

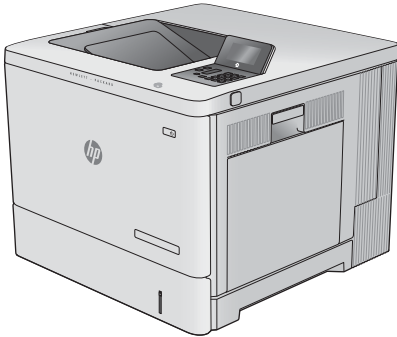

Color LaserJet Enterprise M552 Color LaserJet Enterprise M553 Color LaserJet Enterprise MFP M577

Repair Manual



M553n

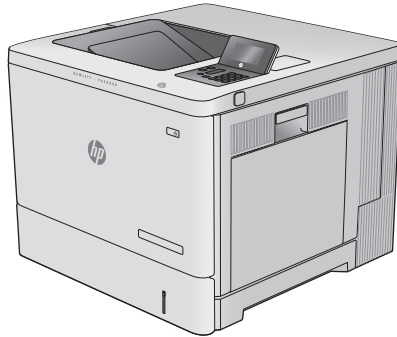

M552dn
M553dn



M553x



M577dn



M577f



M577c
M577z

www.hp.com/support/colorlj552
www.hp.com/support/colorlj553
www.hp.com/support/colorljM577MFP
For printer theory and troubleshooting
information, see the Troubleshooting Manual.





HP Color LaserJet Enterprise M552, M553, and MFP M577

Repair Manual

Copyright and License

© Copyright 2015 HP Development Company, L.P.

Reproduction, adaptation, or translation without prior written permission is prohibited, except as allowed under the copyright laws.

The information contained herein is subject to change without notice.

The only warranties for HP products and services are set forth in the express warranty statements accompanying such products and services. Nothing herein should be construed as constituting an additional warranty. HP shall not be liable for technical or editorial errors or omissions contained herein.

Edition 1, 11/2015

Conventions used in this guide

 **TIP:** Helpful hints or shortcuts.

 **NOTE:** Information that explains a concept or how to complete a task.

 **Reinstallation tip:** Reinstallation helpful hints, shortcuts, or considerations.

 **IMPORTANT:** Information that help the user to avoid potential printer error conditions.

 **CAUTION:** Procedures that the user must follow to avoid losing data or damaging the printer.

 **WARNING!** Procedures that the user must follow to avoid personal injury, catastrophic loss of data, or extensive damage to the printer.

For additional service and support information

HP service personnel, go to the Service Access Work Bench (SAW) at <http://h41302.www4.hp.com/km/saw/home.do>.

Channel partners, go to HP Channel Services Network (CNS) at <https://h30125.www3.hp.com/hpcsn>.

At these locations, find information on the following topics:

- Install and configure
- Printer specifications
- Up-to-date control panel message (CPMD) troubleshooting
- Solutions for printer issues and emerging issues
- Remove and replace part instructions and videos
- Service advisories
- Warranty and regulatory information

To access HP PartSurfer information from any mobile device, go to <http://partsurfermobile.hp.com/> or scan the Quick Response (QR) code below.



Table of contents

1 Removal and replacement	1
For additional service and support	2
Removal and replacement strategy	2
Introduction	2
Considerations during removal and replacement	3
Electrostatic discharge	4
Required tools	4
Fasteners used in this printer	4
Service approach	6
Before performing service	6
After performing service	6
Post service tests	6
Print quality test	6
Copy-quality test (M577 models)	6
Fax-quality test (M577 models)	7
Parts removal orientation	7
Removal and replacement procedures	8
Customer self-repair (CSR) A parts and assemblies	8
Removal and replacement: Toner cartridges	9
Introduction	9
Step 1: Remove the toner cartridges	10
Step 2: Unpack the replacement assembly	11
Step 3: Install a toner cartridge	11
Removal and replacement: Toner collection unit (TCU)	14
Introduction	14
Step 1: Remove the TCU	14
Step 2: Unpack the replacement assembly	16
Step 3: Install the TCU	17
Removal and replacement: Staple cartridge (M577c/f/z)	19
Introduction	19
Step 1: Remove the staple cartridge	19
Step 2: Unpack the replacement assembly	20

Step 3: Install the staple cartridge	21
Removal and replacement: Fuser	23
Introduction	23
Step 1: Remove the fuser	23
Step 2: Unpack the replacement assembly	25
Step 3: Install the fuser	25
Step 4: Reset the fuser counter	27
Removal and replacement: Hard-disk drive (HDD) (M552 and M553)	28
Introduction	28
Step 1: Remove the formatter cover	29
Step 2: Remove the hard-disk drive (HDD)	30
Step 3: Unpack the replacement assembly	31
Step 4: Install the hard-disk drive (HDD)	32
Step 5: Install the formatter cover	33
Step 6: Reinstall the product firmware	33
Removal and replacement: Hard-disk drive (HDD) (M577)	28
Introduction	34
Step 1: Remove the formatter cover	35
Step 2: Remove the hard-disk drive (HDD)	36
Step 3: Unpack the replacement assembly	38
Step 4: Install the hard-disk drive (HDD)	39
Step 5: Install the formatter cover	42
Step 6: Reinstall the product firmware	43
Removal and replacement: Dual in-line memory module (DIMM; M552 and M553)	44
Introduction	44
Step 1: Remove the formatter cover	45
Step 2: Remove the hard-disk drive (HDD; M552 and M553)	46
Step 3: Remove the dual in-line memory module (DIMM)	47
Step 4: Unpack the replacement assembly	48
Step 5: Install the DIMM	49
Step 6: Install the HDD (M552 and M553)	50
Step 7: Install the formatter cover	51
Removal and replacement: Dual in-line memory module (DIMM; M577)	53
Introduction	53
Step 1: Remove the formatter cover	54
Step 2: Remove the hard-disk drive (HDD; M577)	55
Step 3: Remove the dual in-line memory module (DIMM)	44
Step 4: Unpack the replacement assembly	57
Step 5: Install the DIMM	57
Step 6: Install the HDD (M577)	59
Step 7: Install the formatter cover	60

Removal and replacement: embedded MultiMedia Card (eMMC; M552 and M553)	53
Introduction	61
Step 1: Remove the formatter cover	62
Step 2: Remove the embedded MultiMedia Card (eMMC)	63
Step 3: Unpack the replacement assembly	64
Step 4: Install the eMMC	64
Step 5: Install the formatter cover	65
Step 6: Reinstall the product firmware	65
Removal and replacement: Secondary transfer roller	67
Introduction	67
Step 1: Remove the transfer roller	67
Step 2: Unpack the replacement assembly	69
Step 3: Install the secondary transfer roller	70
Removal and replacement: Universal Serial Bus (USB) cover (M552 and M553)	72
Introduction	72
Step 1: Remove the USB cover	72
Step 2: Unpack the replacement assembly	73
Step 3: Install the USB cover	73
Removal and replacement: Hardware Integration Pocket (HIP) cover (M552 and M553)	75
Introduction	75
Step 1: Remove the HIP cover	75
Step 2: Unpack the replacement assembly	77
Step 3: Install the HIP cover	77
Removal and replacement: Hardware Integration Pocket (HIP) cover (M577)	79
Introduction	79
Step 1: Remove the HIP cover	79
Step 2: Unpack the replacement assembly	80
Step 3: Install the HIP cover	81
Removal and replacement: Control panel (M553x)	83
Introduction	83
Step 1: Remove the control panel	84
Step 2: Unpack the replacement assembly	88
Step 3: Install the control panel	88
Removal and replacement: Control panel (M577)	92
Introduction	92
Step 1: Remove the control-panel cover (M577)	92
Step 2: Remove the control panel (M577)	94
Step 3: Unpack the replacement assembly	97
Step 4: Install the control panel (M577)	97
Step 5: Install the control-panel cover (M577)	102

Removal and replacement: Keyboard (M577c/z)	104
Introduction	104
Step 1: Remove the control-panel cover (M577)	104
Step 2: Remove the keyboard	106
Step 3: Unpack the replacement assembly	108
Step 4: Install the keyboard	108
Step 5: Install the control-panel cover (M577)	111
Removal and replacement: White backing (M577)	113
Introduction	113
Step 1: Remove the white backing (M577)	113
Step 2: Unpack the replacement assembly	116
Step 3: Install the white backing (M577)	117
Removal and replacement: Retention clips (M577)	120
Introduction	120
Step 1: Remove the retention clips	120
Step 2: Unpack the replacement assembly	123
Step 3: Install the retention clips	123
Removal and replacement: Document feeder rollers (M577)	128
Introduction	128
Step 1: Remove the pickup and feed roller assembly	128
Step 2: Remove the separation roller	130
Step 3: Unpack the replacement assemblies	131
Step 4: Install the separation roller	132
Step 5: Install the pickup and feed roller assembly	134
Step 6: Reset the document feeder kit count	135
Customer self-repair (CSR) B parts and assemblies	137
Removal and replacement: Tray 2-X paper pickup roller and separation roller assemblies	138
Introduction	138
Step 1: Remove the Tray 2-X paper pickup roller assembly	139
Step 2: Remove the Tray 2-X separation roller	144
Step 3: Unpack the replacement assemblies	145
Step 4: Install the Tray 2-X separation roller	146
Step 5: Install the Tray 2-X paper pickup roller assembly	147
Removal and replacement: Intermediate transfer belt (ITB)	153
Introduction	83
Step 1: Remove the ITB	153
Step 2: Unpack the replacement assembly	158
Step 3: Install the ITB	159
Removal and replacement: Intermediate transfer belt (ITB) and secondary transfer roller	166

Introduction	166
Step 1: Remove the transfer roller	166
Step 2: Remove the ITB	168
Step 3: Unpack the replacement assemblies	173
Step 4: Install the ITB	173
Step 5: Install the transfer roller	179
Field replaceable units (FRUs)	181
Removal and replacement: External panels, covers, and doors	181
Removal and replacement: Stapler cover assembly (M577c/f/z)	182
Removal and replacement: Right front upper cover (M577dn)	187
Removal and replacement: Rear upper cover (M577)	192
Removal and replacement: Left upper cover (M577)	199
Removal and replacement: Right upper cover (M577)	209
Removal and replacement: Top rear cover (M577)	229
Removal and replacement: Paper feed cover (M577)	261
Removal and replacement: Top cover (M577)	295
Removal and replacement: Right door	339
Removal and replacement: Front door	348
Removal and replacement: Formatter cover	358
Removal and replacement: Rear cover (M552 and M553)	361
Removal and replacement: Rear cover (M577)	366
Removal and replacement: Left cover	376
Removal and replacement: Upper cover (M552 and M553)	395
Removal and replacement: Output bin	424
Removal and replacement: Right rear cover (M552 and M553)	491
Removal and replacement: Right rear cover (M577)	519
Removal and replacement: Control panel (M553n/dn and M552dn only)	542
Removal and replacement: Internal parts and assemblies	566
Removal and replacement: Tray 1 pickup and separation rollers	568
Removal and replacement: Secondary transfer assembly	580
Removal and replacement: Near field communication (NFC) PCA (M553x)	586
Removal and replacement: Near field communication (NFC) PCA (M577z)	613
Removal and replacement: Wireless PCA (M553 and M577)	621
Removal and replacement: Stapler unit (M577c/f/z)	688
Removal and replacement: DC controller	698
Removal and replacement: Delivery assembly	713
Removal and replacement: Formatter (M552 and M553)	807
Removal and replacement: Formatter (M577)	822

Removal and replacement: Formatter case assembly	838
Removal and replacement: Fuser power supply	878
Removal and replacement: Low-voltage power supply (LVPS)	902
Removal and replacement: High-voltage power supply D (HVPST)	947
Removal and replacement: Drum motor 1 (M1)	996
Removal and replacement: Power-supply fan (FM1)	1037
Removal and replacement: Developing disengagement motor (M6)	1111
Removal and replacement: Auto close assembly	1161
Removal and replacement: Lifter drive assembly	1211
Removal and replacement: Laser/scanner assembly	1263
Removal and replacement: Delivery fan (FM3)	1322
Removal and replacement: High-voltage power supply T (HVPST)	1407
Removal and replacement: Drum motor 2 (M2)	1495
Removal and replacement: Drum motor 3 (M3)	1584
Removal and replacement: Fuser motor (M4)	1673
Removal and replacement: Environmental sensor printed circuit assembly (PCA)	1762
Removal and replacement: Fuser drive assembly	1777
Removal and replacement: Duplex drive assembly and motor	1887
Removal and replacement: Pickup drive assembly and motor (M5)	2022
Removal and replacement: Registration assembly	2119
Removal and replacement: Paper pickup assembly	2241
Removal and replacement: Density-detect assembly	2379
Removal and replacement: Main drive assembly	2506
Removal and replacement: Document feeder and image scanner assemblies (M577)	2655
Removal and replacement: Document feeder (M577)	2656
Introduction	2656
Step 1: Remove the formatter cover	2657
Step 2: Remove the rear upper cover	2658
Step 3: Remove the left upper cover	2660
Step 4: Remove the document feeder	2661
Step 5: Unpack the replacement assembly	2665
Step 6: Install the document feeder	2665
Step 7: Install the left upper cover	2671
Step 8: Install the rear upper cover	2673
Step 9: Install the formatter cover	2675
Step 10: Reset the firmware counter	2676
Removal and replacement: Scanner control board (SCB) (M577)	2677
Introduction	2677
Step 1: Remove the formatter cover	2677
Step 2: Remove the rear upper cover	2678

Step 3: Remove the scanner control board (SCB)	2680
Step 4: Unpack the replacement assembly	2683
Step 5: Install the SCB	2683
Step 6: Install the rear upper cover	2686
Step 7: Install the formatter cover	2688
Removal and replacement: Image scanner (M577)	2690
Introduction	2690
Step 1: Remove the control-panel cover (M577)	2691
Step 2: Remove the white backing (M577)	2693
Step 3: Remove the keyboard (M577c/z)	2695
Step 4: Remove the control panel (M577)	2697
Step 5: Remove the formatter cover	2699
Step 6: Remove the fax PCA (M577c/f/z)	2700
Step 7: Remove the rear upper cover (M577)	2702
Step 8: Remove the left upper cover (M577)	2704
Step 9: Remove the right front upper cover (M577dn)	2706
Step 10: Remove the stapler cover assembly (M577c/f/z)	2707
Step 11: Remove the document feeder (M577)	2709
Step 12: Remove the scanner control board (SCB) (M577)	2713
Step 13: Remove the image scanner assembly (M577)	2715
Step 14: Unpack the replacement assembly	2718
Step 15: Install the image scanner assembly (M577)	2719
Step 16: Install the scanner control board (M577)	2723
Step 17: Install the document feeder (M577)	2725
Step 18: Install the stapler cover assembly (M577c/f/z)	2729
Step 19: Install the right front upper cover (M577dn)	2731
Step 20: Install the left upper cover (M577)	2732
Step 21: Install the rear upper cover (M577)	2734
Step 22: Install the fax PCA (M577c/f/z)	2736
Step 23: Install the formatter cover	2738
Step 24: Install the control panel (M577)	2738
Step 25: Install the keyboard (M577c/z)	2742
Step 26: Install the white backing (M577)	2744
Step 27: Install the control-panel cover (M577)	2745
Removal and replacement: Trays	2747
Removal and replacement: Tray 2	2748
Introduction	2748
Step 1: Remove the tray	2748
Step 2: Unpack the replacement assembly	2749
Step 3: Install the tray	2750
Removal and replacement: Tray 3, Tray 4, or Tray 5	2752

Introduction	2752
Step 1: Remove the tray	2752
Step 2: Unpack the replacement assembly	2753
Step 3: Install the tray	2754
Removal and replacement: Accessories	2756
Removal and replacement: 1x550-sheet paper feeder	2757
Removal and replacement: Rear cover (1x550-sheet paper feeder)	2758
Removal and replacement: Right door (1x550-sheet paper feeder)	2762
Removal and replacement: Right door hinge bracket (1x550-sheet paper feeder)	2771
Removal and replacement: Right-lower cover (1x550-sheet paper feeder)	2781
Removal and replacement: Right-door link (1x550-sheet paper feeder)	2794
Removal and replacement: Left cover (1x550-sheet paper feeder)	2807
Removal and replacement: OP Drawer holder (1x550-sheet paper feeder)	2811
Removal and replacement: Auto close assembly (1x550-sheet paper feeder)	2817
Removal and replacement: Switch button (SW12) (1x550-sheet paper feeder)	2827
Removal and replacement: Drawer connector holder (1x550-sheet paper feeder)	2836
Removal and replacement: Paper-feeder drive PCA (1x550-sheet paper feeder)	2843
Removal and replacement: Paper feed assembly (1x550-sheet paper feeder)	2849
Removal and replacement: Paper pickup assembly (1x550-sheet paper feeder)	2872
Removal and replacement: Feeder drive assembly (1x550-sheet paper feeder)	2900
Removal and replacement: Lifter drive assembly (1x550-sheet paper feeder)	2925
Removal and replacement: Trusted platform module (M552 and M553)	2956
Introduction	2956
Step 1: Remove the formatter cover	2957
Step 2: Remove the hard-disk drive (HDD)	2958
Step 3: Remove the trusted platform module (TPM)	2959
Step 4: Unpack the replacement assembly	2960
Step 5: Install the TPM	2961
Step 6: Install the hard-disk drive (HDD)	2962
Step 7: Install the formatter cover	2963

Removal and replacement: Trusted platform module (M577)	2964
Introduction	2964
Step 1: Remove the formatter cover	2965
Step 2: Remove the hard-disk drive (HDD; M577)	2966
Step 3: Remove the trusted platform module (TPM)	2966
Step 4: Unpack the replacement assembly	2967
Step 5: Install the TPM	2961
Step 6: Install the hard-disk drive (HDD; M577)	2969
Step 7: Install the formatter cover	2963
Removal and replacement: Internal USB ports (M552 and M553)	53
Introduction	2971
Step 1: Remove the formatter cover	2972
Step 2: Remove the internal USB ports module (M552 and M553)	44
Step 3: Unpack the replacement assembly	2975
Step 4: Install the internal USB ports module (M552 and M553)	2976
Step 5: Install the formatter cover	60
Removal and replacement: Internal USB ports (M577)	53
Introduction	2980
Step 1: Remove the formatter cover	2981
Step 2: Remove the internal USB ports module (M577)	44
Step 3: Unpack the replacement assembly	2983
Step 4: Install the internal USB ports module (M577)	2984
Step 5: Install the formatter cover	60
Removal and replacement: Fax PCA (M577c/f/z)	53
Introduction	2987
Step 1: Remove the formatter cover	2988
Step 2: Remove the fax PCA	44
Step 3: Unpack the replacement assembly	2990
Step 4: Install the fax PCA	2991
Step 5: Install the formatter cover	60

2 Parts and diagrams 2995

For additional service and support	2996
Assembly locations	2997
Product front view (M552 and M553 models)	2997
Product back view (M552 and M553 models)	2998
Product front view (M577 models)	2999
Product back view (M577 models)	3000
Order parts, accessories, and supplies	3001
Ordering	3001
Orderable parts	3001

Supplies	3001
Accessories	3002
Customer self-repair kits	3004
Related documentation and software	3005
How to use the parts lists and diagrams	3006
Parts and diagrams: Document feeder and scanner whole units	3008
Parts and diagrams: Covers	3010
Covers (M552 and M553)	3010
Covers (M577)	3012
Parts and diagrams: Internal components	3014
Internal components (1 of 5)	3014
Internal components (2 of 5)	3016
Internal components (3 of 5)	3018
Internal components (4 of 5)	3020
Internal components (5 of 5)	3022
Parts and diagrams: 550-sheet paper feeder	3024
550-sheet paper feeder covers	3024
550-sheet paper feeder main body	3026
Alphabetical parts list	3028
Numerical parts list	3036
Index	3045

List of tables

Table 2-1	Supplies	3001
Table 2-2	Accessories (M552 and M553)	3002
Table 2-3	Accessories (M577)	3003
Table 2-4	Document feeder and scanner whole units (M577 only)	3009
Table 2-5	Covers (M552, M553)	3011
Table 2-6	Covers (M577)	3013
Table 2-7	Internal components (1 of 5)	3015
Table 2-8	Internal components (2 of 5)	3017
Table 2-9	Internal components (3 of 5)	3019
Table 2-10	Internal components (4 of 5)	3021
Table 2-11	Internal components (5 of 5)	3023
Table 2-12	550-sheet paper feeder covers	3025
Table 2-13	550-sheet paper feeder covers	3027

List of figures

Figure 1-1	Screwdrivers	4
Figure 1-2	Screw size chart	5
Figure 1-3	Open the front door	10
Figure 1-4	Remove the toner cartridge	10
Figure 1-5	Recycle and unpack	11
Figure 1-6	Rock the toner cartridge	11
Figure 1-7	Remove the protective shield	12
Figure 1-8	Install a toner cartridge	12
Figure 1-9	Close the front door	13
Figure 1-10	Open the front door	15
Figure 1-11	Open the TCU	15
Figure 1-12	Remove the TCU	16
Figure 1-13	Recycle and unpack	17
Figure 1-14	Verify that the toner collection hatch cover is closed	17
Figure 1-15	Install the TCU	18
Figure 1-16	Close the front door	18
Figure 1-17	Open the stapler door	20
Figure 1-18	Remove the staple cartridge	20
Figure 1-19	Recycle and unpack	21
Figure 1-20	Install the staple cartridge	21
Figure 1-21	Close the stapler door	22
Figure 1-22	Open the right door	24
Figure 1-23	Release the fuser	24
Figure 1-24	Remove the fuser	25
Figure 1-25	Recycle and unpack	25
Figure 1-26	Align the fuser with the opening	26
Figure 1-27	Install the fuser	26
Figure 1-28	Close the right door	27
Figure 1-29	Locate the formatter cover	29
Figure 1-30	Loosen the thumbscrews	30
Figure 1-31	Release the HDD	30
Figure 1-32	Remove the HDD	31

Figure 1-33	Recycle and unpack	31
Figure 1-34	Install the holder	32
Figure 1-35	Release the HDD	32
Figure 1-36	Install the cover	33
Figure 1-37	Locate the formatter cover	35
Figure 1-38	Loosen the thumbscrews	36
Figure 1-39	Release the HDD	36
Figure 1-40	Remove the HDD	37
Figure 1-41	Remove two screws	37
Figure 1-42	Remove the bracket	38
Figure 1-43	Remove the PCA	38
Figure 1-44	Recycle and unpack	39
Figure 1-45	Align the PCA	39
Figure 1-46	Install the PCA	40
Figure 1-47	Align the tabs on the bracket	40
Figure 1-48	Install the bracket	41
Figure 1-49	Install two screws	41
Figure 1-50	Install the holder	42
Figure 1-51	Release the HDD	42
Figure 1-52	Install the cover	43
Figure 1-53	Locate the formatter cover	45
Figure 1-54	Loosen the thumbscrews	46
Figure 1-55	Release the HDD	47
Figure 1-56	Remove the HDD	47
Figure 1-57	Locate the DIMM	48
Figure 1-58	Remove the DIMM	48
Figure 1-59	Recycle and unpack	49
Figure 1-60	The DIMM connector	49
Figure 1-61	Install the DIMM	50
Figure 1-62	Verify the installation	50
Figure 1-63	Install the holder	51
Figure 1-64	Release the HDD	51
Figure 1-65	Install the cover	52
Figure 1-66	Locate the formatter cover	54
Figure 1-67	Loosen the thumbscrews	54
Figure 1-68	Release the HDD	55
Figure 1-69	Remove the HDD	55
Figure 1-70	Locate the DIMM	56
Figure 1-71	Release the DIMM	56
Figure 1-72	Remove the DIMM (M527)	57
Figure 1-73	Recycle and unpack	57

Figure 1-74	Insert the DIMM	58
Figure 1-75	Install the DIMM	58
Figure 1-76	Snap the DIMM into place	59
Figure 1-77	Install the holder	59
Figure 1-78	Release the HDD	60
Figure 1-79	Install the cover	60
Figure 1-80	Locate the formatter cover	62
Figure 1-81	Loosen the thumbscrews	63
Figure 1-82	Remove the eMMC	63
Figure 1-83	Recycle and unpack	64
Figure 1-84	Install the eMMC	64
Figure 1-85	Verify the installation	65
Figure 1-86	Install the cover	65
Figure 1-87	Open the right door	68
Figure 1-88	Lower the secondary transfer roller assembly	68
Figure 1-89	Release the secondary transfer roller clip	69
Figure 1-90	Remove the secondary transfer roller	69
Figure 1-91	Recycle and unpack	70
Figure 1-92	Install the secondary transfer roller	70
Figure 1-93	Close the right door	71
Figure 1-94	Locate the USB cover	72
Figure 1-95	Remove the cover	73
Figure 1-96	Recycle and unpack	73
Figure 1-97	Install the cover	74
Figure 1-98	Check the installation	74
Figure 1-99	Locate the HIP cover	75
Figure 1-100	Note the mounting feet and tabs	76
Figure 1-101	Release the HIP cover tabs	76
Figure 1-102	Remove the cover	77
Figure 1-103	Recycle and unpack	77
Figure 1-104	Install the cover	78
Figure 1-105	Check the installation	78
Figure 1-106	Locate the HIP cover	79
Figure 1-107	Release the HIP cover tabs	80
Figure 1-108	Remove the cover	80
Figure 1-109	Recycle and unpack	81
Figure 1-110	Position the tabs	81
Figure 1-111	Rotate the cover down	82
Figure 1-112	Check the installation	82
Figure 1-113	Tilt the control panel up	84
Figure 1-114	Release the control-panel screws cover tabs	84

Figure 1-115	Remove the cover	85
Figure 1-116	Remove two screws	85
Figure 1-117	Rotate the control-panel base up	86
Figure 1-118	Turn the control panel over	86
Figure 1-119	Disconnect two connectors	87
Figure 1-120	Recycle and unpack	88
Figure 1-121	Place the control panel on the product	88
Figure 1-122	Connect two connectors	89
Figure 1-123	Turn the control panel over	89
Figure 1-124	Rotate the control-panel base down	90
Figure 1-125	Install two screws	90
Figure 1-126	Install the cover	91
Figure 1-127	Open the document feeder	93
Figure 1-128	Release five tabs	93
Figure 1-129	Remove the cover	94
Figure 1-130	Disconnect the keyboard flat cable (M577c/z)	94
Figure 1-131	Disconnect connectors	95
Figure 1-132	Disconnect connectors	95
Figure 1-133	Remove three screws	96
Figure 1-134	Remove the control panel	96
Figure 1-135	Recycle and unpack	97
Figure 1-136	Open the control panel	97
Figure 1-137	Feed the keyboard flat cable through opening	98
Figure 1-138	Locate hooks and grounding clip	98
Figure 1-139	Install the control-panel	99
Figure 1-140	Install three screws	100
Figure 1-141	Connect connectors	101
Figure 1-142	Install USB and NFC	101
Figure 1-143	Connect the keyboard flat cable (M577c/z)	102
Figure 1-144	Position the control-panel cover on the printer	102
Figure 1-145	Engage five tabs	103
Figure 1-146	Close the document feeder	103
Figure 1-147	Open the document feeder	105
Figure 1-148	Release five tabs	105
Figure 1-149	Remove the cover	106
Figure 1-150	Disconnect the keyboard flat cable	106
Figure 1-151	Slide the keyboard out	107
Figure 1-152	Release two tabs	107
Figure 1-153	Remove the keyboard	108
Figure 1-154	Recycle and unpack	108
Figure 1-155	Install the flat cable through the slot	109

Figure 1-156	Slide the keyboard into the slot	109
Figure 1-157	Check the flat cable	110
Figure 1-158	Connect the flat cable	110
Figure 1-159	Position the control-panel cover on the printer	111
Figure 1-160	Engage five tabs	111
Figure 1-161	Close the document feeder	112
Figure 1-162	Open the document feeder	114
Figure 1-163	Remove the white backing	114
Figure 1-164	Check the retention clips	115
Figure 1-165	Check the retention clip spring	115
Figure 1-166	Install the retention clip	116
Figure 1-167	Press the retention clip	116
Figure 1-168	Recycle and unpack	117
Figure 1-169	Install the white backing	117
Figure 1-170	Close the document feeder	118
Figure 1-171	Check the white backing	118
Figure 1-172	Close the document feeder	119
Figure 1-173	Open the document feeder	121
Figure 1-174	Remove the white backing	121
Figure 1-175	Check the retention clips	122
Figure 1-176	Loosen damaged clips	122
Figure 1-177	Remove the retention clip	123
Figure 1-178	Recycle and unpack	123
Figure 1-179	Check the retention clip spring	124
Figure 1-180	Install the retention clip	124
Figure 1-181	Press the retention clip	125
Figure 1-182	Install the white backing	125
Figure 1-183	Close the document feeder	126
Figure 1-184	Check the white backing	126
Figure 1-185	Close the document feeder	127
Figure 1-186	Open the document-feeder jam access door	129
Figure 1-187	Release the blue locking arm	129
Figure 1-188	Remove the roller assembly	130
Figure 1-189	Release the separation roller cover	130
Figure 1-190	Remove the cover	131
Figure 1-191	Remove the roller	131
Figure 1-192	Recycle and unpack	132
Figure 1-193	Install the roller	132
Figure 1-194	Position the separation roller cover	133
Figure 1-195	Close the separation roller cover	133
Figure 1-196	Snap the cover closed	134

Figure 1-197	Install the roller assembly	134
Figure 1-198	Close the blue locking arm	135
Figure 1-199	Close the document-feeder jam access door	135
Figure 1-200	Pull the tray out	139
Figure 1-201	Remove the tray	139
Figure 1-202	Open the right door	140
Figure 1-203	Raise the transfer roller assembly	140
Figure 1-204	Lower the paper guide	141
Figure 1-205	Locate the tray pickup roller	141
Figure 1-206	Open the Tray 3, 4, or 5 right door	142
Figure 1-207	Lower the Tray 3, 4, or 5 paper guide	142
Figure 1-208	Locate the Tray 3, 4, or 5 pickup roller assembly	143
Figure 1-209	Slide the assembly to the left	143
Figure 1-210	Remove the roller assembly	144
Figure 1-211	Locate the roller assembly	144
Figure 1-212	Push up on the blue label	145
Figure 1-213	Remove the roller assembly	145
Figure 1-214	Recycle and unpack	146
Figure 1-215	Install the roller assembly	146
Figure 1-216	Fully seat the roller assembly	147
Figure 1-217	Check the installation	147
Figure 1-218	Note the mounting tab	148
Figure 1-219	Position the roller assembly in the printer	148
Figure 1-220	Release the spring loaded shaft	149
Figure 1-221	Verify the roller installation	149
Figure 1-222	Raise the Tray 3, 4, or 5 paper guide	150
Figure 1-223	Close the Tray 3, 4, or 5 right door	150
Figure 1-224	Close the right door	151
Figure 1-225	Install the tray	151
Figure 1-226	Close the tray	152
Figure 1-227	Open the right door	154
Figure 1-228	Release the ITB drive coupling	154
Figure 1-229	Lower the secondary transfer roller assembly	155
Figure 1-230	Release the front-side ITB spring	155
Figure 1-231	Place the spring on the holder	156
Figure 1-232	Release the rear-side ITB spring	156
Figure 1-233	Place the spring on the holder	157
Figure 1-234	Grasp the ITB handles	158
Figure 1-235	Remove the ITB	158
Figure 1-236	Recycle and unpack	159
Figure 1-237	Handle the ITB by the edges	159

Figure 1-238	Align the ITB with the slots in the product	160
Figure 1-239	Orange handles stop	160
Figure 1-240	Release one tab	161
Figure 1-241	Remove the orange handle	161
Figure 1-242	Install the ITB	162
Figure 1-243	Remove the spring from the holder	162
Figure 1-244	Fasten the rear-side ITB spring	163
Figure 1-245	Remove the spring from the holder	163
Figure 1-246	Fasten the front-side ITB spring	164
Figure 1-247	Engage the ITB drive coupling	164
Figure 1-248	Close the right door	165
Figure 1-249	Open the right door	167
Figure 1-250	Lower the secondary transfer roller assembly	167
Figure 1-251	Release the secondary transfer roller clip	168
Figure 1-252	Remove the secondary transfer roller	168
Figure 1-253	Release the ITB drive coupling	169
Figure 1-254	Release the front-side ITB spring	169
Figure 1-255	Place the spring on the holder	170
Figure 1-256	Release the rear-side ITB spring	170
Figure 1-257	Place the spring on the holder	171
Figure 1-258	Grasp the ITB handles	172
Figure 1-259	Remove the ITB	172
Figure 1-260	Recycle and unpack	173
Figure 1-261	Handle the ITB by the edges	174
Figure 1-262	Align the ITB with the slots in the product	174
Figure 1-263	Orange handles stop	175
Figure 1-264	Release one tab	175
Figure 1-265	Remove the orange handle	176
Figure 1-266	Install the ITB	176
Figure 1-267	Remove the spring from the holder	177
Figure 1-268	Fasten the rear-side ITB spring	177
Figure 1-269	Remove the spring from the holder	178
Figure 1-270	Fasten the front-side ITB spring	178
Figure 1-271	Engage the ITB drive coupling	179
Figure 1-272	Install the secondary transfer roller right end	179
Figure 1-273	Close the right door	180
Figure 1-274	Remove one screw	183
Figure 1-275	Release two tabs	183
Figure 1-276	Release the back edge of the cover	184
Figure 1-277	Remove the cover	184
Figure 1-278	Recycle and unpack	185

Figure 1-279	Install two tabs	185
Figure 1-280	Install the cover assembly	186
Figure 1-281	Install one screw	186
Figure 1-282	Remove one screw	188
Figure 1-283	Release two tabs	188
Figure 1-284	Rotate the cover	189
Figure 1-285	Recycle and unpack	189
Figure 1-286	Install the cover	190
Figure 1-287	Press the cover	190
Figure 1-288	Install one screw	191
Figure 1-289	Locate the formatter cover	193
Figure 1-290	Loosen the thumbscrews	193
Figure 1-291	Remove two screws	194
Figure 1-292	Release the right edge	194
Figure 1-293	Slide the cover right	195
Figure 1-294	Remove the cover	195
Figure 1-295	Recycle and unpack	196
Figure 1-296	Align the cover	196
Figure 1-297	Rotate the top of the cover	197
Figure 1-298	Slide the cover	197
Figure 1-299	Install two screws	198
Figure 1-300	Install the cover	198
Figure 1-301	Locate the formatter cover	200
Figure 1-302	Loosen the thumbscrews	200
Figure 1-303	Remove two screws	201
Figure 1-304	Release the right edge	201
Figure 1-305	Slide the cover right	202
Figure 1-306	Remove the cover	202
Figure 1-307	Release one tab	203
Figure 1-308	Slide the cover back	203
Figure 1-309	Remove the left upper cover	204
Figure 1-310	Recycle and unpack	204
Figure 1-311	Position the tab	205
Figure 1-312	Slide the cover	205
Figure 1-313	Check the tab	206
Figure 1-314	Align the cover	206
Figure 1-315	Rotate the top of the cover	207
Figure 1-316	Slide the cover	207
Figure 1-317	Install two screws	208
Figure 1-318	Install the cover	208
Figure 1-319	Locate the formatter cover	210

Figure 1-320	Loosen the thumbscrews	210
Figure 1-321	Remove two screws	211
Figure 1-322	Release the right edge	211
Figure 1-323	Slide the cover right	212
Figure 1-324	Remove the cover	212
Figure 1-325	Remove one screw	213
Figure 1-326	Release two tabs	213
Figure 1-327	Rotate the cover	214
Figure 1-328	Remove one screw	214
Figure 1-329	Release two tabs	215
Figure 1-330	Release the back edge of the cover	215
Figure 1-331	Remove the cover	216
Figure 1-332	Remove two screws and one connector	216
Figure 1-333	Remove one screw and connector	217
Figure 1-334	Slide the cover	217
Figure 1-335	Remove the cover	218
Figure 1-336	Release two retainers	218
Figure 1-337	Remove the wire harness	219
Figure 1-338	Recycle and unpack	219
Figure 1-339	Install the wire harness	220
Figure 1-340	Install the cables	220
Figure 1-341	Position the hooks	221
Figure 1-342	Install the cover	221
Figure 1-343	Install one screw and connector	222
Figure 1-344	Install one screw and connector	222
Figure 1-345	Install two tabs	223
Figure 1-346	Install the cover assembly	223
Figure 1-347	Install one screw	224
Figure 1-348	Install the cover	224
Figure 1-349	Press the cover	225
Figure 1-350	Install one screw	225
Figure 1-351	Align the cover	226
Figure 1-352	Rotate the top of the cover	226
Figure 1-353	Slide the cover	227
Figure 1-354	Install two screws	227
Figure 1-355	Install the cover	228
Figure 1-356	Locate the formatter cover	230
Figure 1-357	Loosen the thumbscrews	231
Figure 1-358	Remove two screws	231
Figure 1-359	Release the right edge	232
Figure 1-360	Slide the cover right	232

Figure 1-361	Remove the cover	233
Figure 1-362	Release one tab	233
Figure 1-363	Slide the cover back	234
Figure 1-364	Remove the left upper cover	234
Figure 1-365	Remove one screw	235
Figure 1-366	Release two tabs	235
Figure 1-367	Rotate the cover	236
Figure 1-368	Remove one screw	236
Figure 1-369	Release two tabs	237
Figure 1-370	Release the back edge of the cover	237
Figure 1-371	Remove the cover	238
Figure 1-372	Remove one screw	238
Figure 1-373	Remove two screws	239
Figure 1-374	Remove one screw	239
Figure 1-375	Disconnect four connectors	240
Figure 1-376	Disconnect connectors	240
Figure 1-377	Slide the ISA towards the back of the printer	241
Figure 1-378	Remove the ISA	241
Figure 1-379	Remove two screws and one connector	242
Figure 1-380	Remove one screw and connector	242
Figure 1-381	Slide the cover	243
Figure 1-382	Remove the cover	243
Figure 1-383	Remove five screws	244
Figure 1-384	Release two tabs	244
Figure 1-385	Remove the top rear cover	245
Figure 1-386	Recycle and unpack	245
Figure 1-387	Align the locator tabs	246
Figure 1-388	Install the cover	246
Figure 1-389	Install five screws	247
Figure 1-390	Install the cables	247
Figure 1-391	Position the hooks	248
Figure 1-392	Install the cover	248
Figure 1-393	Install one screw and connector	249
Figure 1-394	Install one screw and connector	249
Figure 1-395	Locate the ISA mounting pins and slots	250
Figure 1-396	Install the ISA	250
Figure 1-397	Slide the ISA towards the front of the printer	251
Figure 1-398	Install one screw	251
Figure 1-399	Install two screws	252
Figure 1-400	Install one screw	252
Figure 1-401	Connect connectors	253

Figure 1-402	Connect four connectors	253
Figure 1-403	Install two tabs	254
Figure 1-404	Install the cover assembly	254
Figure 1-405	Install one screw	255
Figure 1-406	Install the cover	255
Figure 1-407	Press the cover	256
Figure 1-408	Install one screw	256
Figure 1-409	Position the tab	257
Figure 1-410	Slide the cover	257
Figure 1-411	Check the tab	258
Figure 1-412	Align the cover	258
Figure 1-413	Rotate the top of the cover	259
Figure 1-414	Slide the cover	259
Figure 1-415	Install two screws	260
Figure 1-416	Install the cover	260
Figure 1-417	Locate the formatter cover	262
Figure 1-418	Loosen the thumbscrews	263
Figure 1-419	Remove two screws	263
Figure 1-420	Release the right edge	264
Figure 1-421	Slide the cover right	264
Figure 1-422	Remove the cover	265
Figure 1-423	Release one tab	265
Figure 1-424	Slide the cover back	266
Figure 1-425	Remove the left upper cover	266
Figure 1-426	Remove one screw	267
Figure 1-427	Release two tabs	267
Figure 1-428	Rotate the cover	268
Figure 1-429	Remove one screw	268
Figure 1-430	Release two tabs	269
Figure 1-431	Release the back edge of the cover	269
Figure 1-432	Remove the cover	270
Figure 1-433	Remove one screw	270
Figure 1-434	Remove two screws	271
Figure 1-435	Remove one screw	271
Figure 1-436	Disconnect four connectors	272
Figure 1-437	Disconnect connectors	272
Figure 1-438	Slide the ISA towards the back of the printer	273
Figure 1-439	Remove the ISA	273
Figure 1-440	Remove two screws and one connector	274
Figure 1-441	Remove one screw and connector	274
Figure 1-442	Slide the cover	275

Figure 1-443	Remove the cover	275
Figure 1-444	Remove five screws	276
Figure 1-445	Release two tabs	276
Figure 1-446	Remove the top rear cover	277
Figure 1-447	Remove one screw	277
Figure 1-448	Remove the cover	278
Figure 1-449	Recycle and unpack	278
Figure 1-450	Install the cover	279
Figure 1-451	Install one screw	279
Figure 1-452	Align the locator tabs	280
Figure 1-453	Install the cover	280
Figure 1-454	Install five screws	281
Figure 1-455	Install the cables	281
Figure 1-456	Position the hooks	282
Figure 1-457	Install the cover	282
Figure 1-458	Install one screw and connector	283
Figure 1-459	Install one screw and connector	283
Figure 1-460	Locate the ISA mounting pins and slots	250
Figure 1-461	Install the ISA	284
Figure 1-462	Slide the ISA towards the front of the printer	285
Figure 1-463	Install one screw	285
Figure 1-464	Install two screws	286
Figure 1-465	Install one screw	286
Figure 1-466	Connect connectors	287
Figure 1-467	Connect four connectors	287
Figure 1-468	Install two tabs	288
Figure 1-469	Install the cover assembly	288
Figure 1-470	Install one screw	289
Figure 1-471	Install the cover	289
Figure 1-472	Press the cover	290
Figure 1-473	Install one screw	290
Figure 1-474	Position the tab	291
Figure 1-475	Slide the cover	291
Figure 1-476	Check the tab	292
Figure 1-477	Align the cover	292
Figure 1-478	Rotate the top of the cover	293
Figure 1-479	Slide the cover	293
Figure 1-480	Install two screws	294
Figure 1-481	Install the cover	294
Figure 1-482	Locate the formatter cover	296
Figure 1-483	Loosen the thumbscrews	297

Figure 1-484	Remove two screws	297
Figure 1-485	Release the right edge	298
Figure 1-486	Slide the cover right	298
Figure 1-487	Remove the cover	299
Figure 1-488	Release one tab	299
Figure 1-489	Slide the cover back	300
Figure 1-490	Remove the left upper cover	300
Figure 1-491	Remove one screw	301
Figure 1-492	Release two tabs	301
Figure 1-493	Rotate the cover	302
Figure 1-494	Remove one screw	302
Figure 1-495	Release two tabs	303
Figure 1-496	Release the back edge of the cover	303
Figure 1-497	Remove the cover	304
Figure 1-498	Remove one screw	304
Figure 1-499	Remove two screws	305
Figure 1-500	Remove one screw	305
Figure 1-501	Disconnect four connectors	306
Figure 1-502	Disconnect connectors	306
Figure 1-503	Slide the ISA towards the back of the printer	307
Figure 1-504	Remove the ISA	307
Figure 1-505	Disconnect connector and remove screws	308
Figure 1-506	Remove the stapler unit	308
Figure 1-507	Remove two screws and one connector	309
Figure 1-508	Remove one screw and connector	309
Figure 1-509	Slide the cover	310
Figure 1-510	Remove the cover	310
Figure 1-511	Remove five screws	311
Figure 1-512	Release two tabs	311
Figure 1-513	Remove the top rear cover	312
Figure 1-514	Remove one screw	312
Figure 1-515	Remove the cover	313
Figure 1-516	Open the front door	313
Figure 1-517	Open the TCU	314
Figure 1-518	Remove the TCU	315
Figure 1-519	Remove one screw	316
Figure 1-520	Remove one screw	316
Figure 1-521	Release one tab	317
Figure 1-522	Release two tabs	317
Figure 1-523	Recycle and unpack	318
Figure 1-524	Position the locator pins	318

Figure 1-525	Press down on the cover	319
Figure 1-526	Install one screw	319
Figure 1-527	Install one screw	320
Figure 1-528	Verify that the toner collection hatch cover is closed	320
Figure 1-529	Install the TCU	321
Figure 1-530	Close the front door	321
Figure 1-531	Install the cover	322
Figure 1-532	Install one screw	322
Figure 1-533	Align the locator tabs	323
Figure 1-534	Install the cover	323
Figure 1-535	Install five screws	324
Figure 1-536	Install the cables	324
Figure 1-537	Position the hooks	325
Figure 1-538	Install the cover	325
Figure 1-539	Install one screw and connector	326
Figure 1-540	Install one screw and connector	326
Figure 1-541	Position the hooks in the slots	327
Figure 1-542	Connect connector and install screws	327
Figure 1-543	Locate the ISA mounting pins and slots	250
Figure 1-544	Install the ISA	328
Figure 1-545	Slide the ISA towards the front of the printer	329
Figure 1-546	Install one screw	329
Figure 1-547	Install two screws	330
Figure 1-548	Install one screw	330
Figure 1-549	Connect connectors	331
Figure 1-550	Connect four connectors	331
Figure 1-551	Install two tabs	332
Figure 1-552	Install the cover assembly	332
Figure 1-553	Install one screw	333
Figure 1-554	Install the cover	333
Figure 1-555	Press the cover	334
Figure 1-556	Install one screw	334
Figure 1-557	Position the tab	335
Figure 1-558	Slide the cover	335
Figure 1-559	Check the tab	336
Figure 1-560	Align the cover	336
Figure 1-561	Rotate the top of the cover	337
Figure 1-562	Slide the cover	337
Figure 1-563	Install two screws	338
Figure 1-564	Install the cover	338
Figure 1-565	Open the right door	340

Figure 1-566	Rotate the secondary transfer assembly up	340
Figure 1-567	Release the door retainer straps	341
Figure 1-568	Release the connector cover	341
Figure 1-569	Remove the connector cover	342
Figure 1-570	Disconnect two connectors	342
Figure 1-571	Remove two screws	343
Figure 1-572	Remove the door	343
Figure 1-573	Recycle and unpack	344
Figure 1-574	Install the door	344
Figure 1-575	Rotate the door arm down	345
Figure 1-576	Install two screws	345
Figure 1-577	Connect two connectors	346
Figure 1-578	Install the connector cover	346
Figure 1-579	Install the door retainer straps	347
Figure 1-580	Close the right door	347
Figure 1-581	Pull the tray out	349
Figure 1-582	Remove the tray	349
Figure 1-583	Open the front door	350
Figure 1-584	Release the door retainer straps	350
Figure 1-585	Slide the door to the right	351
Figure 1-586	Remove the door	352
Figure 1-587	Recycle and unpack	353
Figure 1-588	Engage the inner door	353
Figure 1-589	Install the door	354
Figure 1-590	Engage the door retainer straps	355
Figure 1-591	Close the front door	355
Figure 1-592	Install nameplate and HP jewel	356
Figure 1-593	Install the tray	356
Figure 1-594	Close the tray	357
Figure 1-595	Locate the formatter cover	359
Figure 1-596	Loosen the thumbscrews	359
Figure 1-597	Recycle and unpack	360
Figure 1-598	Install the cover	360
Figure 1-599	Locate the formatter cover	362
Figure 1-600	Loosen the thumbscrews	362
Figure 1-601	Remove four screws	363
Figure 1-602	Remove the cover	363
Figure 1-603	Recycle and unpack	364
Figure 1-604	Install the cover	364
Figure 1-605	Install four screws cover	365
Figure 1-606	Install the cover	365

Figure 1-607	Locate the formatter cover	367
Figure 1-608	Loosen the thumbscrews	367
Figure 1-609	Remove two screws	368
Figure 1-610	Release the right edge	368
Figure 1-611	Slide the cover right	369
Figure 1-612	Remove the cover	369
Figure 1-613	Remove four screws	370
Figure 1-614	Remove the cover	370
Figure 1-615	Recycle and unpack	371
Figure 1-616	Position the hooks	371
Figure 1-617	Install the cover	372
Figure 1-618	Install four screws cover	372
Figure 1-619	Align the cover	373
Figure 1-620	Rotate the top of the cover	373
Figure 1-621	Slide the cover	374
Figure 1-622	Install two screws	374
Figure 1-623	Install the cover	375
Figure 1-624	Open the front door	377
Figure 1-625	Open the TCU	378
Figure 1-626	Remove the TCU	379
Figure 1-627	Locate the formatter cover	380
Figure 1-628	Loosen the thumbscrews	380
Figure 1-629	Remove four screws	381
Figure 1-630	Remove the cover	381
Figure 1-631	Remove two screws	382
Figure 1-632	Release the right edge	382
Figure 1-633	Slide the cover right	383
Figure 1-634	Remove the cover	383
Figure 1-635	Remove four screws	384
Figure 1-636	Remove the cover	384
Figure 1-637	Remove one screw	385
Figure 1-638	Release the cover	385
Figure 1-639	Remove the cover	386
Figure 1-640	Recycle and unpack	386
Figure 1-641	Install the cover	387
Figure 1-642	Engage the cover	387
Figure 1-643	Install one screw	388
Figure 1-644	Position the hooks	388
Figure 1-645	Install the cover	389
Figure 1-646	Install four screws cover	389
Figure 1-647	Align the cover	390

Figure 1-648	Rotate the top of the cover	390
Figure 1-649	Slide the cover	391
Figure 1-650	Install two screws	391
Figure 1-651	Install the cover	392
Figure 1-652	Install four screws cover	392
Figure 1-653	Install the cover	393
Figure 1-654	Verify that the toner collection hatch cover is closed	393
Figure 1-655	Install the TCU	394
Figure 1-656	Close the front door	394
Figure 1-657	Locate the USB cover	396
Figure 1-658	Remove the cover	397
Figure 1-659	Locate the HIP cover	397
Figure 1-660	Note the mounting feet and tabs	398
Figure 1-661	Release the HIP cover tabs	398
Figure 1-662	Remove the cover	399
Figure 1-663	Tilt the control panel up	400
Figure 1-664	Release the control-panel screws cover tabs	400
Figure 1-665	Remove the cover	401
Figure 1-666	Remove two screws	401
Figure 1-667	Rotate the control-panel base up	402
Figure 1-668	Turn the control panel over	402
Figure 1-669	Disconnect two connectors	403
Figure 1-670	Open the front door	403
Figure 1-671	Open the TCU	404
Figure 1-672	Remove the TCU	405
Figure 1-673	Locate the formatter cover	406
Figure 1-674	Loosen the thumbscrews	406
Figure 1-675	Remove four screws	407
Figure 1-676	Remove the cover	407
Figure 1-677	Remove one screw	408
Figure 1-678	Release the cover	408
Figure 1-679	Remove the cover	409
Figure 1-680	Remove three screws	409
Figure 1-681	Remove one screw and release one tab	410
Figure 1-682	Release the cover	410
Figure 1-683	Remove the cover	411
Figure 1-684	Recycle and unpack	411
Figure 1-685	Install the cover	412
Figure 1-686	Engage one tab	412
Figure 1-687	Engage one tab and install one screw	413
Figure 1-688	Install three screws	413

Figure 1-689	Install the cover	414
Figure 1-690	Engage the cover	414
Figure 1-691	Install one screw	415
Figure 1-692	Install the cover	415
Figure 1-693	Install four screws cover	416
Figure 1-694	Install the cover	416
Figure 1-695	Verify that the toner collection hatch cover is closed	417
Figure 1-696	Install the TCU	417
Figure 1-697	Close the front door	418
Figure 1-698	Place the control panel on the product	418
Figure 1-699	Connect two connectors	419
Figure 1-700	Turn the control panel over	419
Figure 1-701	Rotate the control-panel base down	420
Figure 1-702	Install two screws	420
Figure 1-703	Install the cover	421
Figure 1-704	Install the cover	421
Figure 1-705	Check the installation	422
Figure 1-706	Install the cover	422
Figure 1-707	Check the installation	423
Figure 1-708	Locate the formatter cover	426
Figure 1-709	Loosen the thumbscrews	426
Figure 1-710	Open the front door	427
Figure 1-711	Open the TCU	427
Figure 1-712	Remove the TCU	428
Figure 1-713	Locate the USB cover	429
Figure 1-714	Remove the cover	429
Figure 1-715	Tilt the control panel up	430
Figure 1-716	Release the control-panel screws cover tabs	430
Figure 1-717	Remove the cover	431
Figure 1-718	Remove two screws	431
Figure 1-719	Rotate the control-panel base up	432
Figure 1-720	Turn the control panel over	432
Figure 1-721	Disconnect two connectors	433
Figure 1-722	Remove four screws	433
Figure 1-723	Remove the cover	434
Figure 1-724	Remove two screws	434
Figure 1-725	Release the right edge	435
Figure 1-726	Slide the cover right	435
Figure 1-727	Remove the cover	436
Figure 1-728	Remove four screws	436
Figure 1-729	Remove the cover	437

Figure 1-730	Remove one screw	437
Figure 1-731	Release the cover	438
Figure 1-732	Remove the cover	438
Figure 1-733	Remove three screws	439
Figure 1-734	Remove one screw and release one tab	439
Figure 1-735	Release the cover	440
Figure 1-736	Remove the cover	440
Figure 1-737	Release one tab	441
Figure 1-738	Slide the cover back	441
Figure 1-739	Remove the left upper cover	442
Figure 1-740	Remove one screw	442
Figure 1-741	Release two tabs	443
Figure 1-742	Rotate the cover	443
Figure 1-743	Remove one screw	444
Figure 1-744	Release two tabs	444
Figure 1-745	Release the back edge of the cover	445
Figure 1-746	Remove the cover	445
Figure 1-747	Remove one screw	446
Figure 1-748	Remove two screws	446
Figure 1-749	Remove one screw	447
Figure 1-750	Disconnect four connectors	447
Figure 1-751	Disconnect connectors	448
Figure 1-752	Slide the ISA towards the back of the printer	448
Figure 1-753	Remove the ISA	449
Figure 1-754	Disconnect connector and remove screws	449
Figure 1-755	Remove the stapler unit	450
Figure 1-756	Remove two screws and one connector	450
Figure 1-757	Remove one screw and connector	451
Figure 1-758	Slide the cover	451
Figure 1-759	Remove the cover	452
Figure 1-760	Remove five screws	452
Figure 1-761	Release two tabs	453
Figure 1-762	Remove the top rear cover	453
Figure 1-763	Remove one screw	454
Figure 1-764	Remove the cover	454
Figure 1-765	Remove one screw	455
Figure 1-766	Remove one screw	455
Figure 1-767	Release one tab	456
Figure 1-768	Release two tabs	456
Figure 1-769	Release the cover	457
Figure 1-770	Remove the cover	457

Figure 1-771	Recycle and unpack	458
Figure 1-772	Install the cover	458
Figure 1-773	Align the tabs	459
Figure 1-774	Release the cover	459
Figure 1-775	Verify the installation	460
Figure 1-776	Position the locator pins	460
Figure 1-777	Press down on the cover	461
Figure 1-778	Install one screw	461
Figure 1-779	Install one screw	462
Figure 1-780	Install the cover	462
Figure 1-781	Install one screw	463
Figure 1-782	Align the locator tabs	463
Figure 1-783	Install the cover	464
Figure 1-784	Install five screws	464
Figure 1-785	Install the cables	465
Figure 1-786	Position the hooks	465
Figure 1-787	Install the cover	466
Figure 1-788	Install one screw and connector	466
Figure 1-789	Install one screw and connector	467
Figure 1-790	Position the hooks in the slots	467
Figure 1-791	Connect connector and install screws	468
Figure 1-792	Locate the ISA mounting pins and slots	250
Figure 1-793	Install the ISA	469
Figure 1-794	Slide the ISA towards the front of the printer	469
Figure 1-795	Install one screw	470
Figure 1-796	Install two screws	470
Figure 1-797	Install one screw	471
Figure 1-798	Connect connectors	471
Figure 1-799	Connect four connectors	472
Figure 1-800	Install two tabs	472
Figure 1-801	Install the cover assembly	473
Figure 1-802	Install one screw	473
Figure 1-803	Install the cover	474
Figure 1-804	Press the cover	474
Figure 1-805	Install one screw	475
Figure 1-806	Position the tab	475
Figure 1-807	Slide the cover	476
Figure 1-808	Check the tab	476
Figure 1-809	Install the cover	477
Figure 1-810	Engage one tab	477
Figure 1-811	Engage one tab and install one screw	478

Figure 1-812	Install three screws	478
Figure 1-813	Install the cover	479
Figure 1-814	Engage the cover	479
Figure 1-815	Install one screw	480
Figure 1-816	Position the hooks	480
Figure 1-817	Install the cover	481
Figure 1-818	Install four screws cover	481
Figure 1-819	Align the cover	482
Figure 1-820	Rotate the top of the cover	482
Figure 1-821	Slide the cover	483
Figure 1-822	Install two screws	483
Figure 1-823	Install the cover	484
Figure 1-824	Install four screws cover	484
Figure 1-825	Place the control panel on the product	485
Figure 1-826	Connect two connectors	485
Figure 1-827	Turn the control panel over	486
Figure 1-828	Rotate the control-panel base down	486
Figure 1-829	Install two screws	487
Figure 1-830	Install the cover	487
Figure 1-831	Install the cover	488
Figure 1-832	Check the installation	488
Figure 1-833	Verify that the toner collection hatch cover is closed	489
Figure 1-834	Install the TCU	489
Figure 1-835	Close the front door	490
Figure 1-836	Install the cover	490
Figure 1-837	Locate the USB cover	492
Figure 1-838	Remove the cover	493
Figure 1-839	Tilt the control panel up	494
Figure 1-840	Release the control-panel screws cover tabs	494
Figure 1-841	Remove the cover	495
Figure 1-842	Remove two screws	495
Figure 1-843	Rotate the control-panel base up	496
Figure 1-844	Turn the control panel over	496
Figure 1-845	Disconnect two connectors	497
Figure 1-846	Open the front door	497
Figure 1-847	Open the TCU	498
Figure 1-848	Remove the TCU	499
Figure 1-849	Locate the formatter cover	500
Figure 1-850	Loosen the thumbscrews	500
Figure 1-851	Remove four screws	501
Figure 1-852	Remove the cover	501

Figure 1-853	Remove one screw	502
Figure 1-854	Release the cover	502
Figure 1-855	Remove the cover	503
Figure 1-856	Remove three screws	503
Figure 1-857	Remove one screw and release one tab	504
Figure 1-858	Release the cover	504
Figure 1-859	Remove the cover	505
Figure 1-860	Release the cover	505
Figure 1-861	Remove the cover	506
Figure 1-862	Recycle and unpack	506
Figure 1-863	Install the cover	507
Figure 1-864	Install one screw	507
Figure 1-865	Install the cover	508
Figure 1-866	Engage one tab	508
Figure 1-867	Engage one tab and install one screw	509
Figure 1-868	Install three screws	509
Figure 1-869	Install the cover	510
Figure 1-870	Engage the cover	510
Figure 1-871	Install one screw	511
Figure 1-872	Install the cover	511
Figure 1-873	Install four screws cover	512
Figure 1-874	Install the cover	512
Figure 1-875	Verify that the toner collection hatch cover is closed	513
Figure 1-876	Install the TCU	513
Figure 1-877	Close the front door	514
Figure 1-878	Place the control panel on the product	514
Figure 1-879	Connect two connectors	515
Figure 1-880	Turn the control panel over	515
Figure 1-881	Rotate the control-panel base down	516
Figure 1-882	Install two screws	516
Figure 1-883	Install the cover	517
Figure 1-884	Install the cover	517
Figure 1-885	Check the installation	518
Figure 1-886	Locate the formatter cover	520
Figure 1-887	Loosen the thumbscrews	521
Figure 1-888	Remove two screws	521
Figure 1-889	Release the right edge	522
Figure 1-890	Slide the cover right	522
Figure 1-891	Remove the cover	523
Figure 1-892	Remove one screw	523
Figure 1-893	Release two tabs	524

Figure 1-894	Rotate the cover	524
Figure 1-895	Remove one screw	525
Figure 1-896	Release two tabs	525
Figure 1-897	Release the back edge of the cover	526
Figure 1-898	Remove the cover	526
Figure 1-899	Remove two screws and one connector	527
Figure 1-900	Remove one screw and connector	527
Figure 1-901	Slide the cover	528
Figure 1-902	Remove the cover	528
Figure 1-903	Remove four screws	529
Figure 1-904	Remove the cover	529
Figure 1-905	Release the cover	530
Figure 1-906	Remove the cover	530
Figure 1-907	Recycle and unpack	531
Figure 1-908	Install the cover	531
Figure 1-909	Install one screw	532
Figure 1-910	Position the hooks	532
Figure 1-911	Install the cover	533
Figure 1-912	Install four screws cover	533
Figure 1-913	Install the cables	534
Figure 1-914	Position the hooks	534
Figure 1-915	Install the cover	535
Figure 1-916	Install one screw and connector	535
Figure 1-917	Install one screw and connector	536
Figure 1-918	Install two tabs	536
Figure 1-919	Install the cover assembly	537
Figure 1-920	Install one screw	537
Figure 1-921	Install the cover	538
Figure 1-922	Press the cover	538
Figure 1-923	Install one screw	539
Figure 1-924	Align the cover	539
Figure 1-925	Rotate the top of the cover	540
Figure 1-926	Slide the cover	540
Figure 1-927	Install two screws	541
Figure 1-928	Install the cover	541
Figure 1-929	Locate the USB cover	543
Figure 1-930	Remove the cover	544
Figure 1-931	Open the front door	544
Figure 1-932	Open the TCU	545
Figure 1-933	Remove the TCU	546
Figure 1-934	Locate the formatter cover	547

Figure 1-935	Loosen the thumbscrews	547
Figure 1-936	Remove four screws	548
Figure 1-937	Remove the cover	548
Figure 1-938	Remove one screw	549
Figure 1-939	Release the cover	549
Figure 1-940	Remove the cover	550
Figure 1-941	Remove three screws	550
Figure 1-942	Remove one screw and release one tab	551
Figure 1-943	Release the cover	551
Figure 1-944	Remove the cover	552
Figure 1-945	Remove one screw	552
Figure 1-946	Remove the PCA holder	553
Figure 1-947	Remove one cable	553
Figure 1-948	Remove four screws	554
Figure 1-949	Remove the control panel	554
Figure 1-950	Recycle and unpack	555
Figure 1-951	Connect one connector	555
Figure 1-952	Install four screws	556
Figure 1-953	Place one cable in the guide	556
Figure 1-954	Install the tab	557
Figure 1-955	Install one screw	557
Figure 1-956	Install the cover	558
Figure 1-957	Engage one tab	558
Figure 1-958	Engage one tab and install one screw	559
Figure 1-959	Install three screws	559
Figure 1-960	Install the cover	560
Figure 1-961	Engage the cover	560
Figure 1-962	Install one screw	561
Figure 1-963	Install the cover	561
Figure 1-964	Install four screws cover	562
Figure 1-965	Install the cover	562
Figure 1-966	Verify that the toner collection hatch cover is closed	563
Figure 1-967	Install the TCU	563
Figure 1-968	Close the front door	564
Figure 1-969	Install the cover	564
Figure 1-970	Check the installation	565
Figure 1-971	Open Tray 1	569
Figure 1-972	Open the roller cover	569
Figure 1-973	Remove the cover	570
Figure 1-974	Release two tabs	570
Figure 1-975	Remove the roller	571

Figure 1-976	Release the tray retainers	571
Figure 1-977	Raise Tray 1 up	572
Figure 1-978	Open the roller cover	572
Figure 1-979	Release one tab	573
Figure 1-980	Remove the roller	573
Figure 1-981	Recycle and unpack	574
Figure 1-982	Locate the keyed end of the roller and the holder	574
Figure 1-983	Install the roller	575
Figure 1-984	Rotate the end of the roller into the holder	575
Figure 1-985	Close the roller cover	576
Figure 1-986	Lower Tray 1 down	576
Figure 1-987	Reconnect the tray retainers	577
Figure 1-988	Install the roller	577
Figure 1-989	Reconnect two tabs	578
Figure 1-990	Install the roller cover	578
Figure 1-991	Close the roller cover	579
Figure 1-992	Close Tray 1	579
Figure 1-993	Open the right door	581
Figure 1-994	Release the secondary transfer roller assembly	581
Figure 1-995	Carefully flex the top portion of the blue arm	582
Figure 1-996	Disengage the blue arm and pin	582
Figure 1-997	Remove the secondary transfer roller assembly	583
Figure 1-998	Recycle and unpack	583
Figure 1-999	Install the right hinge	584
Figure 1-1000	Install the left hinge	584
Figure 1-1001	Engage the blue arm with the pin	585
Figure 1-1002	Close the right door	585
Figure 1-1003	Locate the USB cover	587
Figure 1-1004	Remove the cover	588
Figure 1-1005	Tilt the control panel up	589
Figure 1-1006	Release the control-panel screws cover tabs	589
Figure 1-1007	Remove the cover	590
Figure 1-1008	Remove two screws	590
Figure 1-1009	Rotate the control-panel base up	591
Figure 1-1010	Turn the control panel over	591
Figure 1-1011	Disconnect two connectors	592
Figure 1-1012	Open the front door	592
Figure 1-1013	Open the TCU	593
Figure 1-1014	Remove the TCU	594
Figure 1-1015	Locate the formatter cover	595
Figure 1-1016	Loosen the thumbscrews	595

Figure 1-1017	Remove four screws	596
Figure 1-1018	Remove the cover	596
Figure 1-1019	Remove one screw	597
Figure 1-1020	Release the cover	597
Figure 1-1021	Remove the cover	598
Figure 1-1022	Remove three screws	598
Figure 1-1023	Remove one screw and release one tab	599
Figure 1-1024	Release the cover	599
Figure 1-1025	Remove the cover	600
Figure 1-1026	Remove the NFC PCA	600
Figure 1-1027	Recycle and unpack	601
Figure 1-1028	Install the NFC PCA	601
Figure 1-1029	Install the cover	602
Figure 1-1030	Engage one tab	602
Figure 1-1031	Engage one tab and install one screw	603
Figure 1-1032	Install three screws	603
Figure 1-1033	Install the cover	604
Figure 1-1034	Engage the cover	604
Figure 1-1035	Install one screw	605
Figure 1-1036	Install the cover	605
Figure 1-1037	Install four screws cover	606
Figure 1-1038	Install the cover	606
Figure 1-1039	Verify that the toner collection hatch cover is closed	607
Figure 1-1040	Install the TCU	607
Figure 1-1041	Close the front door	608
Figure 1-1042	Place the control panel on the product	608
Figure 1-1043	Connect two connectors	609
Figure 1-1044	Turn the control panel over	609
Figure 1-1045	Rotate the control-panel base down	610
Figure 1-1046	Install two screws	610
Figure 1-1047	Install the cover	611
Figure 1-1048	Install the cover	611
Figure 1-1049	Check the installation	612
Figure 1-1050	Open the document feeder	614
Figure 1-1051	Release five tabs	614
Figure 1-1052	Remove the cover	615
Figure 1-1053	Locate the NFC	615
Figure 1-1054	Release four tabs	616
Figure 1-1055	Disconnect one connector	616
Figure 1-1056	Recycle and unpack	617
Figure 1-1057	Connect one connector	617

Figure 1-1058	Position the NFC PCA	618
Figure 1-1059	Install four tabs	618
Figure 1-1060	Position the control-panel cover on the printer	619
Figure 1-1061	Engage five tabs	619
Figure 1-1062	Close the document feeder	620
Figure 1-1063	Locate the formatter cover	623
Figure 1-1064	Loosen the thumbscrews	624
Figure 1-1065	Open the front door	624
Figure 1-1066	Open the TCU	625
Figure 1-1067	Remove the TCU	626
Figure 1-1068	Locate the USB cover	627
Figure 1-1069	Remove the cover	627
Figure 1-1070	Tilt the control panel up	628
Figure 1-1071	Release the control-panel screws cover tabs	628
Figure 1-1072	Remove the cover	629
Figure 1-1073	Remove two screws	629
Figure 1-1074	Rotate the control-panel base up	630
Figure 1-1075	Turn the control panel over	630
Figure 1-1076	Disconnect two connectors	631
Figure 1-1077	Remove four screws	631
Figure 1-1078	Remove the cover	632
Figure 1-1079	Remove one screw	632
Figure 1-1080	Release the cover	633
Figure 1-1081	Remove the cover	633
Figure 1-1082	Remove three screws	634
Figure 1-1083	Remove one screw and release one tab	634
Figure 1-1084	Release the cover	635
Figure 1-1085	Remove the cover	635
Figure 1-1086	Remove two screws	636
Figure 1-1087	Release the right edge	636
Figure 1-1088	Slide the cover right	637
Figure 1-1089	Remove the cover	637
Figure 1-1090	Release one tab	638
Figure 1-1091	Slide the cover back	638
Figure 1-1092	Remove the left upper cover	639
Figure 1-1093	Remove one screw	639
Figure 1-1094	Release two tabs	640
Figure 1-1095	Rotate the cover	640
Figure 1-1096	Remove one screw	641
Figure 1-1097	Release two tabs	641
Figure 1-1098	Release the back edge of the cover	642

Figure 1-1099	Remove the cover	642
Figure 1-1100	Remove one screw	643
Figure 1-1101	Remove two screws	643
Figure 1-1102	Remove one screw	644
Figure 1-1103	Disconnect four connectors	644
Figure 1-1104	Disconnect connectors	645
Figure 1-1105	Slide the ISA towards the back of the printer	645
Figure 1-1106	Remove the ISA	646
Figure 1-1107	Disconnect connector and remove screws	646
Figure 1-1108	Remove the stapler unit	647
Figure 1-1109	Remove two screws and one connector	647
Figure 1-1110	Remove one screw and connector	648
Figure 1-1111	Slide the cover	648
Figure 1-1112	Remove the cover	649
Figure 1-1113	Remove five screws	649
Figure 1-1114	Release two tabs	650
Figure 1-1115	Remove the top rear cover	650
Figure 1-1116	Remove one screw	651
Figure 1-1117	Remove the cover	651
Figure 1-1118	Remove one screw	652
Figure 1-1119	Remove one screw	652
Figure 1-1120	Release one tab	653
Figure 1-1121	Release two tabs	653
Figure 1-1122	Release the cover	654
Figure 1-1123	Remove the cover	654
Figure 1-1124	Remove the wireless PCA	655
Figure 1-1125	Recycle and unpack	655
Figure 1-1126	Install the wireless PCA	656
Figure 1-1127	Install the cover	656
Figure 1-1128	Align the tabs	657
Figure 1-1129	Release the cover	657
Figure 1-1130	Verify the installation	658
Figure 1-1131	Position the locator pins	658
Figure 1-1132	Press down on the cover	659
Figure 1-1133	Install one screw	659
Figure 1-1134	Install one screw	660
Figure 1-1135	Install the cover	660
Figure 1-1136	Install one screw	661
Figure 1-1137	Align the locator tabs	661
Figure 1-1138	Install the cover	662
Figure 1-1139	Install five screws	662

Figure 1-1140	Install the cables	663
Figure 1-1141	Position the hooks	663
Figure 1-1142	Install the cover	664
Figure 1-1143	Install one screw and connector	664
Figure 1-1144	Install one screw and connector	665
Figure 1-1145	Position the hooks in the slots	665
Figure 1-1146	Connect connector and install screws	666
Figure 1-1147	Locate the ISA mounting pins and slots	250
Figure 1-1148	Install the ISA	667
Figure 1-1149	Slide the ISA towards the front of the printer	667
Figure 1-1150	Install one screw	668
Figure 1-1151	Install two screws	668
Figure 1-1152	Install one screw	669
Figure 1-1153	Connect connectors	669
Figure 1-1154	Connect four connectors	670
Figure 1-1155	Install two tabs	670
Figure 1-1156	Install the cover assembly	671
Figure 1-1157	Install one screw	671
Figure 1-1158	Install the cover	672
Figure 1-1159	Press the cover	672
Figure 1-1160	Install one screw	673
Figure 1-1161	Position the tab	673
Figure 1-1162	Slide the cover	674
Figure 1-1163	Check the tab	674
Figure 1-1164	Align the cover	675
Figure 1-1165	Rotate the top of the cover	675
Figure 1-1166	Slide the cover	676
Figure 1-1167	Install two screws	676
Figure 1-1168	Install the cover	677
Figure 1-1169	Engage one tab	677
Figure 1-1170	Engage one tab and install one screw	678
Figure 1-1171	Install three screws	678
Figure 1-1172	Install the cover	679
Figure 1-1173	Engage the cover	679
Figure 1-1174	Install one screw	680
Figure 1-1175	Install the cover	680
Figure 1-1176	Install four screws cover	681
Figure 1-1177	Place the control panel on the product	681
Figure 1-1178	Connect two connectors	682
Figure 1-1179	Turn the control panel over	682
Figure 1-1180	Rotate the control-panel base down	683

Figure 1-1181	Install two screws	683
Figure 1-1182	Install the cover	684
Figure 1-1183	Install the cover	684
Figure 1-1184	Check the installation	685
Figure 1-1185	Verify that the toner collection hatch cover is closed	685
Figure 1-1186	Install the TCU	686
Figure 1-1187	Close the front door	686
Figure 1-1188	Install the cover	687
Figure 1-1189	Open the stapler door	689
Figure 1-1190	Remove the staple cartridge	689
Figure 1-1191	Close the stapler door	690
Figure 1-1192	Remove one screw	690
Figure 1-1193	Release two tabs	691
Figure 1-1194	Release the back edge of the cover	691
Figure 1-1195	Remove the cover	692
Figure 1-1196	Disconnect connector and remove screws	692
Figure 1-1197	Remove the stapler unit	693
Figure 1-1198	Recycle and unpack	693
Figure 1-1199	Position the hooks in the slots	694
Figure 1-1200	Connect connector and install screws	694
Figure 1-1201	Install two tabs	695
Figure 1-1202	Install the cover assembly	695
Figure 1-1203	Install one screw	696
Figure 1-1204	Open the stapler door	696
Figure 1-1205	Install the staple cartridge	697
Figure 1-1206	Close the stapler door	697
Figure 1-1207	Locate the formatter cover	699
Figure 1-1208	Loosen the thumbscrews	700
Figure 1-1209	Remove four screws	700
Figure 1-1210	Remove the cover	701
Figure 1-1211	Remove two screws	701
Figure 1-1212	Release the right edge	702
Figure 1-1213	Slide the cover right	702
Figure 1-1214	Remove the cover	703
Figure 1-1215	Remove four screws	703
Figure 1-1216	Remove the cover	704
Figure 1-1217	Disconnect 18 connectors	704
Figure 1-1218	Disconnect the flat cables	705
Figure 1-1219	Remove the DC controller	705
Figure 1-1220	Recycle and unpack	706
Figure 1-1221	Install the DC controller	706

Figure 1-1222	Connect the flat cables	707
Figure 1-1223	Connect all of the connectors	707
Figure 1-1224	Position the hooks	708
Figure 1-1225	Install the cover	708
Figure 1-1226	Install four screws cover	709
Figure 1-1227	Align the cover	709
Figure 1-1228	Rotate the top of the cover	710
Figure 1-1229	Slide the cover	710
Figure 1-1230	Install two screws	711
Figure 1-1231	Install the cover	711
Figure 1-1232	Install four screws cover	712
Figure 1-1233	Install the cover	712
Figure 1-1234	Locate the formatter cover	715
Figure 1-1235	Loosen the thumbscrews	716
Figure 1-1236	Open the front door	716
Figure 1-1237	Open the TCU	717
Figure 1-1238	Remove the TCU	718
Figure 1-1239	Locate the USB cover	719
Figure 1-1240	Remove the cover	719
Figure 1-1241	Open the right door	720
Figure 1-1242	Release the fuser	720
Figure 1-1243	Remove the fuser	721
Figure 1-1244	Release the ITB drive coupling	721
Figure 1-1245	Lower the secondary transfer roller assembly	722
Figure 1-1246	Release the front-side ITB spring	722
Figure 1-1247	Place the spring on the holder	723
Figure 1-1248	Release the rear-side ITB spring	723
Figure 1-1249	Place the spring on the holder	724
Figure 1-1250	Grasp the ITB handles	725
Figure 1-1251	Remove the ITB	725
Figure 1-1252	Tilt the control panel up	726
Figure 1-1253	Release the control-panel screws cover tabs	726
Figure 1-1254	Remove the cover	727
Figure 1-1255	Remove two screws	727
Figure 1-1256	Rotate the control-panel base up	728
Figure 1-1257	Turn the control panel over	728
Figure 1-1258	Disconnect two connectors	729
Figure 1-1259	Remove four screws	729
Figure 1-1260	Remove the cover	730
Figure 1-1261	Remove one screw	730
Figure 1-1262	Release the cover	731

Figure 1-1263	Remove the cover	731
Figure 1-1264	Remove three screws	732
Figure 1-1265	Remove one screw and release one tab	732
Figure 1-1266	Release the cover	733
Figure 1-1267	Remove the cover	733
Figure 1-1268	Remove one screw	734
Figure 1-1269	Remove the PCA holder	734
Figure 1-1270	Remove one cable	735
Figure 1-1271	Remove four screws	735
Figure 1-1272	Remove the control panel	736
Figure 1-1273	Remove two screws	736
Figure 1-1274	Release the right edge	737
Figure 1-1275	Slide the cover right	737
Figure 1-1276	Remove the cover	738
Figure 1-1277	Release one tab	738
Figure 1-1278	Slide the cover back	739
Figure 1-1279	Remove the left upper cover	739
Figure 1-1280	Remove one screw	740
Figure 1-1281	Release two tabs	740
Figure 1-1282	Rotate the cover	741
Figure 1-1283	Remove one screw	741
Figure 1-1284	Release two tabs	742
Figure 1-1285	Release the back edge of the cover	742
Figure 1-1286	Remove the cover	743
Figure 1-1287	Remove one screw	743
Figure 1-1288	Remove two screws	744
Figure 1-1289	Remove one screw	744
Figure 1-1290	Disconnect four connectors	745
Figure 1-1291	Disconnect connectors	745
Figure 1-1292	Slide the ISA towards the back of the printer	746
Figure 1-1293	Remove the ISA	746
Figure 1-1294	Disconnect connector and remove screws	747
Figure 1-1295	Remove the stapler unit	747
Figure 1-1296	Remove two screws and one connector	748
Figure 1-1297	Remove one screw and connector	748
Figure 1-1298	Slide the cover	749
Figure 1-1299	Remove the cover	749
Figure 1-1300	Remove five screws	750
Figure 1-1301	Release two tabs	750
Figure 1-1302	Remove the top rear cover	751
Figure 1-1303	Remove one screw	751

Figure 1-1304	Remove the cover	752
Figure 1-1305	Remove one screw	752
Figure 1-1306	Remove one screw	753
Figure 1-1307	Release one tab	753
Figure 1-1308	Release two tabs	754
Figure 1-1309	Remove three screws	754
Figure 1-1310	Remove two screws	755
Figure 1-1311	Remove the bracket	755
Figure 1-1312	Release the cover	756
Figure 1-1313	Remove the cover	756
Figure 1-1314	Remove two screws	757
Figure 1-1315	Remove the PCA	757
Figure 1-1316	Release two retainers and disconnect one connector	758
Figure 1-1317	Remove four screws	758
Figure 1-1318	Remove the assembly	759
Figure 1-1319	Recycle and unpack	760
Figure 1-1320	Locate the solenoid plunger	760
Figure 1-1321	Remove the arm	761
Figure 1-1322	Separate the solenoid plunger from the arm	761
Figure 1-1323	Install the solenoid plunger	762
Figure 1-1324	Install the assembly	762
Figure 1-1325	Install four screws	763
Figure 1-1326	Connect one connector	763
Figure 1-1327	Install the PCA holder	764
Figure 1-1328	Install one screw	764
Figure 1-1329	Connect one connector	765
Figure 1-1330	Install two screws	765
Figure 1-1331	Install the cover	766
Figure 1-1332	Align the tabs	766
Figure 1-1333	Release the cover	767
Figure 1-1334	Verify the installation	767
Figure 1-1335	Position the tabs in the slots	768
Figure 1-1336	Install two screws	768
Figure 1-1337	Install three screws	769
Figure 1-1338	Position the locator pins	769
Figure 1-1339	Press down on the cover	770
Figure 1-1340	Install one screw	770
Figure 1-1341	Install one screw	771
Figure 1-1342	Install the cover	771
Figure 1-1343	Install one screw	772
Figure 1-1344	Align the locator tabs	772

Figure 1-1345	Install the cover	773
Figure 1-1346	Install five screws	773
Figure 1-1347	Install the cables	774
Figure 1-1348	Position the hooks	774
Figure 1-1349	Install the cover	775
Figure 1-1350	Install one screw and connector	775
Figure 1-1351	Install one screw and connector	776
Figure 1-1352	Position the hooks in the slots	776
Figure 1-1353	Connect connector and install screws	777
Figure 1-1354	Locate the ISA mounting pins and slots	250
Figure 1-1355	Install the ISA	778
Figure 1-1356	Slide the ISA towards the front of the printer	778
Figure 1-1357	Install one screw	779
Figure 1-1358	Install two screws	779
Figure 1-1359	Install one screw	780
Figure 1-1360	Connect connectors	780
Figure 1-1361	Connect four connectors	781
Figure 1-1362	Install two tabs	781
Figure 1-1363	Install the cover assembly	782
Figure 1-1364	Install one screw	782
Figure 1-1365	Install the cover	783
Figure 1-1366	Press the cover	783
Figure 1-1367	Install one screw	784
Figure 1-1368	Position the tab	784
Figure 1-1369	Slide the cover	785
Figure 1-1370	Check the tab	785
Figure 1-1371	Align the cover	786
Figure 1-1372	Rotate the top of the cover	786
Figure 1-1373	Slide the cover	787
Figure 1-1374	Install two screws	787
Figure 1-1375	Connect one connector	788
Figure 1-1376	Install four screws	788
Figure 1-1377	Place one cable in the guide	789
Figure 1-1378	Install the tab	789
Figure 1-1379	Install one screw	790
Figure 1-1380	Install the cover	790
Figure 1-1381	Engage one tab	791
Figure 1-1382	Engage one tab and install one screw	791
Figure 1-1383	Install three screws	792
Figure 1-1384	Install the cover	792
Figure 1-1385	Engage the cover	793

Figure 1-1386	Install one screw	793
Figure 1-1387	Install the cover	794
Figure 1-1388	Install four screws cover	794
Figure 1-1389	Place the control panel on the product	795
Figure 1-1390	Connect two connectors	795
Figure 1-1391	Turn the control panel over	796
Figure 1-1392	Rotate the control-panel base down	796
Figure 1-1393	Install two screws	797
Figure 1-1394	Install the cover	797
Figure 1-1395	Handle the ITB by the edges	798
Figure 1-1396	Align the ITB with the slots in the product	798
Figure 1-1397	Install the ITB	799
Figure 1-1398	Remove the spring from the holder	799
Figure 1-1399	Fasten the rear-side ITB spring	800
Figure 1-1400	Remove the spring from the holder	800
Figure 1-1401	Fasten the front-side ITB spring	801
Figure 1-1402	Engage the ITB drive coupling	801
Figure 1-1403	Align the fuser with the opening	802
Figure 1-1404	Install the fuser	802
Figure 1-1405	Close the right door	803
Figure 1-1406	Install the cover	803
Figure 1-1407	Check the installation	804
Figure 1-1408	Verify that the toner collection hatch cover is closed	804
Figure 1-1409	Install the TCU	805
Figure 1-1410	Close the front door	805
Figure 1-1411	Install the cover	806
Figure 1-1412	Locate the formatter cover	809
Figure 1-1413	Loosen the thumbscrews	809
Figure 1-1414	Release the HDD	810
Figure 1-1415	Remove the HDD	810
Figure 1-1416	Remove the eMMC	811
Figure 1-1417	Locate the DIMM	811
Figure 1-1418	Remove the DIMM	812
Figure 1-1419	Locate the TPM	812
Figure 1-1420	Remove the TPM	813
Figure 1-1421	Disconnect all connectors	814
Figure 1-1422	Remove the formatter	814
Figure 1-1423	Recycle and unpack	815
Figure 1-1424	Install the formatter	815
Figure 1-1425	Connect all connectors	816
Figure 1-1426	The DIMM connector	817

Figure 1-1427	Install the DIMM	817
Figure 1-1428	Verify the installation	818
Figure 1-1429	Install the eMMC	818
Figure 1-1430	Verify the installation	819
Figure 1-1431	Install the TPM	819
Figure 1-1432	Verify that the TPM is fully seated	820
Figure 1-1433	Install the holder	820
Figure 1-1434	Release the HDD	821
Figure 1-1435	Install the cover	821
Figure 1-1436	Locate the formatter cover	823
Figure 1-1437	Loosen the thumbscrews	824
Figure 1-1438	Release the HDD	824
Figure 1-1439	Remove the HDD	825
Figure 1-1440	Locate the fax PCA	825
Figure 1-1441	Disconnect one connector	826
Figure 1-1442	Release one latch	826
Figure 1-1443	Remove the fax PCA	827
Figure 1-1444	Locate the DIMM	827
Figure 1-1445	Release the DIMM	828
Figure 1-1446	Remove the DIMM (M527)	828
Figure 1-1447	Disconnect all connectors	829
Figure 1-1448	Remove four screws	830
Figure 1-1449	Remove the formatter	830
Figure 1-1450	Recycle and unpack	831
Figure 1-1451	Install the formatter	831
Figure 1-1452	Install four screws	832
Figure 1-1453	Connect all connectors	833
Figure 1-1454	Insert the DIMM	833
Figure 1-1455	Install the DIMM	834
Figure 1-1456	Snap the DIMM into place	834
Figure 1-1457	Position the fax PCA	835
Figure 1-1458	Install the fax PCA	835
Figure 1-1459	Connect the connector	836
Figure 1-1460	Install the holder	836
Figure 1-1461	Release the HDD	837
Figure 1-1462	Install the cover	837
Figure 1-1463	Open the front door	840
Figure 1-1464	Open the TCU	840
Figure 1-1465	Remove the TCU	841
Figure 1-1466	Locate the formatter cover	842
Figure 1-1467	Loosen the thumbscrews	842

Figure 1-1468	Disconnect all connectors	844
Figure 1-1469	Remove the formatter	844
Figure 1-1470	Release the HDD	845
Figure 1-1471	Remove the HDD	845
Figure 1-1472	Locate the fax PCA	846
Figure 1-1473	Disconnect one connector	846
Figure 1-1474	Release one latch	847
Figure 1-1475	Remove the fax PCA	847
Figure 1-1476	Disconnect all connectors	848
Figure 1-1477	Remove four screws	849
Figure 1-1478	Remove the formatter	849
Figure 1-1479	Remove four screws	850
Figure 1-1480	Remove the cover	850
Figure 1-1481	Remove two screws	851
Figure 1-1482	Release the right edge	851
Figure 1-1483	Slide the cover right	852
Figure 1-1484	Remove the cover	852
Figure 1-1485	Remove four screws	853
Figure 1-1486	Remove the cover	853
Figure 1-1487	Remove one screw	854
Figure 1-1488	Release the cover	854
Figure 1-1489	Remove the cover	855
Figure 1-1490	Disconnect one connector	855
Figure 1-1491	Remove the bracket	856
Figure 1-1492	Remove the LVPS cover	856
Figure 1-1493	Release wire harnesses and flat cable	857
Figure 1-1494	Remove six screws	857
Figure 1-1495	Release the formatter case	858
Figure 1-1496	Remove the formatter case	858
Figure 1-1497	Recycle and unpack	859
Figure 1-1498	Pass the wire harnesses through the opening	859
Figure 1-1499	Install the formatter case	860
Figure 1-1500	Install six screws	860
Figure 1-1501	Install wire harnesses and flat cable	861
Figure 1-1502	Install the LVPS cover	861
Figure 1-1503	Attach the flat cable	862
Figure 1-1504	Position the bracket	862
Figure 1-1505	Connect one connector	863
Figure 1-1506	Install the cover	863
Figure 1-1507	Engage the cover	864
Figure 1-1508	Install one screw	864

Figure 1-1509	Position the hooks	865
Figure 1-1510	Install the cover	865
Figure 1-1511	Install four screws cover	866
Figure 1-1512	Align the cover	866
Figure 1-1513	Rotate the top of the cover	867
Figure 1-1514	Slide the cover	867
Figure 1-1515	Install two screws	868
Figure 1-1516	Install the cover	868
Figure 1-1517	Install four screws cover	869
Figure 1-1518	Install the formatter	869
Figure 1-1519	Install four screws	870
Figure 1-1520	Connect all connectors	871
Figure 1-1521	Position the fax PCA	871
Figure 1-1522	Install the fax PCA	872
Figure 1-1523	Connect the connector	872
Figure 1-1524	Install the holder	873
Figure 1-1525	Release the HDD	873
Figure 1-1526	Install the formatter	874
Figure 1-1527	Connect all connectors	875
Figure 1-1528	Install the cover	876
Figure 1-1529	Verify that the toner collection hatch cover is closed	876
Figure 1-1530	Install the TCU	877
Figure 1-1531	Close the front door	877
Figure 1-1532	Open the front door	879
Figure 1-1533	Open the TCU	880
Figure 1-1534	Remove the TCU	881
Figure 1-1535	Locate the formatter cover	882
Figure 1-1536	Loosen the thumbscrews	882
Figure 1-1537	Remove four screws	883
Figure 1-1538	Remove the cover	883
Figure 1-1539	Remove two screws	884
Figure 1-1540	Release the right edge	884
Figure 1-1541	Slide the cover right	885
Figure 1-1542	Remove the cover	885
Figure 1-1543	Remove four screws	886
Figure 1-1544	Remove the cover	886
Figure 1-1545	Remove one screw	887
Figure 1-1546	Release the cover	887
Figure 1-1547	Remove the cover	888
Figure 1-1548	Remove the LVPS cover	888
Figure 1-1549	Disconnect one connector	889

Figure 1-1550	Pass the wire harness through the opening	889
Figure 1-1551	Disconnect three connectors	890
Figure 1-1552	Remove the fuser power supply	890
Figure 1-1553	Recycle and unpack	891
Figure 1-1554	Remove the fuser power supply	891
Figure 1-1555	Connect three connectors	892
Figure 1-1556	Pass the wire harness through the opening	892
Figure 1-1557	Connect one connector	893
Figure 1-1558	Install the LVPS cover	893
Figure 1-1559	Install the cover	894
Figure 1-1560	Engage the cover	894
Figure 1-1561	Install one screw	895
Figure 1-1562	Position the hooks	895
Figure 1-1563	Install the cover	896
Figure 1-1564	Install four screws cover	896
Figure 1-1565	Align the cover	897
Figure 1-1566	Rotate the top of the cover	897
Figure 1-1567	Slide the cover	898
Figure 1-1568	Install two screws	898
Figure 1-1569	Install the cover	899
Figure 1-1570	Install four screws cover	899
Figure 1-1571	Install the cover	900
Figure 1-1572	Verify that the toner collection hatch cover is closed	900
Figure 1-1573	Install the TCU	901
Figure 1-1574	Close the front door	901
Figure 1-1575	Open the front door	904
Figure 1-1576	Open the TCU	904
Figure 1-1577	Remove the TCU	905
Figure 1-1578	Locate the formatter cover	906
Figure 1-1579	Loosen the thumbscrews	906
Figure 1-1580	Disconnect all connectors	908
Figure 1-1581	Remove the formatter	908
Figure 1-1582	Release the HDD	909
Figure 1-1583	Remove the HDD	909
Figure 1-1584	Locate the fax PCA	910
Figure 1-1585	Disconnect one connector	910
Figure 1-1586	Release one latch	911
Figure 1-1587	Remove the fax PCA	911
Figure 1-1588	Disconnect all connectors	912
Figure 1-1589	Remove four screws	913
Figure 1-1590	Remove the formatter	913

Figure 1-1591	Remove four screws	914
Figure 1-1592	Remove the cover	914
Figure 1-1593	Remove two screws	915
Figure 1-1594	Release the right edge	915
Figure 1-1595	Slide the cover right	916
Figure 1-1596	Remove the cover	916
Figure 1-1597	Remove four screws	917
Figure 1-1598	Remove the cover	917
Figure 1-1599	Remove one screw	918
Figure 1-1600	Release the cover	918
Figure 1-1601	Remove the cover	919
Figure 1-1602	Disconnect one connector	919
Figure 1-1603	Remove the bracket	920
Figure 1-1604	Remove the LVPS cover	920
Figure 1-1605	Release wire harnesses and flat cable	921
Figure 1-1606	Remove six screws	921
Figure 1-1607	Release the formatter case	922
Figure 1-1608	Remove the formatter case	922
Figure 1-1609	Disconnect one wire harness	923
Figure 1-1610	Disconnect seven connectors	923
Figure 1-1611	Pass the wire harnesses through the opening	924
Figure 1-1612	Remove three screws	924
Figure 1-1613	Remove the LVPS	925
Figure 1-1614	Recycle and unpack	925
Figure 1-1615	Install the LVPS	926
Figure 1-1616	Install three screws	926
Figure 1-1617	Pass the wire harnesses through the opening	927
Figure 1-1618	Connect seven connectors	927
Figure 1-1619	Connect one wire harness	928
Figure 1-1620	Pass the wire harnesses through the opening	928
Figure 1-1621	Install the formatter case	929
Figure 1-1622	Install six screws	929
Figure 1-1623	Install wire harnesses and flat cable	930
Figure 1-1624	Install the LVPS cover	930
Figure 1-1625	Attach the flat cable	931
Figure 1-1626	Position the bracket	931
Figure 1-1627	Connect one connector	932
Figure 1-1628	Install the cover	932
Figure 1-1629	Engage the cover	933
Figure 1-1630	Install one screw	933
Figure 1-1631	Position the hooks	934

Figure 1-1632	Install the cover	934
Figure 1-1633	Install four screws cover	935
Figure 1-1634	Align the cover	935
Figure 1-1635	Rotate the top of the cover	936
Figure 1-1636	Slide the cover	936
Figure 1-1637	Install two screws	937
Figure 1-1638	Install the cover	937
Figure 1-1639	Install four screws cover	938
Figure 1-1640	Install the formatter	938
Figure 1-1641	Install four screws	939
Figure 1-1642	Connect all connectors	940
Figure 1-1643	Position the fax PCA	940
Figure 1-1644	Install the fax PCA	941
Figure 1-1645	Connect the connector	941
Figure 1-1646	Install the holder	942
Figure 1-1647	Release the HDD	942
Figure 1-1648	Install the formatter	943
Figure 1-1649	Connect all connectors	944
Figure 1-1650	Install the cover	945
Figure 1-1651	Verify that the toner collection hatch cover is closed	945
Figure 1-1652	Install the TCU	946
Figure 1-1653	Close the front door	946
Figure 1-1654	Open the front door	949
Figure 1-1655	Open the TCU	949
Figure 1-1656	Remove the TCU	950
Figure 1-1657	Locate the formatter cover	951
Figure 1-1658	Loosen the thumbscrews	951
Figure 1-1659	Disconnect all connectors	953
Figure 1-1660	Remove the formatter	953
Figure 1-1661	Release the HDD	954
Figure 1-1662	Remove the HDD	954
Figure 1-1663	Locate the fax PCA	955
Figure 1-1664	Disconnect one connector	955
Figure 1-1665	Release one latch	956
Figure 1-1666	Remove the fax PCA	956
Figure 1-1667	Disconnect all connectors	957
Figure 1-1668	Remove four screws	958
Figure 1-1669	Remove the formatter	958
Figure 1-1670	Remove four screws	959
Figure 1-1671	Remove the cover	959
Figure 1-1672	Remove two screws	960

Figure 1-1673	Release the right edge	960
Figure 1-1674	Slide the cover right	961
Figure 1-1675	Remove the cover	961
Figure 1-1676	Remove four screws	962
Figure 1-1677	Remove the cover	962
Figure 1-1678	Remove one screw	963
Figure 1-1679	Release the cover	963
Figure 1-1680	Remove the cover	964
Figure 1-1681	Disconnect one connector	964
Figure 1-1682	Remove the bracket	965
Figure 1-1683	Remove the LVPS cover	965
Figure 1-1684	Release wire harnesses and flat cable	966
Figure 1-1685	Remove six screws	966
Figure 1-1686	Release the formatter case	967
Figure 1-1687	Remove the formatter case	967
Figure 1-1688	Disconnect one wire harness	968
Figure 1-1689	Disconnect seven connectors	968
Figure 1-1690	Pass the wire harnesses through the opening	969
Figure 1-1691	Remove three screws	969
Figure 1-1692	Remove the LVPS	970
Figure 1-1693	Disconnect one flat cable	970
Figure 1-1694	Remove three screws	971
Figure 1-1695	Remove the HVPSD	971
Figure 1-1696	Recycle and unpack	972
Figure 1-1697	Install the HVPSD	972
Figure 1-1698	Press the tabs	973
Figure 1-1699	Install three screws	973
Figure 1-1700	Connect one flat cable	974
Figure 1-1701	Install the LVPS	974
Figure 1-1702	Install three screws	975
Figure 1-1703	Pass the wire harnesses through the opening	975
Figure 1-1704	Connect seven connectors	976
Figure 1-1705	Connect one wire harness	976
Figure 1-1706	Pass the wire harnesses through the opening	977
Figure 1-1707	Install the formatter case	977
Figure 1-1708	Install six screws	978
Figure 1-1709	Install wire harnesses and flat cable	978
Figure 1-1710	Install the LVPS cover	979
Figure 1-1711	Attach the flat cable	979
Figure 1-1712	Position the bracket	980
Figure 1-1713	Connect one connector	980

Figure 1-1714	Install the cover	981
Figure 1-1715	Engage the cover	981
Figure 1-1716	Install one screw	982
Figure 1-1717	Position the hooks	982
Figure 1-1718	Install the cover	983
Figure 1-1719	Install four screws cover	983
Figure 1-1720	Align the cover	984
Figure 1-1721	Rotate the top of the cover	984
Figure 1-1722	Slide the cover	985
Figure 1-1723	Install two screws	985
Figure 1-1724	Install the cover	986
Figure 1-1725	Install four screws cover	986
Figure 1-1726	Install the formatter	987
Figure 1-1727	Install four screws	987
Figure 1-1728	Connect all connectors	988
Figure 1-1729	Position the fax PCA	989
Figure 1-1730	Install the fax PCA	989
Figure 1-1731	Connect the connector	990
Figure 1-1732	Install the holder	990
Figure 1-1733	Release the HDD	991
Figure 1-1734	Install the formatter	992
Figure 1-1735	Connect all connectors	993
Figure 1-1736	Install the cover	993
Figure 1-1737	Verify that the toner collection hatch cover is closed	994
Figure 1-1738	Install the TCU	994
Figure 1-1739	Close the front door	995
Figure 1-1740	Open the front door	998
Figure 1-1741	Open the TCU	998
Figure 1-1742	Remove the TCU	999
Figure 1-1743	Locate the formatter cover	1000
Figure 1-1744	Loosen the thumbscrews	1000
Figure 1-1745	Disconnect all connectors	1002
Figure 1-1746	Remove the formatter	1002
Figure 1-1747	Release the HDD	1003
Figure 1-1748	Remove the HDD	1003
Figure 1-1749	Locate the fax PCA	1004
Figure 1-1750	Disconnect one connector	1004
Figure 1-1751	Release one latch	1005
Figure 1-1752	Remove the fax PCA	1005
Figure 1-1753	Disconnect all connectors	1006
Figure 1-1754	Remove four screws	1007

Figure 1-1755	Remove the formatter	1007
Figure 1-1756	Remove four screws	1008
Figure 1-1757	Remove the cover	1008
Figure 1-1758	Remove two screws	1009
Figure 1-1759	Release the right edge	1009
Figure 1-1760	Slide the cover right	1010
Figure 1-1761	Remove the cover	1010
Figure 1-1762	Remove four screws	1011
Figure 1-1763	Remove the cover	1011
Figure 1-1764	Remove one screw	1012
Figure 1-1765	Release the cover	1012
Figure 1-1766	Remove the cover	1013
Figure 1-1767	Disconnect one connector	1013
Figure 1-1768	Remove the bracket	1014
Figure 1-1769	Remove the LVPS cover	1014
Figure 1-1770	Release wire harnesses and flat cable	1015
Figure 1-1771	Remove six screws	1015
Figure 1-1772	Release the formatter case	1016
Figure 1-1773	Remove the formatter case	1016
Figure 1-1774	Remove the motor	1017
Figure 1-1775	Recycle and unpack	1017
Figure 1-1776	Install the motor	1018
Figure 1-1777	Pass the wire harnesses through the opening	1018
Figure 1-1778	Install the formatter case	1019
Figure 1-1779	Install six screws	1019
Figure 1-1780	Install wire harnesses and flat cable	1020
Figure 1-1781	Install the LVPS cover	1020
Figure 1-1782	Attach the flat cable	1021
Figure 1-1783	Position the bracket	1021
Figure 1-1784	Connect one connector	1022
Figure 1-1785	Install the cover	1022
Figure 1-1786	Engage the cover	1023
Figure 1-1787	Install one screw	1023
Figure 1-1788	Position the hooks	1024
Figure 1-1789	Install the cover	1024
Figure 1-1790	Install four screws cover	1025
Figure 1-1791	Align the cover	1025
Figure 1-1792	Rotate the top of the cover	1026
Figure 1-1793	Slide the cover	1026
Figure 1-1794	Install two screws	1027
Figure 1-1795	Install the cover	1027

Figure 1-1796	Install four screws cover	1028
Figure 1-1797	Install the formatter	1028
Figure 1-1798	Install four screws	1029
Figure 1-1799	Connect all connectors	1030
Figure 1-1800	Position the fax PCA	1030
Figure 1-1801	Install the fax PCA	1031
Figure 1-1802	Connect the connector	1031
Figure 1-1803	Install the holder	1032
Figure 1-1804	Release the HDD	1032
Figure 1-1805	Install the formatter	1033
Figure 1-1806	Connect all connectors	1034
Figure 1-1807	Install the cover	1035
Figure 1-1808	Verify that the toner collection hatch cover is closed	1035
Figure 1-1809	Install the TCU	1036
Figure 1-1810	Close the front door	1036
Figure 1-1811	Locate the USB cover	1039
Figure 1-1812	Remove the cover	1039
Figure 1-1813	Tilt the control panel up	1040
Figure 1-1814	Release the control-panel screws cover tabs	1040
Figure 1-1815	Remove the cover	1041
Figure 1-1816	Remove two screws	1041
Figure 1-1817	Rotate the control-panel base up	1042
Figure 1-1818	Turn the control panel over	1042
Figure 1-1819	Disconnect two connectors	1043
Figure 1-1820	Open the front door	1043
Figure 1-1821	Open the TCU	1044
Figure 1-1822	Remove the TCU	1045
Figure 1-1823	Locate the formatter cover	1046
Figure 1-1824	Loosen the thumbscrews	1046
Figure 1-1825	Remove four screws	1047
Figure 1-1826	Remove the cover	1047
Figure 1-1827	Remove two screws	1048
Figure 1-1828	Release the right edge	1048
Figure 1-1829	Slide the cover right	1049
Figure 1-1830	Remove the cover	1049
Figure 1-1831	Remove four screws	1050
Figure 1-1832	Remove the cover	1050
Figure 1-1833	Remove one screw	1051
Figure 1-1834	Release the cover	1051
Figure 1-1835	Remove the cover	1052
Figure 1-1836	Remove three screws	1052

Figure 1-1837	Remove one screw and release one tab	1053
Figure 1-1838	Release the cover	1053
Figure 1-1839	Remove the cover	1054
Figure 1-1840	Remove one screw	1054
Figure 1-1841	Release two tabs	1055
Figure 1-1842	Rotate the cover	1055
Figure 1-1843	Remove one screw	1056
Figure 1-1844	Release two tabs	1056
Figure 1-1845	Release the back edge of the cover	1057
Figure 1-1846	Remove the cover	1057
Figure 1-1847	Remove two screws and one connector	1058
Figure 1-1848	Remove one screw and connector	1058
Figure 1-1849	Slide the cover	1059
Figure 1-1850	Remove the cover	1059
Figure 1-1851	Release the cover	1060
Figure 1-1852	Remove the cover	1060
Figure 1-1853	Disconnect all connectors	1061
Figure 1-1854	Remove the formatter	1062
Figure 1-1855	Release the HDD	1062
Figure 1-1856	Remove the HDD	1063
Figure 1-1857	Locate the fax PCA	1063
Figure 1-1858	Disconnect one connector	1064
Figure 1-1859	Release one latch	1064
Figure 1-1860	Remove the fax PCA	1065
Figure 1-1861	Disconnect all connectors	1066
Figure 1-1862	Remove four screws	1066
Figure 1-1863	Remove the formatter	1067
Figure 1-1864	Disconnect one connector	1067
Figure 1-1865	Remove the bracket	1068
Figure 1-1866	Remove the LVPS cover	1068
Figure 1-1867	Release wire harnesses and flat cable	1069
Figure 1-1868	Remove six screws	1069
Figure 1-1869	Release the formatter case	1070
Figure 1-1870	Remove the formatter case	1070
Figure 1-1871	Disconnect one wire harness	1071
Figure 1-1872	Disconnect seven connectors	1071
Figure 1-1873	Pass the wire harnesses through the opening	1072
Figure 1-1874	Remove three screws	1072
Figure 1-1875	Remove the LVPS	1073
Figure 1-1876	Remove one screw	1073
Figure 1-1877	Release the wire harnesses	1074

Figure 1-1878	Remove the fan	1074
Figure 1-1879	Recycle and unpack	1075
Figure 1-1880	Install the fan	1075
Figure 1-1881	Place the wire harnesses in the retainer	1076
Figure 1-1882	Install one screw	1076
Figure 1-1883	Install the LVPS	1077
Figure 1-1884	Install three screws	1077
Figure 1-1885	Pass the wire harnesses through the opening	1078
Figure 1-1886	Connect seven connectors	1078
Figure 1-1887	Connect one wire harness	1079
Figure 1-1888	Pass the wire harnesses through the opening	1079
Figure 1-1889	Install the formatter case	1080
Figure 1-1890	Install six screws	1080
Figure 1-1891	Install wire harnesses and flat cable	1081
Figure 1-1892	Install the LVPS cover	1081
Figure 1-1893	Attach the flat cable	1082
Figure 1-1894	Position the bracket	1082
Figure 1-1895	Connect one connector	1083
Figure 1-1896	Install the formatter	1083
Figure 1-1897	Install four screws	1084
Figure 1-1898	Connect all connectors	1085
Figure 1-1899	Position the fax PCA	1085
Figure 1-1900	Install the fax PCA	1086
Figure 1-1901	Connect the connector	1086
Figure 1-1902	Install the holder	1087
Figure 1-1903	Release the HDD	1087
Figure 1-1904	Install the formatter	1088
Figure 1-1905	Connect all connectors	1089
Figure 1-1906	Install the cover	1089
Figure 1-1907	Install one screw	1090
Figure 1-1908	Install the cables	1090
Figure 1-1909	Position the hooks	1091
Figure 1-1910	Install the cover	1091
Figure 1-1911	Install one screw and connector	1092
Figure 1-1912	Install one screw and connector	1092
Figure 1-1913	Install two tabs	1093
Figure 1-1914	Install the cover assembly	1093
Figure 1-1915	Install one screw	1094
Figure 1-1916	Install the cover	1095
Figure 1-1917	Press the cover	1095
Figure 1-1918	Install one screw	1096

Figure 1-1919	Install the cover	1096
Figure 1-1920	Engage one tab	1097
Figure 1-1921	Engage one tab and install one screw	1097
Figure 1-1922	Install three screws	1098
Figure 1-1923	Install the cover	1098
Figure 1-1924	Engage the cover	1099
Figure 1-1925	Install one screw	1099
Figure 1-1926	Position the hooks	1100
Figure 1-1927	Install the cover	1100
Figure 1-1928	Install four screws cover	1101
Figure 1-1929	Align the cover	1101
Figure 1-1930	Rotate the top of the cover	1102
Figure 1-1931	Slide the cover	1102
Figure 1-1932	Install two screws	1103
Figure 1-1933	Install the cover	1103
Figure 1-1934	Install four screws cover	1104
Figure 1-1935	Install the cover	1104
Figure 1-1936	Verify that the toner collection hatch cover is closed	1105
Figure 1-1937	Install the TCU	1105
Figure 1-1938	Close the front door	1106
Figure 1-1939	Place the control panel on the product	1106
Figure 1-1940	Connect two connectors	1107
Figure 1-1941	Turn the control panel over	1107
Figure 1-1942	Rotate the control-panel base down	1108
Figure 1-1943	Install two screws	1108
Figure 1-1944	Install the cover	1109
Figure 1-1945	Install the cover	1109
Figure 1-1946	Check the installation	1110
Figure 1-1947	Open the front door	1113
Figure 1-1948	Open the TCU	1113
Figure 1-1949	Remove the TCU	1114
Figure 1-1950	Locate the formatter cover	1115
Figure 1-1951	Loosen the thumbscrews	1115
Figure 1-1952	Disconnect all connectors	1117
Figure 1-1953	Remove the formatter	1117
Figure 1-1954	Release the HDD	1118
Figure 1-1955	Remove the HDD	1118
Figure 1-1956	Locate the fax PCA	1119
Figure 1-1957	Disconnect one connector	1119
Figure 1-1958	Release one latch	1120
Figure 1-1959	Remove the fax PCA	1120

Figure 1-1960	Disconnect all connectors	1121
Figure 1-1961	Remove four screws	1122
Figure 1-1962	Remove the formatter	1122
Figure 1-1963	Remove four screws	1123
Figure 1-1964	Remove the cover	1123
Figure 1-1965	Remove two screws	1124
Figure 1-1966	Release the right edge	1124
Figure 1-1967	Slide the cover right	1125
Figure 1-1968	Remove the cover	1125
Figure 1-1969	Remove four screws	1126
Figure 1-1970	Remove the cover	1126
Figure 1-1971	Remove one screw	1127
Figure 1-1972	Release the cover	1127
Figure 1-1973	Remove the cover	1128
Figure 1-1974	Disconnect one connector	1128
Figure 1-1975	Remove the bracket	1129
Figure 1-1976	Remove the LVPS cover	1129
Figure 1-1977	Release wire harnesses and flat cable	1130
Figure 1-1978	Remove six screws	1130
Figure 1-1979	Release the formatter case	1131
Figure 1-1980	Remove the formatter case	1131
Figure 1-1981	Disconnect one wire harness	1132
Figure 1-1982	Disconnect seven connectors	1132
Figure 1-1983	Pass the wire harnesses through the opening	1133
Figure 1-1984	Remove three screws	1133
Figure 1-1985	Remove the LVPS	1134
Figure 1-1986	Disconnect one flat cable	1134
Figure 1-1987	Remove three screws	1135
Figure 1-1988	Remove the HVPSD	1135
Figure 1-1989	Remove the motor	1136
Figure 1-1990	Recycle and unpack	1136
Figure 1-1991	Install the motor	1137
Figure 1-1992	Install the HVPSD	1137
Figure 1-1993	Press the tabs	1138
Figure 1-1994	Install three screws	1138
Figure 1-1995	Connect one flat cable	1139
Figure 1-1996	Install the LVPS	1139
Figure 1-1997	Install three screws	1140
Figure 1-1998	Pass the wire harnesses through the opening	1140
Figure 1-1999	Connect seven connectors	1141
Figure 1-2000	Connect one wire harness	1141

Figure 1-2001	Pass the wire harnesses through the opening	1142
Figure 1-2002	Install the formatter case	1142
Figure 1-2003	Install six screws	1143
Figure 1-2004	Install wire harnesses and flat cable	1143
Figure 1-2005	Install the LVPS cover	1144
Figure 1-2006	Attach the flat cable	1144
Figure 1-2007	Position the bracket	1145
Figure 1-2008	Connect one connector	1145
Figure 1-2009	Install the cover	1146
Figure 1-2010	Engage the cover	1146
Figure 1-2011	Install one screw	1147
Figure 1-2012	Position the hooks	1147
Figure 1-2013	Install the cover	1148
Figure 1-2014	Install four screws cover	1148
Figure 1-2015	Align the cover	1149
Figure 1-2016	Rotate the top of the cover	1149
Figure 1-2017	Slide the cover	1150
Figure 1-2018	Install two screws	1150
Figure 1-2019	Install the cover	1151
Figure 1-2020	Install four screws cover	1151
Figure 1-2021	Install the formatter	1152
Figure 1-2022	Install four screws	1152
Figure 1-2023	Connect all connectors	1153
Figure 1-2024	Position the fax PCA	1154
Figure 1-2025	Install the fax PCA	1154
Figure 1-2026	Connect the connector	1155
Figure 1-2027	Install the holder	1155
Figure 1-2028	Release the HDD	1156
Figure 1-2029	Install the formatter	1157
Figure 1-2030	Connect all connectors	1158
Figure 1-2031	Install the cover	1158
Figure 1-2032	Verify that the toner collection hatch cover is closed	1159
Figure 1-2033	Install the TCU	1159
Figure 1-2034	Close the front door	1160
Figure 1-2035	Open the front door	1163
Figure 1-2036	Open the TCU	1163
Figure 1-2037	Remove the TCU	1164
Figure 1-2038	Locate the formatter cover	1165
Figure 1-2039	Loosen the thumbscrews	1165
Figure 1-2040	Disconnect all connectors	1167
Figure 1-2041	Remove the formatter	1167

Figure 1-2042	Release the HDD	1168
Figure 1-2043	Remove the HDD	1168
Figure 1-2044	Locate the fax PCA	1169
Figure 1-2045	Disconnect one connector	1169
Figure 1-2046	Release one latch	1170
Figure 1-2047	Remove the fax PCA	1170
Figure 1-2048	Disconnect all connectors	1171
Figure 1-2049	Remove four screws	1172
Figure 1-2050	Remove the formatter	1172
Figure 1-2051	Remove four screws	1173
Figure 1-2052	Remove the cover	1173
Figure 1-2053	Remove two screws	1174
Figure 1-2054	Release the right edge	1174
Figure 1-2055	Slide the cover right	1175
Figure 1-2056	Remove the cover	1175
Figure 1-2057	Remove four screws	1176
Figure 1-2058	Remove the cover	1176
Figure 1-2059	Remove one screw	1177
Figure 1-2060	Release the cover	1177
Figure 1-2061	Remove the cover	1178
Figure 1-2062	Disconnect one connector	1178
Figure 1-2063	Remove the bracket	1179
Figure 1-2064	Remove the LVPS cover	1179
Figure 1-2065	Release wire harnesses and flat cable	1180
Figure 1-2066	Remove six screws	1180
Figure 1-2067	Release the formatter case	1181
Figure 1-2068	Remove the formatter case	1181
Figure 1-2069	Disconnect one wire harness	1182
Figure 1-2070	Disconnect seven connectors	1182
Figure 1-2071	Pass the wire harnesses through the opening	1183
Figure 1-2072	Remove three screws	1183
Figure 1-2073	Remove the LVPS	1184
Figure 1-2074	Disconnect one flat cable	1184
Figure 1-2075	Remove three screws	1185
Figure 1-2076	Remove the HVPSD	1185
Figure 1-2077	Remove the assembly	1186
Figure 1-2078	Recycle and unpack	1186
Figure 1-2079	Install the assembly	1187
Figure 1-2080	Install the HVPSD	1187
Figure 1-2081	Press the tabs	1188
Figure 1-2082	Install three screws	1188

Figure 1-2083	Connect one flat cable	1189
Figure 1-2084	Install the LVPS	1189
Figure 1-2085	Install three screws	1190
Figure 1-2086	Pass the wire harnesses through the opening	1190
Figure 1-2087	Connect seven connectors	1191
Figure 1-2088	Connect one wire harness	1191
Figure 1-2089	Pass the wire harnesses through the opening	1192
Figure 1-2090	Install the formatter case	1192
Figure 1-2091	Install six screws	1193
Figure 1-2092	Install wire harnesses and flat cable	1193
Figure 1-2093	Install the LVPS cover	1194
Figure 1-2094	Attach the flat cable	1194
Figure 1-2095	Position the bracket	1195
Figure 1-2096	Connect one connector	1195
Figure 1-2097	Install the cover	1196
Figure 1-2098	Engage the cover	1196
Figure 1-2099	Install one screw	1197
Figure 1-2100	Position the hooks	1197
Figure 1-2101	Install the cover	1198
Figure 1-2102	Install four screws cover	1198
Figure 1-2103	Align the cover	1199
Figure 1-2104	Rotate the top of the cover	1199
Figure 1-2105	Slide the cover	1200
Figure 1-2106	Install two screws	1200
Figure 1-2107	Install the cover	1201
Figure 1-2108	Install four screws cover	1201
Figure 1-2109	Install the formatter	1202
Figure 1-2110	Install four screws	1202
Figure 1-2111	Connect all connectors	1203
Figure 1-2112	Position the fax PCA	1204
Figure 1-2113	Install the fax PCA	1204
Figure 1-2114	Connect the connector	1205
Figure 1-2115	Install the holder	1205
Figure 1-2116	Release the HDD	1206
Figure 1-2117	Install the formatter	1207
Figure 1-2118	Connect all connectors	1208
Figure 1-2119	Install the cover	1208
Figure 1-2120	Verify that the toner collection hatch cover is closed	1209
Figure 1-2121	Install the TCU	1209
Figure 1-2122	Close the front door	1210
Figure 1-2123	Open the front door	1213

Figure 1-2124	Open the TCU	1213
Figure 1-2125	Remove the TCU	1214
Figure 1-2126	Locate the formatter cover	1215
Figure 1-2127	Loosen the thumbscrews	1215
Figure 1-2128	Disconnect all connectors	1217
Figure 1-2129	Remove the formatter	1217
Figure 1-2130	Release the HDD	1218
Figure 1-2131	Remove the HDD	1218
Figure 1-2132	Locate the fax PCA	1219
Figure 1-2133	Disconnect one connector	1219
Figure 1-2134	Release one latch	1220
Figure 1-2135	Remove the fax PCA	1220
Figure 1-2136	Disconnect all connectors	1221
Figure 1-2137	Remove four screws	1222
Figure 1-2138	Remove the formatter	1222
Figure 1-2139	Remove four screws	1223
Figure 1-2140	Remove the cover	1223
Figure 1-2141	Remove two screws	1224
Figure 1-2142	Release the right edge	1224
Figure 1-2143	Slide the cover right	1225
Figure 1-2144	Remove the cover	1225
Figure 1-2145	Remove four screws	1226
Figure 1-2146	Remove the cover	1226
Figure 1-2147	Remove one screw	1227
Figure 1-2148	Release the cover	1227
Figure 1-2149	Remove the cover	1228
Figure 1-2150	Disconnect one connector	1228
Figure 1-2151	Remove the bracket	1229
Figure 1-2152	Remove the LVPS cover	1229
Figure 1-2153	Release wire harnesses and flat cable	1230
Figure 1-2154	Remove six screws	1230
Figure 1-2155	Release the formatter case	1231
Figure 1-2156	Remove the formatter case	1231
Figure 1-2157	Disconnect one wire harness	1232
Figure 1-2158	Disconnect seven connectors	1232
Figure 1-2159	Pass the wire harnesses through the opening	1233
Figure 1-2160	Remove three screws	1233
Figure 1-2161	Remove the LVPS	1234
Figure 1-2162	Disconnect one flat cable	1234
Figure 1-2163	Remove three screws	1235
Figure 1-2164	Remove the HVPSD	1235

Figure 1-2165	Disconnect two connectors	1236
Figure 1-2166	Disconnect two flat cables	1236
Figure 1-2167	Remove the assembly	1237
Figure 1-2168	Recycle and unpack	1237
Figure 1-2169	Install the lifter drive	1238
Figure 1-2170	Connect two flat cables	1238
Figure 1-2171	Connect two connectors	1239
Figure 1-2172	Install the HVPSD	1239
Figure 1-2173	Press the tabs	1240
Figure 1-2174	Install three screws	1240
Figure 1-2175	Connect one flat cable	1241
Figure 1-2176	Install the LVPS	1241
Figure 1-2177	Install three screws	1242
Figure 1-2178	Pass the wire harnesses through the opening	1242
Figure 1-2179	Connect seven connectors	1243
Figure 1-2180	Connect one wire harness	1243
Figure 1-2181	Pass the wire harnesses through the opening	1244
Figure 1-2182	Install the formatter case	1244
Figure 1-2183	Install six screws	1245
Figure 1-2184	Install wire harnesses and flat cable	1245
Figure 1-2185	Install the LVPS cover	1246
Figure 1-2186	Attach the flat cable	1246
Figure 1-2187	Position the bracket	1247
Figure 1-2188	Connect one connector	1247
Figure 1-2189	Install the cover	1248
Figure 1-2190	Engage the cover	1248
Figure 1-2191	Install one screw	1249
Figure 1-2192	Position the hooks	1249
Figure 1-2193	Install the cover	1250
Figure 1-2194	Install four screws cover	1250
Figure 1-2195	Align the cover	1251
Figure 1-2196	Rotate the top of the cover	1251
Figure 1-2197	Slide the cover	1252
Figure 1-2198	Install two screws	1252
Figure 1-2199	Install the cover	1253
Figure 1-2200	Install four screws cover	1253
Figure 1-2201	Install the formatter	1254
Figure 1-2202	Install four screws	1254
Figure 1-2203	Connect all connectors	1255
Figure 1-2204	Position the fax PCA	1256
Figure 1-2205	Install the fax PCA	1256

Figure 1-2206	Connect the connector	1257
Figure 1-2207	Install the holder	1257
Figure 1-2208	Release the HDD	1258
Figure 1-2209	Install the formatter	1259
Figure 1-2210	Connect all connectors	1260
Figure 1-2211	Install the cover	1260
Figure 1-2212	Verify that the toner collection hatch cover is closed	1261
Figure 1-2213	Install the TCU	1261
Figure 1-2214	Close the front door	1262
Figure 1-2215	Open the front door	1265
Figure 1-2216	Open the TCU	1265
Figure 1-2217	Remove the TCU	1266
Figure 1-2218	Remove the toner cartridge	1267
Figure 1-2219	Locate the formatter cover	1267
Figure 1-2220	Loosen the thumbscrews	1268
Figure 1-2221	Disconnect all connectors	1269
Figure 1-2222	Remove the formatter	1269
Figure 1-2223	Release the HDD	1270
Figure 1-2224	Remove the HDD	1270
Figure 1-2225	Locate the fax PCA	1271
Figure 1-2226	Disconnect one connector	1271
Figure 1-2227	Release one latch	1272
Figure 1-2228	Remove the fax PCA	1272
Figure 1-2229	Disconnect all connectors	1273
Figure 1-2230	Remove four screws	1274
Figure 1-2231	Remove the formatter	1274
Figure 1-2232	Remove four screws	1275
Figure 1-2233	Remove the cover	1275
Figure 1-2234	Remove two screws	1276
Figure 1-2235	Release the right edge	1276
Figure 1-2236	Slide the cover right	1277
Figure 1-2237	Remove the cover	1277
Figure 1-2238	Remove four screws	1278
Figure 1-2239	Remove the cover	1278
Figure 1-2240	Remove one screw	1279
Figure 1-2241	Release the cover	1279
Figure 1-2242	Remove the cover	1280
Figure 1-2243	Disconnect one connector	1280
Figure 1-2244	Remove the bracket	1281
Figure 1-2245	Remove the LVPS cover	1281
Figure 1-2246	Release wire harnesses and flat cable	1282

Figure 1-2247	Remove six screws	1282
Figure 1-2248	Release the formatter case	1283
Figure 1-2249	Remove the formatter case	1283
Figure 1-2250	Disconnect one wire harness	1284
Figure 1-2251	Disconnect seven connectors	1284
Figure 1-2252	Pass the wire harnesses through the opening	1285
Figure 1-2253	Remove three screws	1285
Figure 1-2254	Remove the LVPS	1286
Figure 1-2255	Disconnect one flat cable	1286
Figure 1-2256	Remove three screws	1287
Figure 1-2257	Remove the HVPSD	1287
Figure 1-2258	Release one wire harness	1288
Figure 1-2259	Release two tabs	1288
Figure 1-2260	Remove the guide	1289
Figure 1-2261	Disconnect two flat cables	1289
Figure 1-2262	Disconnect two connectors	1290
Figure 1-2263	Remove one screw and the plate	1290
Figure 1-2264	Release the spring	1291
Figure 1-2265	Remove the spring	1291
Figure 1-2266	Release the wire harness	1292
Figure 1-2267	Remove the laser/scanner assembly	1292
Figure 1-2268	Recycle and unpack	1293
Figure 1-2269	Handle the laser/scanner assembly carefully	1293
Figure 1-2270	Install the laser/scanner assembly	1294
Figure 1-2271	Release the spring	1294
Figure 1-2272	Install the plate and one screw	1295
Figure 1-2273	Place the wire harness in the retainers	1295
Figure 1-2274	Connect two connectors	1296
Figure 1-2275	Connect two flat cables	1296
Figure 1-2276	Install the guide	1297
Figure 1-2277	Place one wire harness in the retainer	1297
Figure 1-2278	Install the HVPSD	1298
Figure 1-2279	Press the tabs	1298
Figure 1-2280	Install three screws	1299
Figure 1-2281	Connect one flat cable	1299
Figure 1-2282	Install the LVPS	1300
Figure 1-2283	Install three screws	1300
Figure 1-2284	Pass the wire harnesses through the opening	1301
Figure 1-2285	Connect seven connectors	1301
Figure 1-2286	Connect one wire harness	1302
Figure 1-2287	Pass the wire harnesses through the opening	1302

Figure 1-2288	Install the formatter case	1303
Figure 1-2289	Install six screws	1303
Figure 1-2290	Install wire harnesses and flat cable	1304
Figure 1-2291	Install the LVPS cover	1304
Figure 1-2292	Attach the flat cable	1305
Figure 1-2293	Position the bracket	1305
Figure 1-2294	Connect one connector	1306
Figure 1-2295	Install the cover	1306
Figure 1-2296	Engage the cover	1307
Figure 1-2297	Install one screw	1307
Figure 1-2298	Position the hooks	1308
Figure 1-2299	Install the cover	1308
Figure 1-2300	Install four screws cover	1309
Figure 1-2301	Align the cover	1309
Figure 1-2302	Rotate the top of the cover	1310
Figure 1-2303	Slide the cover	1310
Figure 1-2304	Install two screws	1311
Figure 1-2305	Install the cover	1311
Figure 1-2306	Install four screws cover	1312
Figure 1-2307	Install the formatter	1312
Figure 1-2308	Install four screws	1313
Figure 1-2309	Connect all connectors	1314
Figure 1-2310	Position the fax PCA	1314
Figure 1-2311	Install the fax PCA	1315
Figure 1-2312	Connect the connector	1315
Figure 1-2313	Install the holder	1316
Figure 1-2314	Release the HDD	1316
Figure 1-2315	Install the formatter	1317
Figure 1-2316	Connect all connectors	1318
Figure 1-2317	Install the cover	1319
Figure 1-2318	Install a toner cartridge	1319
Figure 1-2319	Verify that the toner collection hatch cover is closed	1320
Figure 1-2320	Install the TCU	1320
Figure 1-2321	Close the front door	1321
Figure 1-2322	Locate the USB cover	1324
Figure 1-2323	Remove the cover	1325
Figure 1-2324	Tilt the control panel up	1326
Figure 1-2325	Release the control-panel screws cover tabs	1326
Figure 1-2326	Remove the cover	1327
Figure 1-2327	Remove two screws	1327
Figure 1-2328	Rotate the control-panel base up	1328

Figure 1-2329	Turn the control panel over	1328
Figure 1-2330	Disconnect two connectors	1329
Figure 1-2331	Pull the tray out	1329
Figure 1-2332	Remove the tray	1330
Figure 1-2333	Open the front door	1330
Figure 1-2334	Open the TCU	1331
Figure 1-2335	Remove the TCU	1332
Figure 1-2336	Locate the formatter cover	1333
Figure 1-2337	Loosen the thumbscrews	1333
Figure 1-2338	Disconnect all connectors	1335
Figure 1-2339	Remove the formatter	1335
Figure 1-2340	Release the HDD	1336
Figure 1-2341	Remove the HDD	1336
Figure 1-2342	Locate the fax PCA	1337
Figure 1-2343	Disconnect one connector	1337
Figure 1-2344	Release one latch	1338
Figure 1-2345	Remove the fax PCA	1338
Figure 1-2346	Disconnect all connectors	1339
Figure 1-2347	Remove four screws	1340
Figure 1-2348	Remove the formatter	1340
Figure 1-2349	Remove four screws	1341
Figure 1-2350	Remove the cover	1341
Figure 1-2351	Remove two screws	1342
Figure 1-2352	Release the right edge	1342
Figure 1-2353	Slide the cover right	1343
Figure 1-2354	Remove the cover	1343
Figure 1-2355	Remove four screws	1344
Figure 1-2356	Remove the cover	1344
Figure 1-2357	Release one tab	1345
Figure 1-2358	Slide the cover back	1345
Figure 1-2359	Remove the left upper cover	1346
Figure 1-2360	Remove one screw	1346
Figure 1-2361	Release two tabs	1347
Figure 1-2362	Rotate the cover	1347
Figure 1-2363	Remove one screw	1348
Figure 1-2364	Release two tabs	1348
Figure 1-2365	Release the back edge of the cover	1349
Figure 1-2366	Remove the cover	1349
Figure 1-2367	Remove one screw	1350
Figure 1-2368	Remove two screws	1350
Figure 1-2369	Remove one screw	1351

Figure 1-2370	Disconnect connectors	1351
Figure 1-2371	Slide the ISA towards the back of the printer	1352
Figure 1-2372	Remove the ISA	1352
Figure 1-2373	Remove two screws and one connector	1353
Figure 1-2374	Remove one screw and connector	1353
Figure 1-2375	Slide the cover	1354
Figure 1-2376	Remove the cover	1354
Figure 1-2377	Remove one screw	1355
Figure 1-2378	Remove one screw	1355
Figure 1-2379	Release one tab	1356
Figure 1-2380	Release two tabs	1356
Figure 1-2381	Remove one screw	1357
Figure 1-2382	Release the cover	1357
Figure 1-2383	Remove the cover	1358
Figure 1-2384	Remove three screws	1358
Figure 1-2385	Remove one screw and release one tab	1359
Figure 1-2386	Release the cover	1359
Figure 1-2387	Remove the cover	1360
Figure 1-2388	Disconnect one connector	1360
Figure 1-2389	Remove the bracket	1361
Figure 1-2390	Remove the LVPS cover	1361
Figure 1-2391	Release wire harnesses and flat cable	1362
Figure 1-2392	Remove six screws	1362
Figure 1-2393	Release the formatter case	1363
Figure 1-2394	Remove the formatter case	1363
Figure 1-2395	Disconnect one connector	1364
Figure 1-2396	Remove one screw	1364
Figure 1-2397	Release the fan	1365
Figure 1-2398	Remove the fan	1365
Figure 1-2399	Recycle and unpack	1366
Figure 1-2400	Install the fan	1366
Figure 1-2401	Engage the fan with the chassis	1367
Figure 1-2402	Install one screw	1367
Figure 1-2403	Connect one connector	1368
Figure 1-2404	Pass the wire harnesses through the opening	1368
Figure 1-2405	Install the formatter case	1369
Figure 1-2406	Install six screws	1369
Figure 1-2407	Install wire harnesses and flat cable	1370
Figure 1-2408	Install the LVPS cover	1370
Figure 1-2409	Attach the flat cable	1371
Figure 1-2410	Position the bracket	1371

Figure 1-2411	Connect one connector	1372
Figure 1-2412	Install the cover	1372
Figure 1-2413	Engage one tab	1373
Figure 1-2414	Engage one tab and install one screw	1373
Figure 1-2415	Install three screws	1374
Figure 1-2416	Install the cover	1374
Figure 1-2417	Engage the cover	1375
Figure 1-2418	Install one screw	1375
Figure 1-2419	Position the locator pins	1376
Figure 1-2420	Press down on the cover	1376
Figure 1-2421	Install one screw	1377
Figure 1-2422	Install one screw	1377
Figure 1-2423	Install the cables	1378
Figure 1-2424	Position the hooks	1378
Figure 1-2425	Install the cover	1379
Figure 1-2426	Install one screw and connector	1379
Figure 1-2427	Install one screw and connector	1380
Figure 1-2428	Locate the ISA mounting pins and slots	250
Figure 1-2429	Install the ISA	1381
Figure 1-2430	Slide the ISA towards the front of the printer	1381
Figure 1-2431	Install one screw	1382
Figure 1-2432	Install two screws	1382
Figure 1-2433	Install one screw	1383
Figure 1-2434	Connect connectors	1383
Figure 1-2435	Install two tabs	1384
Figure 1-2436	Install the cover assembly	1384
Figure 1-2437	Install one screw	1385
Figure 1-2438	Install the cover	1386
Figure 1-2439	Press the cover	1386
Figure 1-2440	Install one screw	1387
Figure 1-2441	Position the tab	1387
Figure 1-2442	Slide the cover	1388
Figure 1-2443	Check the tab	1388
Figure 1-2444	Position the hooks	1389
Figure 1-2445	Install the cover	1389
Figure 1-2446	Install four screws cover	1390
Figure 1-2447	Align the cover	1390
Figure 1-2448	Rotate the top of the cover	1391
Figure 1-2449	Slide the cover	1391
Figure 1-2450	Install two screws	1392
Figure 1-2451	Install the cover	1392

Figure 1-2452	Install four screws cover	1393
Figure 1-2453	Install the formatter	1393
Figure 1-2454	Install four screws	1394
Figure 1-2455	Connect all connectors	1395
Figure 1-2456	Position the fax PCA	1395
Figure 1-2457	Install the fax PCA	1396
Figure 1-2458	Connect the connector	1396
Figure 1-2459	Install the holder	1397
Figure 1-2460	Release the HDD	1397
Figure 1-2461	Install the formatter	1398
Figure 1-2462	Connect all connectors	1399
Figure 1-2463	Install the cover	1400
Figure 1-2464	Verify that the toner collection hatch cover is closed	1400
Figure 1-2465	Install the TCU	1401
Figure 1-2466	Close the front door	1401
Figure 1-2467	Install the tray	1402
Figure 1-2468	Close the tray	1402
Figure 1-2469	Place the control panel on the product	1403
Figure 1-2470	Connect two connectors	1403
Figure 1-2471	Turn the control panel over	1404
Figure 1-2472	Rotate the control-panel base down	1404
Figure 1-2473	Install two screws	1405
Figure 1-2474	Install the cover	1405
Figure 1-2475	Install the cover	1406
Figure 1-2476	Check the installation	1406
Figure 1-2477	Locate the USB cover	1410
Figure 1-2478	Remove the cover	1410
Figure 1-2479	Tilt the control panel up	1411
Figure 1-2480	Release the control-panel screws cover tabs	1411
Figure 1-2481	Remove the cover	1412
Figure 1-2482	Remove two screws	1412
Figure 1-2483	Rotate the control-panel base up	1413
Figure 1-2484	Turn the control panel over	1413
Figure 1-2485	Disconnect two connectors	1414
Figure 1-2486	Pull the tray out	1414
Figure 1-2487	Remove the tray	1415
Figure 1-2488	Open the front door	1415
Figure 1-2489	Open the TCU	1416
Figure 1-2490	Remove the TCU	1417
Figure 1-2491	Locate the formatter cover	1418
Figure 1-2492	Loosen the thumbscrews	1418

Figure 1-2493	Disconnect all connectors	1420
Figure 1-2494	Remove the formatter	1420
Figure 1-2495	Release the HDD	1421
Figure 1-2496	Remove the HDD	1421
Figure 1-2497	Locate the fax PCA	1422
Figure 1-2498	Disconnect one connector	1422
Figure 1-2499	Release one latch	1423
Figure 1-2500	Remove the fax PCA	1423
Figure 1-2501	Disconnect all connectors	1424
Figure 1-2502	Remove four screws	1425
Figure 1-2503	Remove the formatter	1425
Figure 1-2504	Remove four screws	1426
Figure 1-2505	Remove the cover	1426
Figure 1-2506	Remove two screws	1427
Figure 1-2507	Release the right edge	1427
Figure 1-2508	Slide the cover right	1428
Figure 1-2509	Remove the cover	1428
Figure 1-2510	Remove four screws	1429
Figure 1-2511	Remove the cover	1429
Figure 1-2512	Release one tab	1430
Figure 1-2513	Slide the cover back	1430
Figure 1-2514	Remove the left upper cover	1431
Figure 1-2515	Remove one screw	1431
Figure 1-2516	Release two tabs	1432
Figure 1-2517	Rotate the cover	1432
Figure 1-2518	Remove one screw	1433
Figure 1-2519	Release two tabs	1433
Figure 1-2520	Release the back edge of the cover	1434
Figure 1-2521	Remove the cover	1434
Figure 1-2522	Remove one screw	1435
Figure 1-2523	Remove two screws	1435
Figure 1-2524	Remove one screw	1436
Figure 1-2525	Disconnect connectors	1436
Figure 1-2526	Slide the ISA towards the back of the printer	1437
Figure 1-2527	Remove the ISA	1437
Figure 1-2528	Remove two screws and one connector	1438
Figure 1-2529	Remove one screw and connector	1438
Figure 1-2530	Slide the cover	1439
Figure 1-2531	Remove the cover	1439
Figure 1-2532	Remove five screws	1440
Figure 1-2533	Release two tabs	1440

Figure 1-2534	Remove the top rear cover	1441
Figure 1-2535	Remove one screw	1441
Figure 1-2536	Release the cover	1442
Figure 1-2537	Remove the cover	1442
Figure 1-2538	Remove three screws	1443
Figure 1-2539	Remove one screw and release one tab	1443
Figure 1-2540	Release the cover	1444
Figure 1-2541	Remove the cover	1444
Figure 1-2542	Disconnect one connector	1445
Figure 1-2543	Remove the bracket	1445
Figure 1-2544	Remove the LVPS cover	1446
Figure 1-2545	Release wire harnesses and flat cable	1446
Figure 1-2546	Remove six screws	1447
Figure 1-2547	Release the formatter case	1447
Figure 1-2548	Remove the formatter case	1448
Figure 1-2549	Release the cover	1448
Figure 1-2550	Remove the cover	1449
Figure 1-2551	Remove two screws	1449
Figure 1-2552	Remove the plate	1450
Figure 1-2553	Disconnect five connectors and one flat cable	1450
Figure 1-2554	Remove one screw	1451
Figure 1-2555	Release the HVPST	1451
Figure 1-2556	Remove the HVPST	1452
Figure 1-2557	Recycle and unpack	1452
Figure 1-2558	Connect one ground wire	1453
Figure 1-2559	Install the HVPST	1453
Figure 1-2560	Install one screw	1454
Figure 1-2561	Connect five connectors and one flat cable	1454
Figure 1-2562	Install the plate	1455
Figure 1-2563	Install two screws	1455
Figure 1-2564	Install the cover	1456
Figure 1-2565	Install one screw	1456
Figure 1-2566	Pass the wire harnesses through the opening	1457
Figure 1-2567	Install the formatter case	1457
Figure 1-2568	Install six screws	1458
Figure 1-2569	Install wire harnesses and flat cable	1458
Figure 1-2570	Install the LVPS cover	1459
Figure 1-2571	Attach the flat cable	1459
Figure 1-2572	Position the bracket	1460
Figure 1-2573	Connect one connector	1460
Figure 1-2574	Install the cover	1461

Figure 1-2575	Engage one tab	1461
Figure 1-2576	Engage one tab and install one screw	1462
Figure 1-2577	Install three screws	1462
Figure 1-2578	Install the cover	1463
Figure 1-2579	Engage the cover	1463
Figure 1-2580	Install one screw	1464
Figure 1-2581	Align the locator tabs	1464
Figure 1-2582	Install the cover	1465
Figure 1-2583	Install five screws	1465
Figure 1-2584	Install the cables	1466
Figure 1-2585	Position the hooks	1466
Figure 1-2586	Install the cover	1467
Figure 1-2587	Install one screw and connector	1467
Figure 1-2588	Install one screw and connector	1468
Figure 1-2589	Locate the ISA mounting pins and slots	250
Figure 1-2590	Install the ISA	1469
Figure 1-2591	Slide the ISA towards the front of the printer	1469
Figure 1-2592	Install one screw	1470
Figure 1-2593	Install two screws	1470
Figure 1-2594	Install one screw	1471
Figure 1-2595	Connect connectors	1471
Figure 1-2596	Install two tabs	1472
Figure 1-2597	Install the cover assembly	1472
Figure 1-2598	Install one screw	1473
Figure 1-2599	Install the cover	1474
Figure 1-2600	Press the cover	1474
Figure 1-2601	Install one screw	1475
Figure 1-2602	Position the tab	1475
Figure 1-2603	Slide the cover	1476
Figure 1-2604	Check the tab	1476
Figure 1-2605	Position the hooks	1477
Figure 1-2606	Install the cover	1477
Figure 1-2607	Install four screws cover	1478
Figure 1-2608	Align the cover	1478
Figure 1-2609	Rotate the top of the cover	1479
Figure 1-2610	Slide the cover	1479
Figure 1-2611	Install two screws	1480
Figure 1-2612	Install the cover	1480
Figure 1-2613	Install four screws cover	1481
Figure 1-2614	Install the formatter	1481
Figure 1-2615	Install four screws	1482

Figure 1-2616	Connect all connectors	1483
Figure 1-2617	Position the fax PCA	1483
Figure 1-2618	Install the fax PCA	1484
Figure 1-2619	Connect the connector	1484
Figure 1-2620	Install the holder	1485
Figure 1-2621	Release the HDD	1485
Figure 1-2622	Install the formatter	1486
Figure 1-2623	Connect all connectors	1487
Figure 1-2624	Install the cover	1488
Figure 1-2625	Verify that the toner collection hatch cover is closed	1488
Figure 1-2626	Install the TCU	1489
Figure 1-2627	Close the front door	1489
Figure 1-2628	Install the tray	1490
Figure 1-2629	Close the tray	1490
Figure 1-2630	Place the control panel on the product	1491
Figure 1-2631	Connect two connectors	1491
Figure 1-2632	Turn the control panel over	1492
Figure 1-2633	Rotate the control-panel base down	1492
Figure 1-2634	Install two screws	1493
Figure 1-2635	Install the cover	1493
Figure 1-2636	Install the cover	1494
Figure 1-2637	Check the installation	1494
Figure 1-2638	Locate the USB cover	1497
Figure 1-2639	Remove the cover	1498
Figure 1-2640	Tilt the control panel up	1499
Figure 1-2641	Release the control-panel screws cover tabs	1499
Figure 1-2642	Remove the cover	1500
Figure 1-2643	Remove two screws	1500
Figure 1-2644	Rotate the control-panel base up	1501
Figure 1-2645	Turn the control panel over	1501
Figure 1-2646	Disconnect two connectors	1502
Figure 1-2647	Pull the tray out	1502
Figure 1-2648	Remove the tray	1503
Figure 1-2649	Open the front door	1503
Figure 1-2650	Open the TCU	1504
Figure 1-2651	Remove the TCU	1505
Figure 1-2652	Locate the formatter cover	1506
Figure 1-2653	Loosen the thumbscrews	1506
Figure 1-2654	Disconnect all connectors	1508
Figure 1-2655	Remove the formatter	1508
Figure 1-2656	Release the HDD	1509

Figure 1-2657	Remove the HDD	1509
Figure 1-2658	Locate the fax PCA	1510
Figure 1-2659	Disconnect one connector	1510
Figure 1-2660	Release one latch	1511
Figure 1-2661	Remove the fax PCA	1511
Figure 1-2662	Disconnect all connectors	1512
Figure 1-2663	Remove four screws	1513
Figure 1-2664	Remove the formatter	1513
Figure 1-2665	Remove four screws	1514
Figure 1-2666	Remove the cover	1514
Figure 1-2667	Remove two screws	1515
Figure 1-2668	Release the right edge	1515
Figure 1-2669	Slide the cover right	1516
Figure 1-2670	Remove the cover	1516
Figure 1-2671	Remove four screws	1517
Figure 1-2672	Remove the cover	1517
Figure 1-2673	Release one tab	1518
Figure 1-2674	Slide the cover back	1518
Figure 1-2675	Remove the left upper cover	1519
Figure 1-2676	Remove one screw	1519
Figure 1-2677	Release two tabs	1520
Figure 1-2678	Rotate the cover	1520
Figure 1-2679	Remove one screw	1521
Figure 1-2680	Release two tabs	1521
Figure 1-2681	Release the back edge of the cover	1522
Figure 1-2682	Remove the cover	1522
Figure 1-2683	Remove one screw	1523
Figure 1-2684	Remove two screws	1523
Figure 1-2685	Remove one screw	1524
Figure 1-2686	Disconnect connectors	1524
Figure 1-2687	Slide the ISA towards the back of the printer	1525
Figure 1-2688	Remove the ISA	1525
Figure 1-2689	Remove two screws and one connector	1526
Figure 1-2690	Remove one screw and connector	1526
Figure 1-2691	Slide the cover	1527
Figure 1-2692	Remove the cover	1527
Figure 1-2693	Remove five screws	1528
Figure 1-2694	Release two tabs	1528
Figure 1-2695	Remove the top rear cover	1529
Figure 1-2696	Remove one screw	1529
Figure 1-2697	Release the cover	1530

Figure 1-2698	Remove the cover	1530
Figure 1-2699	Remove three screws	1531
Figure 1-2700	Remove one screw and release one tab	1531
Figure 1-2701	Release the cover	1532
Figure 1-2702	Remove the cover	1532
Figure 1-2703	Disconnect one connector	1533
Figure 1-2704	Remove the bracket	1533
Figure 1-2705	Remove the LVPS cover	1534
Figure 1-2706	Release wire harnesses and flat cable	1534
Figure 1-2707	Remove six screws	1535
Figure 1-2708	Release the formatter case	1535
Figure 1-2709	Remove the formatter case	1536
Figure 1-2710	Release the cover	1536
Figure 1-2711	Remove the cover	1537
Figure 1-2712	Remove two screws	1537
Figure 1-2713	Remove the plate	1538
Figure 1-2714	Disconnect five connectors and one flat cable	1538
Figure 1-2715	Remove one screw	1539
Figure 1-2716	Release the HVPST	1539
Figure 1-2717	Remove the HVPST	1540
Figure 1-2718	Remove the motor	1540
Figure 1-2719	Recycle and unpack	1541
Figure 1-2720	Install the motor	1541
Figure 1-2721	Connect one ground wire	1542
Figure 1-2722	Install the HVPST	1542
Figure 1-2723	Install one screw	1543
Figure 1-2724	Connect five connectors and one flat cable	1543
Figure 1-2725	Install the plate	1544
Figure 1-2726	Install two screws	1544
Figure 1-2727	Install the cover	1545
Figure 1-2728	Install one screw	1545
Figure 1-2729	Pass the wire harnesses through the opening	1546
Figure 1-2730	Install the formatter case	1546
Figure 1-2731	Install six screws	1547
Figure 1-2732	Install wire harnesses and flat cable	1547
Figure 1-2733	Install the LVPS cover	1548
Figure 1-2734	Attach the flat cable	1548
Figure 1-2735	Position the bracket	1549
Figure 1-2736	Connect one connector	1549
Figure 1-2737	Install the cover	1550
Figure 1-2738	Engage one tab	1550

Figure 1-2739	Engage one tab and install one screw	1551
Figure 1-2740	Install three screws	1551
Figure 1-2741	Install the cover	1552
Figure 1-2742	Engage the cover	1552
Figure 1-2743	Install one screw	1553
Figure 1-2744	Align the locator tabs	1553
Figure 1-2745	Install the cover	1554
Figure 1-2746	Install five screws	1554
Figure 1-2747	Install the cables	1555
Figure 1-2748	Position the hooks	1555
Figure 1-2749	Install the cover	1556
Figure 1-2750	Install one screw and connector	1556
Figure 1-2751	Install one screw and connector	1557
Figure 1-2752	Locate the ISA mounting pins and slots	250
Figure 1-2753	Install the ISA	1558
Figure 1-2754	Slide the ISA towards the front of the printer	1558
Figure 1-2755	Install one screw	1559
Figure 1-2756	Install two screws	1559
Figure 1-2757	Install one screw	1560
Figure 1-2758	Connect connectors	1560
Figure 1-2759	Install two tabs	1561
Figure 1-2760	Install the cover assembly	1561
Figure 1-2761	Install one screw	1562
Figure 1-2762	Install the cover	1563
Figure 1-2763	Press the cover	1563
Figure 1-2764	Install one screw	1564
Figure 1-2765	Position the tab	1564
Figure 1-2766	Slide the cover	1565
Figure 1-2767	Check the tab	1565
Figure 1-2768	Position the hooks	1566
Figure 1-2769	Install the cover	1566
Figure 1-2770	Install four screws cover	1567
Figure 1-2771	Align the cover	1567
Figure 1-2772	Rotate the top of the cover	1568
Figure 1-2773	Slide the cover	1568
Figure 1-2774	Install two screws	1569
Figure 1-2775	Install the cover	1569
Figure 1-2776	Install four screws cover	1570
Figure 1-2777	Install the formatter	1570
Figure 1-2778	Install four screws	1571
Figure 1-2779	Connect all connectors	1572

Figure 1-2780	Position the fax PCA	1572
Figure 1-2781	Install the fax PCA	1573
Figure 1-2782	Connect the connector	1573
Figure 1-2783	Install the holder	1574
Figure 1-2784	Release the HDD	1574
Figure 1-2785	Install the formatter	1575
Figure 1-2786	Connect all connectors	1576
Figure 1-2787	Install the cover	1577
Figure 1-2788	Verify that the toner collection hatch cover is closed	1577
Figure 1-2789	Install the TCU	1578
Figure 1-2790	Close the front door	1578
Figure 1-2791	Install the tray	1579
Figure 1-2792	Close the tray	1579
Figure 1-2793	Place the control panel on the product	1580
Figure 1-2794	Connect two connectors	1580
Figure 1-2795	Turn the control panel over	1581
Figure 1-2796	Rotate the control-panel base down	1581
Figure 1-2797	Install two screws	1582
Figure 1-2798	Install the cover	1582
Figure 1-2799	Install the cover	1583
Figure 1-2800	Check the installation	1583
Figure 1-2801	Locate the USB cover	1586
Figure 1-2802	Remove the cover	1587
Figure 1-2803	Tilt the control panel up	1588
Figure 1-2804	Release the control-panel screws cover tabs	1588
Figure 1-2805	Remove the cover	1589
Figure 1-2806	Remove two screws	1589
Figure 1-2807	Rotate the control-panel base up	1590
Figure 1-2808	Turn the control panel over	1590
Figure 1-2809	Disconnect two connectors	1591
Figure 1-2810	Pull the tray out	1591
Figure 1-2811	Remove the tray	1592
Figure 1-2812	Open the front door	1592
Figure 1-2813	Open the TCU	1593
Figure 1-2814	Remove the TCU	1594
Figure 1-2815	Locate the formatter cover	1595
Figure 1-2816	Loosen the thumbscrews	1595
Figure 1-2817	Disconnect all connectors	1597
Figure 1-2818	Remove the formatter	1597
Figure 1-2819	Release the HDD	1598
Figure 1-2820	Remove the HDD	1598

Figure 1-2821	Locate the fax PCA	1599
Figure 1-2822	Disconnect one connector	1599
Figure 1-2823	Release one latch	1600
Figure 1-2824	Remove the fax PCA	1600
Figure 1-2825	Disconnect all connectors	1601
Figure 1-2826	Remove four screws	1602
Figure 1-2827	Remove the formatter	1602
Figure 1-2828	Remove four screws	1603
Figure 1-2829	Remove the cover	1603
Figure 1-2830	Remove two screws	1604
Figure 1-2831	Release the right edge	1604
Figure 1-2832	Slide the cover right	1605
Figure 1-2833	Remove the cover	1605
Figure 1-2834	Remove four screws	1606
Figure 1-2835	Remove the cover	1606
Figure 1-2836	Release one tab	1607
Figure 1-2837	Slide the cover back	1607
Figure 1-2838	Remove the left upper cover	1608
Figure 1-2839	Remove one screw	1608
Figure 1-2840	Release two tabs	1609
Figure 1-2841	Rotate the cover	1609
Figure 1-2842	Remove one screw	1610
Figure 1-2843	Release two tabs	1610
Figure 1-2844	Release the back edge of the cover	1611
Figure 1-2845	Remove the cover	1611
Figure 1-2846	Remove one screw	1612
Figure 1-2847	Remove two screws	1612
Figure 1-2848	Remove one screw	1613
Figure 1-2849	Disconnect connectors	1613
Figure 1-2850	Slide the ISA towards the back of the printer	1614
Figure 1-2851	Remove the ISA	1614
Figure 1-2852	Remove two screws and one connector	1615
Figure 1-2853	Remove one screw and connector	1615
Figure 1-2854	Slide the cover	1616
Figure 1-2855	Remove the cover	1616
Figure 1-2856	Remove five screws	1617
Figure 1-2857	Release two tabs	1617
Figure 1-2858	Remove the top rear cover	1618
Figure 1-2859	Remove one screw	1618
Figure 1-2860	Release the cover	1619
Figure 1-2861	Remove the cover	1619

Figure 1-2862	Remove three screws	1620
Figure 1-2863	Remove one screw and release one tab	1620
Figure 1-2864	Release the cover	1621
Figure 1-2865	Remove the cover	1621
Figure 1-2866	Disconnect one connector	1622
Figure 1-2867	Remove the bracket	1622
Figure 1-2868	Remove the LVPS cover	1623
Figure 1-2869	Release wire harnesses and flat cable	1623
Figure 1-2870	Remove six screws	1624
Figure 1-2871	Release the formatter case	1624
Figure 1-2872	Remove the formatter case	1625
Figure 1-2873	Release the cover	1625
Figure 1-2874	Remove the cover	1626
Figure 1-2875	Remove two screws	1626
Figure 1-2876	Remove the plate	1627
Figure 1-2877	Disconnect five connectors and one flat cable	1627
Figure 1-2878	Remove one screw	1628
Figure 1-2879	Release the HVPST	1628
Figure 1-2880	Remove the HVPST	1629
Figure 1-2881	Remove the motor	1629
Figure 1-2882	Recycle and unpack	1630
Figure 1-2883	Install the motor	1630
Figure 1-2884	Connect one ground wire	1631
Figure 1-2885	Install the HVPST	1631
Figure 1-2886	Install one screw	1632
Figure 1-2887	Connect five connectors and one flat cable	1632
Figure 1-2888	Install the plate	1633
Figure 1-2889	Install two screws	1633
Figure 1-2890	Install the cover	1634
Figure 1-2891	Install one screw	1634
Figure 1-2892	Pass the wire harnesses through the opening	1635
Figure 1-2893	Install the formatter case	1635
Figure 1-2894	Install six screws	1636
Figure 1-2895	Install wire harnesses and flat cable	1636
Figure 1-2896	Install the LVPS cover	1637
Figure 1-2897	Attach the flat cable	1637
Figure 1-2898	Position the bracket	1638
Figure 1-2899	Connect one connector	1638
Figure 1-2900	Install the cover	1639
Figure 1-2901	Engage one tab	1639
Figure 1-2902	Engage one tab and install one screw	1640

Figure 1-2903	Install three screws	1640
Figure 1-2904	Install the cover	1641
Figure 1-2905	Engage the cover	1641
Figure 1-2906	Install one screw	1642
Figure 1-2907	Align the locator tabs	1642
Figure 1-2908	Install the cover	1643
Figure 1-2909	Install five screws	1643
Figure 1-2910	Install the cables	1644
Figure 1-2911	Position the hooks	1644
Figure 1-2912	Install the cover	1645
Figure 1-2913	Install one screw and connector	1645
Figure 1-2914	Install one screw and connector	1646
Figure 1-2915	Locate the ISA mounting pins and slots	250
Figure 1-2916	Install the ISA	1647
Figure 1-2917	Slide the ISA towards the front of the printer	1647
Figure 1-2918	Install one screw	1648
Figure 1-2919	Install two screws	1648
Figure 1-2920	Install one screw	1649
Figure 1-2921	Connect connectors	1649
Figure 1-2922	Install two tabs	1650
Figure 1-2923	Install the cover assembly	1650
Figure 1-2924	Install one screw	1651
Figure 1-2925	Install the cover	1652
Figure 1-2926	Press the cover	1652
Figure 1-2927	Install one screw	1653
Figure 1-2928	Position the tab	1653
Figure 1-2929	Slide the cover	1654
Figure 1-2930	Check the tab	1654
Figure 1-2931	Position the hooks	1655
Figure 1-2932	Install the cover	1655
Figure 1-2933	Install four screws cover	1656
Figure 1-2934	Align the cover	1656
Figure 1-2935	Rotate the top of the cover	1657
Figure 1-2936	Slide the cover	1657
Figure 1-2937	Install two screws	1658
Figure 1-2938	Install the cover	1658
Figure 1-2939	Install four screws cover	1659
Figure 1-2940	Install the formatter	1659
Figure 1-2941	Install four screws	1660
Figure 1-2942	Connect all connectors	1661
Figure 1-2943	Position the fax PCA	1661

Figure 1-2944	Install the fax PCA	1662
Figure 1-2945	Connect the connector	1662
Figure 1-2946	Install the holder	1663
Figure 1-2947	Release the HDD	1663
Figure 1-2948	Install the formatter	1664
Figure 1-2949	Connect all connectors	1665
Figure 1-2950	Install the cover	1666
Figure 1-2951	Verify that the toner collection hatch cover is closed	1666
Figure 1-2952	Install the TCU	1667
Figure 1-2953	Close the front door	1667
Figure 1-2954	Install the tray	1668
Figure 1-2955	Close the tray	1668
Figure 1-2956	Place the control panel on the product	1669
Figure 1-2957	Connect two connectors	1669
Figure 1-2958	Turn the control panel over	1670
Figure 1-2959	Rotate the control-panel base down	1670
Figure 1-2960	Install two screws	1671
Figure 1-2961	Install the cover	1671
Figure 1-2962	Install the cover	1672
Figure 1-2963	Check the installation	1672
Figure 1-2964	Locate the USB cover	1675
Figure 1-2965	Remove the cover	1676
Figure 1-2966	Tilt the control panel up	1677
Figure 1-2967	Release the control-panel screws cover tabs	1677
Figure 1-2968	Remove the cover	1678
Figure 1-2969	Remove two screws	1678
Figure 1-2970	Rotate the control-panel base up	1679
Figure 1-2971	Turn the control panel over	1679
Figure 1-2972	Disconnect two connectors	1680
Figure 1-2973	Pull the tray out	1680
Figure 1-2974	Remove the tray	1681
Figure 1-2975	Open the front door	1681
Figure 1-2976	Open the TCU	1682
Figure 1-2977	Remove the TCU	1683
Figure 1-2978	Locate the formatter cover	1684
Figure 1-2979	Loosen the thumbscrews	1684
Figure 1-2980	Disconnect all connectors	1686
Figure 1-2981	Remove the formatter	1686
Figure 1-2982	Release the HDD	1687
Figure 1-2983	Remove the HDD	1687
Figure 1-2984	Locate the fax PCA	1688

Figure 1-2985	Disconnect one connector	1688
Figure 1-2986	Release one latch	1689
Figure 1-2987	Remove the fax PCA	1689
Figure 1-2988	Disconnect all connectors	1690
Figure 1-2989	Remove four screws	1691
Figure 1-2990	Remove the formatter	1691
Figure 1-2991	Remove four screws	1692
Figure 1-2992	Remove the cover	1692
Figure 1-2993	Remove two screws	1693
Figure 1-2994	Release the right edge	1693
Figure 1-2995	Slide the cover right	1694
Figure 1-2996	Remove the cover	1694
Figure 1-2997	Remove four screws	1695
Figure 1-2998	Remove the cover	1695
Figure 1-2999	Release one tab	1696
Figure 1-3000	Slide the cover back	1696
Figure 1-3001	Remove the left upper cover	1697
Figure 1-3002	Remove one screw	1697
Figure 1-3003	Release two tabs	1698
Figure 1-3004	Rotate the cover	1698
Figure 1-3005	Remove one screw	1699
Figure 1-3006	Release two tabs	1699
Figure 1-3007	Release the back edge of the cover	1700
Figure 1-3008	Remove the cover	1700
Figure 1-3009	Remove one screw	1701
Figure 1-3010	Remove two screws	1701
Figure 1-3011	Remove one screw	1702
Figure 1-3012	Disconnect connectors	1702
Figure 1-3013	Slide the ISA towards the back of the printer	1703
Figure 1-3014	Remove the ISA	1703
Figure 1-3015	Remove two screws and one connector	1704
Figure 1-3016	Remove one screw and connector	1704
Figure 1-3017	Slide the cover	1705
Figure 1-3018	Remove the cover	1705
Figure 1-3019	Remove five screws	1706
Figure 1-3020	Release two tabs	1706
Figure 1-3021	Remove the top rear cover	1707
Figure 1-3022	Remove one screw	1707
Figure 1-3023	Release the cover	1708
Figure 1-3024	Remove the cover	1708
Figure 1-3025	Remove three screws	1709

Figure 1-3026	Remove one screw and release one tab	1709
Figure 1-3027	Release the cover	1710
Figure 1-3028	Remove the cover	1710
Figure 1-3029	Disconnect one connector	1711
Figure 1-3030	Remove the bracket	1711
Figure 1-3031	Remove the LVPS cover	1712
Figure 1-3032	Release wire harnesses and flat cable	1712
Figure 1-3033	Remove six screws	1713
Figure 1-3034	Release the formatter case	1713
Figure 1-3035	Remove the formatter case	1714
Figure 1-3036	Release the cover	1714
Figure 1-3037	Remove the cover	1715
Figure 1-3038	Remove two screws	1715
Figure 1-3039	Remove the plate	1716
Figure 1-3040	Disconnect five connectors and one flat cable	1716
Figure 1-3041	Remove one screw	1717
Figure 1-3042	Release the HVPST	1717
Figure 1-3043	Remove the HVPST	1718
Figure 1-3044	Remove the motor	1718
Figure 1-3045	Recycle and unpack	1719
Figure 1-3046	Install the motor	1719
Figure 1-3047	Connect one ground wire	1720
Figure 1-3048	Install the HVPST	1720
Figure 1-3049	Install one screw	1721
Figure 1-3050	Connect five connectors and one flat cable	1721
Figure 1-3051	Install the plate	1722
Figure 1-3052	Install two screws	1722
Figure 1-3053	Install the cover	1723
Figure 1-3054	Install one screw	1723
Figure 1-3055	Pass the wire harnesses through the opening	1724
Figure 1-3056	Install the formatter case	1724
Figure 1-3057	Install six screws	1725
Figure 1-3058	Install wire harnesses and flat cable	1725
Figure 1-3059	Install the LVPS cover	1726
Figure 1-3060	Attach the flat cable	1726
Figure 1-3061	Position the bracket	1727
Figure 1-3062	Connect one connector	1727
Figure 1-3063	Install the cover	1728
Figure 1-3064	Engage one tab	1728
Figure 1-3065	Engage one tab and install one screw	1729
Figure 1-3066	Install three screws	1729

Figure 1-3067	Install the cover	1730
Figure 1-3068	Engage the cover	1730
Figure 1-3069	Install one screw	1731
Figure 1-3070	Align the locator tabs	1731
Figure 1-3071	Install the cover	1732
Figure 1-3072	Install five screws	1732
Figure 1-3073	Install the cables	1733
Figure 1-3074	Position the hooks	1733
Figure 1-3075	Install the cover	1734
Figure 1-3076	Install one screw and connector	1734
Figure 1-3077	Install one screw and connector	1735
Figure 1-3078	Locate the ISA mounting pins and slots	250
Figure 1-3079	Install the ISA	1736
Figure 1-3080	Slide the ISA towards the front of the printer	1736
Figure 1-3081	Install one screw	1737
Figure 1-3082	Install two screws	1737
Figure 1-3083	Install one screw	1738
Figure 1-3084	Connect connectors	1738
Figure 1-3085	Install two tabs	1739
Figure 1-3086	Install the cover assembly	1739
Figure 1-3087	Install one screw	1740
Figure 1-3088	Install the cover	1741
Figure 1-3089	Press the cover	1741
Figure 1-3090	Install one screw	1742
Figure 1-3091	Position the tab	1742
Figure 1-3092	Slide the cover	1743
Figure 1-3093	Check the tab	1743
Figure 1-3094	Position the hooks	1744
Figure 1-3095	Install the cover	1744
Figure 1-3096	Install four screws cover	1745
Figure 1-3097	Align the cover	1745
Figure 1-3098	Rotate the top of the cover	1746
Figure 1-3099	Slide the cover	1746
Figure 1-3100	Install two screws	1747
Figure 1-3101	Install the cover	1747
Figure 1-3102	Install four screws cover	1748
Figure 1-3103	Install the formatter	1748
Figure 1-3104	Install four screws	1749
Figure 1-3105	Connect all connectors	1750
Figure 1-3106	Position the fax PCA	1750
Figure 1-3107	Install the fax PCA	1751

Figure 1-3108	Connect the connector	1751
Figure 1-3109	Install the holder	1752
Figure 1-3110	Release the HDD	1752
Figure 1-3111	Install the formatter	1753
Figure 1-3112	Connect all connectors	1754
Figure 1-3113	Install the cover	1755
Figure 1-3114	Verify that the toner collection hatch cover is closed	1755
Figure 1-3115	Install the TCU	1756
Figure 1-3116	Close the front door	1756
Figure 1-3117	Install the tray	1757
Figure 1-3118	Close the tray	1757
Figure 1-3119	Place the control panel on the product	1758
Figure 1-3120	Connect two connectors	1758
Figure 1-3121	Turn the control panel over	1759
Figure 1-3122	Rotate the control-panel base down	1759
Figure 1-3123	Install two screws	1760
Figure 1-3124	Install the cover	1760
Figure 1-3125	Install the cover	1761
Figure 1-3126	Check the installation	1761
Figure 1-3127	Locate the formatter cover	1763
Figure 1-3128	Loosen the thumbscrews	1764
Figure 1-3129	Remove four screws	1764
Figure 1-3130	Remove the cover	1765
Figure 1-3131	Remove two screws	1765
Figure 1-3132	Release the right edge	1766
Figure 1-3133	Slide the cover right	1766
Figure 1-3134	Remove the cover	1767
Figure 1-3135	Remove four screws	1767
Figure 1-3136	Remove the cover	1768
Figure 1-3137	Remove the LVPS cover	1768
Figure 1-3138	Disconnect one connector	1769
Figure 1-3139	Remove the sensor	1769
Figure 1-3140	Recycle and unpack	1770
Figure 1-3141	Install the sensor	1770
Figure 1-3142	Connect one connector	1771
Figure 1-3143	Install the LVPS cover	1771
Figure 1-3144	Position the hooks	1772
Figure 1-3145	Install the cover	1772
Figure 1-3146	Install four screws cover	1773
Figure 1-3147	Align the cover	1773
Figure 1-3148	Rotate the top of the cover	1774

Figure 1-3149	Slide the cover	1774
Figure 1-3150	Install two screws	1775
Figure 1-3151	Install the cover	1775
Figure 1-3152	Install four screws cover	1776
Figure 1-3153	Install the cover	1776
Figure 1-3154	Locate the USB cover	1780
Figure 1-3155	Remove the cover	1780
Figure 1-3156	Open the right door	1781
Figure 1-3157	Release the fuser	1781
Figure 1-3158	Remove the fuser	1782
Figure 1-3159	Tilt the control panel up	1783
Figure 1-3160	Release the control-panel screws cover tabs	1783
Figure 1-3161	Remove the cover	1784
Figure 1-3162	Remove two screws	1784
Figure 1-3163	Rotate the control-panel base up	1785
Figure 1-3164	Turn the control panel over	1785
Figure 1-3165	Disconnect two connectors	1786
Figure 1-3166	Pull the tray out	1786
Figure 1-3167	Remove the tray	1787
Figure 1-3168	Open the front door	1787
Figure 1-3169	Open the TCU	1788
Figure 1-3170	Remove the TCU	1789
Figure 1-3171	Locate the formatter cover	1790
Figure 1-3172	Loosen the thumbscrews	1790
Figure 1-3173	Disconnect all connectors	1792
Figure 1-3174	Remove the formatter	1792
Figure 1-3175	Release the HDD	1793
Figure 1-3176	Remove the HDD	1793
Figure 1-3177	Locate the fax PCA	1794
Figure 1-3178	Disconnect one connector	1794
Figure 1-3179	Release one latch	1795
Figure 1-3180	Remove the fax PCA	1795
Figure 1-3181	Disconnect all connectors	1796
Figure 1-3182	Remove four screws	1797
Figure 1-3183	Remove the formatter	1797
Figure 1-3184	Remove four screws	1798
Figure 1-3185	Remove the cover	1798
Figure 1-3186	Remove two screws	1799
Figure 1-3187	Release the right edge	1799
Figure 1-3188	Slide the cover right	1800
Figure 1-3189	Remove the cover	1800

Figure 1-3190	Remove four screws	1801
Figure 1-3191	Remove the cover	1801
Figure 1-3192	Release one tab	1802
Figure 1-3193	Slide the cover back	1802
Figure 1-3194	Remove the left upper cover	1803
Figure 1-3195	Remove one screw	1803
Figure 1-3196	Release two tabs	1804
Figure 1-3197	Rotate the cover	1804
Figure 1-3198	Remove one screw	1805
Figure 1-3199	Release two tabs	1805
Figure 1-3200	Release the back edge of the cover	1806
Figure 1-3201	Remove the cover	1806
Figure 1-3202	Remove one screw	1807
Figure 1-3203	Remove two screws	1807
Figure 1-3204	Remove one screw	1808
Figure 1-3205	Disconnect connectors	1808
Figure 1-3206	Slide the ISA towards the back of the printer	1809
Figure 1-3207	Remove the ISA	1809
Figure 1-3208	Disconnect connector and remove screws	1810
Figure 1-3209	Remove the stapler unit	1810
Figure 1-3210	Remove two screws and one connector	1811
Figure 1-3211	Remove one screw and connector	1811
Figure 1-3212	Slide the cover	1812
Figure 1-3213	Remove the cover	1812
Figure 1-3214	Remove five screws	1813
Figure 1-3215	Release two tabs	1813
Figure 1-3216	Remove the top rear cover	1814
Figure 1-3217	Remove one screw	1814
Figure 1-3218	Remove the cover	1815
Figure 1-3219	Remove one screw	1815
Figure 1-3220	Remove one screw	1816
Figure 1-3221	Release one tab	1816
Figure 1-3222	Release two tabs	1817
Figure 1-3223	Remove three screws	1817
Figure 1-3224	Remove two screws	1818
Figure 1-3225	Remove the bracket	1818
Figure 1-3226	Remove one screw	1819
Figure 1-3227	Release the cover	1819
Figure 1-3228	Remove the cover	1820
Figure 1-3229	Remove three screws	1820
Figure 1-3230	Remove one screw and release one tab	1821

Figure 1-3231	Release the cover	1821
Figure 1-3232	Remove the cover	1822
Figure 1-3233	Disconnect one connector	1822
Figure 1-3234	Remove the bracket	1823
Figure 1-3235	Remove the LVPS cover	1823
Figure 1-3236	Release wire harnesses and flat cable	1824
Figure 1-3237	Remove six screws	1824
Figure 1-3238	Release the formatter case	1825
Figure 1-3239	Remove the formatter case	1825
Figure 1-3240	Release the cover	1826
Figure 1-3241	Remove the cover	1826
Figure 1-3242	Remove two screws	1827
Figure 1-3243	Remove the plate	1827
Figure 1-3244	Disconnect five connectors and one flat cable	1828
Figure 1-3245	Remove one screw	1828
Figure 1-3246	Release the HVPST	1829
Figure 1-3247	Remove the HVPST	1829
Figure 1-3248	Move the guide out of the way	1830
Figure 1-3249	Disconnect one connector	1830
Figure 1-3250	Remove one screw	1831
Figure 1-3251	Remove the guide	1831
Figure 1-3252	Remove three screws	1832
Figure 1-3253	Remove the assembly	1832
Figure 1-3254	Recycle and unpack	1833
Figure 1-3255	Check the gears on the assembly	1834
Figure 1-3256	Install three screws	1834
Figure 1-3257	Install the guide	1835
Figure 1-3258	Install one screw	1835
Figure 1-3259	Connect one connector	1836
Figure 1-3260	Install the guide	1836
Figure 1-3261	Connect one ground wire	1837
Figure 1-3262	Install the HVPST	1837
Figure 1-3263	Install one screw	1838
Figure 1-3264	Connect five connectors and one flat cable	1838
Figure 1-3265	Install the plate	1839
Figure 1-3266	Install two screws	1839
Figure 1-3267	Install the cover	1840
Figure 1-3268	Install one screw	1840
Figure 1-3269	Pass the wire harnesses through the opening	1841
Figure 1-3270	Install the formatter case	1841
Figure 1-3271	Install six screws	1842

Figure 1-3272	Install wire harnesses and flat cable	1842
Figure 1-3273	Install the LVPS cover	1843
Figure 1-3274	Attach the flat cable	1843
Figure 1-3275	Position the bracket	1844
Figure 1-3276	Connect one connector	1844
Figure 1-3277	Install the cover	1845
Figure 1-3278	Engage one tab	1845
Figure 1-3279	Engage one tab and install one screw	1846
Figure 1-3280	Install three screws	1846
Figure 1-3281	Install the cover	1847
Figure 1-3282	Engage the cover	1847
Figure 1-3283	Install one screw	1848
Figure 1-3284	Position the tabs in the slots	1848
Figure 1-3285	Install two screws	1849
Figure 1-3286	Install three screws	1849
Figure 1-3287	Position the locator pins	1850
Figure 1-3288	Press down on the cover	1850
Figure 1-3289	Install one screw	1851
Figure 1-3290	Install one screw	1851
Figure 1-3291	Install the cover	1852
Figure 1-3292	Install one screw	1852
Figure 1-3293	Align the locator tabs	1853
Figure 1-3294	Install the cover	1853
Figure 1-3295	Install five screws	1854
Figure 1-3296	Install the cables	1854
Figure 1-3297	Position the hooks	1855
Figure 1-3298	Install the cover	1855
Figure 1-3299	Install one screw and connector	1856
Figure 1-3300	Install one screw and connector	1856
Figure 1-3301	Position the hooks in the slots	1857
Figure 1-3302	Connect connector and install screws	1857
Figure 1-3303	Locate the ISA mounting pins and slots	250
Figure 1-3304	Install the ISA	1859
Figure 1-3305	Slide the ISA towards the front of the printer	1859
Figure 1-3306	Install one screw	1860
Figure 1-3307	Install two screws	1860
Figure 1-3308	Install one screw	1861
Figure 1-3309	Connect connectors	1861
Figure 1-3310	Install two tabs	1862
Figure 1-3311	Install the cover assembly	1862
Figure 1-3312	Install one screw	1863

Figure 1-3313	Install the cover	1864
Figure 1-3314	Press the cover	1864
Figure 1-3315	Install one screw	1865
Figure 1-3316	Position the tab	1865
Figure 1-3317	Slide the cover	1866
Figure 1-3318	Check the tab	1866
Figure 1-3319	Position the hooks	1867
Figure 1-3320	Install the cover	1867
Figure 1-3321	Install four screws cover	1868
Figure 1-3322	Align the cover	1868
Figure 1-3323	Rotate the top of the cover	1869
Figure 1-3324	Slide the cover	1869
Figure 1-3325	Install two screws	1870
Figure 1-3326	Install the cover	1870
Figure 1-3327	Install four screws cover	1871
Figure 1-3328	Install the formatter	1871
Figure 1-3329	Install four screws	1872
Figure 1-3330	Connect all connectors	1873
Figure 1-3331	Position the fax PCA	1873
Figure 1-3332	Install the fax PCA	1874
Figure 1-3333	Connect the connector	1874
Figure 1-3334	Install the holder	1875
Figure 1-3335	Release the HDD	1875
Figure 1-3336	Install the formatter	1876
Figure 1-3337	Connect all connectors	1877
Figure 1-3338	Install the cover	1878
Figure 1-3339	Verify that the toner collection hatch cover is closed	1878
Figure 1-3340	Install the TCU	1879
Figure 1-3341	Close the front door	1879
Figure 1-3342	Install the tray	1880
Figure 1-3343	Close the tray	1880
Figure 1-3344	Place the control panel on the product	1881
Figure 1-3345	Connect two connectors	1881
Figure 1-3346	Turn the control panel over	1882
Figure 1-3347	Rotate the control-panel base down	1882
Figure 1-3348	Install two screws	1883
Figure 1-3349	Install the cover	1883
Figure 1-3350	Align the fuser with the opening	1884
Figure 1-3351	Install the fuser	1884
Figure 1-3352	Close the right door	1885
Figure 1-3353	Install the cover	1885

Figure 1-3354	Check the installation	1886
Figure 1-3355	Open the right door	1890
Figure 1-3356	Release the fuser	1891
Figure 1-3357	Remove the fuser	1891
Figure 1-3358	Open the right door	1892
Figure 1-3359	Release the ITB drive coupling	1892
Figure 1-3360	Lower the secondary transfer roller assembly	1893
Figure 1-3361	Release the front-side ITB spring	1893
Figure 1-3362	Place the spring on the holder	1894
Figure 1-3363	Release the rear-side ITB spring	1894
Figure 1-3364	Place the spring on the holder	1895
Figure 1-3365	Grasp the ITB handles	1896
Figure 1-3366	Remove the ITB	1896
Figure 1-3367	Locate the USB cover	1897
Figure 1-3368	Remove the cover	1897
Figure 1-3369	Tilt the control panel up	1898
Figure 1-3370	Release the control-panel screws cover tabs	1898
Figure 1-3371	Remove the cover	1899
Figure 1-3372	Remove two screws	1899
Figure 1-3373	Rotate the control-panel base up	1900
Figure 1-3374	Turn the control panel over	1900
Figure 1-3375	Disconnect two connectors	1901
Figure 1-3376	Pull the tray out	1901
Figure 1-3377	Remove the tray	1902
Figure 1-3378	Open the front door	1902
Figure 1-3379	Open the TCU	1903
Figure 1-3380	Remove the TCU	1904
Figure 1-3381	Locate the formatter cover	1905
Figure 1-3382	Loosen the thumbscrews	1905
Figure 1-3383	Disconnect all connectors	1907
Figure 1-3384	Remove the formatter	1907
Figure 1-3385	Release the HDD	1908
Figure 1-3386	Remove the HDD	1908
Figure 1-3387	Locate the fax PCA	1909
Figure 1-3388	Disconnect one connector	1909
Figure 1-3389	Release one latch	1910
Figure 1-3390	Remove the fax PCA	1910
Figure 1-3391	Disconnect all connectors	1911
Figure 1-3392	Remove four screws	1912
Figure 1-3393	Remove the formatter	1912
Figure 1-3394	Remove four screws	1913

Figure 1-3395	Remove the cover	1913
Figure 1-3396	Remove two screws	1914
Figure 1-3397	Release the right edge	1914
Figure 1-3398	Slide the cover right	1915
Figure 1-3399	Remove the cover	1915
Figure 1-3400	Remove four screws	1916
Figure 1-3401	Remove the cover	1916
Figure 1-3402	Release one tab	1917
Figure 1-3403	Slide the cover back	1917
Figure 1-3404	Remove the left upper cover	1918
Figure 1-3405	Remove one screw	1918
Figure 1-3406	Release two tabs	1919
Figure 1-3407	Rotate the cover	1919
Figure 1-3408	Remove one screw	1920
Figure 1-3409	Release two tabs	1920
Figure 1-3410	Release the back edge of the cover	1921
Figure 1-3411	Remove the cover	1921
Figure 1-3412	Remove one screw	1922
Figure 1-3413	Remove two screws	1922
Figure 1-3414	Remove one screw	1923
Figure 1-3415	Disconnect connectors	1923
Figure 1-3416	Slide the ISA towards the back of the printer	1924
Figure 1-3417	Remove the ISA	1924
Figure 1-3418	Disconnect connector and remove screws	1925
Figure 1-3419	Remove the stapler unit	1925
Figure 1-3420	Remove two screws and one connector	1926
Figure 1-3421	Remove one screw and connector	1926
Figure 1-3422	Slide the cover	1927
Figure 1-3423	Remove the cover	1927
Figure 1-3424	Remove five screws	1928
Figure 1-3425	Release two tabs	1928
Figure 1-3426	Remove the top rear cover	1929
Figure 1-3427	Remove one screw	1929
Figure 1-3428	Remove the cover	1930
Figure 1-3429	Remove one screw	1930
Figure 1-3430	Remove one screw	1931
Figure 1-3431	Release one tab	1931
Figure 1-3432	Release two tabs	1932
Figure 1-3433	Remove three screws	1932
Figure 1-3434	Remove two screws	1933
Figure 1-3435	Remove the bracket	1933

Figure 1-3436	Remove one screw	1934
Figure 1-3437	Release the cover	1934
Figure 1-3438	Remove the cover	1935
Figure 1-3439	Remove three screws	1935
Figure 1-3440	Remove one screw and release one tab	1936
Figure 1-3441	Release the cover	1936
Figure 1-3442	Remove the cover	1937
Figure 1-3443	Remove one screw	1937
Figure 1-3444	Remove the PCA holder	1938
Figure 1-3445	Remove one cable	1938
Figure 1-3446	Remove four screws	1939
Figure 1-3447	Remove the control panel	1939
Figure 1-3448	Release the cover	1940
Figure 1-3449	Remove the cover	1940
Figure 1-3450	Disconnect one connector	1941
Figure 1-3451	Remove the bracket	1941
Figure 1-3452	Remove the LVPS cover	1942
Figure 1-3453	Release wire harnesses and flat cable	1942
Figure 1-3454	Remove six screws	1943
Figure 1-3455	Release the formatter case	1943
Figure 1-3456	Remove the formatter case	1944
Figure 1-3457	Release the cover	1944
Figure 1-3458	Remove the cover	1945
Figure 1-3459	Remove two screws	1945
Figure 1-3460	Remove the plate	1946
Figure 1-3461	Disconnect five connectors and one flat cable	1946
Figure 1-3462	Remove one screw	1947
Figure 1-3463	Release the HVPST	1947
Figure 1-3464	Remove the HVPST	1948
Figure 1-3465	Move the guide out of the way	1948
Figure 1-3466	Disconnect one connector	1949
Figure 1-3467	Remove one screw	1949
Figure 1-3468	Remove the guide	1950
Figure 1-3469	Remove three screws	1950
Figure 1-3470	Remove the assembly	1951
Figure 1-3471	Remove two screws	1951
Figure 1-3472	Remove the PCA	1952
Figure 1-3473	Release two retainers and disconnect one connector	1952
Figure 1-3474	Remove four screws	1953
Figure 1-3475	Remove the assembly	1954
Figure 1-3476	Remove two screws	1955

Figure 1-3477	Remove the duplex drive assembly	1955
Figure 1-3478	Recycle and unpack	1956
Figure 1-3479	Install the duplex drive assembly	1956
Figure 1-3480	Install two screws	1957
Figure 1-3481	Install the assembly	1957
Figure 1-3482	Install four screws	1958
Figure 1-3483	Connect one connector	1958
Figure 1-3484	Install the PCA holder	1959
Figure 1-3485	Install one screw	1959
Figure 1-3486	Connect one connector	1960
Figure 1-3487	Install two screws	1960
Figure 1-3488	Check the gears on the assembly	1961
Figure 1-3489	Install three screws	1961
Figure 1-3490	Install the guide	1962
Figure 1-3491	Install one screw	1962
Figure 1-3492	Connect one connector	1963
Figure 1-3493	Install the guide	1963
Figure 1-3494	Connect one ground wire	1964
Figure 1-3495	Install the HVPST	1964
Figure 1-3496	Install one screw	1965
Figure 1-3497	Connect five connectors and one flat cable	1965
Figure 1-3498	Install the plate	1966
Figure 1-3499	Install two screws	1966
Figure 1-3500	Install the cover	1967
Figure 1-3501	Install one screw	1967
Figure 1-3502	Pass the wire harnesses through the opening	1968
Figure 1-3503	Install the formatter case	1968
Figure 1-3504	Install six screws	1969
Figure 1-3505	Install wire harnesses and flat cable	1969
Figure 1-3506	Install the LVPS cover	1970
Figure 1-3507	Attach the flat cable	1970
Figure 1-3508	Position the bracket	1971
Figure 1-3509	Connect one connector	1971
Figure 1-3510	Install the cover	1972
Figure 1-3511	Align the tabs	1972
Figure 1-3512	Release the cover	1973
Figure 1-3513	Verify the installation	1973
Figure 1-3514	Connect one connector	1974
Figure 1-3515	Install four screws	1974
Figure 1-3516	Place one cable in the guide	1975
Figure 1-3517	Install the tab	1975

Figure 1-3518	Install one screw	1976
Figure 1-3519	Install the cover	1976
Figure 1-3520	Engage one tab	1977
Figure 1-3521	Engage one tab and install one screw	1977
Figure 1-3522	Install three screws	1978
Figure 1-3523	Install the cover	1978
Figure 1-3524	Engage the cover	1979
Figure 1-3525	Install one screw	1979
Figure 1-3526	Position the tabs in the slots	1980
Figure 1-3527	Install two screws	1980
Figure 1-3528	Install three screws	1981
Figure 1-3529	Position the locator pins	1981
Figure 1-3530	Press down on the cover	1982
Figure 1-3531	Install one screw	1982
Figure 1-3532	Install one screw	1983
Figure 1-3533	Install the cover	1983
Figure 1-3534	Install one screw	1984
Figure 1-3535	Align the locator tabs	1984
Figure 1-3536	Install the cover	1985
Figure 1-3537	Install five screws	1985
Figure 1-3538	Install the cables	1986
Figure 1-3539	Position the hooks	1986
Figure 1-3540	Install the cover	1987
Figure 1-3541	Install one screw and connector	1987
Figure 1-3542	Install one screw and connector	1988
Figure 1-3543	Position the hooks in the slots	1988
Figure 1-3544	Connect connector and install screws	1989
Figure 1-3545	Locate the ISA mounting pins and slots	250
Figure 1-3546	Install the ISA	1990
Figure 1-3547	Slide the ISA towards the front of the printer	1990
Figure 1-3548	Install one screw	1991
Figure 1-3549	Install two screws	1991
Figure 1-3550	Install one screw	1992
Figure 1-3551	Connect connectors	1992
Figure 1-3552	Install two tabs	1993
Figure 1-3553	Install the cover assembly	1993
Figure 1-3554	Install one screw	1994
Figure 1-3555	Install the cover	1995
Figure 1-3556	Press the cover	1995
Figure 1-3557	Install one screw	1996
Figure 1-3558	Position the tab	1996

Figure 1-3559	Slide the cover	1997
Figure 1-3560	Check the tab	1997
Figure 1-3561	Position the hooks	1998
Figure 1-3562	Install the cover	1998
Figure 1-3563	Install four screws cover	1999
Figure 1-3564	Align the cover	1999
Figure 1-3565	Rotate the top of the cover	2000
Figure 1-3566	Slide the cover	2000
Figure 1-3567	Install two screws	2001
Figure 1-3568	Install the cover	2001
Figure 1-3569	Install four screws cover	2002
Figure 1-3570	Install the formatter	2002
Figure 1-3571	Install four screws	2003
Figure 1-3572	Connect all connectors	2004
Figure 1-3573	Position the fax PCA	2004
Figure 1-3574	Install the fax PCA	2005
Figure 1-3575	Connect the connector	2005
Figure 1-3576	Install the holder	2006
Figure 1-3577	Release the HDD	2006
Figure 1-3578	Install the formatter	2007
Figure 1-3579	Connect all connectors	2008
Figure 1-3580	Install the cover	2009
Figure 1-3581	Verify that the toner collection hatch cover is closed	2009
Figure 1-3582	Install the TCU	2010
Figure 1-3583	Close the front door	2010
Figure 1-3584	Install the tray	2011
Figure 1-3585	Close the tray	2011
Figure 1-3586	Place the control panel on the product	2012
Figure 1-3587	Connect two connectors	2012
Figure 1-3588	Turn the control panel over	2013
Figure 1-3589	Rotate the control-panel base down	2013
Figure 1-3590	Install two screws	2014
Figure 1-3591	Install the cover	2014
Figure 1-3592	Install the cover	2015
Figure 1-3593	Check the installation	2015
Figure 1-3594	Handle the ITB by the edges	2016
Figure 1-3595	Align the ITB with the slots in the product	2016
Figure 1-3596	Install the ITB	2017
Figure 1-3597	Remove the spring from the holder	2017
Figure 1-3598	Fasten the rear-side ITB spring	2018
Figure 1-3599	Remove the spring from the holder	2018

Figure 1-3600	Fasten the front-side ITB spring	2019
Figure 1-3601	Engage the ITB drive coupling	2019
Figure 1-3602	Close the right door	2020
Figure 1-3603	Align the fuser with the opening	2020
Figure 1-3604	Install the fuser	2021
Figure 1-3605	Close the right door	2021
Figure 1-3606	Open the front door	2024
Figure 1-3607	Open the TCU	2025
Figure 1-3608	Remove the TCU	2026
Figure 1-3609	Locate the formatter cover	2027
Figure 1-3610	Loosen the thumbscrews	2027
Figure 1-3611	Locate the USB cover	2028
Figure 1-3612	Remove the cover	2028
Figure 1-3613	Tilt the control panel up	2029
Figure 1-3614	Release the control-panel screws cover tabs	2029
Figure 1-3615	Remove the cover	2030
Figure 1-3616	Remove two screws	2030
Figure 1-3617	Rotate the control-panel base up	2031
Figure 1-3618	Turn the control panel over	2031
Figure 1-3619	Disconnect two connectors	2032
Figure 1-3620	Disconnect all connectors	2033
Figure 1-3621	Remove the formatter	2033
Figure 1-3622	Release the HDD	2034
Figure 1-3623	Remove the HDD	2034
Figure 1-3624	Locate the fax PCA	2035
Figure 1-3625	Disconnect one connector	2035
Figure 1-3626	Release one latch	2036
Figure 1-3627	Remove the fax PCA	2036
Figure 1-3628	Disconnect all connectors	2037
Figure 1-3629	Remove four screws	2038
Figure 1-3630	Remove the formatter	2038
Figure 1-3631	Remove four screws	2039
Figure 1-3632	Remove the cover	2039
Figure 1-3633	Remove two screws	2040
Figure 1-3634	Release the right edge	2040
Figure 1-3635	Slide the cover right	2041
Figure 1-3636	Remove the cover	2041
Figure 1-3637	Remove four screws	2042
Figure 1-3638	Remove the cover	2042
Figure 1-3639	Release one tab	2043
Figure 1-3640	Slide the cover back	2043

Figure 1-3641	Remove the left upper cover	2044
Figure 1-3642	Remove one screw	2044
Figure 1-3643	Release two tabs	2045
Figure 1-3644	Rotate the cover	2045
Figure 1-3645	Remove one screw	2046
Figure 1-3646	Release two tabs	2046
Figure 1-3647	Release the back edge of the cover	2047
Figure 1-3648	Remove the cover	2047
Figure 1-3649	Remove one screw	2048
Figure 1-3650	Remove two screws	2048
Figure 1-3651	Remove one screw	2049
Figure 1-3652	Disconnect connectors	2049
Figure 1-3653	Slide the ISA towards the back of the printer	2050
Figure 1-3654	Remove the ISA	2050
Figure 1-3655	Remove two screws and one connector	2051
Figure 1-3656	Remove one screw and connector	2051
Figure 1-3657	Slide the cover	2052
Figure 1-3658	Remove the cover	2052
Figure 1-3659	Remove one screw	2053
Figure 1-3660	Release the cover	2053
Figure 1-3661	Remove the cover	2054
Figure 1-3662	Remove three screws	2054
Figure 1-3663	Remove one screw and release one tab	2055
Figure 1-3664	Release the cover	2055
Figure 1-3665	Remove the cover	2056
Figure 1-3666	Release the cover	2056
Figure 1-3667	Remove the cover	2057
Figure 1-3668	Disconnect one connector	2057
Figure 1-3669	Remove the bracket	2058
Figure 1-3670	Remove the LVPS cover	2058
Figure 1-3671	Release wire harnesses and flat cable	2059
Figure 1-3672	Remove six screws	2059
Figure 1-3673	Release the formatter case	2060
Figure 1-3674	Remove the formatter case	2060
Figure 1-3675	Disconnect one wire harness	2061
Figure 1-3676	Disconnect seven connectors	2061
Figure 1-3677	Pass the wire harnesses through the opening	2062
Figure 1-3678	Remove three screws	2062
Figure 1-3679	Remove the LVPS	2063
Figure 1-3680	Remove one screw	2063
Figure 1-3681	Release the wire harnesses	2064

Figure 1-3682	Remove the fan	2064
Figure 1-3683	Disconnect one flat cable	2065
Figure 1-3684	Remove three screws	2065
Figure 1-3685	Remove the HVPSD	2066
Figure 1-3686	Disconnect two connectors	2066
Figure 1-3687	Disconnect two flat cables	2067
Figure 1-3688	Remove the assembly	2067
Figure 1-3689	Remove two screws	2068
Figure 1-3690	Remove the plate	2068
Figure 1-3691	Move the guide out of the way	2069
Figure 1-3692	Remove three screws	2069
Figure 1-3693	Remove the assembly	2070
Figure 1-3694	Remove the gear if installed	2070
Figure 1-3695	Recycle and unpack	2071
Figure 1-3696	Check the gears for a gap	2072
Figure 1-3697	Adjust the gears	2072
Figure 1-3698	Install the assembly	2073
Figure 1-3699	Install three screws	2073
Figure 1-3700	Install the guide	2074
Figure 1-3701	Install the plate	2074
Figure 1-3702	Install two screws	2075
Figure 1-3703	Install the lifter drive	2075
Figure 1-3704	Connect two flat cables	2076
Figure 1-3705	Connect two connectors	2076
Figure 1-3706	Install the HVPSD	2077
Figure 1-3707	Press the tabs	2077
Figure 1-3708	Install three screws	2078
Figure 1-3709	Connect one flat cable	2078
Figure 1-3710	Install the fan	2079
Figure 1-3711	Place the wire harnesses in the retainer	2079
Figure 1-3712	Install one screw	2080
Figure 1-3713	Install the LVPS	2080
Figure 1-3714	Install three screws	2081
Figure 1-3715	Pass the wire harnesses through the opening	2081
Figure 1-3716	Connect seven connectors	2082
Figure 1-3717	Connect one wire harness	2082
Figure 1-3718	Pass the wire harnesses through the opening	2083
Figure 1-3719	Install the formatter case	2083
Figure 1-3720	Install six screws	2084
Figure 1-3721	Install wire harnesses and flat cable	2084
Figure 1-3722	Install the LVPS cover	2085

Figure 1-3723	Attach the flat cable	2085
Figure 1-3724	Position the bracket	2086
Figure 1-3725	Connect one connector	2086
Figure 1-3726	Install the cover	2087
Figure 1-3727	Install one screw	2087
Figure 1-3728	Install the cover	2088
Figure 1-3729	Engage one tab	2088
Figure 1-3730	Engage one tab and install one screw	2089
Figure 1-3731	Install three screws	2089
Figure 1-3732	Install the cover	2090
Figure 1-3733	Engage the cover	2090
Figure 1-3734	Install one screw	2091
Figure 1-3735	Install the cables	2091
Figure 1-3736	Position the hooks	2092
Figure 1-3737	Install the cover	2092
Figure 1-3738	Install one screw and connector	2093
Figure 1-3739	Install one screw and connector	2093
Figure 1-3740	Locate the ISA mounting pins and slots	250
Figure 1-3741	Install the ISA	2094
Figure 1-3742	Slide the ISA towards the front of the printer	2095
Figure 1-3743	Install one screw	2095
Figure 1-3744	Install two screws	2096
Figure 1-3745	Install one screw	2096
Figure 1-3746	Connect connectors	2097
Figure 1-3747	Install two tabs	2097
Figure 1-3748	Install the cover assembly	2098
Figure 1-3749	Install one screw	2098
Figure 1-3750	Install the cover	2099
Figure 1-3751	Press the cover	2099
Figure 1-3752	Install one screw	2100
Figure 1-3753	Position the tab	2100
Figure 1-3754	Slide the cover	2101
Figure 1-3755	Check the tab	2101
Figure 1-3756	Position the hooks	2102
Figure 1-3757	Install the cover	2102
Figure 1-3758	Install four screws cover	2103
Figure 1-3759	Align the cover	2103
Figure 1-3760	Rotate the top of the cover	2104
Figure 1-3761	Slide the cover	2104
Figure 1-3762	Install two screws	2105
Figure 1-3763	Install the cover	2105

Figure 1-3764	Install four screws cover	2106
Figure 1-3765	Install the formatter	2106
Figure 1-3766	Install four screws	2107
Figure 1-3767	Connect all connectors	2108
Figure 1-3768	Position the fax PCA	2108
Figure 1-3769	Install the fax PCA	2109
Figure 1-3770	Connect the connector	2109
Figure 1-3771	Install the holder	2110
Figure 1-3772	Release the HDD	2110
Figure 1-3773	Install the formatter	2111
Figure 1-3774	Connect all connectors	2112
Figure 1-3775	Place the control panel on the product	2113
Figure 1-3776	Connect two connectors	2113
Figure 1-3777	Turn the control panel over	2114
Figure 1-3778	Rotate the control-panel base down	2114
Figure 1-3779	Install two screws	2115
Figure 1-3780	Install the cover	2115
Figure 1-3781	Install the cover	2116
Figure 1-3782	Check the installation	2116
Figure 1-3783	Install the cover	2117
Figure 1-3784	Verify that the toner collection hatch cover is closed	2117
Figure 1-3785	Install the TCU	2118
Figure 1-3786	Close the front door	2118
Figure 1-3787	Open the right door	2122
Figure 1-3788	Release the secondary transfer roller assembly	2122
Figure 1-3789	Carefully flex the top portion of the blue arm	2123
Figure 1-3790	Disengage the blue arm and pin	2123
Figure 1-3791	Remove the secondary transfer roller assembly	2124
Figure 1-3792	Open the right door	2124
Figure 1-3793	Release the ITB drive coupling	2125
Figure 1-3794	Lower the secondary transfer roller assembly	2125
Figure 1-3795	Release the front-side ITB spring	2126
Figure 1-3796	Place the spring on the holder	2126
Figure 1-3797	Release the rear-side ITB spring	2127
Figure 1-3798	Place the spring on the holder	2127
Figure 1-3799	Grasp the ITB handles	2128
Figure 1-3800	Remove the ITB	2128
Figure 1-3801	Pull the tray out	2129
Figure 1-3802	Remove the tray	2129
Figure 1-3803	Open the front door	2130
Figure 1-3804	Open the TCU	2130

Figure 1-3805	Remove the TCU	2131
Figure 1-3806	Locate the formatter cover	2132
Figure 1-3807	Loosen the thumbscrews	2132
Figure 1-3808	Locate the USB cover	2133
Figure 1-3809	Remove the cover	2133
Figure 1-3810	Tilt the control panel up	2134
Figure 1-3811	Release the control-panel screws cover tabs	2134
Figure 1-3812	Remove the cover	2135
Figure 1-3813	Remove two screws	2135
Figure 1-3814	Rotate the control-panel base up	2136
Figure 1-3815	Turn the control panel over	2136
Figure 1-3816	Disconnect two connectors	2137
Figure 1-3817	Disconnect all connectors	2138
Figure 1-3818	Remove the formatter	2138
Figure 1-3819	Release the HDD	2139
Figure 1-3820	Remove the HDD	2139
Figure 1-3821	Locate the fax PCA	2140
Figure 1-3822	Disconnect one connector	2140
Figure 1-3823	Release one latch	2141
Figure 1-3824	Remove the fax PCA	2141
Figure 1-3825	Disconnect all connectors	2142
Figure 1-3826	Remove four screws	2143
Figure 1-3827	Remove the formatter	2143
Figure 1-3828	Remove four screws	2144
Figure 1-3829	Remove the cover	2144
Figure 1-3830	Remove two screws	2145
Figure 1-3831	Release the right edge	2145
Figure 1-3832	Slide the cover right	2146
Figure 1-3833	Remove the cover	2146
Figure 1-3834	Remove four screws	2147
Figure 1-3835	Remove the cover	2147
Figure 1-3836	Release one tab	2148
Figure 1-3837	Slide the cover back	2148
Figure 1-3838	Remove the left upper cover	2149
Figure 1-3839	Remove one screw	2149
Figure 1-3840	Release two tabs	2150
Figure 1-3841	Rotate the cover	2150
Figure 1-3842	Remove one screw	2151
Figure 1-3843	Release two tabs	2151
Figure 1-3844	Release the back edge of the cover	2152
Figure 1-3845	Remove the cover	2152

Figure 1-3846	Remove one screw	2153
Figure 1-3847	Remove two screws	2153
Figure 1-3848	Remove one screw	2154
Figure 1-3849	Disconnect connectors	2154
Figure 1-3850	Slide the ISA towards the back of the printer	2155
Figure 1-3851	Remove the ISA	2155
Figure 1-3852	Remove two screws and one connector	2156
Figure 1-3853	Remove one screw and connector	2156
Figure 1-3854	Slide the cover	2157
Figure 1-3855	Remove the cover	2157
Figure 1-3856	Remove one screw	2158
Figure 1-3857	Release the cover	2158
Figure 1-3858	Remove the cover	2159
Figure 1-3859	Remove three screws	2159
Figure 1-3860	Remove one screw and release one tab	2160
Figure 1-3861	Release the cover	2160
Figure 1-3862	Remove the cover	2161
Figure 1-3863	Release the cover	2161
Figure 1-3864	Remove the cover	2162
Figure 1-3865	Disconnect one connector	2162
Figure 1-3866	Remove the bracket	2163
Figure 1-3867	Remove the LVPS cover	2163
Figure 1-3868	Release wire harnesses and flat cable	2164
Figure 1-3869	Remove six screws	2164
Figure 1-3870	Release the formatter case	2165
Figure 1-3871	Remove the formatter case	2165
Figure 1-3872	Disconnect one wire harness	2166
Figure 1-3873	Disconnect seven connectors	2166
Figure 1-3874	Pass the wire harnesses through the opening	2167
Figure 1-3875	Remove three screws	2167
Figure 1-3876	Remove the LVPS	2168
Figure 1-3877	Remove one screw	2168
Figure 1-3878	Release the wire harnesses	2169
Figure 1-3879	Remove the fan	2169
Figure 1-3880	Disconnect one flat cable	2170
Figure 1-3881	Remove three screws	2170
Figure 1-3882	Remove the HVPSD	2171
Figure 1-3883	Disconnect two connectors	2171
Figure 1-3884	Disconnect two flat cables	2172
Figure 1-3885	Remove the assembly	2172
Figure 1-3886	Remove two screws	2173

Figure 1-3887	Remove the plate	2173
Figure 1-3888	Move the guide out of the way	2174
Figure 1-3889	Remove three screws	2174
Figure 1-3890	Remove the assembly	2175
Figure 1-3891	Remove the gear if installed	2175
Figure 1-3892	Release one tab	2176
Figure 1-3893	Remove the cover	2176
Figure 1-3894	Release the guide	2177
Figure 1-3895	Move the guide out of the way	2177
Figure 1-3896	Remove three screws	2178
Figure 1-3897	Locate the sheet metal portion of the assembly	2178
Figure 1-3898	Take note of the sheet-metal tabs	2179
Figure 1-3899	Rotate the top of the assembly away from the chassis	2179
Figure 1-3900	Release the bottom tabs	2180
Figure 1-3901	Remove the assembly	2180
Figure 1-3902	Recycle and unpack	2181
Figure 1-3903	Connect three connectors	2181
Figure 1-3904	Align the tabs on the assembly with the slots	2182
Figure 1-3905	Install the bottom tabs	2182
Figure 1-3906	Install the top tabs	2183
Figure 1-3907	Install three screws	2183
Figure 1-3908	Position the guide on the product	2184
Figure 1-3909	Install the guide	2184
Figure 1-3910	Position the cover on the product	2185
Figure 1-3911	Install the cover	2185
Figure 1-3912	Check the gears for a gap	2186
Figure 1-3913	Adjust the gears	2186
Figure 1-3914	Install the assembly	2187
Figure 1-3915	Install three screws	2187
Figure 1-3916	Install the guide	2188
Figure 1-3917	Install the plate	2188
Figure 1-3918	Install two screws	2189
Figure 1-3919	Install the lifter drive	2189
Figure 1-3920	Connect two flat cables	2190
Figure 1-3921	Connect two connectors	2190
Figure 1-3922	Install the HVPSD	2191
Figure 1-3923	Press the tabs	2191
Figure 1-3924	Install three screws	2192
Figure 1-3925	Connect one flat cable	2192
Figure 1-3926	Install the fan	2193
Figure 1-3927	Place the wire harnesses in the retainer	2193

Figure 1-3928	Install one screw	2194
Figure 1-3929	Install the LVPS	2194
Figure 1-3930	Install three screws	2195
Figure 1-3931	Pass the wire harnesses through the opening	2195
Figure 1-3932	Connect seven connectors	2196
Figure 1-3933	Connect one wire harness	2196
Figure 1-3934	Pass the wire harnesses through the opening	2197
Figure 1-3935	Install the formatter case	2197
Figure 1-3936	Install six screws	2198
Figure 1-3937	Install wire harnesses and flat cable	2198
Figure 1-3938	Install the LVPS cover	2199
Figure 1-3939	Attach the flat cable	2199
Figure 1-3940	Position the bracket	2200
Figure 1-3941	Connect one connector	2200
Figure 1-3942	Install the cover	2201
Figure 1-3943	Install one screw	2201
Figure 1-3944	Install the cover	2202
Figure 1-3945	Engage one tab	2202
Figure 1-3946	Engage one tab and install one screw	2203
Figure 1-3947	Install three screws	2203
Figure 1-3948	Install the cover	2204
Figure 1-3949	Engage the cover	2204
Figure 1-3950	Install one screw	2205
Figure 1-3951	Install the cables	2205
Figure 1-3952	Position the hooks	2206
Figure 1-3953	Install the cover	2206
Figure 1-3954	Install one screw and connector	2207
Figure 1-3955	Install one screw and connector	2207
Figure 1-3956	Locate the ISA mounting pins and slots	250
Figure 1-3957	Install the ISA	2208
Figure 1-3958	Slide the ISA towards the front of the printer	2209
Figure 1-3959	Install one screw	2209
Figure 1-3960	Install two screws	2210
Figure 1-3961	Install one screw	2210
Figure 1-3962	Connect connectors	2211
Figure 1-3963	Install two tabs	2211
Figure 1-3964	Install the cover assembly	2212
Figure 1-3965	Install one screw	2212
Figure 1-3966	Install the cover	2213
Figure 1-3967	Press the cover	2213
Figure 1-3968	Install one screw	2214

Figure 1-3969	Position the tab	2214
Figure 1-3970	Slide the cover	2215
Figure 1-3971	Check the tab	2215
Figure 1-3972	Position the hooks	2216
Figure 1-3973	Install the cover	2216
Figure 1-3974	Install four screws cover	2217
Figure 1-3975	Align the cover	2217
Figure 1-3976	Rotate the top of the cover	2218
Figure 1-3977	Slide the cover	2218
Figure 1-3978	Install two screws	2219
Figure 1-3979	Install the cover	2219
Figure 1-3980	Install four screws cover	2220
Figure 1-3981	Install the formatter	2220
Figure 1-3982	Install four screws	2221
Figure 1-3983	Connect all connectors	2222
Figure 1-3984	Position the fax PCA	2222
Figure 1-3985	Install the fax PCA	2223
Figure 1-3986	Connect the connector	2223
Figure 1-3987	Install the holder	2224
Figure 1-3988	Release the HDD	2224
Figure 1-3989	Install the formatter	2225
Figure 1-3990	Connect all connectors	2226
Figure 1-3991	Place the control panel on the product	2227
Figure 1-3992	Connect two connectors	2227
Figure 1-3993	Turn the control panel over	2228
Figure 1-3994	Rotate the control-panel base down	2228
Figure 1-3995	Install two screws	2229
Figure 1-3996	Install the cover	2229
Figure 1-3997	Install the cover	2230
Figure 1-3998	Check the installation	2230
Figure 1-3999	Install the cover	2231
Figure 1-4000	Verify that the toner collection hatch cover is closed	2231
Figure 1-4001	Install the TCU	2232
Figure 1-4002	Close the front door	2232
Figure 1-4003	Install the tray	2233
Figure 1-4004	Close the tray	2233
Figure 1-4005	Handle the ITB by the edges	2234
Figure 1-4006	Align the ITB with the slots in the product	2234
Figure 1-4007	Install the ITB	2235
Figure 1-4008	Remove the spring from the holder	2235
Figure 1-4009	Fasten the rear-side ITB spring	2236

Figure 1-4010	Remove the spring from the holder	2236
Figure 1-4011	Fasten the front-side ITB spring	2237
Figure 1-4012	Engage the ITB drive coupling	2237
Figure 1-4013	Close the right door	2238
Figure 1-4014	Install the right hinge	2238
Figure 1-4015	Install the left hinge	2239
Figure 1-4016	Engage the blue arm with the pin	2239
Figure 1-4017	Close the right door	2240
Figure 1-4018	Open the right door	2244
Figure 1-4019	Release the secondary transfer roller assembly	2244
Figure 1-4020	Carefully flex the top portion of the blue arm	2245
Figure 1-4021	Disengage the blue arm and pin	2245
Figure 1-4022	Remove the secondary transfer roller assembly	2246
Figure 1-4023	Open the right door	2246
Figure 1-4024	Release the ITB drive coupling	2247
Figure 1-4025	Lower the secondary transfer roller assembly	2247
Figure 1-4026	Release the front-side ITB spring	2248
Figure 1-4027	Place the spring on the holder	2248
Figure 1-4028	Release the rear-side ITB spring	2249
Figure 1-4029	Place the spring on the holder	2249
Figure 1-4030	Grasp the ITB handles	2250
Figure 1-4031	Remove the ITB	2250
Figure 1-4032	Pull the tray out	2251
Figure 1-4033	Remove the tray	2251
Figure 1-4034	Open the front door	2252
Figure 1-4035	Open the TCU	2252
Figure 1-4036	Remove the TCU	2253
Figure 1-4037	Locate the formatter cover	2254
Figure 1-4038	Loosen the thumbscrews	2254
Figure 1-4039	Locate the USB cover	2255
Figure 1-4040	Remove the cover	2255
Figure 1-4041	Tilt the control panel up	2256
Figure 1-4042	Release the control-panel screws cover tabs	2256
Figure 1-4043	Remove the cover	2257
Figure 1-4044	Remove two screws	2257
Figure 1-4045	Rotate the control-panel base up	2258
Figure 1-4046	Turn the control panel over	2258
Figure 1-4047	Disconnect two connectors	2259
Figure 1-4048	Disconnect all connectors	2260
Figure 1-4049	Remove the formatter	2260
Figure 1-4050	Release the HDD	2261

Figure 1-4051	Remove the HDD	2261
Figure 1-4052	Locate the fax PCA	2262
Figure 1-4053	Disconnect one connector	2262
Figure 1-4054	Release one latch	2263
Figure 1-4055	Remove the fax PCA	2263
Figure 1-4056	Disconnect all connectors	2264
Figure 1-4057	Remove four screws	2265
Figure 1-4058	Remove the formatter	2265
Figure 1-4059	Remove four screws	2266
Figure 1-4060	Remove the cover	2266
Figure 1-4061	Remove two screws	2267
Figure 1-4062	Release the right edge	2267
Figure 1-4063	Slide the cover right	2268
Figure 1-4064	Remove the cover	2268
Figure 1-4065	Remove four screws	2269
Figure 1-4066	Remove the cover	2269
Figure 1-4067	Release one tab	2270
Figure 1-4068	Slide the cover back	2270
Figure 1-4069	Remove the left upper cover	2271
Figure 1-4070	Remove one screw	2271
Figure 1-4071	Release two tabs	2272
Figure 1-4072	Rotate the cover	2272
Figure 1-4073	Remove one screw	2273
Figure 1-4074	Release two tabs	2273
Figure 1-4075	Release the back edge of the cover	2274
Figure 1-4076	Remove the cover	2274
Figure 1-4077	Remove one screw	2275
Figure 1-4078	Remove two screws	2275
Figure 1-4079	Remove one screw	2276
Figure 1-4080	Disconnect connectors	2276
Figure 1-4081	Slide the ISA towards the back of the printer	2277
Figure 1-4082	Remove the ISA	2277
Figure 1-4083	Remove two screws and one connector	2278
Figure 1-4084	Remove one screw and connector	2278
Figure 1-4085	Slide the cover	2279
Figure 1-4086	Remove the cover	2279
Figure 1-4087	Remove one screw	2280
Figure 1-4088	Release the cover	2280
Figure 1-4089	Remove the cover	2281
Figure 1-4090	Remove three screws	2281
Figure 1-4091	Remove one screw and release one tab	2282

Figure 1-4092	Release the cover	2282
Figure 1-4093	Remove the cover	2283
Figure 1-4094	Release the cover	2283
Figure 1-4095	Remove the cover	2284
Figure 1-4096	Disconnect one connector	2284
Figure 1-4097	Remove the bracket	2285
Figure 1-4098	Remove the LVPS cover	2285
Figure 1-4099	Release wire harnesses and flat cable	2286
Figure 1-4100	Remove six screws	2286
Figure 1-4101	Release the formatter case	2287
Figure 1-4102	Remove the formatter case	2287
Figure 1-4103	Disconnect one wire harness	2288
Figure 1-4104	Disconnect seven connectors	2288
Figure 1-4105	Pass the wire harnesses through the opening	2289
Figure 1-4106	Remove three screws	2289
Figure 1-4107	Remove the LVPS	2290
Figure 1-4108	Remove one screw	2290
Figure 1-4109	Release the wire harnesses	2291
Figure 1-4110	Remove the fan	2291
Figure 1-4111	Disconnect one flat cable	2292
Figure 1-4112	Remove three screws	2292
Figure 1-4113	Remove the HVPSD	2293
Figure 1-4114	Disconnect two connectors	2293
Figure 1-4115	Disconnect two flat cables	2294
Figure 1-4116	Remove the assembly	2294
Figure 1-4117	Remove two screws	2295
Figure 1-4118	Remove the plate	2295
Figure 1-4119	Move the guide out of the way	2296
Figure 1-4120	Remove three screws	2296
Figure 1-4121	Remove the assembly	2297
Figure 1-4122	Remove the gear if installed	2297
Figure 1-4123	Release one tab	2298
Figure 1-4124	Remove the cover	2298
Figure 1-4125	Release the guide	2299
Figure 1-4126	Move the guide out of the way	2299
Figure 1-4127	Remove three screws	2300
Figure 1-4128	Locate the sheet metal portion of the assembly	2300
Figure 1-4129	Take note of the sheet-metal tabs	2301
Figure 1-4130	Rotate the top of the assembly away from the chassis	2301
Figure 1-4131	Release the bottom tabs	2302
Figure 1-4132	Remove the assembly	2302

Figure 1-4133	Remove three screws	2303
Figure 1-4134	Release the left end of the assembly	2303
Figure 1-4135	Slide the assembly to the left	2304
Figure 1-4136	Remove the assembly	2304
Figure 1-4137	Disconnect one connector	2305
Figure 1-4138	Remove the tray pickup roller assembly	2305
Figure 1-4139	Locate the feed bushing	2306
Figure 1-4140	Release one tab and rotate the bushing	2306
Figure 1-4141	Remove the bushing	2307
Figure 1-4142	Slide the shaft out	2307
Figure 1-4143	Remove the gear	2308
Figure 1-4144	Recycle and unpack	2308
Figure 1-4145	Remove the tray pickup roller assembly	2309
Figure 1-4146	Locate the feed bushing	2309
Figure 1-4147	Release one tab and rotate the bushing	2310
Figure 1-4148	Remove the bushing	2310
Figure 1-4149	Slide the shaft out	2311
Figure 1-4150	Position the gear	2311
Figure 1-4151	Install the gear	2312
Figure 1-4152	Install the shaft	2312
Figure 1-4153	Check shaft alignment	2313
Figure 1-4154	Position the feed bushing	2313
Figure 1-4155	Install the feed bushing	2314
Figure 1-4156	Check shaft alignment	2314
Figure 1-4157	Position the roller assembly	2315
Figure 1-4158	Install the roller assembly	2315
Figure 1-4159	Release the spring loaded shaft	2316
Figure 1-4160	Remove three screws	2316
Figure 1-4161	Connect one connector	2317
Figure 1-4162	Position the assembly in the product	2317
Figure 1-4163	Slide the assembly to the right	2318
Figure 1-4164	Install the assembly	2318
Figure 1-4165	Install three screws	2319
Figure 1-4166	Connect three connectors	2319
Figure 1-4167	Align the tabs on the assembly with the slots	2320
Figure 1-4168	Install the bottom tabs	2320
Figure 1-4169	Install the top tabs	2321
Figure 1-4170	Install three screws	2321
Figure 1-4171	Position the guide on the product	2322
Figure 1-4172	Install the guide	2322
Figure 1-4173	Position the cover on the product	2323

Figure 1-4174	Install the cover	2323
Figure 1-4175	Check the gears for a gap	2324
Figure 1-4176	Adjust the gears	2324
Figure 1-4177	Install the assembly	2325
Figure 1-4178	Install three screws	2325
Figure 1-4179	Install the guide	2326
Figure 1-4180	Install the plate	2326
Figure 1-4181	Install two screws	2327
Figure 1-4182	Install the lifter drive	2327
Figure 1-4183	Connect two flat cables	2328
Figure 1-4184	Connect two connectors	2328
Figure 1-4185	Install the HVPSD	2329
Figure 1-4186	Press the tabs	2329
Figure 1-4187	Install three screws	2330
Figure 1-4188	Connect one flat cable	2330
Figure 1-4189	Install the fan	2331
Figure 1-4190	Place the wire harnesses in the retainer	2331
Figure 1-4191	Install one screw	2332
Figure 1-4192	Install the LVPS	2332
Figure 1-4193	Install three screws	2333
Figure 1-4194	Pass the wire harnesses through the opening	2333
Figure 1-4195	Connect seven connectors	2334
Figure 1-4196	Connect one wire harness	2334
Figure 1-4197	Pass the wire harnesses through the opening	2335
Figure 1-4198	Install the formatter case	2335
Figure 1-4199	Install six screws	2336
Figure 1-4200	Install wire harnesses and flat cable	2336
Figure 1-4201	Install the LVPS cover	2337
Figure 1-4202	Attach the flat cable	2337
Figure 1-4203	Position the bracket	2338
Figure 1-4204	Connect one connector	2338
Figure 1-4205	Install the cover	2339
Figure 1-4206	Install one screw	2339
Figure 1-4207	Install the cover	2340
Figure 1-4208	Engage one tab	2340
Figure 1-4209	Engage one tab and install one screw	2341
Figure 1-4210	Install three screws	2341
Figure 1-4211	Install the cover	2342
Figure 1-4212	Engage the cover	2342
Figure 1-4213	Install one screw	2343
Figure 1-4214	Install the cables	2343

Figure 1-4215	Position the hooks	2344
Figure 1-4216	Install the cover	2344
Figure 1-4217	Install one screw and connector	2345
Figure 1-4218	Install one screw and connector	2345
Figure 1-4219	Locate the ISA mounting pins and slots	250
Figure 1-4220	Install the ISA	2346
Figure 1-4221	Slide the ISA towards the front of the printer	2347
Figure 1-4222	Install one screw	2347
Figure 1-4223	Install two screws	2348
Figure 1-4224	Install one screw	2348
Figure 1-4225	Connect connectors	2349
Figure 1-4226	Install two tabs	2349
Figure 1-4227	Install the cover assembly	2350
Figure 1-4228	Install one screw	2350
Figure 1-4229	Install the cover	2351
Figure 1-4230	Press the cover	2351
Figure 1-4231	Install one screw	2352
Figure 1-4232	Position the tab	2352
Figure 1-4233	Slide the cover	2353
Figure 1-4234	Check the tab	2353
Figure 1-4235	Position the hooks	2354
Figure 1-4236	Install the cover	2354
Figure 1-4237	Install four screws cover	2355
Figure 1-4238	Align the cover	2355
Figure 1-4239	Rotate the top of the cover	2356
Figure 1-4240	Slide the cover	2356
Figure 1-4241	Install two screws	2357
Figure 1-4242	Install the cover	2357
Figure 1-4243	Install four screws cover	2358
Figure 1-4244	Install the formatter	2358
Figure 1-4245	Install four screws	2359
Figure 1-4246	Connect all connectors	2360
Figure 1-4247	Position the fax PCA	2360
Figure 1-4248	Install the fax PCA	2361
Figure 1-4249	Connect the connector	2361
Figure 1-4250	Install the holder	2362
Figure 1-4251	Release the HDD	2362
Figure 1-4252	Install the formatter	2363
Figure 1-4253	Connect all connectors	2364
Figure 1-4254	Place the control panel on the product	2365
Figure 1-4255	Connect two connectors	2365

Figure 1-4256	Turn the control panel over	2366
Figure 1-4257	Rotate the control-panel base down	2366
Figure 1-4258	Install two screws	2367
Figure 1-4259	Install the cover	2367
Figure 1-4260	Install the cover	2368
Figure 1-4261	Check the installation	2368
Figure 1-4262	Install the cover	2369
Figure 1-4263	Verify that the toner collection hatch cover is closed	2369
Figure 1-4264	Install the TCU	2370
Figure 1-4265	Close the front door	2370
Figure 1-4266	Install the tray	2371
Figure 1-4267	Close the tray	2371
Figure 1-4268	Handle the ITB by the edges	2372
Figure 1-4269	Align the ITB with the slots in the product	2372
Figure 1-4270	Install the ITB	2373
Figure 1-4271	Remove the spring from the holder	2373
Figure 1-4272	Fasten the rear-side ITB spring	2374
Figure 1-4273	Remove the spring from the holder	2374
Figure 1-4274	Fasten the front-side ITB spring	2375
Figure 1-4275	Engage the ITB drive coupling	2375
Figure 1-4276	Close the right door	2376
Figure 1-4277	Install the right hinge	2376
Figure 1-4278	Install the left hinge	2377
Figure 1-4279	Engage the blue arm with the pin	2377
Figure 1-4280	Close the right door	2378
Figure 1-4281	Open the right door	2382
Figure 1-4282	Release the secondary transfer roller assembly	2383
Figure 1-4283	Carefully flex the top portion of the blue arm	2383
Figure 1-4284	Disengage the blue arm and pin	2384
Figure 1-4285	Remove the secondary transfer roller assembly	2384
Figure 1-4286	Open the right door	2385
Figure 1-4287	Release the ITB drive coupling	2385
Figure 1-4288	Lower the secondary transfer roller assembly	2386
Figure 1-4289	Release the front-side ITB spring	2386
Figure 1-4290	Place the spring on the holder	2387
Figure 1-4291	Release the rear-side ITB spring	2387
Figure 1-4292	Place the spring on the holder	2388
Figure 1-4293	Grasp the ITB handles	2389
Figure 1-4294	Remove the ITB	2389
Figure 1-4295	Pull the tray out	2390
Figure 1-4296	Remove the tray	2390

Figure 1-4297	Open the front door	2391
Figure 1-4298	Open the TCU	2391
Figure 1-4299	Remove the TCU	2392
Figure 1-4300	Locate the formatter cover	2393
Figure 1-4301	Loosen the thumbscrews	2393
Figure 1-4302	Locate the USB cover	2394
Figure 1-4303	Remove the cover	2394
Figure 1-4304	Tilt the control panel up	2395
Figure 1-4305	Release the control-panel screws cover tabs	2395
Figure 1-4306	Remove the cover	2396
Figure 1-4307	Remove two screws	2396
Figure 1-4308	Rotate the control-panel base up	2397
Figure 1-4309	Turn the control panel over	2397
Figure 1-4310	Disconnect two connectors	2398
Figure 1-4311	Disconnect all connectors	2399
Figure 1-4312	Remove the formatter	2399
Figure 1-4313	Release the HDD	2400
Figure 1-4314	Remove the HDD	2400
Figure 1-4315	Locate the fax PCA	2401
Figure 1-4316	Disconnect one connector	2401
Figure 1-4317	Release one latch	2402
Figure 1-4318	Remove the fax PCA	2402
Figure 1-4319	Disconnect all connectors	2403
Figure 1-4320	Remove four screws	2404
Figure 1-4321	Remove the formatter	2404
Figure 1-4322	Remove four screws	2405
Figure 1-4323	Remove the cover	2405
Figure 1-4324	Remove two screws	2406
Figure 1-4325	Release the right edge	2406
Figure 1-4326	Slide the cover right	2407
Figure 1-4327	Remove the cover	2407
Figure 1-4328	Remove four screws	2408
Figure 1-4329	Remove the cover	2408
Figure 1-4330	Release one tab	2409
Figure 1-4331	Slide the cover back	2409
Figure 1-4332	Remove the left upper cover	2410
Figure 1-4333	Install the cover	2410
Figure 1-4334	Press the cover	2411
Figure 1-4335	Install one screw	2411
Figure 1-4336	Remove one screw	2412
Figure 1-4337	Release two tabs	2412

Figure 1-4338	Release the back edge of the cover	2413
Figure 1-4339	Remove the cover	2413
Figure 1-4340	Remove one screw	2414
Figure 1-4341	Remove two screws	2414
Figure 1-4342	Remove one screw	2415
Figure 1-4343	Disconnect connectors	2415
Figure 1-4344	Slide the ISA towards the back of the printer	2416
Figure 1-4345	Remove the ISA	2416
Figure 1-4346	Remove two screws and one connector	2417
Figure 1-4347	Remove one screw and connector	2417
Figure 1-4348	Slide the cover	2418
Figure 1-4349	Remove the cover	2418
Figure 1-4350	Remove one screw	2419
Figure 1-4351	Release the cover	2419
Figure 1-4352	Remove the cover	2420
Figure 1-4353	Remove three screws	2420
Figure 1-4354	Remove one screw and release one tab	2421
Figure 1-4355	Release the cover	2421
Figure 1-4356	Remove the cover	2422
Figure 1-4357	Release the cover	2422
Figure 1-4358	Remove the cover	2423
Figure 1-4359	Disconnect one connector	2423
Figure 1-4360	Remove the bracket	2424
Figure 1-4361	Remove the LVPS cover	2424
Figure 1-4362	Release wire harnesses and flat cable	2425
Figure 1-4363	Remove six screws	2425
Figure 1-4364	Release the formatter case	2426
Figure 1-4365	Remove the formatter case	2426
Figure 1-4366	Disconnect one wire harness	2427
Figure 1-4367	Disconnect seven connectors	2427
Figure 1-4368	Pass the wire harnesses through the opening	2428
Figure 1-4369	Remove three screws	2428
Figure 1-4370	Remove the LVPS	2429
Figure 1-4371	Remove one screw	2429
Figure 1-4372	Release the wire harnesses	2430
Figure 1-4373	Remove the fan	2430
Figure 1-4374	Disconnect one flat cable	2431
Figure 1-4375	Remove three screws	2431
Figure 1-4376	Remove the HVPSD	2432
Figure 1-4377	Disconnect two connectors	2432
Figure 1-4378	Disconnect two flat cables	2433

Figure 1-4379	Remove the assembly	2433
Figure 1-4380	Remove two screws	2434
Figure 1-4381	Remove the plate	2434
Figure 1-4382	Move the guide out of the way	2435
Figure 1-4383	Remove three screws	2435
Figure 1-4384	Remove the assembly	2436
Figure 1-4385	Remove the gear if installed	2436
Figure 1-4386	Release one tab	2437
Figure 1-4387	Remove the cover	2437
Figure 1-4388	Release the guide	2438
Figure 1-4389	Move the guide out of the way	2438
Figure 1-4390	Remove three screws	2439
Figure 1-4391	Locate the sheet metal portion of the assembly	2439
Figure 1-4392	Take note of the sheet-metal tabs	2440
Figure 1-4393	Rotate the top of the assembly away from the chassis	2440
Figure 1-4394	Release the bottom tabs	2441
Figure 1-4395	Remove the assembly	2441
Figure 1-4396	Remove one screw	2442
Figure 1-4397	Remove the cover	2442
Figure 1-4398	Remove the cover	2443
Figure 1-4399	Remove the assembly	2443
Figure 1-4400	Recycle and unpack	2444
Figure 1-4401	Install the assembly	2444
Figure 1-4402	Install the cover	2445
Figure 1-4403	Install the cover	2445
Figure 1-4404	Install one screw	2446
Figure 1-4405	Connect three connectors	2446
Figure 1-4406	Align the tabs on the assembly with the slots	2447
Figure 1-4407	Install the bottom tabs	2447
Figure 1-4408	Install the top tabs	2448
Figure 1-4409	Install three screws	2448
Figure 1-4410	Position the guide on the product	2449
Figure 1-4411	Install the guide	2449
Figure 1-4412	Position the cover on the product	2450
Figure 1-4413	Install the cover	2450
Figure 1-4414	Check the gears for a gap	2451
Figure 1-4415	Adjust the gears	2451
Figure 1-4416	Install the assembly	2452
Figure 1-4417	Install three screws	2452
Figure 1-4418	Install the guide	2453
Figure 1-4419	Install the plate	2453

Figure 1-4420	Install two screws	2454
Figure 1-4421	Install the lifter drive	2454
Figure 1-4422	Connect two flat cables	2455
Figure 1-4423	Connect two connectors	2455
Figure 1-4424	Install the HVPSD	2456
Figure 1-4425	Press the tabs	2456
Figure 1-4426	Install three screws	2457
Figure 1-4427	Connect one flat cable	2457
Figure 1-4428	Install the fan	2458
Figure 1-4429	Place the wire harnesses in the retainer	2458
Figure 1-4430	Install one screw	2459
Figure 1-4431	Install the LVPS	2459
Figure 1-4432	Install three screws	2460
Figure 1-4433	Pass the wire harnesses through the opening	2460
Figure 1-4434	Connect seven connectors	2461
Figure 1-4435	Connect one wire harness	2461
Figure 1-4436	Pass the wire harnesses through the opening	2462
Figure 1-4437	Install the formatter case	2462
Figure 1-4438	Install six screws	2463
Figure 1-4439	Install wire harnesses and flat cable	2463
Figure 1-4440	Install the LVPS cover	2464
Figure 1-4441	Attach the flat cable	2464
Figure 1-4442	Position the bracket	2465
Figure 1-4443	Connect one connector	2465
Figure 1-4444	Install the cover	2466
Figure 1-4445	Install one screw	2466
Figure 1-4446	Install the cover	2467
Figure 1-4447	Engage one tab	2467
Figure 1-4448	Engage one tab and install one screw	2468
Figure 1-4449	Install three screws	2468
Figure 1-4450	Install the cover	2469
Figure 1-4451	Engage the cover	2469
Figure 1-4452	Install one screw	2470
Figure 1-4453	Install the cables	2470
Figure 1-4454	Position the hooks	2471
Figure 1-4455	Install the cover	2471
Figure 1-4456	Install one screw and connector	2472
Figure 1-4457	Install one screw and connector	2472
Figure 1-4458	Locate the ISA mounting pins and slots	250
Figure 1-4459	Install the ISA	2473
Figure 1-4460	Slide the ISA towards the front of the printer	2474

Figure 1-4461	Install one screw	2474
Figure 1-4462	Install two screws	2475
Figure 1-4463	Install one screw	2475
Figure 1-4464	Connect connectors	2476
Figure 1-4465	Install two tabs	2476
Figure 1-4466	Install the cover assembly	2477
Figure 1-4467	Install one screw	2477
Figure 1-4468	Install the cover	2478
Figure 1-4469	Press the cover	2478
Figure 1-4470	Install one screw	2479
Figure 1-4471	Position the tab	2479
Figure 1-4472	Slide the cover	2480
Figure 1-4473	Check the tab	2480
Figure 1-4474	Position the hooks	2481
Figure 1-4475	Install the cover	2481
Figure 1-4476	Install four screws cover	2482
Figure 1-4477	Align the cover	2482
Figure 1-4478	Rotate the top of the cover	2483
Figure 1-4479	Slide the cover	2483
Figure 1-4480	Install two screws	2484
Figure 1-4481	Install the cover	2484
Figure 1-4482	Install four screws cover	2485
Figure 1-4483	Install the formatter	2485
Figure 1-4484	Install four screws	2486
Figure 1-4485	Connect all connectors	2487
Figure 1-4486	Position the fax PCA	2487
Figure 1-4487	Install the fax PCA	2488
Figure 1-4488	Connect the connector	2488
Figure 1-4489	Install the holder	2489
Figure 1-4490	Release the HDD	2489
Figure 1-4491	Install the formatter	2490
Figure 1-4492	Connect all connectors	2491
Figure 1-4493	Place the control panel on the product	2492
Figure 1-4494	Connect two connectors	2492
Figure 1-4495	Turn the control panel over	2493
Figure 1-4496	Rotate the control-panel base down	2493
Figure 1-4497	Install two screws	2494
Figure 1-4498	Install the cover	2494
Figure 1-4499	Install the cover	2495
Figure 1-4500	Check the installation	2495
Figure 1-4501	Install the cover	2496

Figure 1-4502	Verify that the toner collection hatch cover is closed	2496
Figure 1-4503	Install the TCU	2497
Figure 1-4504	Close the front door	2497
Figure 1-4505	Install the tray	2498
Figure 1-4506	Close the tray	2498
Figure 1-4507	Handle the ITB by the edges	2499
Figure 1-4508	Align the ITB with the slots in the product	2499
Figure 1-4509	Install the ITB	2500
Figure 1-4510	Remove the spring from the holder	2500
Figure 1-4511	Fasten the rear-side ITB spring	2501
Figure 1-4512	Remove the spring from the holder	2501
Figure 1-4513	Fasten the front-side ITB spring	2502
Figure 1-4514	Engage the ITB drive coupling	2502
Figure 1-4515	Close the right door	2503
Figure 1-4516	Install the right hinge	2503
Figure 1-4517	Install the left hinge	2504
Figure 1-4518	Engage the blue arm with the pin	2504
Figure 1-4519	Close the right door	2505
Figure 1-4520	Locate the USB cover	2510
Figure 1-4521	Remove the cover	2510
Figure 1-4522	Open the right door	2511
Figure 1-4523	Release the fuser	2511
Figure 1-4524	Remove the fuser	2512
Figure 1-4525	Release the ITB drive coupling	2512
Figure 1-4526	Lower the secondary transfer roller assembly	2513
Figure 1-4527	Release the front-side ITB spring	2513
Figure 1-4528	Place the spring on the holder	2514
Figure 1-4529	Release the rear-side ITB spring	2514
Figure 1-4530	Place the spring on the holder	2515
Figure 1-4531	Grasp the ITB handles	2516
Figure 1-4532	Remove the ITB	2516
Figure 1-4533	Tilt the control panel up	2517
Figure 1-4534	Release the control-panel screws cover tabs	2517
Figure 1-4535	Remove the cover	2518
Figure 1-4536	Remove two screws	2518
Figure 1-4537	Rotate the control-panel base up	2519
Figure 1-4538	Turn the control panel over	2519
Figure 1-4539	Disconnect two connectors	2520
Figure 1-4540	Pull the tray out	2520
Figure 1-4541	Remove the tray	2521
Figure 1-4542	Open the front door	2521

Figure 1-4543	Open the TCU	2522
Figure 1-4544	Remove the TCU	2523
Figure 1-4545	Locate the formatter cover	2524
Figure 1-4546	Loosen the thumbscrews	2524
Figure 1-4547	Disconnect all connectors	2526
Figure 1-4548	Remove the formatter	2526
Figure 1-4549	Release the HDD	2527
Figure 1-4550	Remove the HDD	2527
Figure 1-4551	Locate the fax PCA	2528
Figure 1-4552	Disconnect one connector	2528
Figure 1-4553	Release one latch	2529
Figure 1-4554	Remove the fax PCA	2529
Figure 1-4555	Disconnect all connectors	2530
Figure 1-4556	Remove four screws	2531
Figure 1-4557	Remove the formatter	2531
Figure 1-4558	Remove four screws	2532
Figure 1-4559	Remove the cover	2532
Figure 1-4560	Remove two screws	2533
Figure 1-4561	Release the right edge	2533
Figure 1-4562	Slide the cover right	2534
Figure 1-4563	Remove the cover	2534
Figure 1-4564	Remove four screws	2535
Figure 1-4565	Remove the cover	2535
Figure 1-4566	Release one tab	2536
Figure 1-4567	Slide the cover back	2536
Figure 1-4568	Remove the left upper cover	2537
Figure 1-4569	Remove one screw	2537
Figure 1-4570	Release two tabs	2538
Figure 1-4571	Rotate the cover	2538
Figure 1-4572	Remove one screw	2539
Figure 1-4573	Release two tabs	2539
Figure 1-4574	Release the back edge of the cover	2540
Figure 1-4575	Remove the cover	2540
Figure 1-4576	Remove one screw	2541
Figure 1-4577	Remove two screws	2541
Figure 1-4578	Remove one screw	2542
Figure 1-4579	Disconnect connectors	2542
Figure 1-4580	Slide the ISA towards the back of the printer	2543
Figure 1-4581	Remove the ISA	2543
Figure 1-4582	Disconnect connector and remove screws	2544
Figure 1-4583	Remove the stapler unit	2544

Figure 1-4584	Remove two screws and one connector	2545
Figure 1-4585	Remove one screw and connector	2545
Figure 1-4586	Slide the cover	2546
Figure 1-4587	Remove the cover	2546
Figure 1-4588	Remove five screws	2547
Figure 1-4589	Release two tabs	2547
Figure 1-4590	Remove the top rear cover	2548
Figure 1-4591	Remove one screw	2548
Figure 1-4592	Remove the cover	2549
Figure 1-4593	Remove one screw	2549
Figure 1-4594	Remove one screw	2550
Figure 1-4595	Release one tab	2550
Figure 1-4596	Release two tabs	2551
Figure 1-4597	Remove three screws	2551
Figure 1-4598	Remove two screws	2552
Figure 1-4599	Remove the bracket	2552
Figure 1-4600	Remove one screw	2553
Figure 1-4601	Release the cover	2553
Figure 1-4602	Remove the cover	2554
Figure 1-4603	Remove three screws	2554
Figure 1-4604	Remove one screw and release one tab	2555
Figure 1-4605	Release the cover	2555
Figure 1-4606	Remove the cover	2556
Figure 1-4607	Disconnect one connector	2556
Figure 1-4608	Remove the bracket	2557
Figure 1-4609	Remove the LVPS cover	2557
Figure 1-4610	Release wire harnesses and flat cable	2558
Figure 1-4611	Remove six screws	2558
Figure 1-4612	Release the formatter case	2559
Figure 1-4613	Remove the formatter case	2559
Figure 1-4614	Release the cover	2560
Figure 1-4615	Remove the cover	2560
Figure 1-4616	Disconnect one wire harness	2561
Figure 1-4617	Disconnect seven connectors	2561
Figure 1-4618	Pass the wire harnesses through the opening	2562
Figure 1-4619	Remove three screws	2562
Figure 1-4620	Remove the LVPS	2563
Figure 1-4621	Remove one screw	2563
Figure 1-4622	Release the wire harnesses	2564
Figure 1-4623	Remove the fan	2564
Figure 1-4624	Disconnect one flat cable	2565

Figure 1-4625	Remove three screws	2565
Figure 1-4626	Remove the HVPST	2566
Figure 1-4627	Disconnect two connectors	2566
Figure 1-4628	Disconnect two flat cables	2567
Figure 1-4629	Remove the assembly	2567
Figure 1-4630	Remove two screws	2568
Figure 1-4631	Remove the plate	2568
Figure 1-4632	Disconnect five connectors and one flat cable	2569
Figure 1-4633	Remove one screw	2569
Figure 1-4634	Release the HVPST	2570
Figure 1-4635	Remove the HVPST	2570
Figure 1-4636	Move the guide out of the way	2571
Figure 1-4637	Disconnect one connector	2571
Figure 1-4638	Remove one screw	2572
Figure 1-4639	Remove the guide	2572
Figure 1-4640	Remove three screws	2573
Figure 1-4641	Remove the assembly	2573
Figure 1-4642	Remove one screw	2574
Figure 1-4643	Remove the cover	2574
Figure 1-4644	Release the wire harnesses	2575
Figure 1-4645	Disconnect two connectors	2575
Figure 1-4646	Release the wire harnesses	2576
Figure 1-4647	Disconnect one connector	2576
Figure 1-4648	Release the guide	2577
Figure 1-4649	Remove the guide	2577
Figure 1-4650	Release one wire harness	2578
Figure 1-4651	Release the guide	2578
Figure 1-4652	Remove the guide	2579
Figure 1-4653	Remove seven screws	2579
Figure 1-4654	Remove the main-drive assembly	2580
Figure 1-4655	Recycle and unpack	2580
Figure 1-4656	Main drive gear and cam locations	2581
Figure 1-4657	Main drive gear and cam alignment	2582
Figure 1-4658	Check the blue ITB drive handle	2583
Figure 1-4659	Install the main-drive assembly	2583
Figure 1-4660	Install seven screws	2584
Figure 1-4661	Verify that the assembly is correctly fastened	2584
Figure 1-4662	Install the guide	2585
Figure 1-4663	Install one wire harness	2585
Figure 1-4664	Install the guide	2586
Figure 1-4665	Connect one connector	2586

Figure 1-4666	Install the wire harnesses	2587
Figure 1-4667	Connect two connectors	2587
Figure 1-4668	Install the wire harnesses	2588
Figure 1-4669	Install the cover	2588
Figure 1-4670	Install one screw	2589
Figure 1-4671	Check the gears on the assembly	2589
Figure 1-4672	Install three screws	2590
Figure 1-4673	Install the guide	2590
Figure 1-4674	Install one screw	2591
Figure 1-4675	Connect one connector	2591
Figure 1-4676	Install the guide	2592
Figure 1-4677	Connect one ground wire	2592
Figure 1-4678	Install the HVPST	2593
Figure 1-4679	Install one screw	2593
Figure 1-4680	Connect five connectors and one flat cable	2594
Figure 1-4681	Install the plate	2594
Figure 1-4682	Install two screws	2595
Figure 1-4683	Install the lifter drive	2595
Figure 1-4684	Connect two flat cables	2596
Figure 1-4685	Connect two connectors	2596
Figure 1-4686	Install the HVPST	2597
Figure 1-4687	Press the tabs	2597
Figure 1-4688	Install three screws	2598
Figure 1-4689	Connect one flat cable	2598
Figure 1-4690	Install the fan	2599
Figure 1-4691	Place the wire harnesses in the retainer	2599
Figure 1-4692	Install one screw	2600
Figure 1-4693	Install the LVPS	2600
Figure 1-4694	Install three screws	2601
Figure 1-4695	Pass the wire harnesses through the opening	2601
Figure 1-4696	Connect seven connectors	2602
Figure 1-4697	Connect one wire harness	2602
Figure 1-4698	Install the cover	2603
Figure 1-4699	Install one screw	2603
Figure 1-4700	Pass the wire harnesses through the opening	2604
Figure 1-4701	Install the formatter case	2604
Figure 1-4702	Install six screws	2605
Figure 1-4703	Install wire harnesses and flat cable	2605
Figure 1-4704	Install the LVPS cover	2606
Figure 1-4705	Attach the flat cable	2606
Figure 1-4706	Position the bracket	2607

Figure 1-4707	Connect one connector	2607
Figure 1-4708	Install the cover	2608
Figure 1-4709	Engage one tab	2608
Figure 1-4710	Engage one tab and install one screw	2609
Figure 1-4711	Install three screws	2609
Figure 1-4712	Install the cover	2610
Figure 1-4713	Engage the cover	2610
Figure 1-4714	Install one screw	2611
Figure 1-4715	Position the tabs in the slots	2611
Figure 1-4716	Install two screws	2612
Figure 1-4717	Install three screws	2612
Figure 1-4718	Position the locator pins	2613
Figure 1-4719	Press down on the cover	2613
Figure 1-4720	Install one screw	2614
Figure 1-4721	Install one screw	2614
Figure 1-4722	Install the cover	2615
Figure 1-4723	Install one screw	2615
Figure 1-4724	Align the locator tabs	2616
Figure 1-4725	Install the cover	2616
Figure 1-4726	Install five screws	2617
Figure 1-4727	Install the cables	2617
Figure 1-4728	Position the hooks	2618
Figure 1-4729	Install the cover	2618
Figure 1-4730	Install one screw and connector	2619
Figure 1-4731	Install one screw and connector	2619
Figure 1-4732	Position the hooks in the slots	2620
Figure 1-4733	Connect connector and install screws	2620
Figure 1-4734	Locate the ISA mounting pins and slots	250
Figure 1-4735	Install the ISA	2622
Figure 1-4736	Slide the ISA towards the front of the printer	2622
Figure 1-4737	Install one screw	2623
Figure 1-4738	Install two screws	2623
Figure 1-4739	Install one screw	2624
Figure 1-4740	Connect connectors	2624
Figure 1-4741	Install two tabs	2625
Figure 1-4742	Install the cover assembly	2625
Figure 1-4743	Install one screw	2626
Figure 1-4744	Install the cover	2627
Figure 1-4745	Press the cover	2627
Figure 1-4746	Install one screw	2628
Figure 1-4747	Position the tab	2628

Figure 1-4748	Slide the cover	2629
Figure 1-4749	Check the tab	2629
Figure 1-4750	Position the hooks	2630
Figure 1-4751	Install the cover	2630
Figure 1-4752	Install four screws cover	2631
Figure 1-4753	Align the cover	2631
Figure 1-4754	Rotate the top of the cover	2632
Figure 1-4755	Slide the cover	2632
Figure 1-4756	Install two screws	2633
Figure 1-4757	Install the cover	2633
Figure 1-4758	Install four screws cover	2634
Figure 1-4759	Install the formatter	2634
Figure 1-4760	Install four screws	2635
Figure 1-4761	Connect all connectors	2636
Figure 1-4762	Position the fax PCA	2636
Figure 1-4763	Install the fax PCA	2637
Figure 1-4764	Connect the connector	2637
Figure 1-4765	Install the holder	2638
Figure 1-4766	Release the HDD	2638
Figure 1-4767	Install the formatter	2639
Figure 1-4768	Connect all connectors	2640
Figure 1-4769	Install the cover	2641
Figure 1-4770	Verify that the toner collection hatch cover is closed	2641
Figure 1-4771	Install the TCU	2642
Figure 1-4772	Close the front door	2642
Figure 1-4773	Install the tray	2643
Figure 1-4774	Close the tray	2643
Figure 1-4775	Place the control panel on the product	2644
Figure 1-4776	Connect two connectors	2644
Figure 1-4777	Turn the control panel over	2645
Figure 1-4778	Rotate the control-panel base down	2645
Figure 1-4779	Install two screws	2646
Figure 1-4780	Install the cover	2646
Figure 1-4781	Handle the ITB by the edges	2647
Figure 1-4782	Align the ITB with the slots in the product	2647
Figure 1-4783	Install the ITB	2648
Figure 1-4784	Remove the spring from the holder	2648
Figure 1-4785	Fasten the rear-side ITB spring	2649
Figure 1-4786	Remove the spring from the holder	2649
Figure 1-4787	Fasten the front-side ITB spring	2650
Figure 1-4788	Engage the ITB drive coupling	2650

Figure 1-4789	Align the fuser with the opening	2651
Figure 1-4790	Install the fuser	2651
Figure 1-4791	Close the right door	2652
Figure 1-4792	Install the cover	2652
Figure 1-4793	Check the installation	2653
Figure 1-4794	Locate the formatter cover	2657
Figure 1-4795	Loosen the thumbscrews	2658
Figure 1-4796	Remove two screws	2658
Figure 1-4797	Release the right edge	2659
Figure 1-4798	Slide the cover right	2659
Figure 1-4799	Remove the cover	2660
Figure 1-4800	Release one tab	2660
Figure 1-4801	Slide the cover back	2661
Figure 1-4802	Remove the left upper cover	2661
Figure 1-4803	Remove one screw	2662
Figure 1-4804	Remove the cover	2662
Figure 1-4805	Disconnect the flat cable, ground cable, and connectors	2663
Figure 1-4806	Open the document feeder	2663
Figure 1-4807	Raise the document feeder	2664
Figure 1-4808	Release two tabs	2664
Figure 1-4809	Remove the document feeder	2665
Figure 1-4810	Recycle and unpack	2665
Figure 1-4811	Install the document feeder	2666
Figure 1-4812	Lower the document feeder	2666
Figure 1-4813	Install the retention clip	2667
Figure 1-4814	Press the retention clip	2667
Figure 1-4815	Install the white backing	2668
Figure 1-4816	Attach the white backing	2668
Figure 1-4817	Check the white backing	2669
Figure 1-4818	Close the document feeder	2669
Figure 1-4819	Connect the flat cable, ground cable, and connectors	2670
Figure 1-4820	Position the tabs	2670
Figure 1-4821	Install the cover	2671
Figure 1-4822	Install one screw	2671
Figure 1-4823	Position the tab	2672
Figure 1-4824	Slide the cover	2672
Figure 1-4825	Check the tab	2673
Figure 1-4826	Align the cover	2673
Figure 1-4827	Rotate the top of the cover	2674
Figure 1-4828	Slide the cover	2674
Figure 1-4829	Install two screws	2675

Figure 1-4830	Install the cover	2675
Figure 1-4831	Locate the formatter cover	2678
Figure 1-4832	Loosen the thumbscrews	2678
Figure 1-4833	Remove two screws	2679
Figure 1-4834	Release the right edge	2679
Figure 1-4835	Slide the cover right	2680
Figure 1-4836	Remove the cover	2680
Figure 1-4837	Disconnect all of the connectors	2681
Figure 1-4838	Disconnect three connectors	2681
Figure 1-4839	Remove two screws	2682
Figure 1-4840	Slide the SCB out	2682
Figure 1-4841	Remove the SCB	2683
Figure 1-4842	Recycle and unpack	2683
Figure 1-4843	Install the SCB	2684
Figure 1-4844	Slide the SCB in	2684
Figure 1-4845	Raise the SCB and install cables	2685
Figure 1-4846	Install two screws	2685
Figure 1-4847	Connect three connectors	2686
Figure 1-4848	Connect all of the connectors	2686
Figure 1-4849	Align the cover	2687
Figure 1-4850	Rotate the top of the cover	2687
Figure 1-4851	Slide the cover	2688
Figure 1-4852	Install two screws	2688
Figure 1-4853	Install the cover	2689
Figure 1-4854	Open the document feeder	2692
Figure 1-4855	Release five tabs	2692
Figure 1-4856	Remove the cover	2693
Figure 1-4857	Remove the white backing	2693
Figure 1-4858	Check the retention clips	2694
Figure 1-4859	Check the retention clip spring	2694
Figure 1-4860	Install the retention clip	2695
Figure 1-4861	Press the retention clip	2695
Figure 1-4862	Disconnect the keyboard flat cable	2696
Figure 1-4863	Slide the keyboard out	2696
Figure 1-4864	Release two tabs	2697
Figure 1-4865	Remove the keyboard	2697
Figure 1-4866	Disconnect connectors	2698
Figure 1-4867	Disconnect connectors	2698
Figure 1-4868	Remove three screws	2699
Figure 1-4869	Remove the control panel	2699
Figure 1-4870	Locate the formatter cover	2700

Figure 1-4871	Loosen the thumbscrews	2700
Figure 1-4872	Locate the fax PCA	2701
Figure 1-4873	Disconnect one connector	2701
Figure 1-4874	Release one latch	2702
Figure 1-4875	Remove the fax PCA	2702
Figure 1-4876	Remove two screws	2703
Figure 1-4877	Release the right edge	2703
Figure 1-4878	Slide the cover right	2704
Figure 1-4879	Remove the cover	2704
Figure 1-4880	Release one tab	2705
Figure 1-4881	Slide the cover back	2705
Figure 1-4882	Remove the left upper cover	2706
Figure 1-4883	Remove one screw	2706
Figure 1-4884	Release two tabs	2707
Figure 1-4885	Rotate the cover	2707
Figure 1-4886	Remove one screw	2708
Figure 1-4887	Release two tabs	2708
Figure 1-4888	Release the back edge of the cover	2709
Figure 1-4889	Remove the cover	2709
Figure 1-4890	Remove one screw	2710
Figure 1-4891	Remove the cover	2710
Figure 1-4892	Disconnect the flat cable, ground cable, and connectors	2711
Figure 1-4893	Disconnect three connectors	2711
Figure 1-4894	Open the document feeder	2712
Figure 1-4895	Raise the document feeder	2712
Figure 1-4896	Release two tabs	2713
Figure 1-4897	Remove the document feeder	2713
Figure 1-4898	Remove two screws	2714
Figure 1-4899	Slide the SCB out	2714
Figure 1-4900	Remove the SCB	2715
Figure 1-4901	Disconnect cables and connectors	2715
Figure 1-4902	Remove one screw	2716
Figure 1-4903	Remove two screws	2716
Figure 1-4904	Remove one screw	2717
Figure 1-4905	Release the image scanner	2717
Figure 1-4906	Remove the image scanner	2718
Figure 1-4907	Recycle and unpack	2718
Figure 1-4908	Locate the image scanner mounting pins and slots	2719
Figure 1-4909	Install the image scanner	2719
Figure 1-4910	Engage the image scanner	2720
Figure 1-4911	Install one screw	2720

Figure 1-4912	Install two screws	2721
Figure 1-4913	Install one screw	2721
Figure 1-4914	Connect connectors	2722
Figure 1-4915	Keyboard cover mounting slots and tabs (M577dn and M577f)	2722
Figure 1-4916	Install the keyboard cover (M577dn and M577f)	2723
Figure 1-4917	Check the keyboard cover (M577dn and M577f)	2723
Figure 1-4918	Install the SCB	2724
Figure 1-4919	Slide the SCB in	2724
Figure 1-4920	Raise the SCB and install cables	2725
Figure 1-4921	Install two screws	2725
Figure 1-4922	Install the document feeder	2726
Figure 1-4923	Lower the document feeder	2726
Figure 1-4924	Close the document feeder	2727
Figure 1-4925	Connect three connectors	2727
Figure 1-4926	Connect the flat cable, ground cable, and connectors	2728
Figure 1-4927	Position the tabs	2728
Figure 1-4928	Install the cover	2729
Figure 1-4929	Install one screw	2729
Figure 1-4930	Install two tabs	2730
Figure 1-4931	Install the cover assembly	2730
Figure 1-4932	Install one screw	2731
Figure 1-4933	Install the cover	2731
Figure 1-4934	Press the cover	2732
Figure 1-4935	Install one screw	2732
Figure 1-4936	Position the tab	2733
Figure 1-4937	Slide the cover	2733
Figure 1-4938	Check the tab	2734
Figure 1-4939	Align the cover	2734
Figure 1-4940	Rotate the top of the cover	2735
Figure 1-4941	Slide the cover	2735
Figure 1-4942	Install two screws	2736
Figure 1-4943	Position the fax PCA	2737
Figure 1-4944	Install the fax PCA	2737
Figure 1-4945	Connect the connector	2738
Figure 1-4946	Install the cover	2738
Figure 1-4947	Open the control panel	2739
Figure 1-4948	Locate hooks and grounding clip	98
Figure 1-4949	Install the control-panel	2740
Figure 1-4950	Install three screws	2740
Figure 1-4951	Connect connectors	2741
Figure 1-4952	Connect connectors	2741

Figure 1-4953	Install the flat cable through the slot	2742
Figure 1-4954	Slide the keyboard into the slot	2742
Figure 1-4955	Check the flat cable	2743
Figure 1-4956	Connect the flat cable	2743
Figure 1-4957	Install the white backing	2744
Figure 1-4958	Close the document feeder	2744
Figure 1-4959	Check the white backing	2745
Figure 1-4960	Position the control-panel cover on the printer	2745
Figure 1-4961	Engage five tabs	2746
Figure 1-4962	Close the document feeder	2746
Figure 1-4963	Pull the tray out	2749
Figure 1-4964	Remove the tray	2749
Figure 1-4965	Recycle and unpack	2750
Figure 1-4966	Install the tray	2750
Figure 1-4967	Close the tray	2751
Figure 1-4968	Pull the tray out	2753
Figure 1-4969	Remove the tray	2753
Figure 1-4970	Recycle and unpack	2754
Figure 1-4971	Install the tray	2754
Figure 1-4972	Close the tray	2755
Figure 1-4973	Release three tabs	2758
Figure 1-4974	Remove the cover	2759
Figure 1-4975	Recycle and unpack	2759
Figure 1-4976	Position the cover on the chassis	2760
Figure 1-4977	Install the cover	2760
Figure 1-4978	Check the three tabs	2761
Figure 1-4979	Release three tabs	2763
Figure 1-4980	Remove the cover	2763
Figure 1-4981	Open the door	2764
Figure 1-4982	Release the hinge bracket	2764
Figure 1-4983	Remove the hinge bracket	2765
Figure 1-4984	Release the door link	2765
Figure 1-4985	Recycle and unpack	2766
Figure 1-4986	Install the door link	2766
Figure 1-4987	Position the door on the lower hinge	2767
Figure 1-4988	Engage the hinge bracket	2767
Figure 1-4989	Install the hinge bracket	2768
Figure 1-4990	Close the door	2768
Figure 1-4991	Position the cover on the chassis	2769
Figure 1-4992	Install the cover	2769
Figure 1-4993	Check the three tabs	2770

Figure 1-4994	Release three tabs	2772
Figure 1-4995	Remove the cover	2772
Figure 1-4996	Open the door	2773
Figure 1-4997	Release the hinge bracket	2773
Figure 1-4998	Remove the hinge bracket	2774
Figure 1-4999	Release the door link	2774
Figure 1-5000	Remove the hinge bracket	2775
Figure 1-5001	Recycle and unpack	2775
Figure 1-5002	Install the hinge bracket	2776
Figure 1-5003	Install the door link	2776
Figure 1-5004	Position the door on the lower hinge	2777
Figure 1-5005	Engage the hinge bracket	2777
Figure 1-5006	Install the hinge bracket	2778
Figure 1-5007	Close the door	2778
Figure 1-5008	Position the cover on the chassis	2779
Figure 1-5009	Install the cover	2779
Figure 1-5010	Check the three tabs	2780
Figure 1-5011	Release three tabs	2782
Figure 1-5012	Remove the cover	2782
Figure 1-5013	Open the door	2783
Figure 1-5014	Release the hinge bracket	2783
Figure 1-5015	Remove the hinge bracket	2784
Figure 1-5016	Release the door link	2784
Figure 1-5017	Cover mounting tabs	2785
Figure 1-5018	Release the cover	2785
Figure 1-5019	Remove the right-lower cover	2786
Figure 1-5020	Remove the right-door link	2786
Figure 1-5021	Recycle and unpack	2787
Figure 1-5022	Remove the right-door link	2787
Figure 1-5023	Cover mounting tabs	2788
Figure 1-5024	Install the right-lower cover	2788
Figure 1-5025	Engage the cover	2789
Figure 1-5026	Check the cover	2789
Figure 1-5027	Install the door link	2790
Figure 1-5028	Position the door on the lower hinge	2790
Figure 1-5029	Engage the hinge bracket	2791
Figure 1-5030	Install the hinge bracket	2791
Figure 1-5031	Close the door	2792
Figure 1-5032	Position the cover on the chassis	2792
Figure 1-5033	Install the cover	2793
Figure 1-5034	Check the three tabs	2793

Figure 1-5035	Release three tabs	2795
Figure 1-5036	Remove the cover	2795
Figure 1-5037	Open the door	2796
Figure 1-5038	Release the hinge bracket	2796
Figure 1-5039	Remove the hinge bracket	2797
Figure 1-5040	Release the door link	2797
Figure 1-5041	Cover mounting tabs	2798
Figure 1-5042	Release the cover	2798
Figure 1-5043	Remove the right-lower cover	2799
Figure 1-5044	Remove the right-door link	2799
Figure 1-5045	Recycle and unpack	2800
Figure 1-5046	Remove the right-door link	2800
Figure 1-5047	Cover mounting tabs	2801
Figure 1-5048	Install the right-lower cover	2801
Figure 1-5049	Engage the cover	2802
Figure 1-5050	Check the cover	2802
Figure 1-5051	Install the door link	2803
Figure 1-5052	Position the door on the lower hinge	2803
Figure 1-5053	Engage the hinge bracket	2804
Figure 1-5054	Install the hinge bracket	2804
Figure 1-5055	Close the door	2805
Figure 1-5056	Position the cover on the chassis	2805
Figure 1-5057	Install the cover	2806
Figure 1-5058	Check the three tabs	2806
Figure 1-5059	Release three tabs	2807
Figure 1-5060	Remove the cover	2808
Figure 1-5061	Recycle and unpack	2808
Figure 1-5062	Position the cover on the chassis	2809
Figure 1-5063	Install the cover	2809
Figure 1-5064	Check the three tabs	2810
Figure 1-5065	Release three tabs	2812
Figure 1-5066	Remove the cover	2812
Figure 1-5067	Disconnect one connector	2813
Figure 1-5068	Remove the drawer holder	2813
Figure 1-5069	Recycle and unpack	2814
Figure 1-5070	Install the drawer holder	2814
Figure 1-5071	Connect one connector	2815
Figure 1-5072	Position the cover on the chassis	2815
Figure 1-5073	Install the cover	2816
Figure 1-5074	Check the three tabs	2816
Figure 1-5075	Pull the tray out	2818

Figure 1-5076	Remove the tray	2818
Figure 1-5077	Release three tabs	2819
Figure 1-5078	Remove the cover	2819
Figure 1-5079	Disconnect one connector	2820
Figure 1-5080	Remove two screws	2820
Figure 1-5081	Release the assembly	2821
Figure 1-5082	Remove the assembly	2821
Figure 1-5083	Recycle and unpack	2822
Figure 1-5084	Install the assembly	2822
Figure 1-5085	Engage the assembly	2823
Figure 1-5086	Install two screws	2823
Figure 1-5087	Disconnect one connector	2824
Figure 1-5088	Position the cover on the chassis	2824
Figure 1-5089	Install the cover	2825
Figure 1-5090	Check the three tabs	2825
Figure 1-5091	Install the tray	2826
Figure 1-5092	Close the tray	2826
Figure 1-5093	Pull the tray out	2828
Figure 1-5094	Remove the tray	2828
Figure 1-5095	Release three tabs	2829
Figure 1-5096	Remove the cover	2829
Figure 1-5097	Disconnect one connector	2830
Figure 1-5098	Squeeze two tabs	2830
Figure 1-5099	Remove the switch button (SW12)	2831
Figure 1-5100	Recycle and unpack	2831
Figure 1-5101	Install the switch button (SW12)	2832
Figure 1-5102	Install the switch button (SW12)	2832
Figure 1-5103	Connect one connector	2833
Figure 1-5104	Position the cover on the chassis	2833
Figure 1-5105	Install the cover	2834
Figure 1-5106	Check the three tabs	2834
Figure 1-5107	Install the tray	2835
Figure 1-5108	Close the tray	2835
Figure 1-5109	Release three tabs	2837
Figure 1-5110	Remove the cover	2837
Figure 1-5111	Disconnect one connector	2838
Figure 1-5112	Release one tab	2838
Figure 1-5113	Remove the tray connector	2839
Figure 1-5114	Recycle and unpack	2839
Figure 1-5115	Place the tray connector on the accessory	2840
Figure 1-5116	Install the tray connector	2840

Figure 1-5117	Connect one connector	2841
Figure 1-5118	Position the cover on the chassis	2841
Figure 1-5119	Install the cover	2842
Figure 1-5120	Check the three tabs	2842
Figure 1-5121	Release three tabs	2844
Figure 1-5122	Remove the cover	2844
Figure 1-5123	Disconnect all of the connectors	2845
Figure 1-5124	Remove the PCA	2845
Figure 1-5125	Recycle and unpack	2846
Figure 1-5126	Install the PCA	2846
Figure 1-5127	Connect all of the connectors	2847
Figure 1-5128	Position the cover on the chassis	2847
Figure 1-5129	Install the cover	2848
Figure 1-5130	Check the three tabs	2848
Figure 1-5131	Pull the tray out	2850
Figure 1-5132	Remove the tray	2850
Figure 1-5133	Release three tabs	2851
Figure 1-5134	Remove the cover	2851
Figure 1-5135	Open the door	2852
Figure 1-5136	Release the hinge bracket	2852
Figure 1-5137	Remove the hinge bracket	2853
Figure 1-5138	Release the door link	2853
Figure 1-5139	Disconnect one connector	2854
Figure 1-5140	Release one tab	2854
Figure 1-5141	Remove the tray connector	2855
Figure 1-5142	Remove six screws	2855
Figure 1-5143	Remove the sheet-metal plate	2856
Figure 1-5144	Release the paper feed guide	2856
Figure 1-5145	Remove the cover	2857
Figure 1-5146	Disconnect one connector	2857
Figure 1-5147	Remove two springs	2858
Figure 1-5148	Remove three screws	2858
Figure 1-5149	Release two alignment pins	2859
Figure 1-5150	Remove the paper feed assembly	2859
Figure 1-5151	Recycle and unpack	2860
Figure 1-5152	Left side flag	2860
Figure 1-5153	Install the assembly	2861
Figure 1-5154	Check the alignment pins	2861
Figure 1-5155	Install three screws	2862
Figure 1-5156	Install two springs	2862
Figure 1-5157	Connect one connector	2863

Figure 1-5158	Install the cover	2863
Figure 1-5159	Raise the paper feed guide	2864
Figure 1-5160	Install the sheet-metal plate	2864
Figure 1-5161	Install six screws	2865
Figure 1-5162	Place the tray connector on the accessory	2865
Figure 1-5163	Install the tray connector	2866
Figure 1-5164	Connect one connector	2866
Figure 1-5165	Install the door link	2867
Figure 1-5166	Position the door on the lower hinge	2867
Figure 1-5167	Engage the hinge bracket	2868
Figure 1-5168	Install the hinge bracket	2868
Figure 1-5169	Close the door	2869
Figure 1-5170	Position the cover on the chassis	2869
Figure 1-5171	Install the cover	2870
Figure 1-5172	Check the three tabs	2870
Figure 1-5173	Install the tray	2871
Figure 1-5174	Close the tray	2871
Figure 1-5175	Pull the tray out	2873
Figure 1-5176	Remove the tray	2873
Figure 1-5177	Release three tabs	2874
Figure 1-5178	Remove the cover	2874
Figure 1-5179	Open the door	2875
Figure 1-5180	Release the hinge bracket	2875
Figure 1-5181	Remove the hinge bracket	2876
Figure 1-5182	Release the door link	2876
Figure 1-5183	Disconnect one connector	2877
Figure 1-5184	Release one tab	2877
Figure 1-5185	Remove the tray connector	2878
Figure 1-5186	Remove six screws	2878
Figure 1-5187	Remove the sheet-metal plate	2879
Figure 1-5188	Release the paper feed guide	2879
Figure 1-5189	Remove the cover	2880
Figure 1-5190	Disconnect one connector	2880
Figure 1-5191	Remove two springs	2881
Figure 1-5192	Remove three screws	2881
Figure 1-5193	Release two alignment pins	2882
Figure 1-5194	Remove the paper feed assembly	2882
Figure 1-5195	Disconnect one connector	2883
Figure 1-5196	Remove three screws	2883
Figure 1-5197	Lower the end of the assembly	2884
Figure 1-5198	Release the assembly from the drive gear	2884

Figure 1-5199	Remove the assembly	2885
Figure 1-5200	Recycle and unpack	2885
Figure 1-5201	Install the assembly	2886
Figure 1-5202	Raise the end of the assembly	2886
Figure 1-5203	Install three screws	2887
Figure 1-5204	Connect one connector	2887
Figure 1-5205	Left side flag	2888
Figure 1-5206	Install the assembly	2888
Figure 1-5207	Check the alignment pins	2889
Figure 1-5208	Install three screws	2889
Figure 1-5209	Install two springs	2890
Figure 1-5210	Connect one connector	2890
Figure 1-5211	Install the cover	2891
Figure 1-5212	Raise the paper feed guide	2891
Figure 1-5213	Install the sheet-metal plate	2892
Figure 1-5214	Install six screws	2892
Figure 1-5215	Place the tray connector on the accessory	2893
Figure 1-5216	Install the tray connector	2893
Figure 1-5217	Connect one connector	2894
Figure 1-5218	Install the door link	2894
Figure 1-5219	Position the door on the lower hinge	2895
Figure 1-5220	Engage the hinge bracket	2895
Figure 1-5221	Install the hinge bracket	2896
Figure 1-5222	Close the door	2896
Figure 1-5223	Position the cover on the chassis	2897
Figure 1-5224	Install the cover	2897
Figure 1-5225	Check the three tabs	2898
Figure 1-5226	Install the tray	2898
Figure 1-5227	Close the tray	2899
Figure 1-5228	Pull the tray out	2901
Figure 1-5229	Remove the tray	2901
Figure 1-5230	Release three tabs	2902
Figure 1-5231	Remove the cover	2902
Figure 1-5232	Open the door	2903
Figure 1-5233	Release the hinge bracket	2903
Figure 1-5234	Remove the hinge bracket	2904
Figure 1-5235	Release the door link	2904
Figure 1-5236	Cover mounting tabs	2905
Figure 1-5237	Release the cover	2905
Figure 1-5238	Remove the right-lower cover	2906
Figure 1-5239	Disconnect one connector	2906

Figure 1-5240	Release one tab	2907
Figure 1-5241	Remove the tray connector	2907
Figure 1-5242	Remove six screws	2908
Figure 1-5243	Remove the sheet-metal plate	2908
Figure 1-5244	Remove two screws	2909
Figure 1-5245	Remove the sheet-metal plate	2909
Figure 1-5246	Disconnect one connector	2910
Figure 1-5247	Remove one spring	2910
Figure 1-5248	Remove two screws	2911
Figure 1-5249	Remove the assembly	2911
Figure 1-5250	Recycle and unpack	2912
Figure 1-5251	Install the assembly	2912
Figure 1-5252	Install two screws	2913
Figure 1-5253	Install one spring	2913
Figure 1-5254	Connect one connector	2914
Figure 1-5255	Install the sheet-metal plate	2914
Figure 1-5256	Install two screws	2915
Figure 1-5257	Install the sheet-metal plate	2915
Figure 1-5258	Install six screws	2916
Figure 1-5259	Place the tray connector on the accessory	2916
Figure 1-5260	Install the tray connector	2917
Figure 1-5261	Connect one connector	2917
Figure 1-5262	Cover mounting tabs	2918
Figure 1-5263	Install the right-lower cover	2918
Figure 1-5264	Engage the cover	2919
Figure 1-5265	Check the cover	2919
Figure 1-5266	Install the door link	2920
Figure 1-5267	Position the door on the lower hinge	2920
Figure 1-5268	Engage the hinge bracket	2921
Figure 1-5269	Install the hinge bracket	2921
Figure 1-5270	Close the door	2922
Figure 1-5271	Position the cover on the chassis	2922
Figure 1-5272	Install the cover	2923
Figure 1-5273	Check the three tabs	2923
Figure 1-5274	Install the tray	2924
Figure 1-5275	Close the tray	2924
Figure 1-5276	Pull the tray out	2926
Figure 1-5277	Remove the tray	2926
Figure 1-5278	Release three tabs	2927
Figure 1-5279	Remove the cover	2927
Figure 1-5280	Open the door	2928

Figure 1-5281	Release the hinge bracket	2928
Figure 1-5282	Remove the hinge bracket	2929
Figure 1-5283	Release the door link	2929
Figure 1-5284	Cover mounting tabs	2930
Figure 1-5285	Release the cover	2930
Figure 1-5286	Remove the right-lower cover	2931
Figure 1-5287	Disconnect one connector	2931
Figure 1-5288	Release one tab	2932
Figure 1-5289	Remove the tray connector	2932
Figure 1-5290	Remove six screws	2933
Figure 1-5291	Remove the sheet-metal plate	2933
Figure 1-5292	Remove two screws	2934
Figure 1-5293	Remove the sheet-metal plate	2934
Figure 1-5294	Disconnect one connector	2935
Figure 1-5295	Remove one spring	2935
Figure 1-5296	Remove two screws	2936
Figure 1-5297	Remove the assembly	2936
Figure 1-5298	Disconnect one connector	2937
Figure 1-5299	Disconnect two connectors	2937
Figure 1-5300	Remove two screws	2938
Figure 1-5301	Release one tab	2938
Figure 1-5302	Release two tabs	2939
Figure 1-5303	Remove the assembly	2939
Figure 1-5304	Recycle and unpack	2940
Figure 1-5305	Install the assembly	2940
Figure 1-5306	Install the gear on the shaft	2941
Figure 1-5307	Install the assembly	2941
Figure 1-5308	Install two screws	2942
Figure 1-5309	Connect two connectors	2942
Figure 1-5310	Connect one connector	2943
Figure 1-5311	Install the assembly	2943
Figure 1-5312	Install two screws	2944
Figure 1-5313	Install one spring	2944
Figure 1-5314	Connect one connector	2945
Figure 1-5315	Install the sheet-metal plate	2945
Figure 1-5316	Install two screws	2946
Figure 1-5317	Install the sheet-metal plate	2946
Figure 1-5318	Install six screws	2947
Figure 1-5319	Place the tray connector on the accessory	2947
Figure 1-5320	Install the tray connector	2948
Figure 1-5321	Connect one connector	2948

Figure 1-5322	Cover mounting tabs	2949
Figure 1-5323	Install the right-lower cover	2949
Figure 1-5324	Engage the cover	2950
Figure 1-5325	Check the cover	2950
Figure 1-5326	Install the door link	2951
Figure 1-5327	Position the door on the lower hinge	2951
Figure 1-5328	Engage the hinge bracket	2952
Figure 1-5329	Install the hinge bracket	2952
Figure 1-5330	Close the door	2953
Figure 1-5331	Position the cover on the chassis	2953
Figure 1-5332	Install the cover	2954
Figure 1-5333	Check the three tabs	2954
Figure 1-5334	Install the tray	2955
Figure 1-5335	Close the tray	2955
Figure 1-5336	Locate the formatter cover	2957
Figure 1-5337	Loosen the thumbscrews	2957
Figure 1-5338	Release the HDD	2958
Figure 1-5339	Remove the HDD	2959
Figure 1-5340	Locate the TPM	2959
Figure 1-5341	Remove the TPM	2960
Figure 1-5342	Recycle and unpack	2960
Figure 1-5343	Install the TPM	2961
Figure 1-5344	Verify that the TPM is fully seated	2961
Figure 1-5345	Install the holder	2962
Figure 1-5346	Release the HDD	2962
Figure 1-5347	Install the cover	2963
Figure 1-5348	Locate the formatter cover	2965
Figure 1-5349	Loosen the thumbscrews	2965
Figure 1-5350	Release the HDD	2966
Figure 1-5351	Remove the HDD	2966
Figure 1-5352	Locate the TPM	2967
Figure 1-5353	Remove the TPM	2967
Figure 1-5354	Recycle and unpack	2968
Figure 1-5355	Install the TPM	2968
Figure 1-5356	Verify that the TPM is fully seated	2969
Figure 1-5357	Install the holder	2969
Figure 1-5358	Release the HDD	2970
Figure 1-5359	Install the cover	2970
Figure 1-5360	Locate the formatter cover	2972
Figure 1-5361	Loosen the thumbscrews	2972
Figure 1-5362	Locate the USB ports module	2973

Figure 1-5363	Disconnect one connector	2973
Figure 1-5364	Disconnect one connector	2974
Figure 1-5365	Disconnect one connector	2974
Figure 1-5366	Remove the module	2975
Figure 1-5367	Recycle and unpack	2975
Figure 1-5368	Install the PCA in the holder	2976
Figure 1-5369	Connect the cable harness	2976
Figure 1-5370	Install the internal USB ports module	2977
Figure 1-5371	Connect one connector	2977
Figure 1-5372	Connect one connector	2978
Figure 1-5373	Connect one connector	2978
Figure 1-5374	Install the cover	2979
Figure 1-5375	Locate the formatter cover	2981
Figure 1-5376	Loosen the thumbscrews	2981
Figure 1-5377	Locate the USB ports module	2982
Figure 1-5378	Disconnect one connector	2982
Figure 1-5379	Remove the module	2983
Figure 1-5380	Recycle and unpack	2983
Figure 1-5381	Install the PCA in the holder	2984
Figure 1-5382	Connect one cable	2984
Figure 1-5383	Position the internal USB ports module	2985
Figure 1-5384	Install the internal USB ports module	2985
Figure 1-5385	Connect one connector	2986
Figure 1-5386	Install the cover	2986
Figure 1-5387	Locate the formatter cover	2988
Figure 1-5388	Loosen the thumbscrews	2988
Figure 1-5389	Locate the fax PCA	2989
Figure 1-5390	Disconnect one connector	2989
Figure 1-5391	Release one latch	2990
Figure 1-5392	Remove the fax PCA	2990
Figure 1-5393	Recycle and unpack	2991
Figure 1-5394	Position the fax PCA	2991
Figure 1-5395	Install the fax PCA	2992
Figure 1-5396	Connect the connector	2992
Figure 1-5397	Install the cover	2993
Figure 2-1	Document feeder and scanner whole units (M577 only)	3008
Figure 2-2	Covers (M552, M553)	3010
Figure 2-3	Covers (M577)	3012
Figure 2-4	Internal components (1 of 5)	3014
Figure 2-5	Internal components (2 of 5)	3016
Figure 2-6	Internal components (3 of 5)	3018

Figure 2-7	Internal components (4 of 5)	3020
Figure 2-8	Internal components (5 of 5)	3022
Figure 2-9	550-sheet paper feeder covers	3024
Figure 2-10	550-sheet paper feeder main body	3026

1 Removal and replacement

- [For additional service and support](#)
- [Removal and replacement strategy](#)
- [Service approach](#)
- [Removal and replacement procedures](#)

For additional service and support

HP service personnel, go to the Service Access Work Bench (SAW) at <http://h41302.www4.hp.com/km/saw/home.do>.

Channel partners, go to HP Channel Services Network (CSN) at <https://h30125.www3.hp.com/hpcsn>.

At these locations, find information on the following topics:

- Install and configure
- Printer specifications
- Up-to-date control panel message (CPMD) troubleshooting
- Solutions for printer issues and emerging issues
- Remove and replace part instructions and videos
- Service advisories
- Warranty and regulatory information

To access HP PartSurfer information from any mobile device, go to <http://partsurfermobile.hp.com/> or scan the Quick Response (QR) code below.



Removal and replacement strategy

Introduction

The printer uses a field repair strategy. Defective parts are diagnosed and replaced at the Field Replaceable Unit (FRU) assembly level. Repair normally begins by using the printer internal diagnostics and the following two-step process:

1. Isolate the problem to the major system (for example, the network, server, or printer).
2. Identify the cause of failures according to the printer troubleshooting service manual and follow the disassembly procedures to replace the defective parts or the consumable parts.

After locating a faulty part, the printer can usually be repaired at the assembly level by replacing FRUs. Some mechanical assemblies might need to be repaired at the subassembly level. HP does not support replacement of components on the printed circuit assemblies.

The user replaces toner cartridges as they are depleted. Additional instructions about other user-replaceable parts are provided in this section.

The printer tracks the amount of use on the user-replaceable supplies by keeping a page count. The printer prompts the user to replace certain items when a supply is depleted or a specific number of pages has been printed.

Swapping toner cartridges between products might cause a misrepresentation of supply life values and is not recommended.

Considerations during removal and replacement

This chapter describes the FRUs only.

Replacing FRUs is generally the reverse of removal. Notes are included to provide directions for difficult or critical replacement procedures.

HP does not support repairing individual subassemblies or troubleshooting to the printed-circuit assembly (PCA) component level.

 **WARNING!** Never operate or service the printer with the protective cover removed from the laser scanner assembly. The reflected beam, although invisible, can cause damage to the eyes.

The sheet-metal parts can have sharp edges. Be careful when handling sheet-metal parts.

Turn the printer off, wait 5 seconds, and then remove the power cord before attempting to service the printer. *If this warning is not followed, severe injury can result as well as damage to the printer.* The power must be on for certain functional checks during troubleshooting. However, the power cord must be disconnected during parts removal. AC voltage is still present inside the printer when the power switch is in the off position. The power cord must be *disconnected* before servicing the printer.

 **CAUTION:** Incorrectly routed or loose wire harnesses might interfere with other internal components or assemblies and be damaged, pinched, or frayed. Make sure that wire harnesses are correctly routed and retained when installing assemblies.

Do not bend or fold the flat flexible cables (FFCs) during removal or installation.

Do not expose the toner cartridge, or cartridges, to strong light even for a short time.

 **IMPORTANT:** When an assembly is removed that includes a rating plate or tag (or a printer code label), make sure to transfer the plate or tag (or code label) to the replacement assembly.

Do not replace the formatter, DC controller, and eMMC PCA or hard-disk drive simultaneously during a single printer servicing. Doing so might cause the printer to become unstable or inoperable.

 **NOTE:** During assembly removal and replacement, or if the printer is moved, remove the toner cartridge or cartridges.

Toner is a non-poisonous substance composed of plastic and a small number of colored components. If toner gets on the skin or clothing, wipe it off with dry tissue paper and wash in cold water. Hot water sets toner and it might be difficult, or impossible, to remove. Toner easily breaks down vinyl materials, so avoid letting toner contact vinyl.

 **NOTE:** The M553 model is pictured in procedures in this manual that might apply to the M552, M553 and M577 models. The procedures are correct for the indicated models.

 **TIP:** Some figures might show assemblies removed or installed that have not yet been removed or installed at that specific step. However, the procedures are correct for this printer and the target assembly. Always thoroughly read the instructions that accompany each figure.

Electrostatic discharge

⚠ CAUTION:  Some parts are sensitive to electrostatic discharge (ESD). Look for the ESD reminder when removing printer parts. Always perform service work at an ESD-protected workstation or mat. If an ESD workstation or mat is not available, touch the sheet-metal chassis to provide a static ground *before* touching an ESD-sensitive assembly.

Protect the ESD-sensitive assemblies by placing them in ESD pouches when they are out of the printer.

Required tools

- #2 Phillips screwdriver with a magnetic tip and a 152-mm (6-in) shaft length
- Small, flat-blade screwdriver
- Needle-nose pliers
- ESD strap (if one is available)
- Penlight

⚠ CAUTION: Always use a #2 Phillips screwdriver (callout 1). Do not use a Pozidriv screwdriver (callout 2) or any motorized screwdriver. These can damage screws or screw threads.

Figure 1-1 Screwdrivers

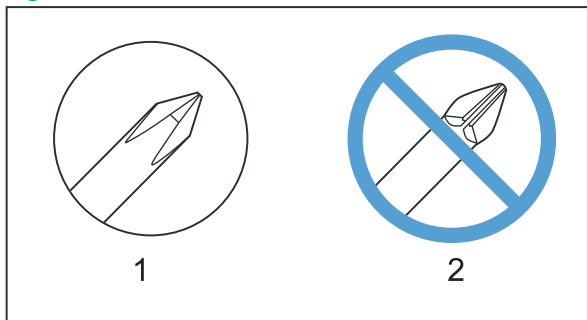

Fasteners used in this printer

⚠ WARNING! Make sure that assemblies are replaced with the correct screw type. Using the incorrect screw (for example, substituting a long screw for the correct shorter screw) can cause damage to the printer or interfere with printer operation. Do not intermix screws that are removed from one assembly with the screws that are removed from another assembly.

📝 NOTE: To install a self-tapping screw, first turn it counterclockwise to align it with the existing thread pattern, and then carefully turn it clockwise to tighten. Do not overtighten. If a self-tapping screw hole becomes stripped, repair the screw hole or replace the affected assembly.

Always take note of the length, diameter, color, type, and location of each removed screw. Make sure that screws are installed in their original location during reinstallation.

Fasteners used in the printer

- Screw, BH M3X10
- Screw, with washer, M3X8

- Screw, D M3X8
- Screw, machine, truss head, M3X6

Figure 1-2 Screw size chart

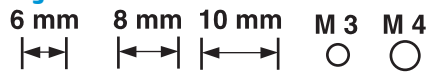

Service approach

Before performing service

 **WARNING!** Turn the printer off, wait 30 seconds, and then remove the power cord before attempting to service the printer. *If this warning is not followed, severe injury and damage to the printer can result.* The power must be on for certain functional checks during troubleshooting. However, the power to the printer should be disconnected during parts removal.

1. Remove all paper.
2. Place the printer on an ESD mat (if available). If an ESD workstation or mat is not available, touch the sheet-metal chassis to provide a static ground *before* touching an ESD-sensitive assembly.
3. Remove the toner cartridge or toner cartridges.
4. Remove the trays.

After performing service

1. Reinstall the toner cartridge or toner cartridges.
2. Reinstall the trays.
3. Return all paper to the trays.
4. Plug in the power cable and turn on the printer.
5. Perform print-quality tests by printing from a host computer.

Post service tests

Print quality test

Use the print-quality troubleshooting pages to help diagnose and solve print-quality problems. For more information, see the printer troubleshooting manual.

 **NOTE:** To get further assistance in print quality troubleshooting, go to www.hp.com/support/colorljM552, www.hp.com/support/colorljM553, www.hp.com/support/colorljM577MFP and select PQ Troubleshooting Tools.

Copy-quality test (M577 models)

1. Verify that you have completed the necessary reassembly steps.
2. Ensure that the input tray contains clean, unmarked paper.
3. With the power cord attached, turn on the printer.
4. Verify that the expected start up sounds occur.
5. Print a configuration page, and then verify that the expected printing sounds occur.
6. Place the configuration page in the document feeder or on the flatbed glass.
7. Print a copy job, and then verify the results.

Fax-quality test (M577 models)

1. Place the configuration page in the document feeder.
2. Type a valid fax number, and send the fax job.
3. Verify that the send quality and the receive quality meet expectations.

Parts removal orientation

For procedures and/or steps that require identifying the right, left, or rear side of the printer, face the front of the printer for correct orientation.

Removal and replacement procedures

Customer self-repair (CSR) A parts and assemblies

- [Removal and replacement: Toner cartridges](#)
- [Removal and replacement: Toner collection unit \(TCU\)](#)
- [Removal and replacement: Staple cartridge \(M577c/f/z\)](#)
- [Removal and replacement: Fuser](#)
- [Removal and replacement: Hard-disk drive \(HDD\) \(M552 and M553\)](#)
- [Removal and replacement: Hard-disk drive \(HDD\) \(M577\)](#)
- [Removal and replacement: Dual in-line memory module \(DIMM; M552 and M553\)](#)
- [Removal and replacement: Dual in-line memory module \(DIMM; M577\)](#)
- [Removal and replacement: embedded MultiMedia Card \(eMMC; M552 and M553\)](#)
- [Removal and replacement: Secondary transfer roller](#)
- [Removal and replacement: Universal Serial Bus \(USB\) cover \(M552 and M553\)](#)
- [Removal and replacement: Hardware Integration Pocket \(HIP\) cover \(M552 and M553\)](#)
- [Removal and replacement: Hardware Integration Pocket \(HIP\) cover \(M577\)](#)
- [Removal and replacement: Control panel \(M553x\)](#)
- [Removal and replacement: Control panel \(M577\)](#)
- [Removal and replacement: Keyboard \(M577c/z\)](#)
- [Removal and replacement: White backing \(M577\)](#)
- [Removal and replacement: Retention clips \(M577\)](#)
- [Removal and replacement: Document feeder rollers \(M577\)](#)

The CSR level indicates the expected difficulty the customer will experience when removing and replacing an assembly. The CSR A assemblies in this section are easy for the customer to remove and replace.

Removal and replacement: Toner cartridges

- [Introduction](#)
- [Step 1: Remove the toner cartridges](#)
- [Step 2: Unpack the replacement assembly](#)
- [Step 3: Install a toner cartridge](#)

Introduction

This document provides instructions about removing and replacing toner cartridges.

Before performing service

⚠ CAUTION: To prevent damage to a toner cartridge, do not expose it to light for more than a few minutes. Cover the green imaging drum if the toner cartridge must be removed from the printer for an extended period of time.

If toner gets on the skin or clothing, wipe it off with dry tissue paper and wash in cold water. Hot water sets toner and it might be difficult, or impossible, to remove.

Use the table below to identify the correct part number for your printer. To order the part, go to www.hp.com/buy/parts.

Toner cartridge kit part numbers	
CF360-67901	Standard-capacity replacement black toner cartridge with instruction guide
CF360-67902	High-capacity replacement black toner cartridge with instruction guide
CF361-67901	Standard-capacity replacement cyan cartridge with instruction guide
CF361-67902	High-capacity replacement cyan toner cartridge with instruction guide
CF362-67901	Standard-capacity replacement yellow toner cartridge with instruction guide
CF362-67902	High-capacity replacement yellow toner cartridge with instruction guide
CF363-67901	Standard-capacity replacement magenta toner cartridge with instruction guide
CF363-67902	High-capacity replacement magenta toner cartridge with instruction guide

Required tools

No special tools are required to install this part.

After performing service

Make sure that the front door is fully closed after replacing a toner cartridge.

Post service test

The color-band test page shows bands of colors that can indicate whether the printer is producing colors correctly.

1. From the Home screen on the printer control panel, open the **Administration** menu.
2. Open the following menus:
 - **Troubleshooting**
 - **Print Quality Pages**
 - **Color Band Test**
3. Select the **Print** or **OK** button to print the pages.

Step 1: Remove the toner cartridges

1. Open the front door.

Figure 1-3 Open the front door

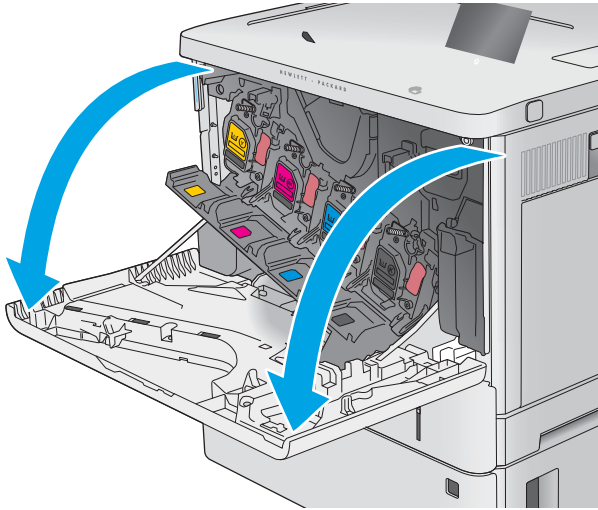

2. Grasp the handle of the used toner cartridge and pull out to remove it.

Figure 1-4 Remove the toner cartridge

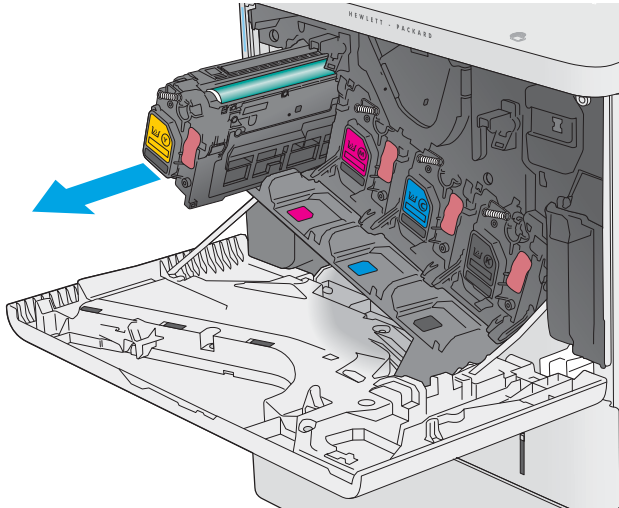

Step 2: Unpack the replacement assembly

Remove the new toner cartridge from its protective shell by tearing off the plastic strip and opening the package. Save all packaging for recycling the used toner cartridge.

For complete information on HP's recycling programs, go to [Product return and recycling](#).

CAUTION: To prevent damage to a replacement toner cartridge, do not expose it to light for more than a few minutes. Cover the green imaging drum if the toner cartridge must be removed from the printer for an extended period of time.

If toner gets on the skin or clothing, wipe it off with dry tissue paper and wash in cold water. Hot water sets toner and it might be difficult, or impossible, to remove.

NOTE: HP recommends responsible disposal of the defective assembly.

Figure 1-5 Recycle and unpack

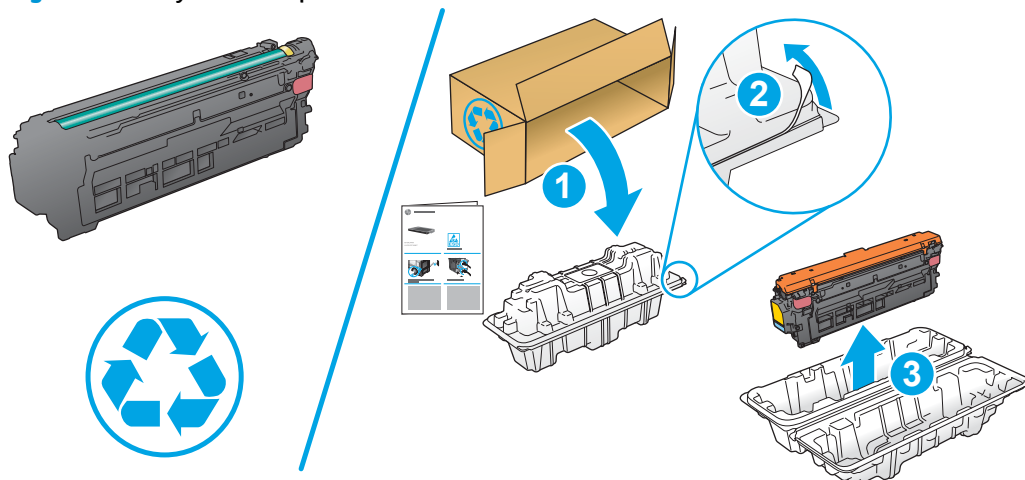

Step 3: Install a toner cartridge

1. Hold both ends of the toner cartridge and rock it 5-6 times.

Figure 1-6 Rock the toner cartridge

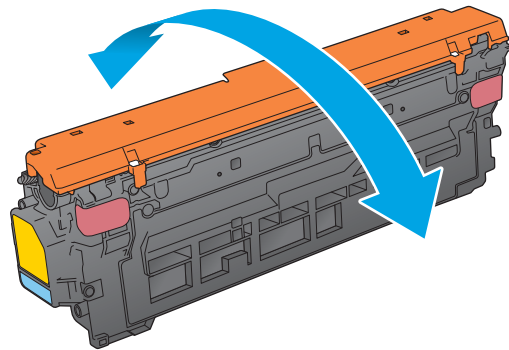

2. Remove the protective shield from the toner cartridge.

Figure 1-7 Remove the protective shield

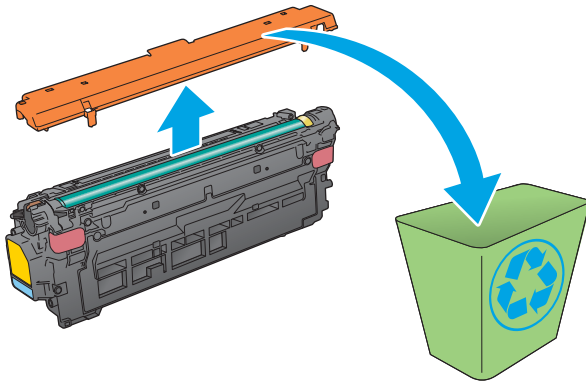

3. Support the toner cartridge underneath with one hand while holding the cartridge handle with the other. Align the toner cartridge with its slot on the shelf, and then insert the toner cartridge into the printer.

 **NOTE:** Avoid touching the green imaging drum. Fingerprints on the imaging drum can cause print defects.

Figure 1-8 Install a toner cartridge



4. Close the front door.

Figure 1-9 Close the front door

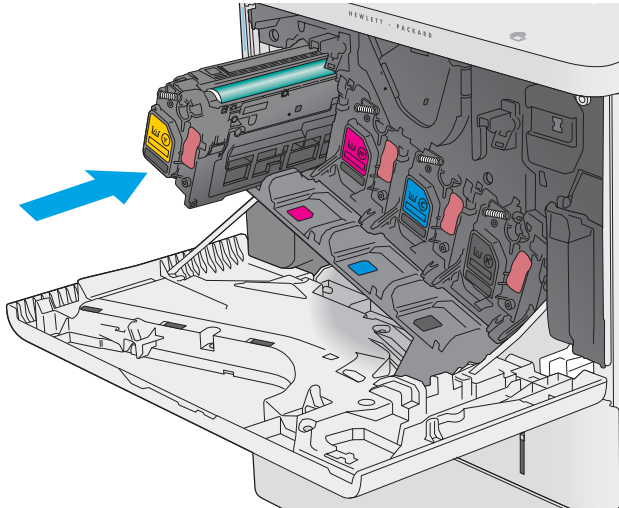
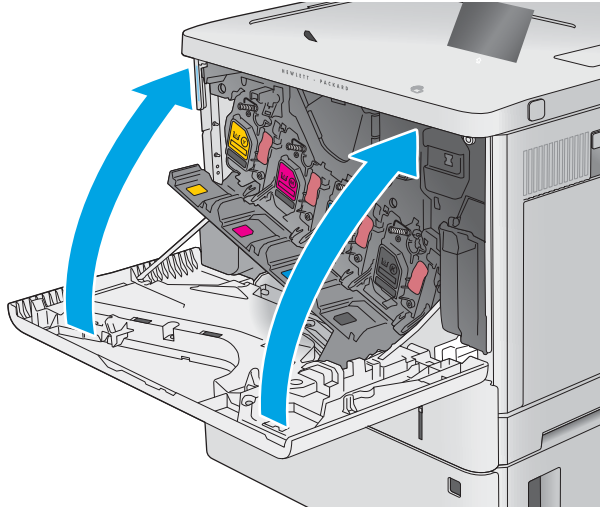

Removal and replacement: Toner collection unit (TCU)

- [Introduction](#)
- [Step 1: Remove the TCU](#)
- [Step 2: Unpack the replacement assembly](#)
- [Step 3: Install the TCU](#)

Introduction

This document provides the procedures to remove and replace the toner collection unit (TCU).

Before performing service

 **CAUTION:** If toner gets on the skin or clothing, wipe it off with dry tissue paper and wash in cold water. Hot water sets toner and it might be difficult, or impossible, to remove.

Use the table below to identify the correct part number for your printer. To order the part, go to www.hp.com/buy/parts.

Toner collect unit (TCU) kit part number	
--	--

B5L37-67901	Toner collection unit (TCU) with instruction guide
--------------------	--

Required tools

No special tools are required to install this part.

After performing service

Make sure that the TCU is fully closed after replacing it.

Step 1: Remove the TCU

1. Open the front door.

Figure 1-10 Open the front door



2. Open the TCU.

 **NOTE:** The toner collection hatch cover automatically closes when the TCU is opened.

Figure 1-11 Open the TCU



3. Pull the TCU away from the printer at an angle to remove it.

⚠ CAUTION: Do not open the toner collection hatch cover when handling the TCU. If toner gets on the skin or clothing, wipe it off with dry tissue paper and wash in cold water. Hot water sets toner and it might be difficult, or impossible, to remove.

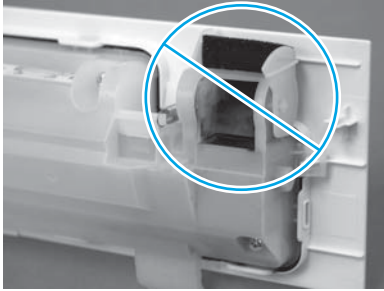
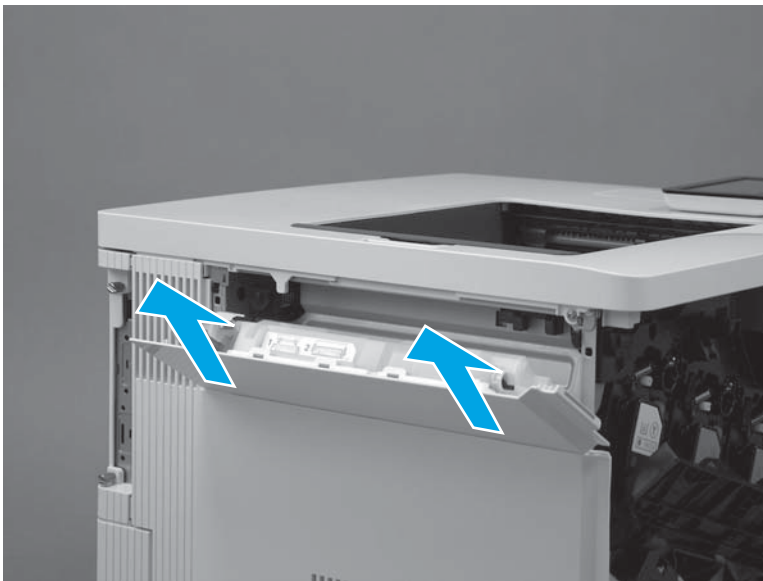

Figure 1-12 Remove the TCU



Step 2: Unpack the replacement assembly

Unpack the replacement assembly from the packaging.

For complete information on HP's recycling programs, go to [Product return and recycling](#).

📝 NOTE: HP recommends responsible disposal of the defective assembly.

Figure 1-13 Recycle and unpack

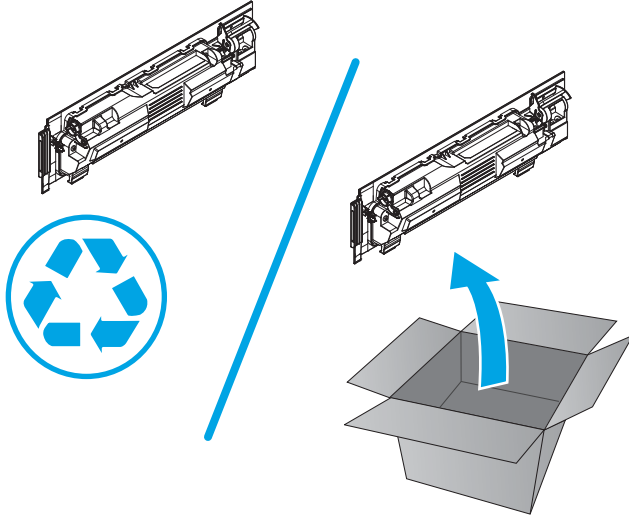

Step 3: Install the TCU

1. Verify that the toner collection hatch cover is in the closed position on the TCU.

Figure 1-14 Verify that the toner collection hatch cover is closed

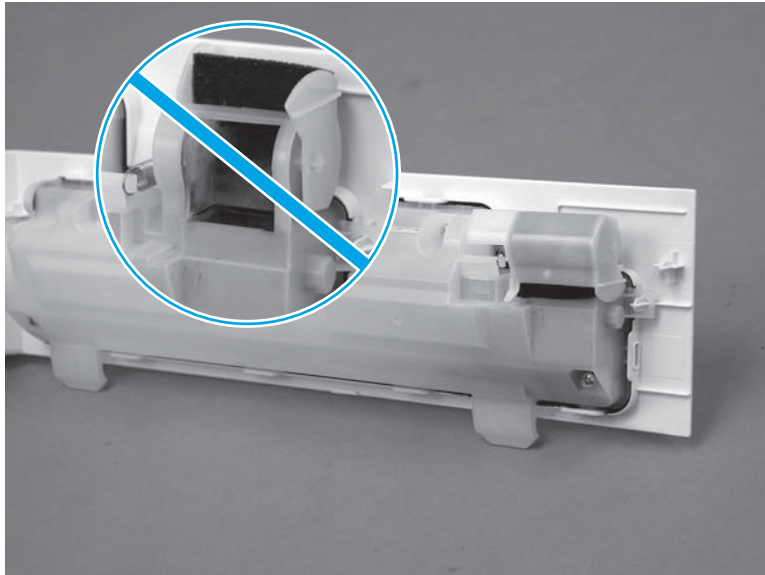

2. Position the TCU with the hinges in the slots provided in the printer (callout 1), and then rotate the TCU up and into the closed position.

 **NOTE:** The toner collection hatch cover automatically opens when the TCU is closed.

Figure 1-15 Install the TCU



3. Close the front door.

Figure 1-16 Close the front door

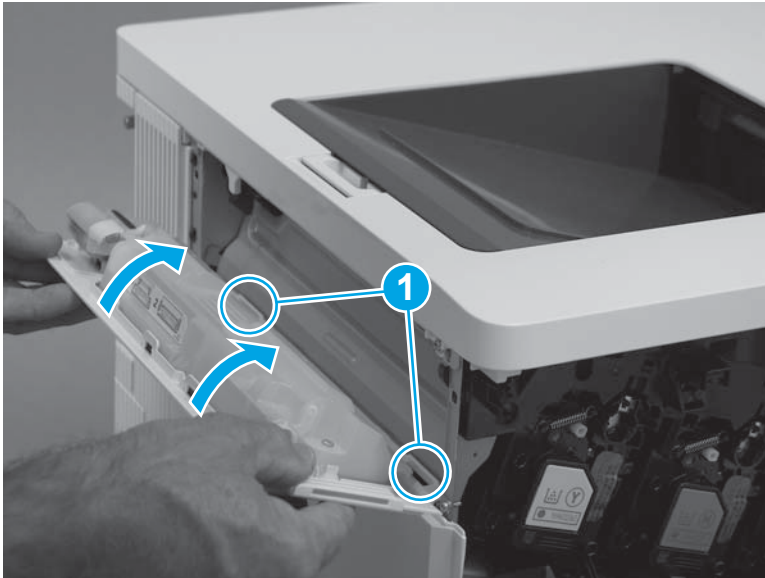

Removal and replacement: Staple cartridge (M577c/f/z)

- [Introduction](#)
- [Step 1: Remove the staple cartridge](#)
- [Step 2: Unpack the replacement assembly](#)
- [Step 3: Install the staple cartridge](#)

Introduction

This document provides the procedures to remove and replace the M577c/f/z staple cartridge.

Before performing service

Turn the printer power off

- Disconnect the power cable.

 **WARNING!** To avoid damage to the printer, turn the printer off, wait 30 seconds, and then remove the power cord before attempting to service the printer.

Use the table below to identify the correct part number for your printer. To order the part, go to www.hp.com/buy/parts.

Staple cartridge part number	
Q7432A	HP staple cartridge pack

Required tools

- No special tools are required to remove this part.

After performing service

Make sure that the stapler door is fully closed after replacing a staple cartridge.

Turn the printer power on

- Connect the power cable.
- Use the power switch to turn the power on.

Post service test

Make sure that the printer initializes to a **Ready** state.

Step 1: Remove the staple cartridge

1. Open the stapler door.

Figure 1-17 Open the stapler door



2. Pull the staple cartridge straight out of the printer to remove it.

Figure 1-18 Remove the staple cartridge



Step 2: Unpack the replacement assembly

Unpack the replacement assembly from the packaging.

For complete information on HP's recycling programs, go to [Product return and recycling](#).

 **NOTE:** HP recommends responsible disposal of the defective assembly.

Figure 1-19 Recycle and unpack

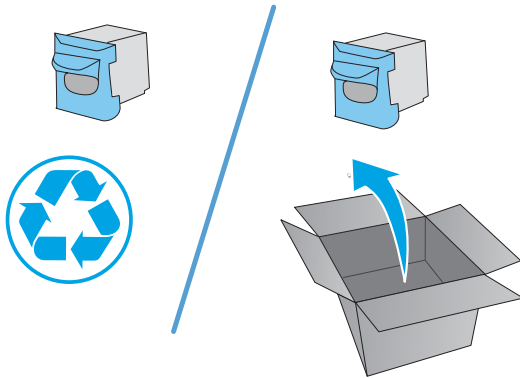

Step 3: Install the staple cartridge

1. Push the staple cartridge straight into the printer to install it.

Figure 1-20 Install the staple cartridge



2. Close the stapler door.

Figure 1-21 Close the stapler door



Removal and replacement: Fuser

- [Introduction](#)
- [Step 1: Remove the fuser](#)
- [Step 2: Unpack the replacement assembly](#)
- [Step 3: Install the fuser](#)
- [Step 4: Reset the fuser counter](#)

Introduction

This document provides the procedures to remove and replace the fuser.

Before performing service

Turn the printer power off

- Disconnect the power cable.

 **WARNING!** To avoid damage to the printer, turn the printer off, wait 30 seconds, and then remove the power cord before attempting to service the printer.

Use the table below to identify the correct part number for your printer. To order the part, go to www.hp.com/buy/parts.

Fuser kit part numbers	
B5L35-67902	Fuser (110V) with instruction guide
B5L36-67902	Fuser (220V) with instruction guide

Required tools

No special tools are required to install this part.

After performing service

Make sure that the right door is fully closed after replacing the fuser.

Turn the printer power on

- Connect the power cable.
- Use the power switch to turn the power on.

Post service test

Print a configuration page to make sure that the printer is functioning correctly.

Step 1: Remove the fuser

1. Open the right door.

CAUTION: The fuser is very hot. After turning the printer power off, allow the fuser to cool for at least 30 minutes before removing it.

Figure 1-22 Open the right door



2. Grasp the two fuser handles, and then squeeze the two blue triggers on the handles to release the fuser.

Figure 1-23 Release the fuser

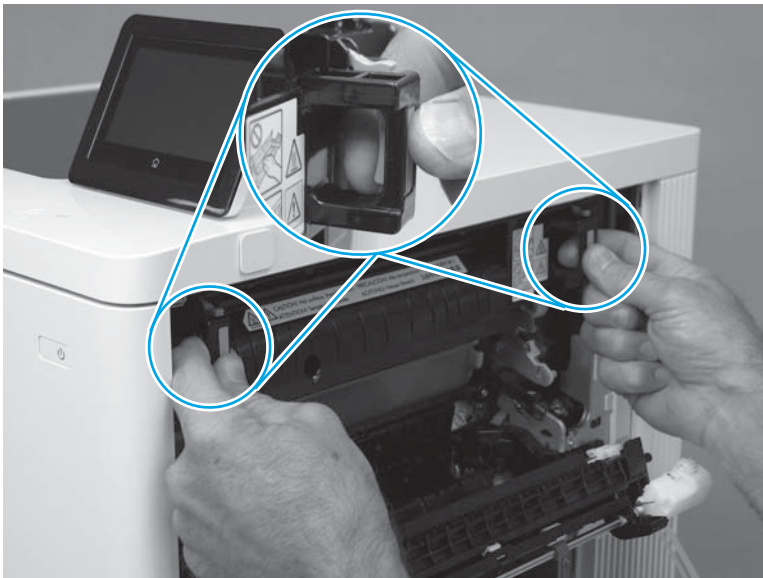

3. Slide the fuser straight out of the printer to remove it.

Figure 1-24 Remove the fuser



Step 2: Unpack the replacement assembly

Unpack the replacement assembly from the packaging.

For complete information on HP's recycling programs, go to [Product return and recycling](#).

 **NOTE:** HP recommends responsible disposal of the defective assembly.

Figure 1-25 Recycle and unpack

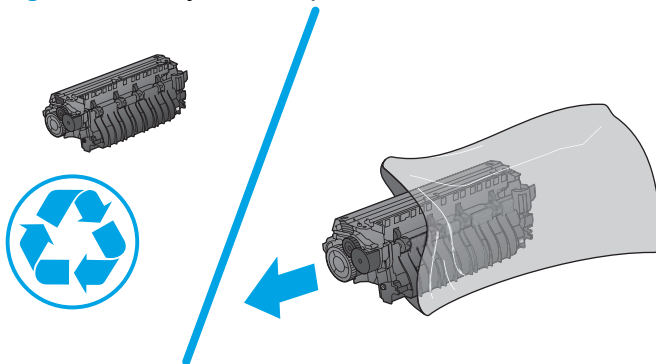

Step 3: Install the fuser

1. Align the fuser with the opening in the printer.

Figure 1-26 Align the fuser with the opening

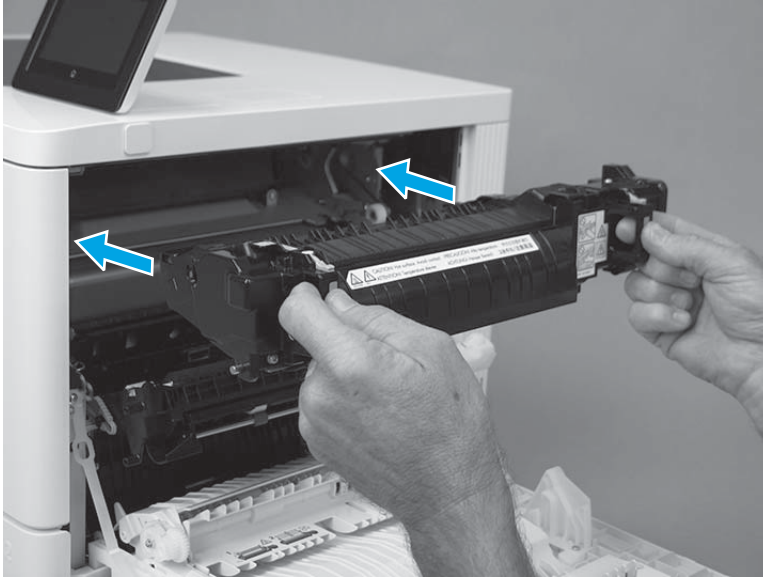

2. Slide the fuser into the printer, push in to install it, and then make sure that it is fully seated.

 **TIP:** When the fuser is fully seated, the two blue triggers on the handles make an audible click.

Figure 1-27 Install the fuser



3. Close the right door.

Figure 1-28 Close the right door

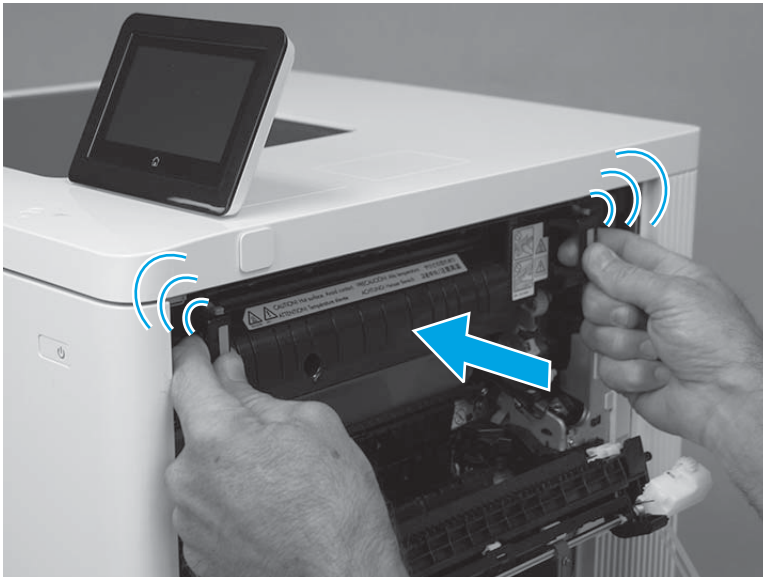

Step 4: Reset the fuser counter

Reset the fuser counter from a touchscreen control panel

1. From the **Home** screen on the printer control panel, scroll to and touch the **Administration** button.
2. Open the following menus:
 - **Manage Supplies**
 - **Reset Supplies**
 - **New Fuser Kit**
3. Select the **Yes** item to reset the fuser counter.

Reset the fuser counter from an LCD control panel

1. From the **Home** screen on the printer control panel, use the down arrow ▼ button to scroll to **Administration**, and then press the **OK** button.
2. Use the down arrow ▼ button to scroll to **Manage Supplies**, and then press the **OK** button.
3. Use the down arrow ▼ button to scroll to **Reset Supplies**, and then press the **OK** button.
4. Use the down arrow ▼ button to scroll to **New Fuser Kit**, and then press the **OK** button to select it.
5. Use the down arrow ▼ button to scroll to **Yes**, and then press the **OK** button to reset the fuser count.

Removal and replacement: Hard-disk drive (HDD) (M552 and M553)

- [Introduction](#)
- [Step 1: Remove the formatter cover](#)
- [Step 2: Remove the hard-disk drive \(HDD\)](#)
- [Step 3: Unpack the replacement assembly](#)
- [Step 4: Install the hard-disk drive \(HDD\)](#)
- [Step 5: Install the formatter cover](#)
- [Step 6: Reinstall the product firmware](#)

Introduction



This document provides the procedures to remove and replace the M553 hard-disk drive (HDD).

Before performing service

Turn the printer power off

- Disconnect the power cable.

 **WARNING!** To avoid damage to the printer, turn the printer off, wait 30 seconds, and then remove the power cord before attempting to service the printer.

 **CAUTION:**  This part contains components that are electrostatic discharge (ESD) sensitive. To reduce the possibility of ESD damage, always touch the sheet-metal chassis to ground yourself before touching an ESD sensitive part.

 **IMPORTANT:** Do not replace the formatter, DC controller, and eMMC PCA or hard-disk drive simultaneously during a single printer servicing. Doing so might cause the printer to become unstable or inoperable.

Use the table below to identify the correct part number for your printer. To order the part, go to www.hp.com/buy/parts.

Hard-disk drive (HDD) kit part number (M553)

B5L29-67903

Hard-disk drive (HDD) with instruction guide (M553)

Required tools

- No special tools are required to remove this part.

After performing service

Make sure that the formatter cover is fully seated, and that the thumbscrews are finger tight after replacing it.

Turn the printer power on

- Connect the power cable.
- Use the power switch to turn the power on.

Post service test

Print a configuration page to make sure that the printer is functioning correctly.

Step 1: Remove the formatter cover

1. Locate the formatter cover.

Figure 1-29 Locate the formatter cover

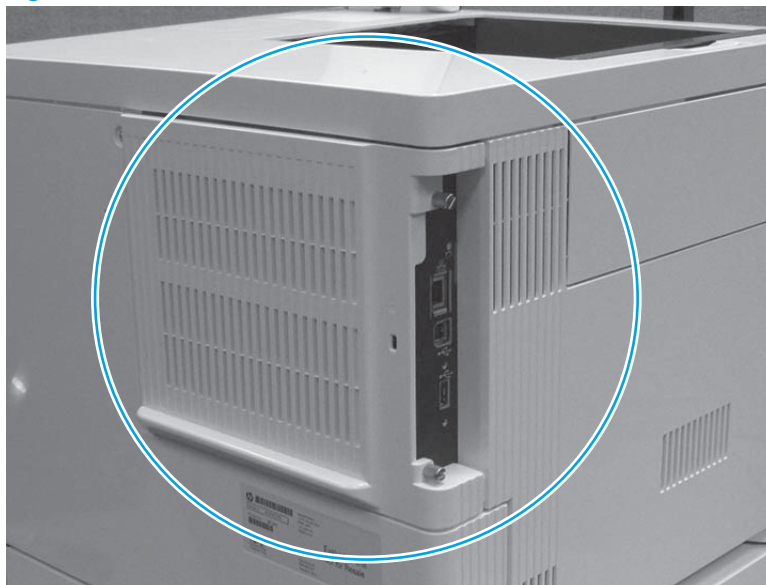

2. Loosen the two thumbscrews (callout 1). Grasp the two thumbscrews, and then slide the cover away from the printer (callout 2) to remove it.

 **TIP:** If needed, use the edge of a coin to turn the thumbscrews.

Figure 1-30 Loosen the thumbscrews



Step 2: Remove the hard-disk drive (HDD)

 **CAUTION:**  ESD-sensitive part.

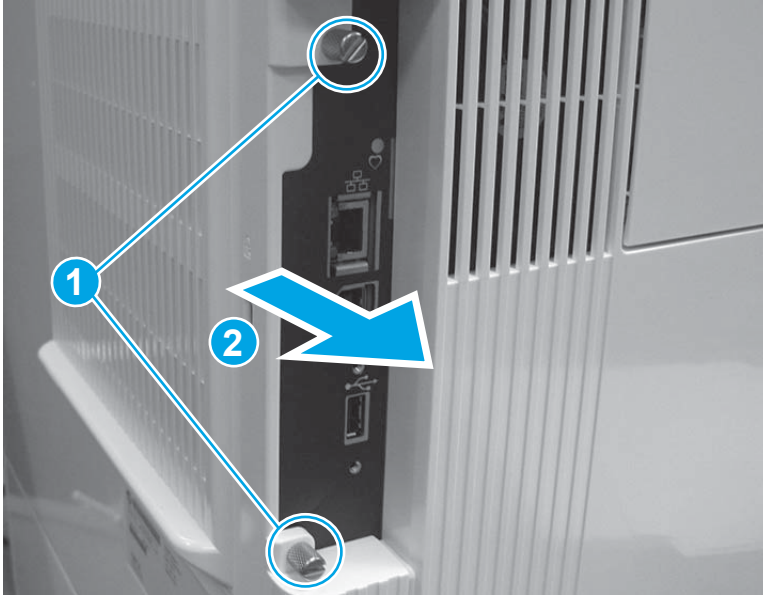
1. Release one tab (callout 1), grasp the HDD mounting bracket, and then rotate the connector end of the bracket up (callout 2) and away from the formatter to release it.

Figure 1-31 Release the HDD

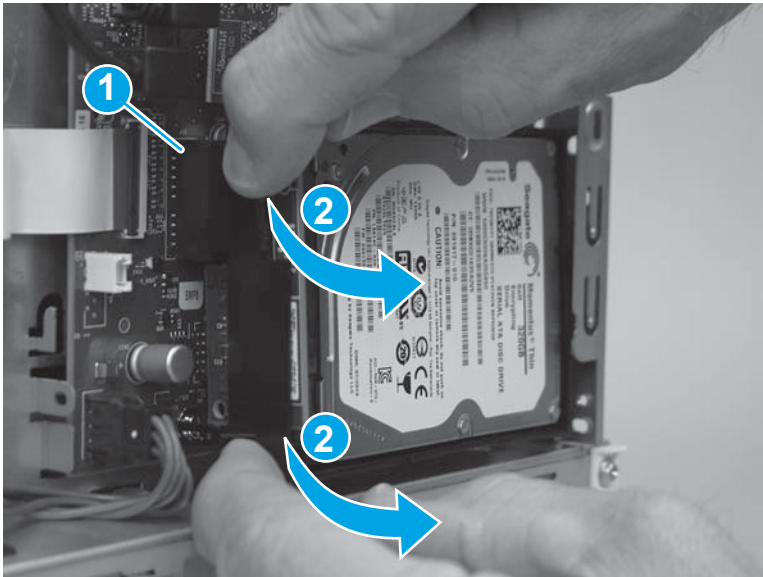

2. Slide the HDD away from the printer to remove it.

Figure 1-32 Remove the HDD

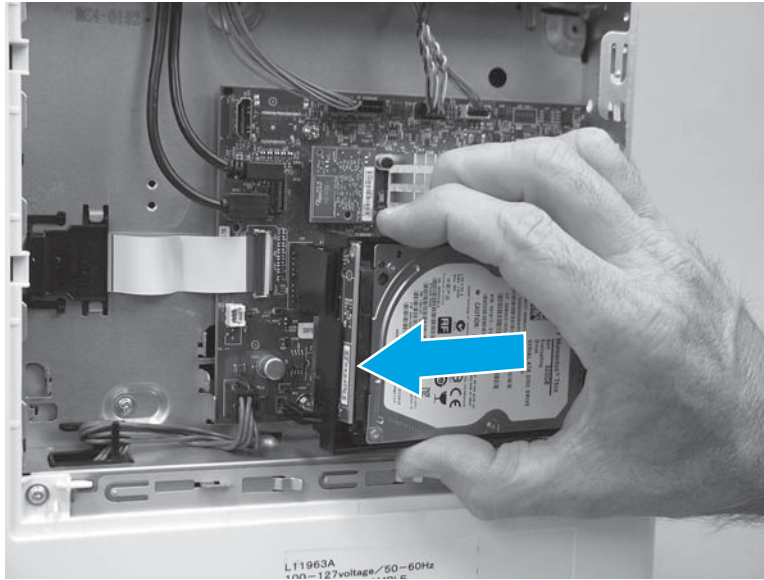

Step 3: Unpack the replacement assembly

Unpack the replacement assembly from the packaging.

 **CAUTION:**  ESD-sensitive part.

For complete information on HP's recycling programs, go to [Product return and recycling](#).

 **NOTE:** HP recommends responsible disposal of the defective assembly.

Figure 1-33 Recycle and unpack

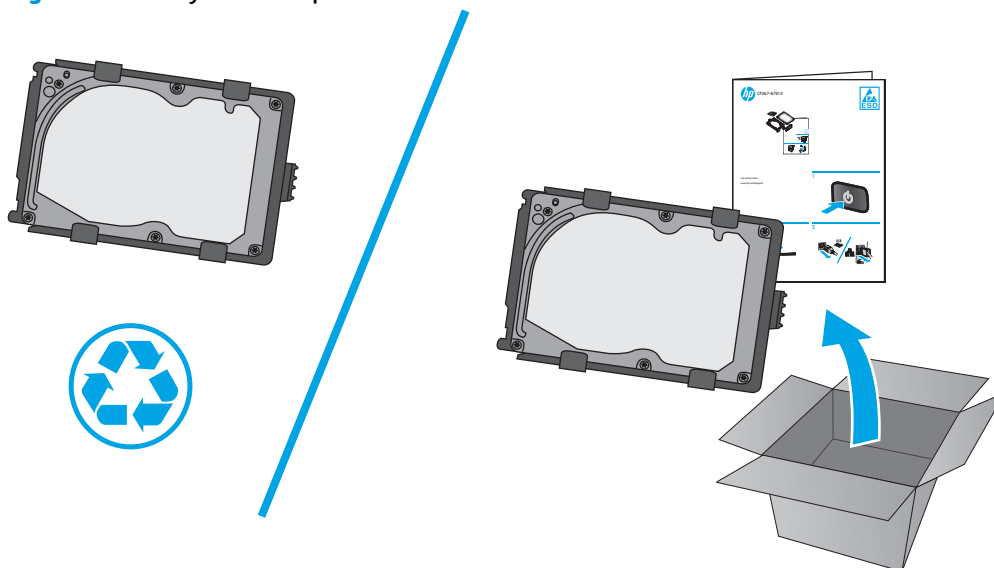

Step 4: Install the hard-disk drive (HDD)

 **CAUTION:**  ESD-sensitive part.

1. Align the end of the holder (callout 1) with the slot in the chassis (callout 2), and then slide the HDD into the printer (callout 3) to engage the holder with the chassis.

 **TIP:** If this is the first time the HDD is being installed, remove the pre-scored label that covers the slot in the chassis (callout 2).

Figure 1-34 Install the holder



2. Rotate the HDD connector (callout 1) down and into the connectors (callout 2) on the formatter to install it.

 **NOTE:** Make sure that the tabs (callout 2) snap into place, and that the HDD is securely installed.

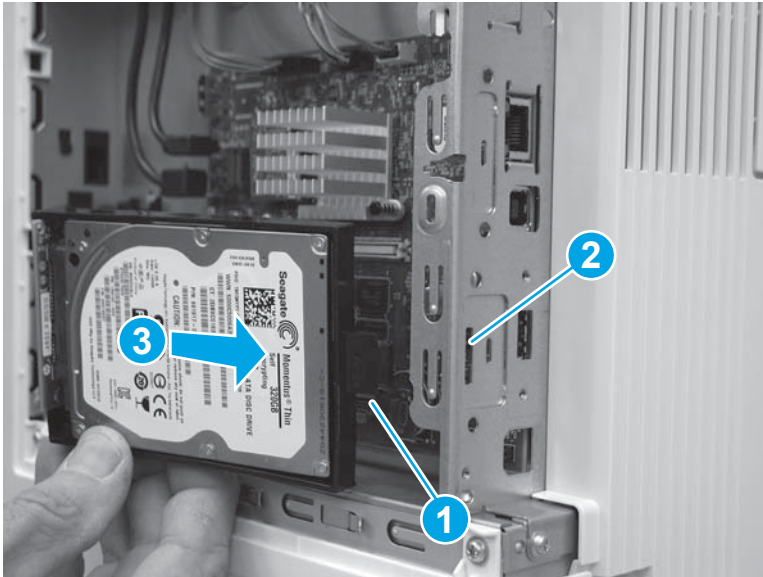
Figure 1-35 Release the HDD

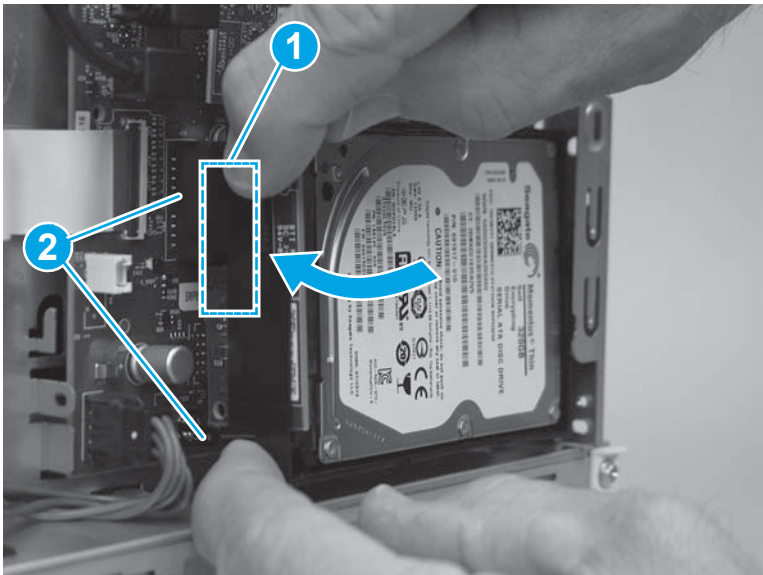

Step 5: Install the formatter cover

- ▲ Slide the cover onto the printer (callout 1) to install it.

 **NOTE:** Make sure that the tabs on the formatter cover align with the slots provided in the printer (callout 2). Tighten the two thumbscrews (callout 3).

 **TIP:** If needed, use the edge of a coin to turn the thumbscrews.

Figure 1-36 Install the cover



Step 6: Reinstall the product firmware

 **NOTE:** If this installation is a replacement HDD, use the following steps to reinstall the firmware.

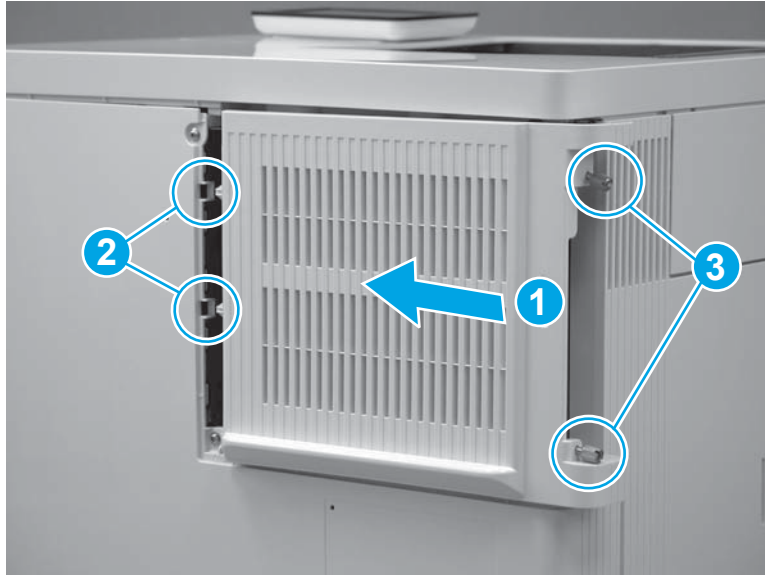
1. Go to www.hp.com/go/futuresmart.
2. Select **Upgrade now**.
3. Find your Enterprise printer model.
4. Select the link to open the firmware download page.
5. Select **OS Independent** from the list of operating systems.
6. Under the **Firmware** section, find the file for multiple operating systems.
7. Select **Download**.

 **NOTE:** To view installation instructions, go to www.hp.com/go/futuresmart. Select **Upgrade now**, and then select **How to perform a firmware update**.

Removal and replacement: Hard-disk drive (HDD) (M577)

- [Introduction](#)
- [Step 1: Remove the formatter cover](#)
- [Step 2: Remove the hard-disk drive \(HDD\)](#)
- [Step 3: Unpack the replacement assembly](#)
- [Step 4: Install the hard-disk drive \(HDD\)](#)
- [Step 5: Install the formatter cover](#)
- [Step 6: Reinstall the product firmware](#)

Introduction



This document provides the procedures to remove and replace the M557 hard-disk drive (HDD).

Before performing service

Turn the printer power off

- Disconnect the power cable.

 **WARNING!** To avoid damage to the printer, turn the printer off, wait 30 seconds, and then remove the power cord before attempting to service the printer.

 **CAUTION:**  This part contains components that are electrostatic discharge (ESD) sensitive. To reduce the possibility of ESD damage, always touch the sheet-metal chassis to ground yourself before touching an ESD sensitive part.

 **IMPORTANT:** Do not replace the formatter, DC controller, and eMMC PCA or hard-disk drive simultaneously during a single printer servicing. Doing so might cause the printer to become unstable or inoperable.

Use the table below to identify the correct part number for your printer. To order the part, go to www.hp.com/buy/parts.

Hard-disk drive (HDD) kit part number (M577)

5851-6712

Hard-disk drive (HDD) with instruction guide (M577)

Required tools

- No special tools are required to remove this part.

After performing service

Make sure that the formatter cover is fully seated, and that the thumbscrews are finger tight after replacing it.

Turn the printer power on

- Connect the power cable.
- Use the power switch to turn the power on.

Post service test

Print a configuration page to make sure that the printer is functioning correctly.

Step 1: Remove the formatter cover

1. Locate the formatter cover.

Figure 1-37 Locate the formatter cover

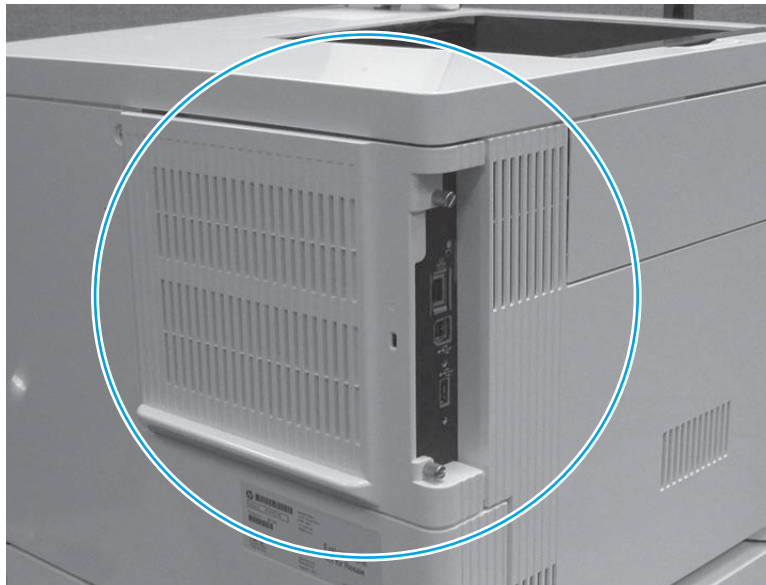

2. Loosen the two thumbscrews (callout 1). Grasp the two thumbscrews, and then slide the cover away from the printer (callout 2) to remove it.

 **TIP:** If needed, use the edge of a coin to turn the thumbscrews.

Figure 1-38 Loosen the thumbscrews



Step 2: Remove the hard-disk drive (HDD)

 **CAUTION:**  ESD-sensitive part.

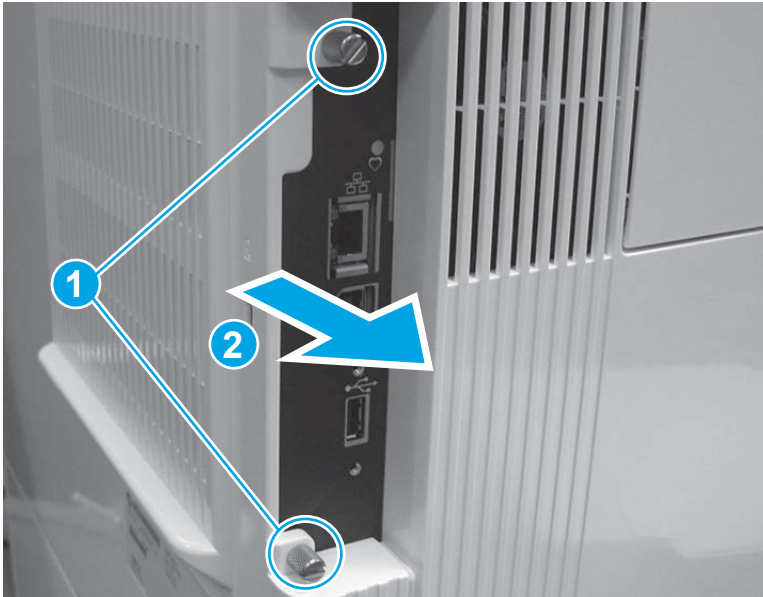
1. Release two tabs (callout 1). Hold the tabs in the released position, and then rotate the hard disk drive (HDD) up (callout 2) to release the connector from the formatter.

Figure 1-39 Release the HDD

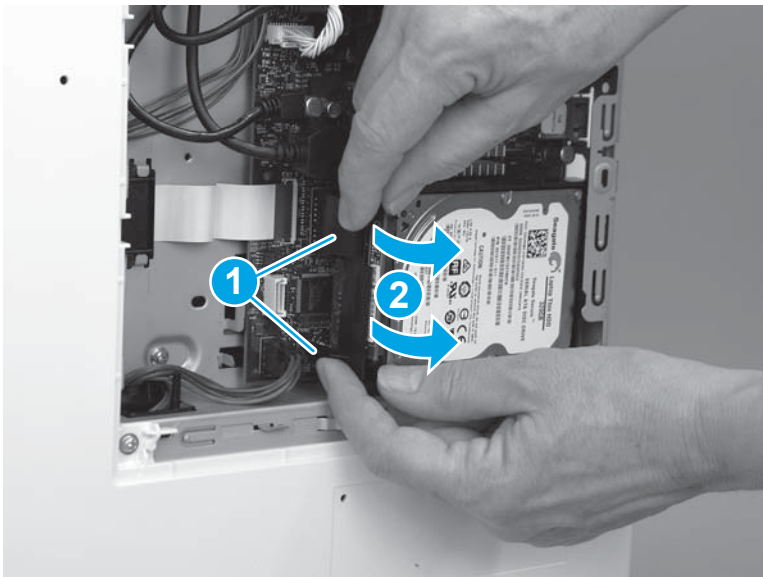

2. Slide the HDD away from the printer to remove it.

Figure 1-40 Remove the HDD

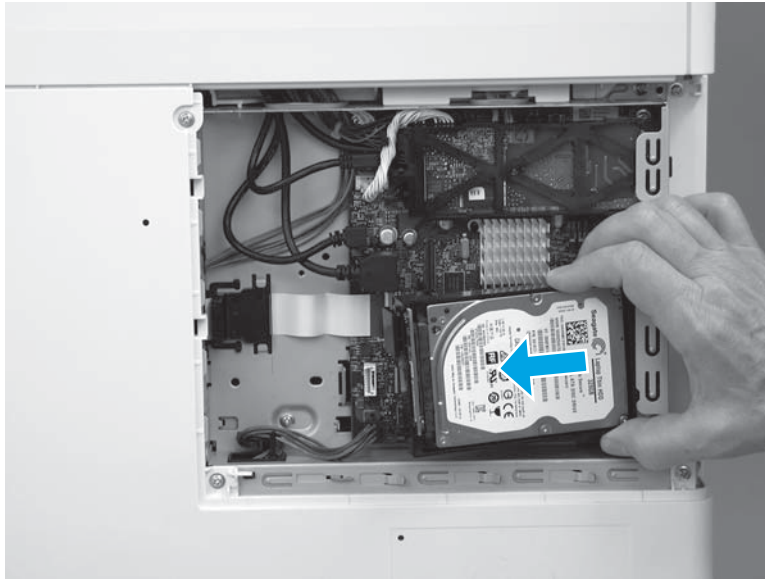

3. Using the screwdriver provided with the replacement HDD, remove two screws (callout 1). Save these screws. They will be installed on the replacement HDD.

 **TIP:** The screwdriver has a reversible shaft. Simply pull the shaft out of the handle, and then reinstall it with the desired end facing out.

Figure 1-41 Remove two screws

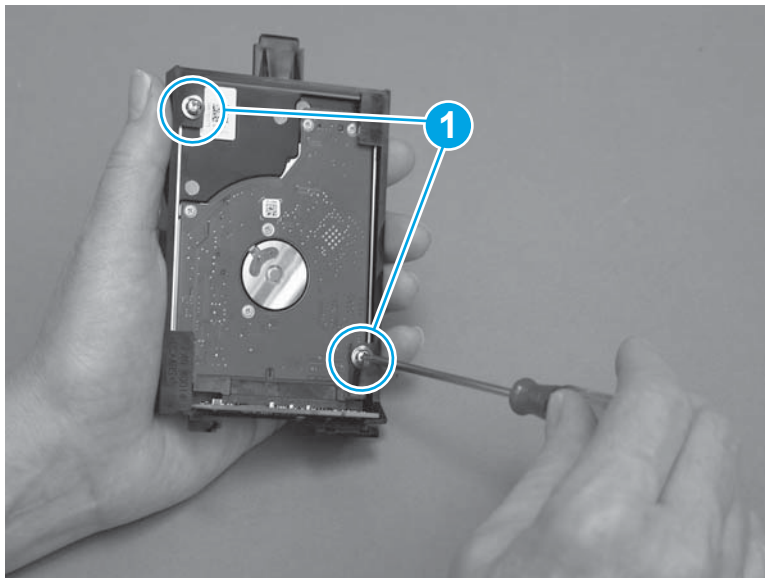

4. Lift the bracket (callout 1) up and off of the HDD. Save this bracket. It will be installed on the replacement HDD.

Figure 1-42 Remove the bracket

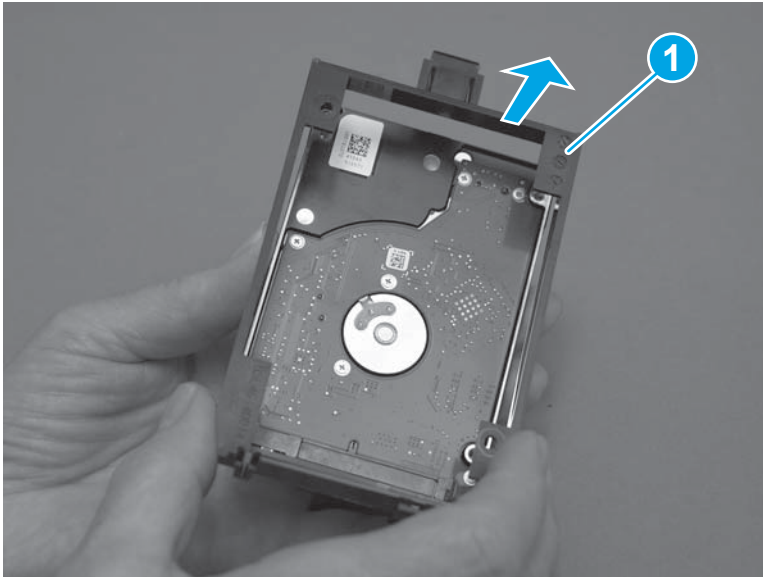

5. Grasp the PCA card (callout 1) attached to the end of the HDD and pull it away from the HDD to remove it. Save this PCA. It will be installed on the replacement HDD.

Figure 1-43 Remove the PCA

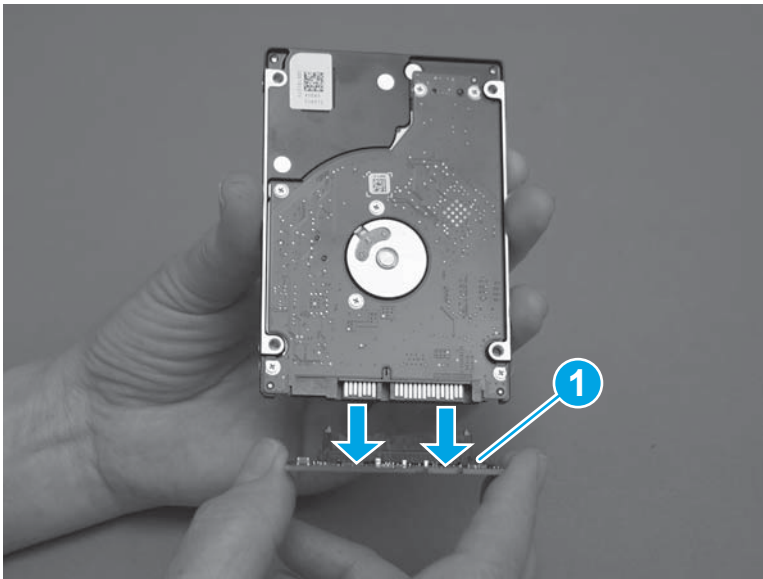

Step 3: Unpack the replacement assembly

 **CAUTION:**  ESD-sensitive part.

Unpack the replacement assembly from the packaging.

For complete information on HP's recycling programs, go to [Product return and recycling](#).

 **NOTE:** HP recommends responsible disposal of the defective assembly.

Figure 1-44 Recycle and unpack

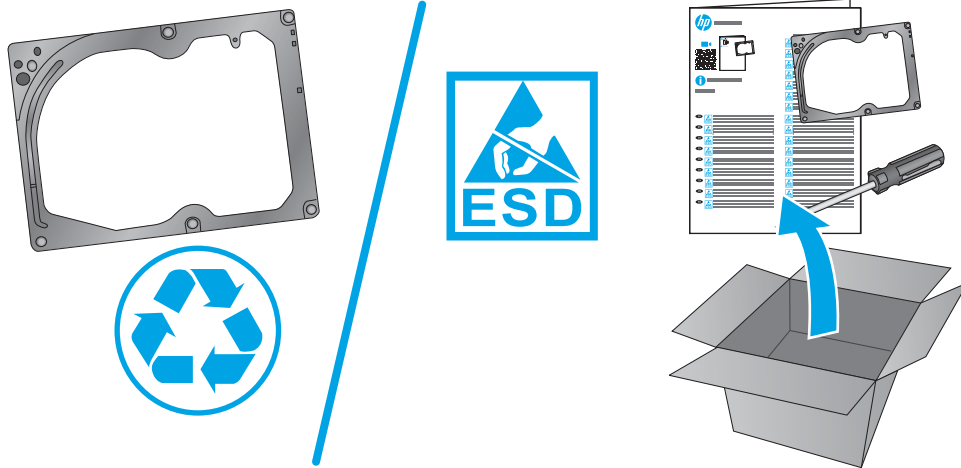

Step 4: Install the hard-disk drive (HDD)

 **CAUTION:**  ESD-sensitive part.

1. Align the slots (callout 1) on the PCA with the connectors (callout 2) on the replacement HDD.

Figure 1-45 Align the PCA

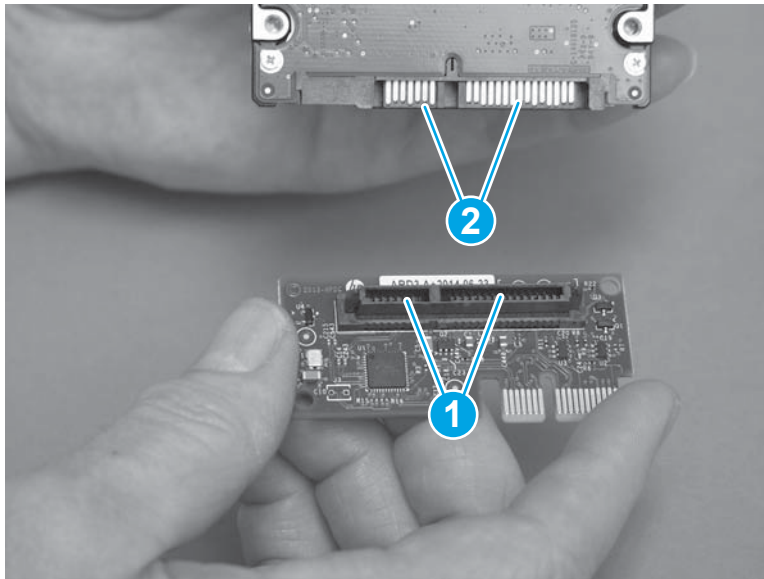

2. Press the PCA onto the HDD connectors. Make sure that the PCA is fully seated on the connectors.

Figure 1-46 Install the PCA

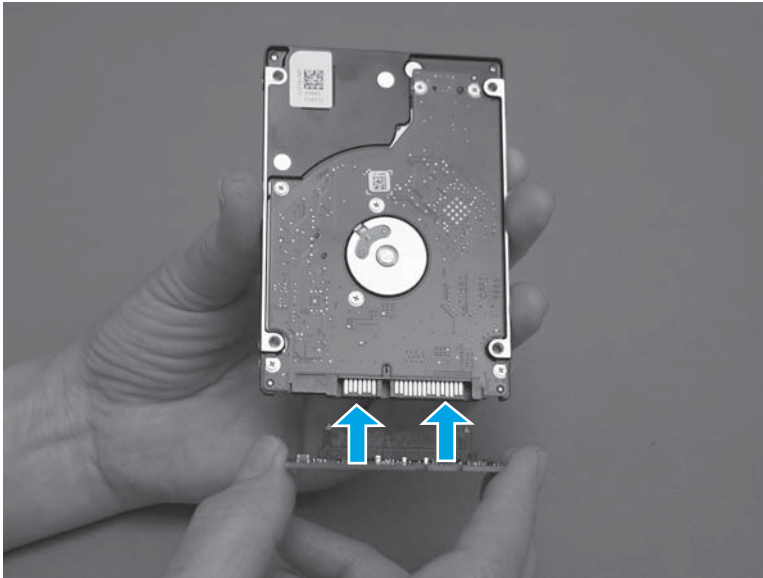

3. Align the tabs (callout 1) on the bracket with the holes (callout 2) in the back side of the HDD.

Figure 1-47 Align the tabs on the bracket

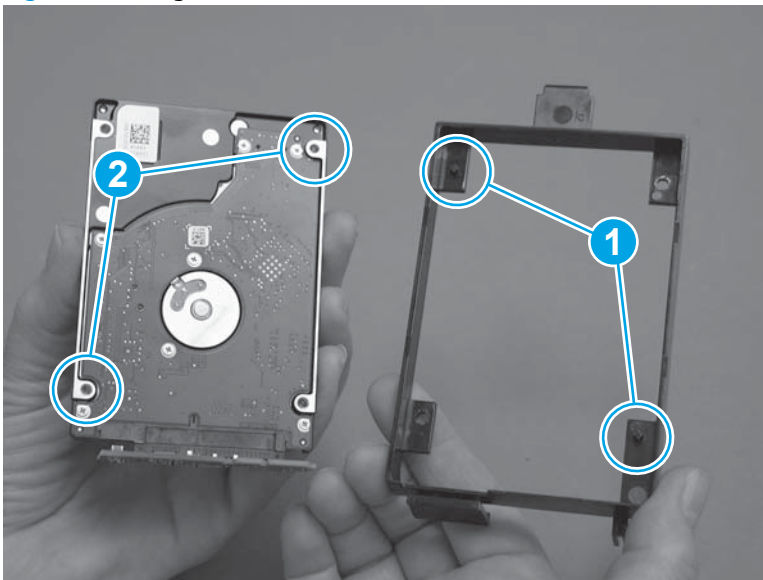

4. Install the bracket on the HDD.

 **NOTE:** If the bracket is difficult to install, make sure that the holes in the HDD are correctly aligned with the tabs on the bracket.

Figure 1-48 Install the bracket



5. Install two screws (callout 1).

 **CAUTION:** Tighten the screws just enough to secure the HDD to the bracket. Do not over-tighten.

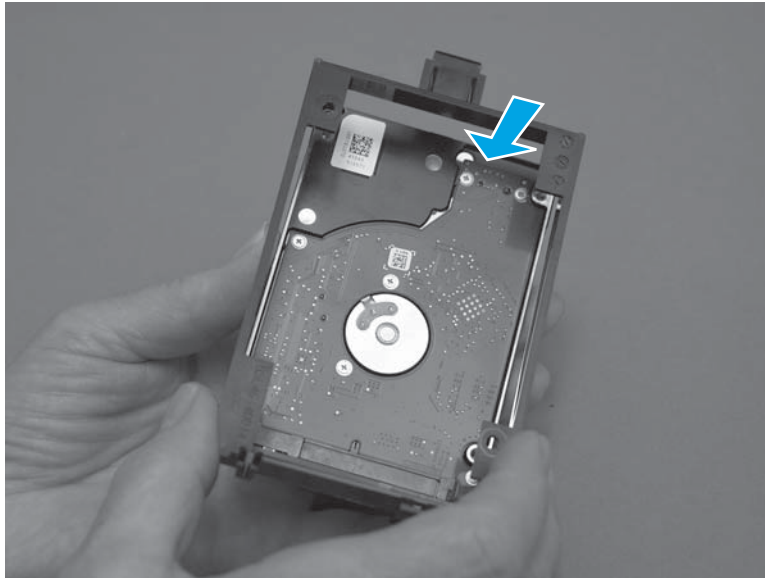
Figure 1-49 Install two screws



6. Align the end of the bracket (callout 1) with the slot in the chassis (callout 2), and then slide the HDD into the printer (callout 3) to engage the bracket with the chassis.

Figure 1-50 Install the holder

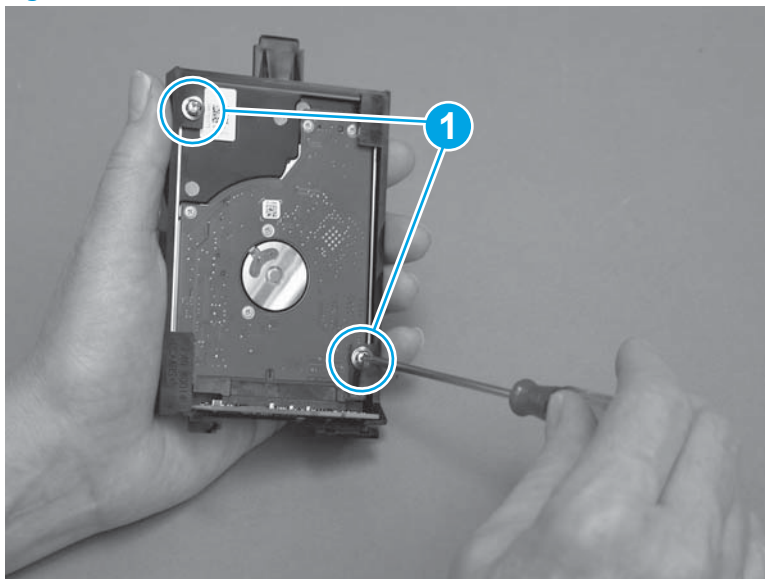
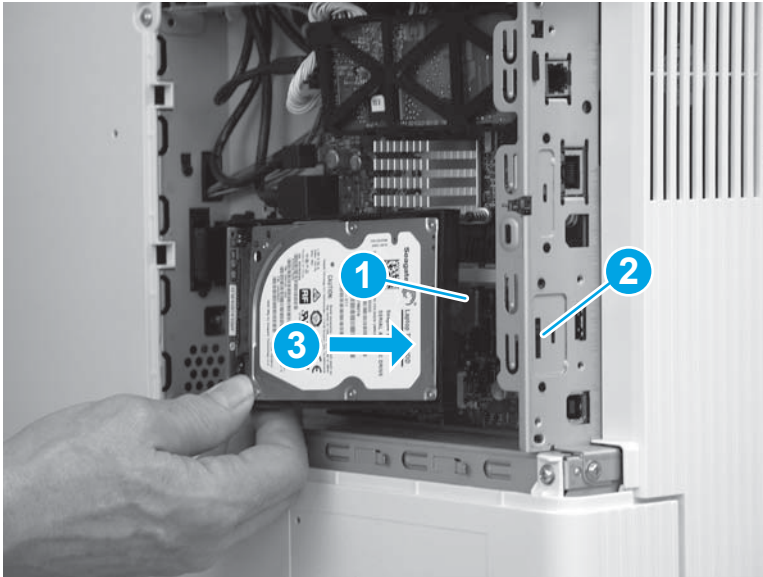

7. Hold the HDD connector latch (callout 1) in the released position, and then rotate the HDD down and into the connector on the formatter to install it.

 **NOTE:** Make sure that the tab (callout 2) snaps into place, and that the HDD is securely installed.

Figure 1-51 Release the HDD

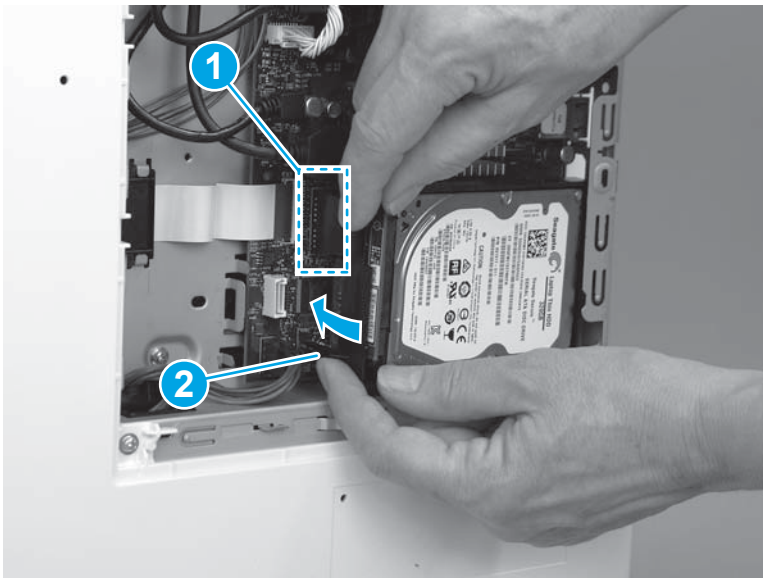

Step 5: Install the formatter cover

- ▲ Slide the cover onto the printer (callout 1) to install it.

 **NOTE:** Make sure that the tabs on the formatter cover align with the slots provided in the printer (callout 2). Tighten the two thumbscrews (callout 3).

 **TIP:** If needed, use the edge of a coin to turn the thumbscrews.

Figure 1-52 Install the cover



Step 6: Reinstall the product firmware

Use the following steps to reinstall the firmware.

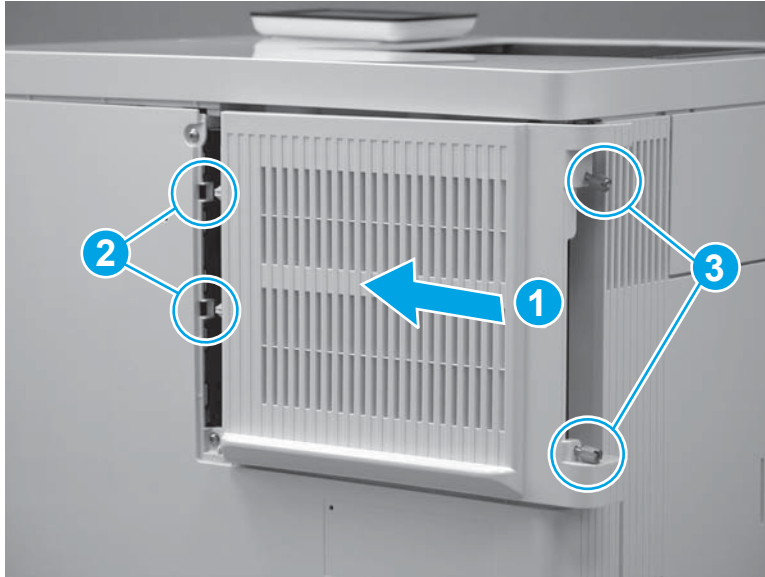
1. Go to www.hp.com/go/futuresmart.
2. Select **Upgrade now**.
3. Find your Enterprise printer model.
4. Select the link to open the firmware download page.
5. Select **OS Independent** from the list of operating systems.
6. Under the **Firmware** section, find the file for multiple operating systems.
7. Select **Download**.

 **NOTE:** To view installation instructions, go to www.hp.com/go/futuresmart. Select **Upgrade now**, and then select **How to perform a firmware update**.

Removal and replacement: Dual in-line memory module (DIMM; M552 and M553)

- [Introduction](#)
- [Step 1: Remove the formatter cover](#)
- [Step 2: Remove the hard-disk drive \(HDD; M552 and M553\)](#)
- [Step 3: Remove the dual in-line memory module \(DIMM\)](#)
- [Step 4: Unpack the replacement assembly](#)
- [Step 5: Install the DIMM](#)
- [Step 6: Install the HDD \(M552 and M553\)](#)
- [Step 7: Install the formatter cover](#)

Introduction



This document provides the procedures to remove and replace the M552 and M553 dual in-line memory module (DIMM).

Before performing service

Turn the printer power off

- Disconnect the power cable.

 **WARNING!** To avoid damage to the printer, turn the printer off, wait 30 seconds, and then remove the power cord before attempting to service the printer.

 **CAUTION:**  This part contains components that are electrostatic discharge (ESD) sensitive. To reduce the possibility of ESD damage, always touch the sheet-metal chassis to ground yourself before touching an ESD sensitive part.

Use the table below to identify the correct part number for your printer. To order the part, go to www.hp.com/buy/parts.

Dual in-line memory module (DIMM) kit part number	
---	--

5851-6422

Dual in-line memory module (DIMM) with instruction guide
--

Required tools

No special tools are required to install this part.

After performing service

Make sure that the formatter cover is fully seated, and that the thumbscrews are finger tight after replacing it.

Turn the printer power on

- Connect the power cable.
- Use the power switch to turn the power on.

Post service test

Print a configuration page to make sure that the printer is functioning correctly.

Step 1: Remove the formatter cover

1. Locate the formatter cover.

Figure 1-53 Locate the formatter cover

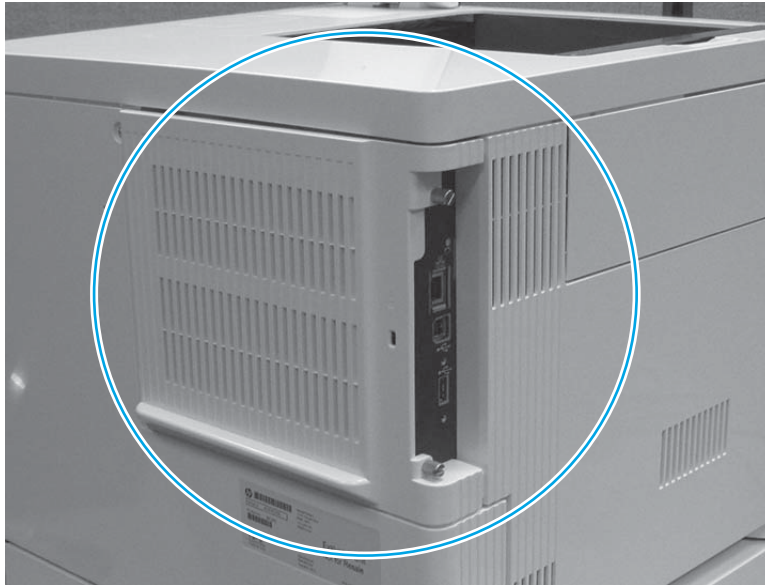

2. Loosen the two thumbscrews (callout 1). Grasp the two thumbscrews, and then slide the cover away from the printer (callout 2) to remove it.



 **TIP:** If needed, use the edge of a coin to turn the thumbscrews.

Figure 1-54 Loosen the thumbscrews

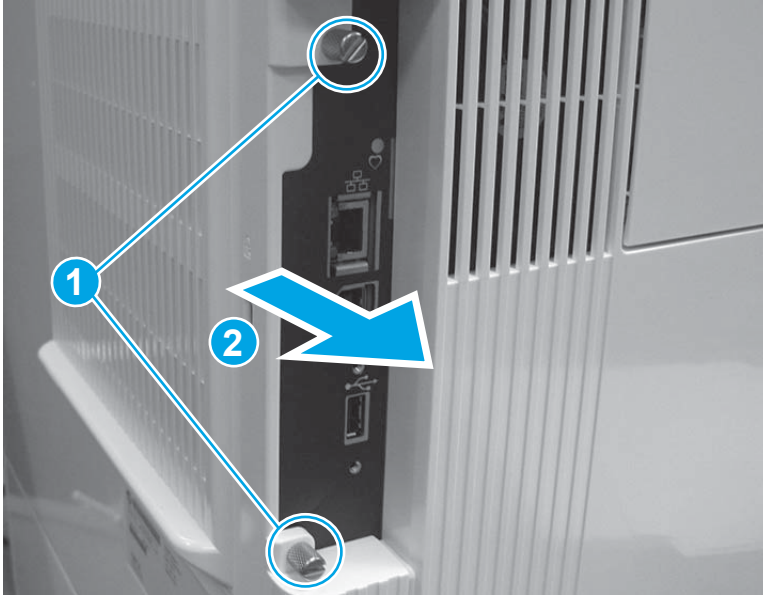

Step 2: Remove the hard-disk drive (HDD; M552 and M553)

 **NOTE:** If the optional HDD is not installed, skip this step and go to [Step 3: Remove the dual in-line memory module \(DIMM\) on page 47](#).

 **CAUTION:**  ESD-sensitive part.

1. Release one tab (callout 1), grasp the HDD mounting bracket, and then rotate the connector end of the bracket up (callout 2) and away from the formatter to release it.

Figure 1-55 Release the HDD

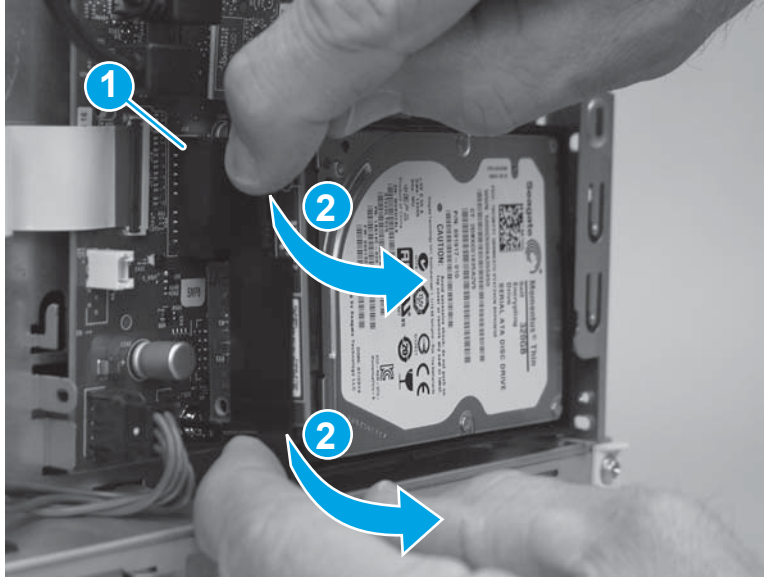

2. Slide the HDD away from the printer to remove it.

Figure 1-56 Remove the HDD

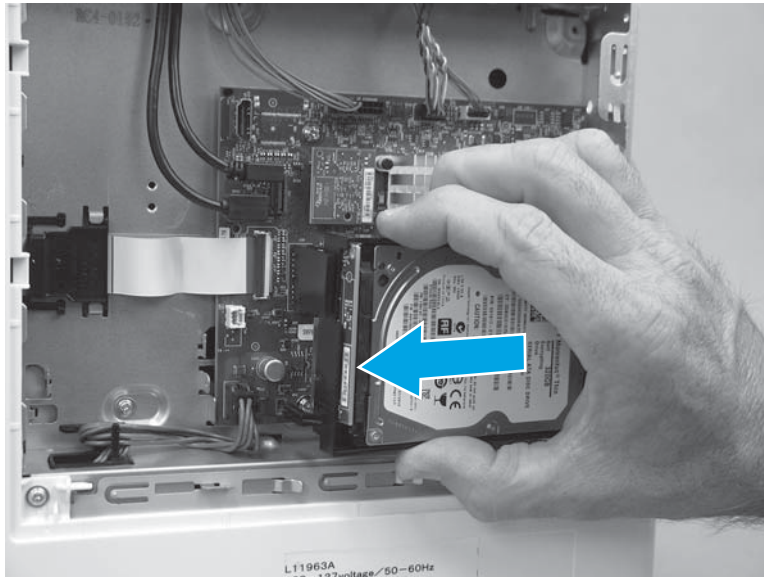

Step 3: Remove the dual in-line memory module (DIMM)

 **CAUTION:**  ESD-sensitive part.

1. Locate the DIMM component on the formatter.

Figure 1-57 Locate the DIMM

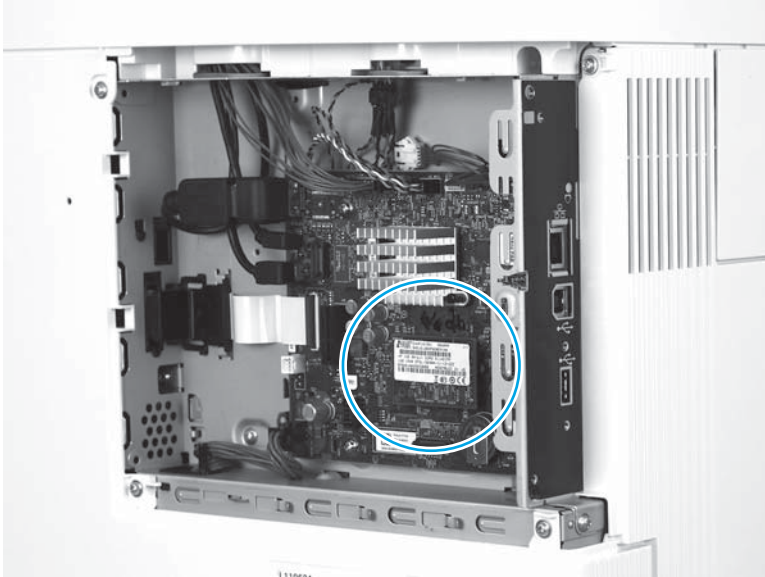

2. Pull the DIMM straight off of the formatter to remove it.

Figure 1-58 Remove the DIMM

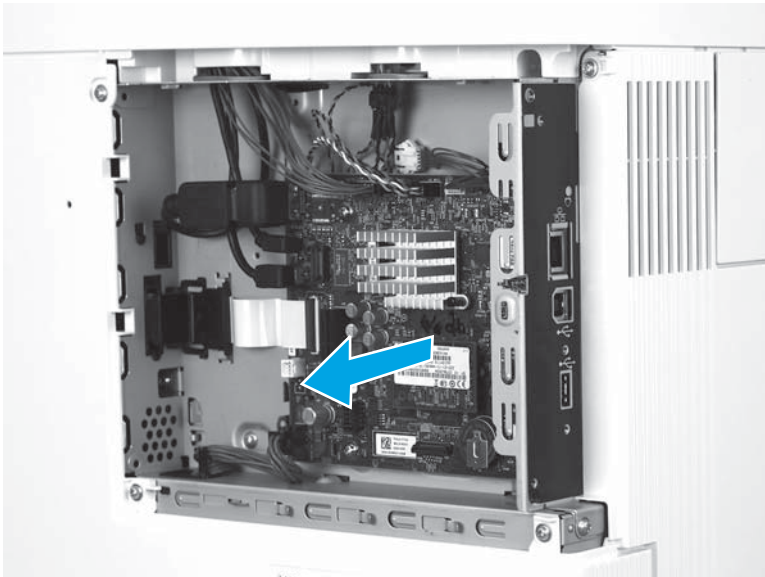

Step 4: Unpack the replacement assembly

Unpack the replacement assembly from the packaging.

 **CAUTION:**  ESD-sensitive part.

For complete information on HP's recycling programs, go to [Product return and recycling](#).

 **NOTE:** HP recommends responsible disposal of the defective assembly.

Figure 1-59 Recycle and unpack

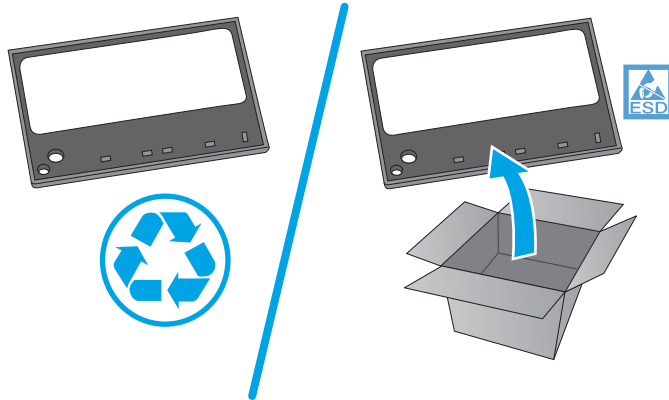

Step 5: Install the DIMM

 **CAUTION:**  ESD-sensitive part.

1. The DIMM connector (callout 1) is keyed, and can only be installed in one direction in the formatter connector (callout 2).

Figure 1-60 The DIMM connector

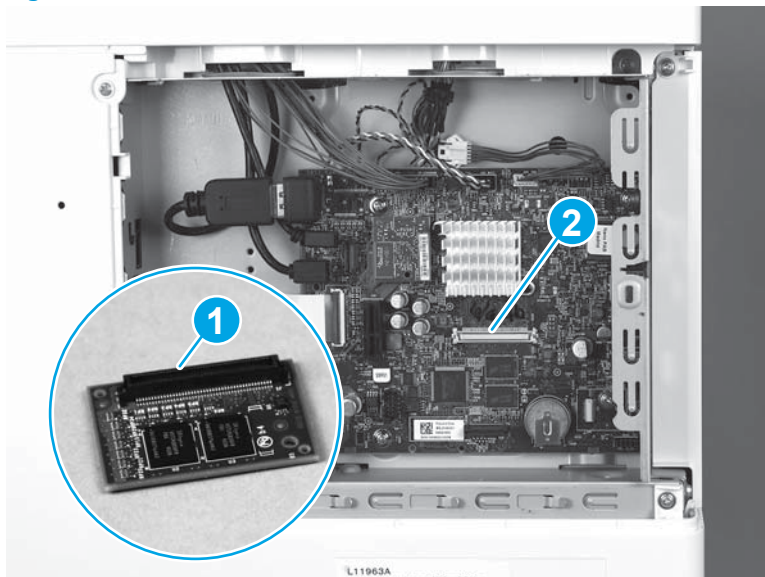

2. Align the connector on the DIMM with the connector on the formatter, and then push the DIMM onto the formatter to install it.

Figure 1-61 Install the DIMM

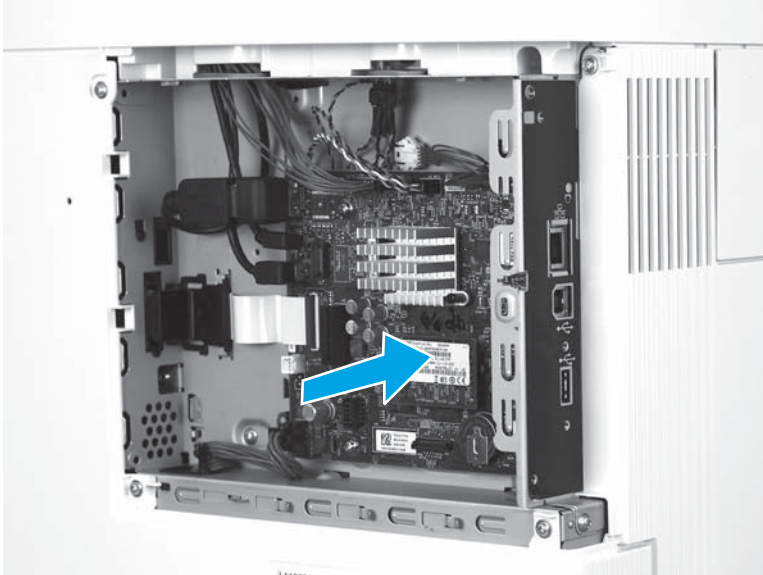

3. Verify that the DIMM is fully seated in the connector.

Figure 1-62 Verify the installation

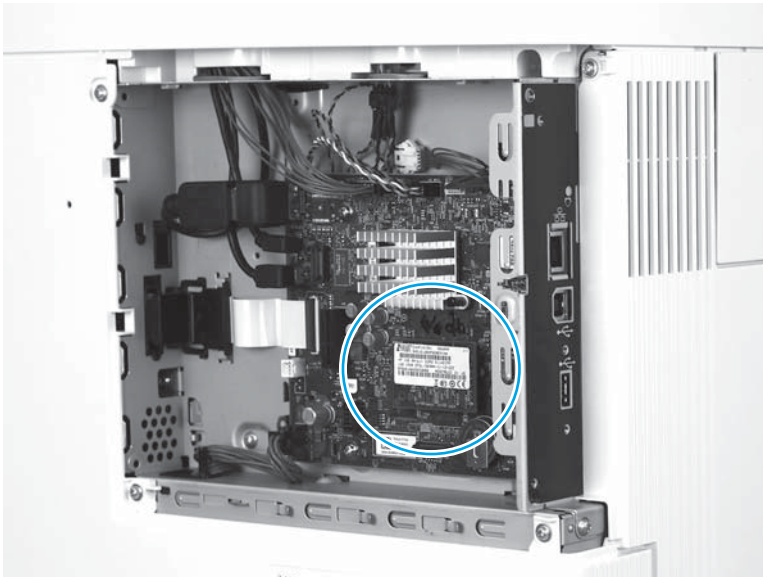

Step 6: Install the HDD (M552 and M553)

 **NOTE:** If the optional HDD is not installed, skip this step and go to [Step 7: Install the formatter cover on page 51](#).

 **CAUTION:**  ESD-sensitive part.

1. Align the end of the holder (callout 1) with the slot in the chassis (callout 2), and then slide the HDD into the printer (callout 3) to engage the holder with the chassis.

Figure 1-63 Install the holder

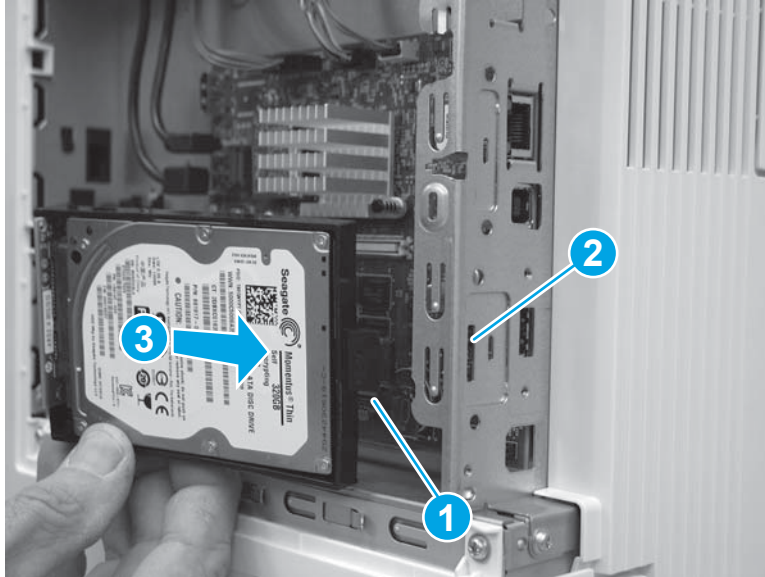

2. Rotate the HDD connector (callout 1) down and into the connector on the formatter to install it.



 **NOTE:** Make sure that the tabs (callout 2) snap into place, and that the HDD is securely installed.

Figure 1-64 Release the HDD

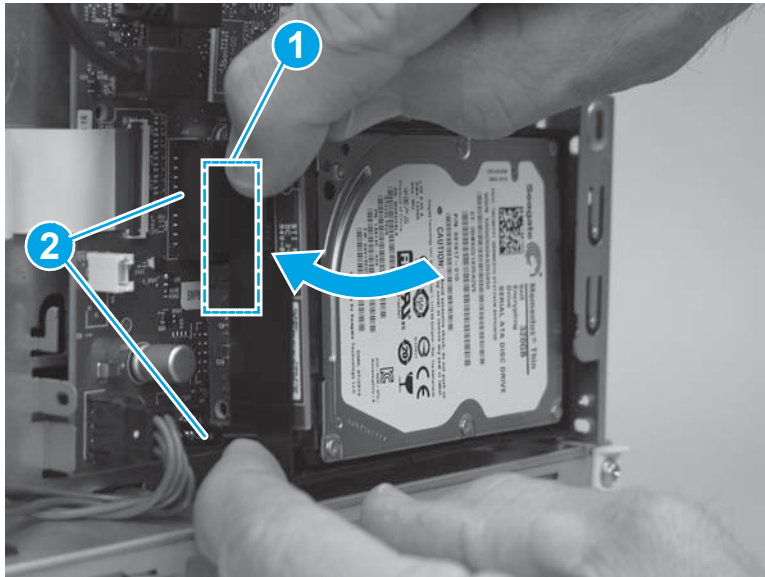

Step 7: Install the formatter cover

- ▲ Slide the cover onto the printer (callout 1) to install it.

 **NOTE:** Make sure that the tabs on the formatter cover align with the slots provided in the printer (callout 2). Tighten the two thumbscrews (callout 3).

 **TIP:** If needed, use the edge of a coin to turn the thumbscrews.

Figure 1-65 Install the cover



Removal and replacement: Dual in-line memory module (DIMM; M577)

- [Introduction](#)
- [Step 1: Remove the formatter cover](#)
- [Step 2: Remove the hard-disk drive \(HDD; M577\)](#)
- [Step 3: Remove the dual in-line memory module \(DIMM\)](#)
- [Step 4: Unpack the replacement assembly](#)
- [Step 5: Install the DIMM](#)
- [Step 6: Install the HDD \(M577\)](#)
- [Step 7: Install the formatter cover](#)

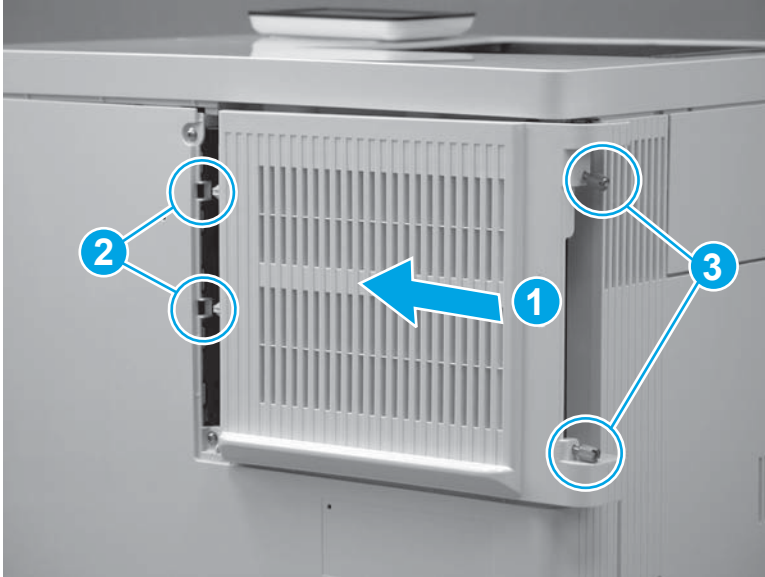
Introduction



This document provides the procedures to remove and replace the M577 dual in-line memory module (DIMM).

Before performing service

Turn the printer power off

- Disconnect the power cable.

 **WARNING!** To avoid damage to the printer, turn the printer off, wait 30 seconds, and then remove the power cord before attempting to service the printer.

 **CAUTION:**  This part contains components that are electrostatic discharge (ESD) sensitive. To reduce the possibility of ESD damage, always touch the sheet-metal chassis to ground yourself before touching an ESD sensitive part.

Use the table below to identify the correct part number for your printer. To order the part, go to www.hp.com/buy/parts.

Dual in-line memory module (DIMM) kit part number	
ESK49-67901	Dual in-line memory module (DIMM) with instruction guide (M577)

Required tools

No special tools are required to install this part.

After performing service

Turn the printer power on

- Connect the power cable.
- Use the power switch to turn the power on.

Post service test

Print a configuration page to make sure that the printer is functioning correctly.

Step 1: Remove the formatter cover

1. Locate the formatter cover.

Figure 1-66 Locate the formatter cover

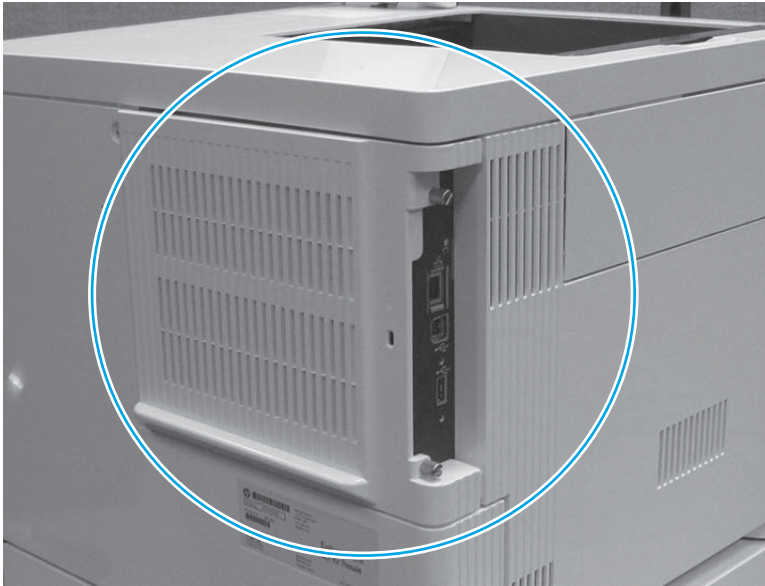

2. Loosen the two thumbscrews (callout 1). Grasp the two thumbscrews, and then slide the cover away from the printer (callout 2) to remove it.

 **TIP:** If needed, use the edge of a coin to turn the thumbscrews.

Figure 1-67 Loosen the thumbscrews



Step 2: Remove the hard-disk drive (HDD; M577)

 **CAUTION:**  ESD-sensitive part.

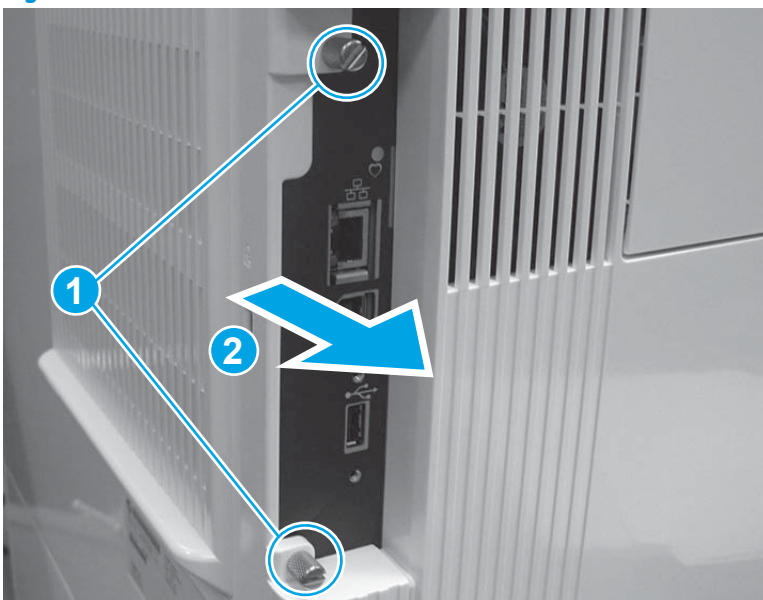
1. Release two tabs (callout 1). Hold the tabs in the released position, and then rotate the hard disk drive (HDD) up (callout 2) to release the connector from the formatter.

Figure 1-68 Release the HDD

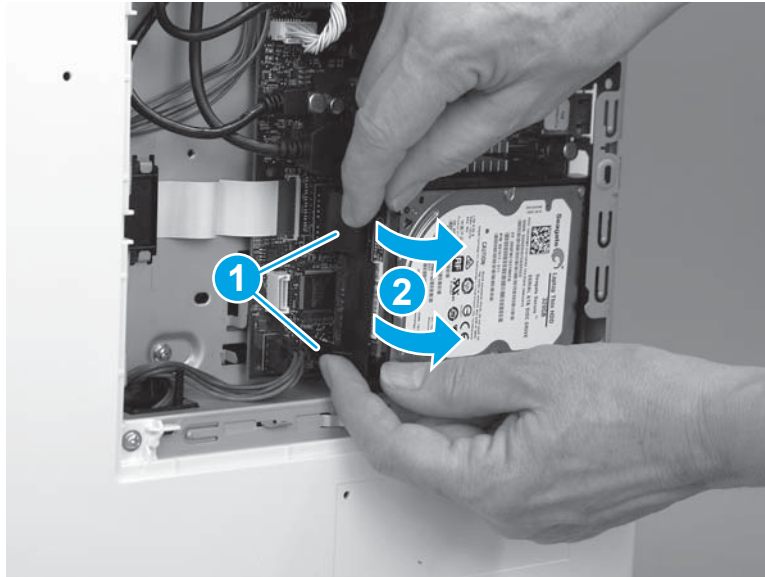

2. Slide the HDD away from the printer to remove it.

Figure 1-69 Remove the HDD

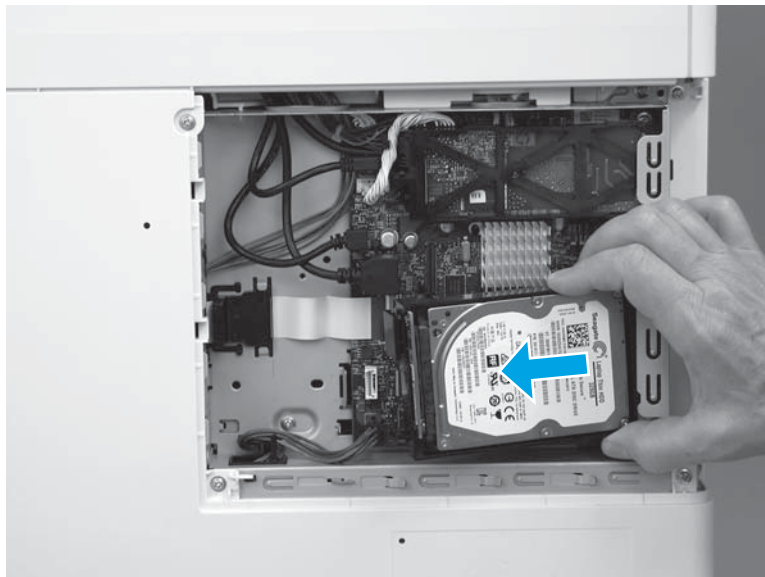

Step 3: Remove the dual in-line memory module (DIMM)

 **CAUTION:**  ESD-sensitive part.

1. Locate the DIMM component on the formatter.

Figure 1-70 Locate the DIMM

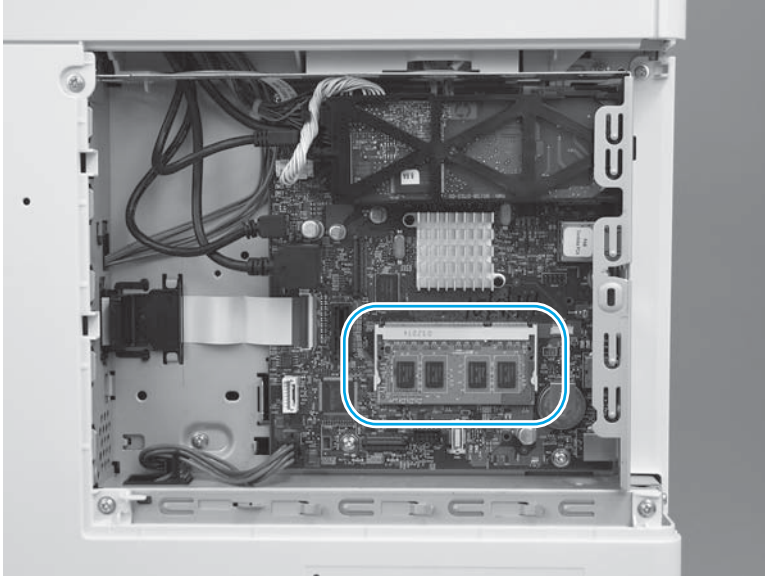

2. Do the following:
 - a. Release two locking arms (callout 1).

Figure 1-71 Release the DIMM

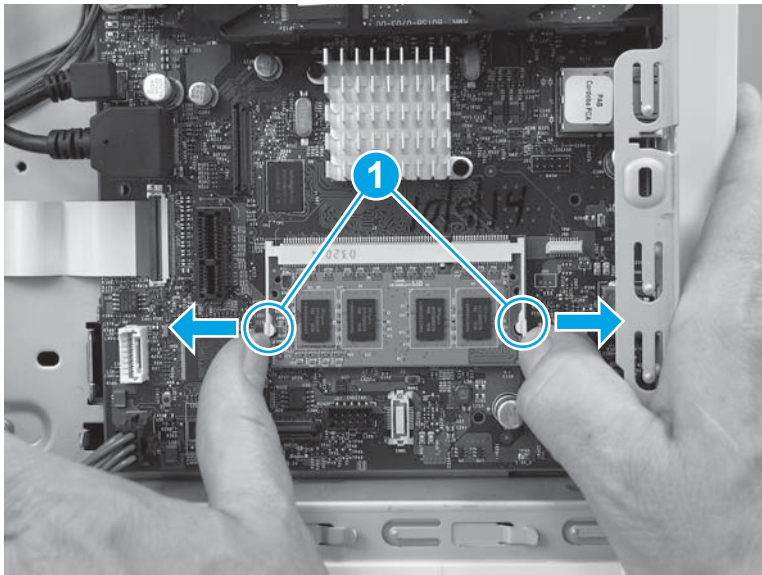

- b. Pull the DIMM down and away from the holder to remove it.

Figure 1-72 Remove the DIMM (M527)

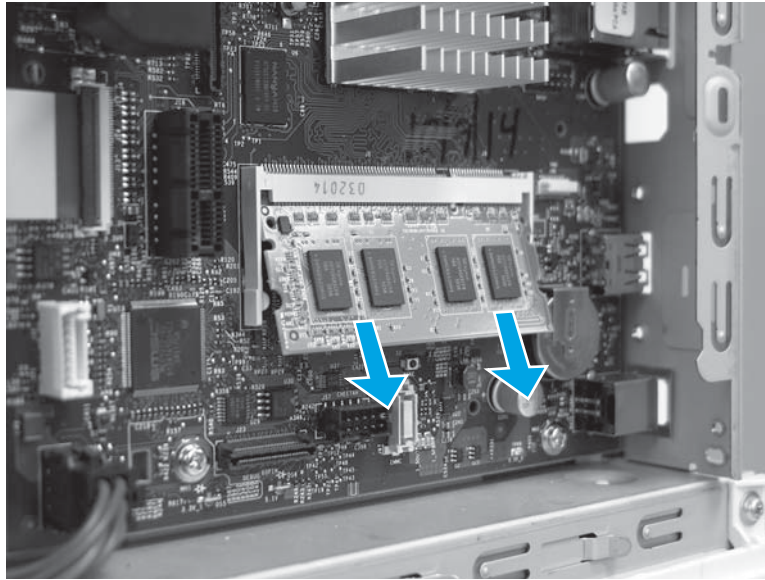

Step 4: Unpack the replacement assembly

Unpack the replacement assembly from the packaging.

 **CAUTION:**  ESD-sensitive part.

For complete information on HP's recycling programs, go to [Product return and recycling](#).

 **NOTE:** HP recommends responsible disposal of the defective assembly.

Figure 1-73 Recycle and unpack

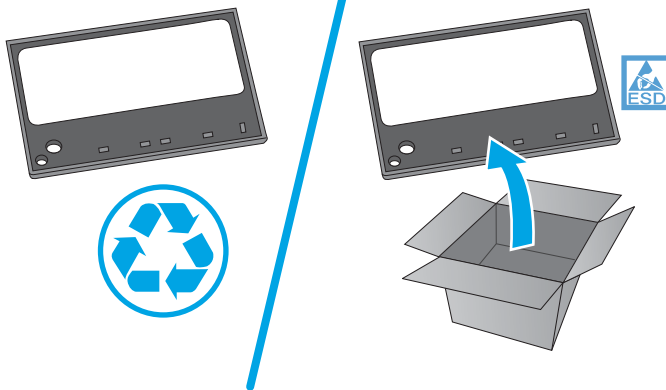

Step 5: Install the DIMM

 **CAUTION:**  ESD-sensitive part.

1. Insert the top edge of the DIMM (callout 1) in the holder (callout 2).

 **Reinstallation tip:** The DIMM is keyed and can only be inserted in the holder one way.

Figure 1-74 Insert the DIMM

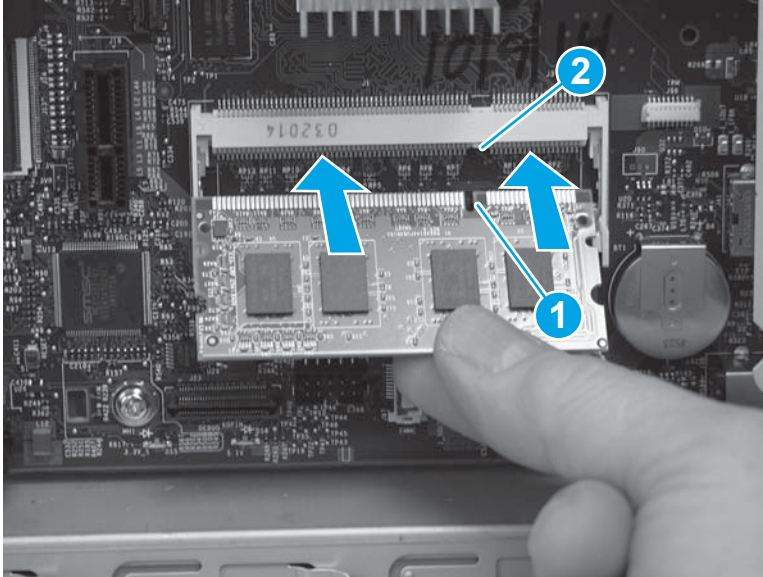

2. Make sure that the DIMM is fully installed in the holder (callout 1), and then rotate the bottom edge of the DIMM toward the holder (callout 2).

Figure 1-75 Install the DIMM

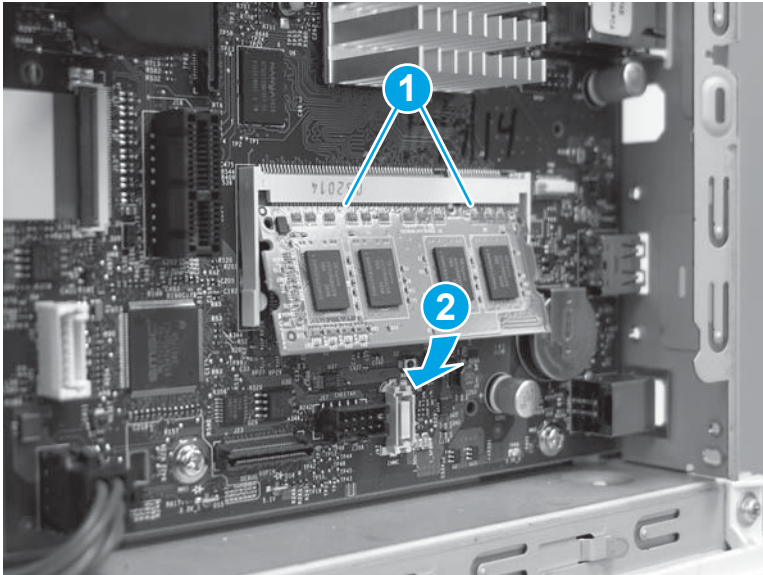

3. Make sure that the DIMM snaps into the locking arms (callout 1).

Figure 1-76 Snap the DIMM into place

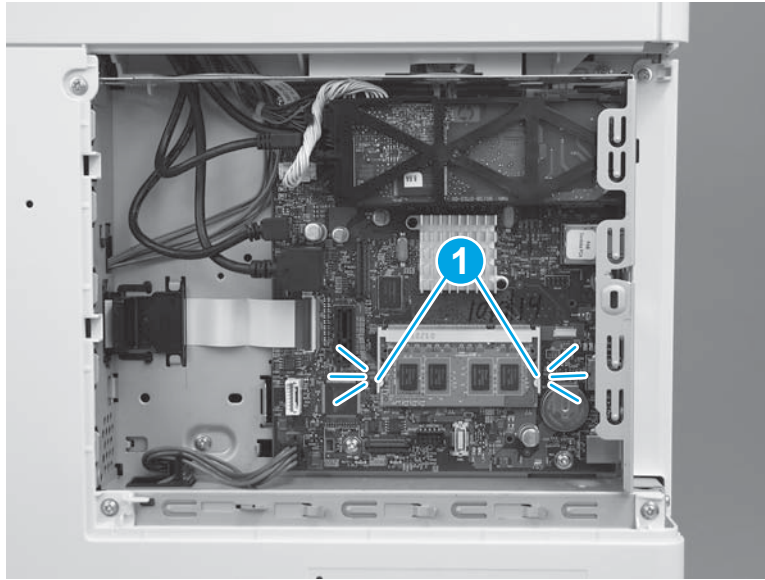

Step 6: Install the HDD (M577)

CAUTION:  ESD-sensitive part.

1. Align the end of the bracket (callout 1) with the slot in the chassis (callout 2), and then slide the HDD into the printer (callout 3) to engage the bracket with the chassis.

Figure 1-77 Install the holder

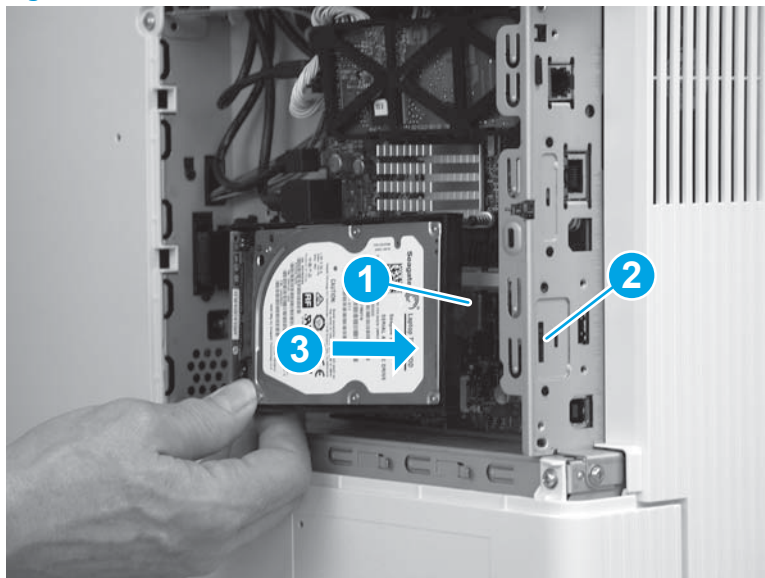

2. Hold the HDD connector latch (callout 1) in the released position, and then rotate the HDD down and into the connector on the formatter to install it.



 **NOTE:** Make sure that the tab (callout 2) snaps into place, and that the HDD is securely installed.

Figure 1-78 Release the HDD

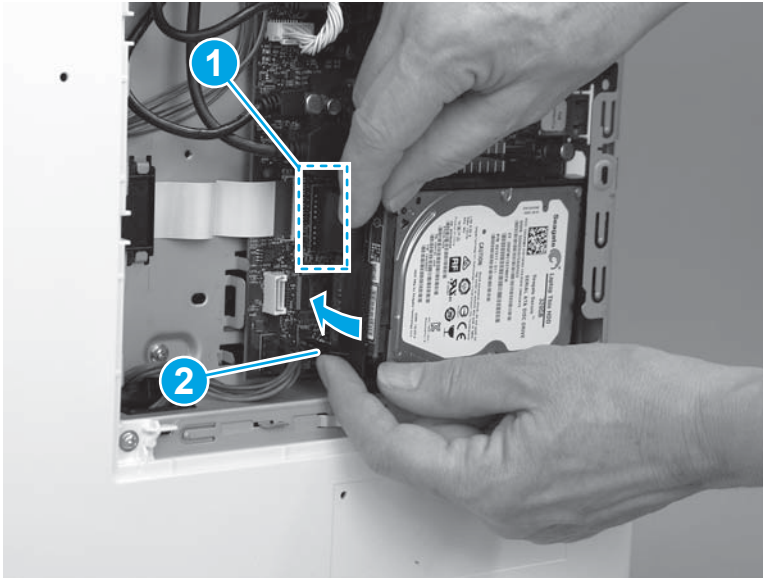

Step 7: Install the formatter cover

- ▲ Slide the cover onto the printer (callout 1) to install it.

 **NOTE:** Make sure that the tabs on the formatter cover align with the slots provided in the printer (callout 2). Tighten the two thumbscrews (callout 3).

 **TIP:** If needed, use the edge of a coin to turn the thumbscrews.

Figure 1-79 Install the cover



Removal and replacement: embedded MultiMedia Card (eMMC; M552 and M553)

- [Introduction](#)
- [Step 1: Remove the formatter cover](#)
- [Step 2: Remove the embedded MultiMedia Card \(eMMC\)](#)
- [Step 3: Unpack the replacement assembly](#)
- [Step 4: Install the eMMC](#)
- [Step 5: Install the formatter cover](#)
- [Step 6: Reinstall the product firmware](#)

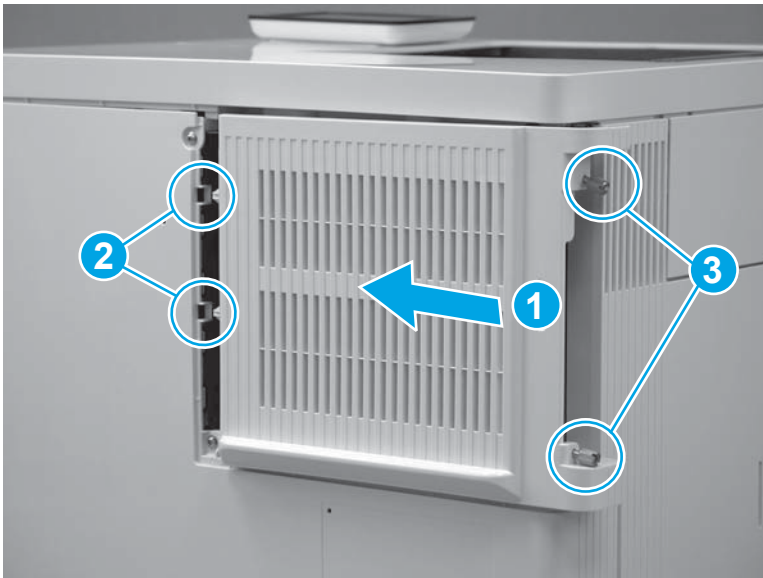
Introduction



This document provides the procedures to remove and replace the M552 and M553 embedded MultiMedia Card (eMMC).

Before performing service

Turn the printer power off

- Disconnect the power cable.

 **WARNING!** To avoid damage to the printer, turn the printer off, wait 30 seconds, and then remove the power cord before attempting to service the printer.

 **CAUTION:**  This part contains components that are electrostatic discharge (ESD) sensitive. To reduce the possibility of ESD damage, always touch the sheet-metal chassis to ground yourself before touching an ESD sensitive part.

 **IMPORTANT:** Do not replace the formatter, DC controller, and eMMC PCA or hard-disk drive simultaneously during a single printer servicing. Doing so might cause the printer to become unstable or inoperable.

 **NOTE:** Data stored on the eMMC is not secure and cannot be encrypted.

Use the table below to identify the correct part number for your printer. To order the part, go to www.hp.com/buy/parts.

embedded MultiMedia Card (eMMC) kit part number	
5851-6436	embedded MultiMedia Card (eMMC) with instruction guide

Required tools

No special tools are required to install this part.

After performing service

Make sure that the formatter cover is fully seated, and that the thumbscrews are finger tight after replacing it.

Turn the printer power on

- Connect the power cable.
- Use the power switch to turn the power on.

Post service test

Print a configuration page to make sure that the printer is functioning correctly.

Step 1: Remove the formatter cover

1. Locate the formatter cover.

Figure 1-80 Locate the formatter cover

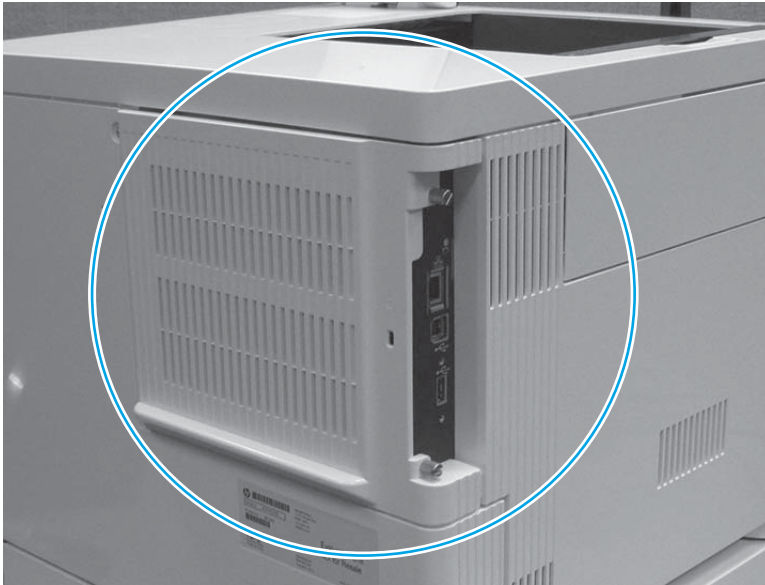

2. Loosen the two thumbscrews (callout 1). Grasp the two thumbscrews, and then slide the cover away from the printer (callout 2) to remove it.

 **TIP:** If needed, use the edge of a coin to turn the thumbscrews.

Figure 1-81 Loosen the thumbscrews



Step 2: Remove the embedded MultiMedia Card (eMMC)

 **CAUTION:**  ESD-sensitive part.

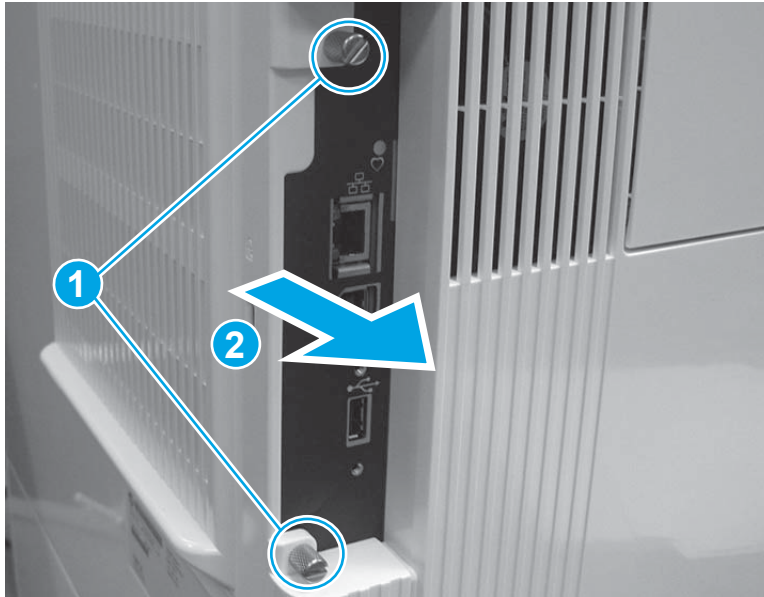
- ▲ Locate the eMMC component on the formatter, and then pull it straight off of the formatter to remove it.

Figure 1-82 Remove the eMMC

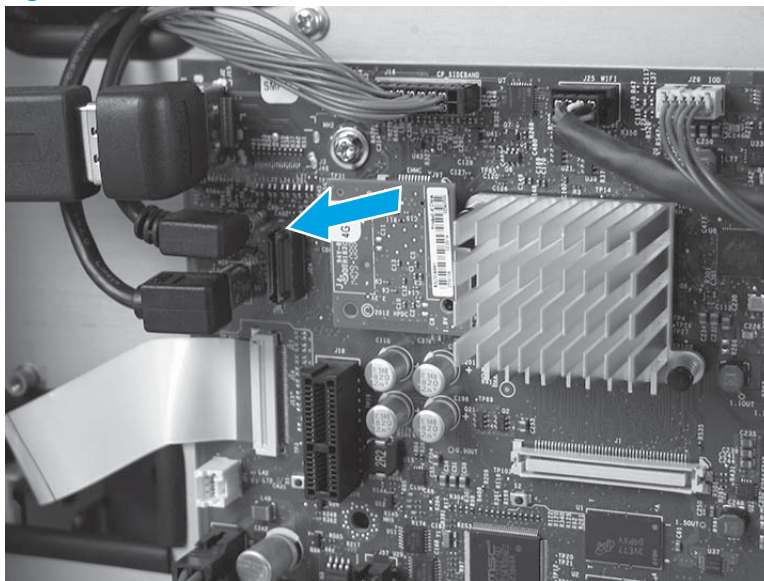

Step 3: Unpack the replacement assembly

Unpack the replacement assembly from the packaging.

 **CAUTION:**  ESD-sensitive part.

For complete information on HP's recycling programs, go to [Product return and recycling](#).

 **NOTE:** HP recommends responsible disposal of the defective assembly.

Figure 1-83 Recycle and unpack

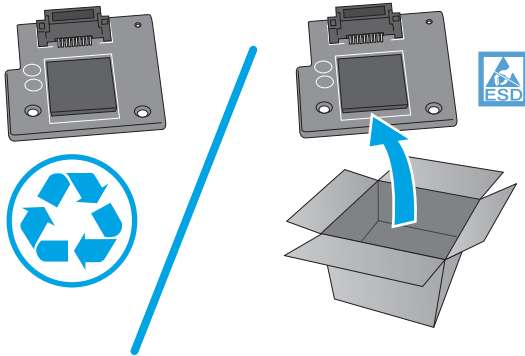

Step 4: Install the eMMC

 **CAUTION:**  ESD-sensitive part.

1. Align the connector on the replacement eMMC (callout 1) with the connector on the formatter (callout 2), and then push the eMMC onto the formatter to install it.

 **NOTE:** The eMMC can only be installed in one direction on the formatter.

Figure 1-84 Install the eMMC

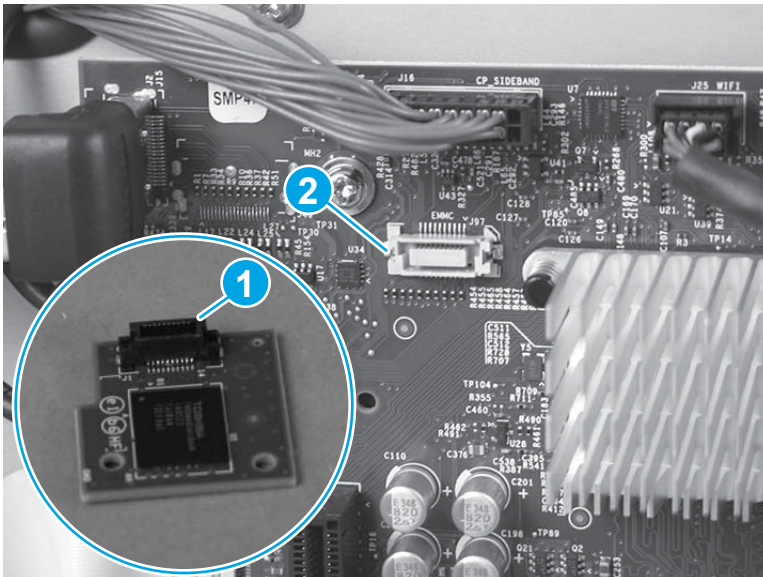

2. Push down on the eMMC to make sure that it is fully seated in the connector.

Figure 1-85 Verify the installation

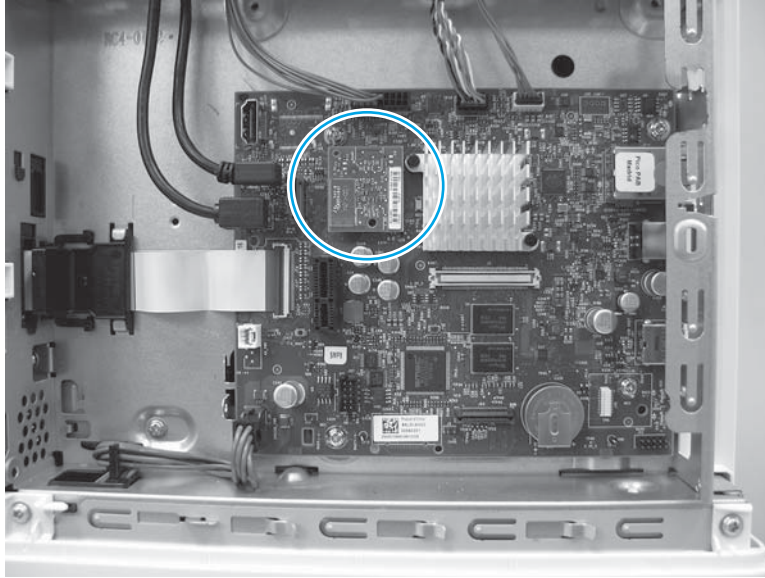

Step 5: Install the formatter cover

- ▲ Slide the cover onto the printer (callout 1) to install it.

 **NOTE:** Make sure that the tabs on the formatter cover align with the slots provided in the printer (callout 2). Tighten the two thumbscrews (callout 3).

 **TIP:** If needed, use the edge of a coin to turn the thumbscrews.

Figure 1-86 Install the cover



Step 6: Reinstall the product firmware

 **NOTE:** If this installation is a replacement eMMC, use the following steps to reinstall the firmware.

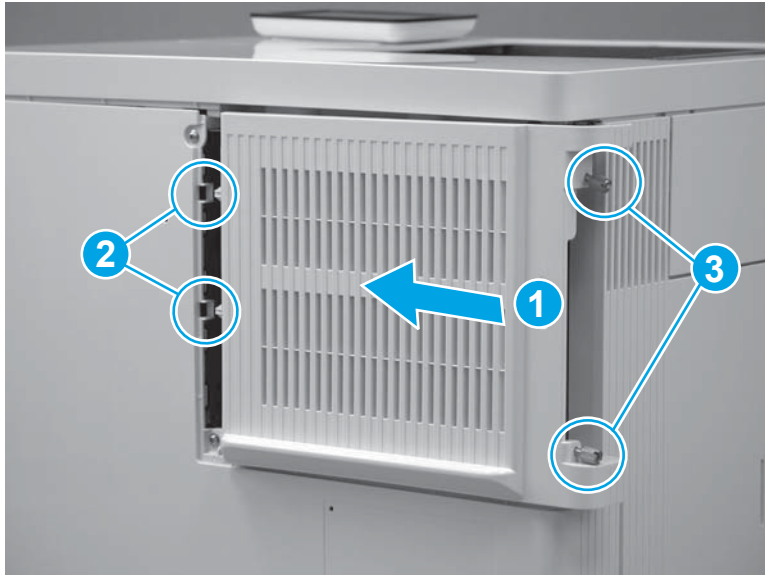
1. Go to www.hp.com/go/futuresmart.
2. Select **Upgrade now**.
3. Find your Enterprise printer model.
4. Select the link to open the firmware download page.
5. Select **OS Independent** from the list of operating systems.
6. Under the **Firmware** section, find the file for multiple operating systems.
7. Select **Download**.



NOTE: To view installation instructions, go to www.hp.com/go/futuresmart. Select **Upgrade now**, and then select **How to perform a firmware update**.

Removal and replacement: Secondary transfer roller

- [Introduction](#)
- [Step 1: Remove the transfer roller](#)
- [Step 2: Unpack the replacement assembly](#)
- [Step 3: Install the secondary transfer roller](#)

Introduction

This document provides the procedures to remove and replace the secondary transfer roller.

Before performing service

Turn the printer power off

- Disconnect the power cable.

 **WARNING!** To avoid damage to the printer, turn the printer off, wait 30 seconds, and then remove the power cord before attempting to service the printer.

Use the table below to identify the correct part number for your printer. To order the part, go to www.hp.com/buy/parts.

Secondary transfer roller kit part number	
B5L24-67902	Secondary transfer roller with instruction guide

Required tools

No special tools are required to install this part.

After performing service

Make sure that the right door is fully closed after replacing the secondary transfer roller.

Turn the printer power on

- Connect the power cable.
- Use the power switch to turn the power on.

Post service test

Print a configuration page to make sure that the printer is functioning correctly.

Step 1: Remove the transfer roller

1. Open the right door.

Figure 1-87 Open the right door



2. Push in on the blue lever (callout 1) to release the secondary transfer roller assembly, and then lower the assembly (callout 2) to the service position.

Figure 1-88 Lower the secondary transfer roller assembly

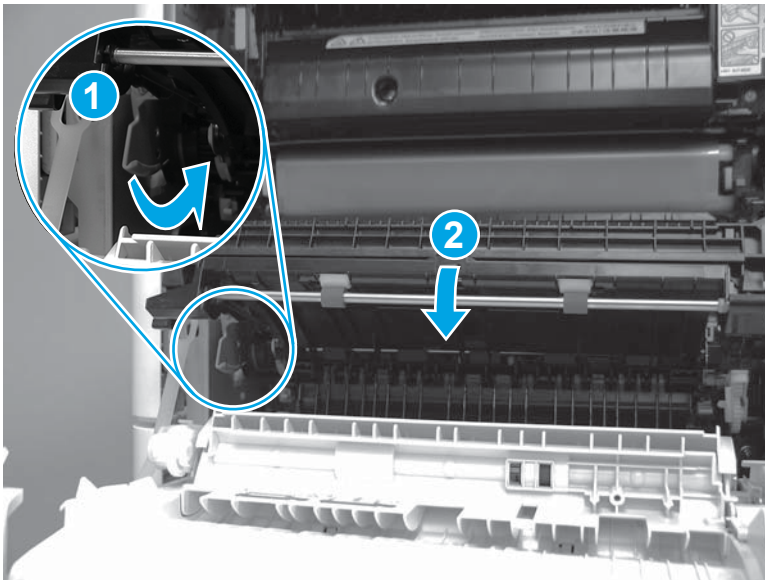

3. Slightly lift the left end of the roller shaft (callout 1; near the gear) to release the transfer roller clip.

Figure 1-89 Release the secondary transfer roller clip

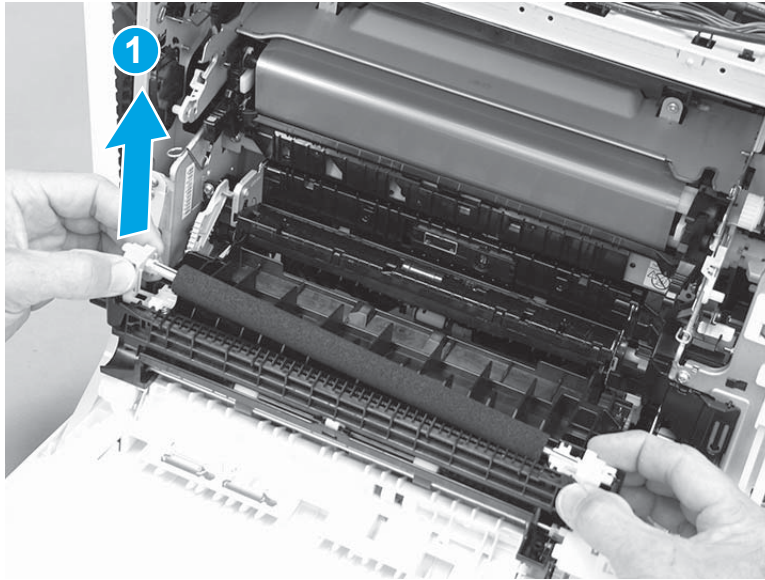

4. Slide the right end roller collar (callout 1) to the left to remove the transfer roller.

Figure 1-90 Remove the secondary transfer roller

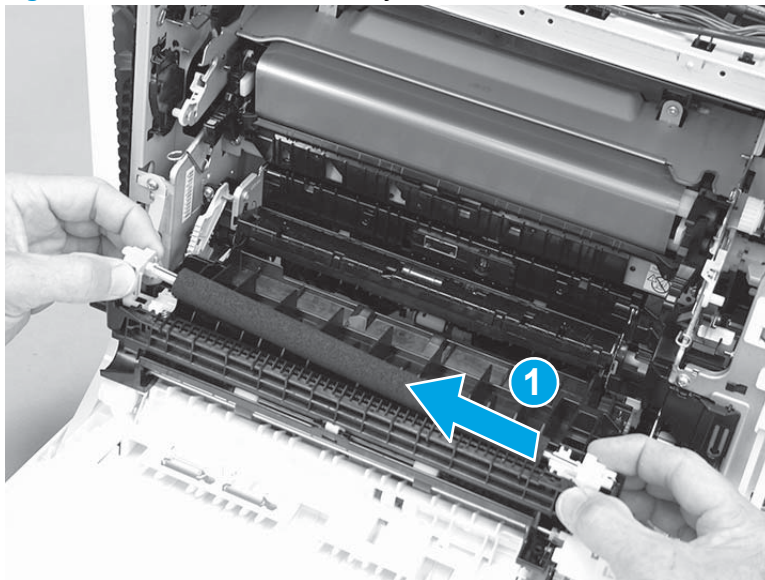

Step 2: Unpack the replacement assembly

Unpack the replacement assembly from the packaging.

CAUTION: Skin oils on the roller can cause print-quality problems. Avoid touching the black spongy roller on the assembly.

For complete information on HP's recycling programs, go to [Product return and recycling](#).

NOTE: HP recommends responsible disposal of the defective assembly.

Figure 1-91 Recycle and unpack

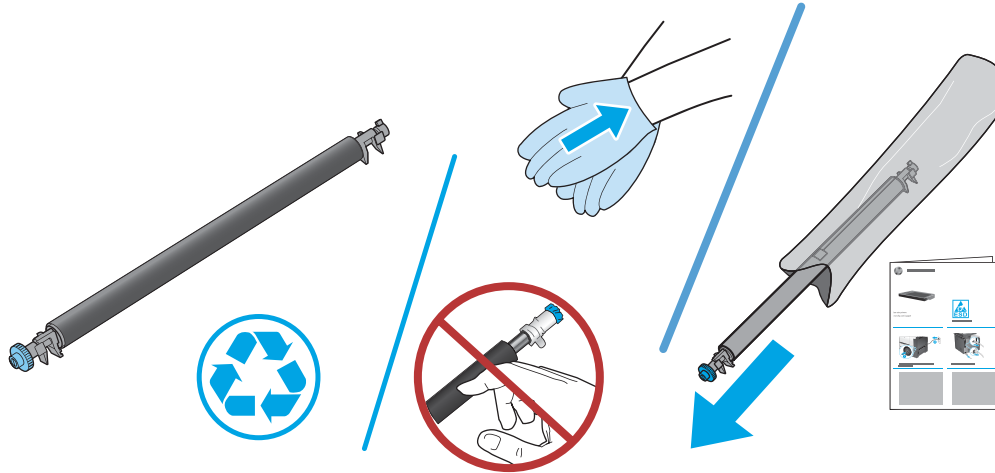

Step 3: Install the secondary transfer roller

1. Insert the right end (white plastic) of the replacement roller into the holder (callout 1), and then push down on the left end (blue plastic clip; callout 2) until the roller snaps into place.

 **IMPORTANT:** Make sure that both ends of the roller assembly are fully seated in the holders.

Figure 1-92 Install the secondary transfer roller



2. Close the right door.

Figure 1-93 Close the right door

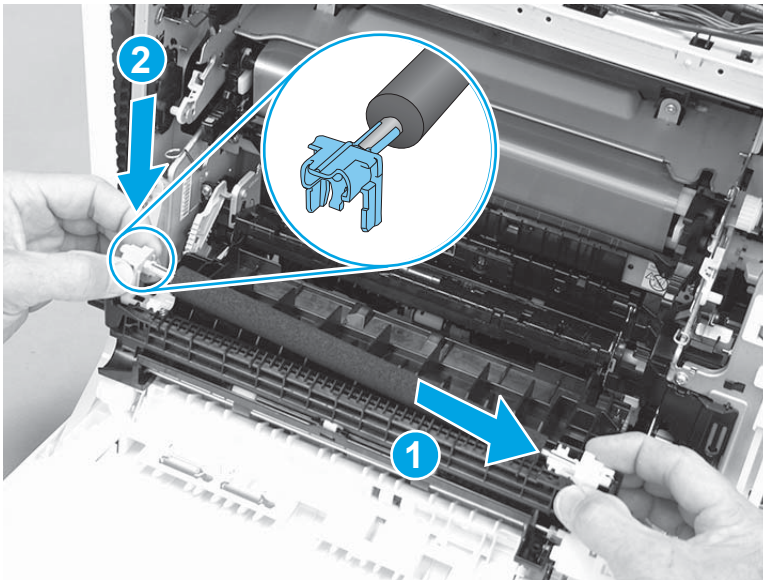

Removal and replacement: Universal Serial Bus (USB) cover (M552 and M553)

- [Introduction](#)
- [Step 1: Remove the USB cover](#)
- [Step 2: Unpack the replacement assembly](#)
- [Step 3: Install the USB cover](#)

Introduction

This document provides the procedures to remove and replace the M552 and M553 USB cover.

Before performing service

Use the table below to identify the correct part number for your printer. To order the part, go to www.hp.com/buy/parts.

USB cover part number	
RC4-0214-000CN	USB cover

Required tools

No special tools are required to install this part.

After performing service

Make sure that the USB cover is fully seated after replacing it.

Step 1: Remove the USB cover

1. Locate the USB cover.

Figure 1-94 Locate the USB cover

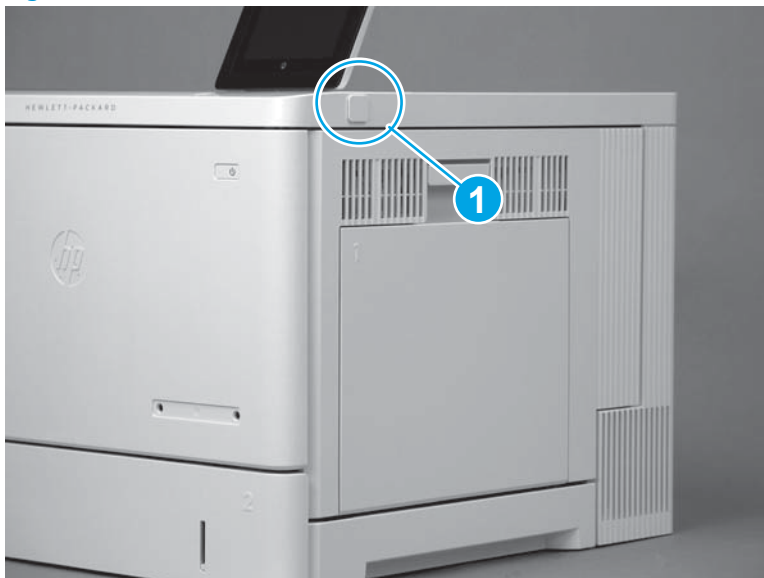

2. Pull the cover off of the printer to remove it.

Figure 1-95 Remove the cover



Step 2: Unpack the replacement assembly

Unpack the replacement assembly from the packaging.

For complete information on HP's recycling programs, go to [Product return and recycling](#).

 **NOTE:** HP recommends responsible disposal of the defective assembly.

Figure 1-96 Recycle and unpack



Step 3: Install the USB cover

1. Push the cover into the USB port to install it.

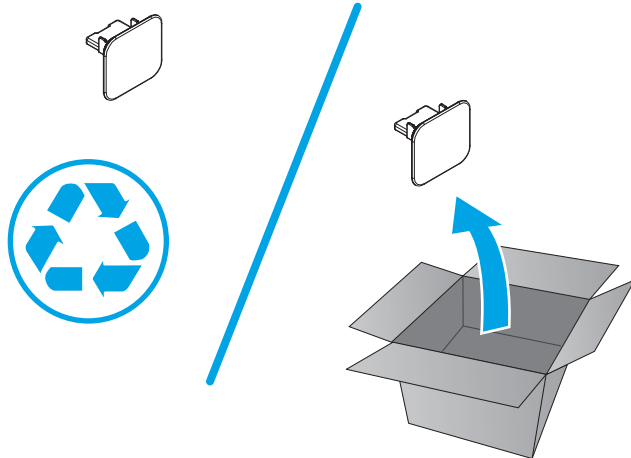
Figure 1-97 Install the cover



2. Make sure that the USB cover is fully seated after installing it.

Figure 1-98 Check the installation



Removal and replacement: Hardware Integration Pocket (HIP) cover (M552 and M553)

- [Introduction](#)
- [Step 1: Remove the HIP cover](#)
- [Step 2: Unpack the replacement assembly](#)
- [Step 3: Install the HIP cover](#)

Introduction

This document provides the procedures to remove and replace the M552 and M553 HIP cover.

Before performing service

Use the table below to identify the correct part number for your printer. To order the part, go to www.hp.com/buy/parts.

HIP cover (M552 and M553) part number	
RC4-0213-000CN	HIP cover (M552 and M553)

Required tools

No special tools are required to install this part.

After performing service

Make sure that the HIP cover is fully seated after replacing it.

Step 1: Remove the HIP cover

1. Locate the HIP cover.

Figure 1-99 Locate the HIP cover



2. Before proceeding, take note of the mounting feet (callout 1) and tabs (callout 2) on the HIP cover.

Figure 1-100 Note the mounting feet and tabs

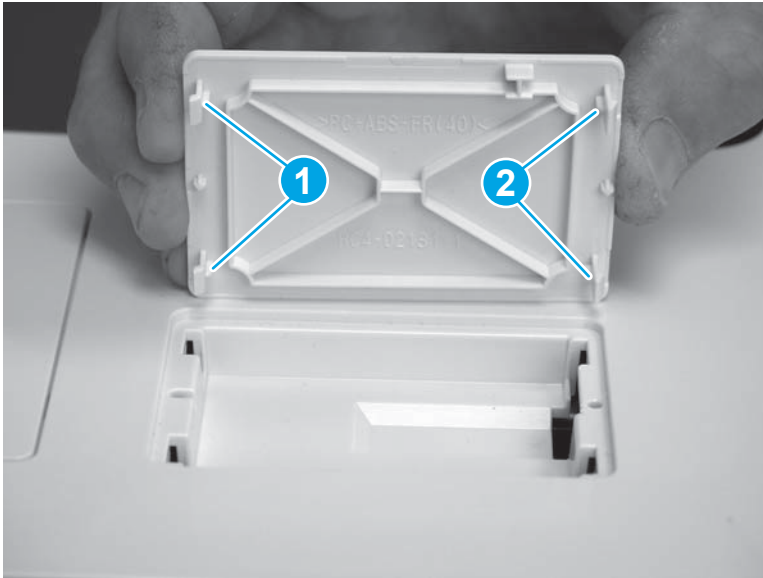

3. Use a small flat-blade screwdriver to release the tabs on the HIP cover.

Figure 1-101 Release the HIP cover tabs

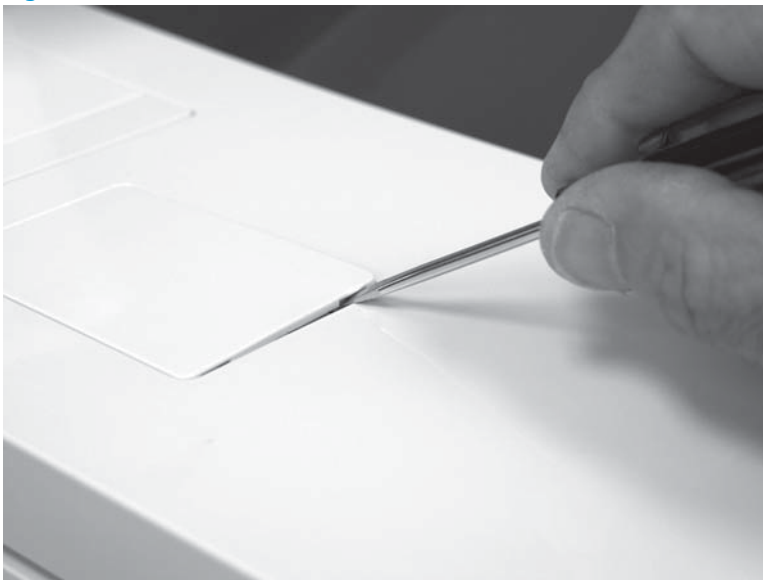

4. Rotate the cover up and off of the printer to remove it.

Figure 1-102 Remove the cover

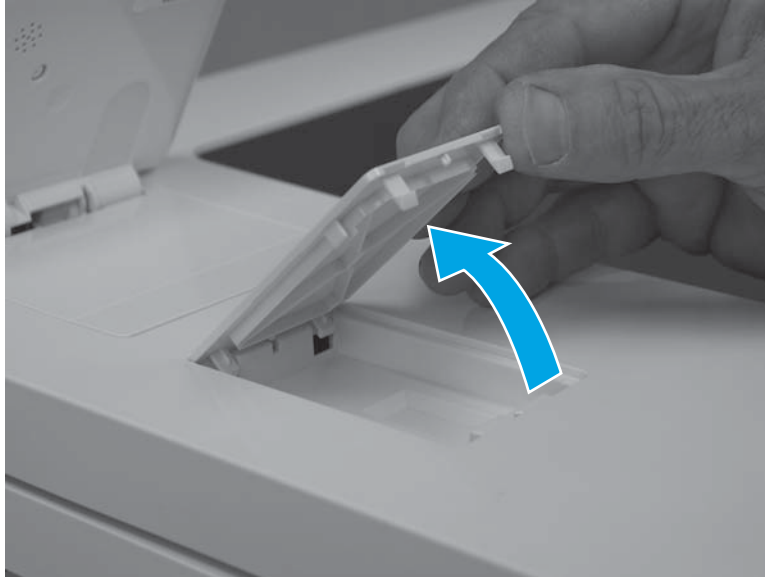

Step 2: Unpack the replacement assembly

Unpack the replacement assembly from the packaging.

For complete information on HP's recycling programs, go to [Product return and recycling](#).

 **NOTE:** HP recommends responsible disposal of the defective assembly.

Figure 1-103 Recycle and unpack

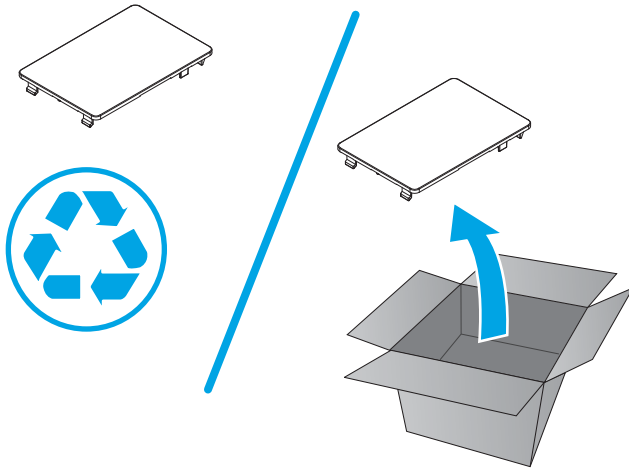

Step 3: Install the HIP cover

1. Position the HIP cover mounting feed in the slots (callout 1) provided in the top cover, and then rotate it down to install it.

 **NOTE:** Make sure that the tabs on the cover snap into place.

Figure 1-104 Install the cover

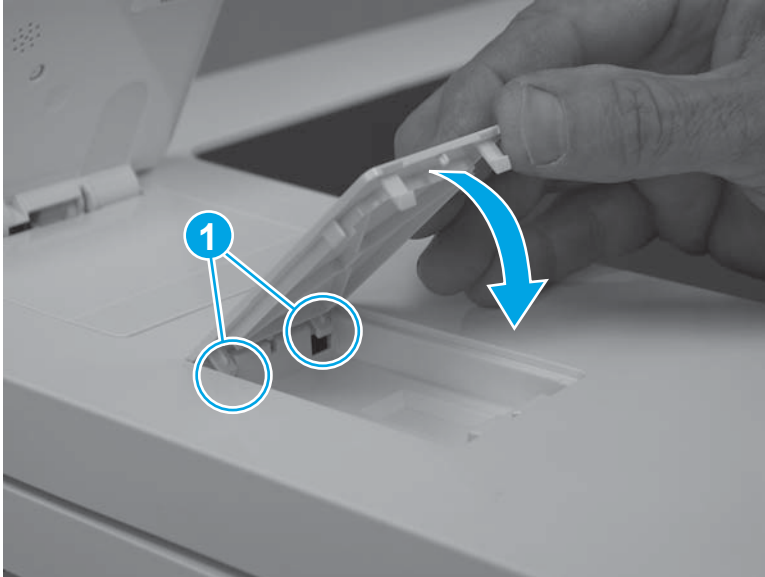

2. Make sure that the HIP cover is fully seated after installing it.

Figure 1-105 Check the installation



Removal and replacement: Hardware Integration Pocket (HIP) cover (M577)

- [Introduction](#)
- [Step 1: Remove the HIP cover](#)
- [Step 2: Unpack the replacement assembly](#)
- [Step 3: Install the HIP cover](#)

Introduction

This document provides the procedures to remove and replace the M577 HIP cover.

Before performing service

Use the table below to identify the correct part number for your printer. To order the part, go to www.hp.com/buy/parts.

HIP cover (M577) part number	
B5L46-40021	HIP cover (M577)

Required tools

No special tools are required to install this part.

After performing service

Make sure that the HIP cover is fully seated after replacing it.

Step 1: Remove the HIP cover

1. Locate the HIP cover.

Figure 1-106 Locate the HIP cover



2. Use a small flat-blade screwdriver to release the tabs on the HIP cover.

Figure 1-107 Release the HIP cover tabs



3. Rotate the cover up and off of the printer to remove it.

Figure 1-108 Remove the cover



Step 2: Unpack the replacement assembly

Unpack the replacement assembly from the packaging.

For complete information on HP's recycling programs, go to [Product return and recycling](#).



NOTE: HP recommends responsible disposal of the defective assembly.

Figure 1-109 Recycle and unpack

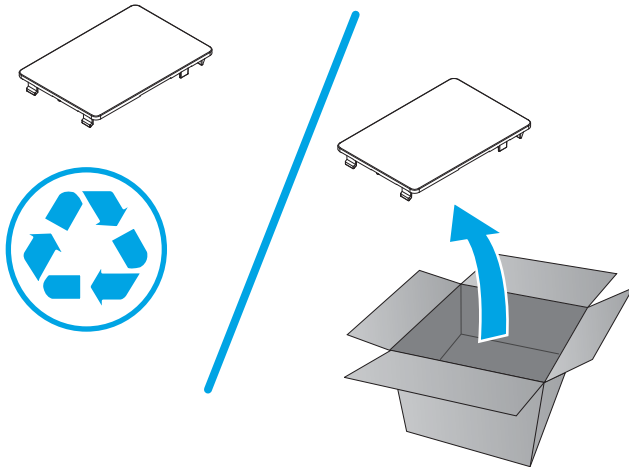

Step 3: Install the HIP cover

1. Position the tabs (callout 1) on the HIP cover in the slots (callout 2) in the printer.

Figure 1-110 Position the tabs

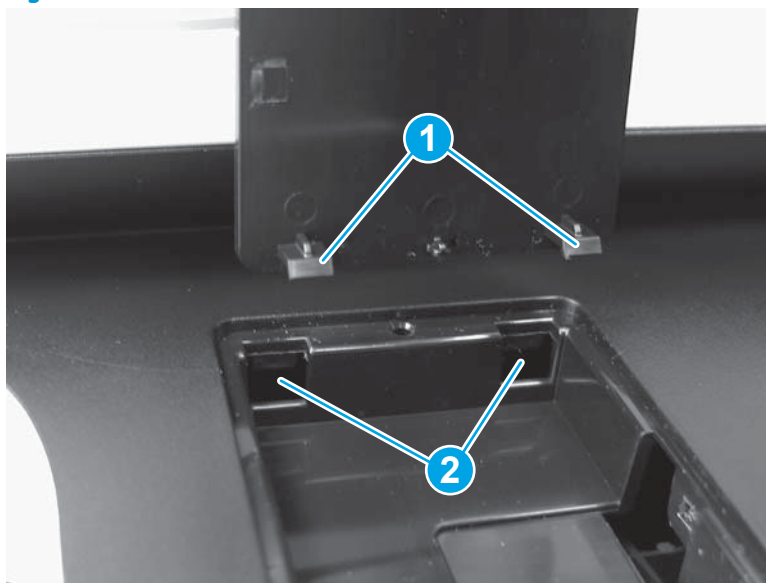

2. Rotate the cover down.

 **NOTE:** Make sure that the tabs on the cover snap into place.

Figure 1-111 Rotate the cover down



3. Make sure that the HIP cover is fully seated after installing it.

Figure 1-112 Check the installation



Removal and replacement: Control panel (M553x)

- [Introduction](#)
- [Step 1: Remove the control panel](#)
- [Step 2: Unpack the replacement assembly](#)
- [Step 3: Install the control panel](#)

Introduction

This document provides instructions about removing and replacing the M553x control panel.

Before performing service

Turn the printer power off

- Disconnect the power cable.

 **WARNING!** To avoid damage to the printer, turn the printer off, wait 30 seconds, and then remove the power cord before attempting to service the printer.

Use the table below to identify the correct part number for your printer. To order the part, go to www.hp.com/buy/parts.

Control panel (M553x) kit part number	
B5L24-67903	Control panel (M553x) and reversible screwdriver with instruction guide

Required tools

- Reversible small, flat-blade screwdriver and #2 Phillips screwdriver (included with the control panel)

After performing service

Turn the printer power on

- Connect the power cable.
- Use the power switch to turn the power on.

Post service test

The printer includes a diagnostic test mode for the control panel. For more information, see the control panel checks section of the printer troubleshooting manual.

Step 1: Remove the control panel

1. Tilt the control panel up.

Figure 1-113 Tilt the control panel up



2. Use the small flat-blade screwdriver supplied in this kit to release the control-panel screws cover tabs.

 **TIP:** The screwdriver has a reversible shaft. Simply pull the shaft out of the handle, and then reinstall it with the desired end facing out.

Figure 1-114 Release the control-panel screws cover tabs



3. Rotate the cover up to remove it.

Figure 1-115 Remove the cover



4. Use the small Phillips screwdriver supplied in this kit to remove two screws (callout 1).

 **IMPORTANT:** Store the screws in a secure place where they cannot fall down into the printer.

 **TIP:** The screwdriver has a reversible shaft. Simply pull the shaft out of the handle, and then reinstall it with the desired end facing out.

Figure 1-116 Remove two screws



5. Rotate the control-panel base toward the front of the printer.

Figure 1-117 Rotate the control-panel base up

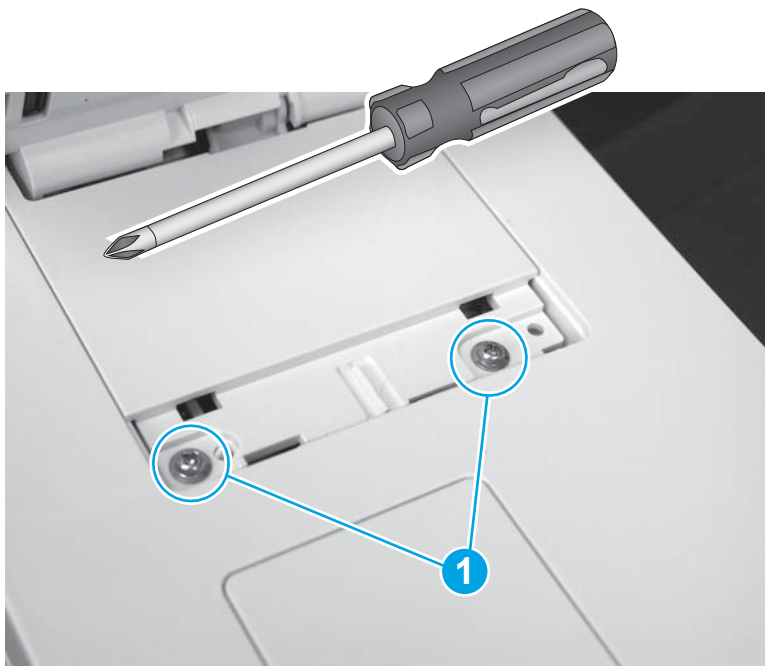

6. Slightly slide the control-panel base toward the rear of the printer (callout 1) to release it, and then turn the control panel over (callout 2) to access the bottom side.

CAUTION: The control panel is still attached to the printer. Do not attempt to completely remove the control panel.

Figure 1-118 Turn the control panel over

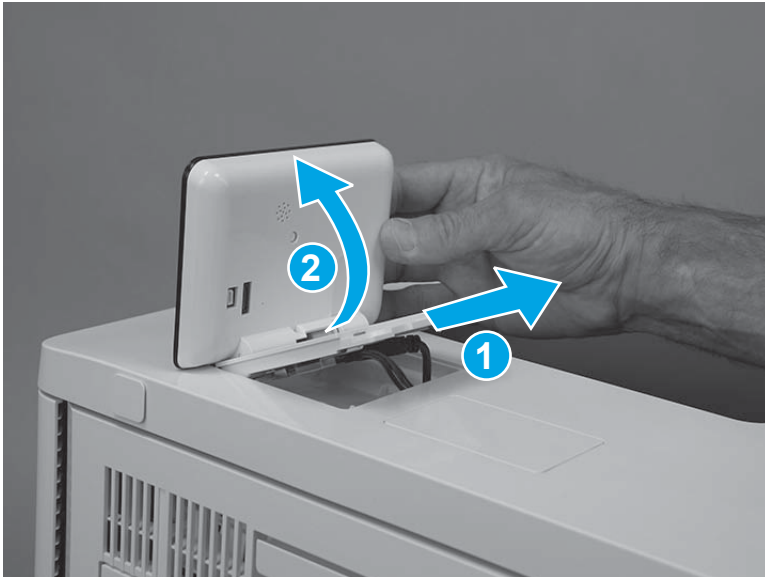

7. Disconnect one USB cable (callout 1), one connector (callout 2), and then remove the control panel.

Figure 1-119 Disconnect two connectors

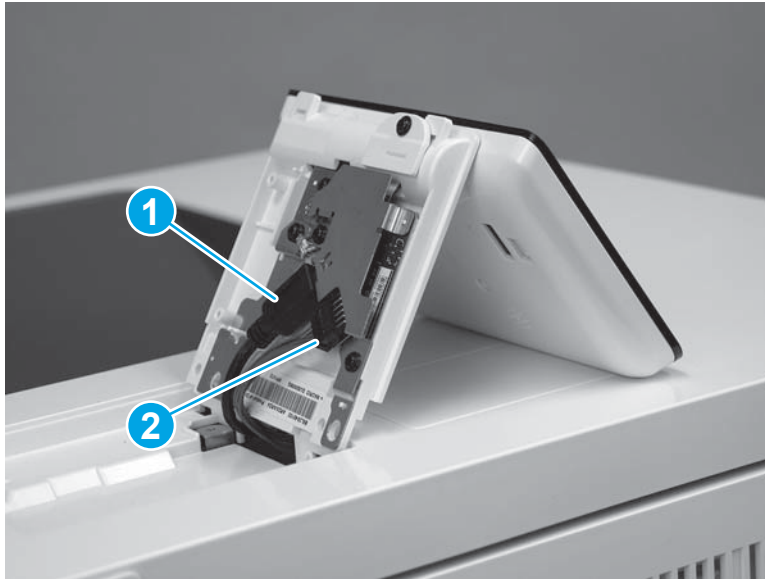

Step 2: Unpack the replacement assembly

Unpack the replacement assembly from the packaging.

For complete information on HP's recycling programs, go to [Product return and recycling](#).

 **NOTE:** HP recommends responsible disposal of the defective assembly.

 **TIP:** Don't forget to remove the protective film on the touchscreen of the replacement control panel.

Figure 1-120 Recycle and unpack



Step 3: Install the control panel

1. Place the control panel on the printer as shown.

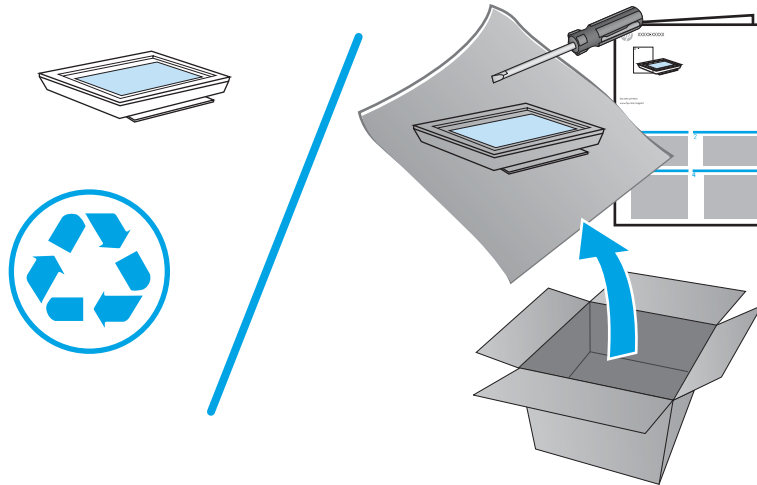
Figure 1-121 Place the control panel on the product

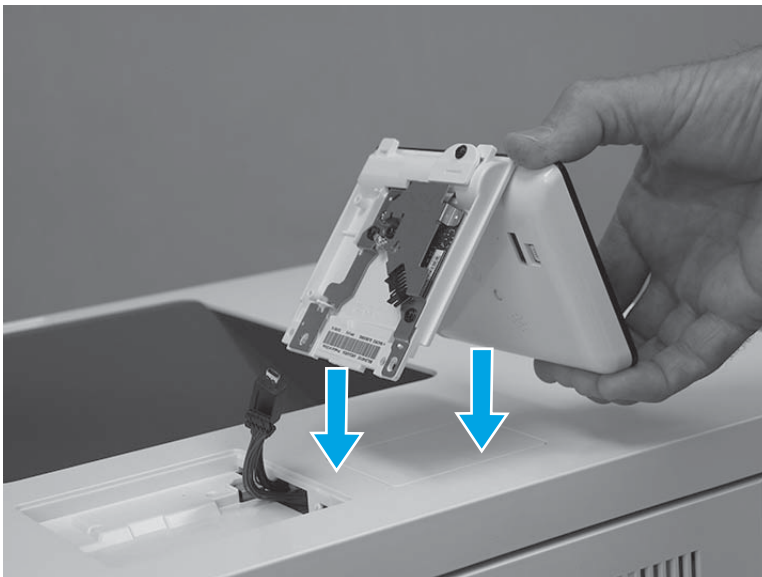

2. Connect one USB cable (callout 1), and one connector (callout 2).

 **IMPORTANT:** Take note of the location of the two mounting tabs (callout 3) on the control-panel assembly.

Figure 1-122 Connect two connectors



3. Turn the control panel over, and then position the front edge tabs in the slots in the top cover.

Figure 1-123 Turn the control panel over

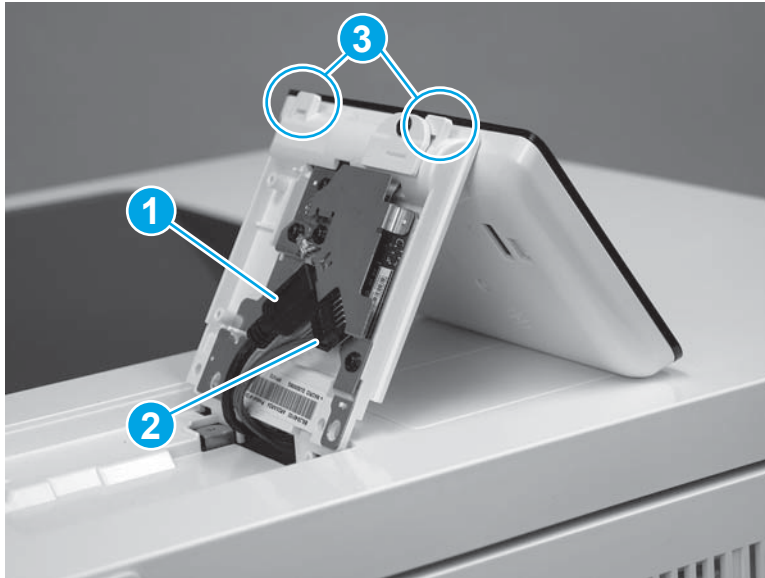
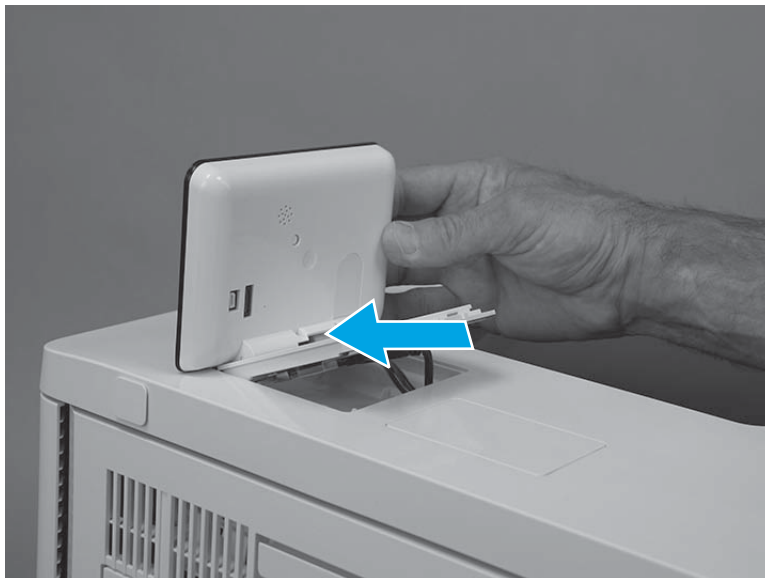

4. Rotate the control-panel base down onto the printer.

Figure 1-124 Rotate the control-panel base down



5. Use the small Phillips screwdriver supplied in this kit to install two screws (callout 1).

 **TIP:** The screwdriver has a reversible shaft. Simply pull the shaft out of the handle, and then reinstall it with the desired end facing out.

Figure 1-125 Install two screws

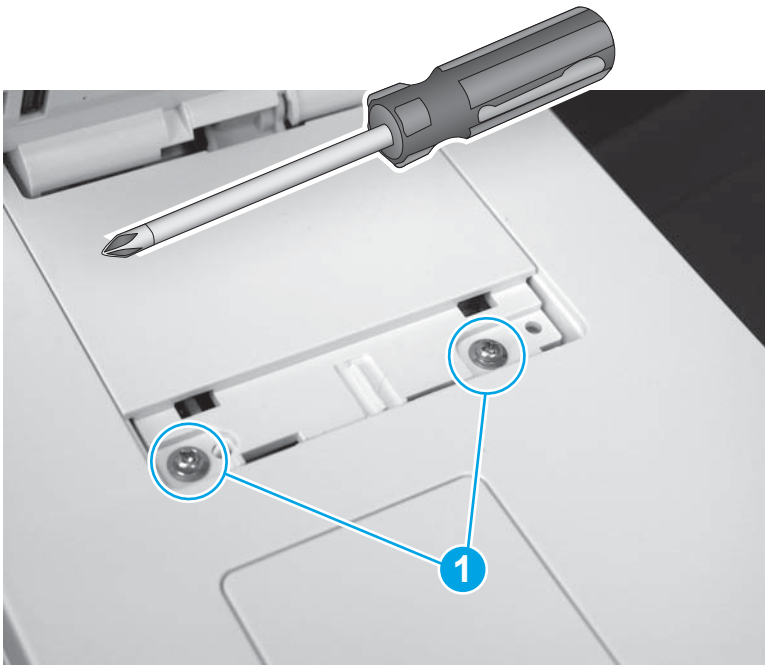

6. Position the screw cover mounting feet into the slots in the top cover (callout 1), and then rotate the cover down (callout 2) to install it.

 **NOTE:** Press down on the cover firmly to make sure that the tabs on the cover (callout 3) snap into place.

Figure 1-126 Install the cover



Removal and replacement: Control panel (M577)

- [Introduction](#)
- [Step 1: Remove the control-panel cover \(M577\)](#)
- [Step 2: Remove the control panel \(M577\)](#)
- [Step 3: Unpack the replacement assembly](#)
- [Step 4: Install the control panel \(M577\)](#)
- [Step 5: Install the control-panel cover \(M577\)](#)

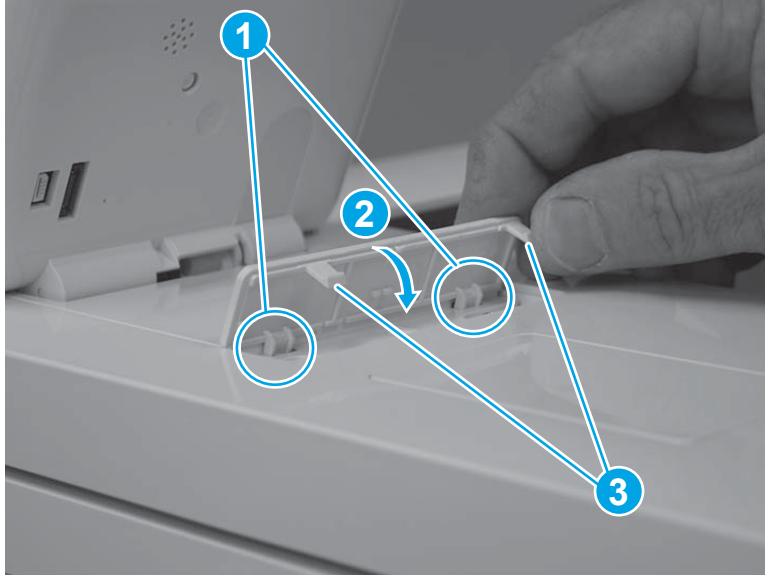
Introduction

This document provides the procedures to remove and replace the M577 control panel.

Before performing service

Turn the printer power off

- Disconnect the power cable.

 **WARNING!** To avoid damage to the printer, turn the printer off, wait 30 seconds, and then remove the power cord before attempting to service the printer.

Use the table below to identify the correct part number for your printer. To order the part, go to www.hp.com/buy/parts.

Control panel (M577) part number	
B5L47-67018	Control panel (M577) and reversible screwdriver with instruction guide

Required tools

- #2 Phillips screwdriver with a magnetic tip.

After performing service

Turn the printer power on

- Connect the power cable.
- Use the power switch to turn the power on.

Post service test

The printer includes a diagnostic test mode for the control panel. For more information, see the control panel checks section of the printer troubleshooting manual.

Step 1: Remove the control-panel cover (M577)

1. Open the document feeder (callout 1).

 **NOTE:** If the control panel is not fully tilted forward, tilt it forward now until it stops (callout 2).

Figure 1-127 Open the document feeder



2. Beginning at the right side of the control-panel cover, carefully release five tabs along the top edge of the cover.

 **NOTE:** The thin, black plastic cover will separate from the white plastic control-panel base.

Figure 1-128 Release five tabs



3. Continue to lift the top edge of the cover away from the printer, and then remove the cover.

Figure 1-129 Remove the cover



Step 2: Remove the control panel (M577)

1. **M577c/z only:** Open the latch (callout 1) to release the keyboard flat cable.

CAUTION: The latch must be opened to release the cable.

Figure 1-130 Disconnect the keyboard flat cable (M577c/z)

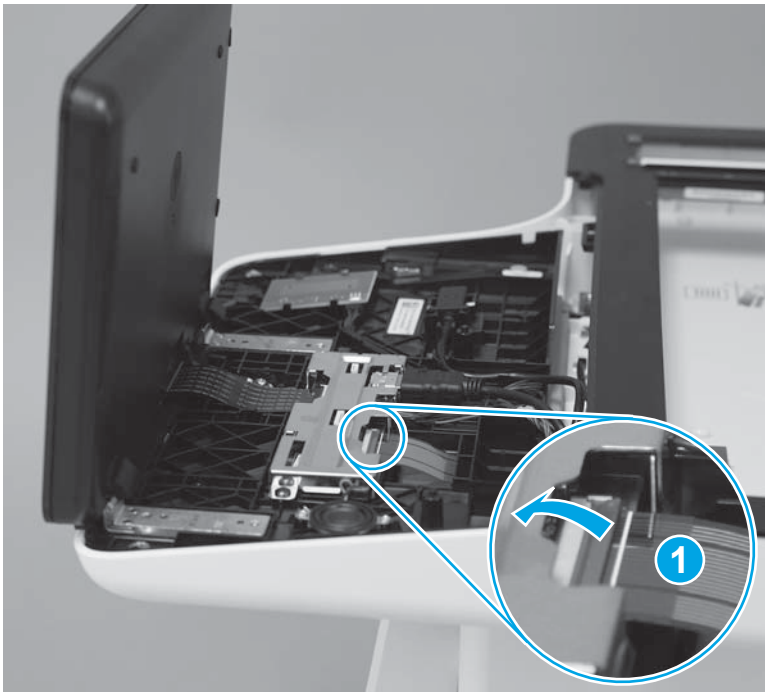

2. Disconnect one HDMI cable (callout 1) and one connector (callout 2).

Figure 1-131 Disconnect connectors



3. Remove the USB cable (callout 1) from the holder.

M577z only: Release four tabs (callout 2), and then remove the near-field communication (NFC) printed circuit board.

Figure 1-132 Disconnect connectors

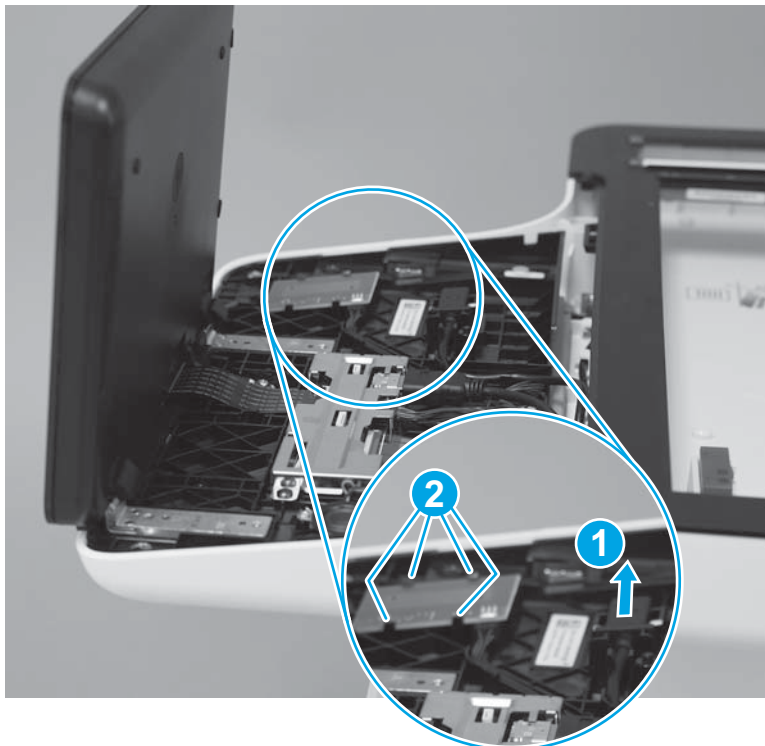

4. Remove three screws (callout 1).

 **TIP:** The screwdriver (supplied with the kit) has a reversible shaft. Simply pull the shaft out of the handle, and then reinstall it with the desired end facing out.

Figure 1-133 Remove three screws



5. Lift the front of the control panel off of the printer (callout 1), and then slide it towards the front of the printer (callout 2) to remove it.

Figure 1-134 Remove the control panel

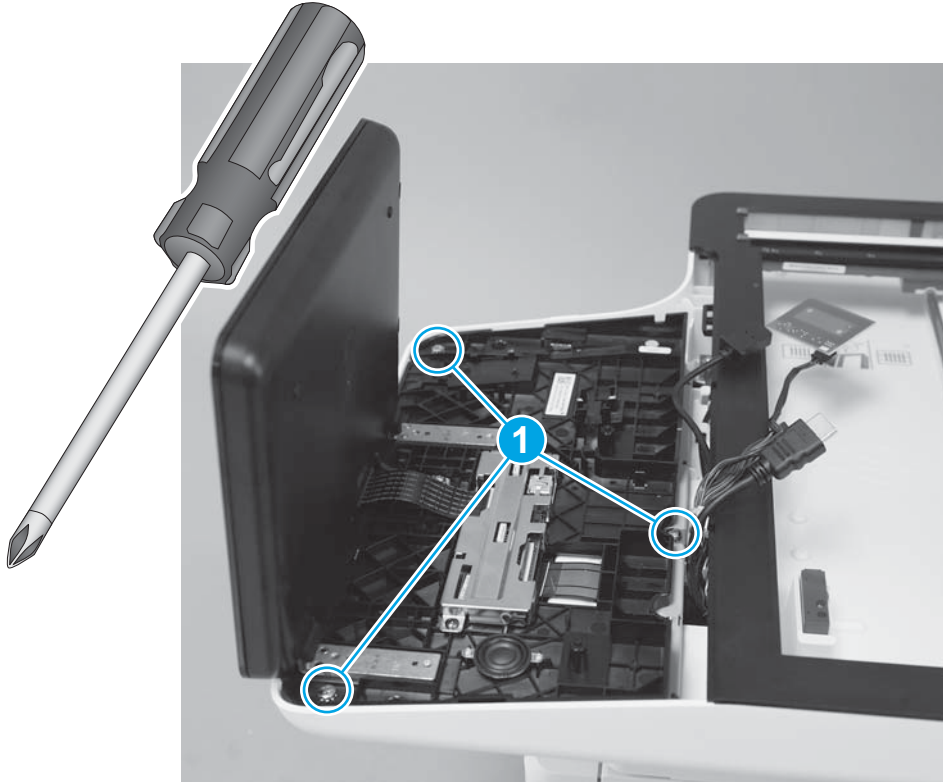

Step 3: Unpack the replacement assembly

Unpack the replacement assembly from the packaging.

For complete information on HP's recycling programs, go to [Product return and recycling](#).

 **NOTE:** HP recommends responsible disposal of the defective assembly.

 **TIP:** Don't forget to remove the protective film on the touchscreen of the replacement control panel.

Figure 1-135 Recycle and unpack



Step 4: Install the control panel (M577)

1. Tilt the replacement control panel away from the base plate.

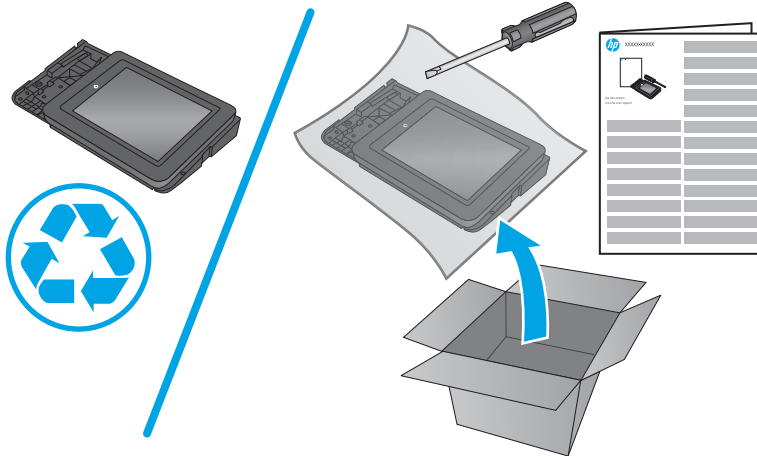
Figure 1-136 Open the control panel

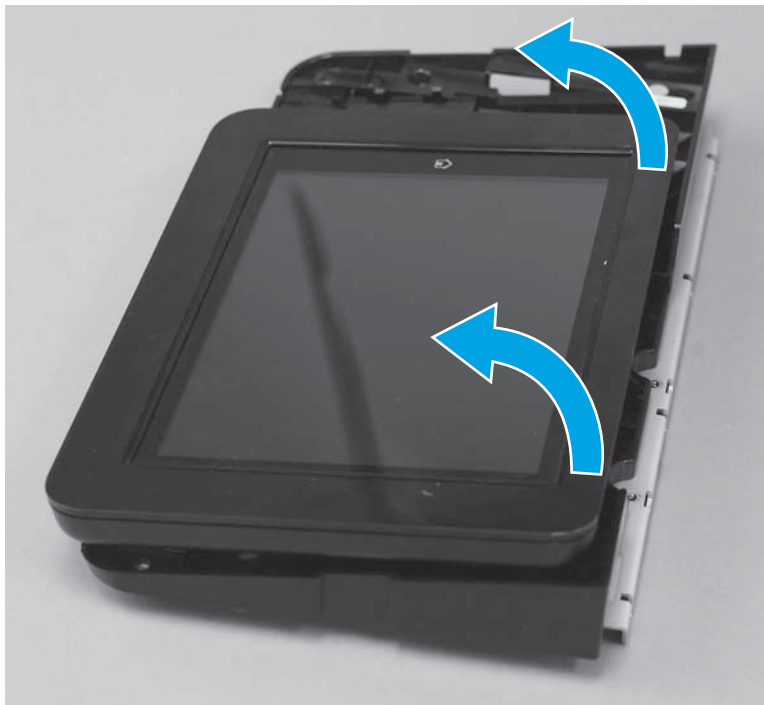

2. **M577c/z only:** Make sure to feed the keyboard flat cable (callout 1) through the opening (callout 2) in the control-panel base when installing the control panel.

Figure 1-137 Feed the keyboard flat cable through opening

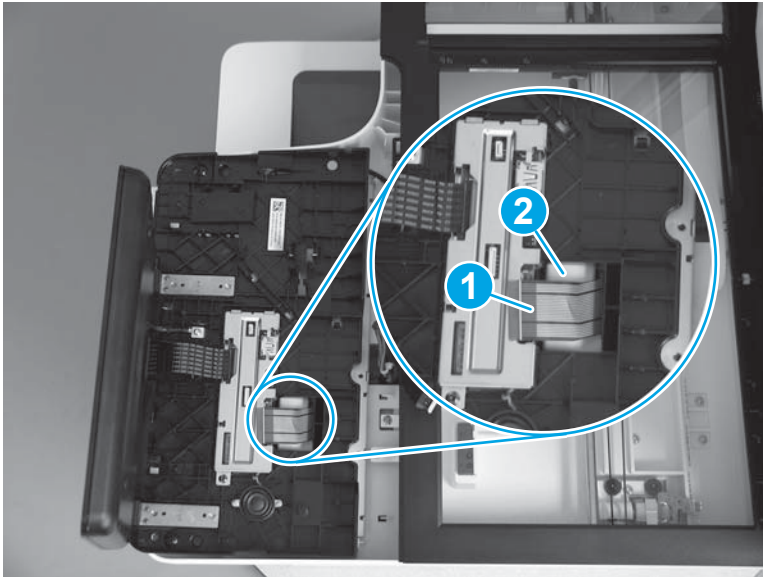

3. Locate the four hooks on the printer and matching slots in the control-panel base (callout 1). The hooks fit into the slots (callout 2) when the assembly is installed.

 **NOTE:** Make sure that the grounding clip (callout 3) is on top of the assembly base when it is installed.

Figure 1-138 Locate hooks and grounding clip



4. Position the rear edge of the control panel in the printer (callout 1), and then lower the front edge down (callout 2) to install it.

 **NOTE:** If the control panel is difficult to install, make sure that the hooks, slots, and grounding clip are correctly engaged. See [Figure 1-138 Locate hooks and grounding clip on page 98](#).

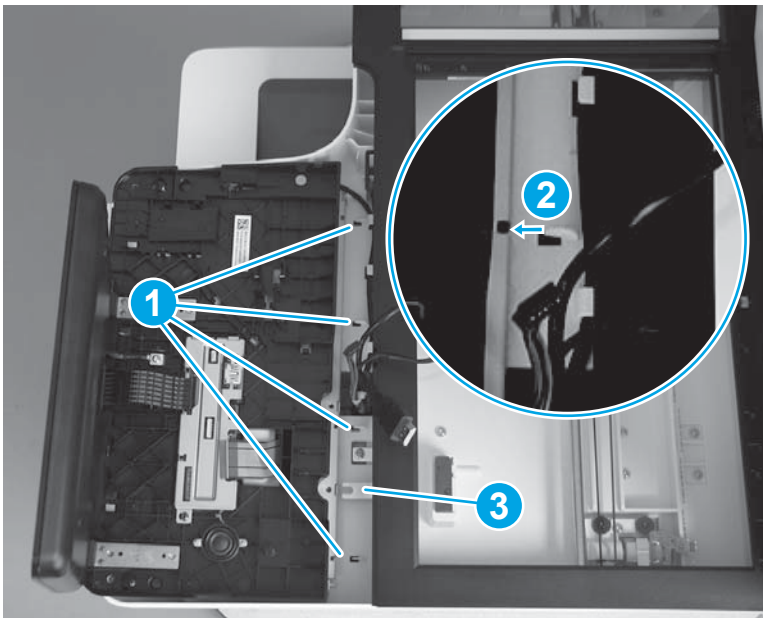
Figure 1-139 Install the control-panel



5. Install three screws (callout 1), making sure that the grounding clip is correctly installed (callout 2).

 **TIP:** The screwdriver (supplied with the kit) has a reversible shaft. Simply pull the shaft out of the handle, and then reinstall it with the desired end facing out.

Figure 1-140 Install three screws



6. Connect one HDMI cable (callout 1), and one connector (callout 2).

Figure 1-141 Connect connectors

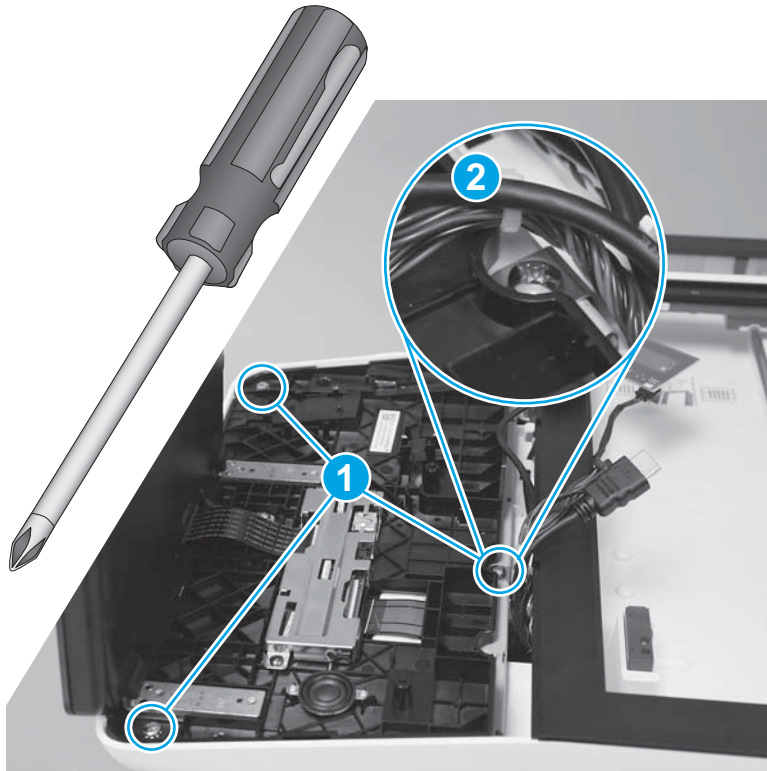

7. Install the USB cable (callout 1) in the holder.

M577z only: Install the near-field communication (NFC) printed circuit board under the four tabs (callout 2).

Figure 1-142 Install USB and NFC

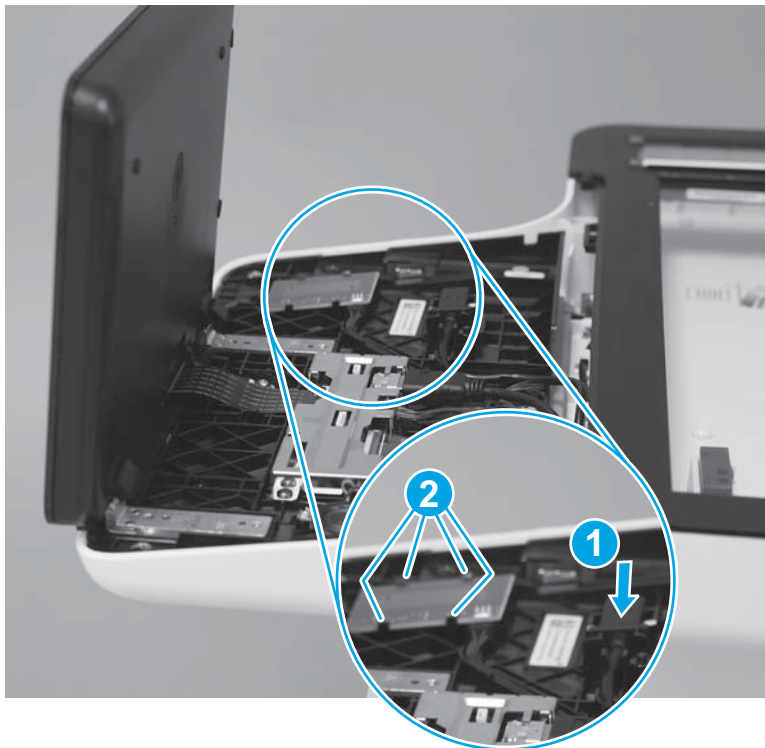

8. **M577c/z only:** Position the keyboard flat cable in the connector, and then close the latch (callout 1).

 **IMPORTANT:** Slightly tug on the cable to make sure that it is fully captured in the connector.

Figure 1-143 Connect the keyboard flat cable (M577c/z)

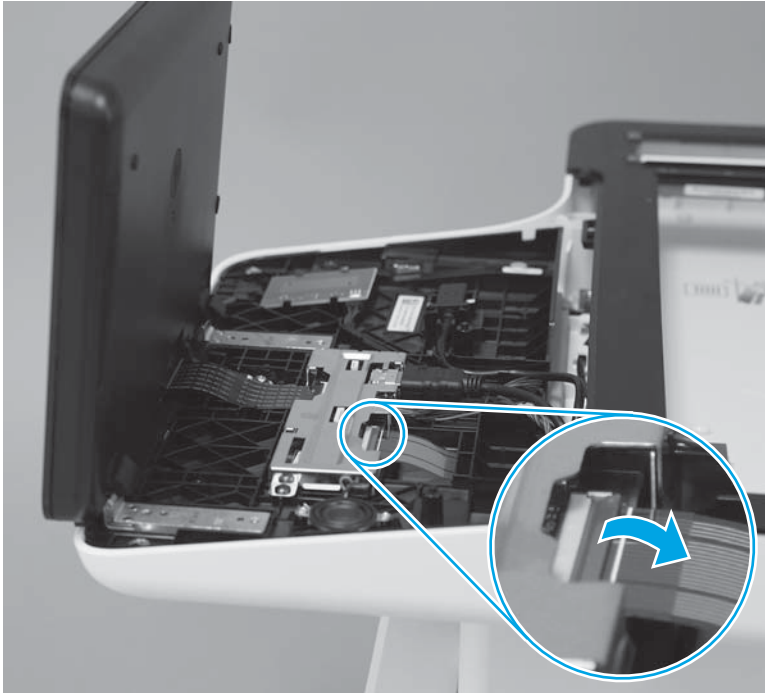

Step 5: Install the control-panel cover (M577)

1. Position the control-panel cover on the printer.

Figure 1-144 Position the control-panel cover on the printer



2. Beginning at the left side of the control-panel cover, carefully push down along the top edge of the cover to engage five tabs.

Figure 1-145 Engage five tabs

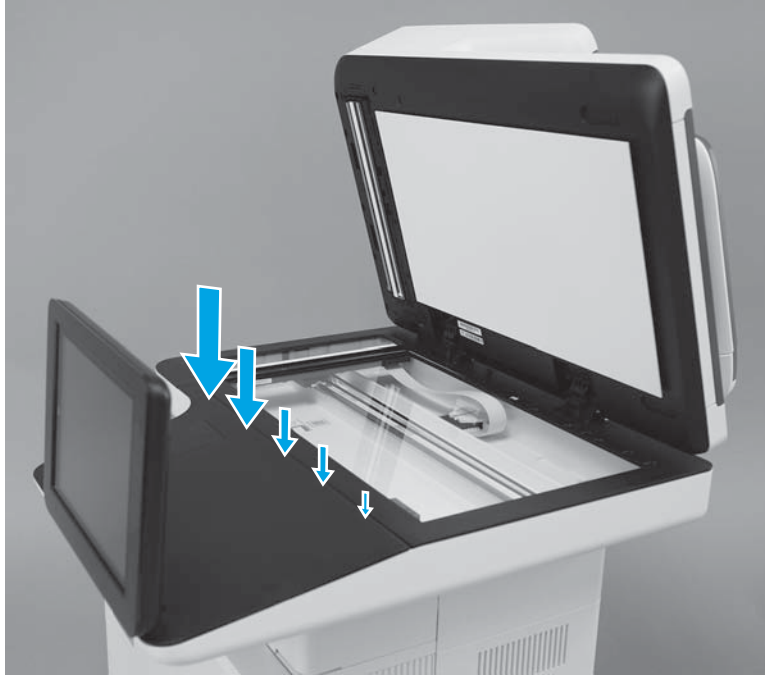

3. Close the document feeder.

 **NOTE:** Adjust the control panel to the desired angle.

Figure 1-146 Close the document feeder



Removal and replacement: Keyboard (M577c/z)

- [Introduction](#)
- [Step 1: Remove the control-panel cover \(M577\)](#)
- [Step 2: Remove the keyboard](#)
- [Step 3: Unpack the replacement assembly](#)
- [Step 4: Install the keyboard](#)
- [Step 5: Install the control-panel cover \(M577\)](#)

Introduction

This document provides the procedures to remove and replace the M577c/z keyboard.

Before performing service

Turn the printer power off

- Disconnect the power cable.

 **WARNING!** To avoid damage to the printer, turn the printer off, wait 30 seconds, and then remove the power cord before attempting to service the printer.

Use the table below to identify the correct part number for your printer. To order the part, go to www.hp.com/buy/parts.

Keyboard (M577z) part number	
B5L47-67019	US English Keyboard Kit
B5L47-67020	UK English Keyboard Kit

Required tools

- No special tools are required to replace this part.

After performing service

Turn the printer power on

- Connect the power cable.
- Use the power switch to turn the power on.

Post service test

Print a configuration page to make sure that the printer is functioning correctly.

Step 1: Remove the control-panel cover (M577)

1. Open the document feeder (callout 1).

 **NOTE:** If the control panel is not fully tilted forward, tilt it forward now until it stops (callout 2).

Figure 1-147 Open the document feeder



2. Beginning at the right side of the control-panel cover, carefully release five tabs along the top edge of the cover.



NOTE: The thin, black plastic cover will separate from the white plastic control-panel base.

Figure 1-148 Release five tabs



3. Continue to lift the top edge of the cover away from the printer, and then remove the cover.

Figure 1-149 Remove the cover



Step 2: Remove the keyboard

1. Open the latch (callout 1) to release the keyboard flat cable.

CAUTION: The latch must be opened to release the cable.

Figure 1-150 Disconnect the keyboard flat cable

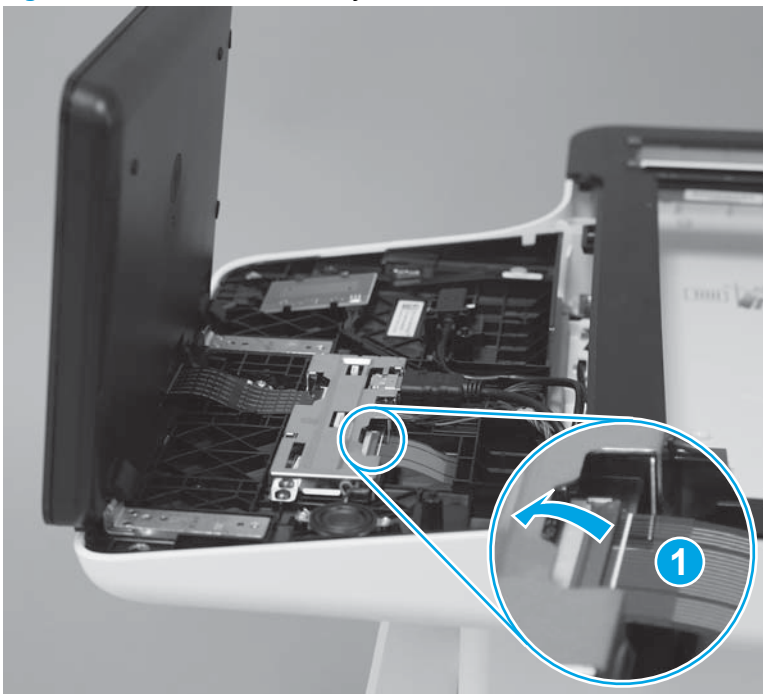

2. Slide the keyboard tray out until it stops.

Figure 1-151 Slide the keyboard out



3. Push up on the keyboard tray to release two tabs on the bottom of the tray, and then slide the tray toward the front of the printer to disengage the tabs.

Figure 1-152 Release two tabs

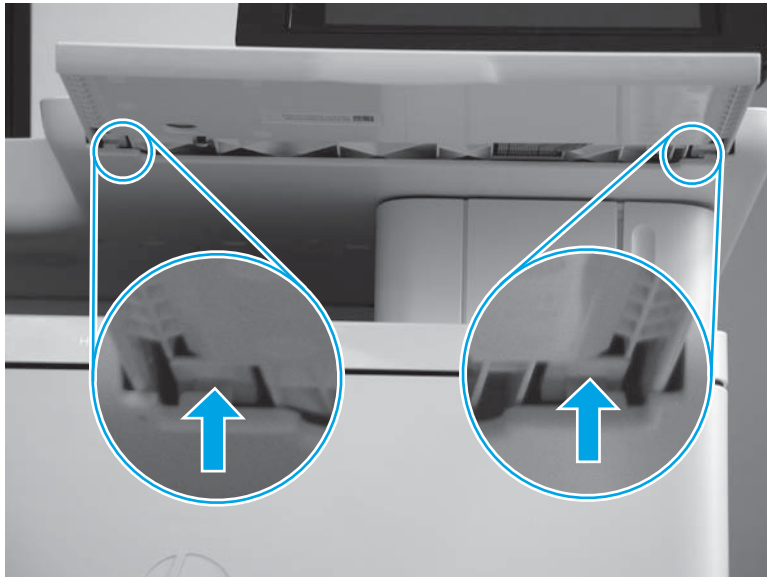

- Slide the keyboard (callout 1) all of the way out of the printer to remove it.

Figure 1-153 Remove the keyboard



Step 3: Unpack the replacement assembly

Unpack the replacement assembly from the packaging.

For complete information on HP's recycling programs, go to [Product return and recycling](#).

 **NOTE:** HP recommends responsible disposal of the defective assembly.

Figure 1-154 Recycle and unpack

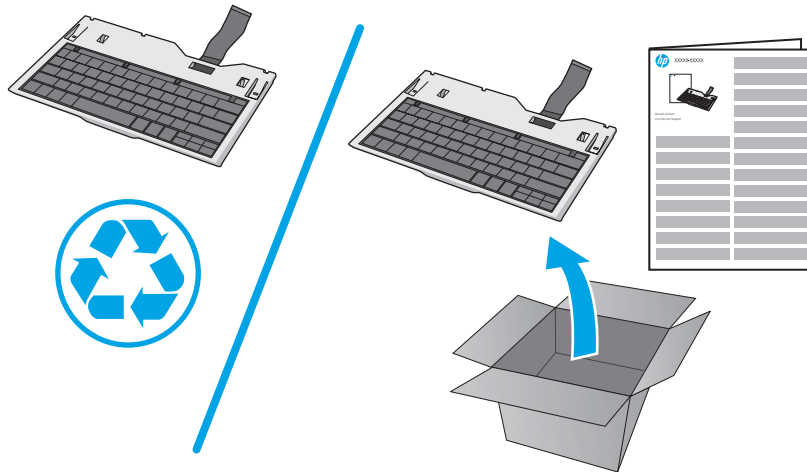

Step 4: Install the keyboard

- Position the flat cable (callout 1) on the keyboard into the keyboard slot (callout 2).

Figure 1-155 Install the flat cable through the slot



2. Slide the keyboard tray into the slot.

 **NOTE:** Only slide the tray halfway into the opening. This makes connecting the cable in the next step easier.

Figure 1-156 Slide the keyboard into the slot



3. If the flat cable (callout 1) is not in the opening (callout 2) in the control panel base, carefully reach in and thread the flat cable through the opening.

Figure 1-157 Check the flat cable

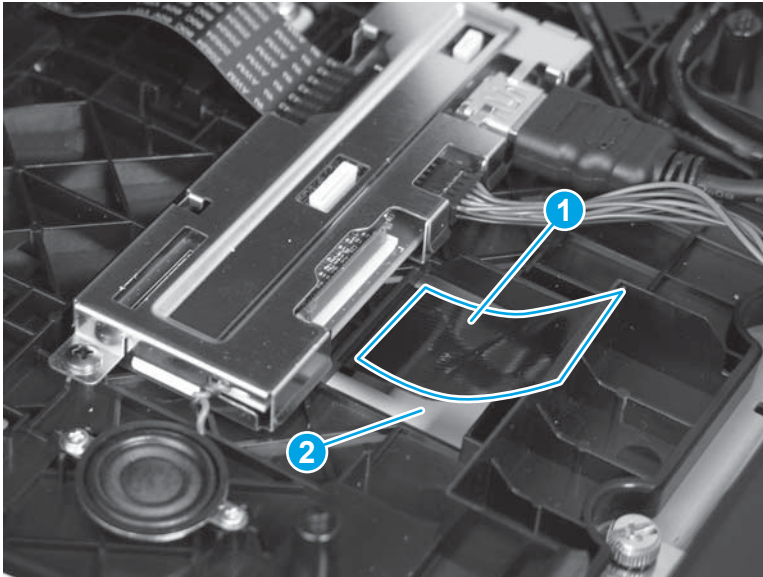

4. Position the keyboard flat cable in the connector, and then close the connector latch.

 **IMPORTANT:** Slightly tug on the cable to make sure that it is fully captured in the connector.

 **NOTE:** When the connector latch is closed and the cable is correctly installed, the white line on the cable is parallel to the connector latch.

Figure 1-158 Connect the flat cable



Step 5: Install the control-panel cover (M577)

1. Position the control-panel cover on the printer.

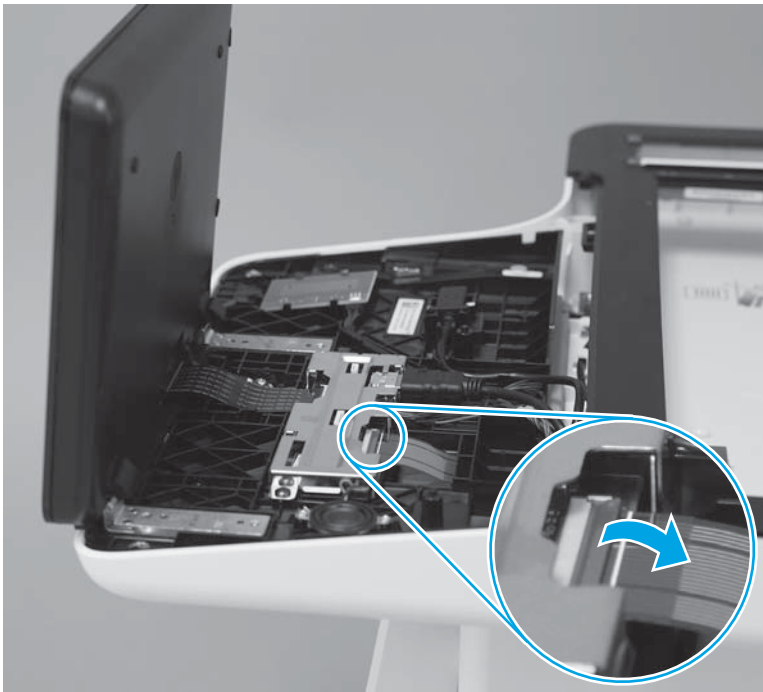
Figure 1-159 Position the control-panel cover on the printer



2. Beginning at the left side of the control-panel cover, carefully push down along the top edge of the cover to engage five tabs.

Figure 1-160 Engage five tabs

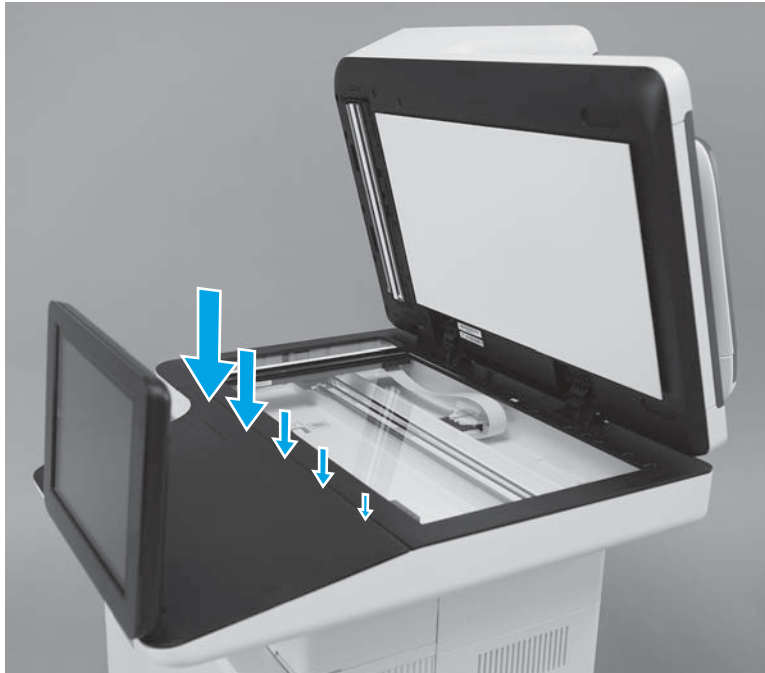

3. Close the document feeder.

 **NOTE:** Adjust the control panel to the desired angle.

Figure 1-161 Close the document feeder



Removal and replacement: White backing (M577)



NOTE: M577 printers only.

- [Introduction](#)
- [Step 1: Remove the white backing \(M577\)](#)
- [Step 2: Unpack the replacement assembly](#)
- [Step 3: Install the white backing \(M577\)](#)

Introduction

This document provides the procedures to remove and replace the M577 white backing.

Before performing service

Turn the printer power off

- Disconnect the power cable.



WARNING! To avoid damage to the printer, turn the printer off, wait 30 seconds, and then remove the power cord before attempting to service the printer.

Use the table below to identify the correct part number for your printer. To order the part, go to www.hp.com/buy/parts.

White backing (M577) part number	
5851-6570	White backing kit (M577) with instruction guide

Required tools

No special tools are required for this assembly.

After performing service

Turn the printer power on

- Connect the power cable.
- Use the power switch to turn the power on.

Step 1: Remove the white backing (M577)

1. Open the document feeder.

Figure 1-162 Open the document feeder



2. Remove the white backing.

Figure 1-163 Remove the white backing



3. One or more of the retention clips (callout 1) that fit in the openings (callout 2) in the document feeder might remain attached to the white backing when it is removed. If this happens, remove the clip from the white backing.

 **NOTE:** If none of the retention clips remain attached to the white backing, skip the remaining sub-steps in this removal procedure.

Figure 1-164 Check the retention clips



4. If a spring comes off of a retention clip, make sure that it is correctly repositioned on the clip.

 **NOTE:** If any of the retention clips or springs are damaged, replace them with the clips supplied in this kit.

Figure 1-165 Check the retention clip spring



5. Install the clip (callout 1) in the opening (callout 2) in the document feeder.

Figure 1-166 Install the retention clip

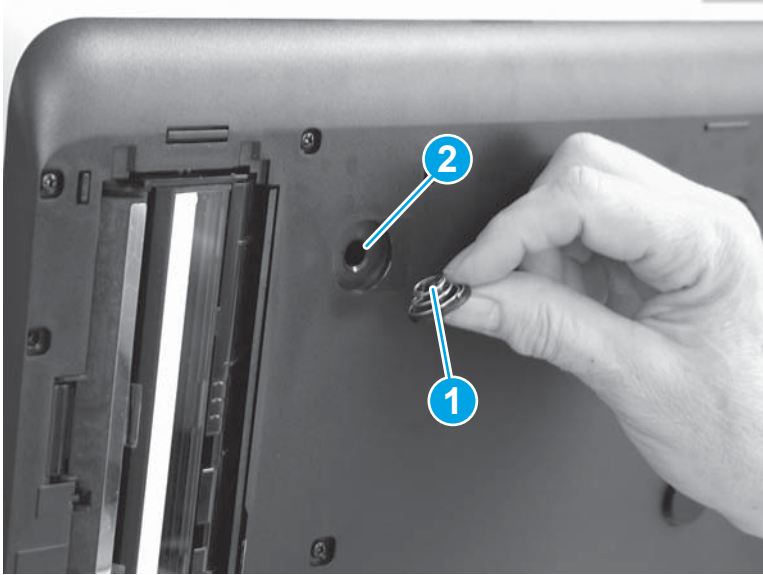

6. Press the clip to make sure it is securely installed.

Figure 1-167 Press the retention clip

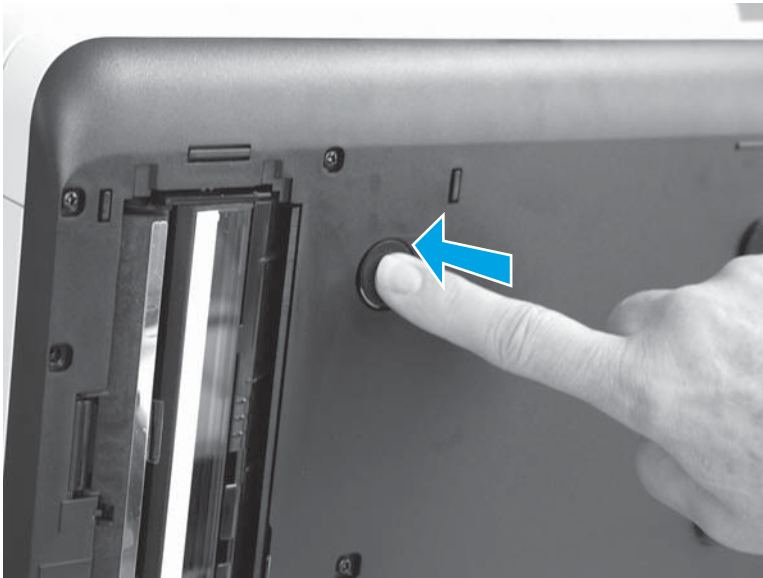

Step 2: Unpack the replacement assembly

Unpack the replacement assembly from the packaging.

For complete information on HP's recycling programs, go to [Product return and recycling](#)

 **NOTE:** HP recommends responsible disposal of the defective assembly.

Figure 1-168 Recycle and unpack



Step 3: Install the white backing (M577)

1. Open the document feeder, and then place the replacement white backing on the flatbed scanner glass, as shown.

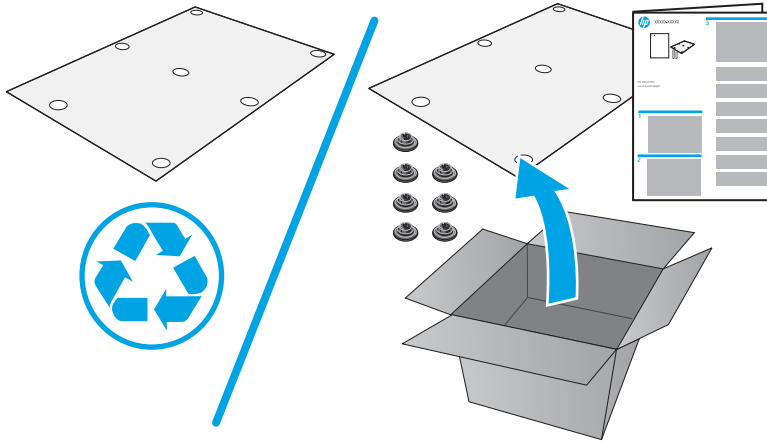
 **NOTE:** Place the corner of the backing that does not have a hook-and-loop fastener in the upper-left corner of the scanner glass.

Figure 1-169 Install the white backing



2. Close the document feeder.

Figure 1-170 Close the document feeder

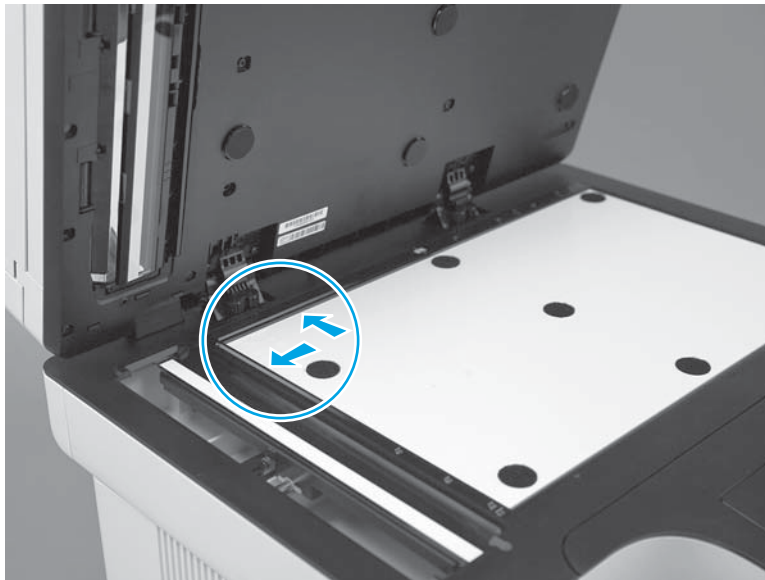
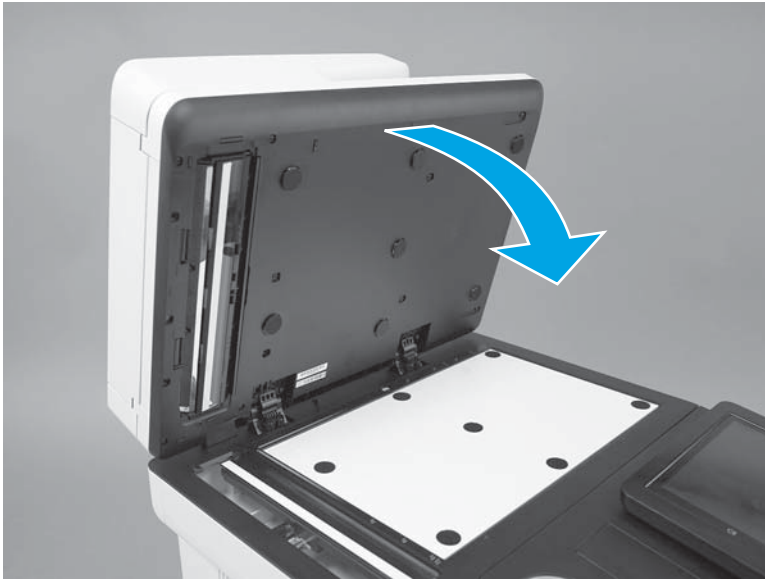

3. Open the document feeder and make sure that the white backing is securely attached.

Figure 1-171 Check the white backing



4. Close the document feeder.

Figure 1-172 Close the document feeder



Removal and replacement: Retention clips (M577)

- [Introduction](#)
- [Step 1: Remove the retention clips](#)
- [Step 2: Unpack the replacement assembly](#)
- [Step 3: Install the retention clips](#)

Introduction

This document provides the procedures to remove and replace the M577 retention clips.

Before performing service

Turn the printer power off

- Disconnect the power cable.

 **WARNING!** To avoid damage to the printer, turn the printer off, wait 30 seconds, and then remove the power cord before attempting to service the printer.

Use the table below to identify the correct part number for your printer. To order the part, go to www.hp.com/buy/parts.

Retention clips (M577) part number

5851-6573

Retention clips kit (M577) with instruction guide

Required tools

No special tools are required for this assembly.

After performing service

Turn the printer power on

- Connect the power cable.
- Use the power switch to turn the power on.

Step 1: Remove the retention clips

1. Open the document feeder.

Figure 1-173 Open the document feeder



2. Remove the white backing.

Figure 1-174 Remove the white backing



3. If any of the retention clips (callout 1) remain attached to the white backing remove them.

 **NOTE:** If none of the retention clips remain attached to the white backing, skip to Step 4.

Figure 1-175 Check the retention clips



4. Remove any damaged retention clips from the document feeder.

 **TIP:** Use the edge of a coin to loosen the clip.

Figure 1-176 Loosen damaged clips



5. Remove the retention clip (callout 1).

Figure 1-177 Remove the retention clip

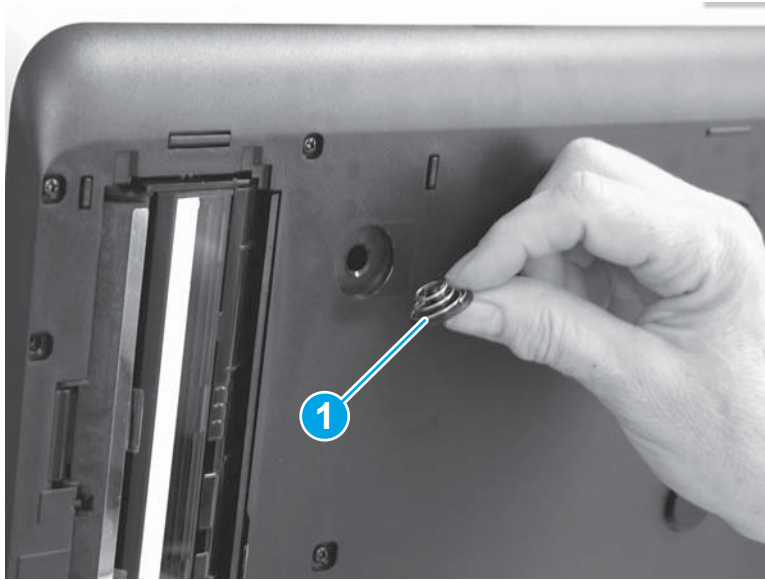

Step 2: Unpack the replacement assembly

Unpack the replacement assembly from the packaging.

For complete information on HP's recycling programs, go to [Product return and recycling](#).

 **NOTE:** HP recommends responsible disposal of the defective assembly.

Figure 1-178 Recycle and unpack

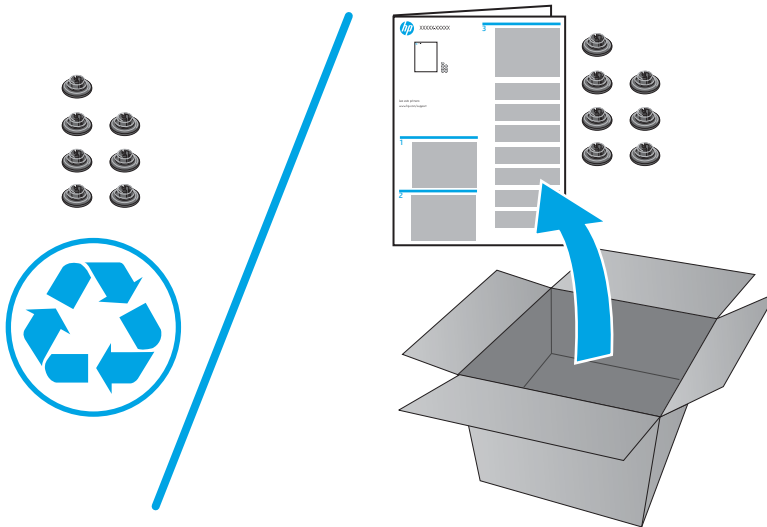

Step 3: Install the retention clips

1. If a spring comes off of a retention clip, make sure that it is correctly repositioned on the clip.

Figure 1-179 Check the retention clip spring



2. Install the clip (callout 1) in the opening (callout 2) in the document feeder. Repeat this step until all of the retention clips are installed.

Figure 1-180 Install the retention clip

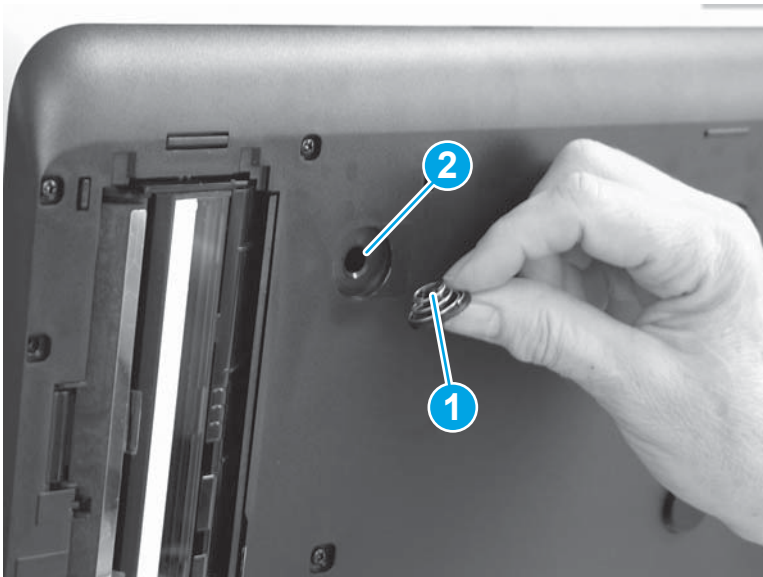

3. Press the clip to make sure it is securely installed. Repeat this step until all of the retention clips are secure.

Figure 1-181 Press the retention clip

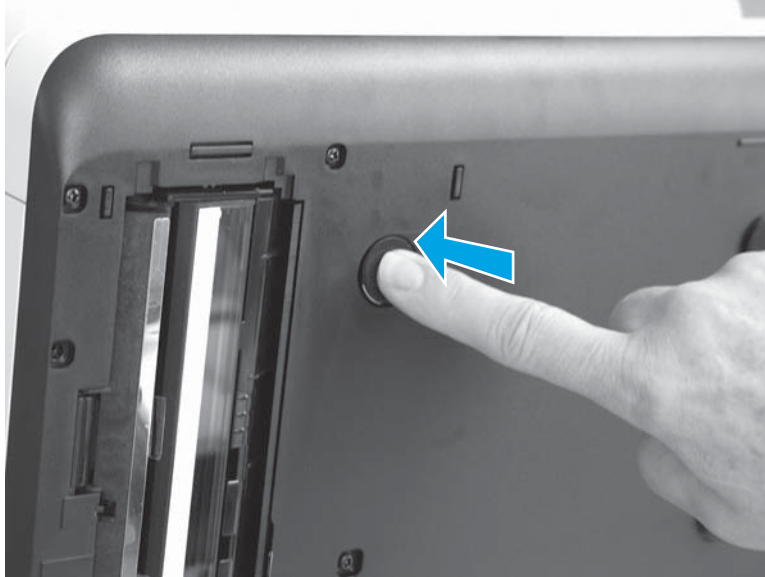

4. Place the white backing, on the flatbed scanner glass as shown.

 **NOTE:** Place the corner of the backing that does not have a hook-and-loop fastener in the upper-left corner of the scanner glass.

Figure 1-182 Install the white backing



5. Close the document feeder.

Figure 1-183 Close the document feeder

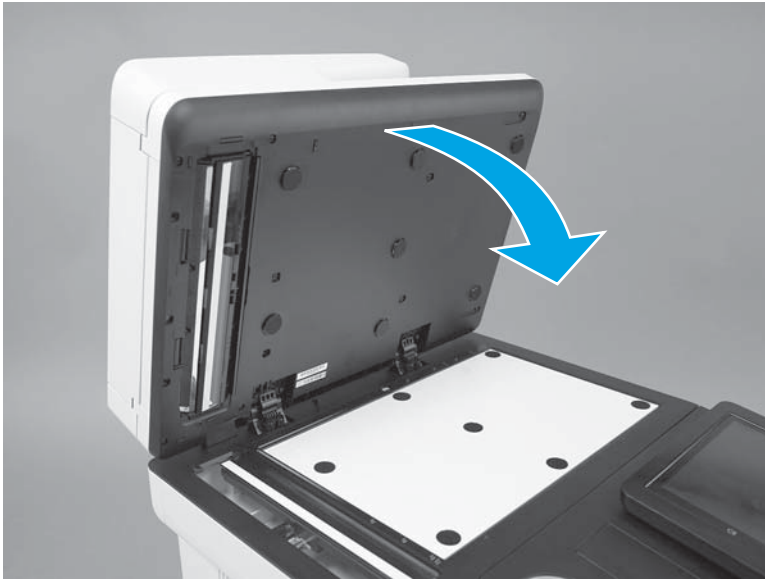

6. Open the document feeder and make sure that the white backing is securely attached.

Figure 1-184 Check the white backing



7. Close the document feeder.

Figure 1-185 Close the document feeder



Removal and replacement: Document feeder rollers (M577)

- [Introduction](#)
- [Step 1: Remove the pickup and feed roller assembly](#)
- [Step 2: Remove the separation roller](#)
- [Step 3: Unpack the replacement assemblies](#)
- [Step 4: Install the separation roller](#)
- [Step 5: Install the pickup and feed roller assembly](#)
- [Step 6: Reset the document feeder kit count](#)

Introduction

This document provides the procedures to remove and replace the document feeder rollers (M577).

Before performing service

Turn the printer power off

- Disconnect the power cable.

 **WARNING!** To avoid damage to the printer, turn the printer off, wait 30 seconds, and then remove the power cord before attempting to service the printer.

Use the table below to identify the correct part number for your printer. To order the part, go to www.hp.com/buy/parts.

Document feeder rollers (M527) part number	
--	--

B5L52-67903

ADF maintenance kit (M577) with instruction guide

Required tools

- No special tools are required to remove this part.

After performing service

Turn the printer power on

- Connect the power cable.
- Use the power switch to turn the power on.

Post service test

Copy a page from the document feeder to make sure that the printer is functioning correctly.

Step 1: Remove the pickup and feed roller assembly

1. Open the document-feeder jam access door.

Figure 1-186 Open the document-feeder jam access door



2. Release the blue locking arm.

Figure 1-187 Release the blue locking arm

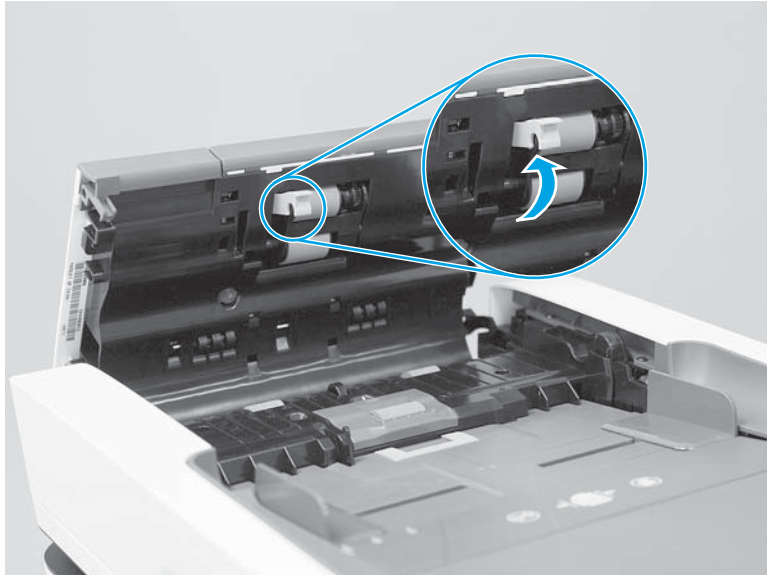

3. Slide the pickup and feed roller assembly to the left (callout 1), and then pull it away from the document feeder (callout 2) to remove it.

Figure 1-188 Remove the roller assembly

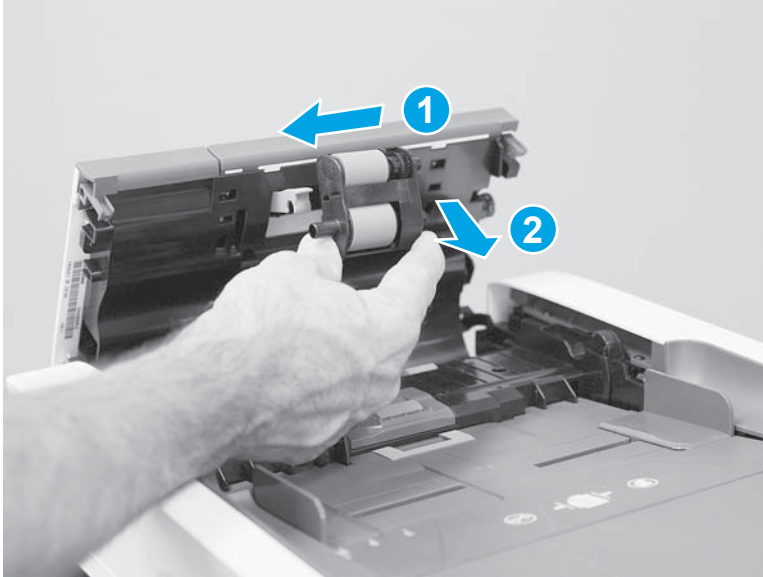

Step 2: Remove the separation roller

1. Rotate the top edge of the separation roller cover away from the printer to release it.

Figure 1-189 Release the separation roller cover



2. Remove the cover.

Figure 1-190 Remove the cover



3. Slide the separation roller to the left, and then lift it up and away from the document feeder to remove it.

Figure 1-191 Remove the roller



Step 3: Unpack the replacement assemblies

Unpack the replacement assemblies from the packaging.

For complete information on HP's recycling programs, go to [Product return and recycling](#).

CAUTION: Avoid touching the rollers. Skin oils deposited on the rollers might cause print quality problems. HP recommends washing your hands before handling the rollers.

NOTE: HP recommends responsible disposal of the defective assemblies.

Figure 1-192 Recycle and unpack

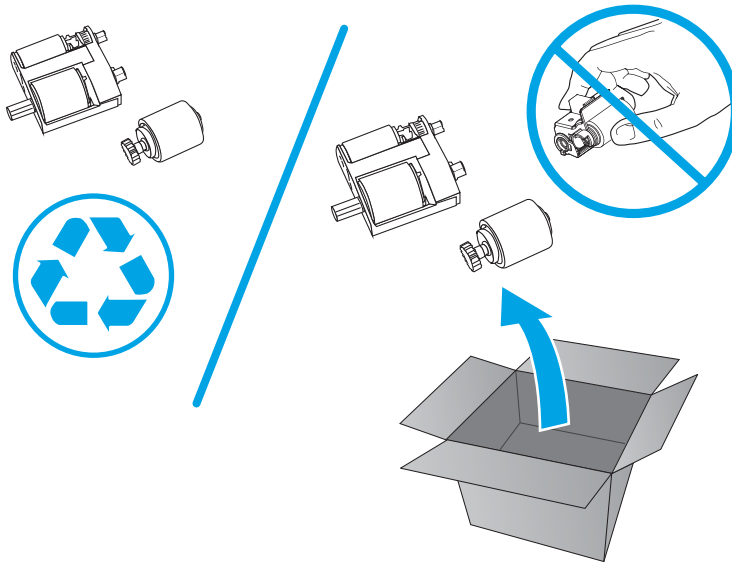

Step 4: Install the separation roller

1. Lower the separation roller into the document feeder, and then slide it to the right to install it.

Figure 1-193 Install the roller

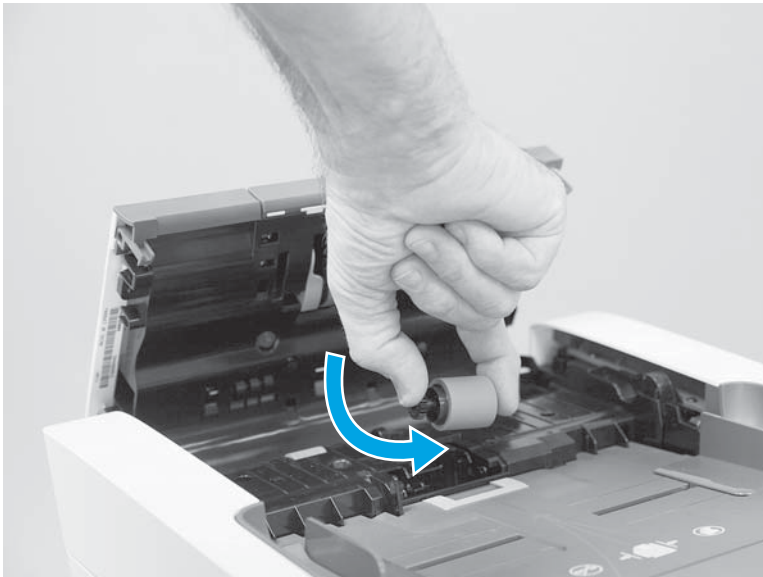

2. Position the bottom edge of the separation roller cover on the printer.

Figure 1-194 Position the separation roller cover



3. Rotate the cover down to close it.

Figure 1-195 Close the separation roller cover

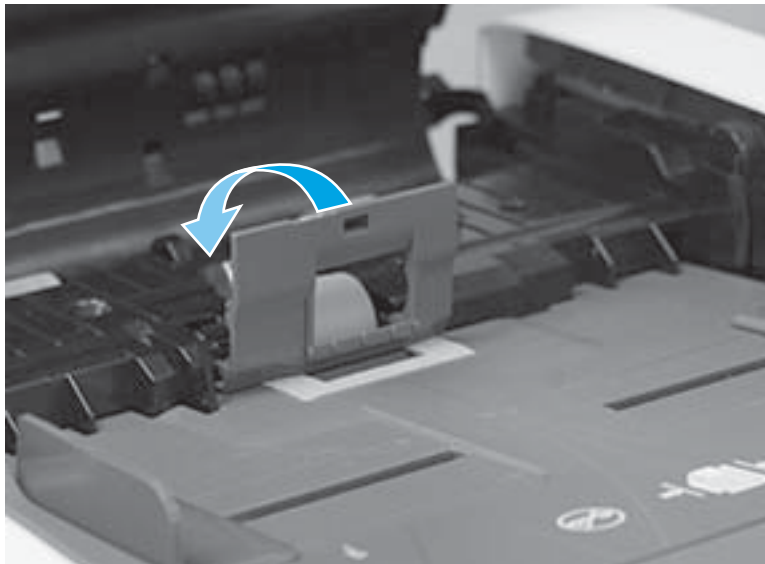

4. The roller might seem loose until the cover is snapped closed. The cover helps hold the roller in place.

Figure 1-196 Snap the cover closed



Step 5: Install the pickup and feed roller assembly

1. Position the pickup and feed roller assembly in the document feeder (callout 1), and then slide the assembly to the right (callout 2) to install it.

Figure 1-197 Install the roller assembly

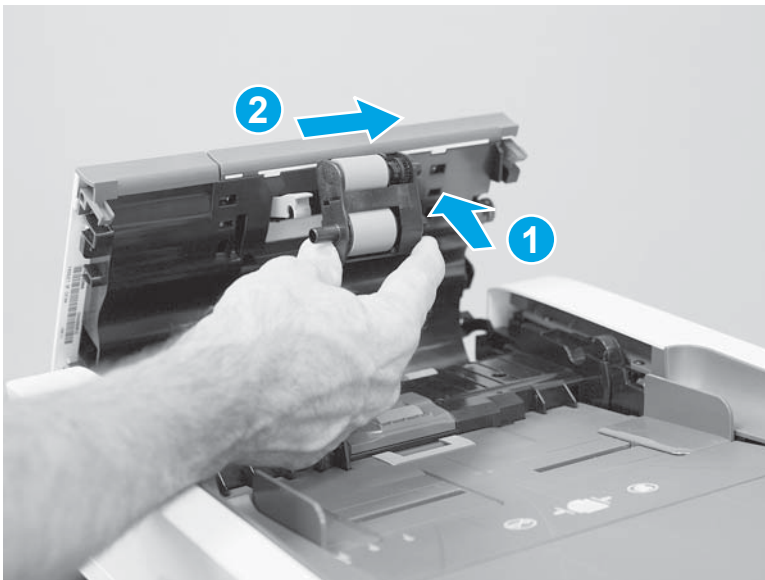

2. Close the blue locking arm.

Figure 1-198 Close the blue locking arm

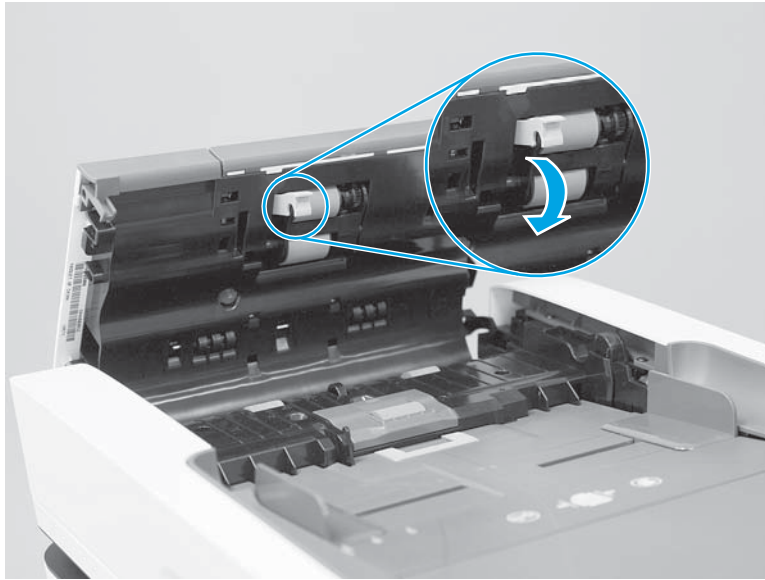

3. Close the document-feeder jam access door.

Figure 1-199 Close the document-feeder jam access door



Step 6: Reset the document feeder kit count

1. From the Home screen on the control panel, scroll to and touch the **Administration** button.
2. Open the following menus:

- [Manage Supplies](#)
 - [Reset Supplies](#)
 - [New Document Feeder Kit](#)
3. Select the [Reset](#) item to reset the firmware counter.

Customer self-repair (CSR) B parts and assemblies

- [Removal and replacement: Tray 2-X paper pickup roller and separation roller assemblies](#)
- [Removal and replacement: Intermediate transfer belt \(ITB\)](#)
- [Removal and replacement: Intermediate transfer belt \(ITB\) and secondary transfer roller](#)

The CSR level indicates the expected difficulty the customer will experience when removing and replacing an assembly. The CSR B assemblies in this section might be difficult for the customer to remove and replace.

Removal and replacement: Tray 2-X paper pickup roller and separation roller assemblies

- [Introduction](#)
- [Step 1: Remove the Tray 2-X paper pickup roller assembly](#)
- [Step 2: Remove the Tray 2-X separation roller](#)
- [Step 3: Unpack the replacement assemblies](#)
- [Step 4: Install the Tray 2-X separation roller](#)
- [Step 5: Install the Tray 2-X paper pickup roller assembly](#)

Introduction

This document provides the procedures to remove and replace the Tray 2/3/4/5 pickup, feed, and separation rollers.

Before performing service



NOTE: The procedure in this section shows Tray 2 in the figures. However, this procedure is also correct for Tray 3, Tray 4, or Tray 5.

Turn the printer power off

- Disconnect the power cable.



WARNING! To avoid damage to the printer, turn the printer off, wait 30 seconds, and then remove the power cord before attempting to service the printer.

Use the table below to identify the correct part number for your printer. To order the part, go to www.hp.com/buy/parts.

Tray 2 - X pickup, feed, and separation rollers kit part number

85L24-67904Tray 2 - X pickup and feed rollers with instruction guide

Required tools

No special tools are required to install this part.

After performing service

Make sure that the tray is fully closed after replacing the rollers.

Turn the printer power on

- Connect the power cable.
- Use the power switch to turn the power on.

Post service test

Print a configuration page to make sure that the printer is functioning correctly.

Step 1: Remove the Tray 2-X paper pickup roller assembly

 **NOTE:** The procedure in this section shows Tray 2 in the figures. However, this procedure is also correct for Tray 3, Tray 4, or Tray 5.

1. Pull the tray out until it stops.

Figure 1-200 Pull the tray out



2. Lift the front of the tray, and then pull it out of the printer to remove it.

Figure 1-201 Remove the tray

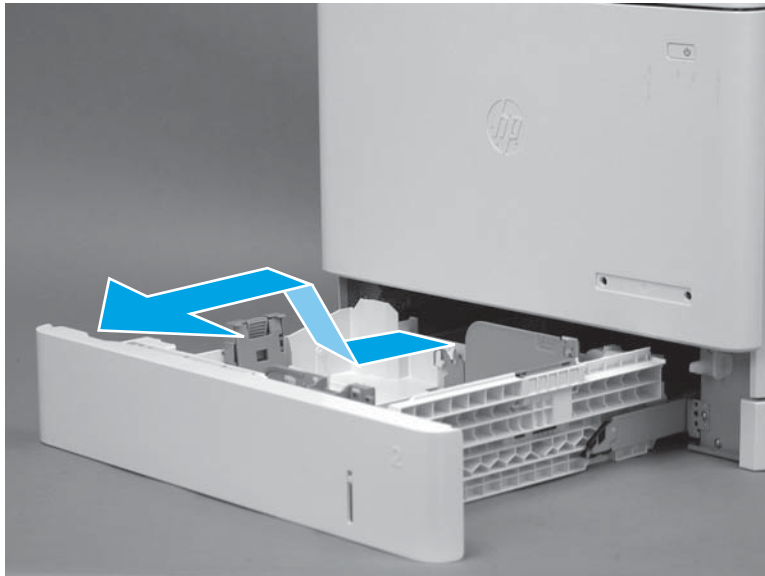

3. Open the right door.

Figure 1-202 Open the right door



4. Carefully raise the transfer roller assembly up and into the printer.

Figure 1-203 Raise the transfer roller assembly

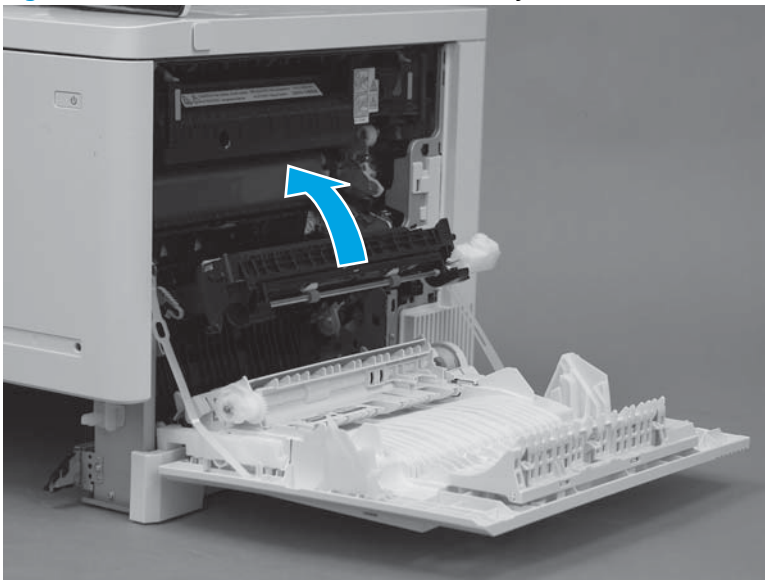

5. Release the green handle (callout 1), and then lower the paper guide (callout 2).

Figure 1-204 Lower the paper guide

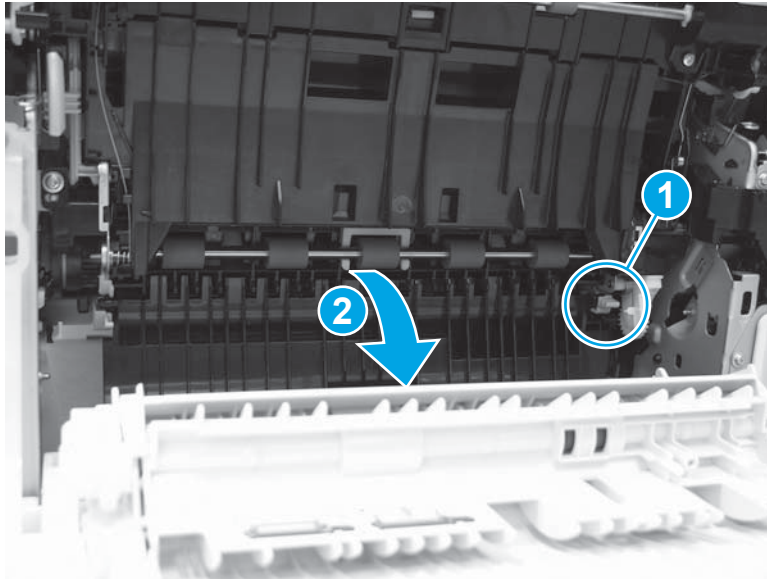

6. Locate the tray pickup roller assembly.

Figure 1-205 Locate the tray pickup roller

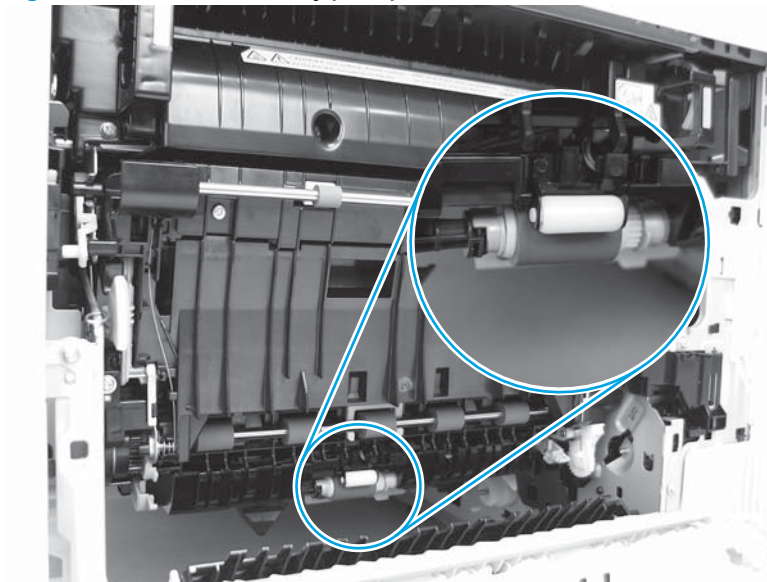

- 7. Trays 3, 4, or 5 only:** Release the latch (callout 1), and then open the right door (callout 2).

Figure 1-206 Open the Tray 3, 4, or 5 right door

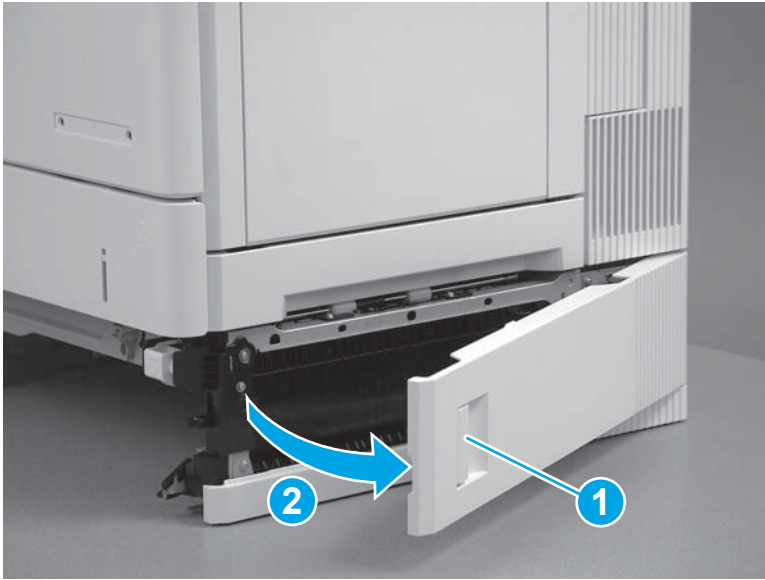

- 8. Trays 3, 4, or 5 only:** Release the green handle (callout 1), and then lower the paper guide (callout 2).

Figure 1-207 Lower the Tray 3, 4, or 5 paper guide

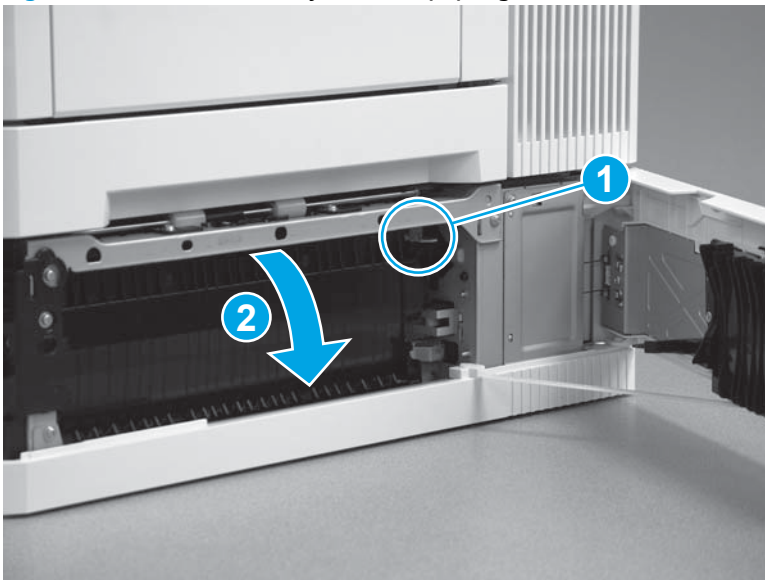

9. **Trays 3, 4, or 5 only:** Locate the tray pickup roller assembly.

Figure 1-208 Locate the Tray 3, 4, or 5 pickup roller assembly

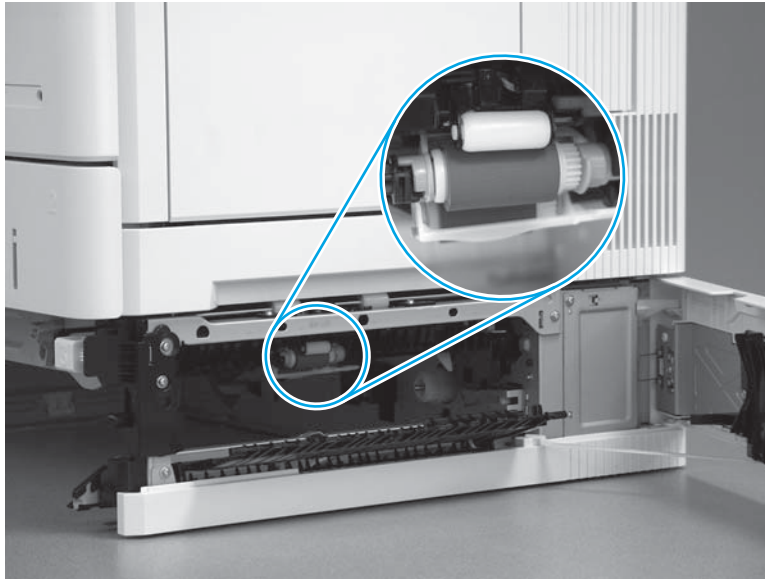

10. Slide the assembly to the left to compress the spring loaded shaft (callout 1), and then rotate the right end of the assembly down and away from the printer (callout 2).

 **TIP:** It might be easier to access the roller through the tray cavity, while viewing it through the right door opening.

Figure 1-209 Slide the assembly to the left

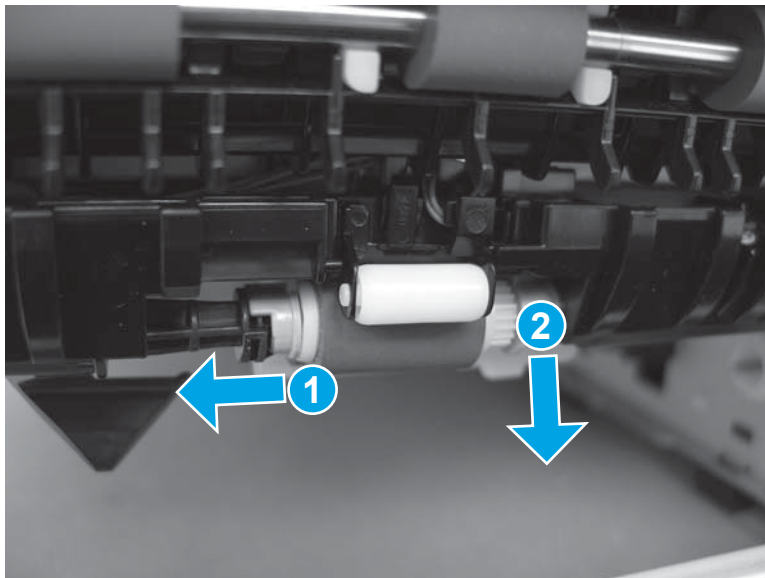

11. Remove the roller assembly.

Figure 1-210 Remove the roller assembly

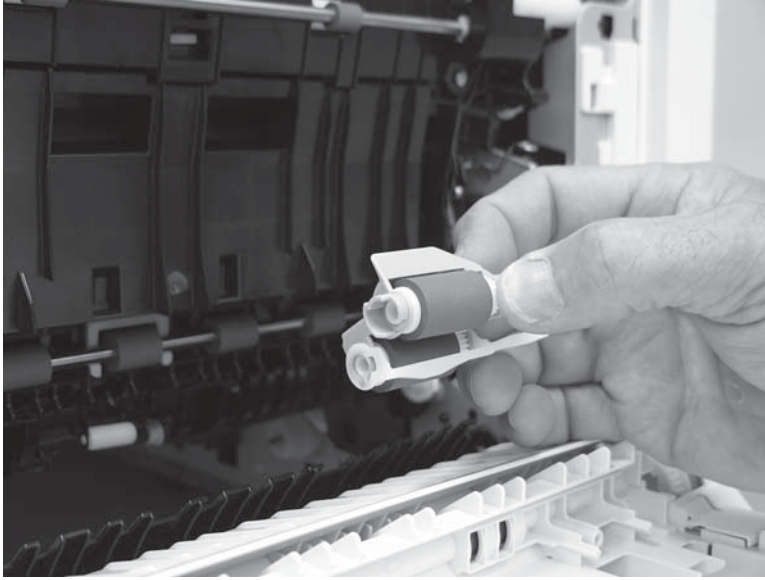

Step 2: Remove the Tray 2-X separation roller

1. Locate the tray separation roller.

Figure 1-211 Locate the roller assembly

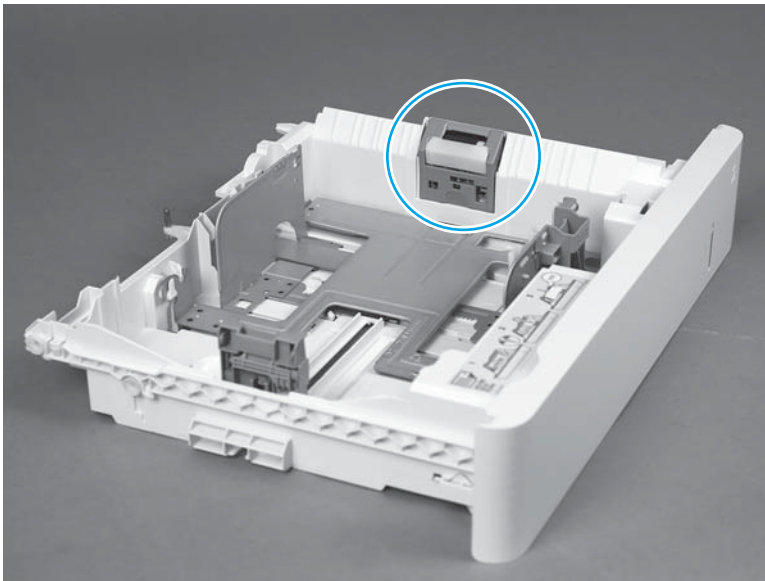

2. Push up on the blue label to release the roller assembly.

Figure 1-212 Push up on the blue label

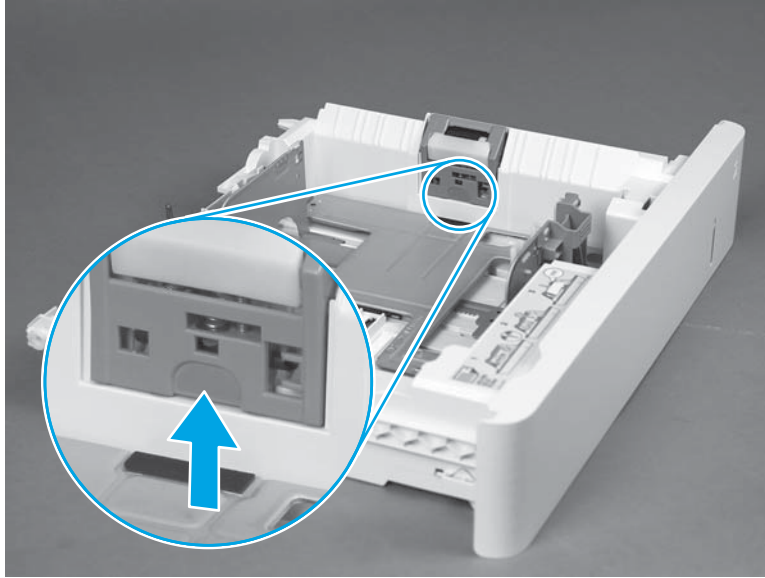

3. Slide the roller assembly straight up to remove it.

Figure 1-213 Remove the roller assembly

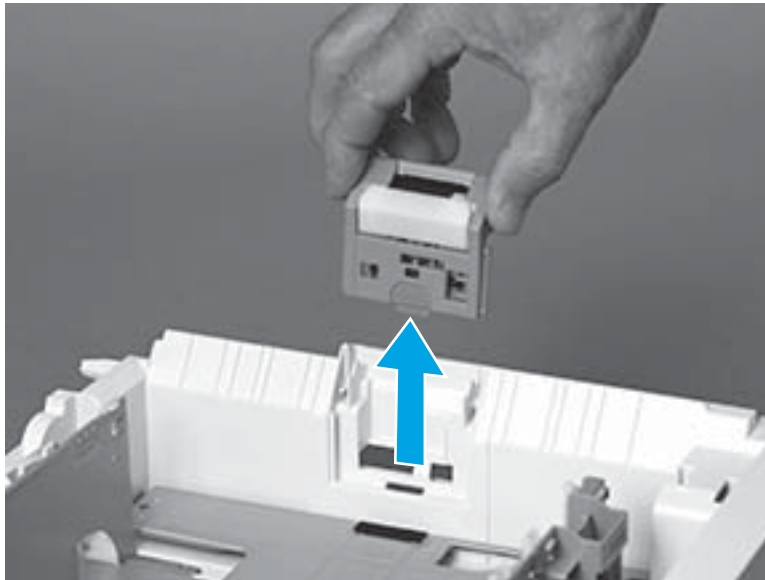

Step 3: Unpack the replacement assemblies

Unpack the replacement assemblies from the packaging.

CAUTION: Avoid touching the surface of the replacement rollers. Skin oils on the rollers can cause print-quality problems. Thoroughly wash your hands with soap and water to remove skin oils, and then completely dry them.

For complete information on HP's recycling programs, go to [Product return and recycling](#).

NOTE: HP recommends responsible disposal of the defective assemblies.

Figure 1-214 Recycle and unpack

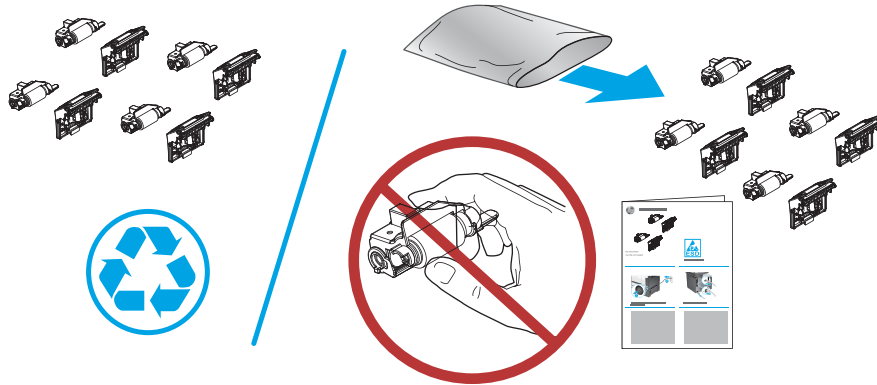

Step 4: Install the Tray 2-X separation roller

1. Slide the roller assembly straight into the tray to install it.

Figure 1-215 Install the roller assembly

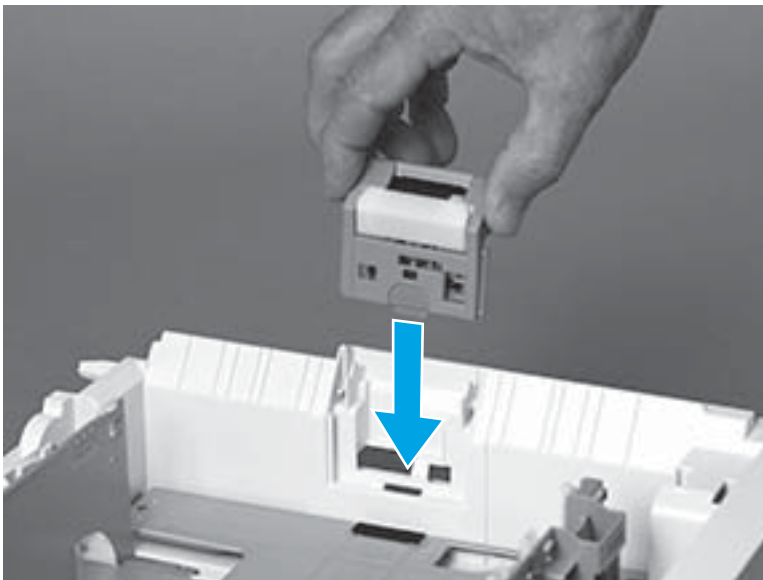

2. Make sure that the roller assembly is fully seated.

Figure 1-216 Fully seat the roller assembly

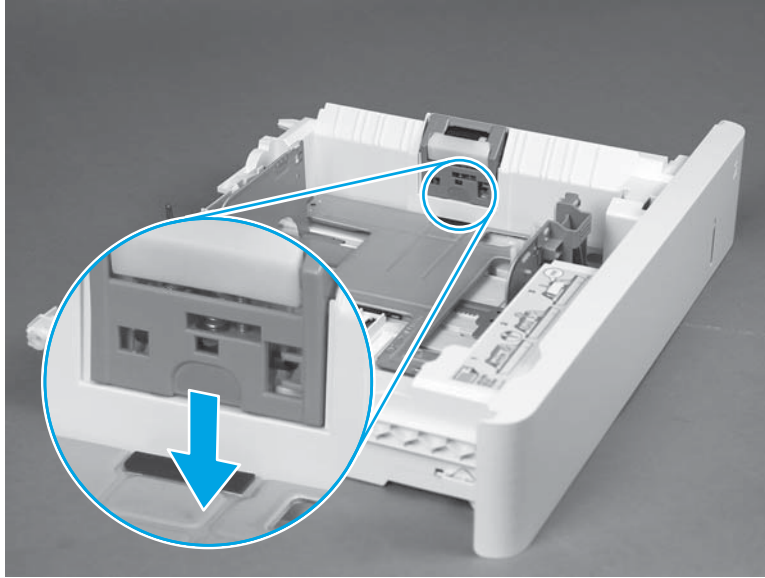

3. Verify that the roller assembly is correctly installed—it should be firmly attached to the tray.

Figure 1-217 Check the installation

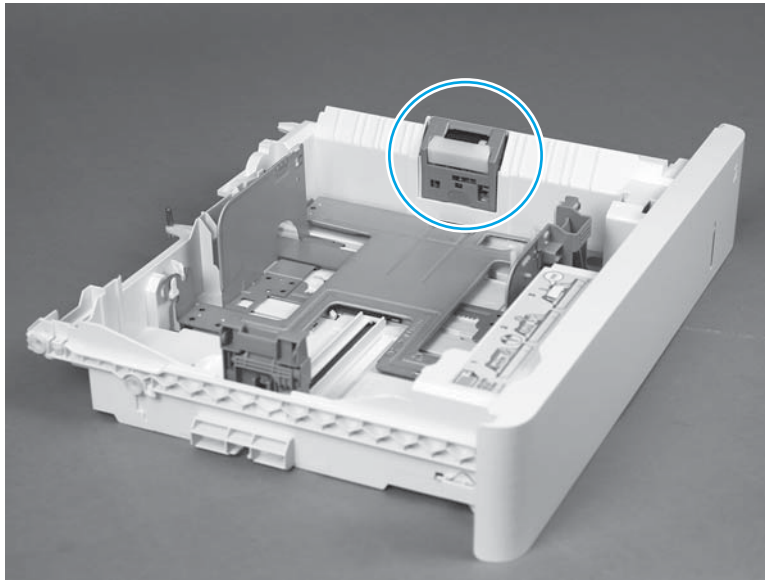

Step 5: Install the Tray 2-X paper pickup roller assembly

1. Before proceeding, take note of the mounting tab (callout 1) on the replacement roller assembly.



IMPORTANT: When correctly installed, a black-plastic protrusion in the printer fits into this tab to hold the roller in the upright position.

Figure 1-218 Note the mounting tab

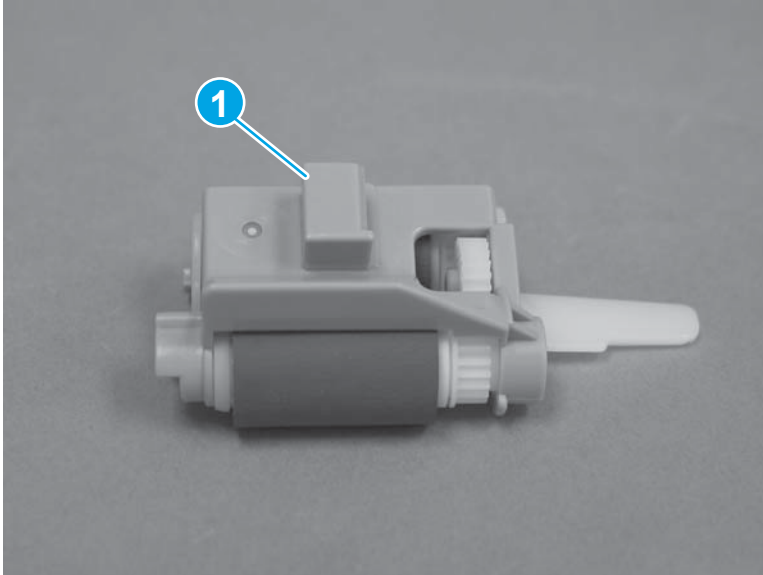

2. Position the roller assembly in the printer with the spring loaded shaft compressed (callout 1), and then rotate the right end of the assembly up and into the printer (callout 2).

 **TIP:** It might be easier to access the roller through the tray cavity, while viewing it through the right door opening.

Figure 1-219 Position the roller assembly in the printer

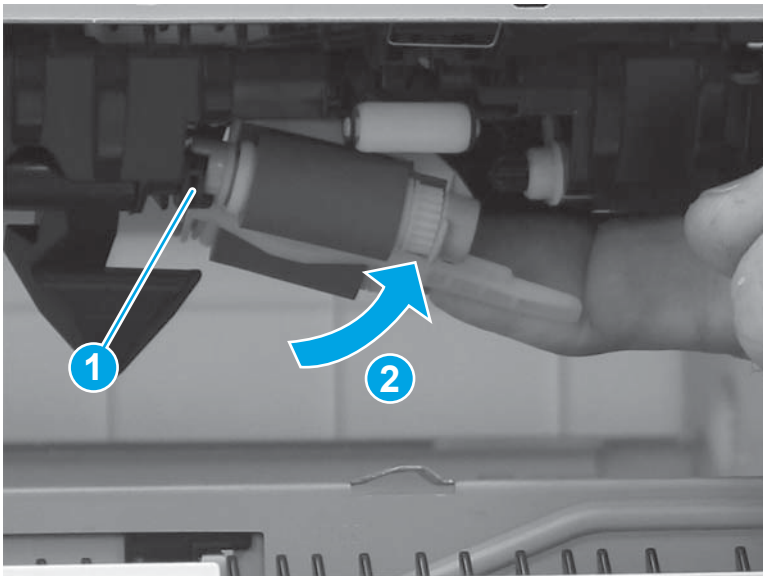

3. Carefully release the spring loaded shaft (callout 1) with the roller in place. The collar (callout 2) on the assembly fits over the bushing (callout 3) in the printer.

Figure 1-220 Release the spring loaded shaft

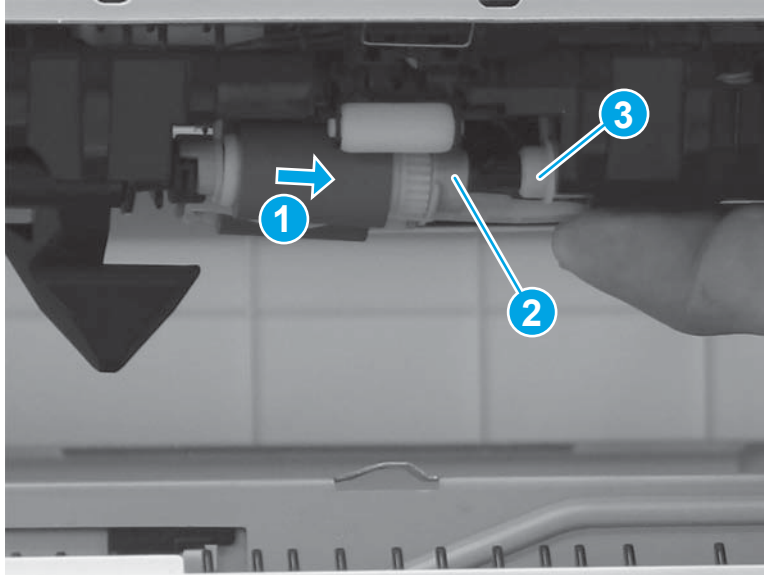

4. Make sure that the roller assembly is correctly installed. It must not hang down into the tray cavity. If the roller hangs down into the tray cavity, remove it, and then reinstall it.

⚠ CAUTION: If the roller assembly is not correctly installed, it will be damaged when the tray is installed.

Figure 1-221 Verify the roller installation

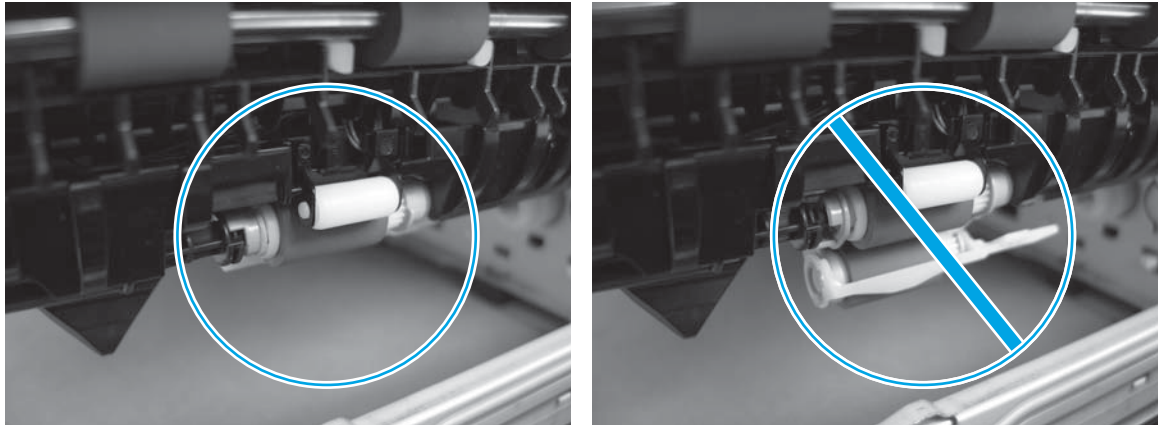

5. **Trays 3, 4, or 5 only:** Raise the paper guide.

Figure 1-222 Raise the Tray 3, 4, or 5 paper guide

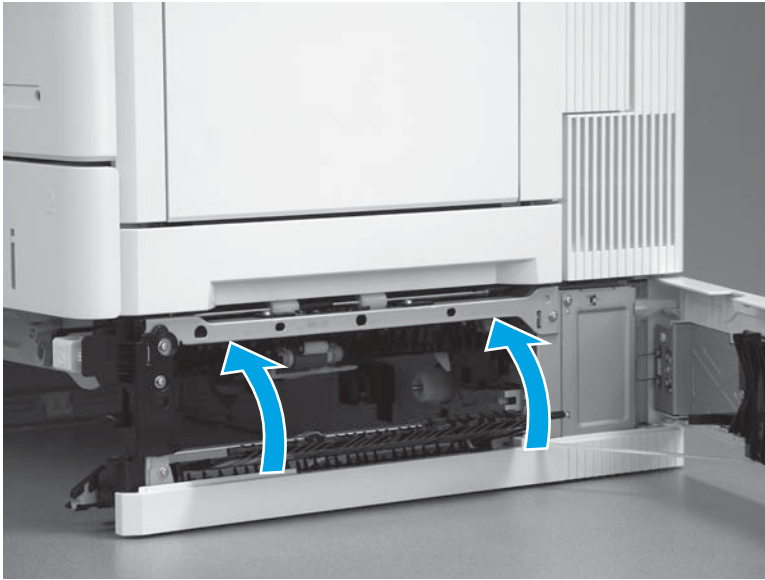

6. **Trays 3, 4, or 5 only:** Close the right door.

Figure 1-223 Close the Tray 3, 4, or 5 right door



7. Close the right door.

Figure 1-224 Close the right door



8. With the front of the tray slightly lifted, align the sides of the tray with the rails in the printer, and then carefully slide the tray into the printer.

 **TIP:** As the tray slides into the printer, lower the front of it.

Figure 1-225 Install the tray



9. Close the tray.

Figure 1-226 Close the tray



Removal and replacement: Intermediate transfer belt (ITB)

- [Introduction](#)
- [Step 1: Remove the ITB](#)
- [Step 2: Unpack the replacement assembly](#)
- [Step 3: Install the ITB](#)

Introduction

This document provides instructions about removing and replacing the intermediate transfer belt (ITB) assembly.

Before performing service

Turn the printer power off

- Disconnect the power cable.

 **WARNING!** To avoid damage to the printer, turn the printer off, wait 30 seconds, and then remove the power cord before attempting to service the printer.

To order a replacement assembly, use the table below to identify the correct part number for your printer. To order the part, go to www.hp.com/buy/parts

Intermediate transfer belt part number	
RM2-6560-000CN	Intermediate transfer belt assembly

Required tools

No special tools are required to install this assembly.

After performing service

Make sure that the right door is fully closed after replacing the ITB.

Turn the printer power on

- Connect the power cable.
- Use the power switch to turn the power on.

Post service test

Print a configuration page to make sure that the printer is functioning correctly.

Step 1: Remove the ITB

 **CAUTION:** Do not touch the grey-plastic belt. Skin oils and fingerprints on the belt can cause print-quality problems.

1. Open the right door.

Figure 1-227 Open the right door



2. Pull the blue lever to release the ITB drive coupling.

Figure 1-228 Release the ITB drive coupling

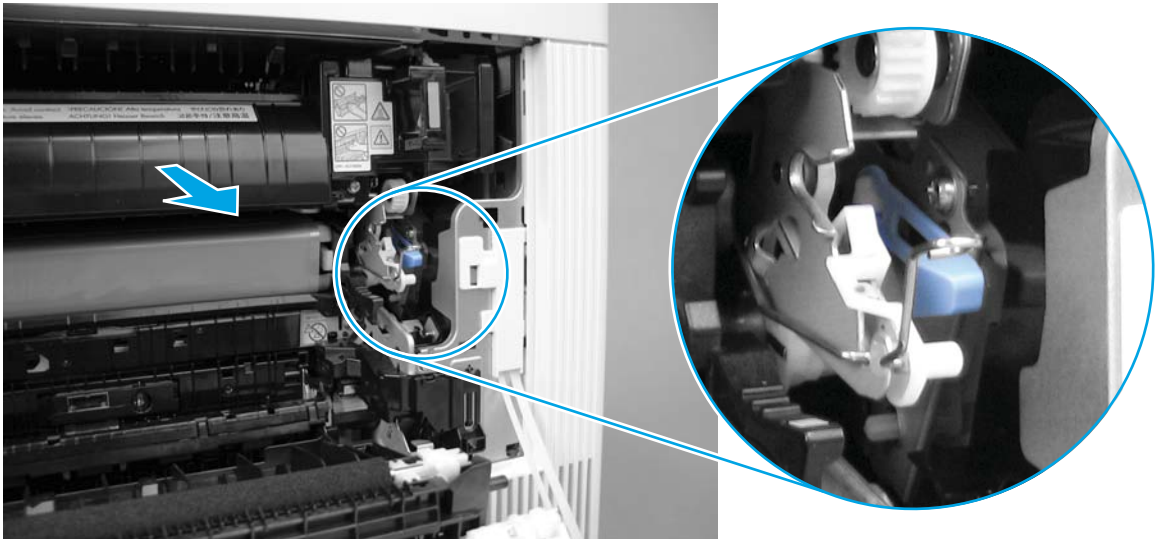

3. Push in on the blue arm to release the secondary transfer roller assembly, and then completely lower the assembly.

 **NOTE:** Press the blue arm on the secondary transfer roller assembly a second time to release the roller assembly when it stops at the halfway open position.

Figure 1-229 Lower the secondary transfer roller assembly



4. Release the left-side ITB spring (callout 1) from the tab (callout 2).

Figure 1-230 Release the front-side ITB spring

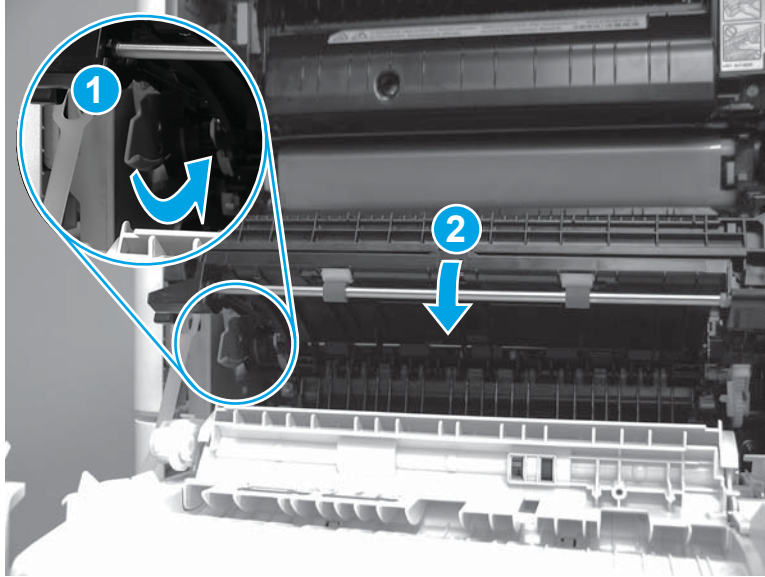
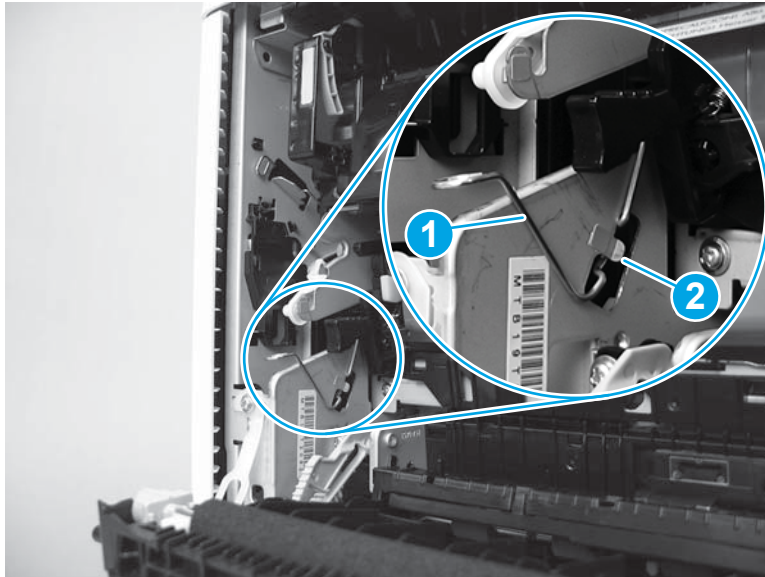

5. Place the left-side ITB spring on the holder to keep it out of the way.

 **TIP:** The holder is colored blue to help locate it.

Figure 1-231 Place the spring on the holder

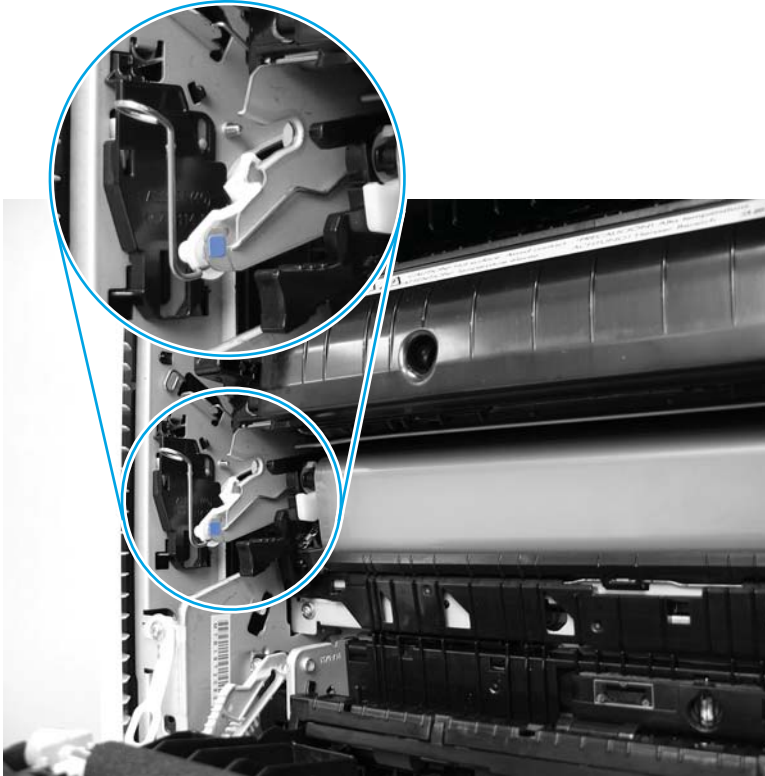

6. Release the right-side ITB spring (callout 1) from the tab (callout 2).

Figure 1-232 Release the rear-side ITB spring

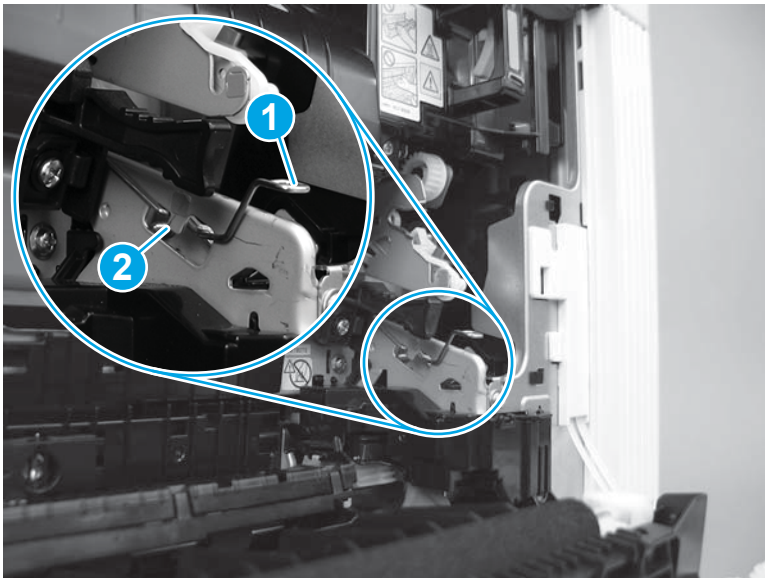

7. Place the right-side ITB spring on the holder to keep it out of the way.

 **TIP:** The holder is colored blue to help locate it.

Figure 1-233 Place the spring on the holder

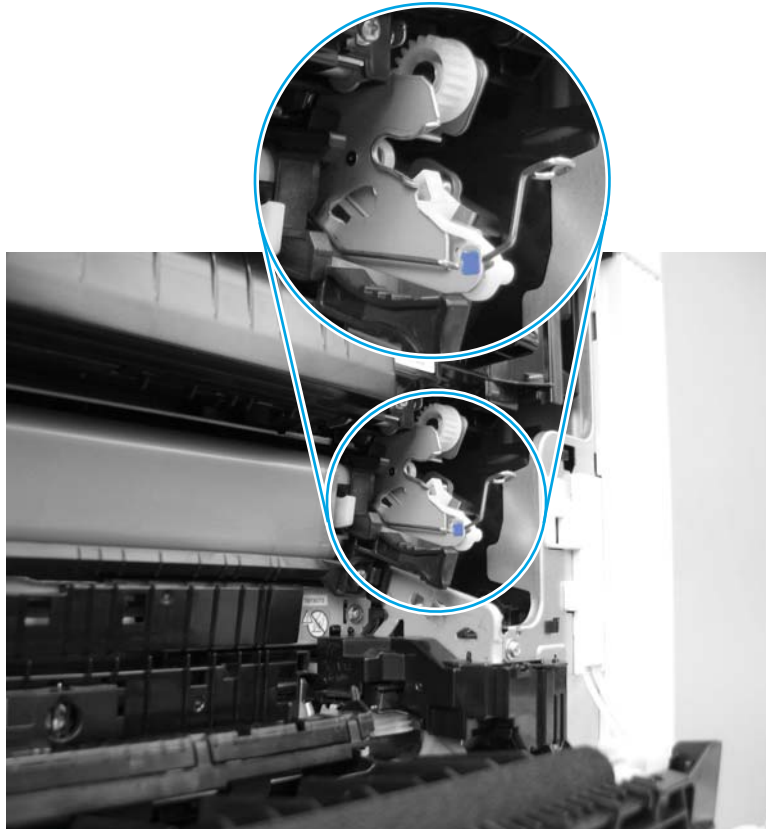

8. Grasp the two blue handles on the ITB.

⚠ CAUTION: If the ITB is removed to access other assemblies in the printer, use care. The ITB is a sensitive assembly. Be careful when handling the ITB so that it is not damaged. Always place the ITB in a safe and protected location.

Figure 1-234 Grasp the ITB handles

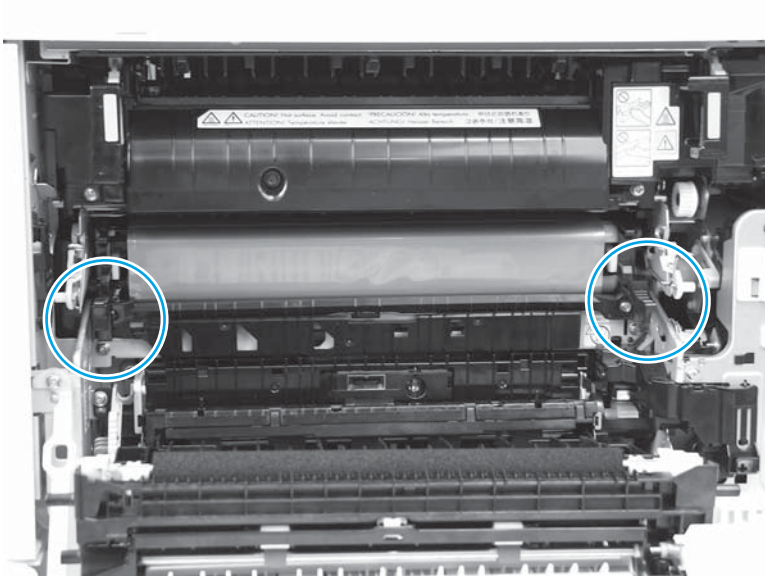

9. Pull the ITB out of the printer to remove it.

⚠ CAUTION: Do not touch the grey-plastic belt. Skin oils and fingerprints on the belt can cause print-quality problems.

Figure 1-235 Remove the ITB

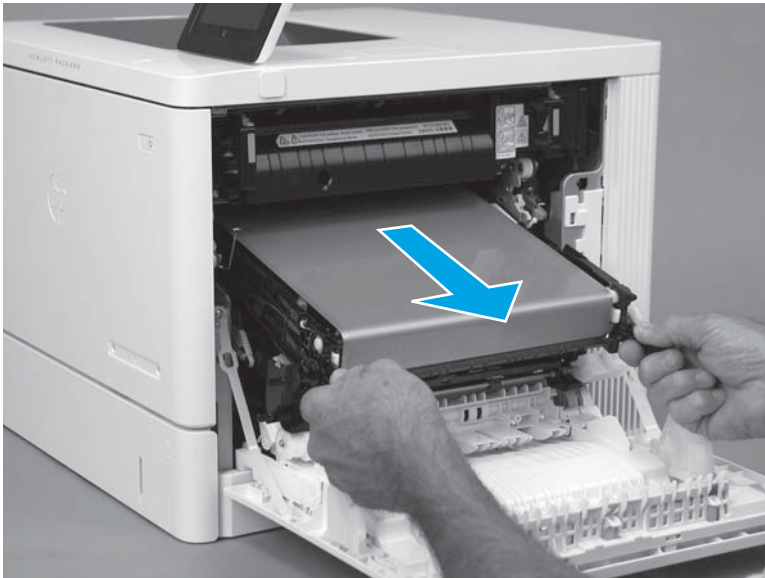

Step 2: Unpack the replacement assembly

Unpack the replacement assembly from the packaging.

CAUTION: Make sure that all of the packing materials and tape is removed from the replacement ITB. The ITB might be damaged if packing materials are in place when the printer power is turned on.

For complete information on HP's recycling programs, go to [Product return and recycling](#).

NOTE: HP recommends responsible disposal of the defective assembly.

Figure 1-236 Recycle and unpack

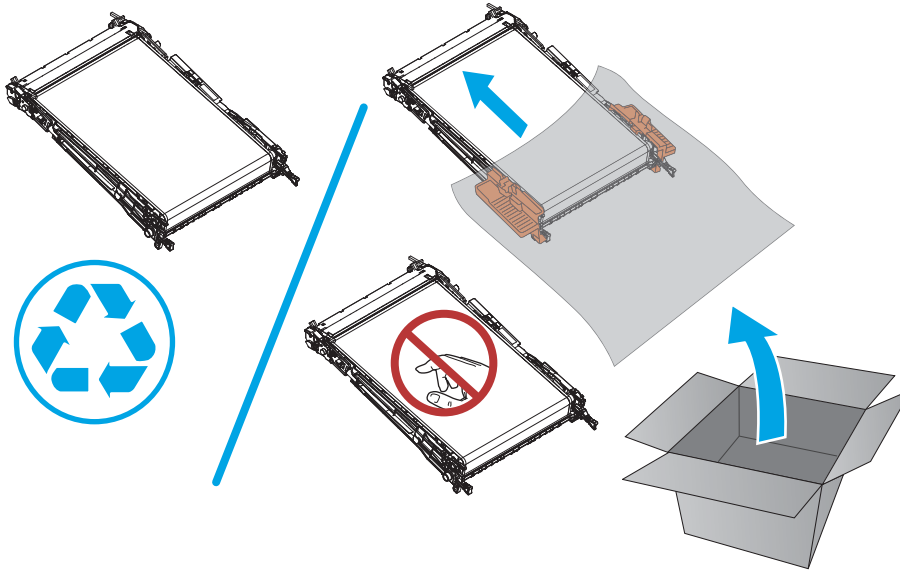

Step 3: Install the ITB

CAUTION: Do not touch the grey-plastic belt. Skin oils and fingerprints on the belt can cause print-quality problems.

1. Hold the ITB by the orange handles.

Figure 1-237 Handle the ITB by the edges

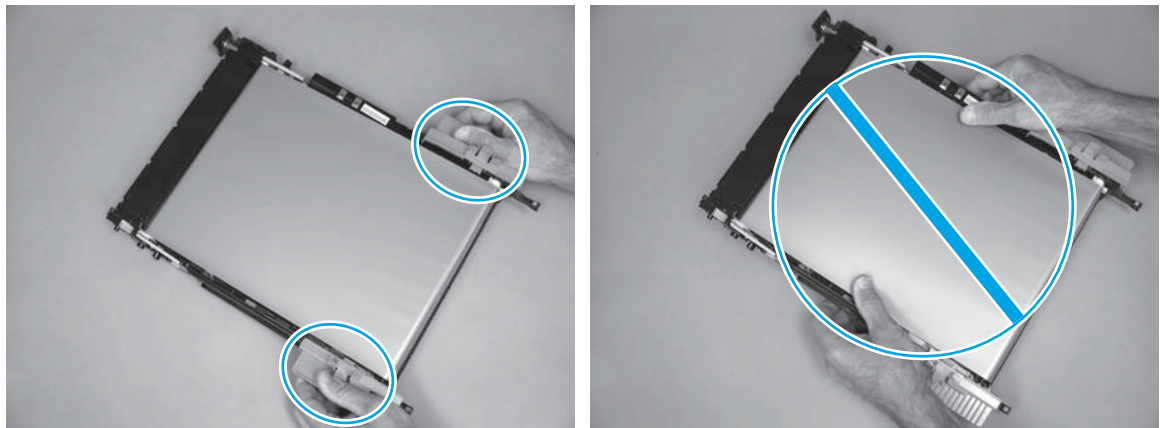

2. Align the ITB with the slots in the printer, and then carefully push it into the printer.

 **NOTE:** Be careful. Do not dislodge the ITB retainer springs from the holders on the chassis. The springs can interfere with installing the ITB.

Figure 1-238 Align the ITB with the slots in the product



3. Continue to carefully push the ITB into the printer until the orange handles stop it.

Figure 1-239 Orange handles stop

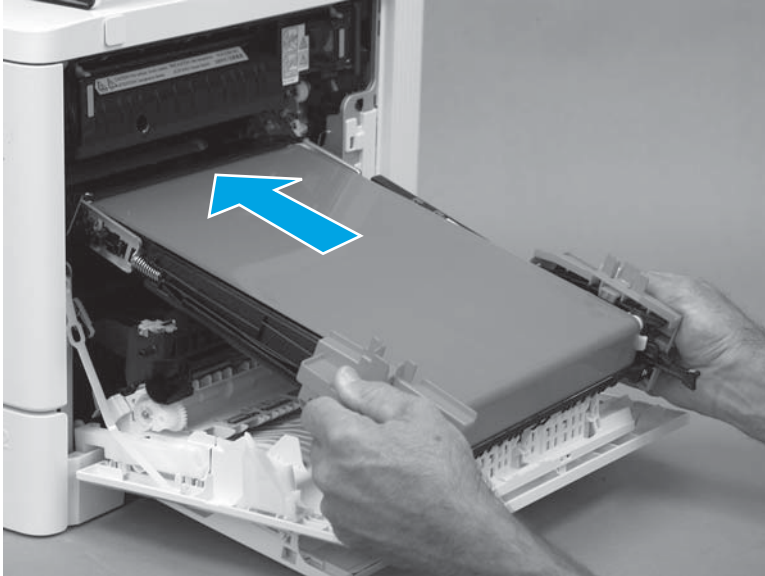
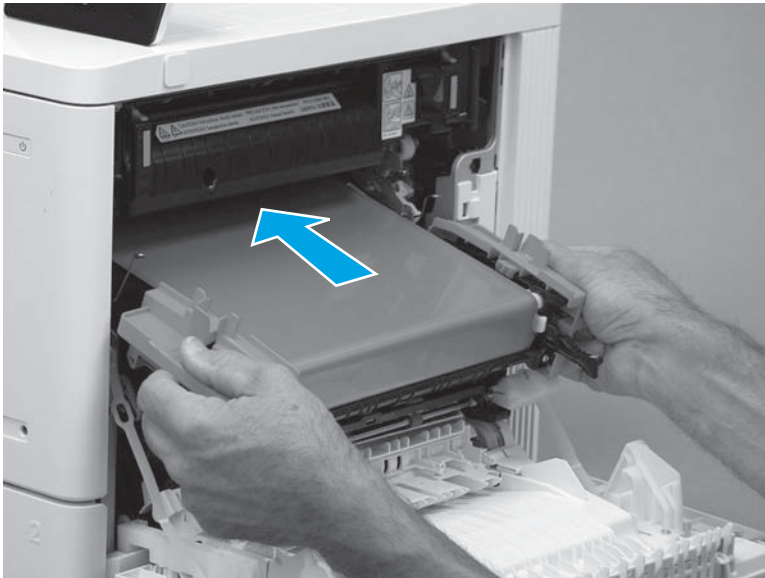

4. Release one tab (callout 1).

Figure 1-240 Release one tab

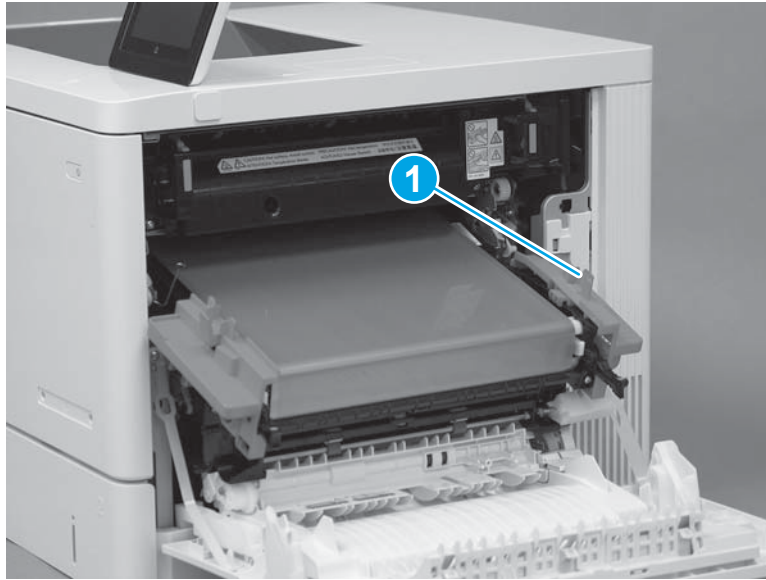

5. Remove the orange handle. Repeat this step for the remaining orange handle.

 **TIP:** HP recommends recycling the plastic handles.

Figure 1-241 Remove the orange handle

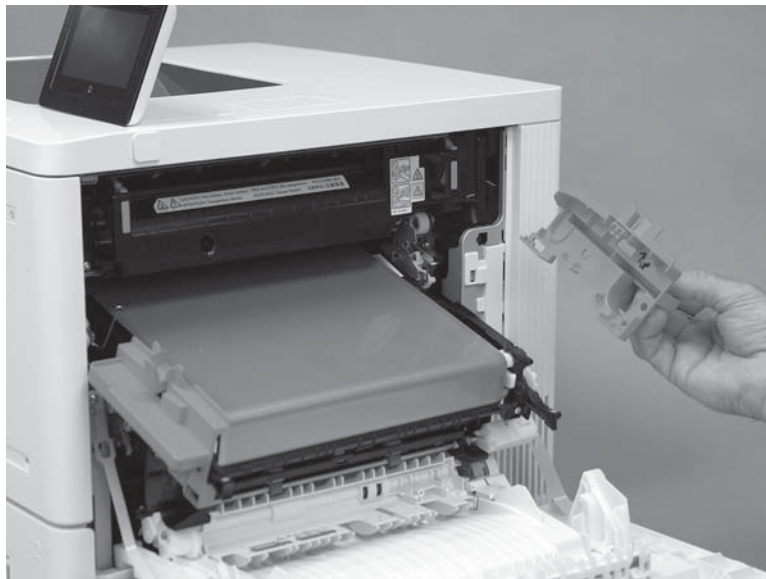

6. Continue to carefully push the ITB into the printer until it is fully installed.

Figure 1-242 Install the ITB

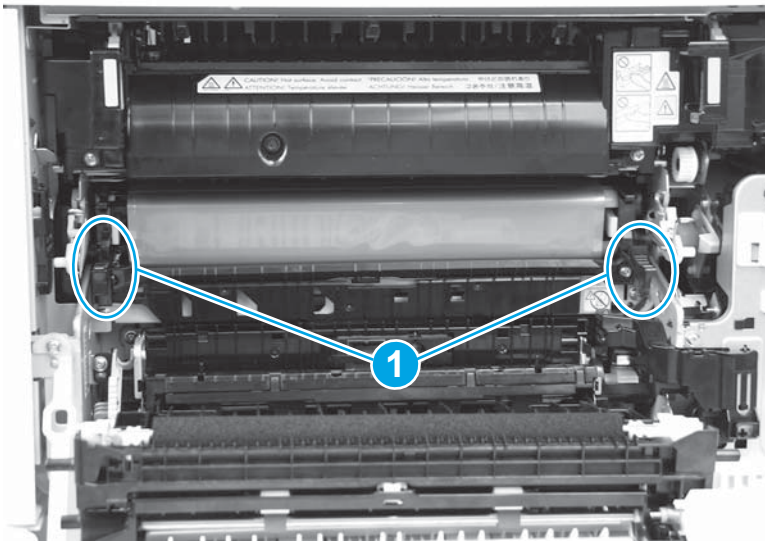

7. Remove the right-side ITB spring from the holder.

Figure 1-243 Remove the spring from the holder



8. Fasten the right-side ITB spring (callout 1) under the tab (callout 2).

Figure 1-244 Fasten the rear-side ITB spring

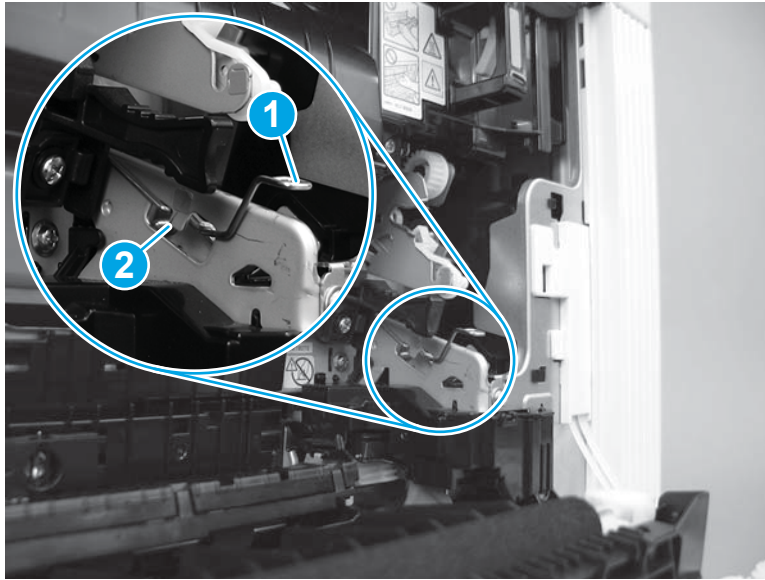

9. Remove the left-side ITB spring from the holder.

Figure 1-245 Remove the spring from the holder

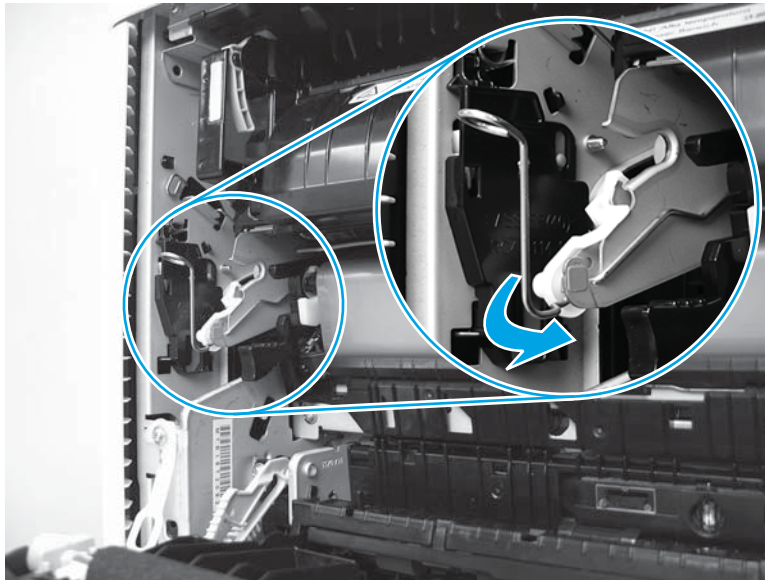

10. Fasten the left-side ITB spring (callout 1) under the tab (callout 2).

Figure 1-246 Fasten the front-side ITB spring

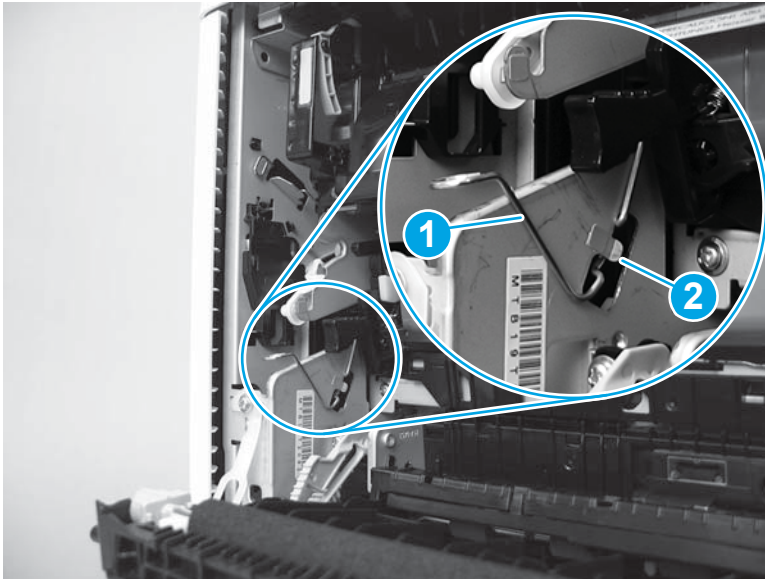

11. Push in the blue lever to engage the ITB drive coupling.

 **IMPORTANT:** If the ITB drive coupling is not fully engaged, the right door will not properly close.

Figure 1-247 Engage the ITB drive coupling

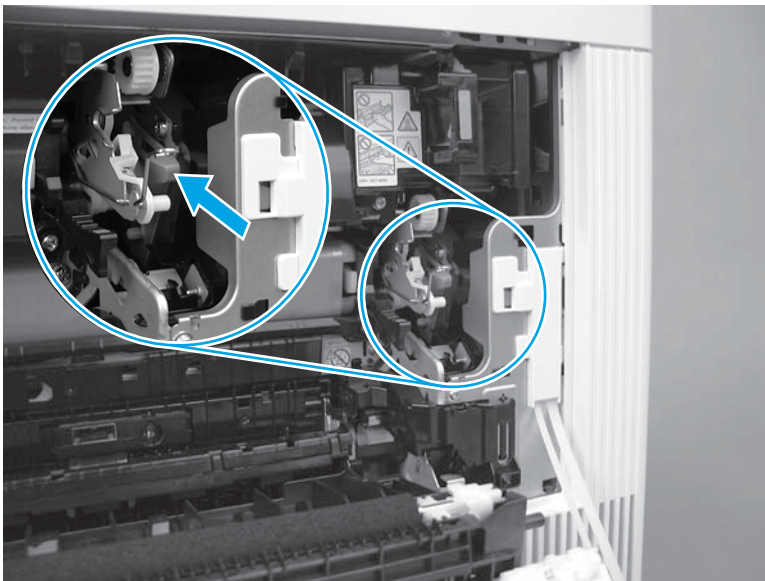

12. Close the right door.

 **TIP:** The right door should close easily if the ITB assembly is correctly installed.

Figure 1-248 Close the right door



Removal and replacement: Intermediate transfer belt (ITB) and secondary transfer roller

- [Introduction](#)
- [Step 1: Remove the transfer roller](#)
- [Step 2: Remove the ITB](#)
- [Step 3: Unpack the replacement assemblies](#)
- [Step 4: Install the ITB](#)
- [Step 5: Install the transfer roller](#)

Introduction

This document provides the procedures to remove and replace the secondary transfer roller and the intermediate transfer belt (ITB).

Before performing service

Turn the printer power off

- Disconnect the power cable.

 **WARNING!** To avoid damage to the printer, turn the printer off, wait 30 seconds, and then remove the power cord before attempting to service the printer.

Use the table below to identify the correct part number for your printer. To order the part, go to www.hp.com/buy/parts.

Secondary transfer roller kit part number	
---	--

B5L24-67901

Secondary transfer roller and intermediate transfer belt (ITB) with instruction guide

Required tools

No special tools are required to install this part.

After performing service

Make sure that the right door is fully closed after replacing the secondary transfer roller and ITB.

Turn the printer power on

- Connect the power cable.
- Use the power switch to turn the power on.

Post service test

Print a configuration page to make sure that the printer is functioning correctly.

Step 1: Remove the transfer roller

1. Open the right door.

Figure 1-249 Open the right door



2. Push in on the blue lever (callout 1) to release the secondary transfer roller assembly, and then lower the assembly (callout 2) to the service position.

Figure 1-250 Lower the secondary transfer roller assembly

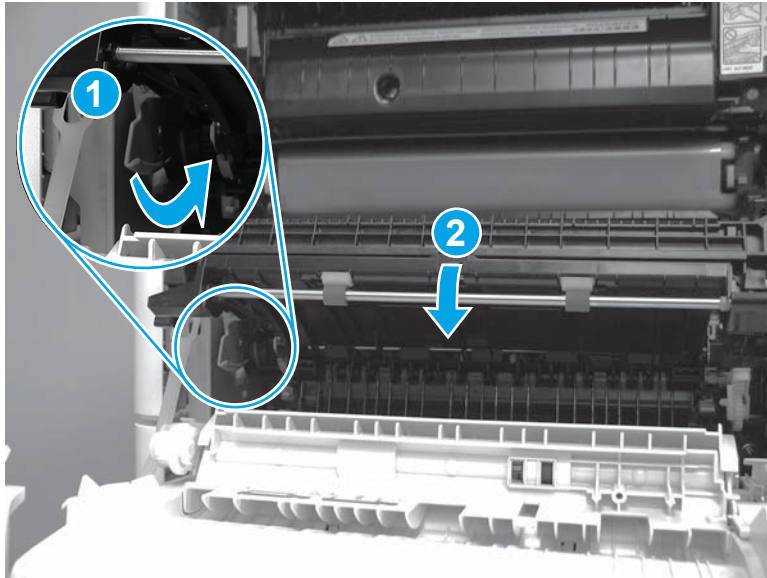

3. Slightly lift the left end of the roller shaft (callout 1; near the gear) to release the transfer roller clip.

Figure 1-251 Release the secondary transfer roller clip

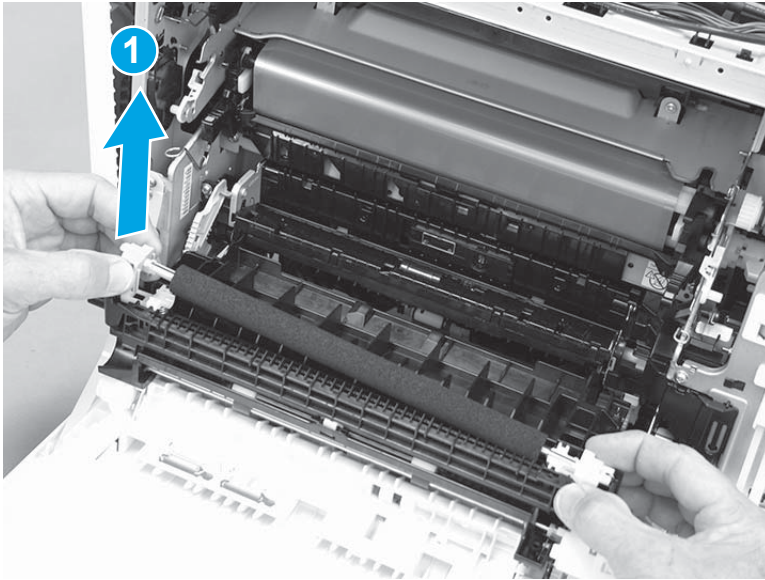

4. Slide the right end roller collar (callout 1) to the left to remove the transfer roller.

Figure 1-252 Remove the secondary transfer roller

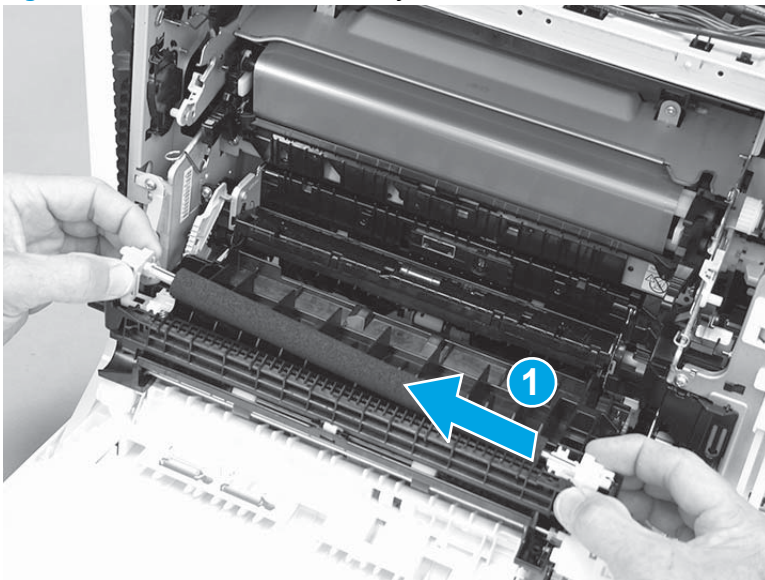

Step 2: Remove the ITB

CAUTION: Do not touch the grey-plastic belt. Skin oils and fingerprints on the belt can cause print-quality problems.

1. Pull the blue lever to release the ITB drive coupling.

Figure 1-253 Release the ITB drive coupling

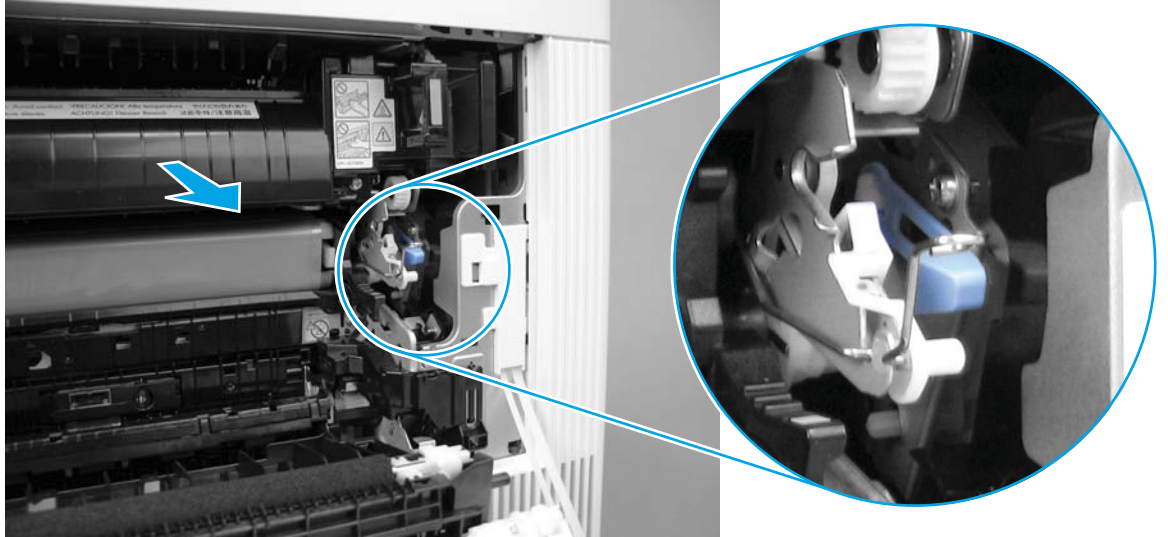

2. Release the left-side ITB spring (callout 1) from the tab (callout 2).

Figure 1-254 Release the front-side ITB spring

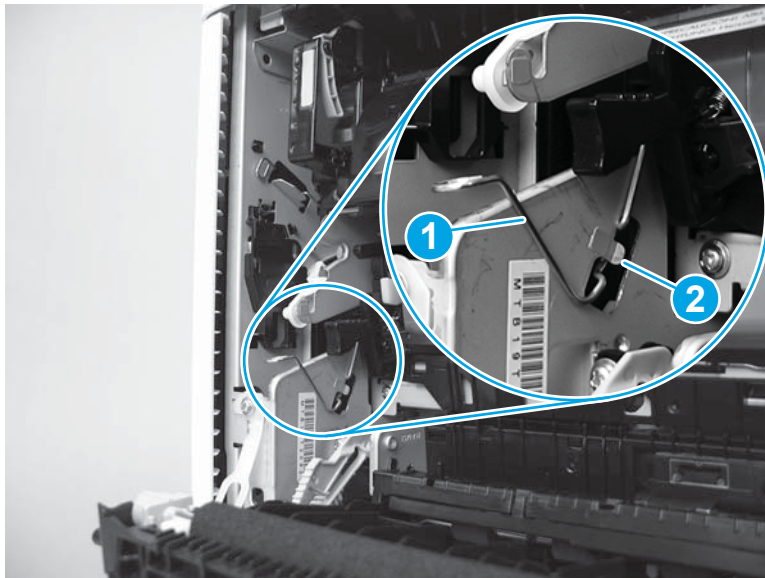

3. Place the left-side ITB spring on the holder to keep it out of the way.

 **TIP:** The holder is colored blue to help locate it.

Figure 1-255 Place the spring on the holder

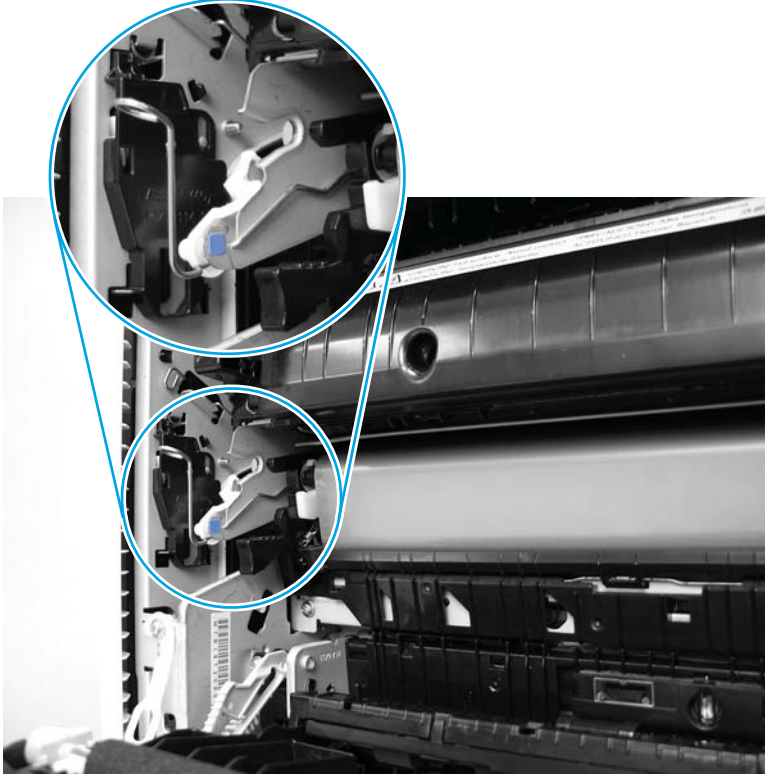

4. Release the right-side ITB spring (callout 1) from the tab (callout 2).

Figure 1-256 Release the rear-side ITB spring

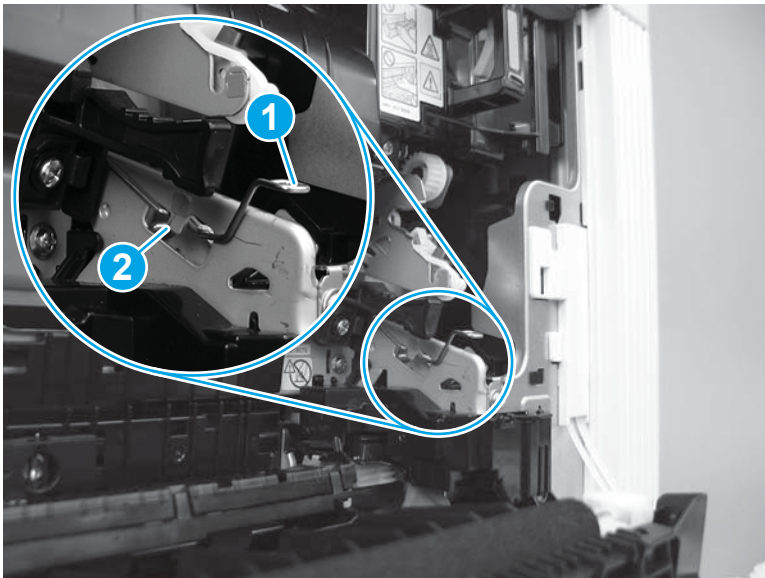

5. Place the right-side ITB spring on the holder to keep it out of the way.

 **TIP:** The holder is colored blue to help locate it.

Figure 1-257 Place the spring on the holder

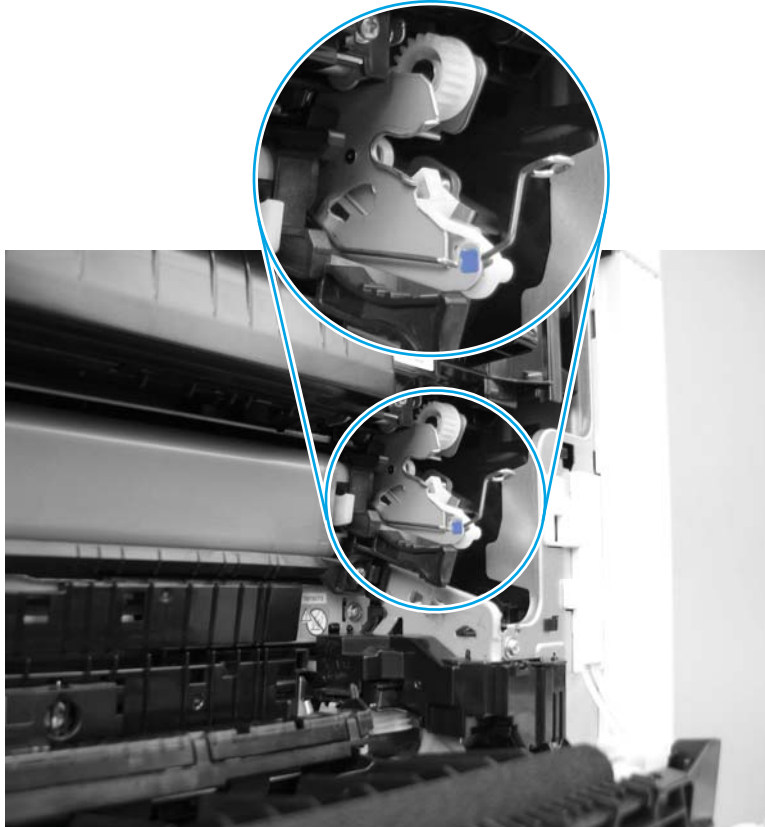

6. Grasp the two handles on the ITB.

CAUTION: If the ITB is removed to access other assemblies in the printer, use care. The ITB is a sensitive assembly. Be careful when handling the ITB so that it is not damaged. Always place the ITB in a safe and protected location.

NOTE: The two black handles have blue stickers on them to help you locate them.

Figure 1-258 Grasp the ITB handles

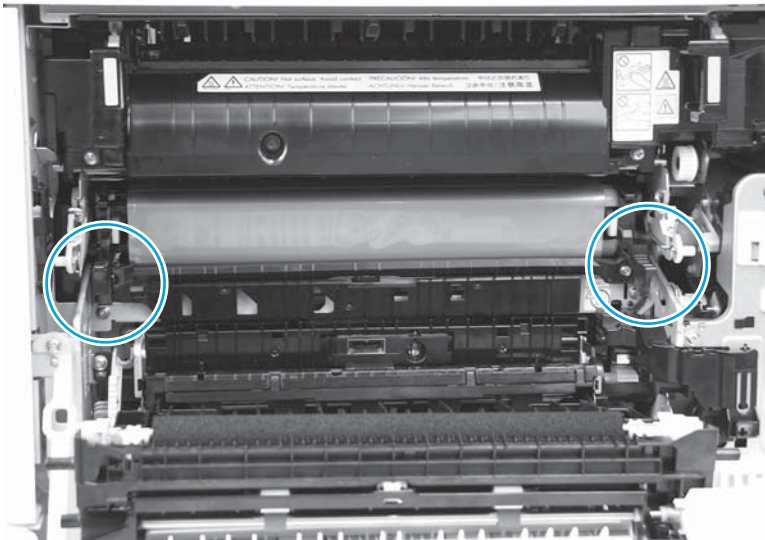

7. Pull the ITB out of the printer to remove it.

CAUTION: Do not touch the grey-plastic belt. Skin oils and fingerprints on the belt can cause print-quality problems.

NOTE: Be careful. Do not dislodge the ITB springs from the holders. The springs can interfere with removing the ITB.

Figure 1-259 Remove the ITB

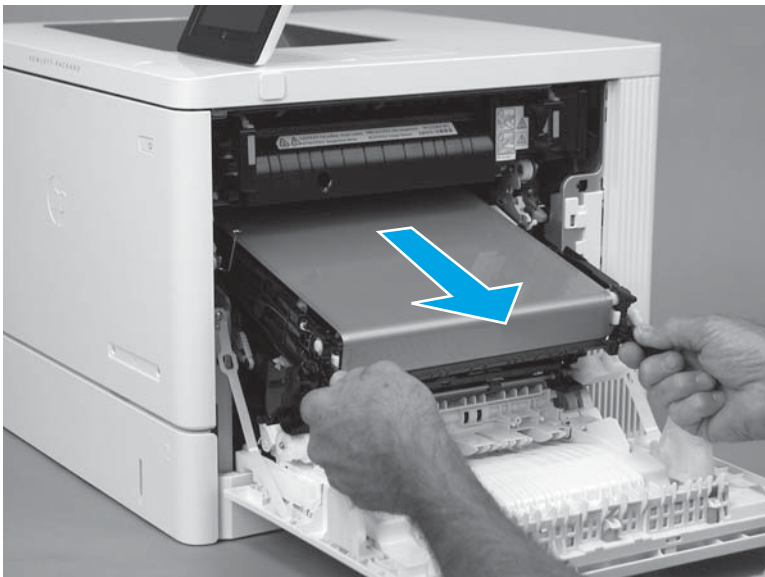

Step 3: Unpack the replacement assemblies

Unpack the replacement assemblies from the packaging.

CAUTION: Make sure that all of the packing materials and tape are removed from the replacement ITB. The ITB might be damaged if packing materials are in place when the printer power is turned on.

For complete information on HP's recycling programs, go to [Product return and recycling](#).

NOTE: HP recommends responsible disposal of the defective assemblies.

Figure 1-260 Recycle and unpack

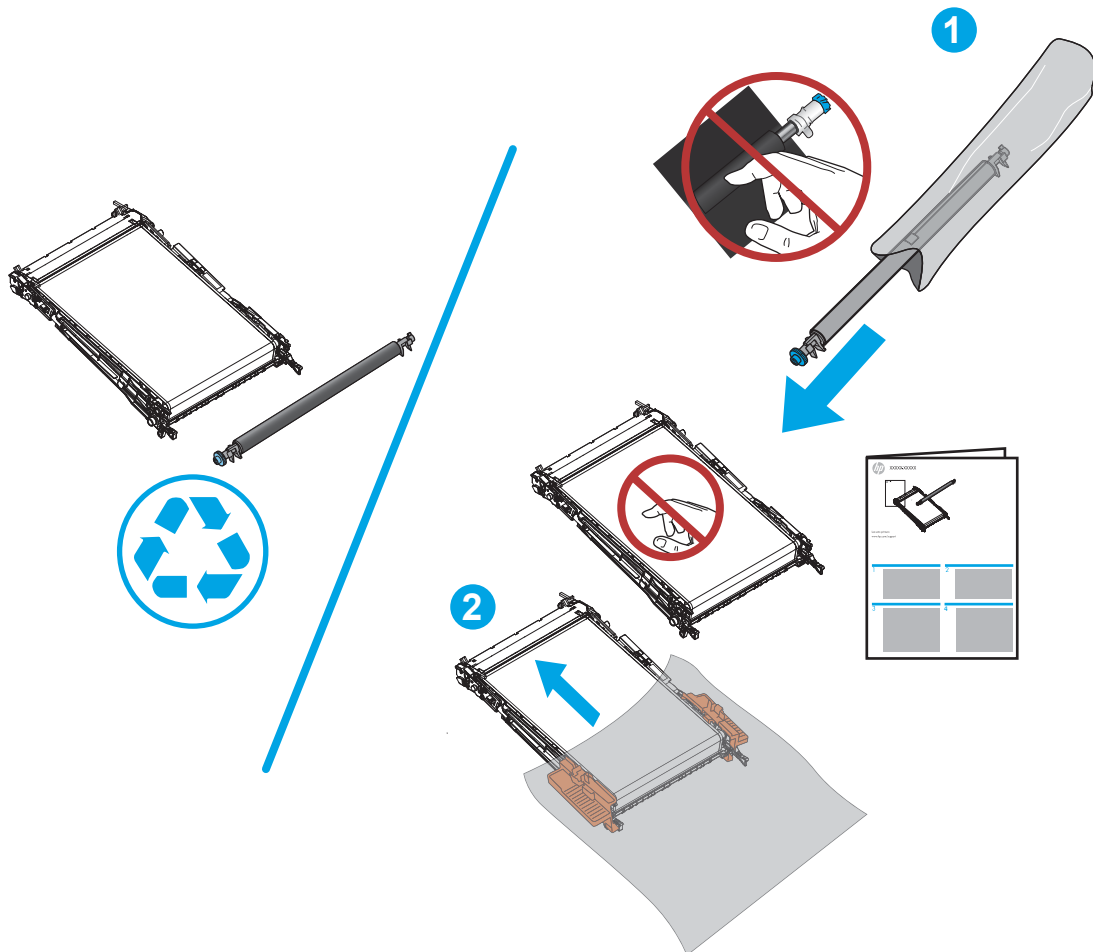

Step 4: Install the ITB

CAUTION: Do not touch the grey-plastic belt. Skin oils and fingerprints on the belt can cause print-quality problems.

1. Hold the ITB by the provided orange ITB service handles.

Figure 1-261 Handle the ITB by the edges

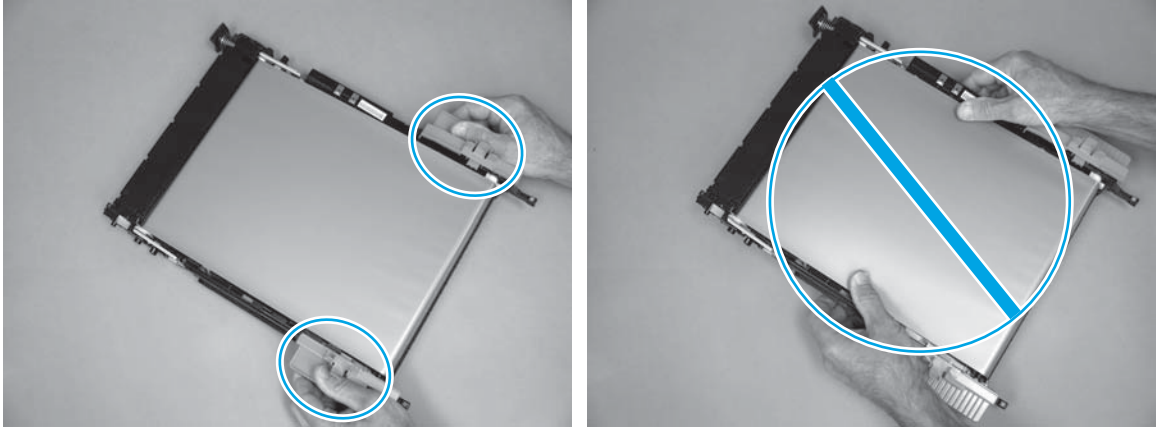

2. Align the ITB with the slots in the printer, and then carefully push it into the printer.

 **NOTE:** Be careful. Do not dislodge the ITB retainer springs from the holders on the chassis. The springs can interfere with installing the ITB.

Figure 1-262 Align the ITB with the slots in the product

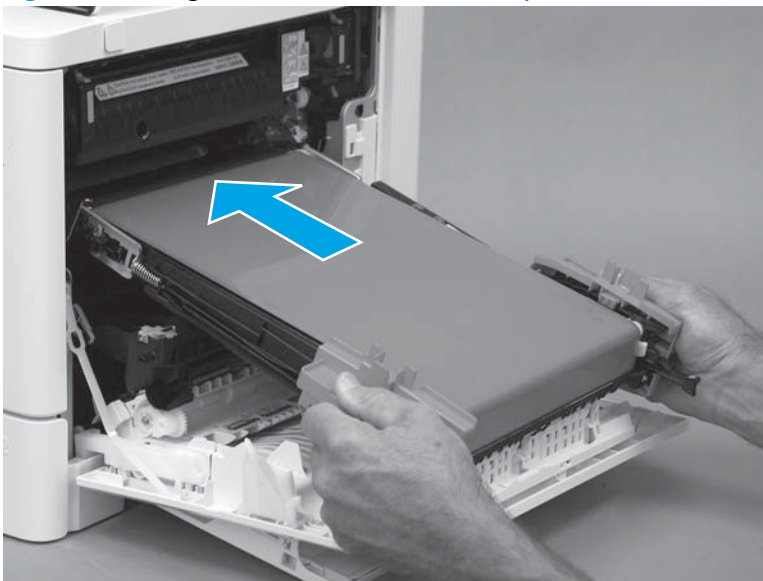

3. Continue to carefully push the ITB into the printer until the orange handles stop it.

Figure 1-263 Orange handles stop

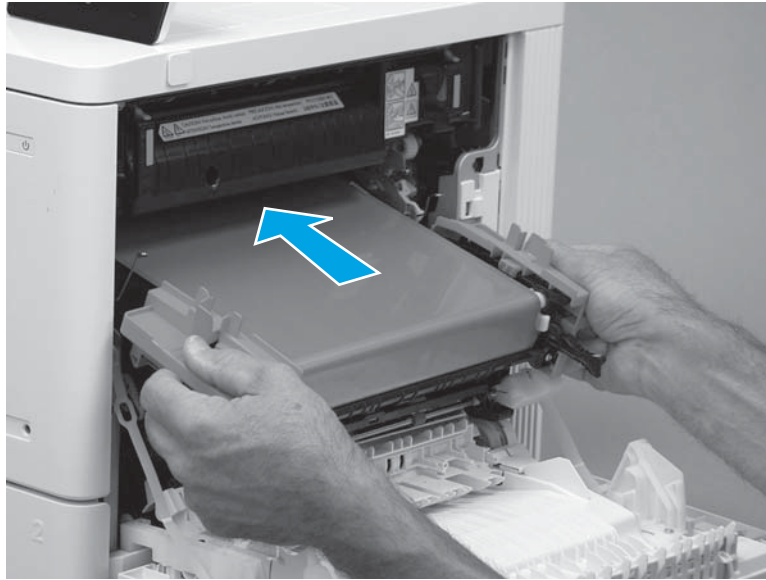

4. Release one tab (callout 1).

Figure 1-264 Release one tab

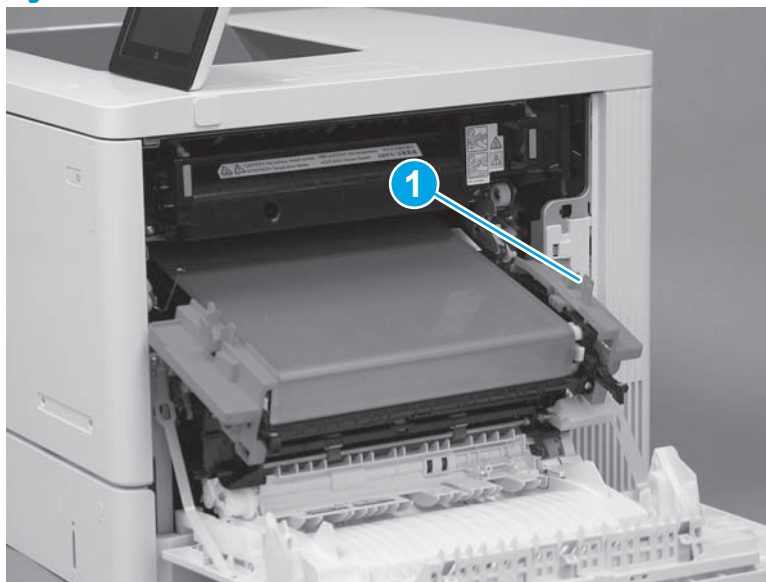

5. Remove the orange handle. Repeat this step for the remaining orange handle.

 **TIP:** HP recommends recycling the plastic handles.

Figure 1-265 Remove the orange handle

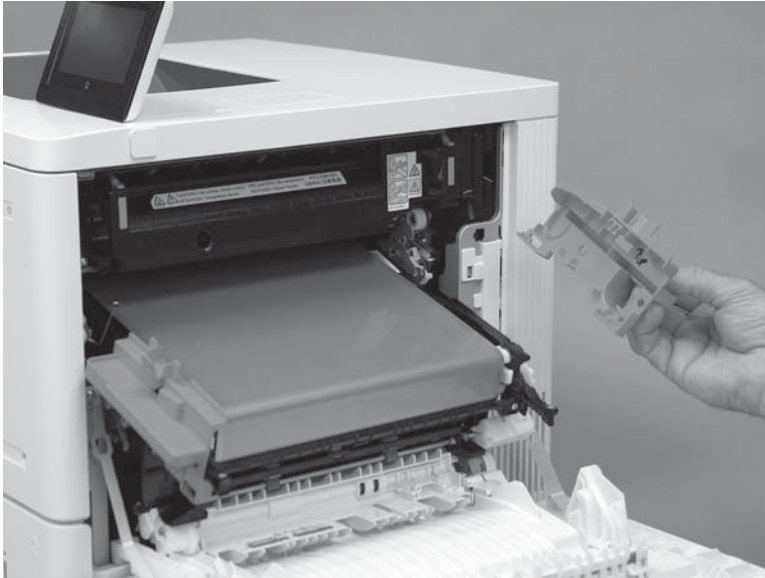

6. Use the black-plastic handles (callout 1) on the ITB to carefully push the ITB into the product until it is fully installed.

Figure 1-266 Install the ITB

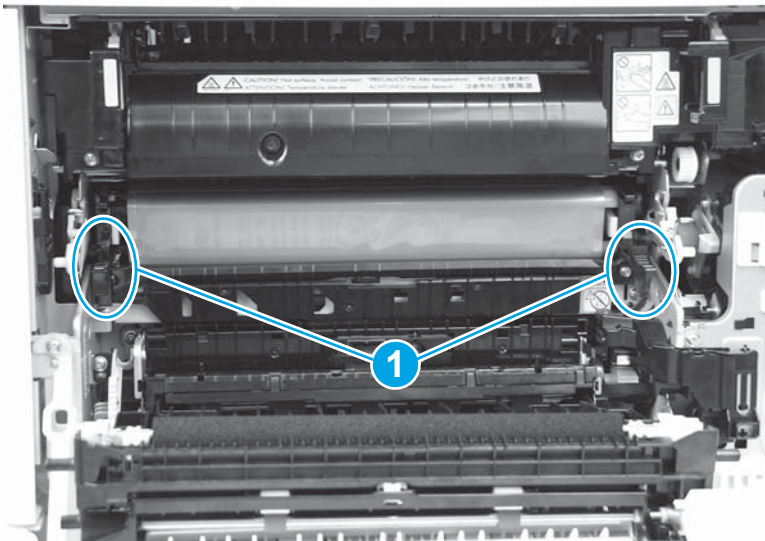

7. Remove the right-side ITB spring from the holder.

Figure 1-267 Remove the spring from the holder



8. Fasten the right-side ITB spring (callout 1) under the tab (callout 2).

Figure 1-268 Fasten the rear-side ITB spring

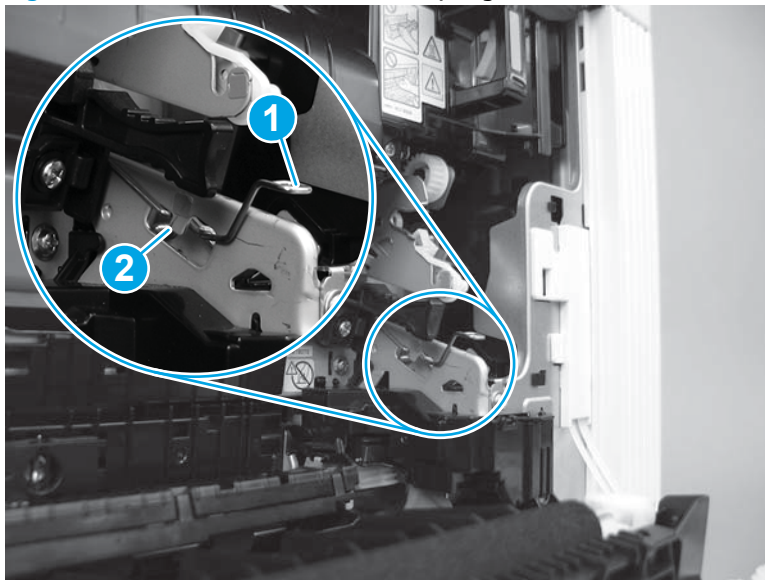

9. Remove the left-side ITB spring from the holder.

Figure 1-269 Remove the spring from the holder

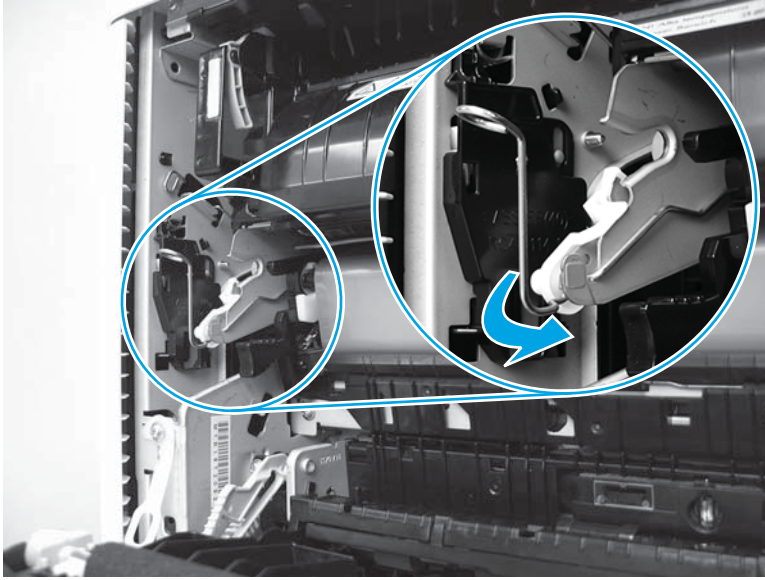

10. Fasten the left-side ITB spring (callout 1) under the tab (callout 2).

Figure 1-270 Fasten the front-side ITB spring

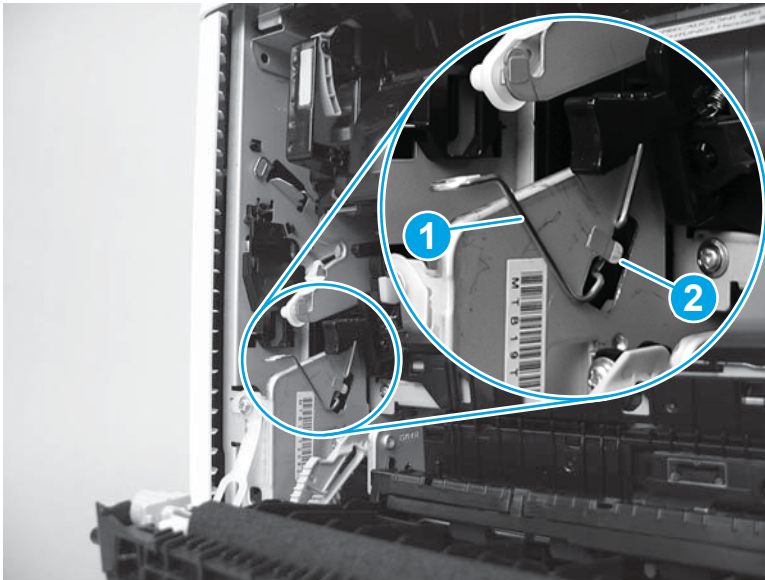

11. Push in the blue lever to engage the ITB drive coupling.

 **IMPORTANT:** If the ITB drive coupling is not fully engaged, the right door will not properly close.

Figure 1-271 Engage the ITB drive coupling

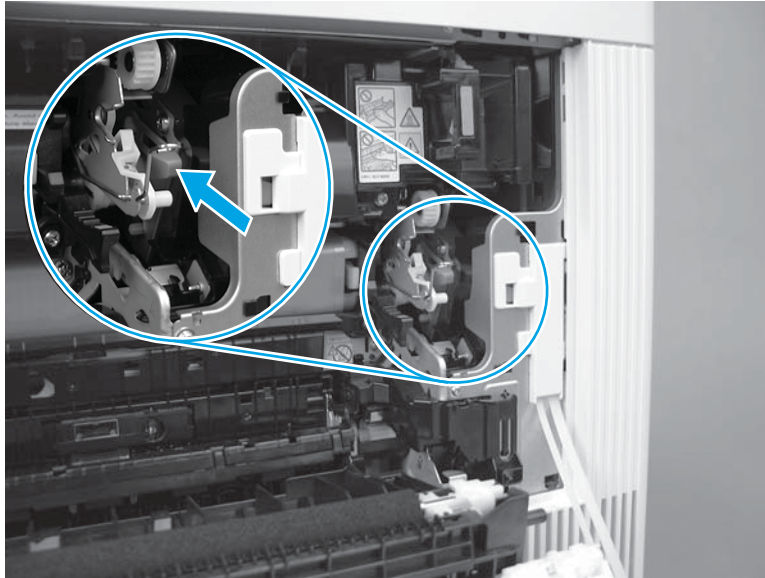

Step 5: Install the transfer roller

1. Insert the right end (white plastic) of the replacement roller into the holder (callout 1), and then push down on the left end (blue plastic clip; callout 2) until the roller snaps into place.

 **IMPORTANT:** Make sure that both ends of the roller assembly are fully seated in the holders.

Figure 1-272 Install the secondary transfer roller right end



2. Close the right door.

 **TIP:** The right door should close easily if the ITB assembly is correctly installed.

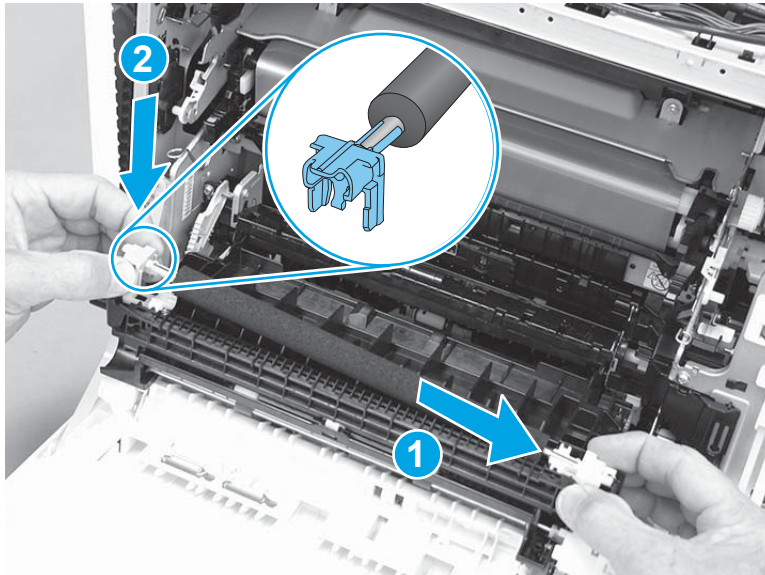
Figure 1-273 Close the right door



Field replaceable units (FRUs)

Removal and replacement: External panels, covers, and doors

- [Removal and replacement: Stapler cover assembly \(M577c/f/z\)](#)
- [Removal and replacement: Right front upper cover \(M577dn\)](#)
- [Removal and replacement: Rear upper cover \(M577\)](#)
- [Removal and replacement: Left upper cover \(M577\)](#)
- [Removal and replacement: Right upper cover \(M577\)](#)
- [Removal and replacement: Top rear cover \(M577\)](#)
- [Removal and replacement: Paper feed cover \(M577\)](#)
- [Removal and replacement: Top cover \(M577\)](#)
- [Removal and replacement: Right door](#)
- [Removal and replacement: Front door](#)
- [Removal and replacement: Formatter cover](#)
- [Removal and replacement: Rear cover \(M552 and M553\)](#)
- [Removal and replacement: Rear cover \(M577\)](#)
- [Removal and replacement: Left cover](#)
- [Removal and replacement: Upper cover \(M552 and M553\)](#)
- [Removal and replacement: Output bin](#)
- [Removal and replacement: Right rear cover \(M552 and M553\)](#)
- [Removal and replacement: Right rear cover \(M577\)](#)
- [Removal and replacement: Control panel \(M553n/dn and M552dn only\)](#)

Removal and replacement: Stapler cover assembly (M577c/f/z)

- [Introduction](#)
- [Step 1: Remove the stapler cover assembly](#)
- [Step 2: Unpack the replacement assembly](#)
- [Step 3: Install the stapler cover assembly](#)

Introduction

This document provides the procedures to remove and replace the M577c/f/z stapler cover assembly.

Before performing service

Turn the printer power off

- Disconnect the power cable.

 **WARNING!** To avoid damage to the printer, turn the printer off, wait 30 seconds, and then remove the power cord before attempting to service the printer.

Use the table below to identify the correct part number for your printer. To order the part, go to www.hp.com/buy/parts.

Stapler cover assembly (M577c/f/z) part number	
--	--

B5L46-60121

Stapler cover assembly (M577c/f/z)

Required tools

- Small flat blade screwdriver
- #2 Phillips screwdriver with a magnetic tip

After performing service

Make sure that the stapler cover is fully seated after replacing it.

Turn the printer power on

- Connect the power cable.
- Use the power switch to turn the power on.

Step 1: Remove the stapler cover assembly

1. Remove one screw (callout 1).

 **Reinstallation tip:** This is a self-tapping screw for plastic. When reinstalling, rotate the screw counterclockwise to align it with the existing thread pattern, and then carefully turn it clockwise to tighten. Do not overtighten. This will prevent stripping the threads inside the screw hole.

Figure 1-274 Remove one screw



2. Release two tabs at the front edge of the cover (callout 1).

Figure 1-275 Release two tabs

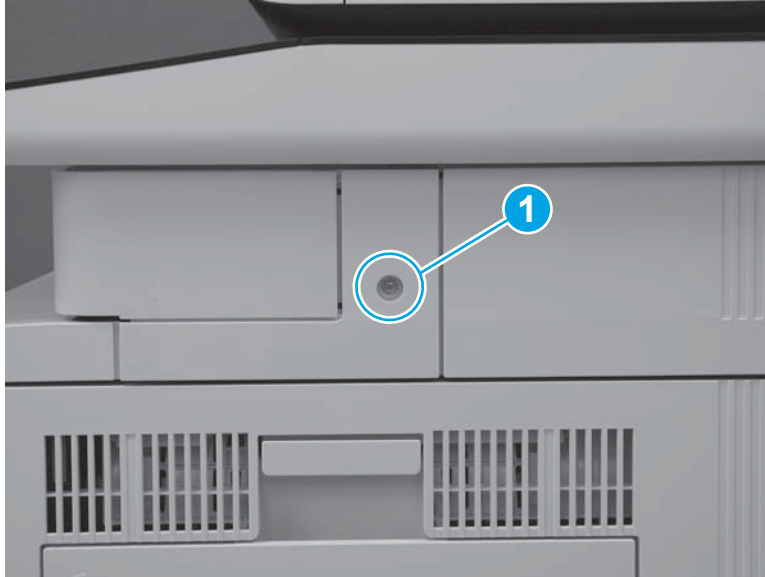

3. Release the back edge of the cover.

Figure 1-276 Release the back edge of the cover

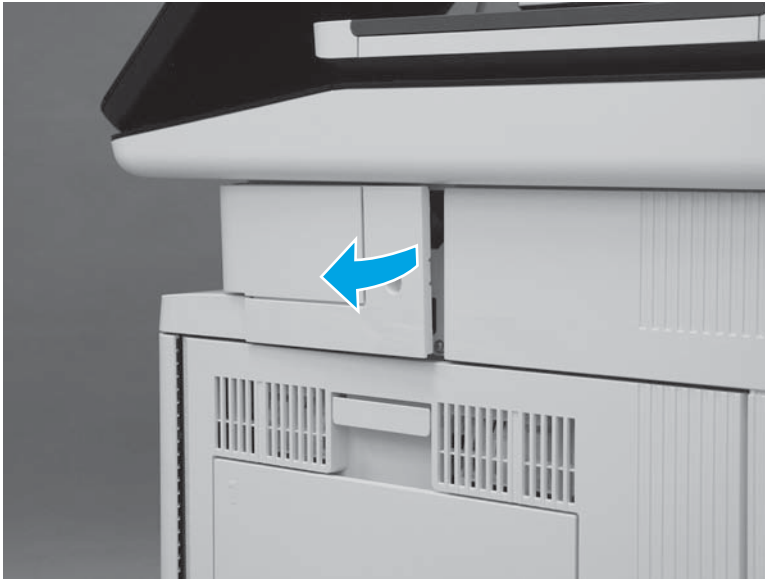

4. Rotate the cover away from the printer to remove it.

Figure 1-277 Remove the cover



Step 2: Unpack the replacement assembly

Unpack the replacement assembly from the packaging.

For complete information on HP's recycling programs, go to [Product return and recycling](#).

 **NOTE:** HP recommends responsible disposal of the defective assembly.

Figure 1-278 Recycle and unpack



Step 3: Install the stapler cover assembly

1. Install the tabs (callout 1) on the cover in the slots (callout 2) in the printer.

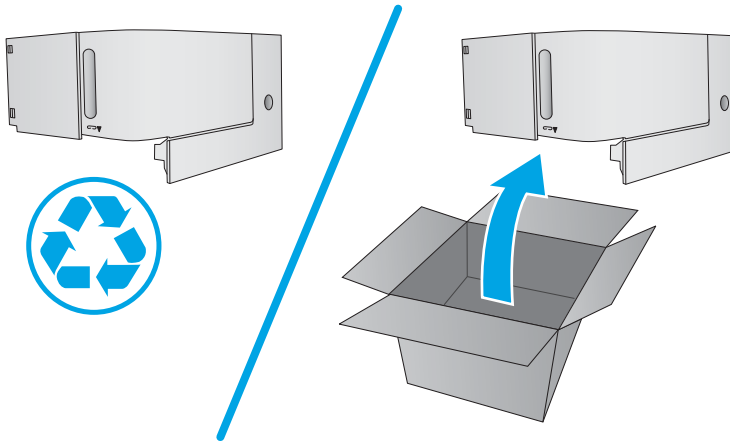
Figure 1-279 Install two tabs



2. Press the cover toward the left side of the printer until it snaps into place.

Figure 1-280 Install the cover assembly



3. Install one screw (callout 1).

 **IMPORTANT:** This is a self-tapping screw for plastic. Rotate it counterclockwise to align it with the existing thread pattern, and then carefully turn it clockwise to tighten. Do not overtighten. This will prevent stripping the threads inside the screw hole.

Figure 1-281 Install one screw



Removal and replacement: Right front upper cover (M577dn)

- [Introduction](#)
- [Step 1: Remove the right front upper cover](#)
- [Step 2: Unpack the replacement assembly](#)
- [Step 3: Install the right front upper cover](#)

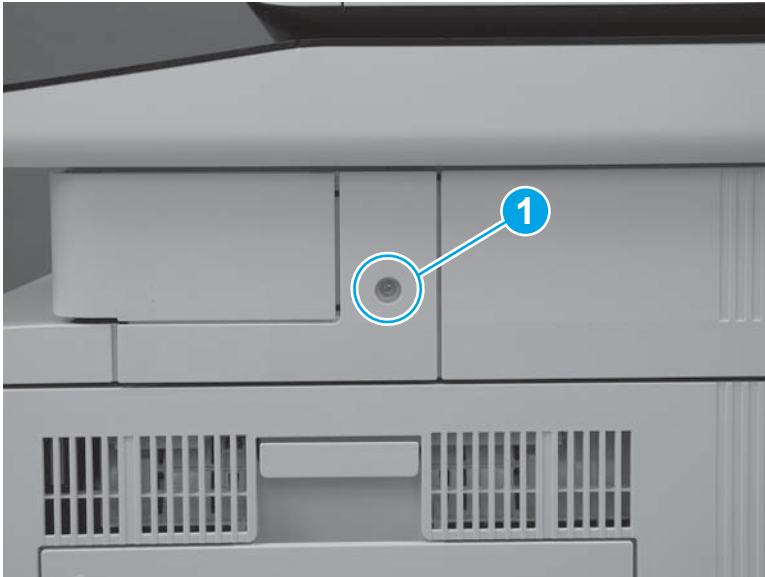
Introduction

This document provides the procedures to remove and replace the M577dn right front upper cover.

Before performing service

Turn the printer power off

- Disconnect the power cable.

 **WARNING!** To avoid damage to the printer, turn the printer off, wait 30 seconds, and then remove the power cord before attempting to service the printer.

Use the table below to identify the correct part number for your printer. To order the part, go to www.hp.com/buy/parts.

Right front upper cover (M577dn) part number	
B5L46-40024	Right front upper cover (M577dn)

Required tools

- Small flat blade screwdriver
- #2 Phillips screwdriver with a magnetic tip

After performing service

Make sure that the right front upper cover is fully seated after replacing it.

Turn the printer power on

- Connect the power cable.
- Use the power switch to turn the power on.

Step 1: Remove the right front upper cover

1. Remove one screw (callout 1).

Figure 1-282 Remove one screw

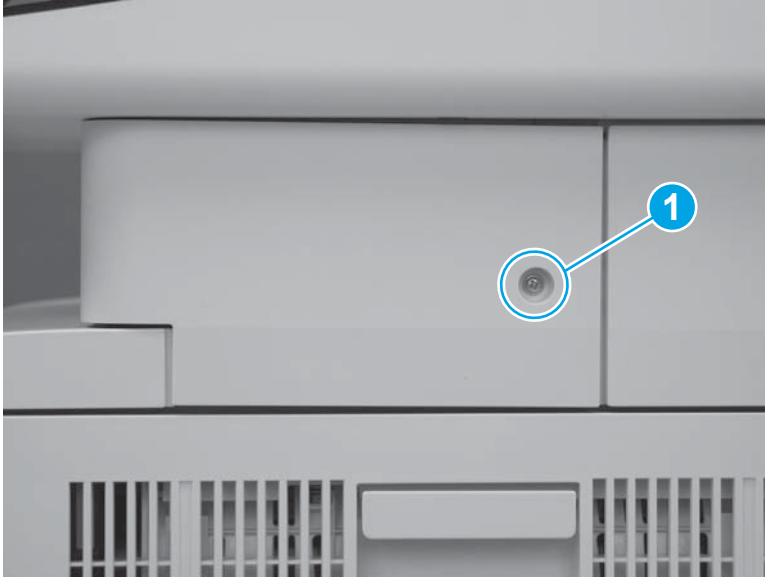

2. Release two tabs at the front edge of the cover (callout 1).

Figure 1-283 Release two tabs



3. Rotate the front of the cover to the right to remove it.

Figure 1-284 Rotate the cover



Step 2: Unpack the replacement assembly

Unpack the replacement assembly from the packaging.

For complete information on HP's recycling programs, go to [Product return and recycling](#).

 **NOTE:** HP recommends responsible disposal of the defective assembly.

Figure 1-285 Recycle and unpack

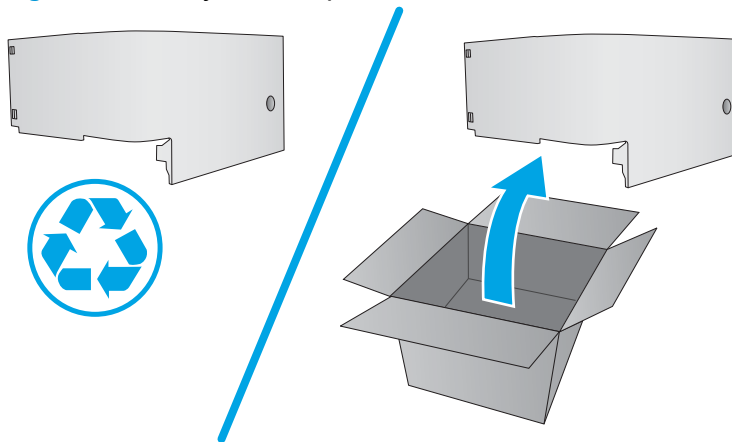

Step 3: Install the right front upper cover

1. Slide the cover toward the left side of the printer to install it. Make sure that the slots (callout 1) in the cover fit over the tabs (callout 2) on the inside of the paper feeder cover.

Figure 1-286 Install the cover



2. Press the right front upper cover (callout 1) and the paper feeder cover (callout 2) together until the tabs on the inside of the covers snap into place.

Figure 1-287 Press the cover



3. Install one screw (callout 1).

Figure 1-288 Install one screw

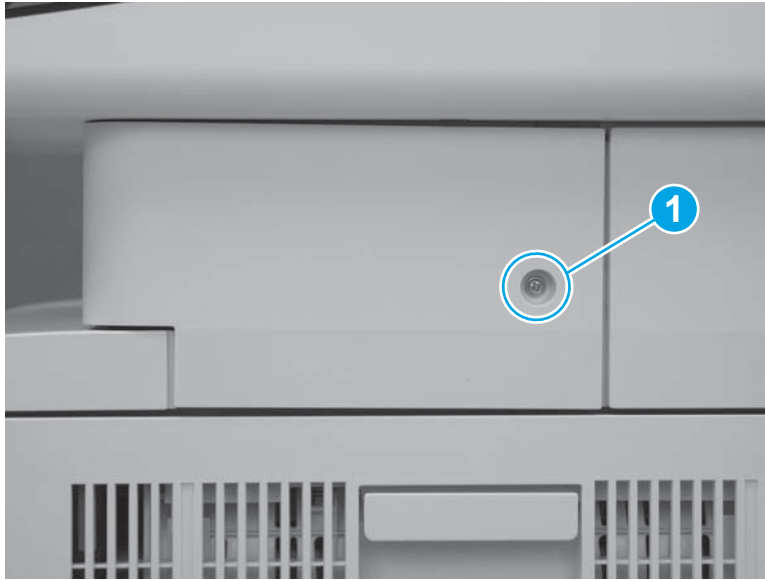

Removal and replacement: Rear upper cover (M577)

- [Introduction](#)
- [Step 1: Remove the formatter cover](#)
- [Step 2: Remove the rear upper cover](#)
- [Step 3: Unpack the replacement assembly](#)
- [Step 4: Install the rear upper cover](#)
- [Step 5: Install the formatter cover](#)

Introduction

This document provides the procedures to remove and replace the M577 rear upper cover.

Before performing service

Turn the printer power off

- Disconnect the power cable.

 **WARNING!** To avoid damage to the printer, turn the printer off, wait 30 seconds, and then remove the power cord before attempting to service the printer.

Use the table below to identify the correct part number for your printer. To order the part, go to www.hp.com/buy/parts.

Rear upper cover (M577) part number	
-------------------------------------	--

RC4-3385-000CN	Rear upper cover (M577)
----------------	-------------------------

Required tools

- Small flat blade screwdriver
- #2 Phillips screwdriver with a magnetic tip

After performing service

Make sure that the rear upper cover is fully seated after replacing it.

Turn the printer power on

- Connect the power cable.
- Use the power switch to turn the power on.

Step 1: Remove the formatter cover

1. Locate the formatter cover.

Figure 1-289 Locate the formatter cover

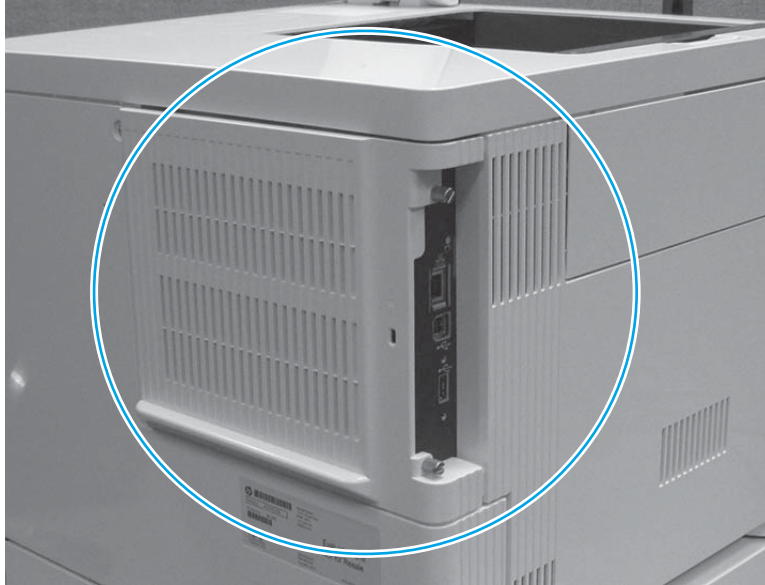

2. Loosen the two thumbscrews (callout 1). Grasp the two thumbscrews, and then slide the cover away from the printer (callout 2) to remove it.

 **TIP:** If needed, use the edge of a coin to turn the thumbscrews.

Figure 1-290 Loosen the thumbscrews



Step 2: Remove the rear upper cover

1. Remove two screws (callout 1).

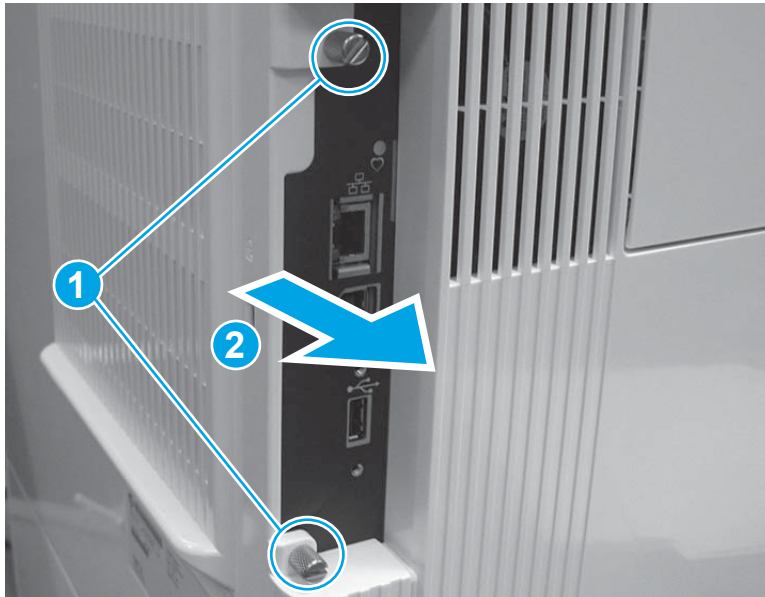
 **Reinstallation tip:** These two screws are self-tapping screws for plastic. When reinstalling them, rotate the screws counterclockwise to align them with the existing thread pattern, and then carefully turn them clockwise to tighten. Do not overtighten. This will prevent stripping the threads inside the screw holes.

Figure 1-291 Remove two screws



2. Use a small, flat blade screwdriver to release the right edge of the cover.

Figure 1-292 Release the right edge

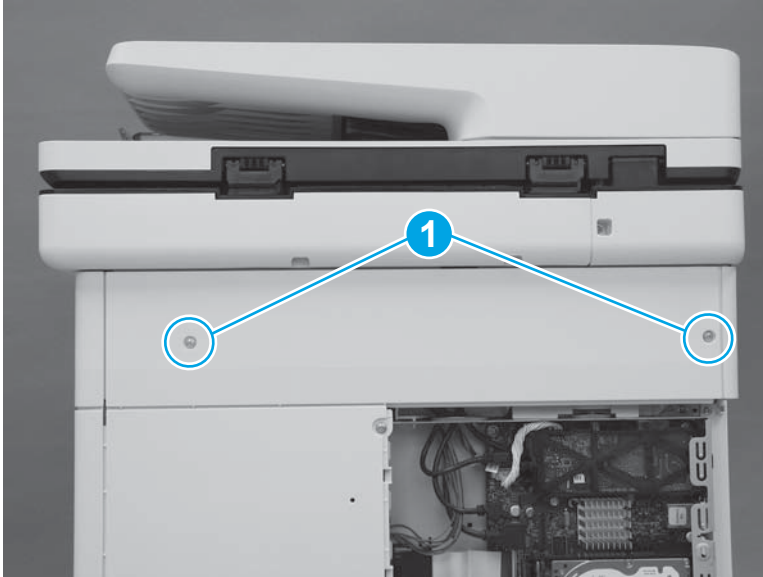
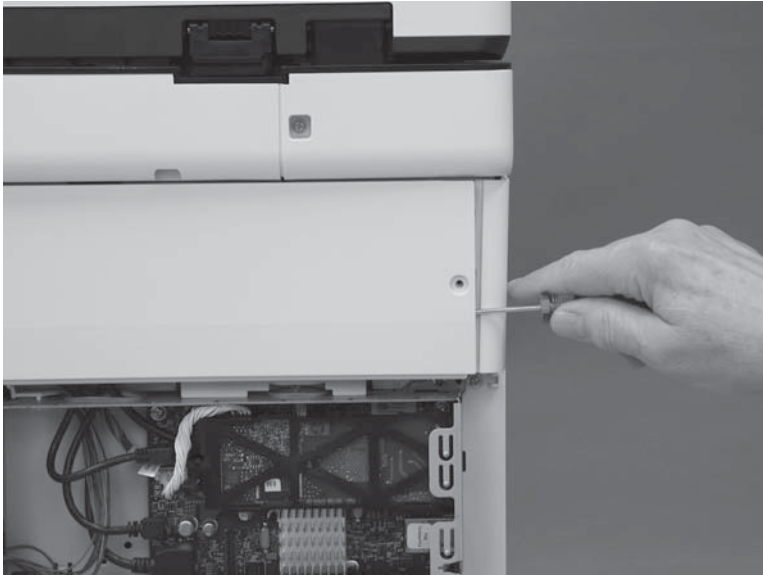

3. Pull the right edge of the cover (callout 1) away from the printer, and then slide the cover to the right (callout 2).

Figure 1-293 Slide the cover right

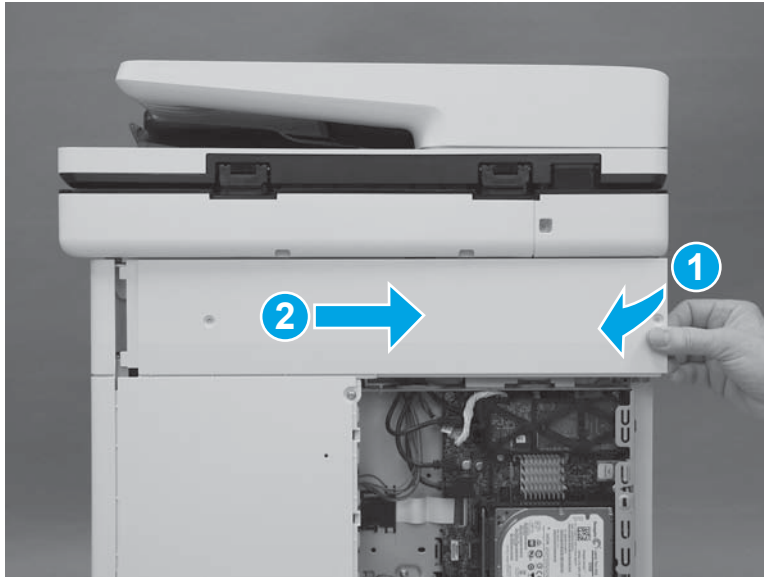

4. Remove the cover.

Figure 1-294 Remove the cover

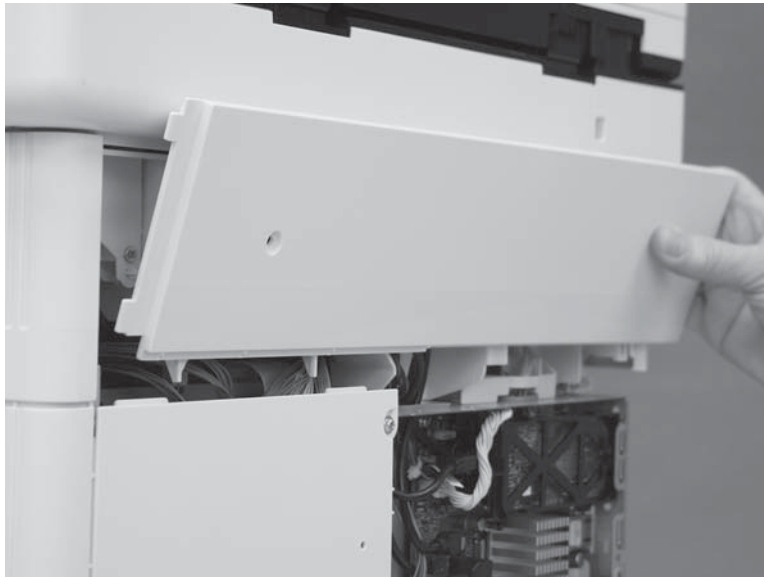

Step 3: Unpack the replacement assembly

Unpack the replacement assembly from the packaging.

For complete information on HP's recycling programs, go to [Product return and recycling](#).

 **NOTE:** HP recommends responsible disposal of the defective assembly.

Figure 1-295 Recycle and unpack

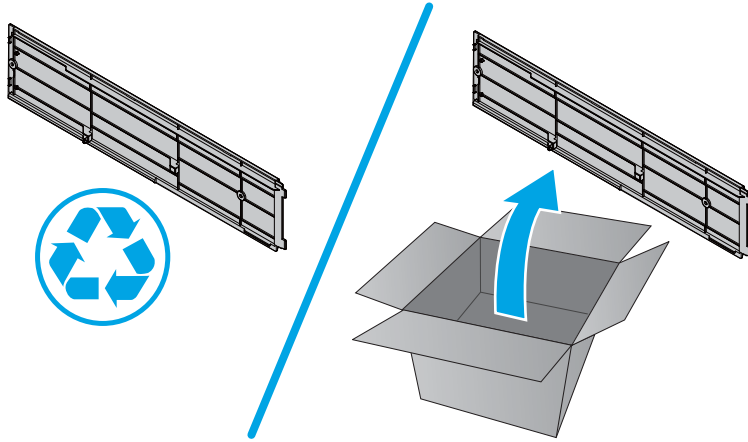

Step 4: Install the rear upper cover

1. Align the ridge (callout 1) on the lower edge of the rear upper cover in front of the tabs (callout 2) on the top edge of the rear cover.

Figure 1-296 Align the cover

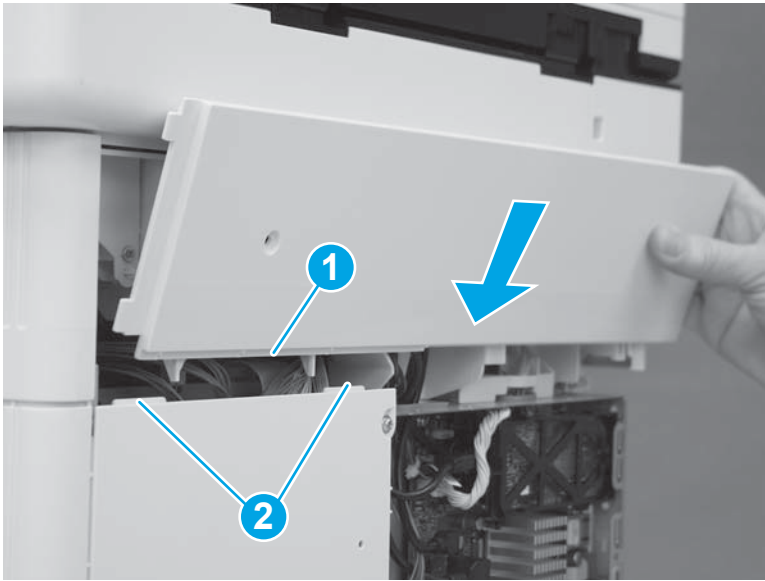

2. Rotate the top of the cover toward the printer.

Figure 1-297 Rotate the top of the cover

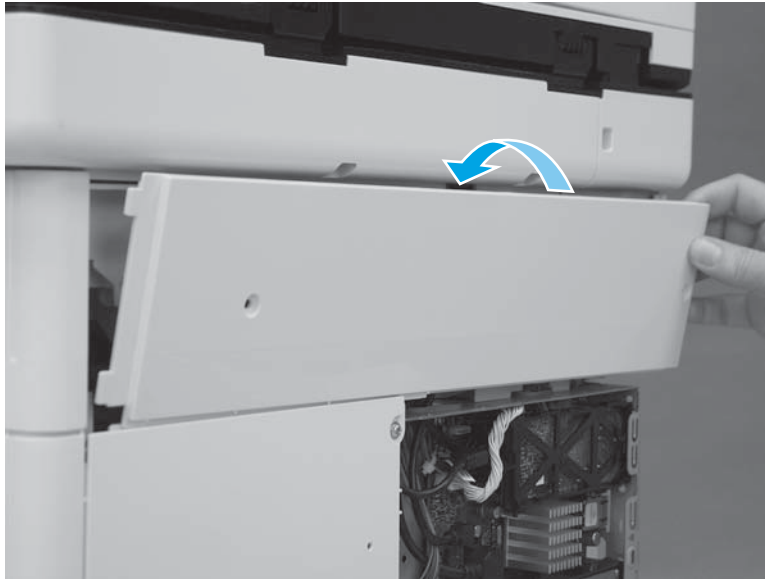

3. Slide the cover to the left (callout 1). Make sure that the tabs (callout 2) on the upper rear cover slide behind the edge (callout 3) of the right upper cover. Make sure that the cover is fully seated.

Figure 1-298 Slide the cover

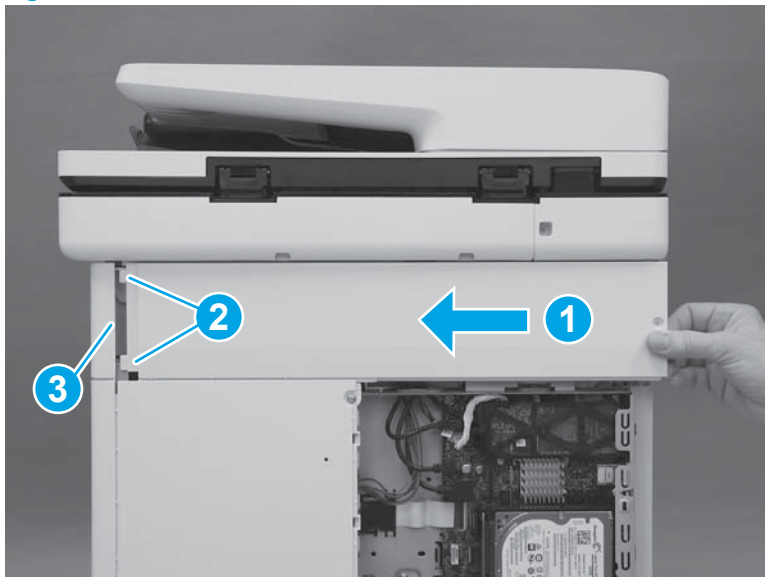

4. Install two screws (callout 1).



 **IMPORTANT:** These two screws are self-tapping screws for plastic. Rotate them counterclockwise to align them with the existing thread pattern, and then carefully turn them clockwise to tighten. Do not overtighten. This will prevent stripping the threads inside the screw holes.

Figure 1-299 Install two screws

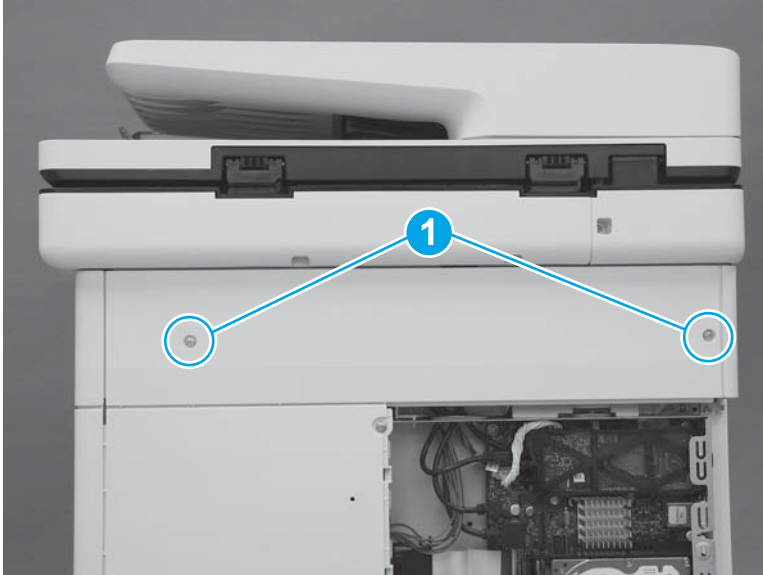

Step 5: Install the formatter cover

- ▲ Slide the cover onto the printer (callout 1) to install it.

 **NOTE:** Make sure that the tabs on the formatter cover align with the slots provided in the printer (callout 2). Tighten the two thumbscrews (callout 3).

 **TIP:** If needed, use the edge of a coin to turn the thumbscrews.

Figure 1-300 Install the cover



Removal and replacement: Left upper cover (M577)

- [Introduction](#)
- [Step 1: Remove the formatter cover](#)
- [Step 2: Remove the rear upper cover](#)
- [Step 3: Remove the left upper cover](#)
- [Step 4: Unpack the replacement assembly](#)
- [Step 5: Install the left upper cover](#)
- [Step 6: Install the rear upper cover](#)
- [Step 7: Install the formatter cover](#)

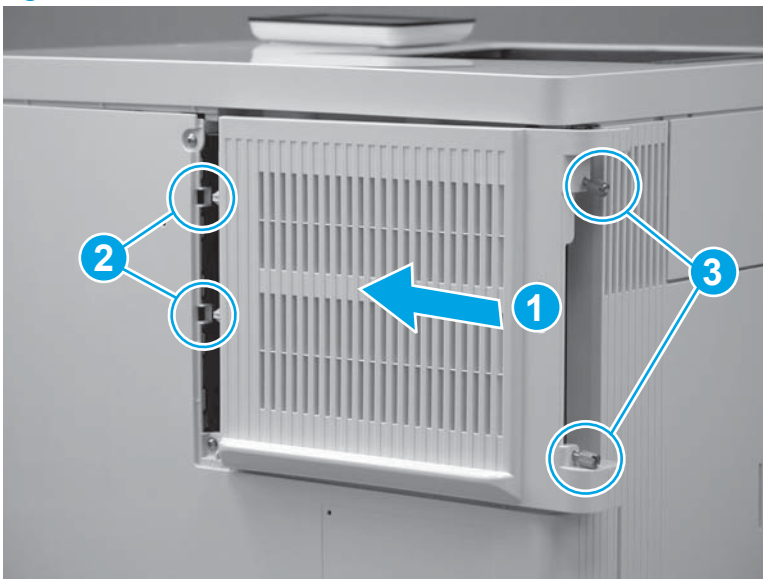
Introduction

This document provides the procedures to remove and replace the M577 left upper cover.

Before performing service

Turn the printer power off

- Disconnect the power cable.

 **WARNING!** To avoid damage to the printer, turn the printer off, wait 30 seconds, and then remove the power cord before attempting to service the printer.

Use the table below to identify the correct part number for your printer. To order the part, go to www.hp.com/buy/parts.

Left upper cover (M577) part number	
RC4-3384-000CN	Left upper cover (M577)

Required tools

- Small flat blade screwdriver
- #2 Phillips screwdriver with a magnetic tip

After performing service

Make sure that the left upper cover is fully seated after replacing it.

Turn the printer power on

- Connect the power cable.
- Use the power switch to turn the power on.

Step 1: Remove the formatter cover

1. Locate the formatter cover.

Figure 1-301 Locate the formatter cover

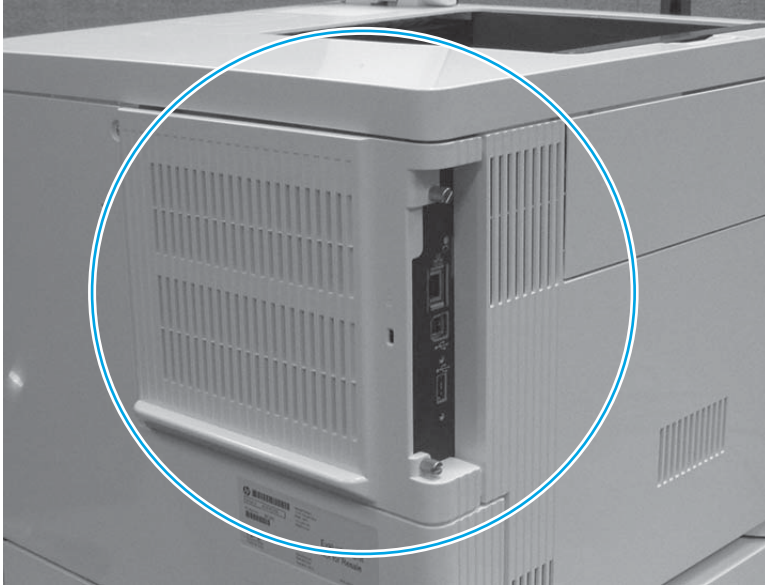

2. Loosen the two thumbscrews (callout 1). Grasp the two thumbscrews, and then slide the cover away from the printer (callout 2) to remove it.

 **TIP:** If needed, use the edge of a coin to turn the thumbscrews.

Figure 1-302 Loosen the thumbscrews



Step 2: Remove the rear upper cover

1. Remove two screws (callout 1).

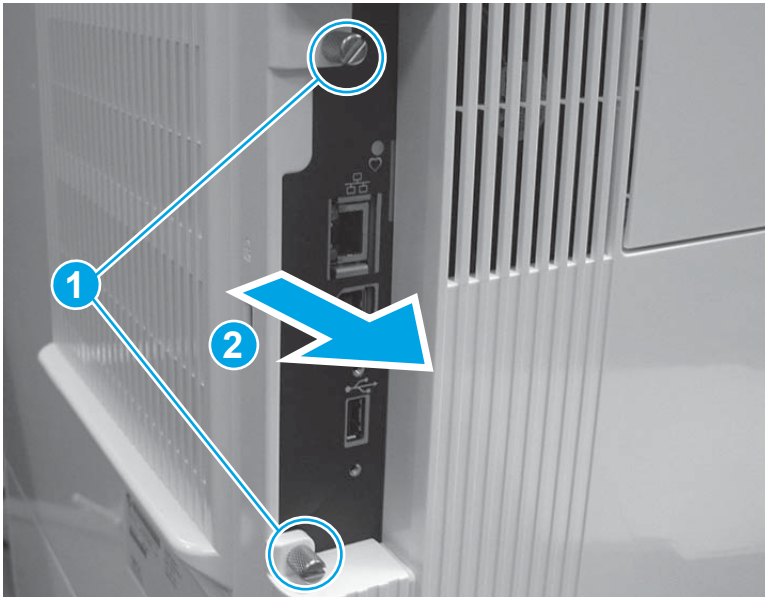
 **Reinstallation tip:** These two screws are self-tapping screws for plastic. When reinstalling them, rotate the screws counterclockwise to align them with the existing thread pattern, and then carefully turn them clockwise to tighten. Do not overtighten. This will prevent stripping the threads inside the screw holes.

Figure 1-303 Remove two screws



2. Use a small, flat blade screwdriver to release the right edge of the cover.

Figure 1-304 Release the right edge

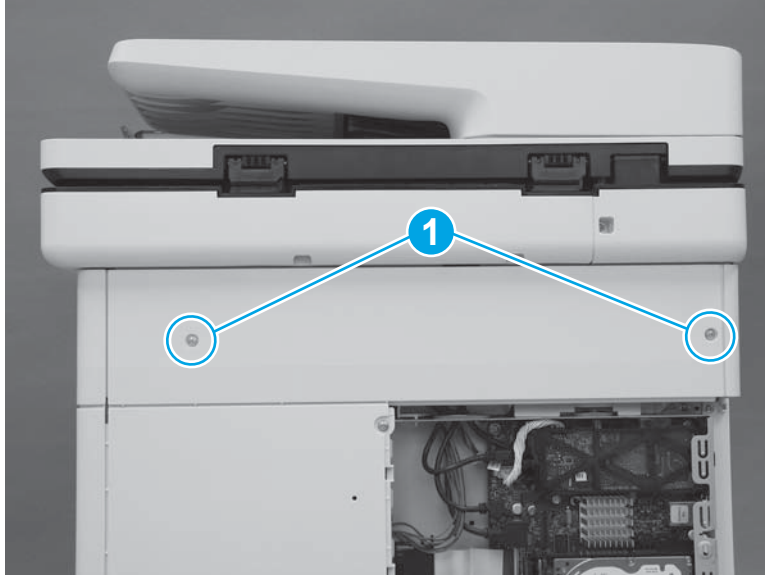
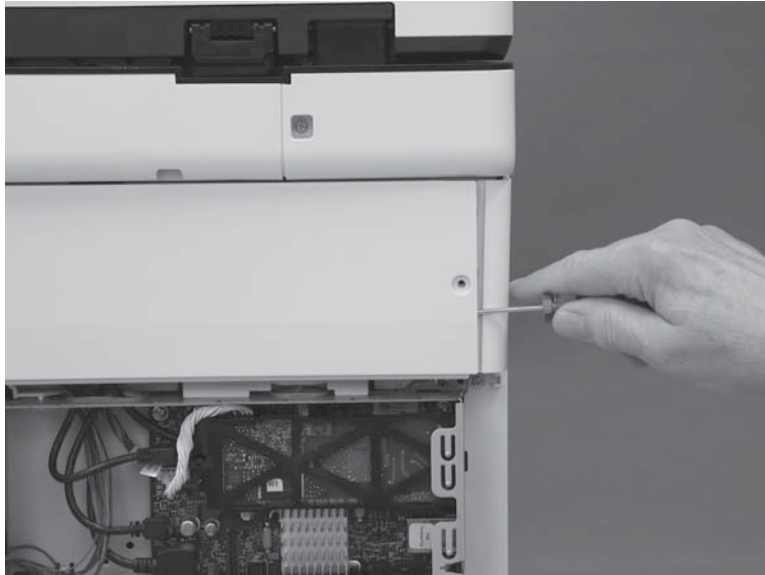

3. Pull the right edge of the cover (callout 1) away from the printer, and then slide the cover to the right (callout 2).

Figure 1-305 Slide the cover right

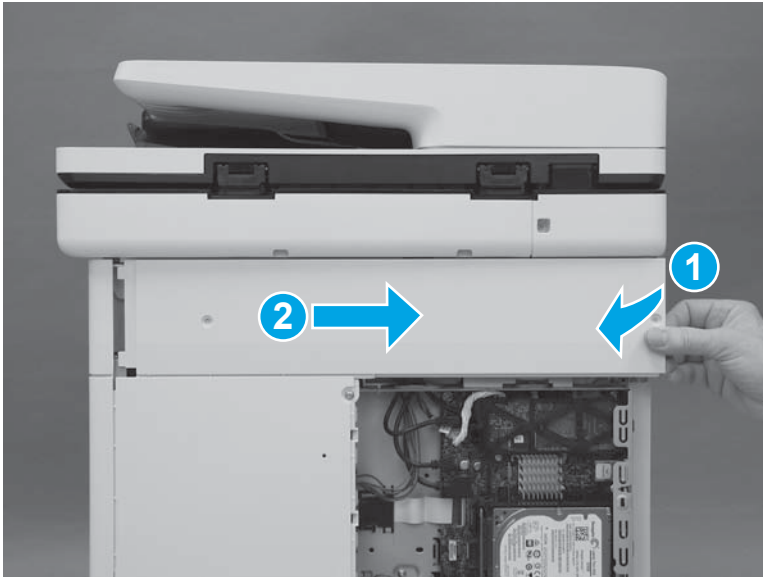

4. Remove the cover.

Figure 1-306 Remove the cover

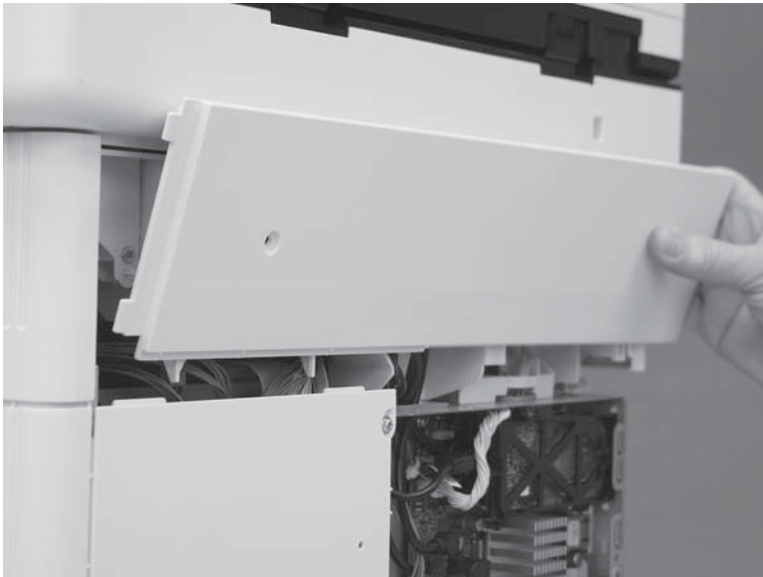

Step 3: Remove the left upper cover

1. At the left side of the printer, release one tab (callout 1).

Figure 1-307 Release one tab

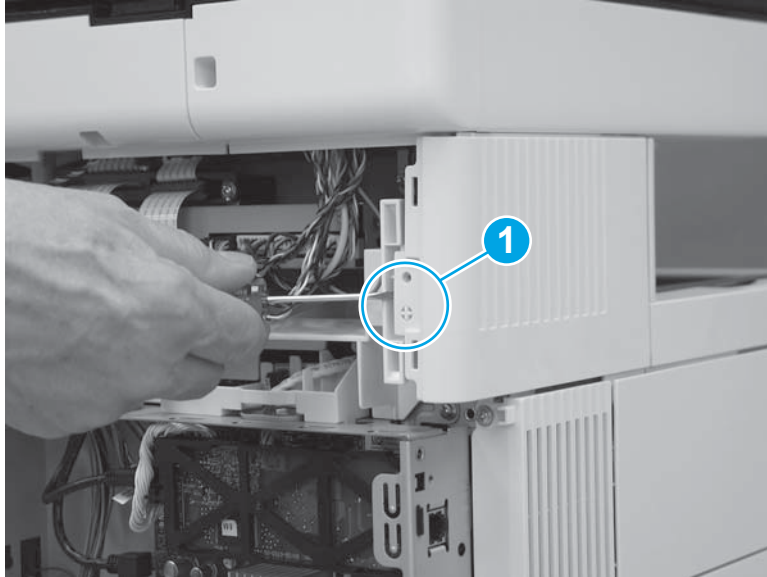

2. Slide the left upper cover toward the back of the printer.

Figure 1-308 Slide the cover back

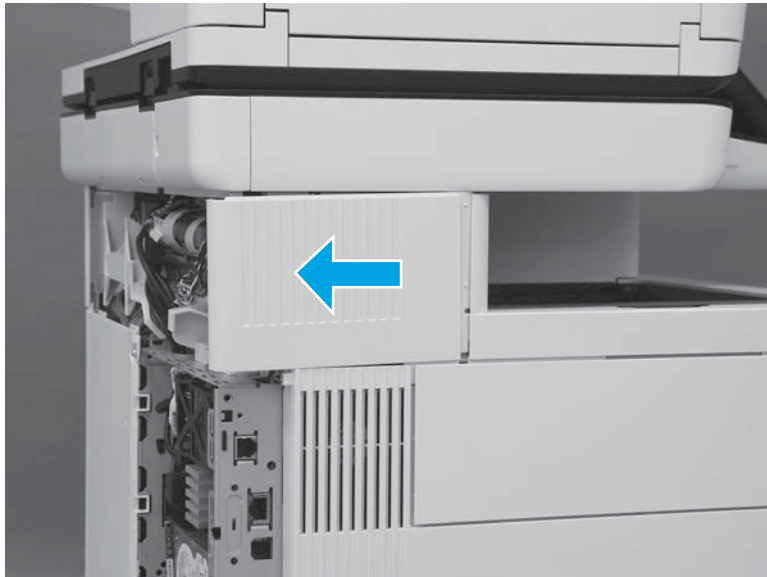

3. Rotate the cover up to remove it.

Figure 1-309 Remove the left upper cover

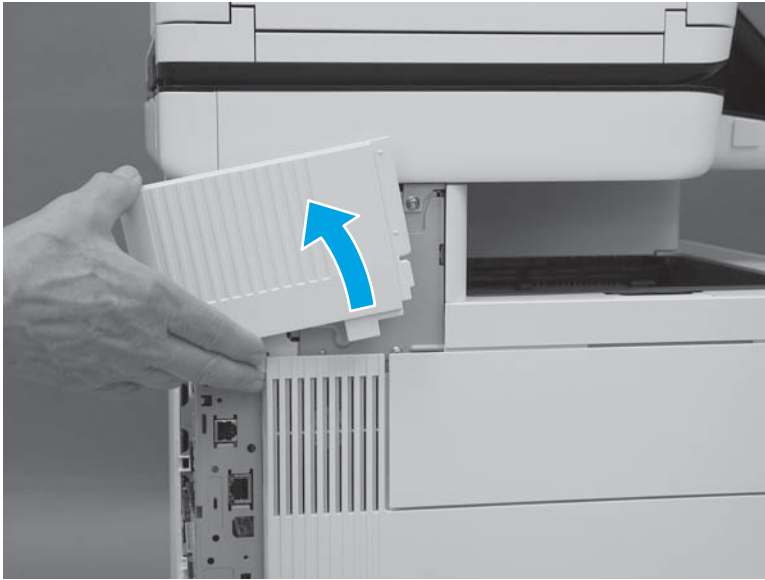

Step 4: Unpack the replacement assembly

Unpack the replacement assembly from the packaging.

For complete information on HP's recycling programs, go to [Product return and recycling](#).

 **NOTE:** HP recommends responsible disposal of the defective assembly.

Figure 1-310 Recycle and unpack



Step 5: Install the left upper cover

1. Position the tab (callout 1) on the lower edge of the cover behind the left cover (callout 2).

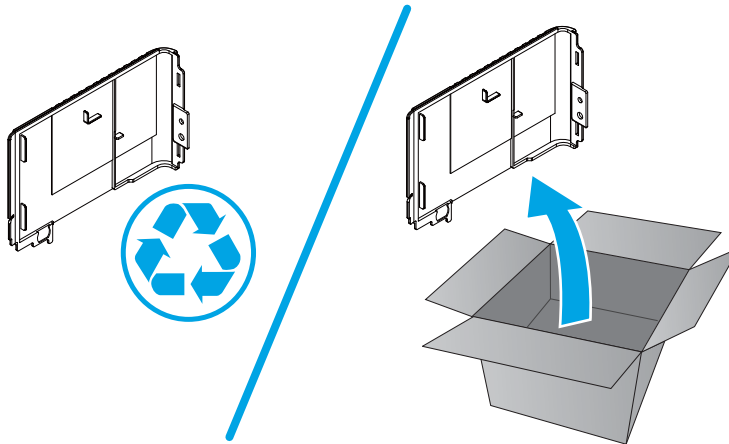
Figure 1-311 Position the tab

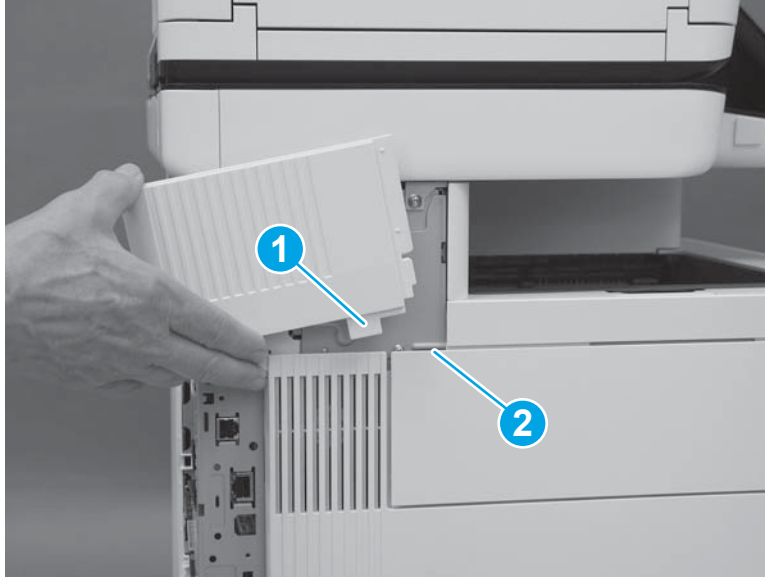

2. Slide the cover toward the front of the printer to install it. Make sure that the edge (callout 1) of the cover fits behind the edge (callout 2) of the top rear cover.

Figure 1-312 Slide the cover

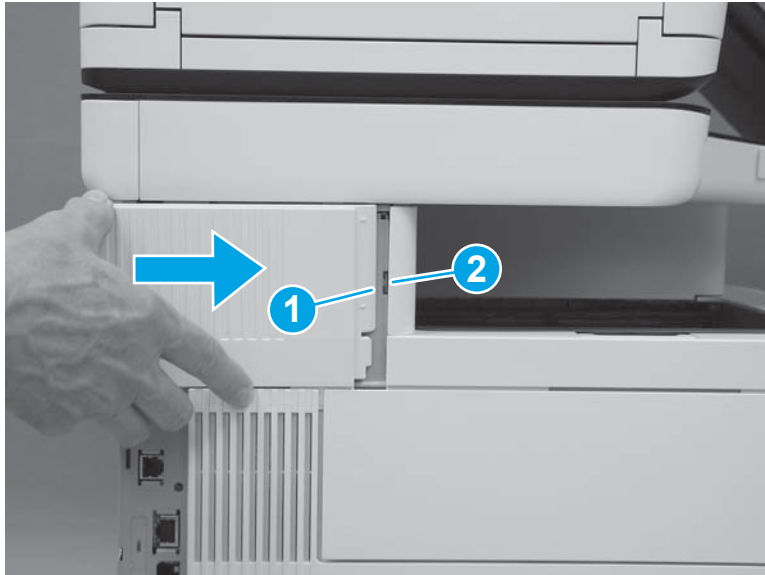

3. Make sure that the tab (callout 1) is fully installed.

Figure 1-313 Check the tab

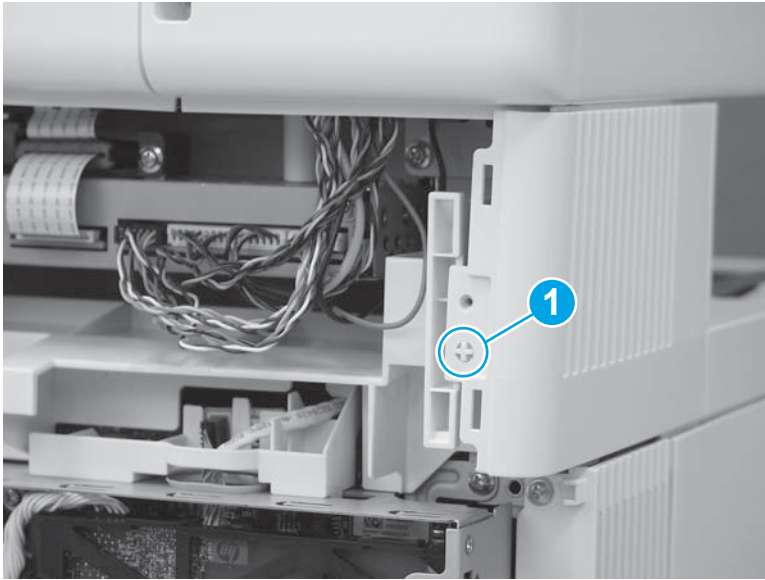

Step 6: Install the rear upper cover

1. Align the ridge (callout 1) on the lower edge of the rear upper cover in front of the tabs (callout 2) on the top edge of the rear cover.

Figure 1-314 Align the cover

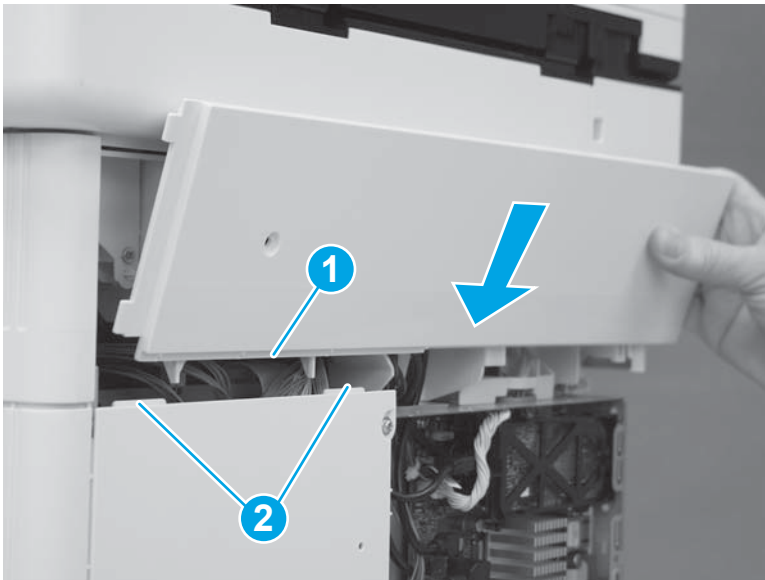

2. Rotate the top of the cover toward the printer.

Figure 1-315 Rotate the top of the cover



3. Slide the cover to the left (callout 1). Make sure that the tabs (callout 2) on the upper rear cover slide behind the edge (callout 3) of the right upper cover. Make sure that the cover is fully seated.

Figure 1-316 Slide the cover

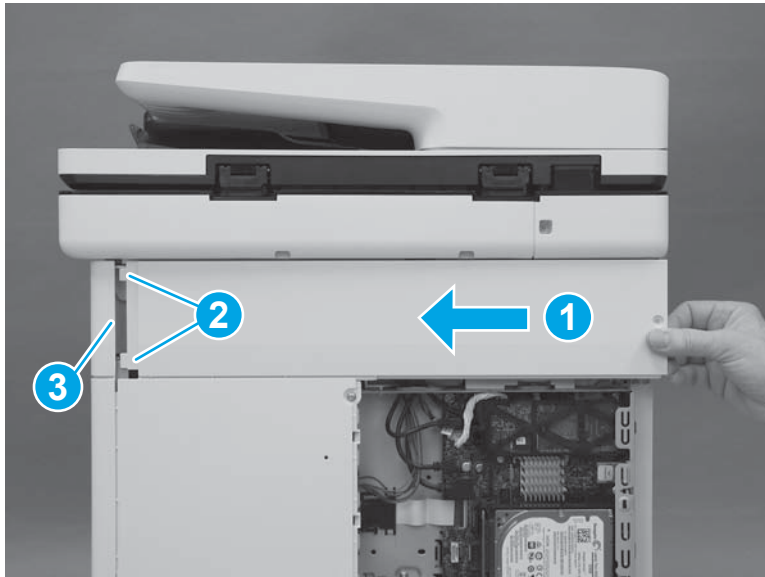

4. Install two screws (callout 1).



 **IMPORTANT:** These two screws are self-tapping screws for plastic. Rotate them counterclockwise to align them with the existing thread pattern, and then carefully turn them clockwise to tighten. Do not overtighten. This will prevent stripping the threads inside the screw holes.

Figure 1-317 Install two screws

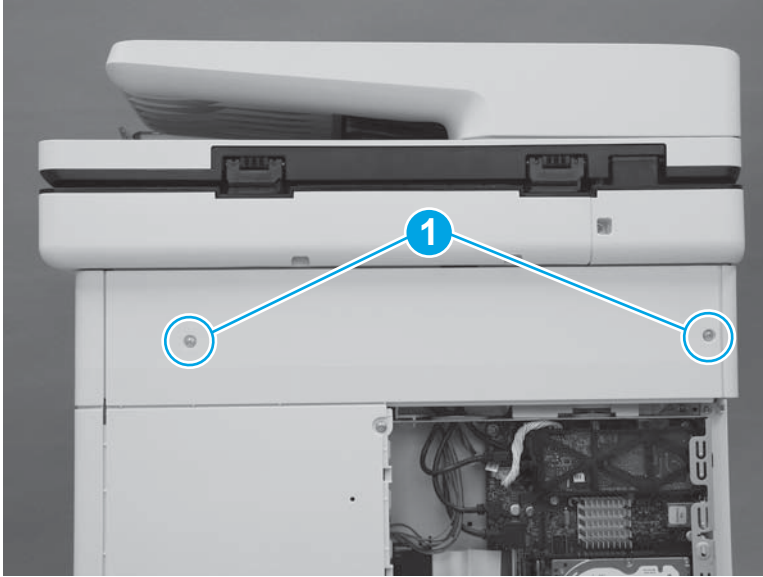

Step 7: Install the formatter cover

- ▲ Slide the cover onto the printer (callout 1) to install it.

 **NOTE:** Make sure that the tabs on the formatter cover align with the slots provided in the printer (callout 2). Tighten the two thumbscrews (callout 3).

 **TIP:** If needed, use the edge of a coin to turn the thumbscrews.

Figure 1-318 Install the cover



Removal and replacement: Right upper cover (M577)

- [Introduction](#)
- [Step 1: Remove the formatter cover](#)
- [Step 2: Remove the rear upper cover](#)
- [Step 3: Remove the right front upper cover \(M577dn\)](#)
- [Step 4: Remove the stapler cover assembly \(M577c/f/z\)](#)
- [Step 5: Remove the right upper cover \(M577\)](#)
- [Step 6: Unpack the replacement assembly](#)
- [Step 7: Install the right upper cover \(M577\)](#)
- [Step 8: Install the stapler cover assembly \(M577c/f/z\)](#)
- [Step 9: Install the right front upper cover \(M577dn\)](#)
- [Step 10: Install the rear upper cover](#)
- [Step 11: Install the formatter cover](#)

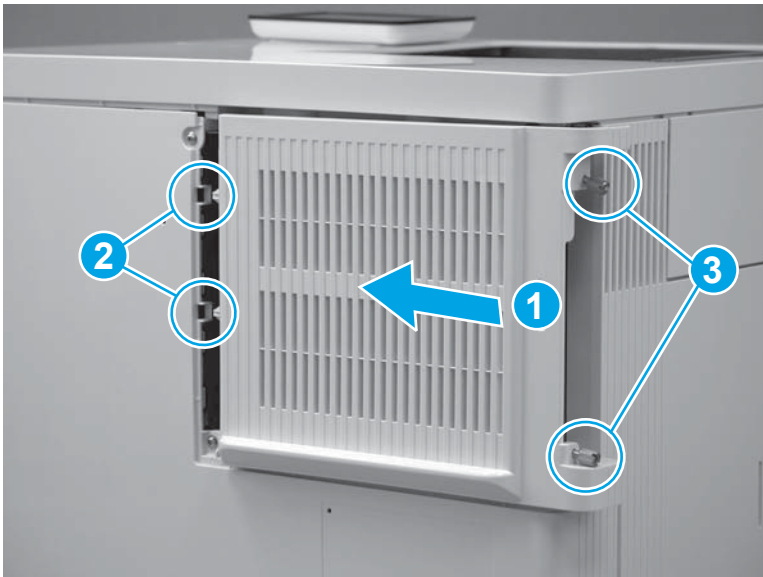
Introduction

This document provides the procedures to remove and replace the M577 right upper cover.

Before performing service

Turn the printer power off

- Disconnect the power cable.

 **WARNING!** To avoid damage to the printer, turn the printer off, wait 30 seconds, and then remove the power cord before attempting to service the printer.

Use the table below to identify the correct part number for your printer. To order the part, go to www.hp.com/buy/parts.

Right upper cover (M577) part number	
RC4-3386-000CN	Right upper cover (M577)

Required tools

- Small flat blade screwdriver
- #2 Phillips screwdriver with a magnetic tip

After performing service

Make sure that the right upper cover is fully seated after replacing it.

Turn the printer power on

- Connect the power cable.
- Use the power switch to turn the power on.

Step 1: Remove the formatter cover

1. Locate the formatter cover.

Figure 1-319 Locate the formatter cover

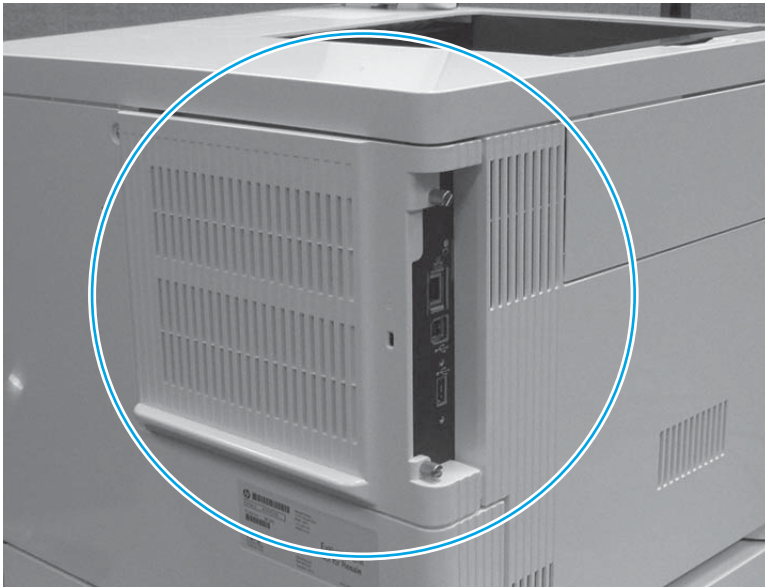

2. Loosen the two thumbscrews (callout 1). Grasp the two thumbscrews, and then slide the cover away from the printer (callout 2) to remove it.

 **TIP:** If needed, use the edge of a coin to turn the thumbscrews.

Figure 1-320 Loosen the thumbscrews

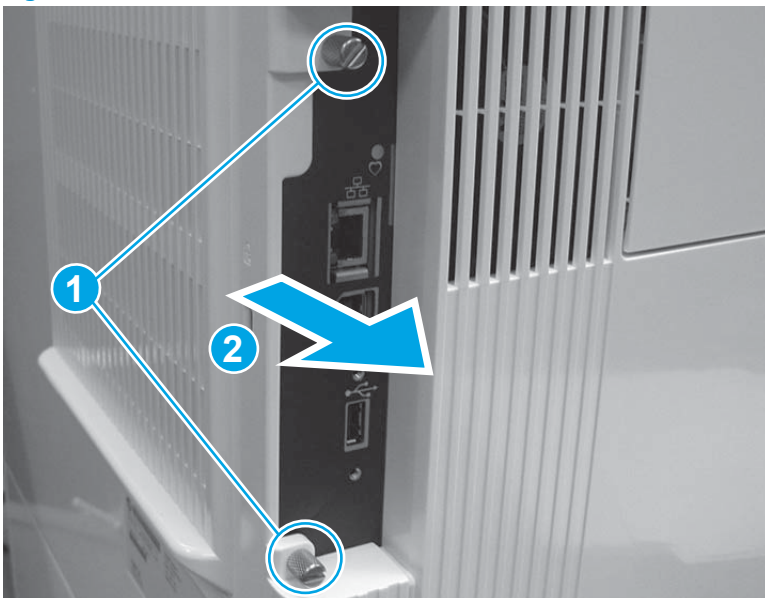

Step 2: Remove the rear upper cover

1. Remove two screws (callout 1).

 **Reinstallation tip:** These two screws are self-tapping screws for plastic. When reinstalling them, rotate the screws counterclockwise to align them with the existing thread pattern, and then carefully turn them clockwise to tighten. Do not overtighten. This will prevent stripping the threads inside the screw holes.

Figure 1-321 Remove two screws



2. Use a small, flat blade screwdriver to release the right edge of the cover.

Figure 1-322 Release the right edge

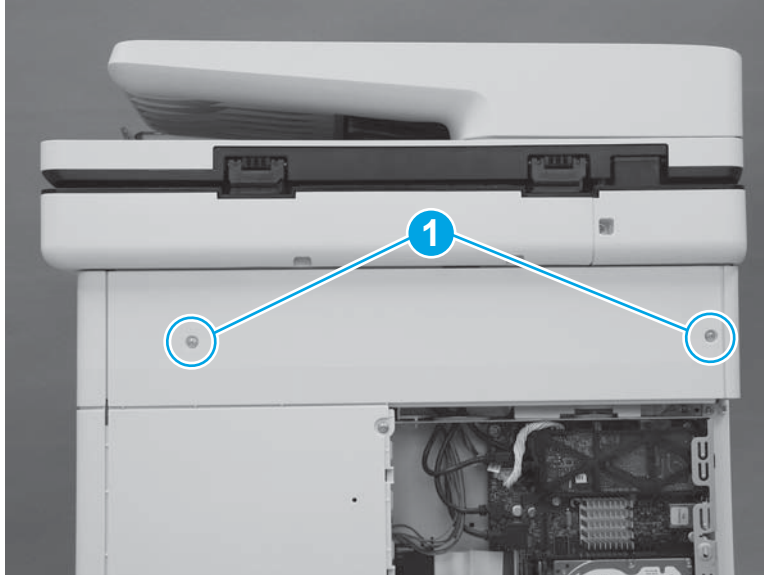
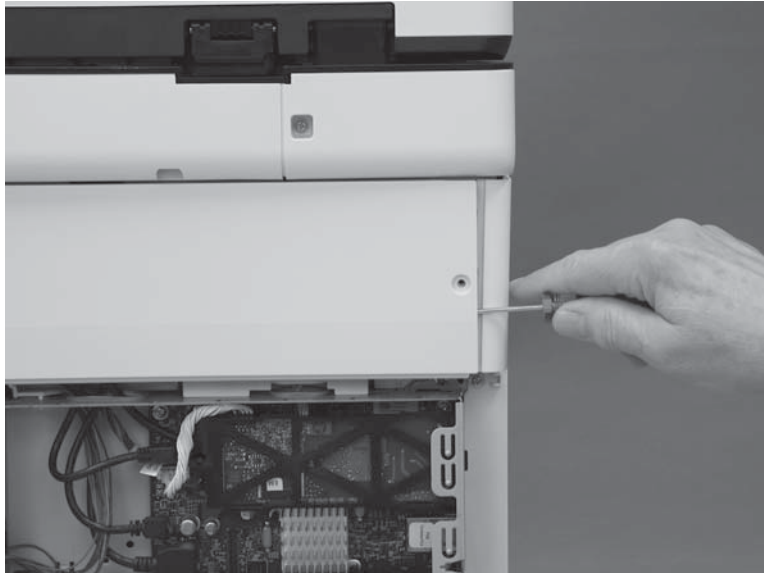

3. Pull the right edge of the cover (callout 1) away from the printer, and then slide the cover to the right (callout 2).

Figure 1-323 Slide the cover right

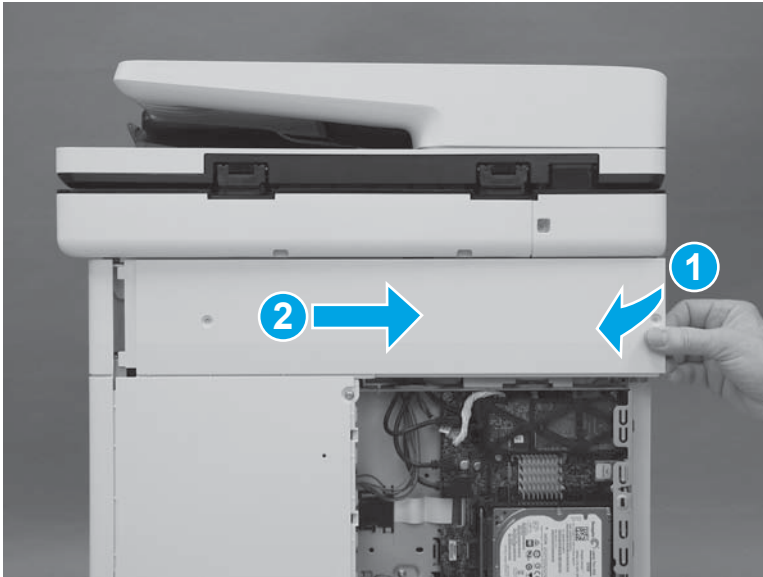

4. Remove the cover.

Figure 1-324 Remove the cover

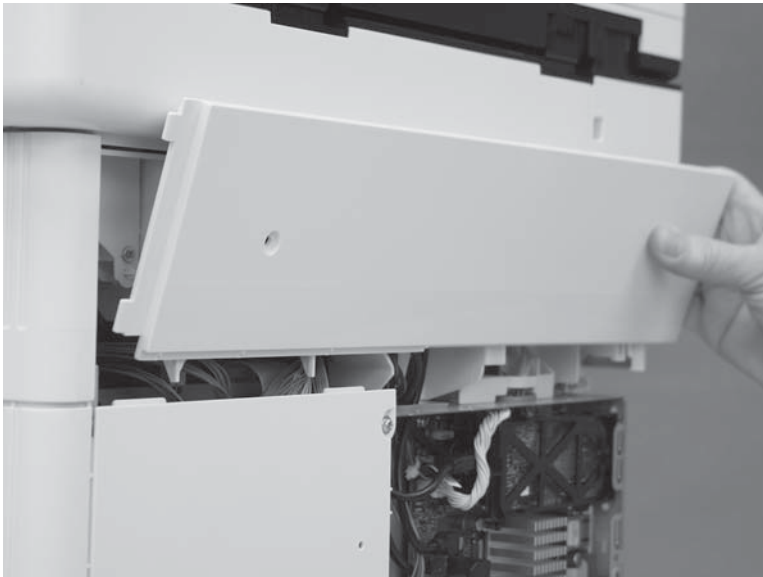

Step 3: Remove the right front upper cover (M577dn)

 **NOTE:** This step is for the M577dn model. For the M577c/f/z models, skip this step and to go [Step 4: Remove the stapler cover assembly \(M577c/f/z\) on page 214.](#)

1. Remove one screw (callout 1).

Figure 1-325 Remove one screw

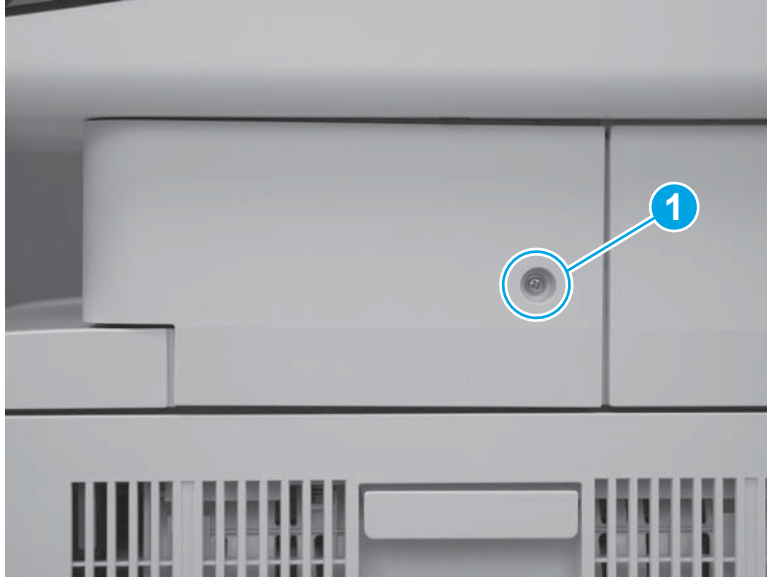

2. Release two tabs at the front edge of the cover (callout 1).

Figure 1-326 Release two tabs



3. Rotate the front of the cover to the right to remove it.

Figure 1-327 Rotate the cover



Step 4: Remove the stapler cover assembly (M577c/f/z)



NOTE: This step is for the M577c/f/z models. For the M577dn model, skip this step and to go [Step 5: Remove the right upper cover \(M577\) on page 216](#).

1. Remove one screw (callout 1).



Reinstallation tip: This is a self-tapping screw for plastic. When reinstalling, rotate the screw counterclockwise to align it with the existing thread pattern, and then carefully turn it clockwise to tighten. Do not overtighten. This will prevent stripping the threads inside the screw hole.

Figure 1-328 Remove one screw

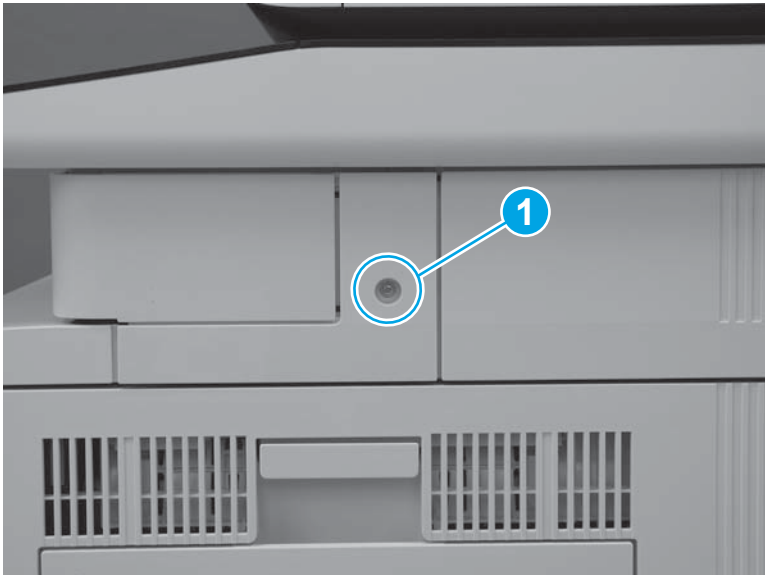

2. Release two tabs at the front edge of the cover (callout 1).

Figure 1-329 Release two tabs



3. Release the back edge of the cover.

Figure 1-330 Release the back edge of the cover



4. Rotate the cover away from the printer to remove it.

Figure 1-331 Remove the cover



Step 5: Remove the right upper cover (M577)

1. At the right side of the printer, remove two screws (callout 1).

M577c/f/z only: Disconnect one connector (callout 2).

Figure 1-332 Remove two screws and one connector

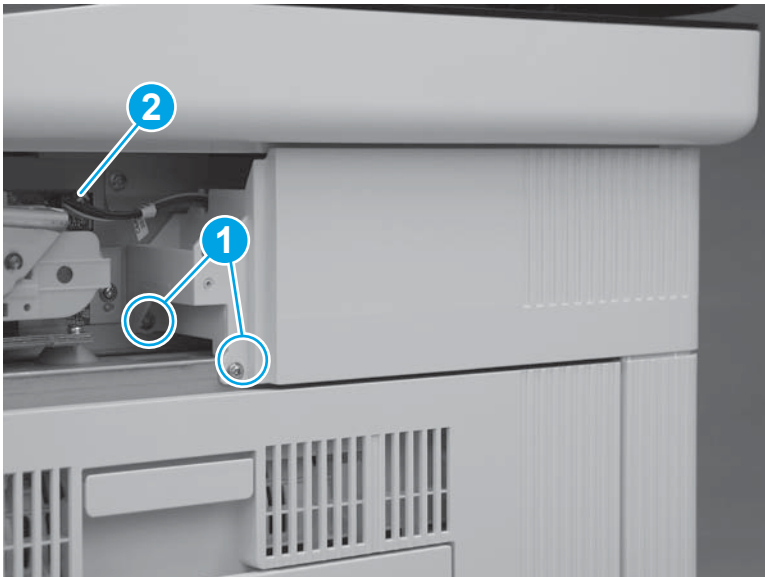

2. At the back of the printer, remove one screw (callout 1).

M577c/f/z only: Disconnect one connector (callout 2).

 **Reinstallation tip:** This screw is smaller than the screws removed in the previous step. When reinstalling the right upper cover, make sure that this screw is installed in the correct position.

Figure 1-333 Remove one screw and connector



3. Slide the cover toward the back of the printer.

Figure 1-334 Slide the cover

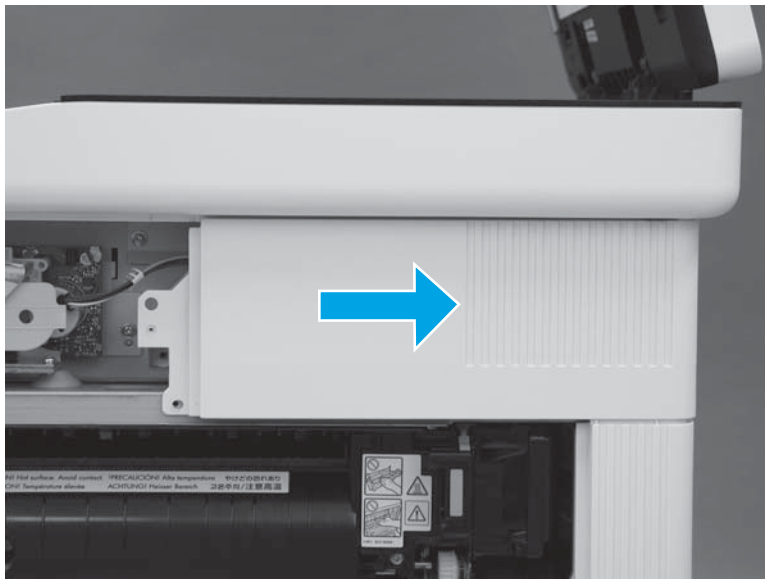

4. Lift the cover away from the printer to remove it.

M577c/f/z only: Release the cables (callout 1) through the slot (callout 2) in the printer.

Figure 1-335 Remove the cover

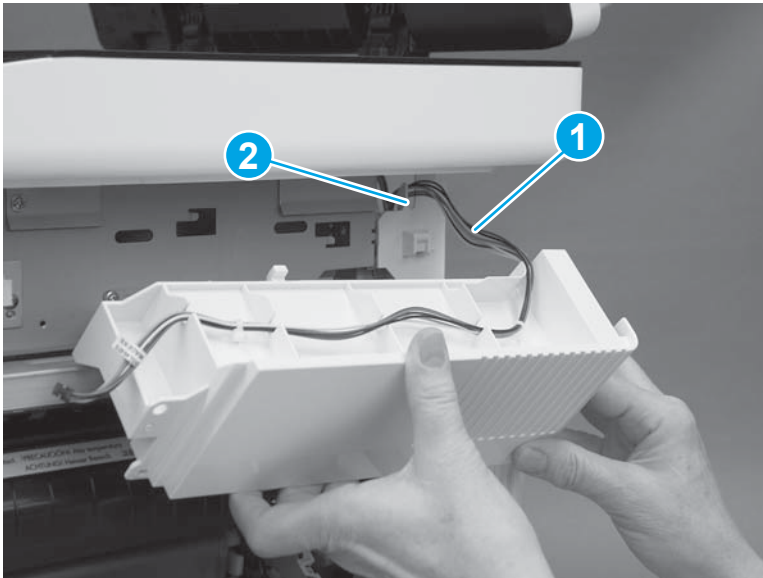

5. **M577c/f/z only:** Release two retainers on the bottom side of the cover.

Figure 1-336 Release two retainers

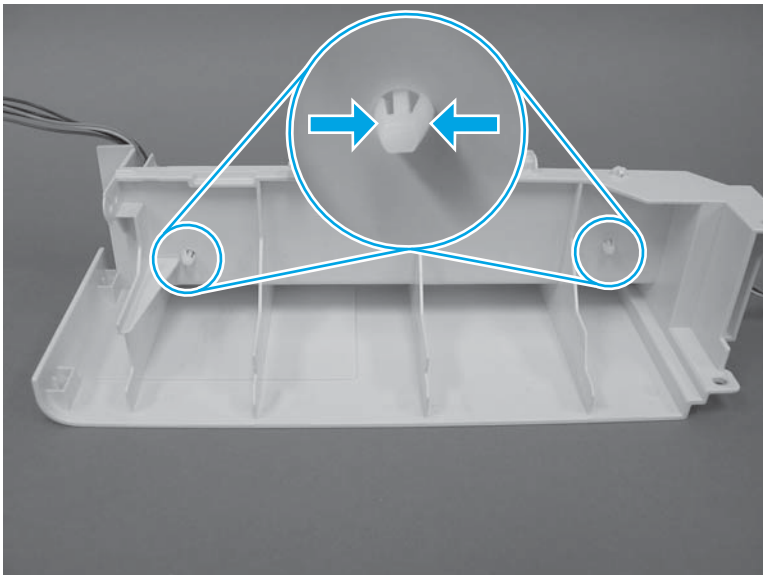

- M577c/f/z only:** On the top of the cover, release the wires (callout 1) from the guides (callout 2) in the right upper cover.

 **TIP:** Set the wire harness aside for installation on the replacement right upper cover.

Figure 1-337 Remove the wire harness

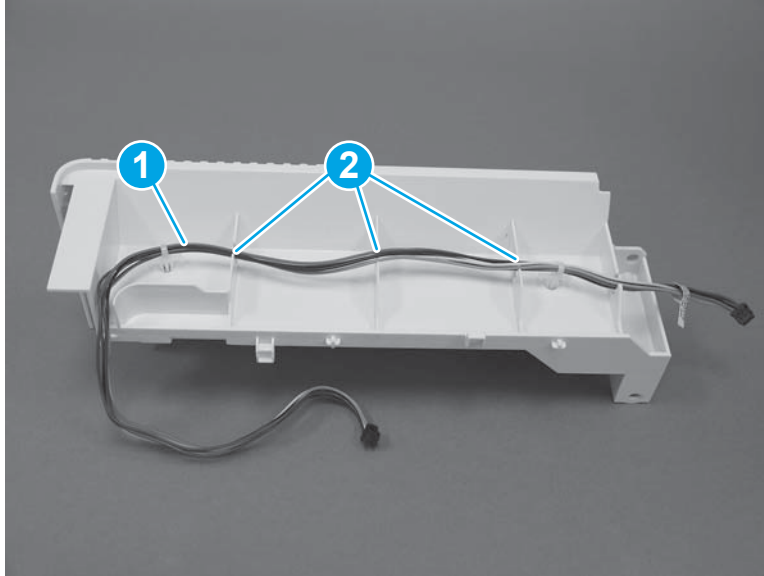

Step 6: Unpack the replacement assembly

Unpack the replacement assembly from the packaging.

For complete information on HP's recycling programs, go to [Product return and recycling](#).

 **NOTE:** HP recommends responsible disposal of the defective assembly.

Figure 1-338 Recycle and unpack

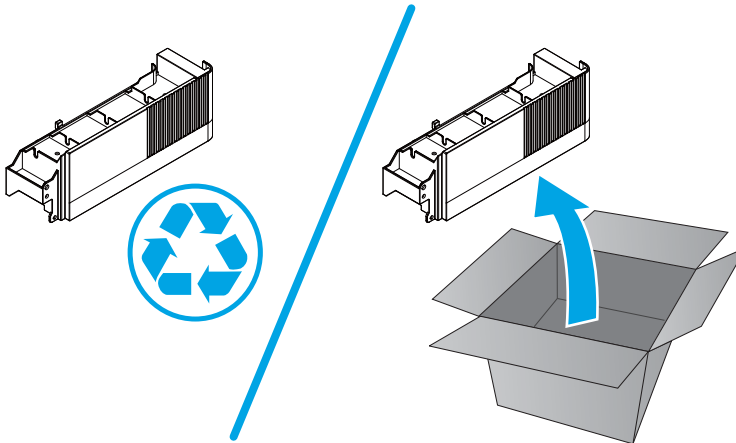

Step 7: Install the right upper cover (M577)

 **NOTE:** The M577z is shown in the figures below. The procedure is correct for all M577 models.

- M577c/f/z only:** Snap two retainers (callout 1) into place, and then install the wire harness (callout 2) in the guides (callout 3) in the cover.

Figure 1-339 Install the wire harness

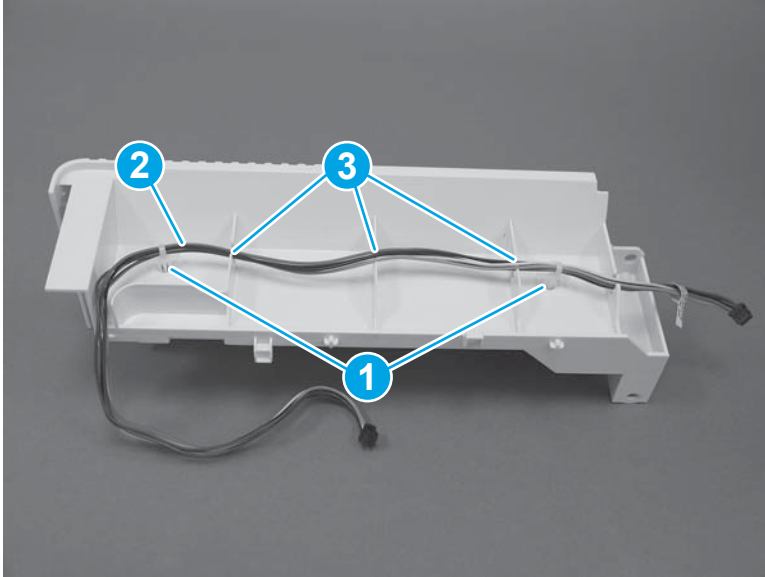

2. **M577c/f/z only:** Install the cables (callout 1) through the slot (callout 2) in the printer.

Figure 1-340 Install the cables

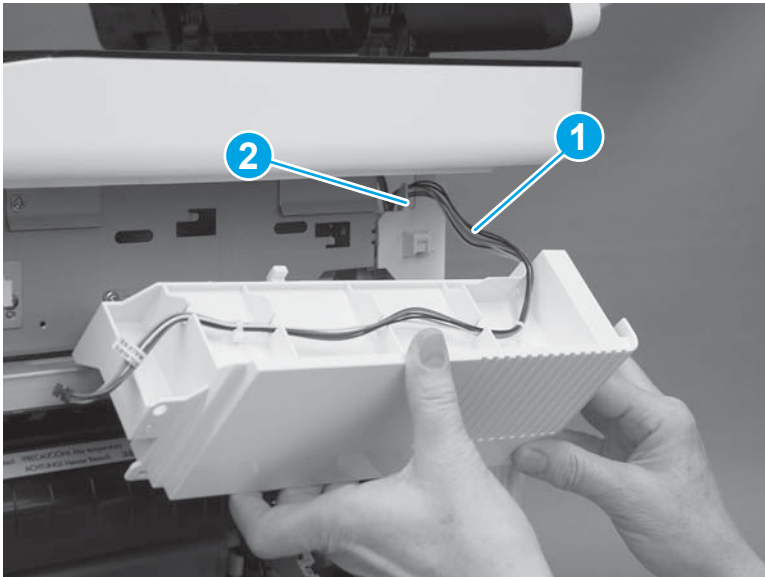

3. Position the hooks (callout 1) on the cover in the slots (callout 2) in the printer.

Figure 1-341 Position the hooks

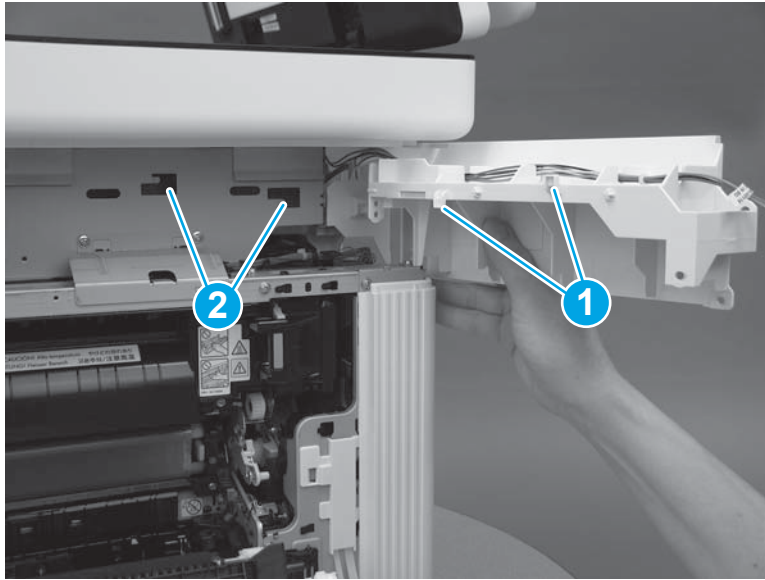

4. Slide the cover toward the front of the printer to install it.

Figure 1-342 Install the cover

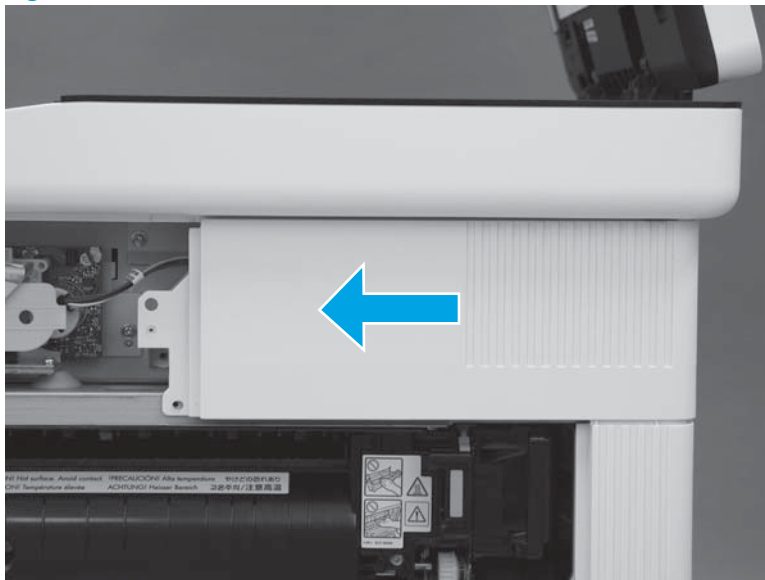

5. At the back of the printer, install one screw (callout 1).

M577c/f/z only: Connect one connector (callout 2).

 **TIP:** This screw is smaller than the screws installed in the next step. Make sure that this screw is installed in the correct position.

Figure 1-343 Install one screw and connector



6. At the right side of the printer, install two screws (callout 1).

M577c/f/z only: Connect one connector (callout 2).

Figure 1-344 Install one screw and connector

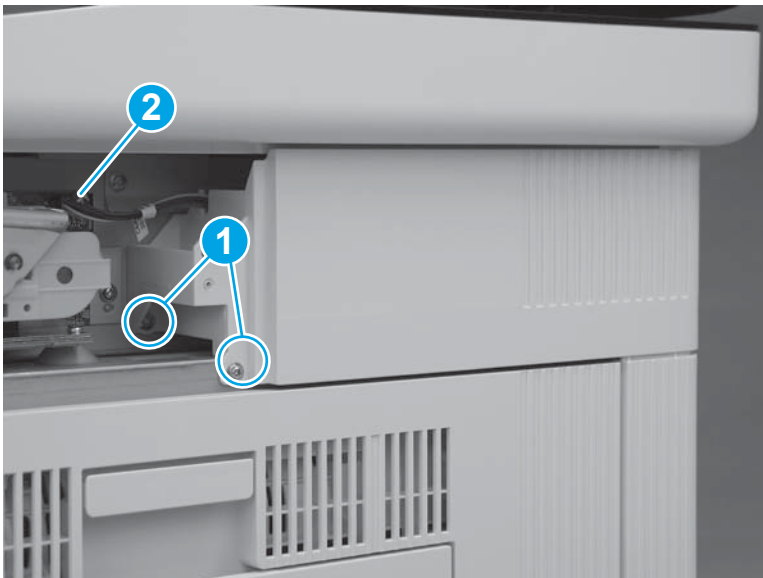

Step 8: Install the stapler cover assembly (M577c/f/z)

 **NOTE:** This step is for the M577c/f/z models only. For the M577dn model, skip this step and go to [Step 9: Install the right front upper cover \(M577dn\) on page 224.](#)

1. Install the tabs (callout 1) on the cover in the slots (callout 2) in the printer.

Figure 1-345 Install two tabs



2. Press the cover toward the left side of the printer until it snaps into place.

Figure 1-346 Install the cover assembly



3. Install one screw (callout 1).



 **IMPORTANT:** This is a self-tapping screw for plastic. Rotate it counterclockwise to align it with the existing thread pattern, and then carefully turn it clockwise to tighten. Do not overtighten. This will prevent stripping the threads inside the screw hole.

Figure 1-347 Install one screw

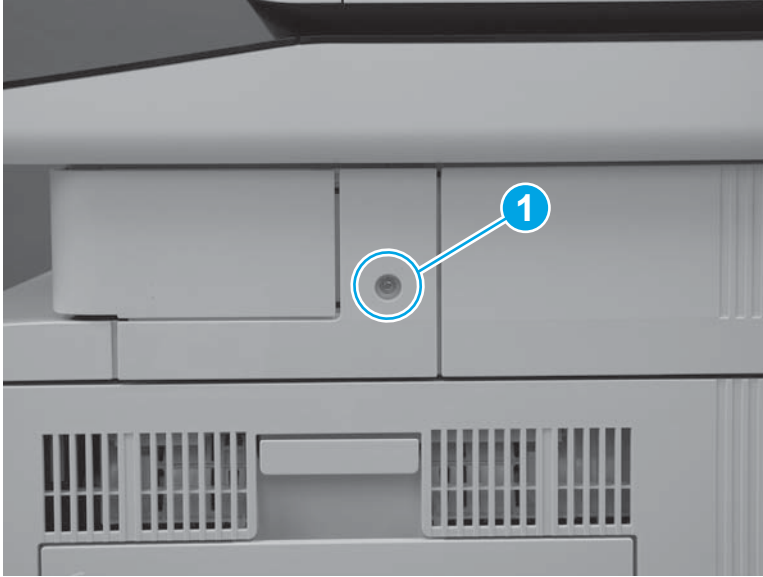

Step 9: Install the right front upper cover (M577dn)

 **NOTE:** This step is for the M577dn model only. For the M577c/f/z models, skip this step and go to [Step 10: Install the rear upper cover on page 225](#).

1. Slide the cover toward the left side of the printer to install it. Make sure that the slots (callout 1) in the cover fit over the tabs (callout 2) on the inside of the paper feeder cover.

Figure 1-348 Install the cover

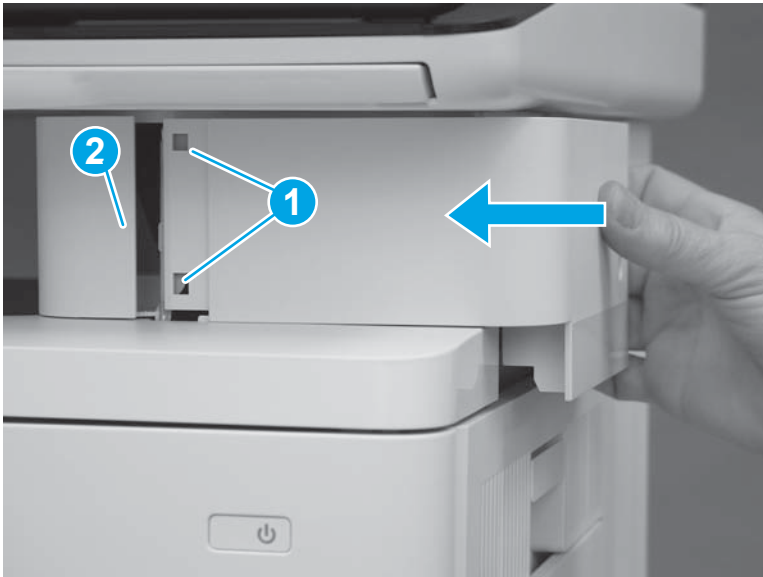

2. Press the right front upper cover (callout 1) and the paper feeder cover (callout 2) together until the tabs on the inside of the covers snap into place.

Figure 1-349 Press the cover



3. Install one screw (callout 1).

Figure 1-350 Install one screw

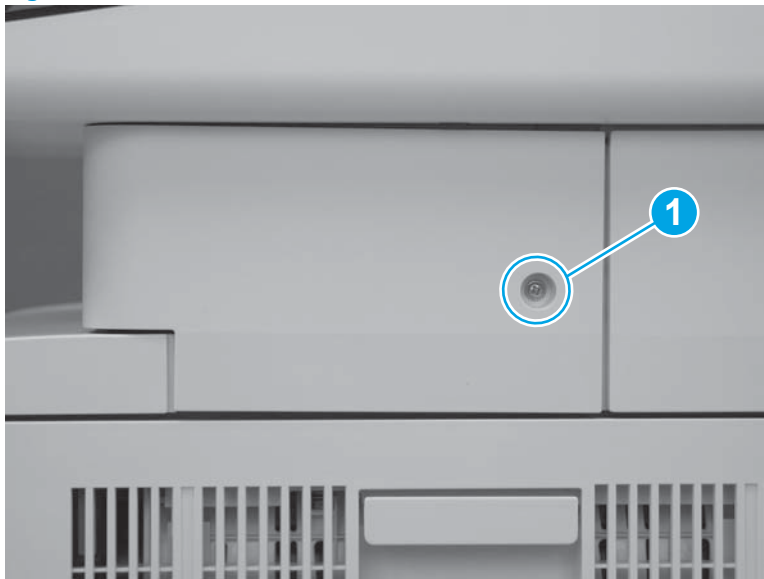

Step 10: Install the rear upper cover

1. Align the ridge (callout 1) on the lower edge of the rear upper cover in front of the tabs (callout 2) on the top edge of the rear cover.

Figure 1-351 Align the cover

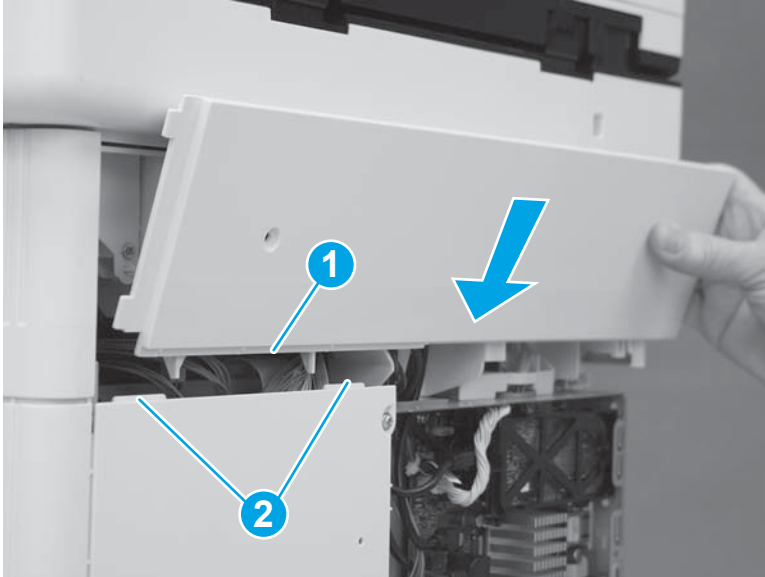

2. Rotate the top of the cover toward the printer.

Figure 1-352 Rotate the top of the cover

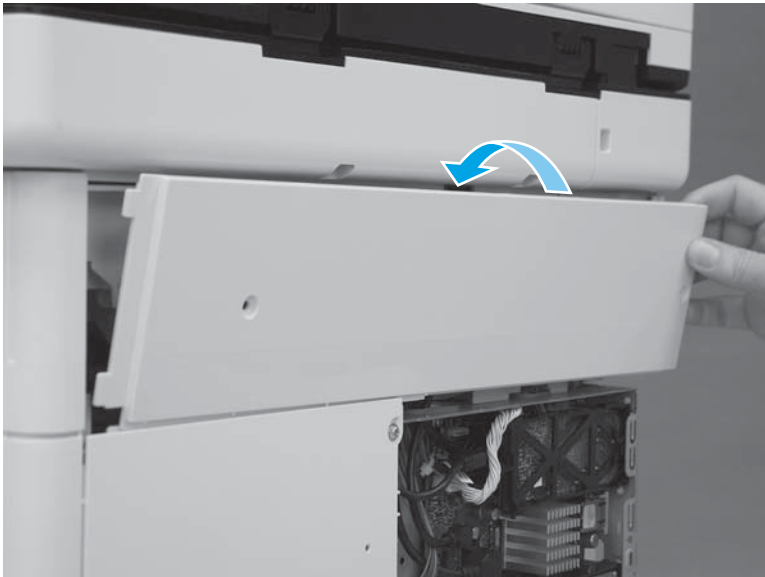

3. Slide the cover to the left (callout 1). Make sure that the tabs (callout 2) on the upper rear cover slide behind the edge (callout 3) of the right upper cover. Make sure that the cover is fully seated.

Figure 1-353 Slide the cover

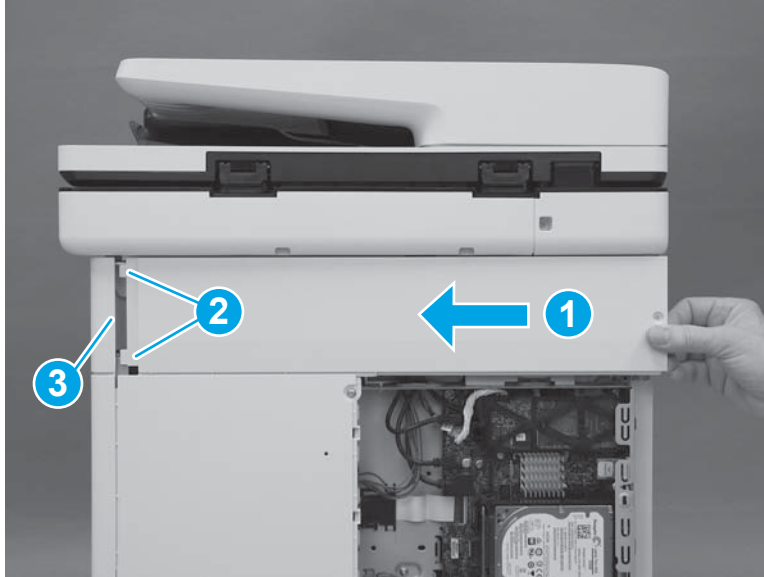

4. Install two screws (callout 1).



 **IMPORTANT:** These two screws are self-tapping screws for plastic. Rotate them counterclockwise to align them with the existing thread pattern, and then carefully turn them clockwise to tighten. Do not overtighten. This will prevent stripping the threads inside the screw holes.

Figure 1-354 Install two screws

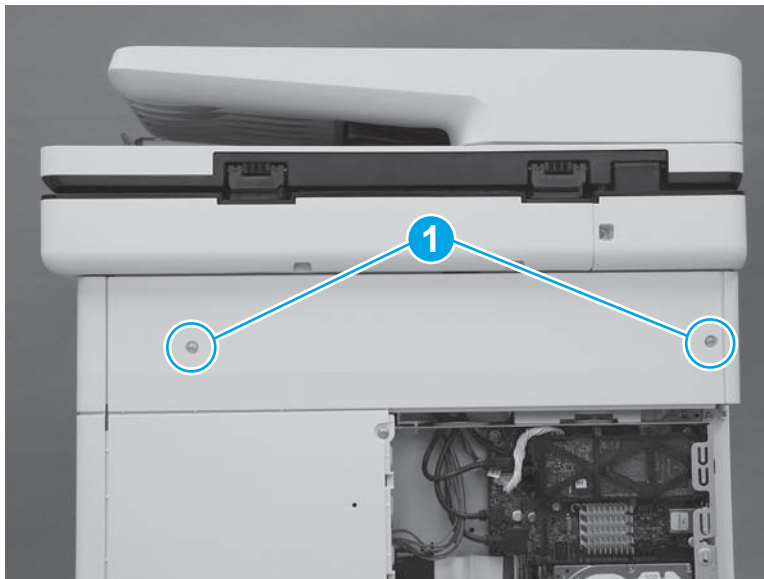

Step 11: Install the formatter cover

- ▲ Slide the cover onto the printer (callout 1) to install it.

 **NOTE:** Make sure that the tabs on the formatter cover align with the slots provided in the printer (callout 2). Tighten the two thumbscrews (callout 3).

 **TIP:** If needed, use the edge of a coin to turn the thumbscrews.

Figure 1-355 Install the cover



Removal and replacement: Top rear cover (M577)

- [Introduction](#)
- [Step 1: Remove the formatter cover](#)
- [Step 2: Remove the rear upper cover](#)
- [Step 3: Remove the left upper cover](#)
- [Step 4: Remove the right front upper cover \(M577dn\)](#)
- [Step 5: Remove the stapler cover assembly \(M577c/f/z\)](#)
- [Step 6: Remove the integrated scanner assembly \(ISA\) \(M577\)](#)
- [Step 7: Remove the right upper cover \(M577\)](#)
- [Step 8: Remove the top rear cover](#)
- [Step 9: Unpack the replacement assembly](#)
- [Step 10: Install the top rear cover](#)
- [Step 11: Install the right upper cover \(M577\)](#)
- [Step 12: Install the integrated scanner assembly \(ISA\) \(M577\)](#)
- [Step 13: Install the stapler cover assembly \(M577c/f/z\)](#)
- [Step 14: Install the right front upper cover \(M577dn\)](#)
- [Step 15: Install the left upper cover](#)
- [Step 16: Install the rear upper cover](#)
- [Step 17: Install the formatter cover](#)

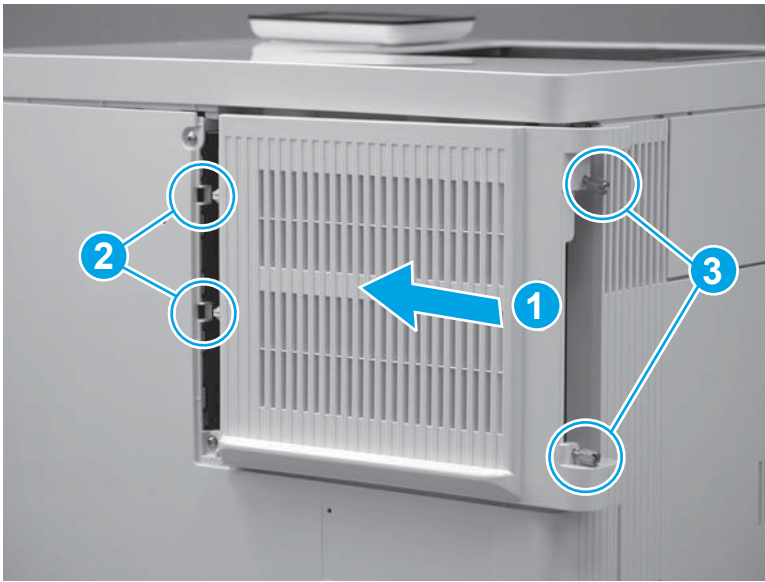
Introduction

This document provides the procedures to remove and replace the M577 top rear cover.

Before performing service

Turn the printer power off

- Disconnect the power cable.

 **WARNING!** To avoid damage to the printer, turn the printer off, wait 30 seconds, and then remove the power cord before attempting to service the printer.

Use the table below to identify the correct part number for your printer. To order the part, go to www.hp.com/buy/parts.

Top rear cover (M577) part number	
RC4-3383-000CN	Top rear cover (M577)

Required tools

- Small flat blade screwdriver
- #2 Phillips screwdriver with a magnetic tip

After performing service

Make sure that the top rear cover is fully seated after replacing it.

Turn the printer power on

- Connect the power cable.
- Use the power switch to turn the power on.

Step 1: Remove the formatter cover

1. Locate the formatter cover.

Figure 1-356 Locate the formatter cover

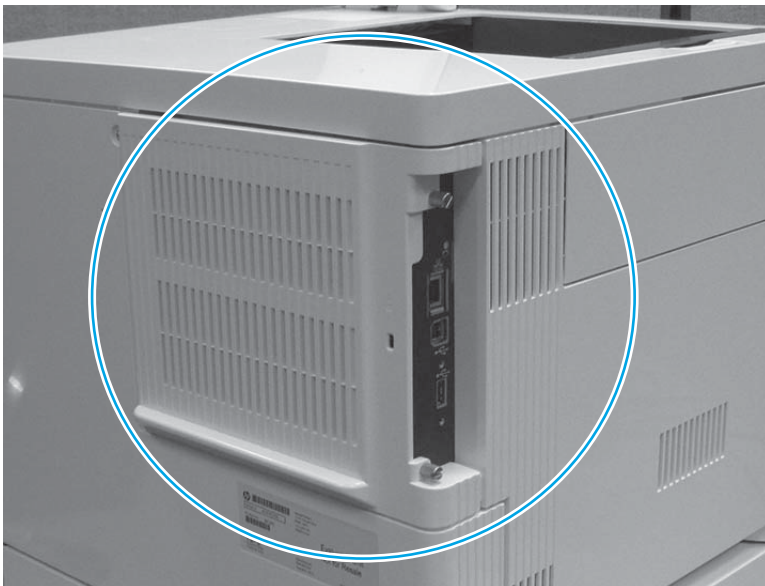

2. Loosen the two thumbscrews (callout 1). Grasp the two thumbscrews, and then slide the cover away from the printer (callout 2) to remove it.

 **TIP:** If needed, use the edge of a coin to turn the thumbscrews.

Figure 1-357 Loosen the thumbscrews



Step 2: Remove the rear upper cover

1. Remove two screws (callout 1).

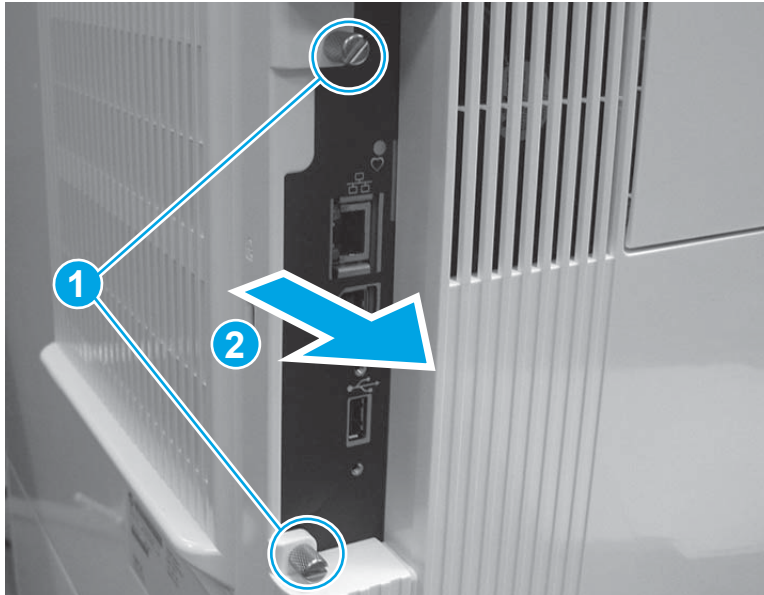
 **Reinstallation tip:** These two screws are self-tapping screws for plastic. When reinstalling them, rotate the screws counterclockwise to align them with the existing thread pattern, and then carefully turn them clockwise to tighten. Do not overtighten. This will prevent stripping the threads inside the screw holes.

Figure 1-358 Remove two screws



2. Use a small, flat blade screwdriver to release the right edge of the cover.

Figure 1-359 Release the right edge

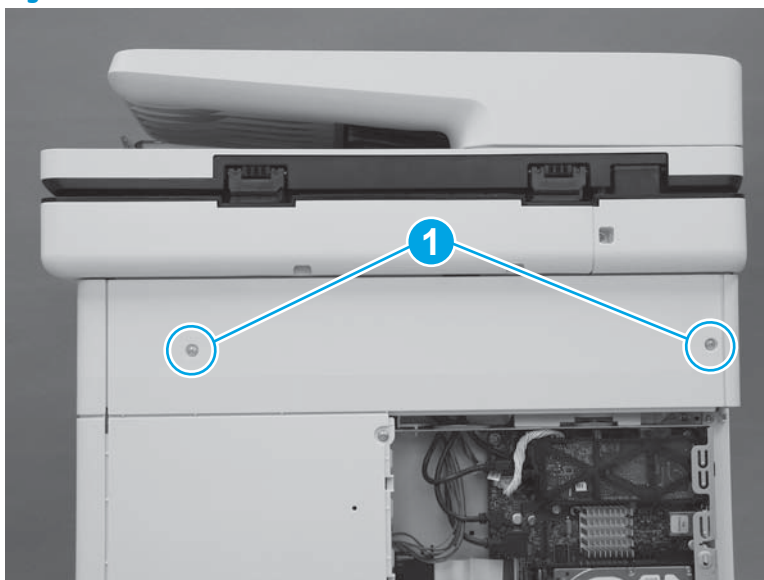
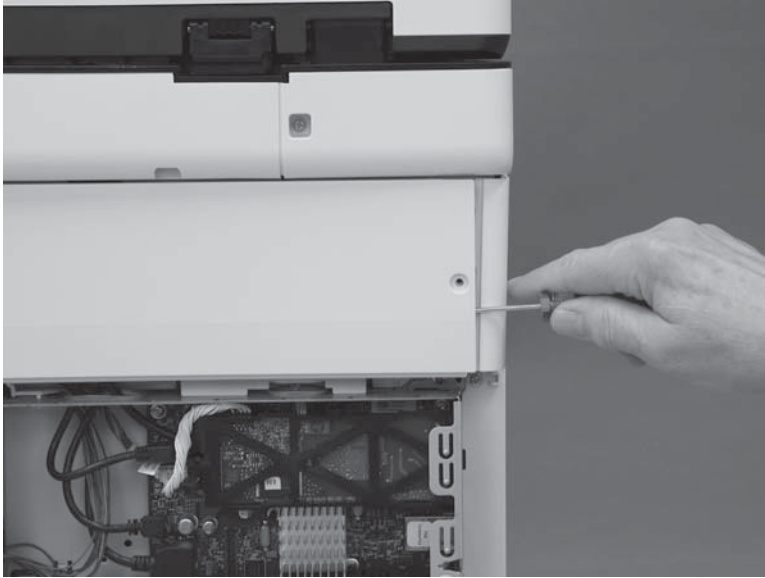

3. Pull the right edge of the cover (callout 1) away from the printer, and then slide the cover to the right (callout 2).

Figure 1-360 Slide the cover right

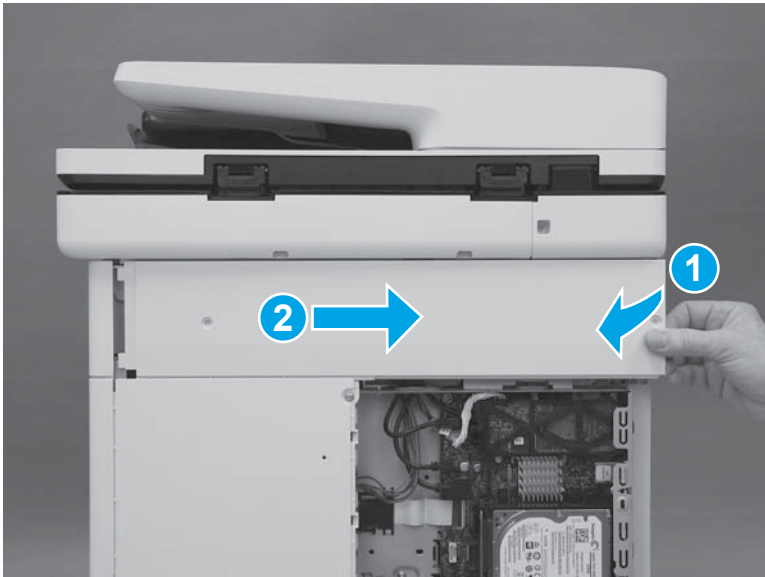

4. Remove the cover.

Figure 1-361 Remove the cover



Step 3: Remove the left upper cover

1. At the left side of the printer, release one tab (callout 1).

Figure 1-362 Release one tab

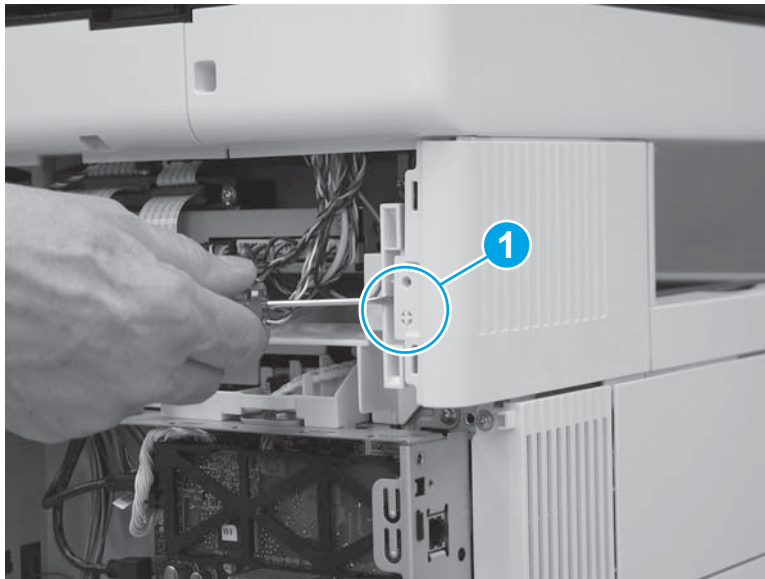

2. Slide the left upper cover toward the back of the printer.

Figure 1-363 Slide the cover back

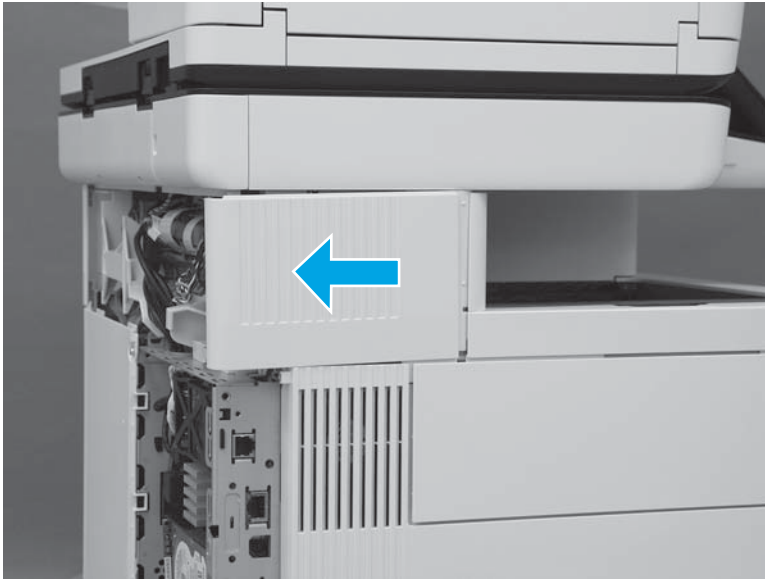

3. Rotate the cover up to remove it.

Figure 1-364 Remove the left upper cover

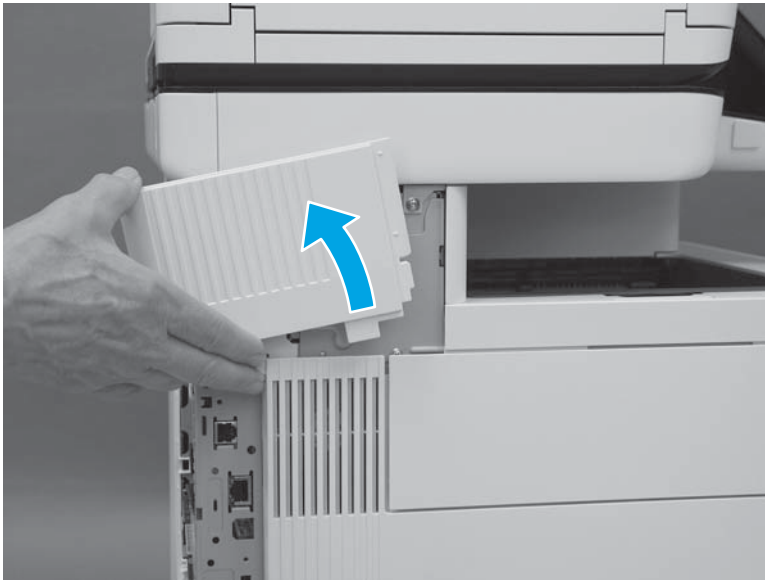

Step 4: Remove the right front upper cover (M577dn)



NOTE: This step is for the M577dn model. For the M577c/f/z models, skip this step and to go [Step 5: Remove the stapler cover assembly \(M577c/f/z\) on page 236.](#)

1. Remove one screw (callout 1).

Figure 1-365 Remove one screw

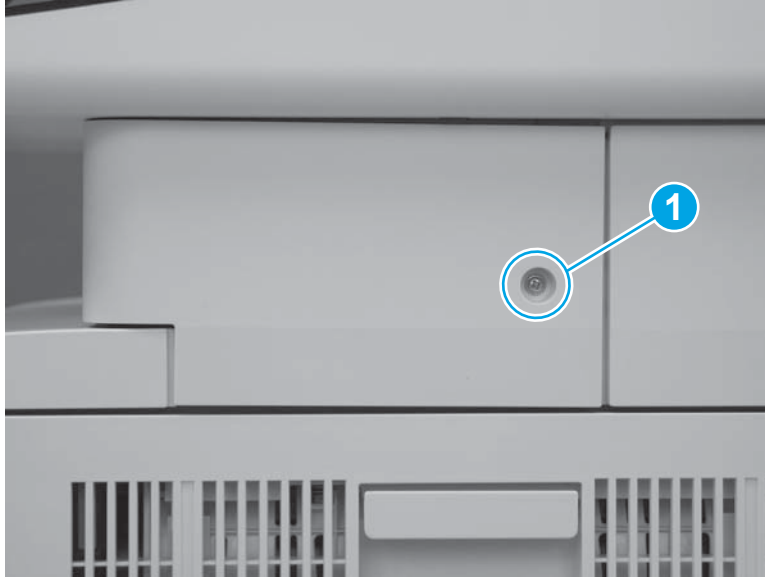

2. Release two tabs at the front edge of the cover (callout 1).

Figure 1-366 Release two tabs



3. Rotate the front of the cover to the right to remove it.

Figure 1-367 Rotate the cover



Step 5: Remove the stapler cover assembly (M577c/f/z)



NOTE: This step is for the M577c/f/z models. For the M577dn model, skip this step and to go [Step 7: Remove the right upper cover \(M577\) on page 241](#).

1. Remove one screw (callout 1).



Reinstallation tip: This is a self-tapping screw for plastic. When reinstalling, rotate the screw counterclockwise to align it with the existing thread pattern, and then carefully turn it clockwise to tighten. Do not overtighten. This will prevent stripping the threads inside the screw hole.

Figure 1-368 Remove one screw

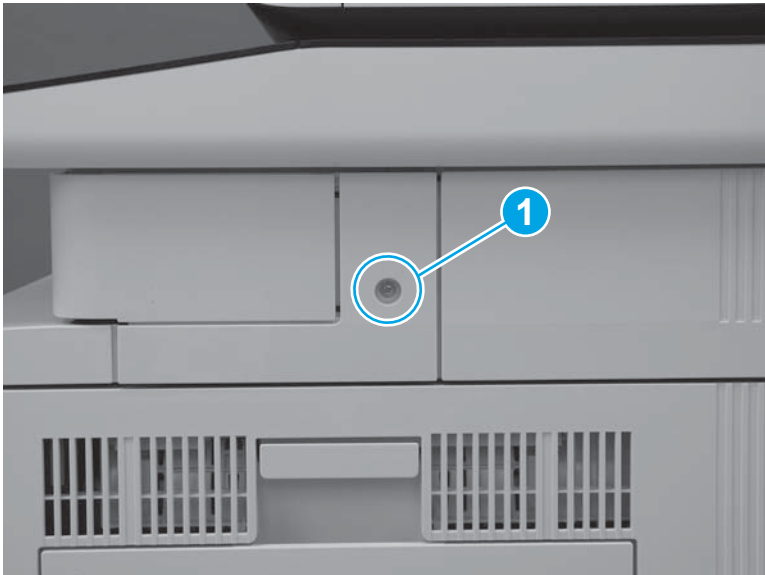

2. Release two tabs at the front edge of the cover (callout 1).

Figure 1-369 Release two tabs



3. Release the back edge of the cover.

Figure 1-370 Release the back edge of the cover

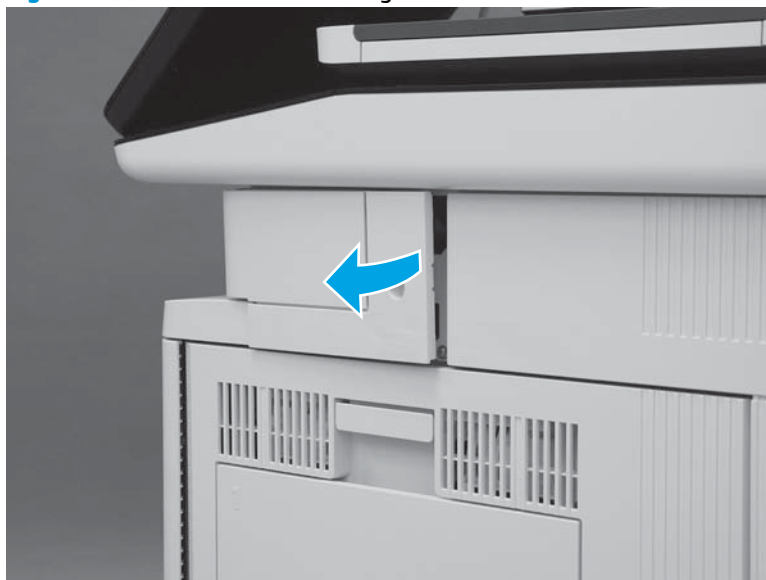

4. Rotate the cover away from the printer to remove it.

Figure 1-371 Remove the cover



Step 6: Remove the integrated scanner assembly (ISA) (M577)

 **NOTE:** The ISA includes the document feeder, image scanner, scanner control board (SCB), control panel, keyboard (M577c/z) and NFC PCA (M577z).

1. At the left side of the printer, remove one screw (callout 1).

Figure 1-372 Remove one screw

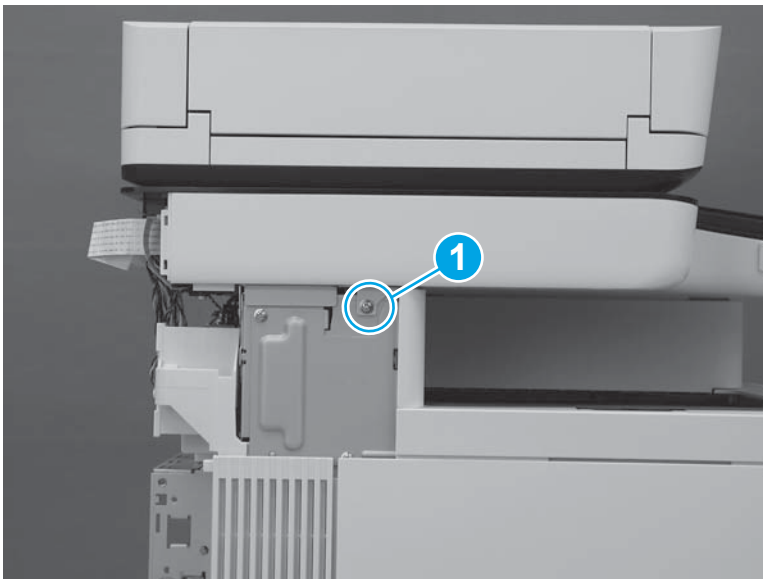

2. At the back side of the printer, remove two screws (callout 1).

Figure 1-373 Remove two screws

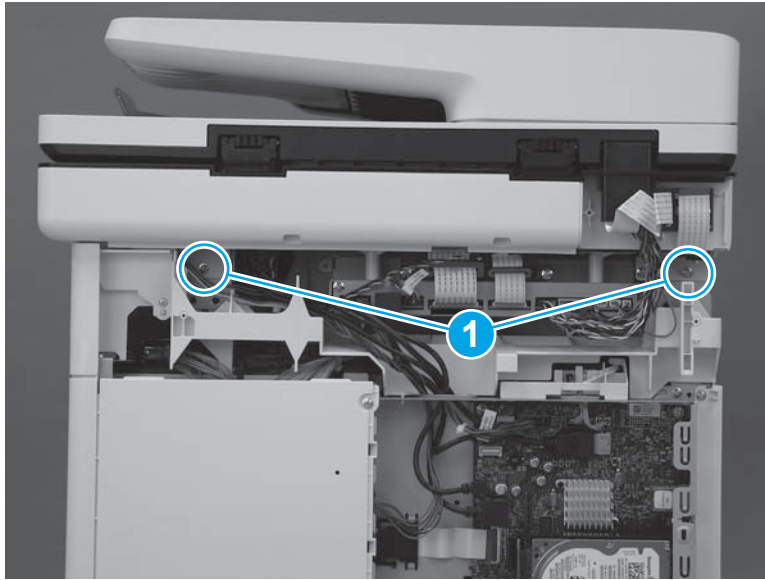

3. At the right side of the printer, remove one screw (callout 1).

Figure 1-374 Remove one screw

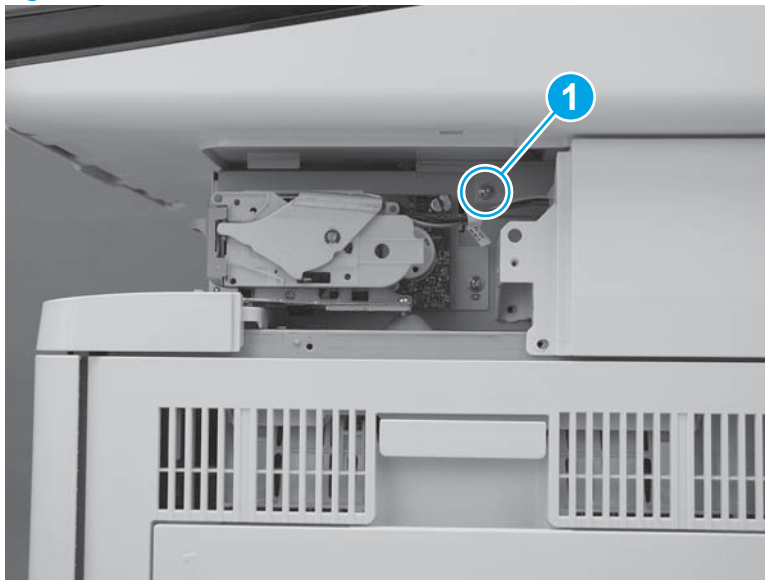

4. Disconnect four connectors on the formatter (callout 1), and then pass the wire harness and cables through the opening in the formatter case (callout 2).

Figure 1-375 Disconnect four connectors

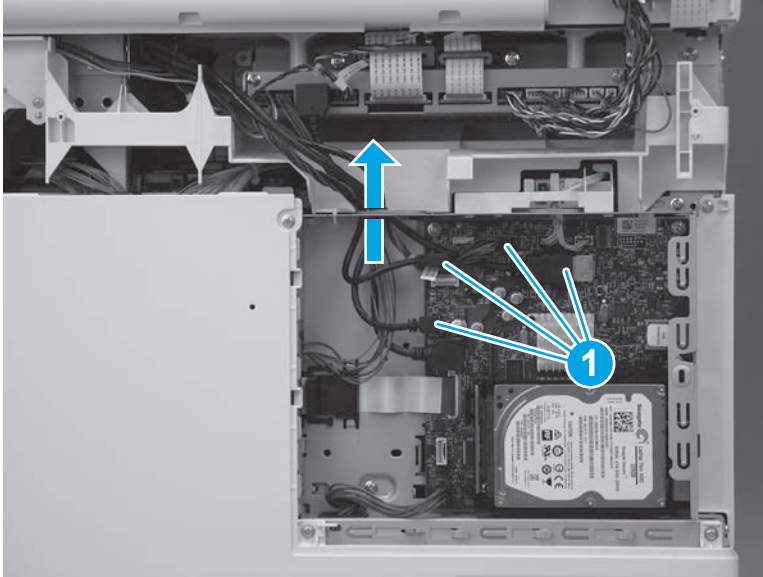

5. Disconnect two connectors on the scanner control board (callout 1).

M577c/f/z only: Disconnect one connector for the stapler on the scanner control board (callout 2).

Figure 1-376 Disconnect connectors

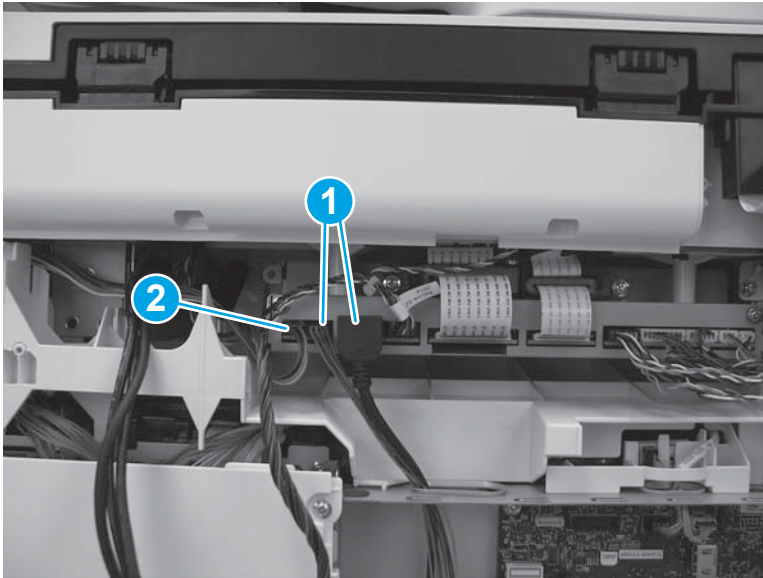

6. Slightly slide the ISA towards the back of the printer to release it.

Figure 1-377 Slide the ISA towards the back of the printer

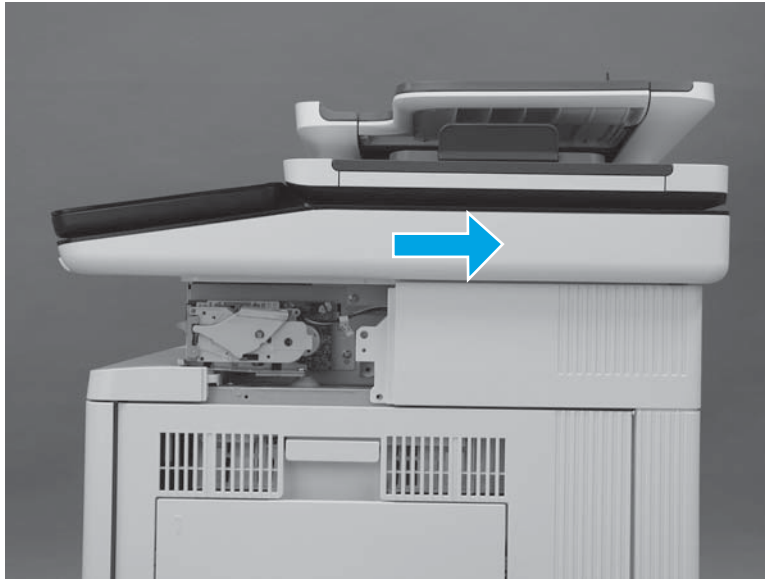

7. Lift the ISA up to remove it.

Figure 1-378 Remove the ISA

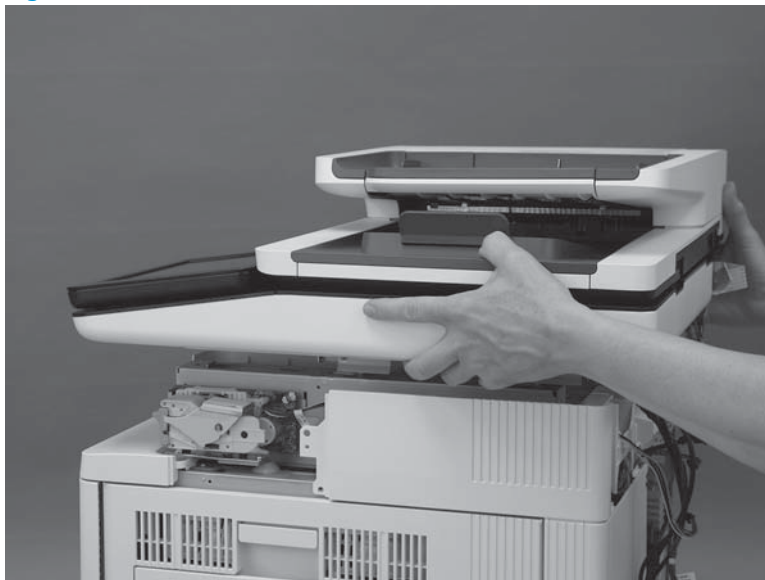

Step 7: Remove the right upper cover (M577)

 **NOTE:** The figures below show the image scanner installed. The procedures for removing and installing the right upper cover are the same whether the image scanner is installed or removed."

1. At the right side of the printer, remove two screws (callout 1).

M577c/f/z only: Disconnect one connector (callout 2), if it was not already disconnected in a previous step.

Figure 1-379 Remove two screws and one connector

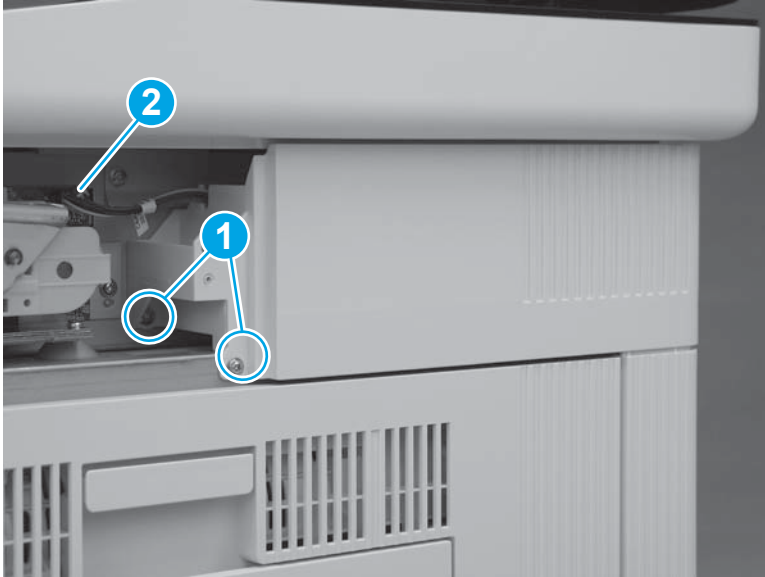

2. At the back of the printer, remove one screw (callout 1).

M577c/f/z only: Disconnect one connector (callout 2), if it was not already disconnected in a previous step.

 **Reinstallation tip:** This screw is smaller than the screws removed in the previous step. When reinstalling the right upper cover, make sure that this screw is installed in the correct position.

Figure 1-380 Remove one screw and connector



3. Slide the cover toward the back of the printer.

Figure 1-381 Slide the cover

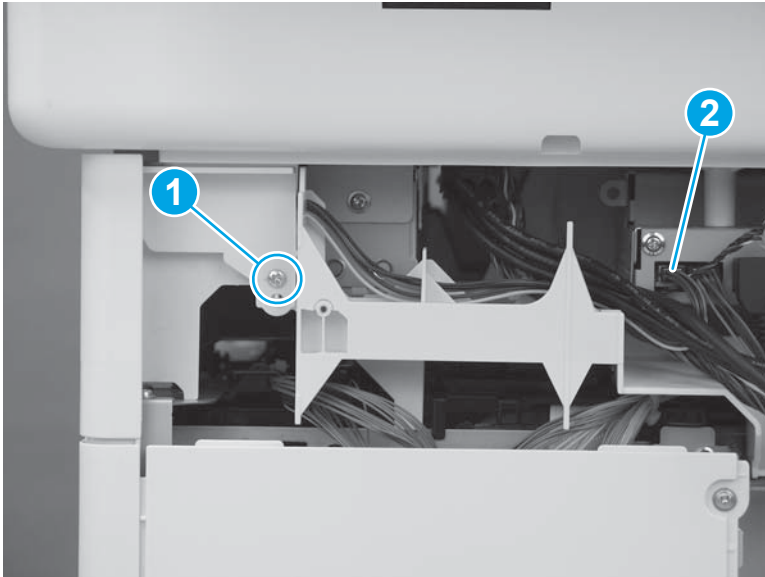
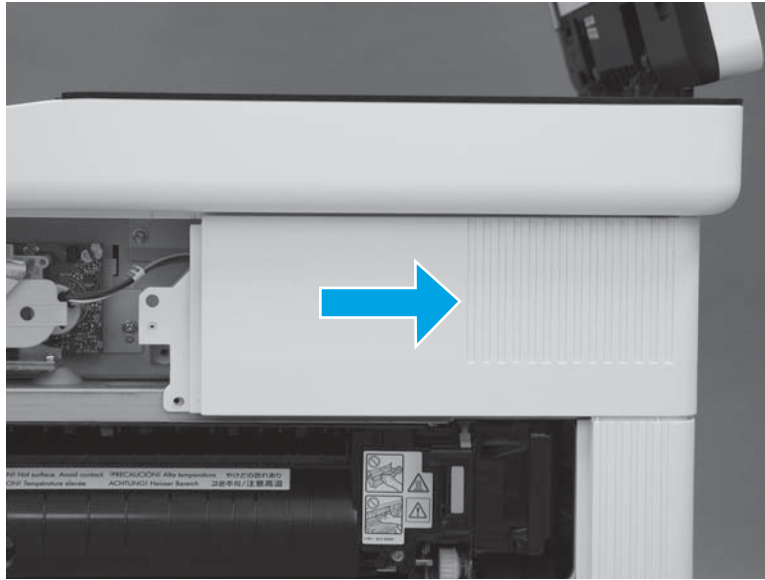

4. Lift the cover away from the printer to remove it.

M577c/f/z only: Release the cables (callout 1) through the slot (callout 2) in the printer.

Figure 1-382 Remove the cover

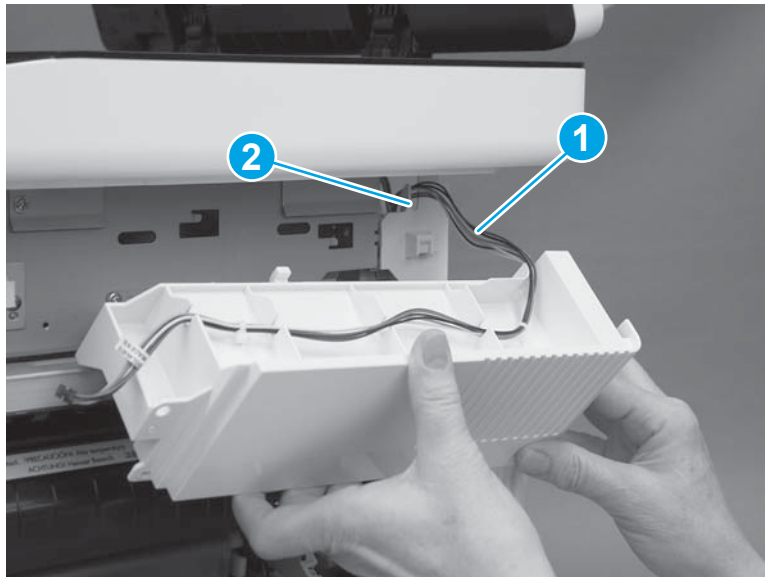

Step 8: Remove the top rear cover

1. At the top of the printer, remove five screws (callout 1).

Figure 1-383 Remove five screws

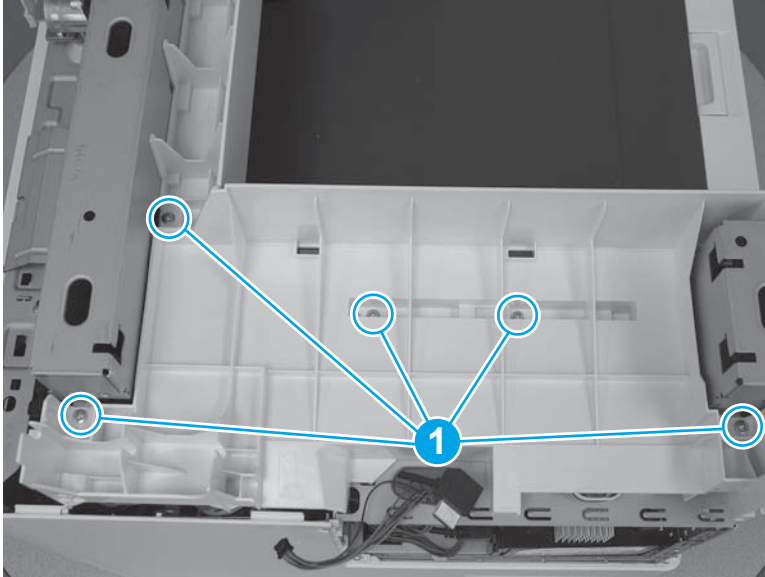

2. Release two tabs (callout 1) on the front edge of the cover.

Figure 1-384 Release two tabs

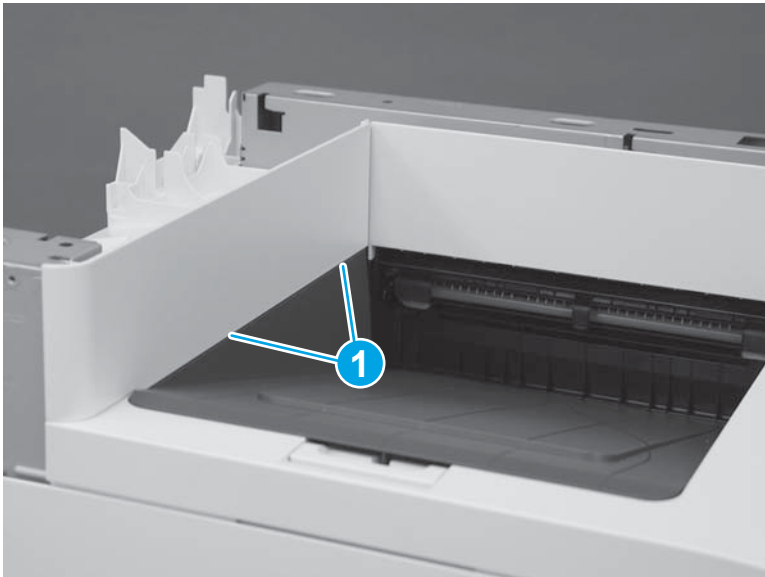

3. Remove the top rear cover.

Figure 1-385 Remove the top rear cover

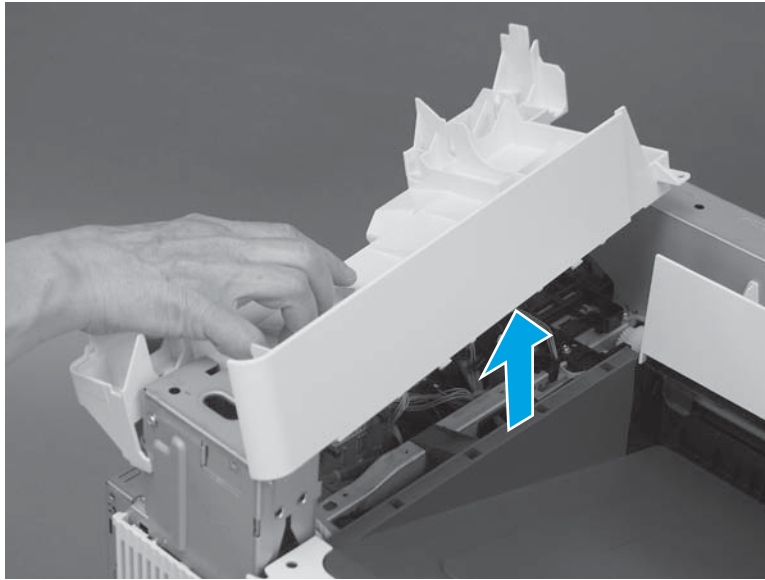

Step 9: Unpack the replacement assembly

Unpack the replacement assembly from the packaging.

For complete information on HP's recycling programs, go to [Product return and recycling](#).

 **NOTE:** HP recommends responsible disposal of the defective assembly.

Figure 1-386 Recycle and unpack

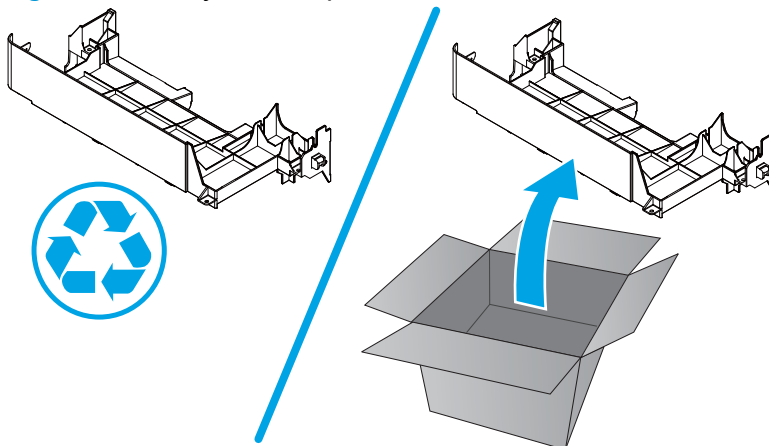

Step 10: Install the top rear cover

1. Align the locator tabs (callout 1) on the cover with the slots (callout 2) in the printer.

Figure 1-387 Align the locator tabs

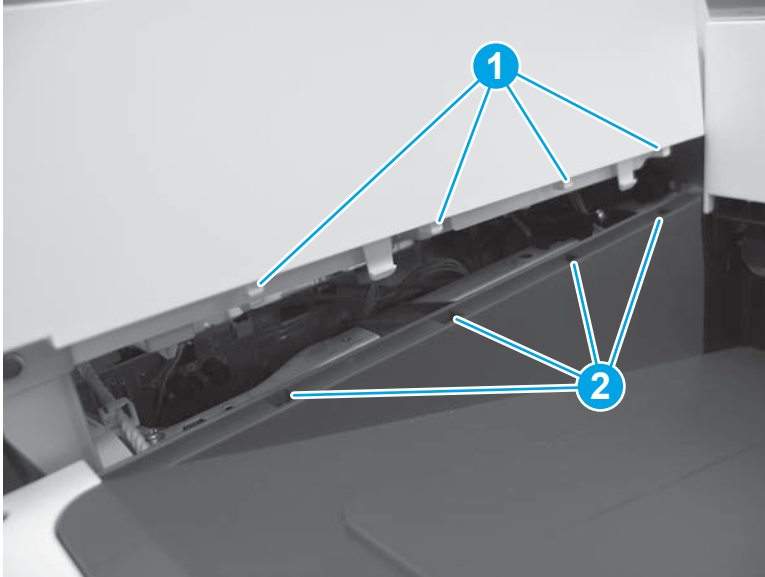

2. Press down to install the cover. Make sure that the tabs snap into place.

Figure 1-388 Install the cover

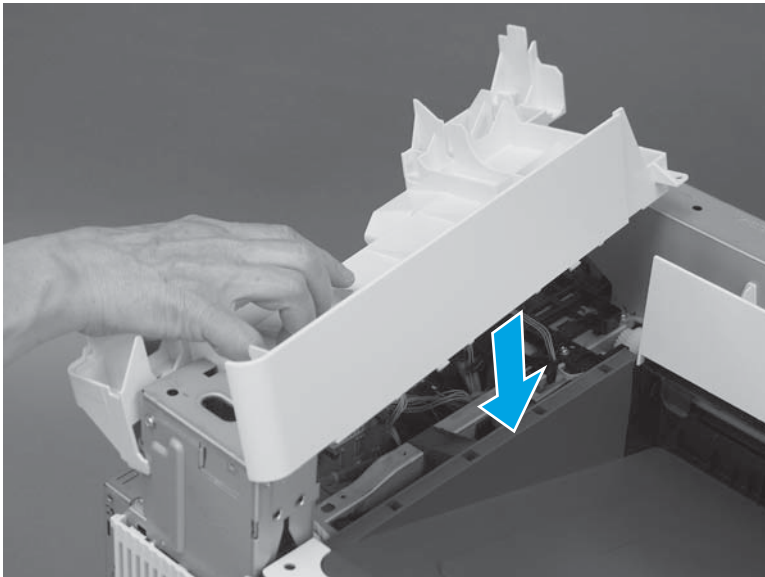

3. At the top of the printer, install five screws (callout 1).

Figure 1-389 Install five screws

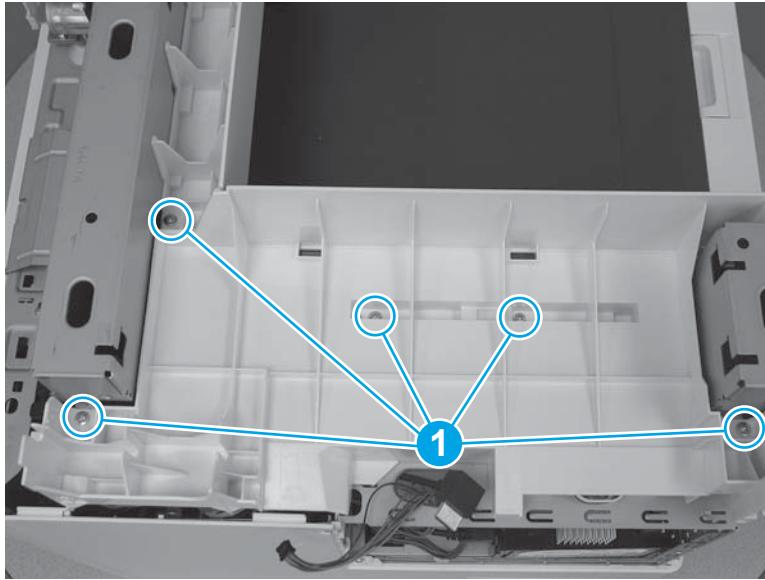

Step 11: Install the right upper cover (M577)

 **NOTE:** The figures below show the image scanner installed. The procedures for removing and installing the right upper cover are the same whether the image scanner is installed or removed."

1. **M577c/f/z only:** Install the cables (callout 1) through the slot (callout 2) in the printer.

Figure 1-390 Install the cables

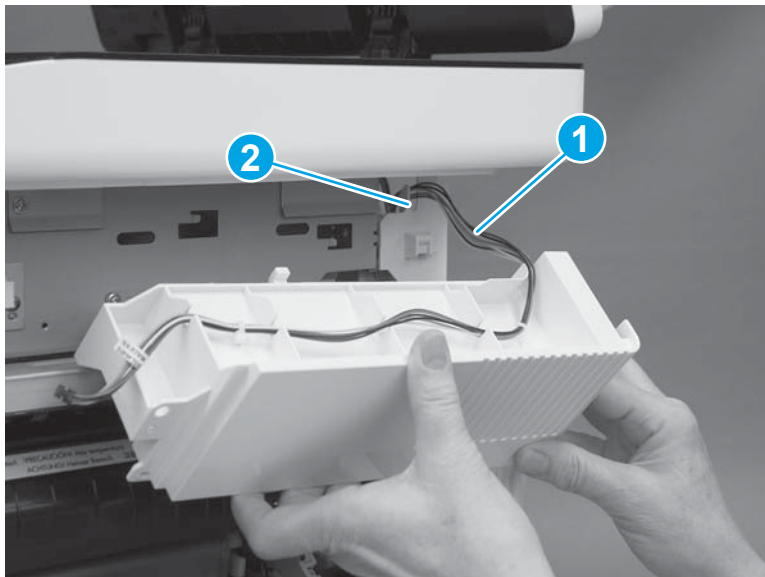

2. Position the hooks (callout 1) on the cover in the slots (callout 2) in the printer.

Figure 1-391 Position the hooks

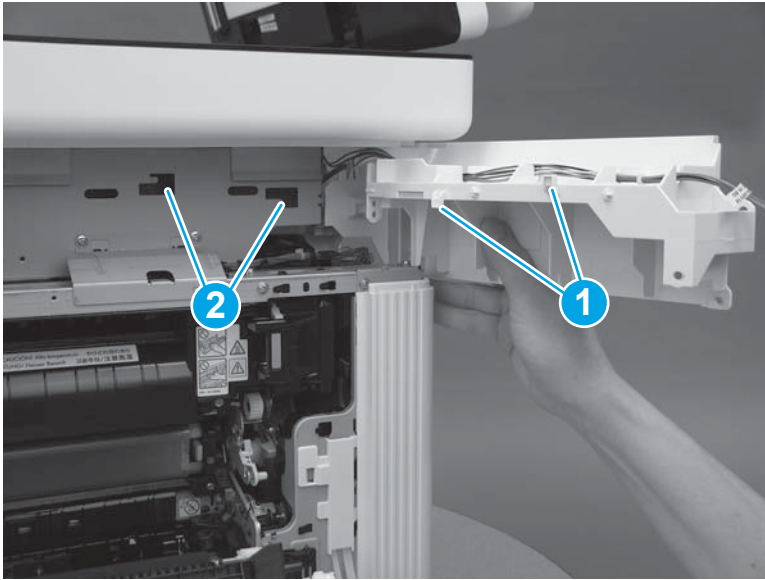

3. Slide the cover toward the front of the printer to install it.

Figure 1-392 Install the cover

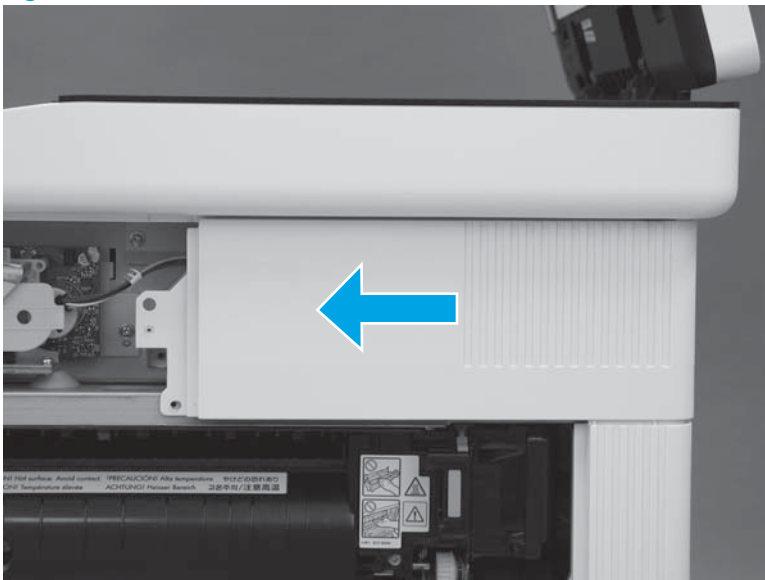

4. At the back of the printer, install one screw (callout 1).

M577c/f/z only: Connect one connector (callout 2), if the integrated scanner assembly is installed.

 **TIP:** This screw is smaller than the screws installed in the next step. Make sure that this screw is installed in the correct position.

Figure 1-393 Install one screw and connector



5. At the right side of the printer, install two screws (callout 1).

M577c/f/z only: Connect one connector (callout 2), if the stapler is installed.

Figure 1-394 Install one screw and connector

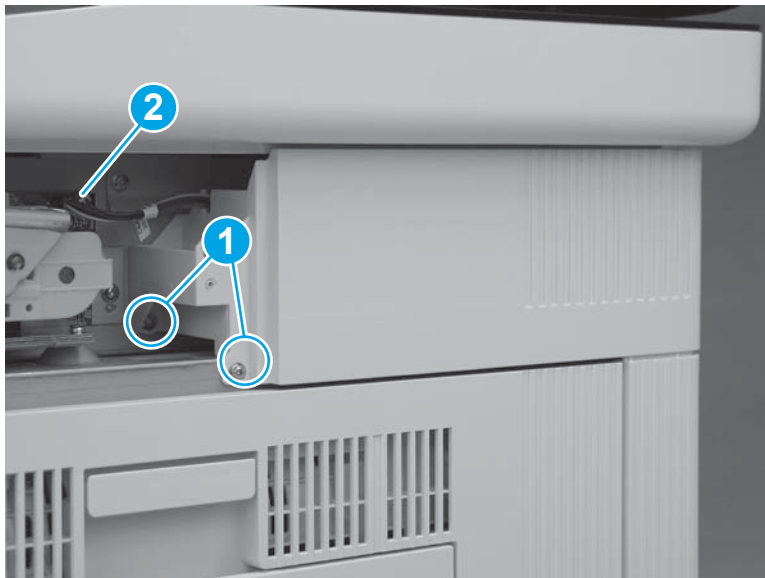

Step 12: Install the integrated scanner assembly (ISA) (M577)

 **NOTE:** The ISA includes the document feeder, image scanner, scanner control board (SCB), control panel, keyboard (M577c/z) and NFC PCA (M577z).

1. Before proceeding, locate the mounting pins (callout 1) on the bottom of the ISA and the slots (callout 2) on the printer base.

Figure 1-395 Locate the ISA mounting pins and slots

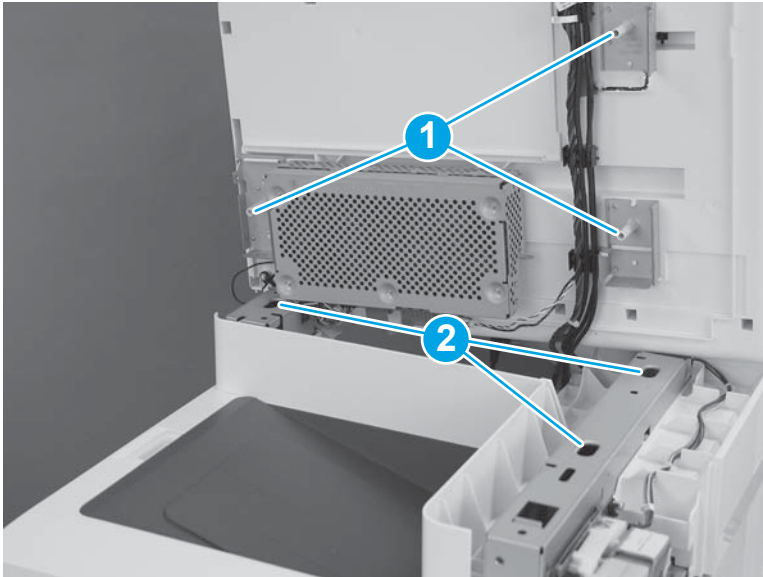

2. Position the ISA on the printer base with the pins in the slots.

 **NOTE:** To locate the pins and slots, see [Figure 1-395 Locate the ISA mounting pins and slots on page 250](#).

Figure 1-396 Install the ISA



3. Slightly slide the ISA towards the front of the printer to engage it.

Figure 1-397 Slide the ISA towards the front of the printer

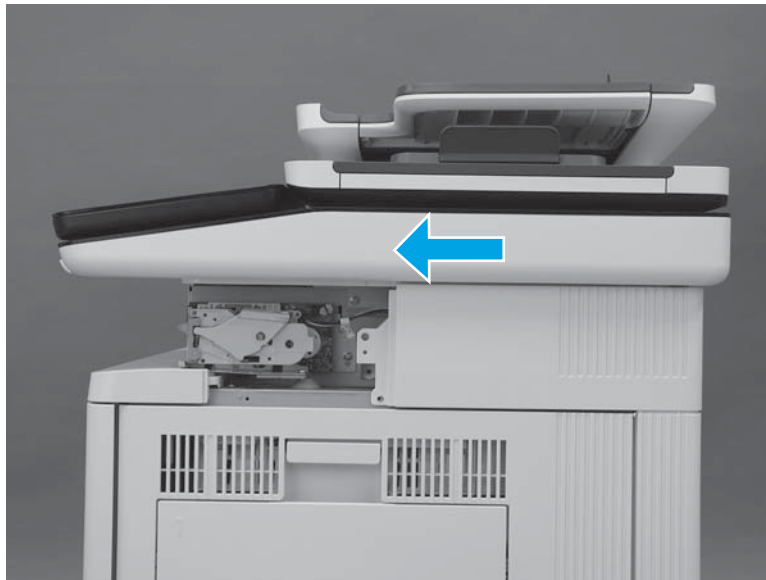

4. At the left side of the printer, install one screw (callout 1).

Figure 1-398 Install one screw

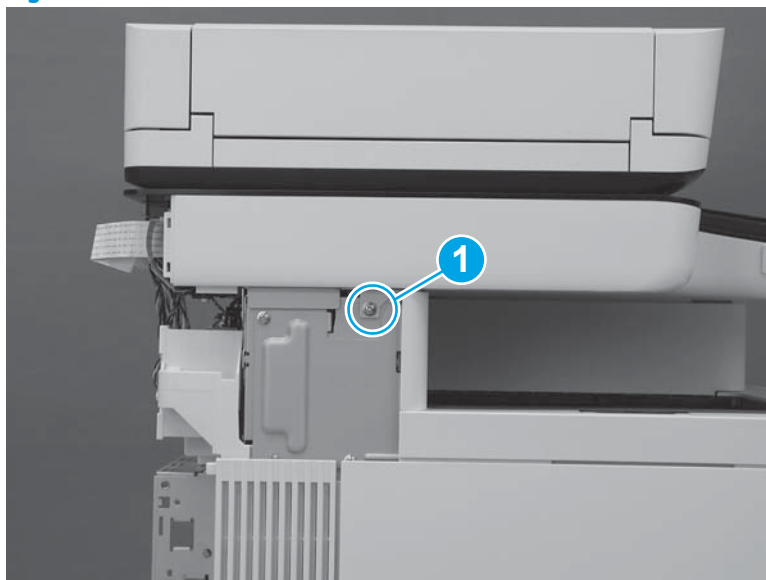

5. At the back of the printer, install two screws (callout 1).

Figure 1-399 Install two screws

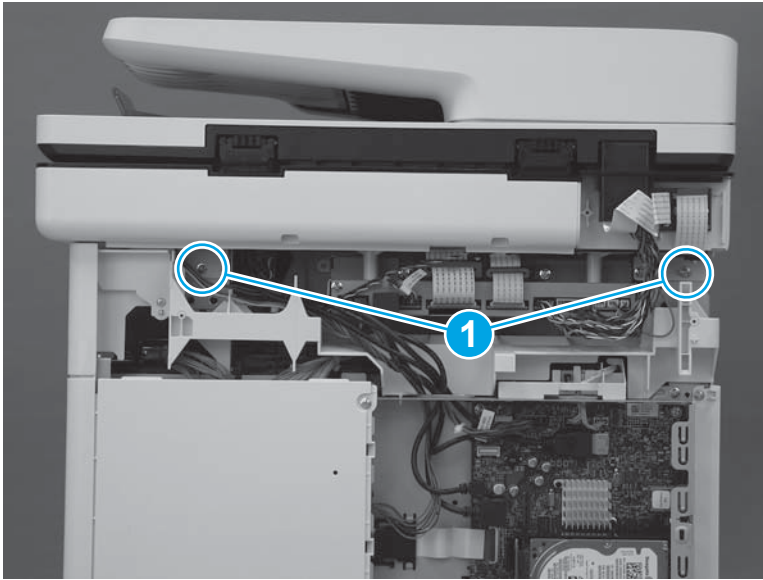

6. At the right side of the printer, install one screw (callout 1).

Figure 1-400 Install one screw

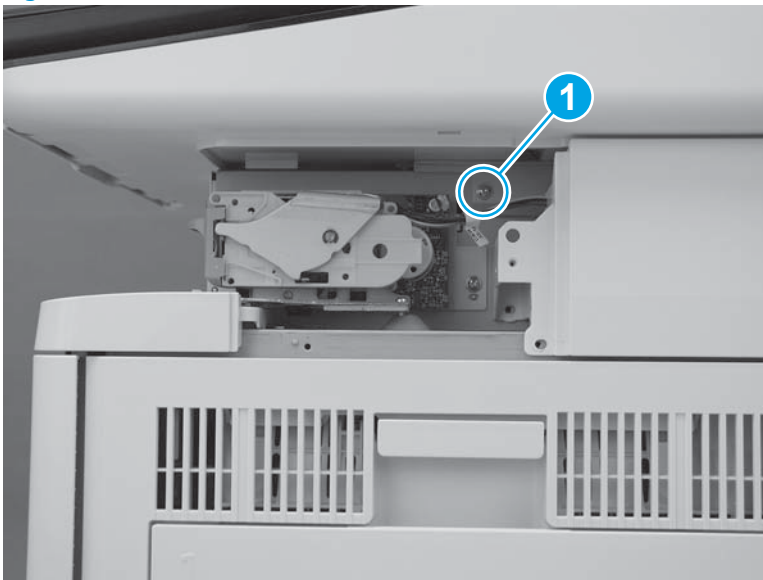

7. Connect two connectors on the scanner control board (callout 1).

M577c/f/z only: Connect one connector for the stapler on the scanner control board (callout 2).

Figure 1-401 Connect connectors

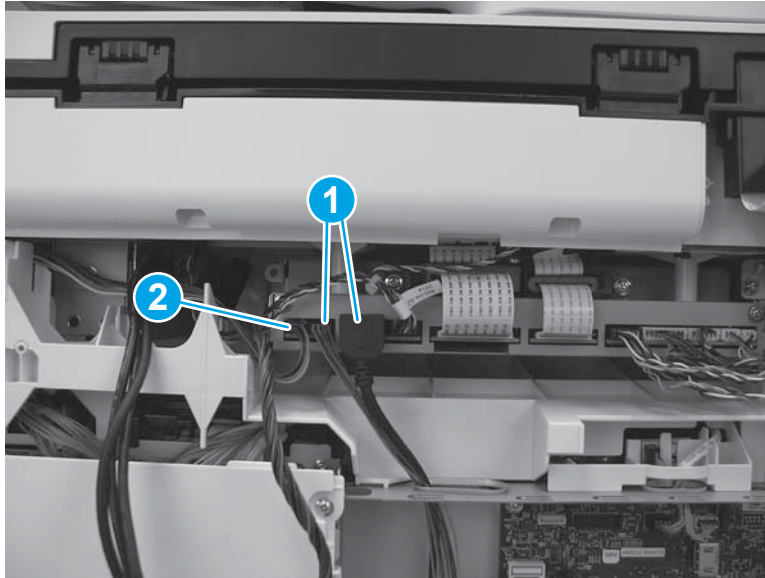

8. Install the wire harness and cables (callout 1) in the retainers (callout 2). Pass them through the opening in the top of the formatter cover (callout 3), and then connect four connectors (callout 4) on the formatter.

Figure 1-402 Connect four connectors

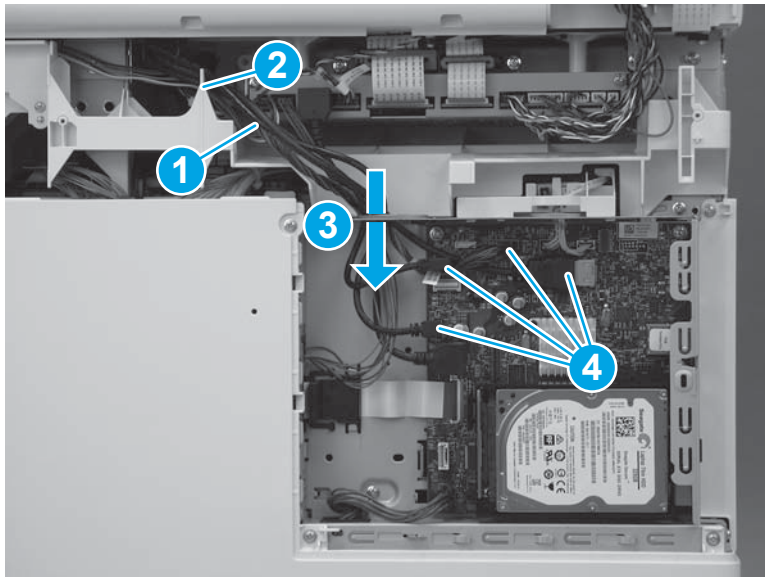

Step 13: Install the stapler cover assembly (M577c/f/z)

 **NOTE:** This step is for the M577c/f/z models only. For the M577dn model, skip this step and go to [Step 14: Install the right front upper cover \(M577dn\) on page 255.](#)

1. Install the tabs (callout 1) on the cover in the slots (callout 2) in the printer.

Figure 1-403 Install two tabs



2. Press the cover toward the left side of the printer until it snaps into place.

Figure 1-404 Install the cover assembly



3. Install one screw (callout 1).



 **IMPORTANT:** This is a self-tapping screw for plastic. Rotate it counterclockwise to align it with the existing thread pattern, and then carefully turn it clockwise to tighten. Do not overtighten. This will prevent stripping the threads inside the screw hole.

Figure 1-405 Install one screw

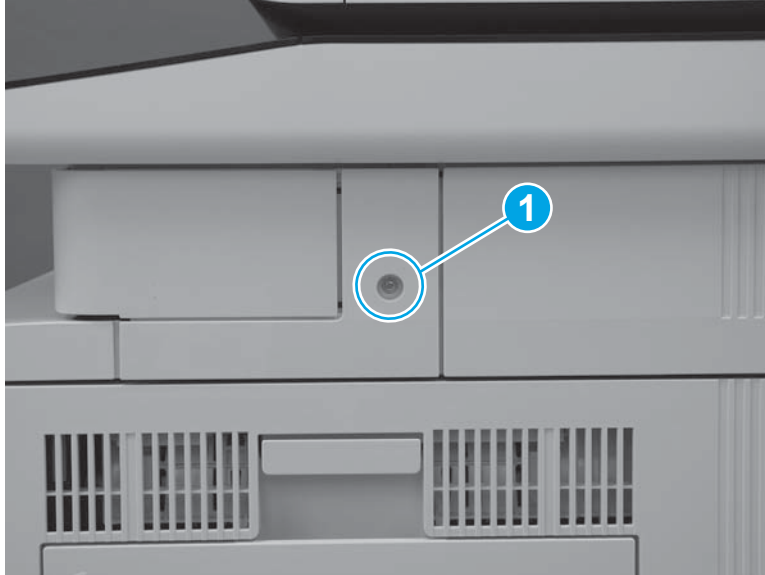

Step 14: Install the right front upper cover (M577dn)

 **NOTE:** This step is for the M577dn model only. For the M577c/f/z models, skip this step and go to [Step 15: Install the left upper cover on page 256](#).

1. Slide the cover toward the left side of the printer to install it. Make sure that the slots (callout 1) in the cover fit over the tabs (callout 2) on the inside of the paper feeder cover.

Figure 1-406 Install the cover

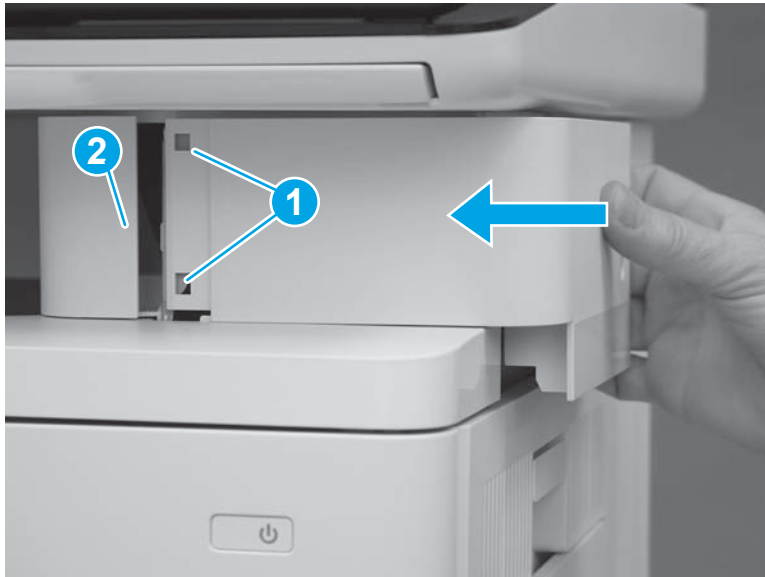

2. Press the right front upper cover (callout 1) and the paper feeder cover (callout 2) together until the tabs on the inside of the covers snap into place.

Figure 1-407 Press the cover



3. Install one screw (callout 1).

Figure 1-408 Install one screw

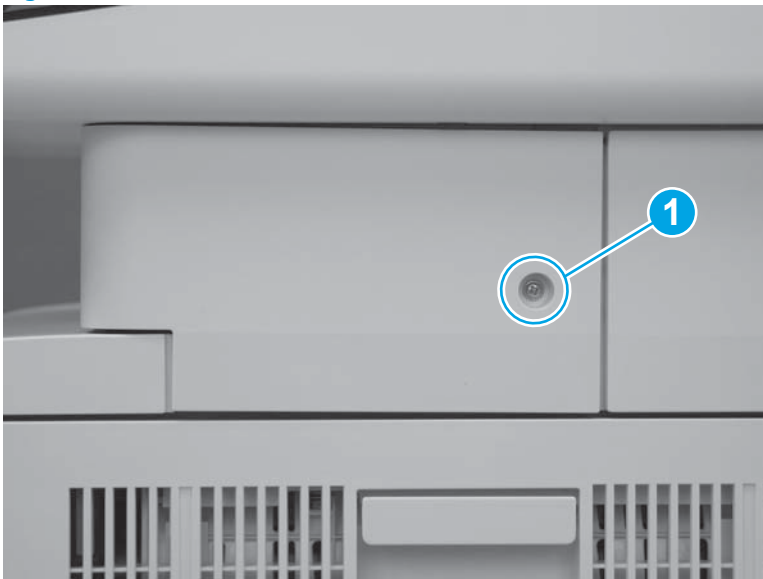

Step 15: Install the left upper cover

1. Position the tab (callout 1) on the lower edge of the cover behind the left cover (callout 2).

Figure 1-409 Position the tab

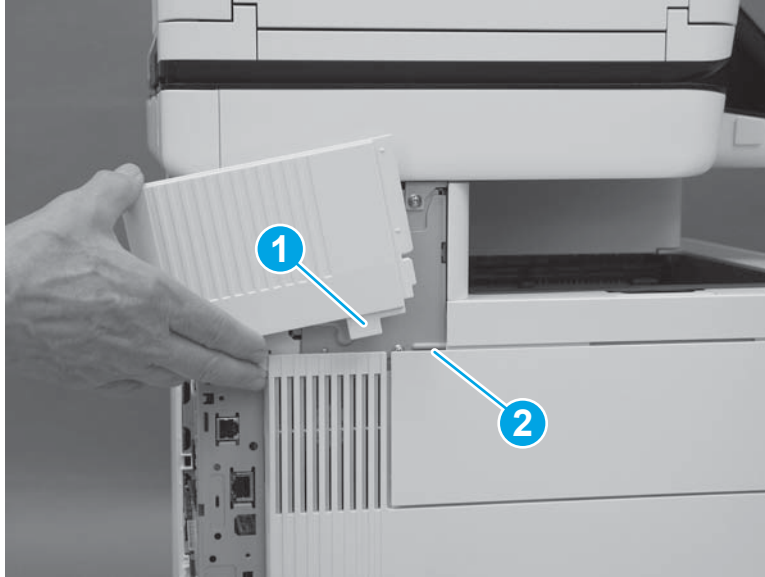

2. Slide the cover toward the front of the printer to install it. Make sure that the edge (callout 1) of the cover fits behind the edge (callout 2) of the top rear cover.

Figure 1-410 Slide the cover

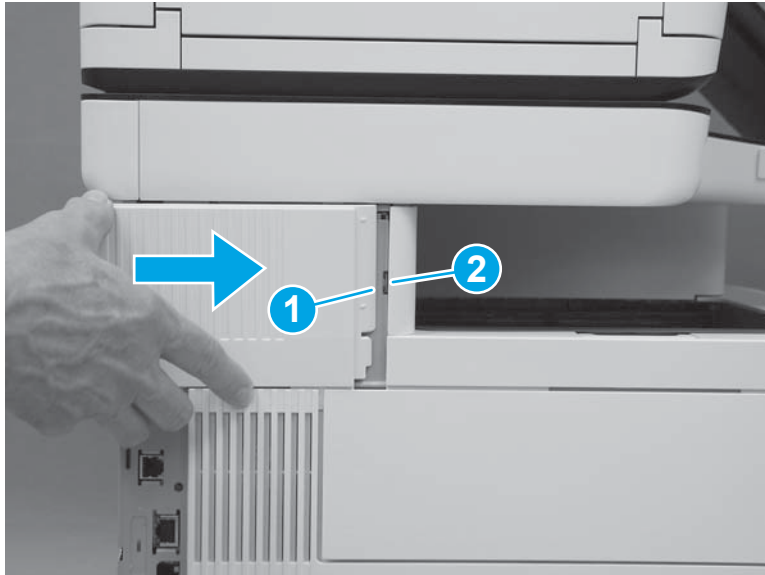

3. Make sure that the tab (callout 1) is fully installed.

Figure 1-411 Check the tab

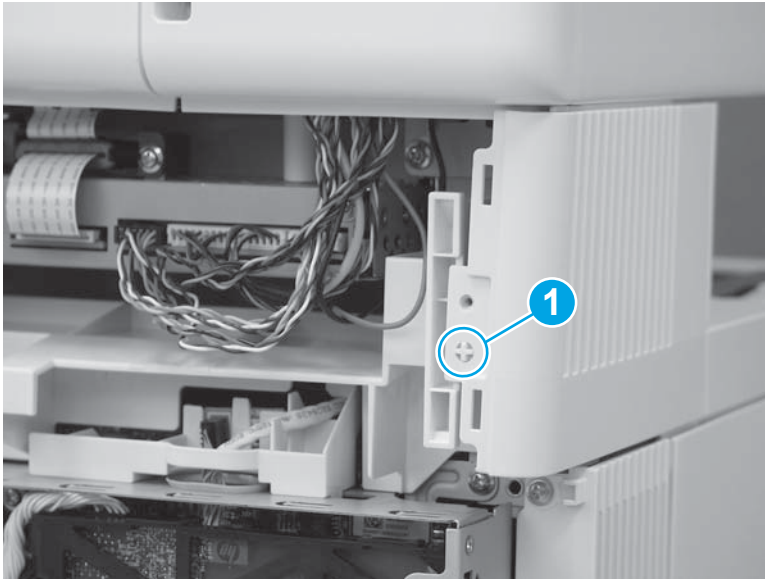

Step 16: Install the rear upper cover

1. Align the ridge (callout 1) on the lower edge of the rear upper cover in front of the tabs (callout 2) on the top edge of the rear cover.

Figure 1-412 Align the cover

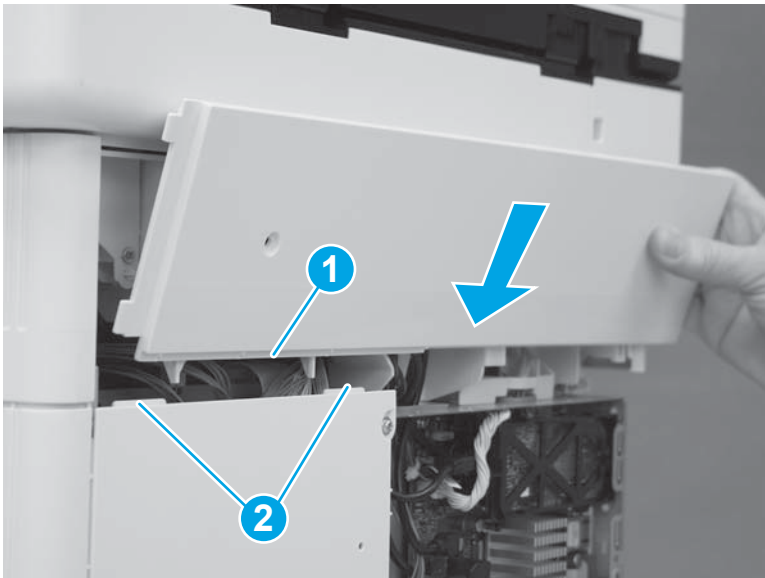

2. Rotate the top of the cover toward the printer.

Figure 1-413 Rotate the top of the cover

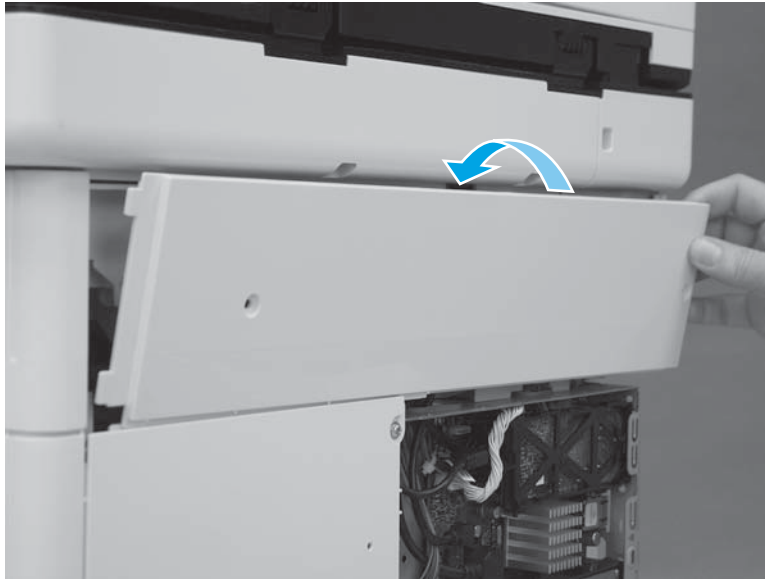

3. Slide the cover to the left (callout 1). Make sure that the tabs (callout 2) on the upper rear cover slide behind the edge (callout 3) of the right upper cover. Make sure that the cover is fully seated.

Figure 1-414 Slide the cover

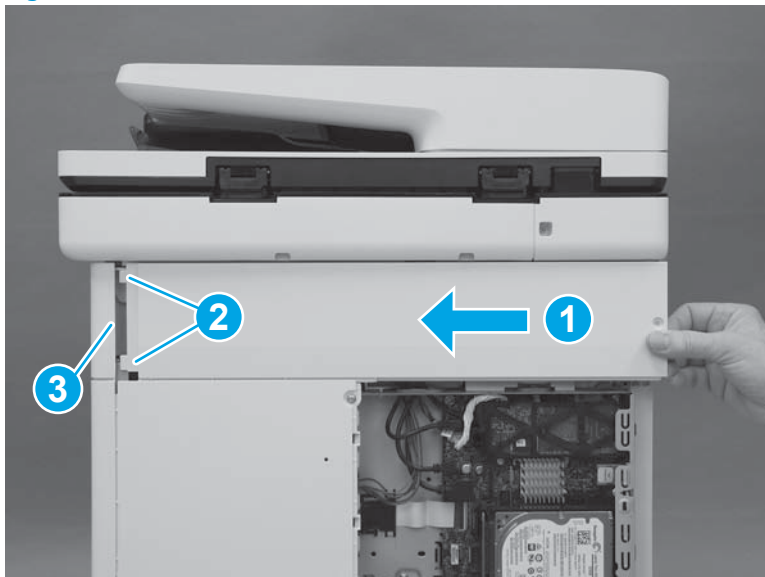

4. Install two screws (callout 1).



 **IMPORTANT:** These two screws are self-tapping screws for plastic. Rotate them counterclockwise to align them with the existing thread pattern, and then carefully turn them clockwise to tighten. Do not overtighten. This will prevent stripping the threads inside the screw holes.

Figure 1-415 Install two screws

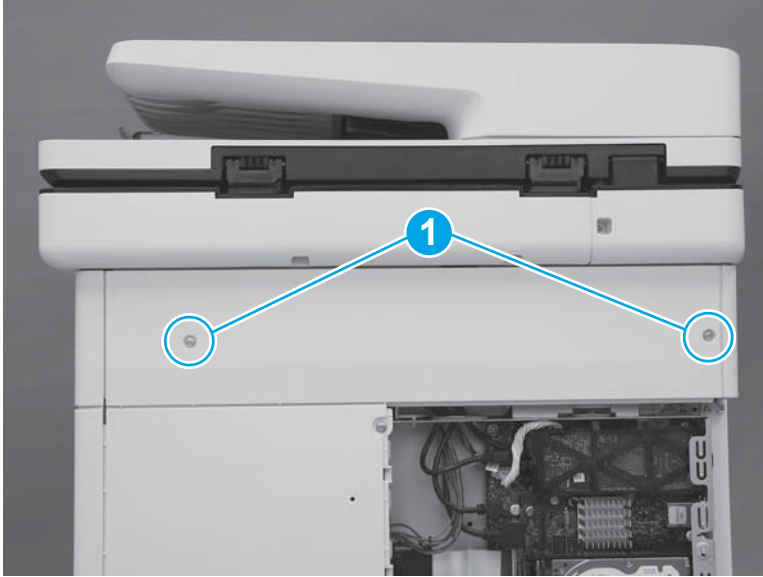

Step 17: Install the formatter cover

- ▲ Slide the cover onto the printer (callout 1) to install it.

 **NOTE:** Make sure that the tabs on the formatter cover align with the slots provided in the printer (callout 2). Tighten the two thumbscrews (callout 3).

 **TIP:** If needed, use the edge of a coin to turn the thumbscrews.

Figure 1-416 Install the cover



Removal and replacement: Paper feed cover (M577)

- [Introduction](#)
- [Step 1: Remove the formatter cover](#)
- [Step 2: Remove the rear upper cover](#)
- [Step 3: Remove the left upper cover](#)
- [Step 4: Remove the right front upper cover \(M577dn\)](#)
- [Step 5: Remove the stapler cover assembly \(M577c/f/z\)](#)
- [Step 6: Remove the integrated scanner assembly \(ISA\) \(M577\)](#)
- [Step 7: Remove the right upper cover \(M577\)](#)
- [Step 8: Remove the top rear cover](#)
- [Step 9: Remove the paper feed cover](#)
- [Step 10: Unpack the replacement assembly](#)
- [Step 11: Install the paper feed cover](#)
- [Step 12: Install the top rear cover](#)
- [Step 13: Install the right upper cover \(M577\)](#)
- [Step 14: Install the integrated scanner assembly \(ISA\) \(M577\)](#)
- [Step 15: Install the stapler cover assembly \(M577c/f/z\)](#)
- [Step 16: Install the right front upper cover \(M577dn\)](#)
- [Step 17: Install the left upper cover](#)
- [Step 18: Install the rear upper cover](#)
- [Step 19: Install the formatter cover](#)

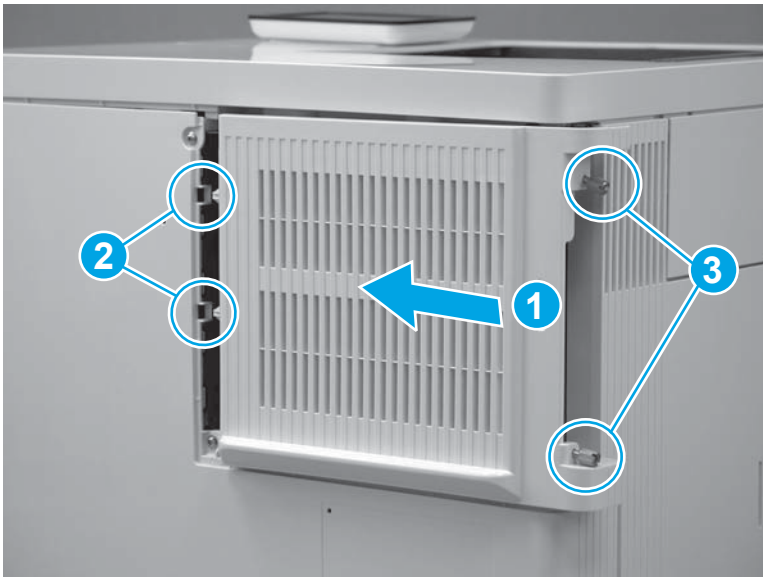
Introduction

This document provides the procedures to remove and replace the M577 paper feed cover.

Before performing service

Turn the printer power off

- Disconnect the power cable.

⚠ WARNING! To avoid damage to the printer, turn the printer off, wait 30 seconds, and then remove the power cord before attempting to service the printer.

Use the table below to identify the correct part number for your printer. To order the part, go to www.hp.com/buy/parts.

Paper feed cover (M577) part number

RC4-3382-000CNPaper feed cover (M577)

Required tools

- Small flat blade screwdriver
- #2 Phillips screwdriver with a magnetic tip

After performing service

Make sure that the paper feed cover is fully seated after replacing it.

Turn the printer power on

- Connect the power cable.
- Use the power switch to turn the power on.

Step 1: Remove the formatter cover

1. Locate the formatter cover.

Figure 1-417 Locate the formatter cover

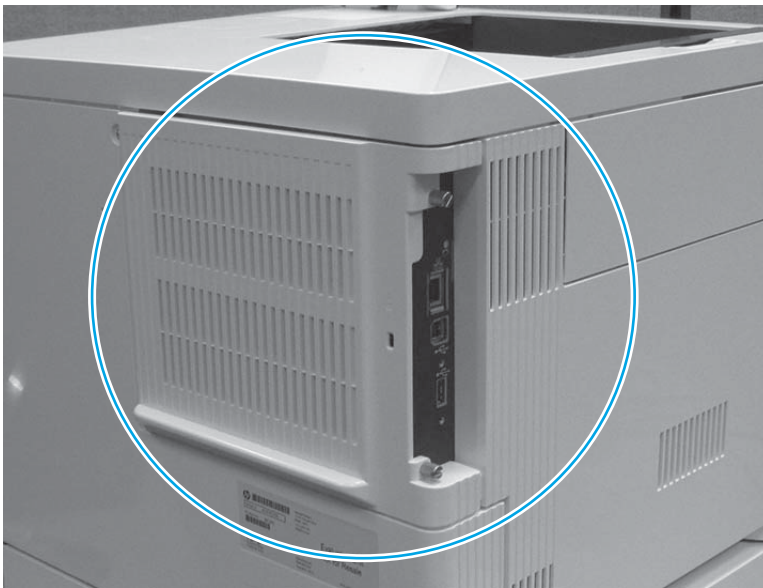

2. Loosen the two thumbscrews (callout 1). Grasp the two thumbscrews, and then slide the cover away from the printer (callout 2) to remove it.

 **TIP:** If needed, use the edge of a coin to turn the thumbscrews.

Figure 1-418 Loosen the thumbscrews



Step 2: Remove the rear upper cover

1. Remove two screws (callout 1).

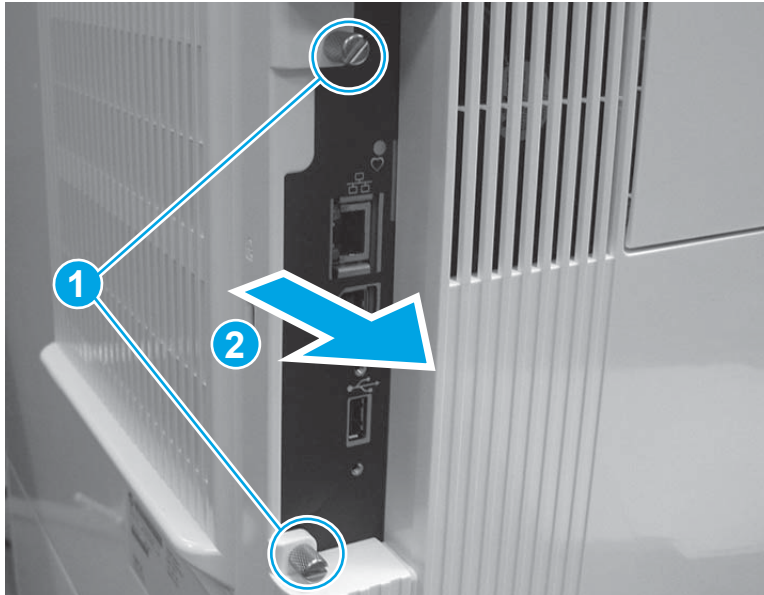
 **Reinstallation tip:** These two screws are self-tapping screws for plastic. When reinstalling them, rotate the screws counterclockwise to align them with the existing thread pattern, and then carefully turn them clockwise to tighten. Do not overtighten. This will prevent stripping the threads inside the screw holes.

Figure 1-419 Remove two screws



2. Use a small, flat blade screwdriver to release the right edge of the cover.

Figure 1-420 Release the right edge

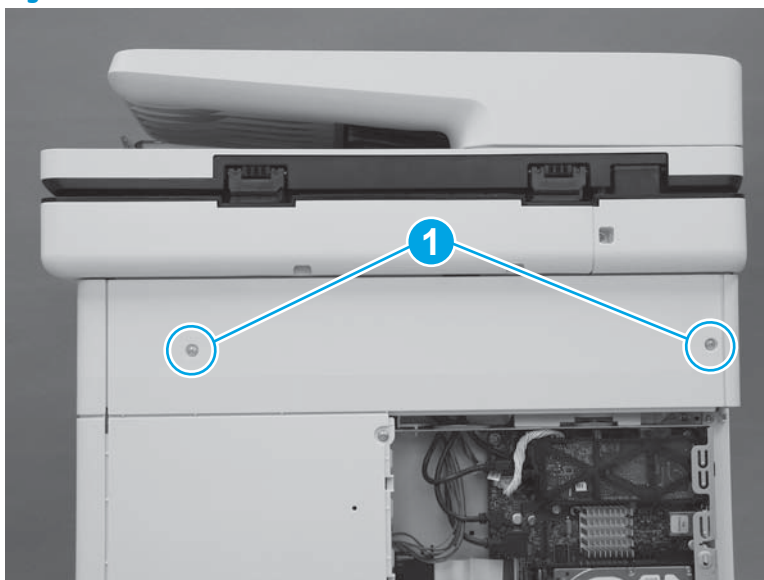
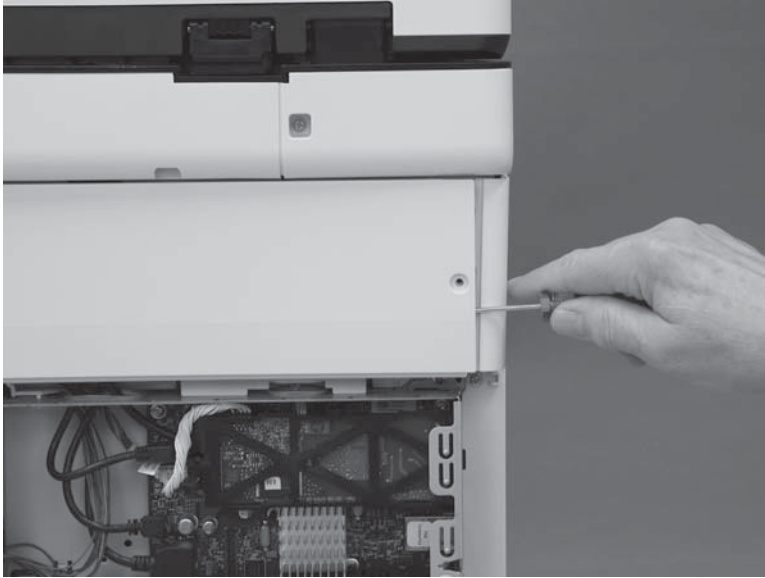

3. Pull the right edge of the cover (callout 1) away from the printer, and then slide the cover to the right (callout 2).

Figure 1-421 Slide the cover right

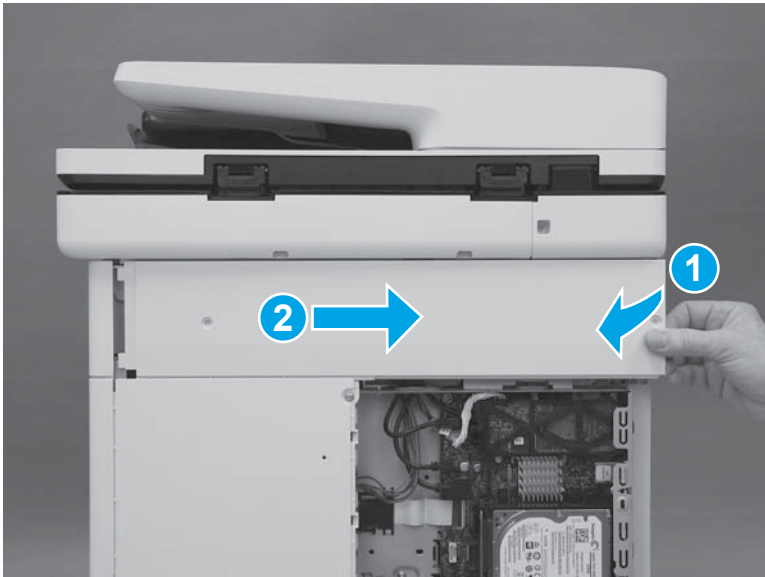

4. Remove the cover.

Figure 1-422 Remove the cover



Step 3: Remove the left upper cover

1. At the left side of the printer, release one tab (callout 1).

Figure 1-423 Release one tab

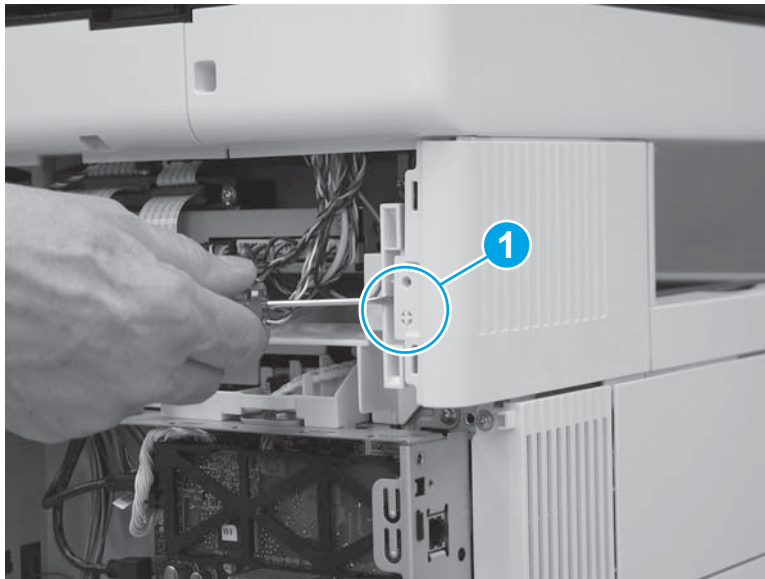

2. Slide the left upper cover toward the back of the printer.

Figure 1-424 Slide the cover back

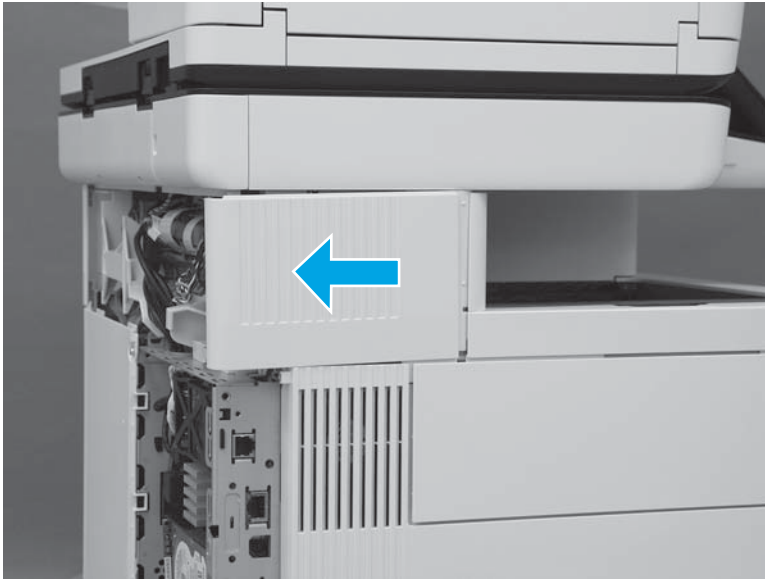

3. Rotate the cover up to remove it.

Figure 1-425 Remove the left upper cover

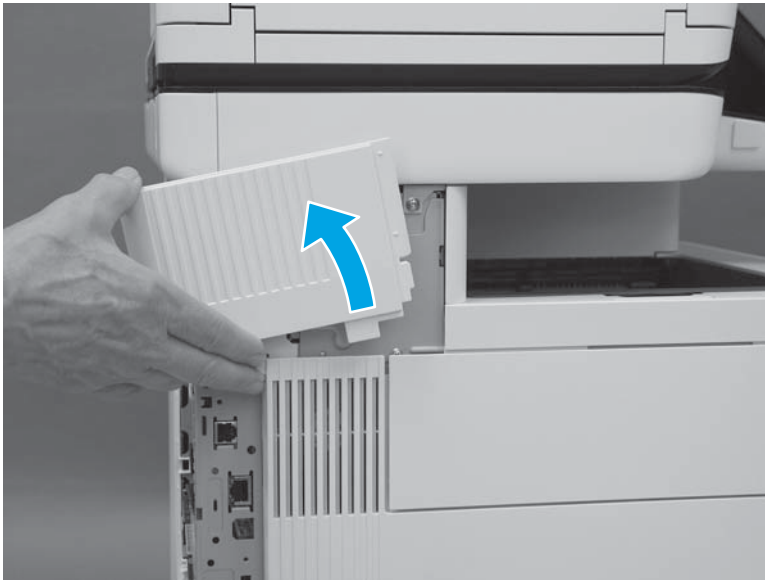

Step 4: Remove the right front upper cover (M577dn)

 **NOTE:** This step is for the M577dn model. For the M577c/f/z models, skip this step and to go [Step 5: Remove the stapler cover assembly \(M577c/f/z\) on page 268.](#)

1. Remove one screw (callout 1).

Figure 1-426 Remove one screw

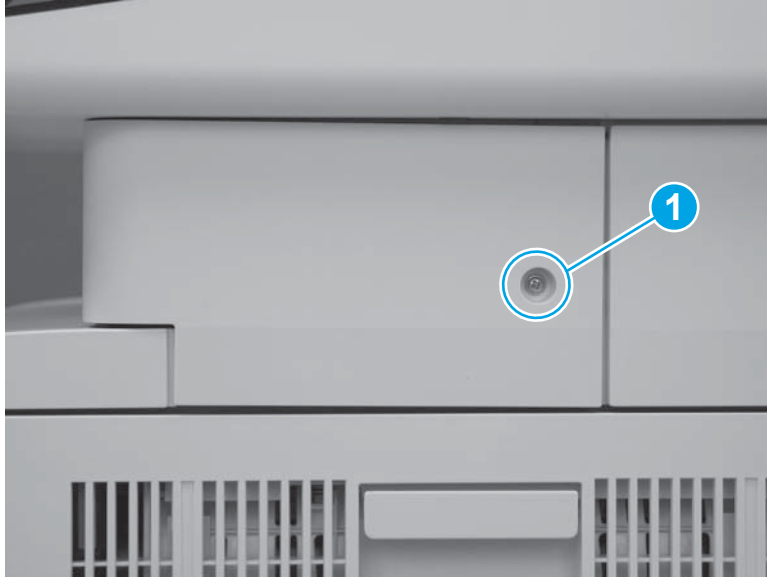

2. Release two tabs at the front edge of the cover (callout 1).

Figure 1-427 Release two tabs



3. Rotate the front of the cover to the right to remove it.

Figure 1-428 Rotate the cover



Step 5: Remove the stapler cover assembly (M577c/f/z)



NOTE: This step is for the M577c/f/z models. For the M577dn model, skip this step and to go [Step 7: Remove the right upper cover \(M577\) on page 273](#).

1. Remove one screw (callout 1).



Reinstallation tip: This is a self-tapping screw for plastic. When reinstalling, rotate the screw counterclockwise to align it with the existing thread pattern, and then carefully turn it clockwise to tighten. Do not overtighten. This will prevent stripping the threads inside the screw hole.

Figure 1-429 Remove one screw

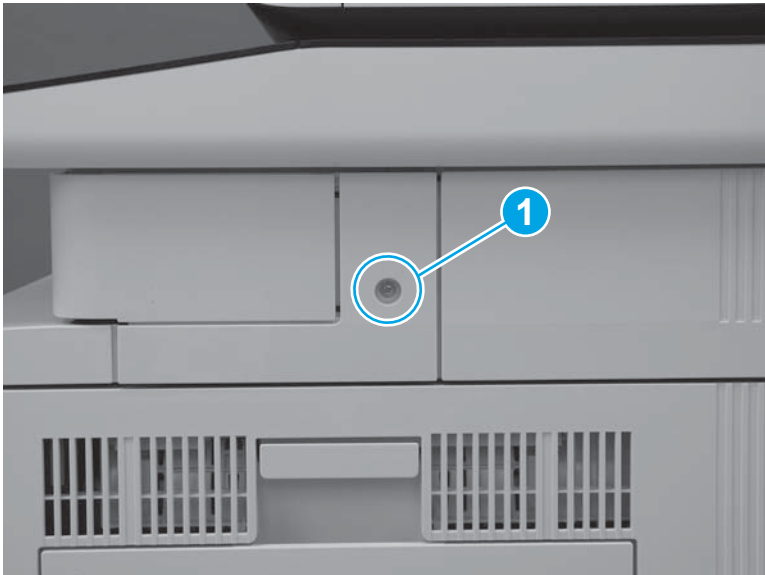

2. Release two tabs at the front edge of the cover (callout 1).

Figure 1-430 Release two tabs



3. Release the back edge of the cover.

Figure 1-431 Release the back edge of the cover

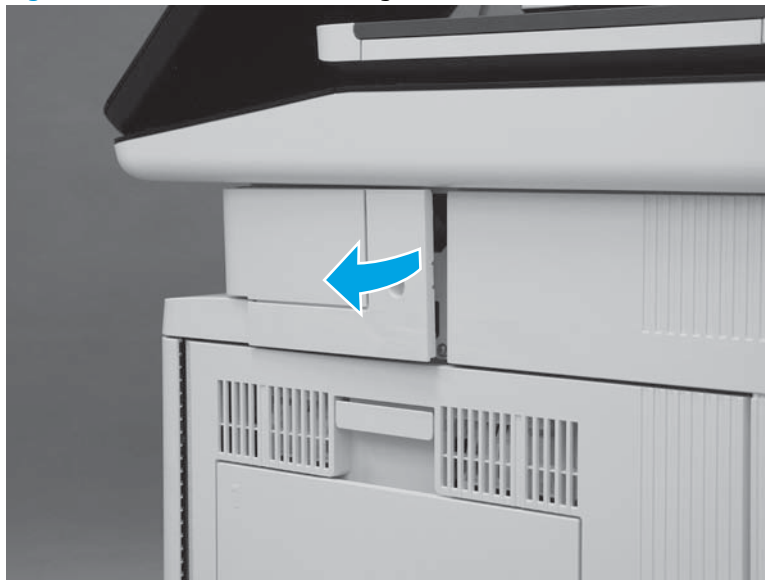

4. Rotate the cover away from the printer to remove it.

Figure 1-432 Remove the cover



Step 6: Remove the integrated scanner assembly (ISA) (M577)

 **NOTE:** The ISA includes the document feeder, image scanner, scanner control board (SCB), control panel, keyboard (M577c/z) and NFC PCA (M577z).

1. At the left side of the printer, remove one screw (callout 1).

Figure 1-433 Remove one screw

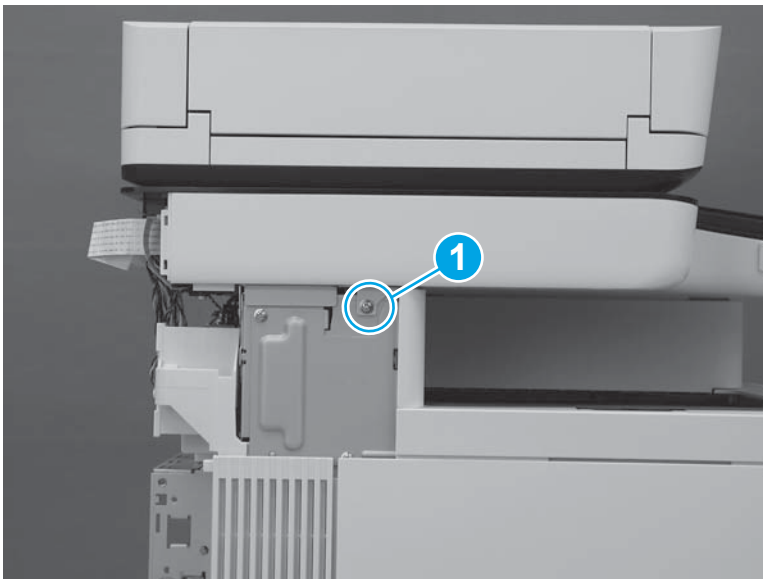

2. At the back side of the printer, remove two screws (callout 1).

Figure 1-434 Remove two screws

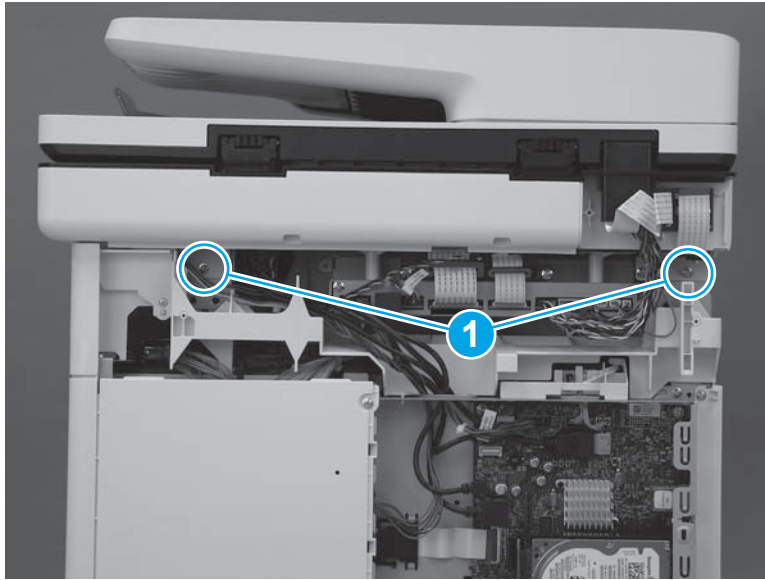

3. At the right side of the printer, remove one screw (callout 1).

Figure 1-435 Remove one screw

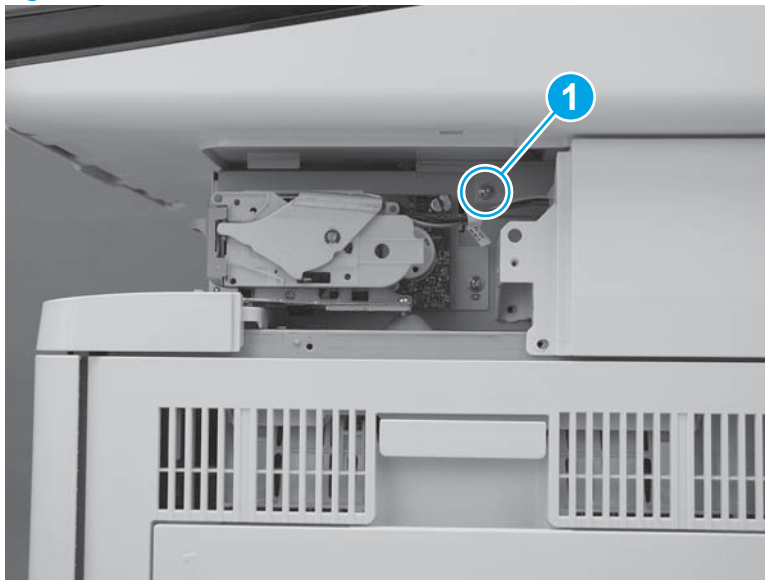

4. Disconnect four connectors on the formatter (callout 1), and then pass the wire harness and cables through the opening in the formatter case (callout 2).

Figure 1-436 Disconnect four connectors

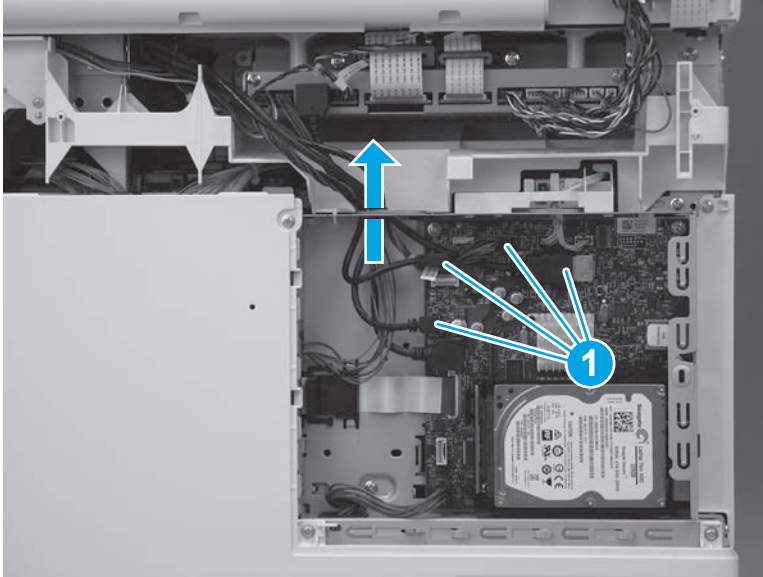

5. Disconnect two connectors on the scanner control board (callout 1).

M577c/f/z only: Disconnect one connector for the stapler on the scanner control board (callout 2).

Figure 1-437 Disconnect connectors

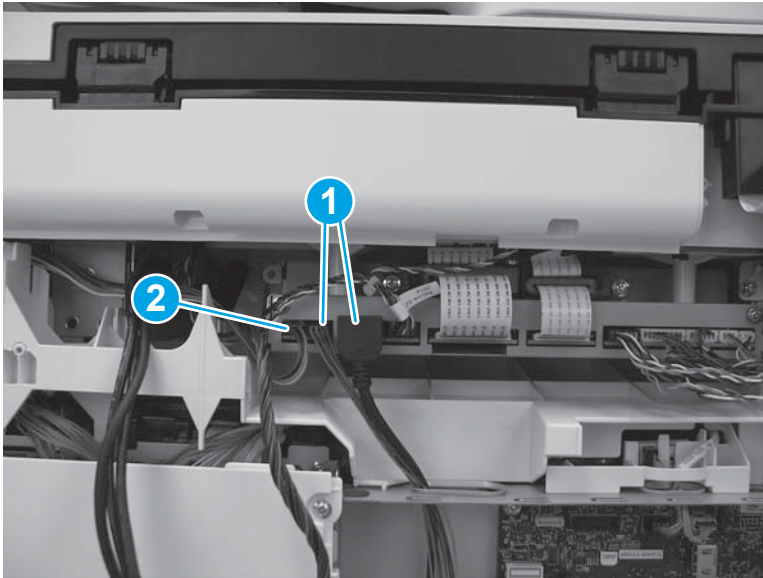

6. Slightly slide the ISA towards the back of the printer to release it.

Figure 1-438 Slide the ISA towards the back of the printer

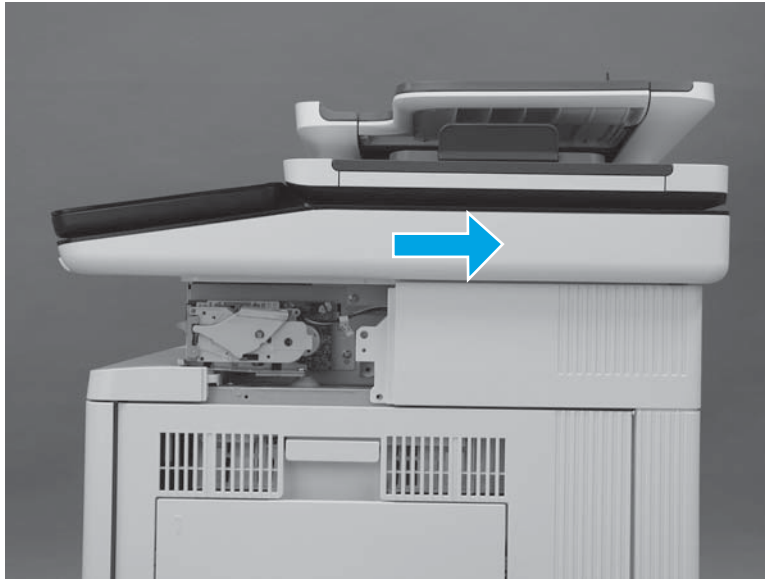

7. Lift the ISA up to remove it.

Figure 1-439 Remove the ISA

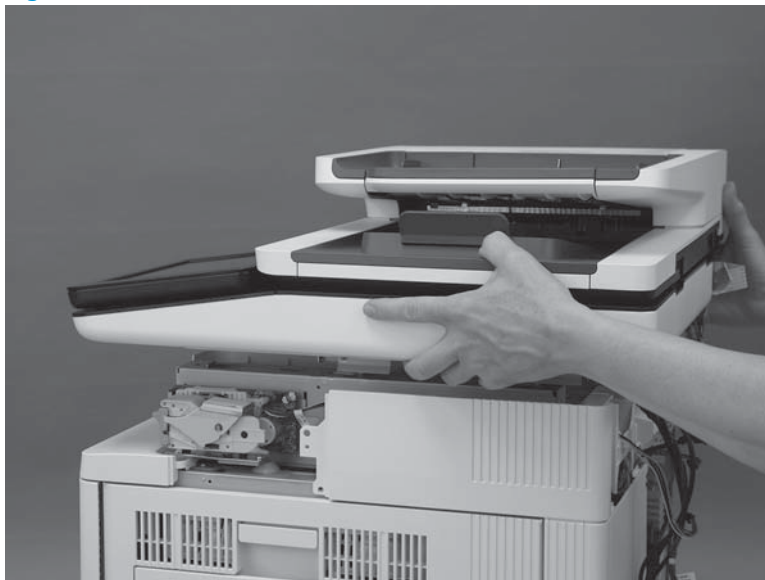

Step 7: Remove the right upper cover (M577)

 **NOTE:** The figures below show the image scanner installed. The procedures for removing and installing the right upper cover are the same whether the image scanner is installed or removed."

1. At the right side of the printer, remove two screws (callout 1).

M577c/f/z only: Disconnect one connector (callout 2), if it was not already disconnected in a previous step.

Figure 1-440 Remove two screws and one connector

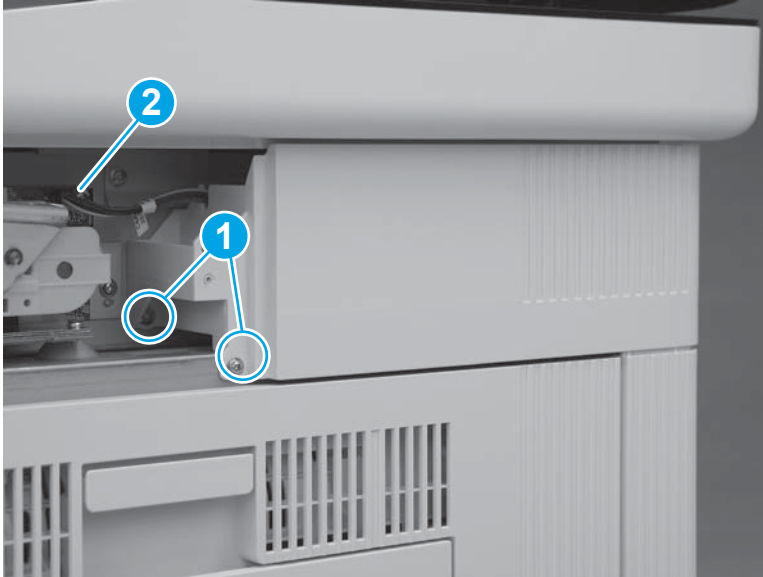

2. At the back of the printer, remove one screw (callout 1).

M577c/f/z only: Disconnect one connector (callout 2), if it was not already disconnected in a previous step.

 **Reinstallation tip:** This screw is smaller than the screws removed in the previous step. When reinstalling the right upper cover, make sure that this screw is installed in the correct position.

Figure 1-441 Remove one screw and connector



3. Slide the cover toward the back of the printer.

Figure 1-442 Slide the cover

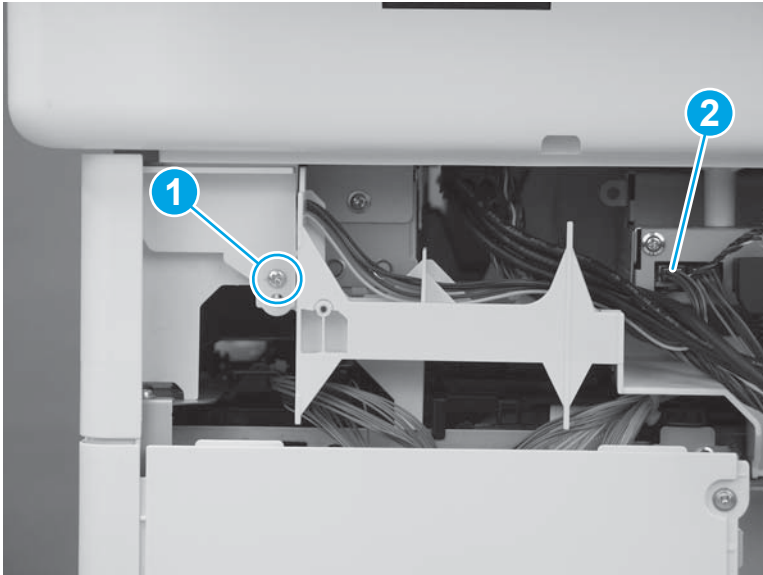
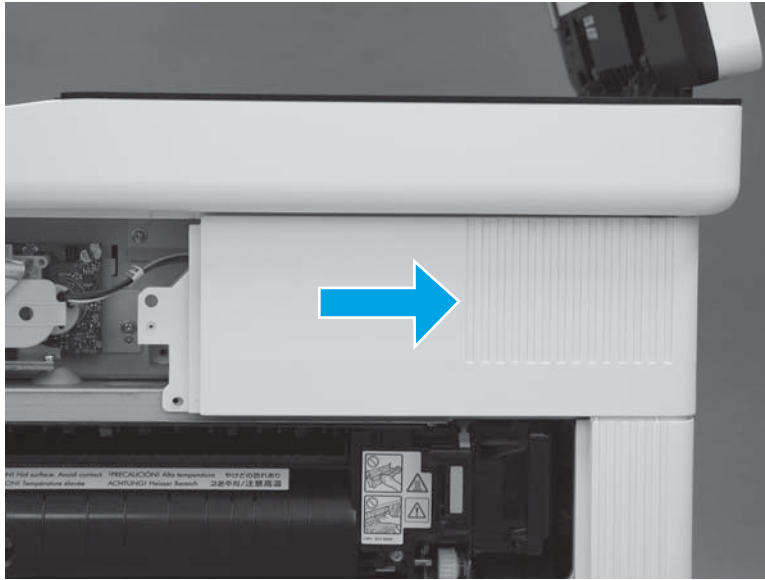

4. Lift the cover away from the printer to remove it.

M577c/f/z only: Release the cables (callout 1) through the slot (callout 2) in the printer.

Figure 1-443 Remove the cover

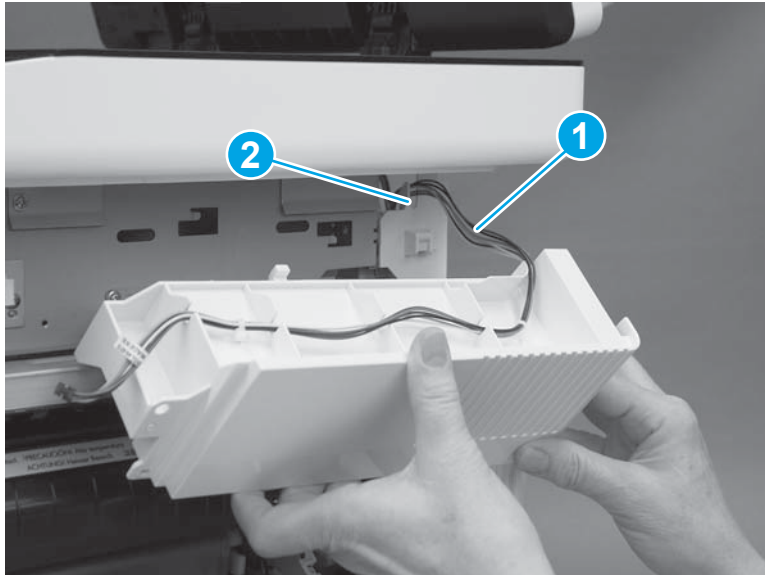

Step 8: Remove the top rear cover

1. At the top of the printer, remove five screws (callout 1).

Figure 1-444 Remove five screws

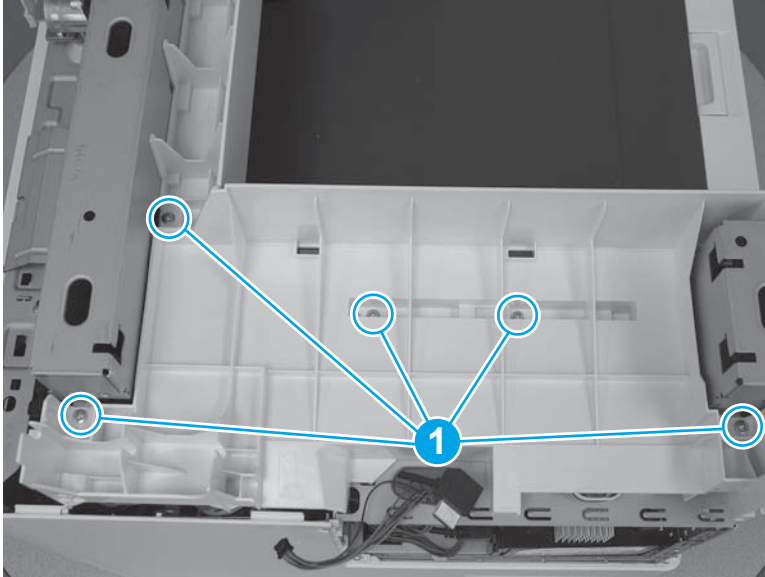

2. Release two tabs (callout 1) on the front edge of the cover.

Figure 1-445 Release two tabs

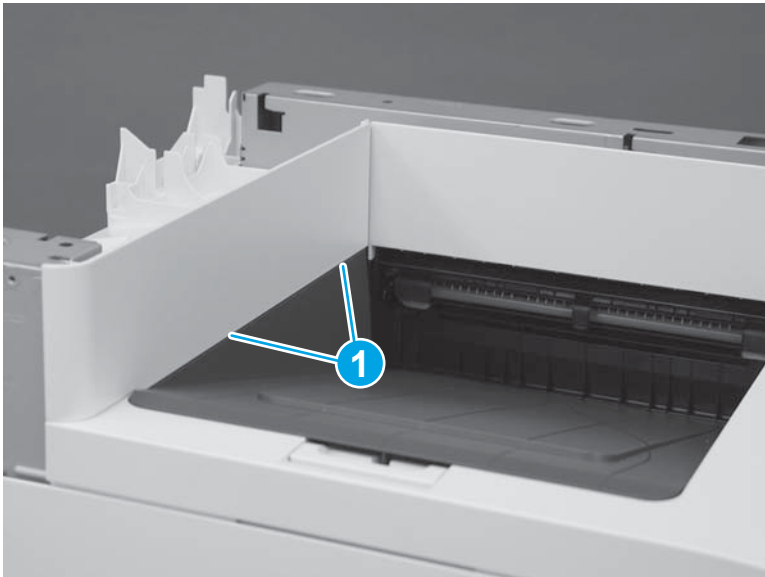

3. Remove the top rear cover.

Figure 1-446 Remove the top rear cover

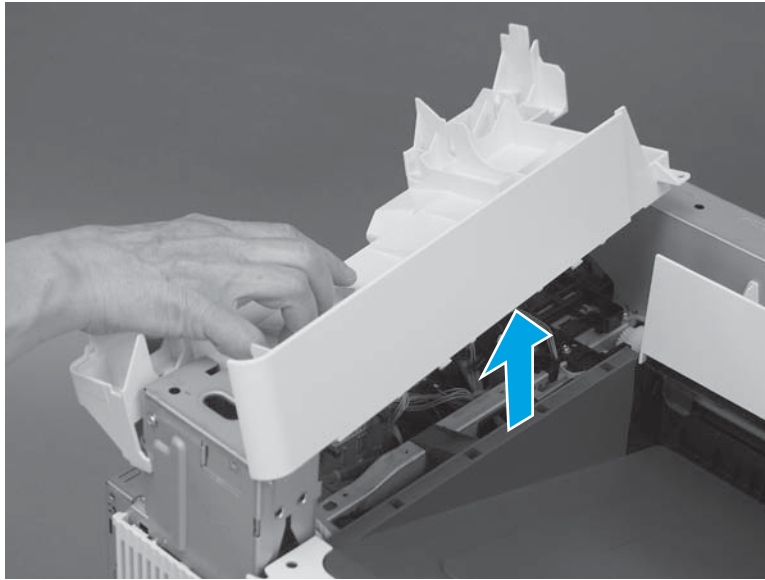

Step 9: Remove the paper feed cover

1. Remove one screw (callout 1).

Figure 1-447 Remove one screw

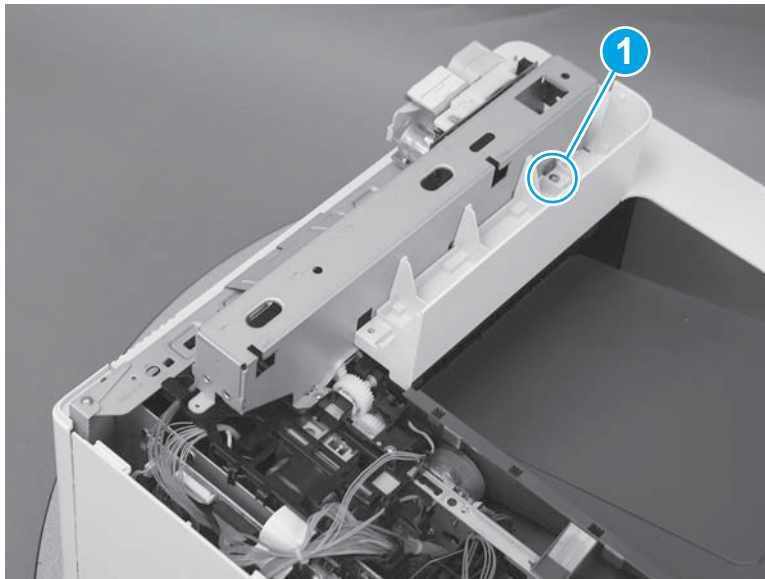

2. Lift the cover up to remove it.

Figure 1-448 Remove the cover

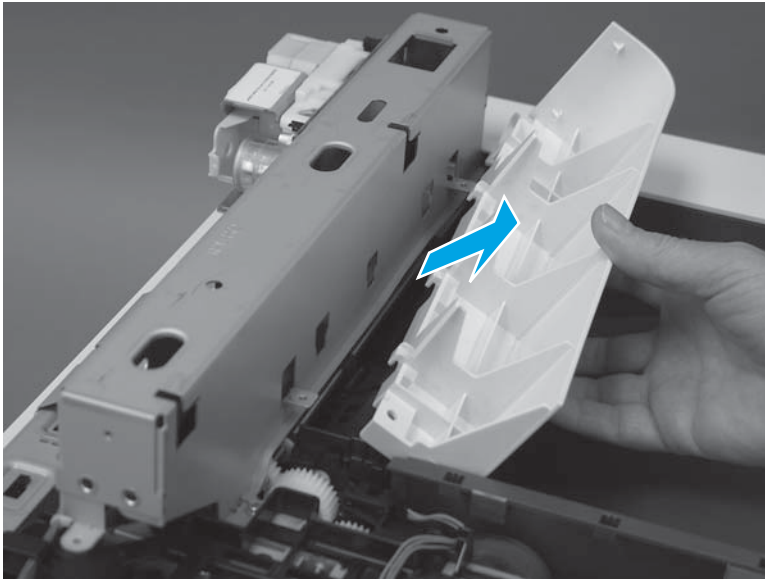

Step 10: Unpack the replacement assembly

Unpack the replacement assembly from the packaging.

For complete information on HP's recycling programs, go to [Product return and recycling](#).

 **NOTE:** HP recommends responsible disposal of the defective assembly.

Figure 1-449 Recycle and unpack



Step 11: Install the paper feed cover

1. Position the locator tabs (callout 1) on the cover in the slots (callout 2) in the printer. Press down until the cover snaps into place.

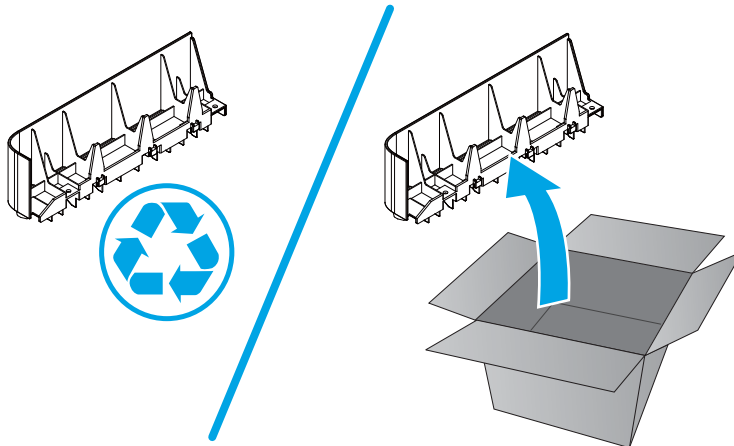
Figure 1-450 Install the cover

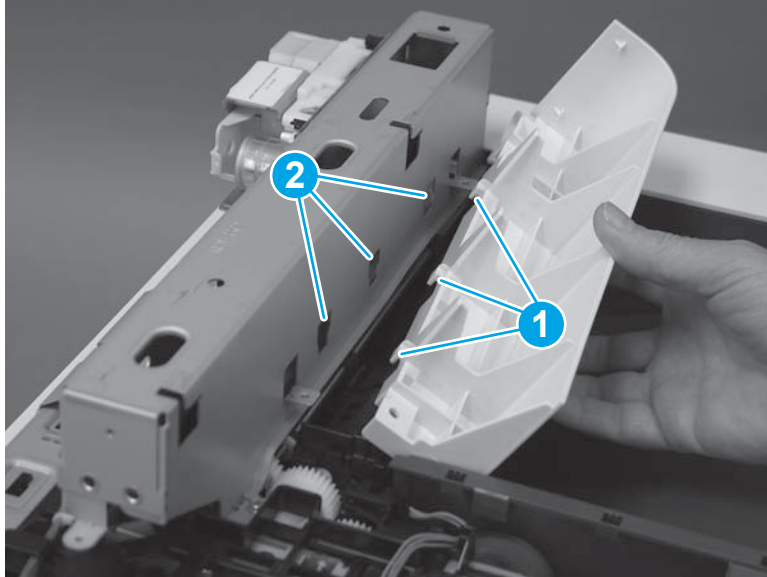

2. Install one screw (callout 1).

Figure 1-451 Install one screw

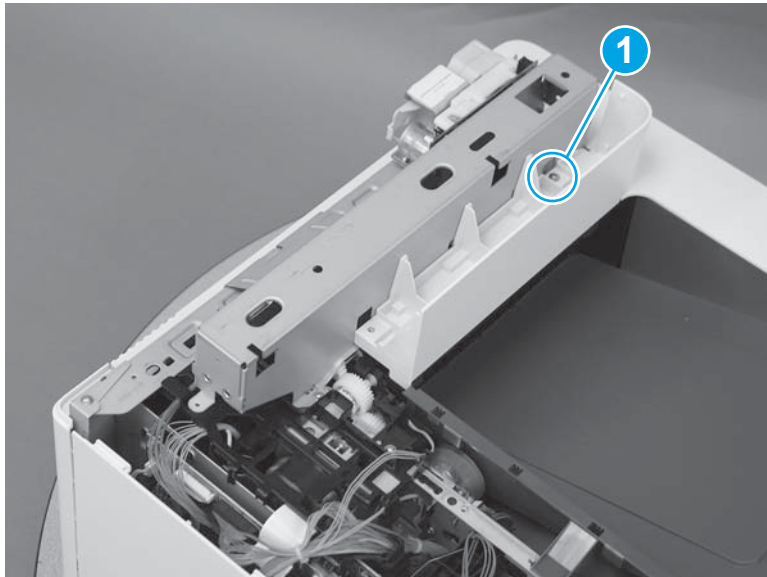

Step 12: Install the top rear cover

1. Align the locator tabs (callout 1) on the cover with the slots (callout 2) in the printer.

Figure 1-452 Align the locator tabs

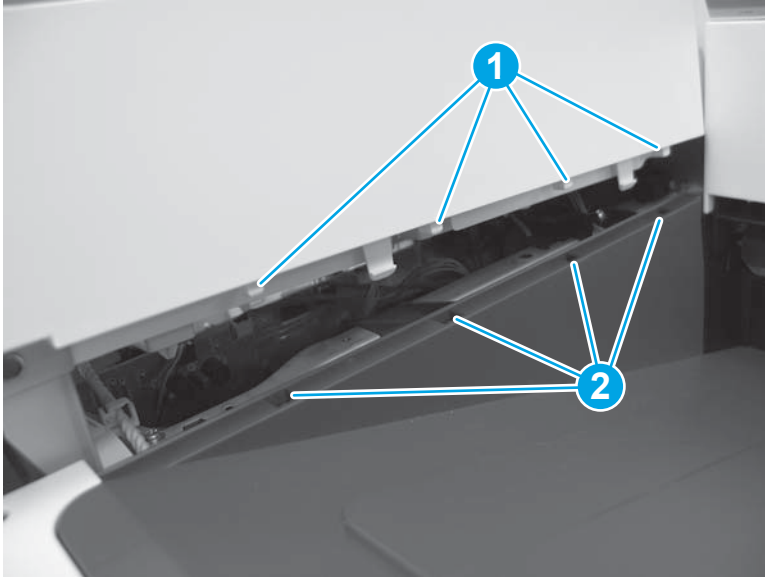

2. Press down to install the cover. Make sure that the tabs snap into place.

Figure 1-453 Install the cover

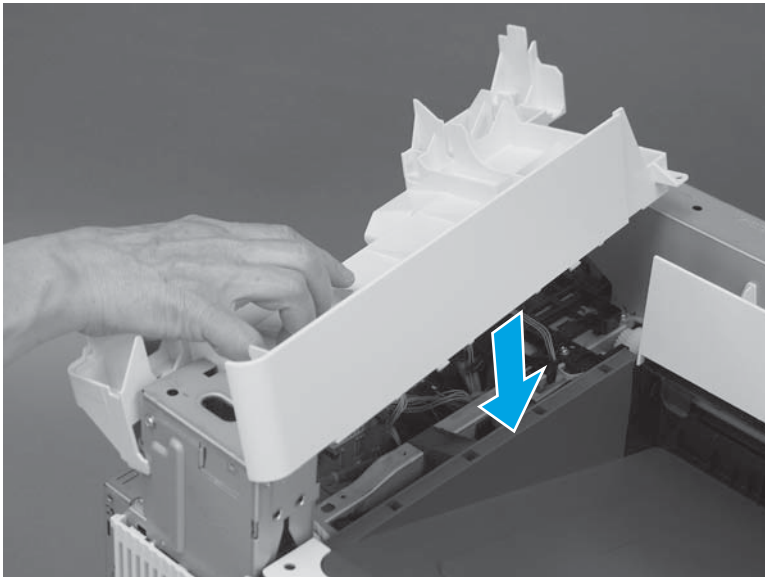

3. At the top of the printer, install five screws (callout 1).

Figure 1-454 Install five screws

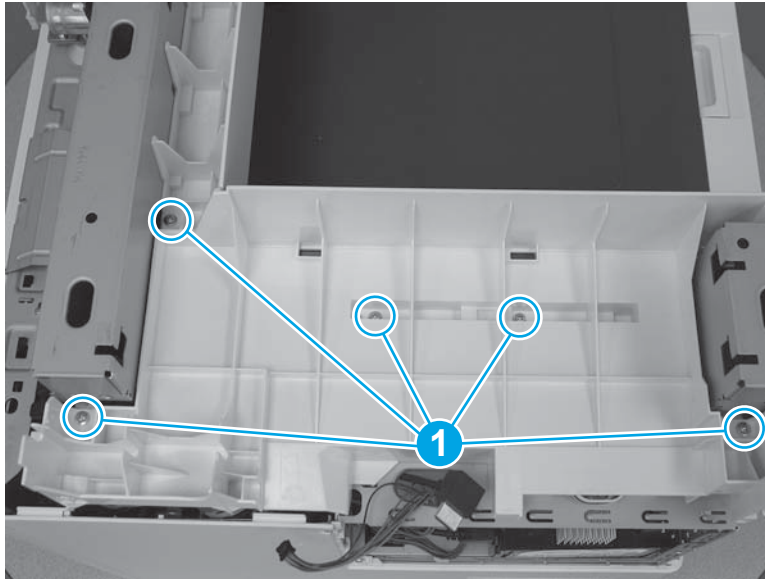

Step 13: Install the right upper cover (M577)

 **NOTE:** The figures below show the image scanner installed. The procedures for removing and installing the right upper cover are the same whether the image scanner is installed or removed."

1. **M577c/f/z only:** Install the cables (callout 1) through the slot (callout 2) in the printer.

Figure 1-455 Install the cables

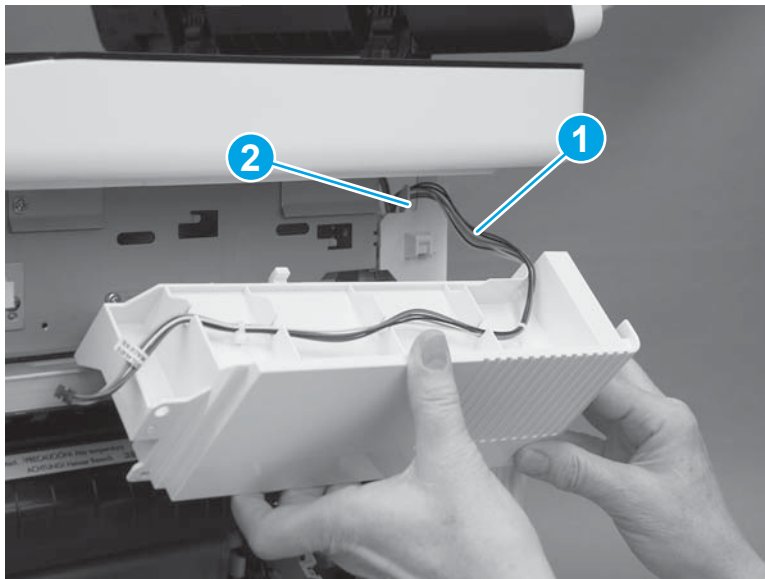

2. Position the hooks (callout 1) on the cover in the slots (callout 2) in the printer.

Figure 1-456 Position the hooks

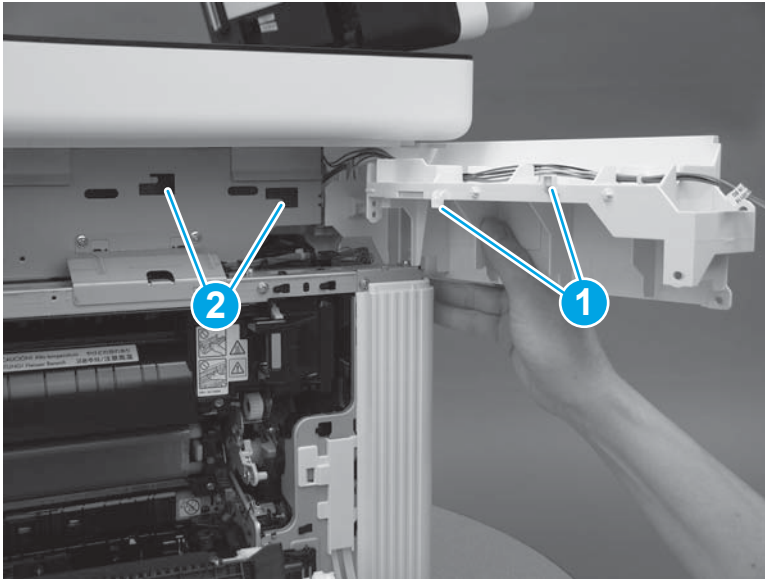

3. Slide the cover toward the front of the printer to install it.

Figure 1-457 Install the cover

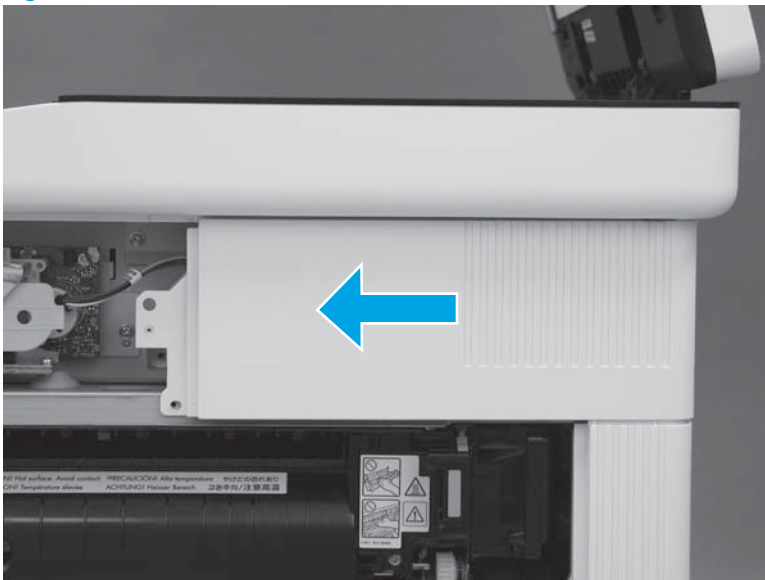

4. At the back of the printer, install one screw (callout 1).

M577c/f/z only: Connect one connector (callout 2), if the integrated scanner assembly is installed.

 **TIP:** This screw is smaller than the screws installed in the next step. Make sure that this screw is installed in the correct position.

Figure 1-458 Install one screw and connector

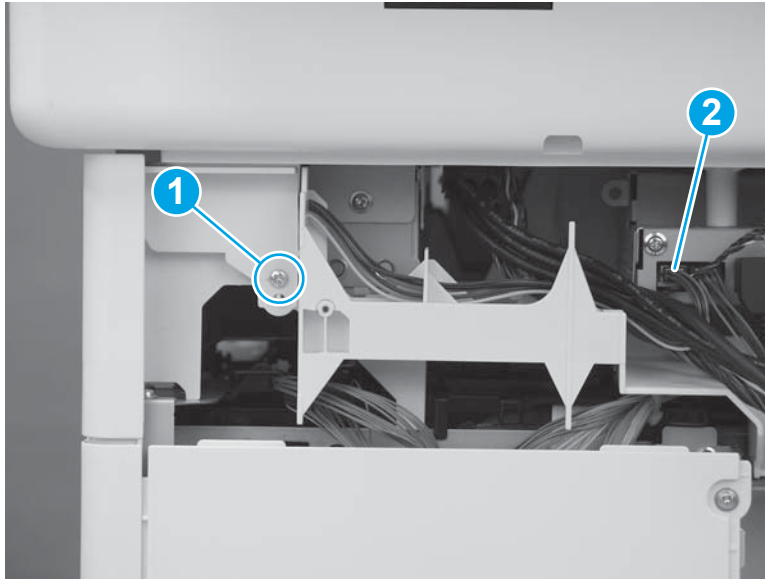

5. At the right side of the printer, install two screws (callout 1).

M577c/f/z only: Connect one connector (callout 2), if the stapler is installed.

Figure 1-459 Install one screw and connector

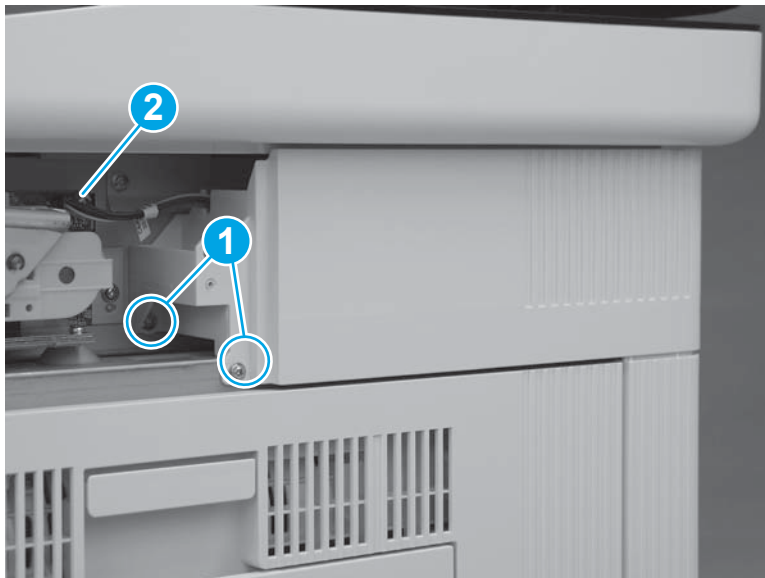

Step 14: Install the integrated scanner assembly (ISA) (M577)

 **NOTE:** The ISA includes the document feeder, image scanner, scanner control board (SCB), control panel, keyboard (M577c/z) and NFC PCA (M577z).

1. Before proceeding, locate the mounting pins (callout 1) on the bottom of the ISA and the slots (callout 2) on the printer base.

Figure 1-460 Locate the ISA mounting pins and slots

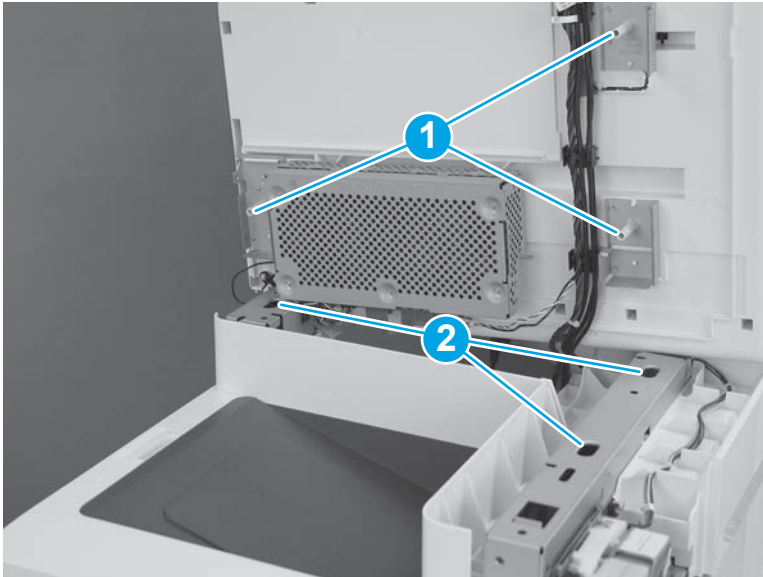

2. Position the ISA on the printer base with the pins in the slots.

 **NOTE:** To locate the pins and slots, see [Figure 1-395 Locate the ISA mounting pins and slots on page 250](#).

Figure 1-461 Install the ISA



3. Slightly slide the ISA towards the front of the printer to engage it.

Figure 1-462 Slide the ISA towards the front of the printer

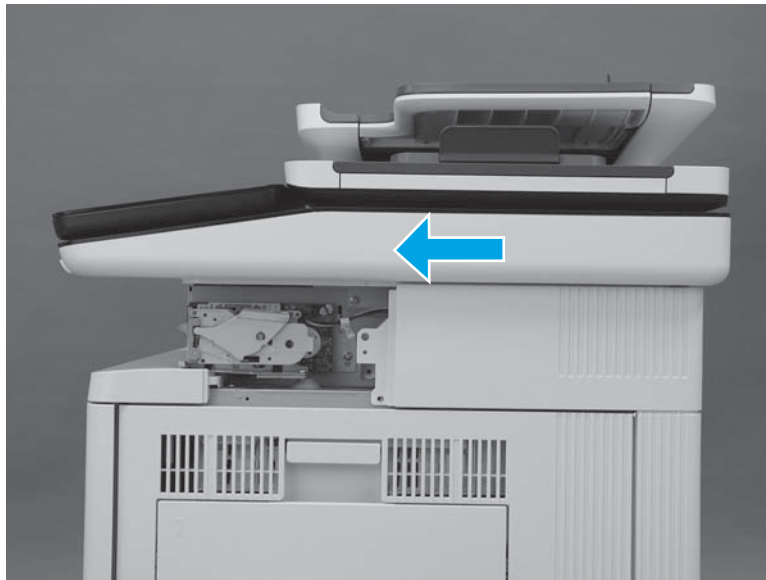

4. At the left side of the printer, install one screw (callout 1).

Figure 1-463 Install one screw

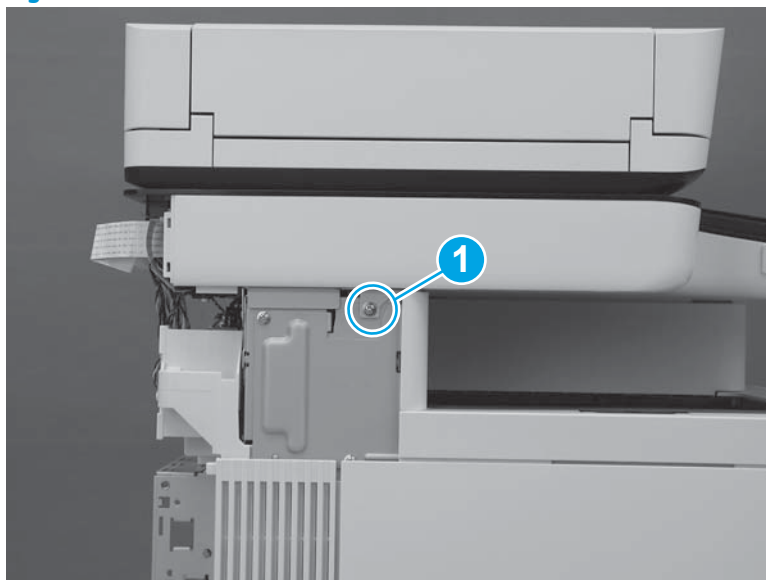

5. At the back of the printer, install two screws (callout 1).

Figure 1-464 Install two screws

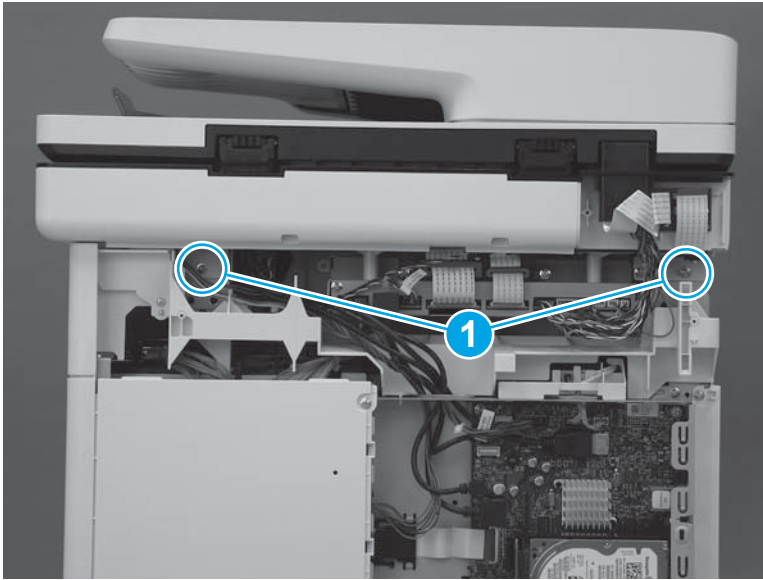

6. At the right side of the printer, install one screw (callout 1).

Figure 1-465 Install one screw

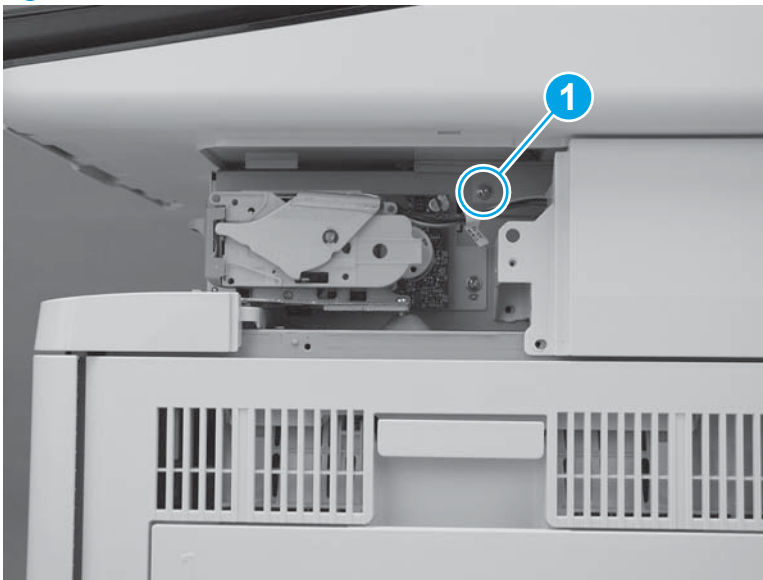

7. Connect two connectors on the scanner control board (callout 1).

M577c/f/z only: Connect one connector for the stapler on the scanner control board (callout 2).

Figure 1-466 Connect connectors

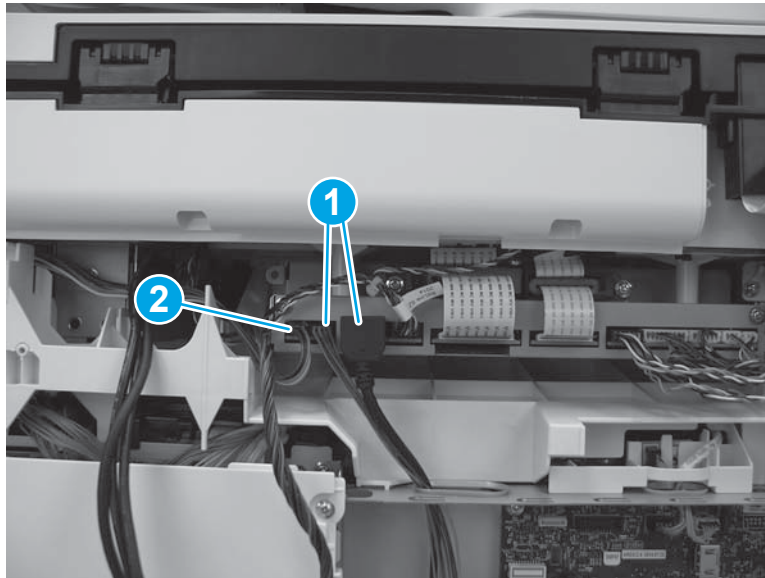

8. Install the wire harness and cables (callout 1) in the retainers (callout 2). Pass them through the opening in the top of the formatter cover (callout 3), and then connect four connectors (callout 4) on the formatter.

Figure 1-467 Connect four connectors

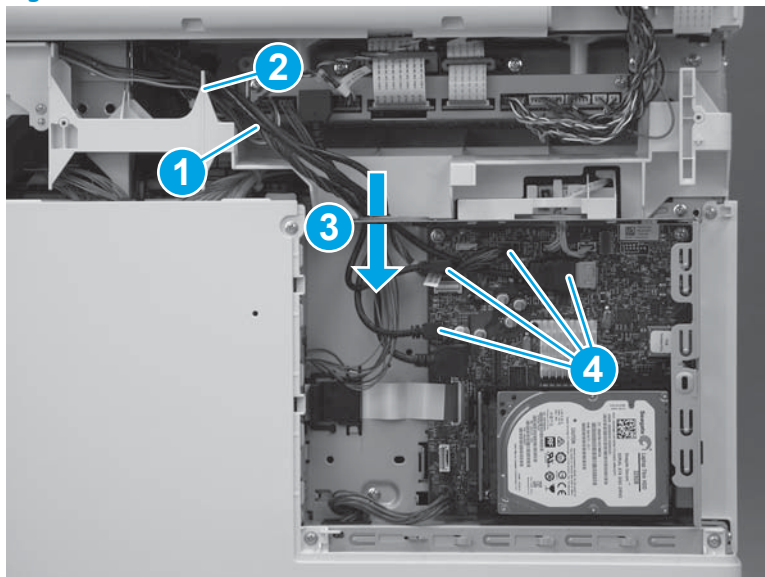

Step 15: Install the stapler cover assembly (M577c/f/z)

 **NOTE:** This step is for the M577c/f/z models only. For the M577dn model, skip this step and go to [Step 16: Install the right front upper cover \(M577dn\) on page 289.](#)

1. Install the tabs (callout 1) on the cover in the slots (callout 2) in the printer.

Figure 1-468 Install two tabs



2. Press the cover toward the left side of the printer until it snaps into place.

Figure 1-469 Install the cover assembly



3. Install one screw (callout 1).



 **IMPORTANT:** This is a self-tapping screw for plastic. Rotate it counterclockwise to align it with the existing thread pattern, and then carefully turn it clockwise to tighten. Do not overtighten. This will prevent stripping the threads inside the screw hole.

Figure 1-470 Install one screw

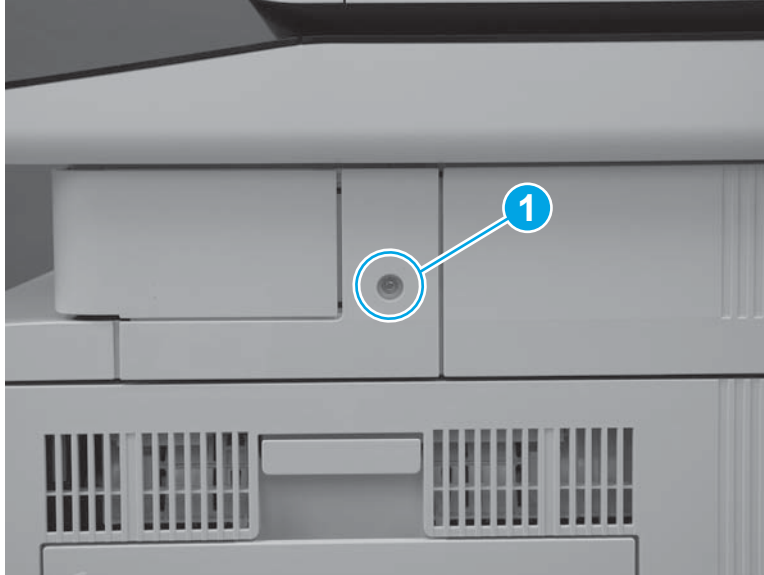

Step 16: Install the right front upper cover (M577dn)

 **NOTE:** This step is for the M577dn model only. For the M577c/f/z models, skip this step and go to [Step 17: Install the left upper cover on page 290](#).

1. Slide the cover toward the left side of the printer to install it. Make sure that the slots (callout 1) in the cover fit over the tabs (callout 2) on the inside of the paper feeder cover.

Figure 1-471 Install the cover

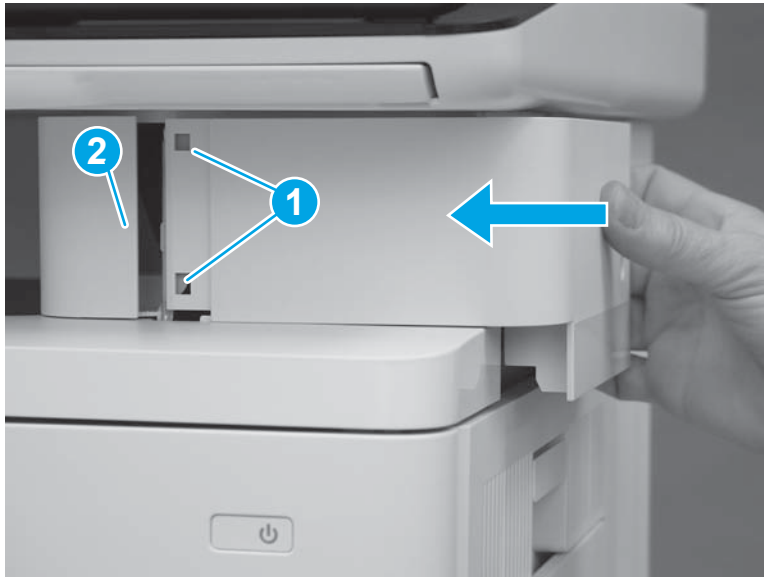

2. Press the right front upper cover (callout 1) and the paper feeder cover (callout 2) together until the tabs on the inside of the covers snap into place.

Figure 1-472 Press the cover



3. Install one screw (callout 1).

Figure 1-473 Install one screw

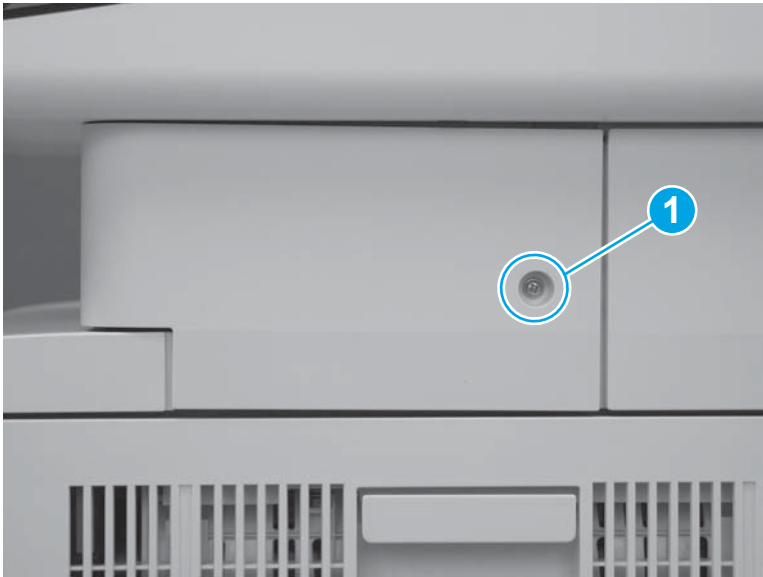

Step 17: Install the left upper cover

1. Position the tab (callout 1) on the lower edge of the cover behind the left cover (callout 2).

Figure 1-474 Position the tab

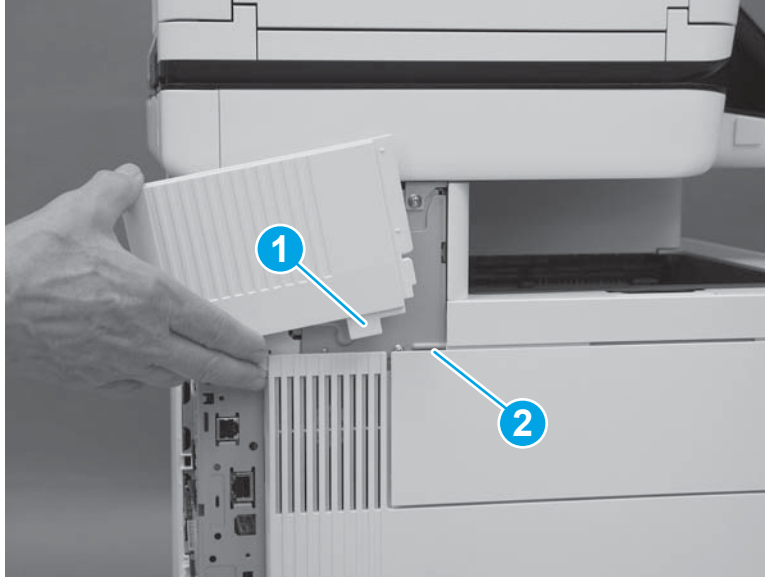

2. Slide the cover toward the front of the printer to install it. Make sure that the edge (callout 1) of the cover fits behind the edge (callout 2) of the top rear cover.

Figure 1-475 Slide the cover

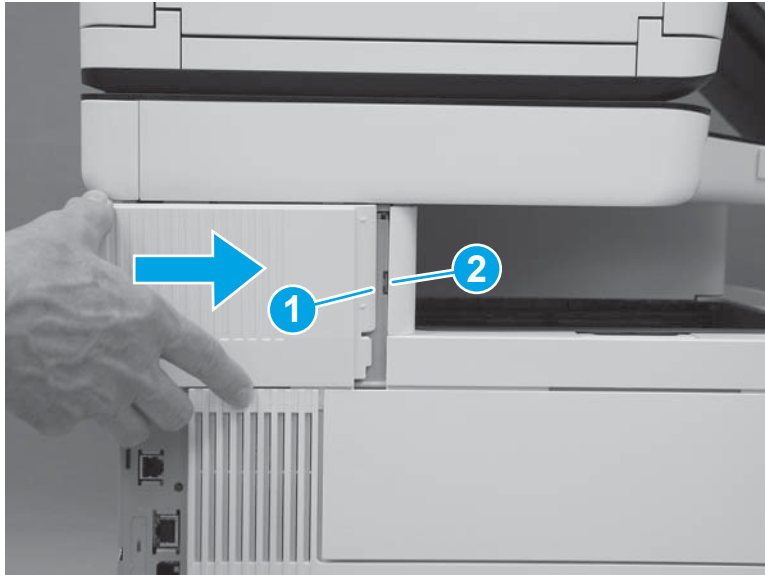

3. Make sure that the tab (callout 1) is fully installed.

Figure 1-476 Check the tab

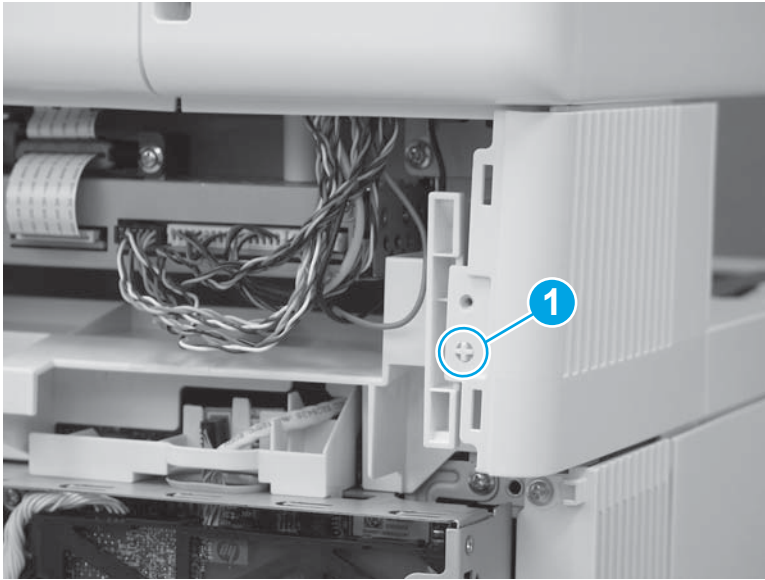

Step 18: Install the rear upper cover

1. Align the ridge (callout 1) on the lower edge of the rear upper cover in front of the tabs (callout 2) on the top edge of the rear cover.

Figure 1-477 Align the cover

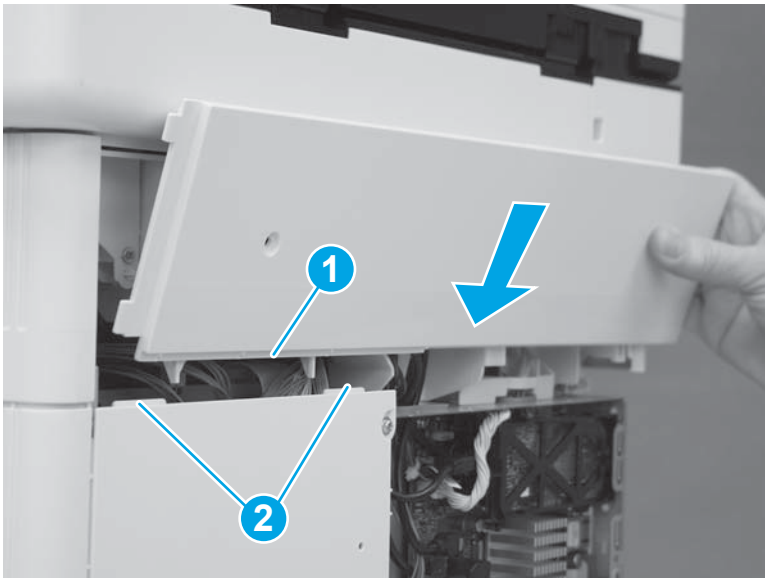

2. Rotate the top of the cover toward the printer.

Figure 1-478 Rotate the top of the cover

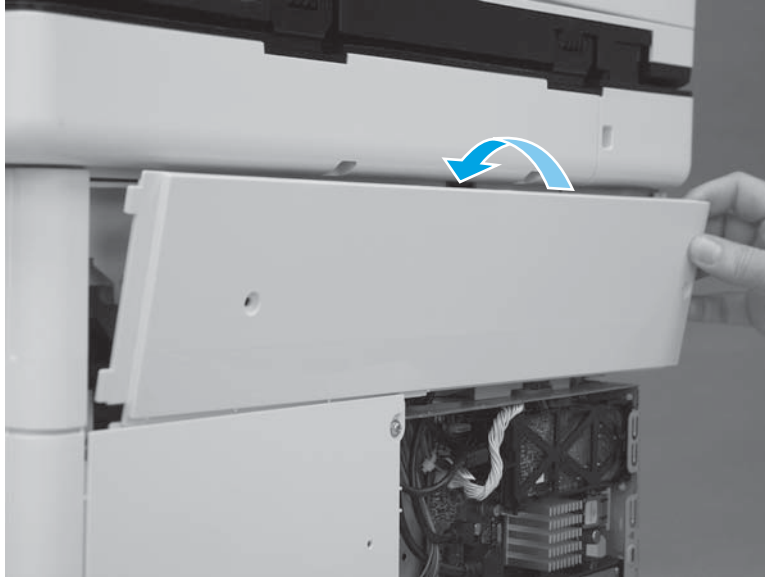

3. Slide the cover to the left (callout 1). Make sure that the tabs (callout 2) on the upper rear cover slide behind the edge (callout 3) of the right upper cover. Make sure that the cover is fully seated.

Figure 1-479 Slide the cover

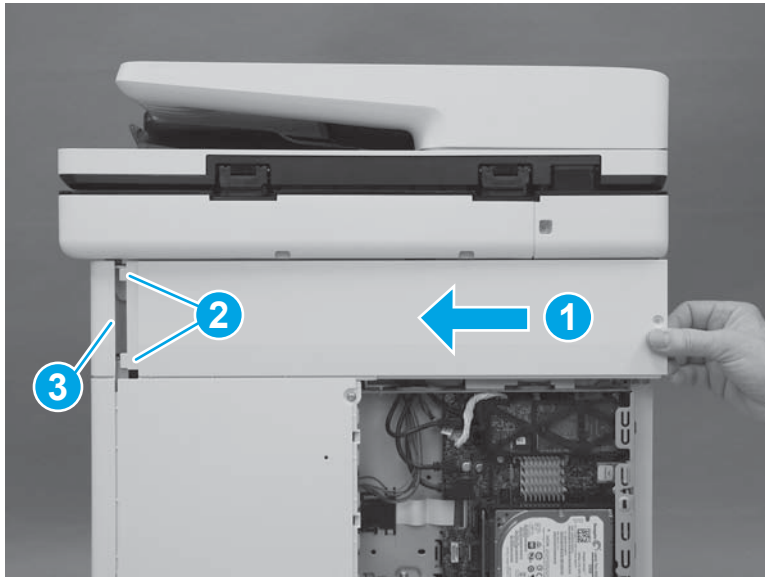

4. Install two screws (callout 1).



 **IMPORTANT:** These two screws are self-tapping screws for plastic. Rotate them counterclockwise to align them with the existing thread pattern, and then carefully turn them clockwise to tighten. Do not overtighten. This will prevent stripping the threads inside the screw holes.

Figure 1-480 Install two screws

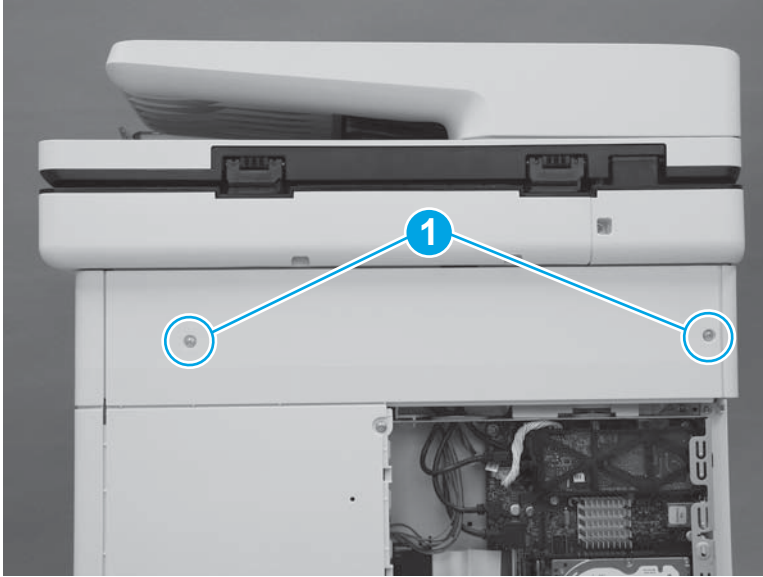

Step 19: Install the formatter cover

- ▲ Slide the cover onto the printer (callout 1) to install it.

 **NOTE:** Make sure that the tabs on the formatter cover align with the slots provided in the printer (callout 2). Tighten the two thumbscrews (callout 3).

 **TIP:** If needed, use the edge of a coin to turn the thumbscrews.

Figure 1-481 Install the cover



Removal and replacement: Top cover (M577)

- [Introduction](#)
- [Step 1: Remove the formatter cover](#)
- [Step 2: Remove the rear upper cover \(M577\)](#)
- [Step 3: Remove the left upper cover \(M577\)](#)
- [Step 4: Remove the right front upper cover \(M577dn\)](#)
- [Step 5: Remove the stapler cover assembly \(M577c/f/z\)](#)
- [Step 6: Remove the integrated scanner assembly \(ISA\) \(M577\)](#)
- [Step 7: Remove the stapler unit \(M577c/f/z\)](#)
- [Step 8: Remove the right upper cover \(M577\)](#)
- [Step 9: Remove the top rear cover \(M577\)](#)
- [Step 10: Remove the paper feed cover \(M577\)](#)
- [Step 11: Remove the toner collection unit \(TCU\)](#)
- [Step 12: Remove the top cover \(M577\)](#)
- [Step 13: Unpack the replacement assembly](#)
- [Step 14: Install the top cover](#)
- [Step 15: Install the toner collection unit \(TCU\)](#)
- [Step 16: Install the paper feed cover](#)
- [Step 17: Install the top rear cover](#)
- [Step 18: Install the right upper cover \(M577\)](#)
- [Step 19: Install the stapler unit \(M577c/f/z\)](#)
- [Step 20: Install the integrated scanner assembly \(ISA\) \(M577\)](#)
- [Step 21: Install the stapler cover assembly \(M577c/f/z\)](#)
- [Step 22: Install the right front upper cover \(M577dn\)](#)
- [Step 23: Install the left upper cover](#)
- [Step 24: Install the rear upper cover](#)
- [Step 25: Install the formatter cover](#)

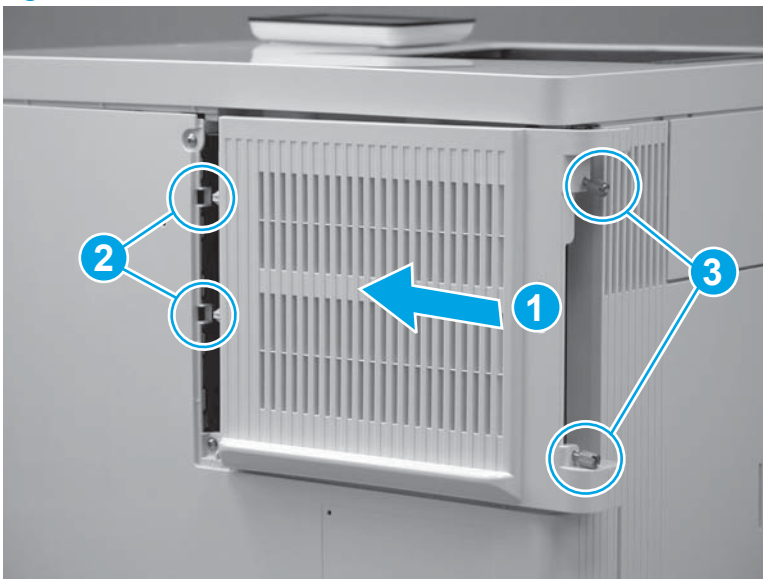
Introduction

This document provides the procedures to remove and replace the M577 top cover.

Before performing service

Make sure that the top cover is fully seated after replacing it.

Turn the printer power off

- Disconnect the power cable.

⚠ WARNING! To avoid damage to the printer, turn the printer off, wait 30 seconds, and then remove the power cord before attempting to service the printer.

Use the table below to identify the correct part number for your printer. To order the part, go to www.hp.com/buy/parts.

Top cover (M577) part number

RC4-3381-000CN

Top cover (M577)

Required tools

- Small flat blade screwdriver
- #2 Phillips screwdriver with a magnetic tip

After performing service

Turn the printer power on

- Connect the power cable.
- Use the power switch to turn the power on.

Step 1: Remove the formatter cover

1. Locate the formatter cover.

Figure 1-482 Locate the formatter cover

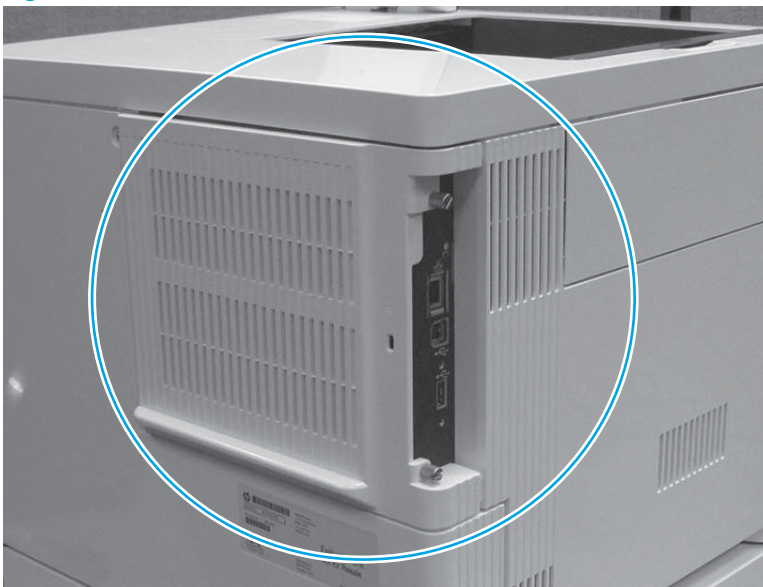

2. Loosen the two thumbscrews (callout 1). Grasp the two thumbscrews, and then slide the cover away from the printer (callout 2) to remove it.

 **TIP:** If needed, use the edge of a coin to turn the thumbscrews.

Figure 1-483 Loosen the thumbscrews



Step 2: Remove the rear upper cover (M577)

1. Remove two screws (callout 1).

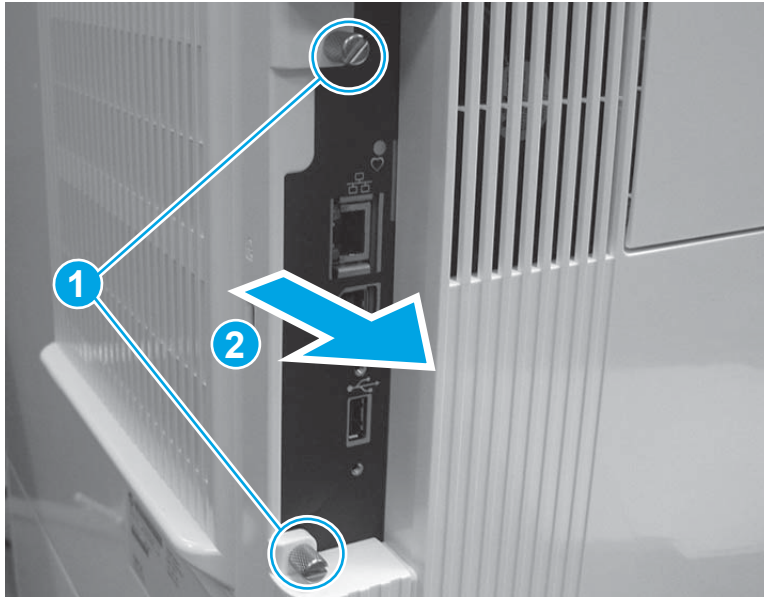
 **Reinstallation tip:** These two screws are self-tapping screws for plastic. When reinstalling them, rotate the screws counterclockwise to align them with the existing thread pattern, and then carefully turn them clockwise to tighten. Do not overtighten. This will prevent stripping the threads inside the screw holes.

Figure 1-484 Remove two screws



2. Use a small, flat blade screwdriver to release the right edge of the cover.

Figure 1-485 Release the right edge

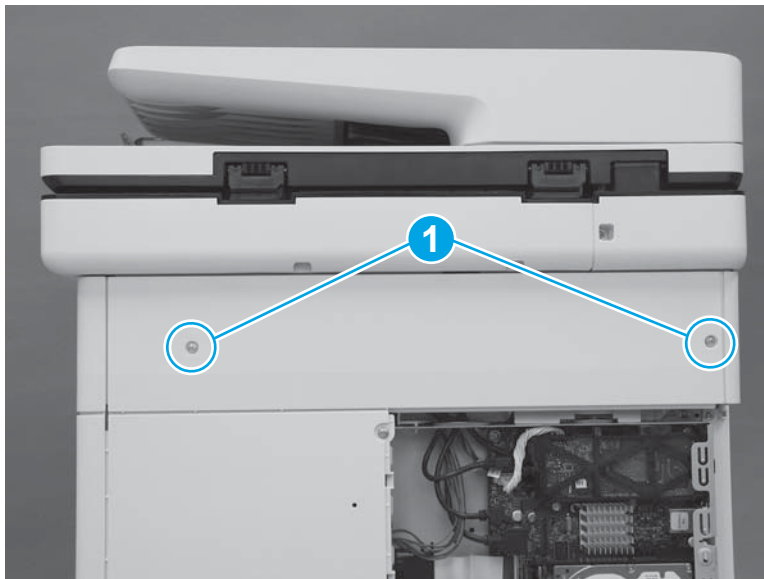
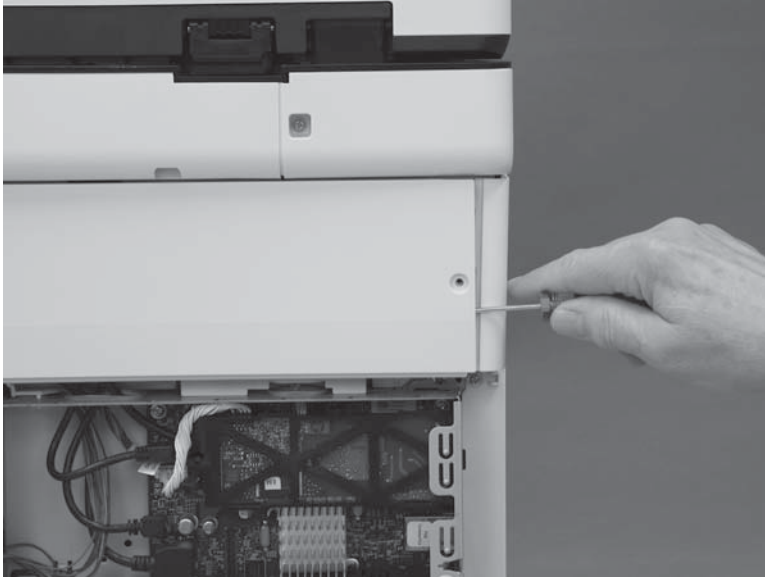

3. Pull the right edge of the cover (callout 1) away from the printer, and then slide the cover to the right (callout 2).

Figure 1-486 Slide the cover right

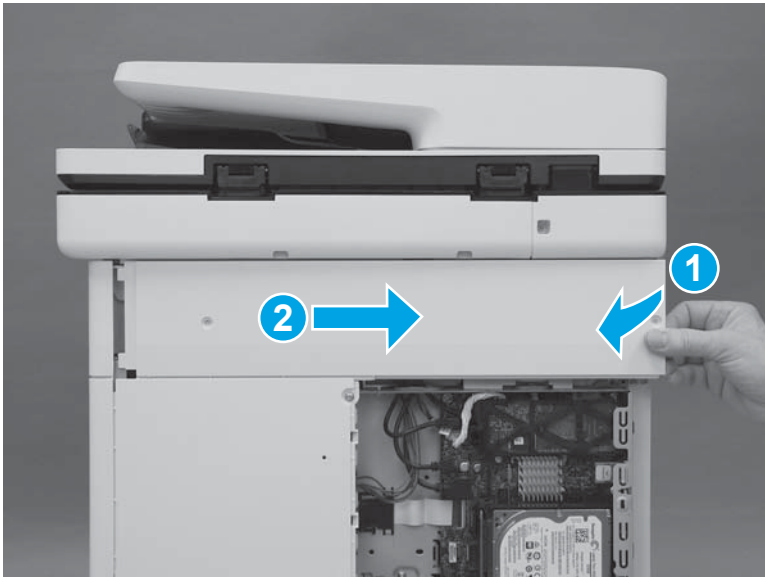

4. Remove the cover.

Figure 1-487 Remove the cover

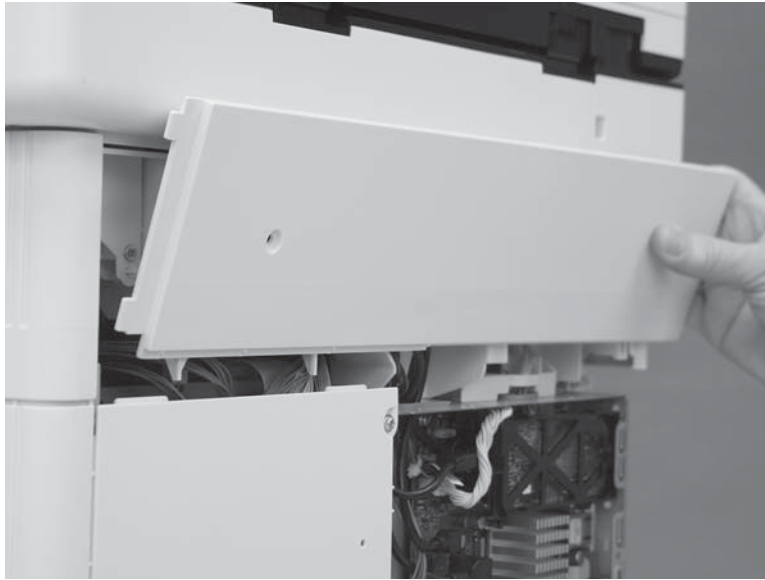

Step 3: Remove the left upper cover (M577)

1. At the left side of the printer, release one tab (callout 1).

Figure 1-488 Release one tab

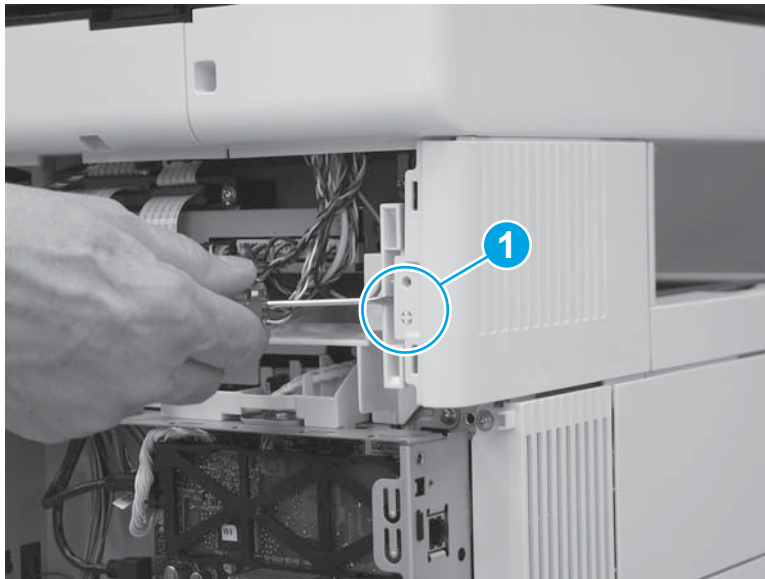

2. Slide the left upper cover toward the back of the printer.

Figure 1-489 Slide the cover back

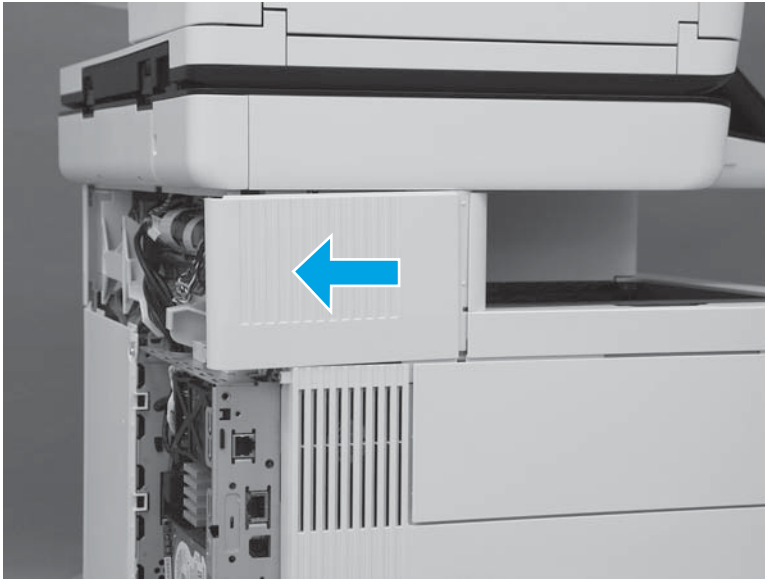

3. Rotate the cover up to remove it.

Figure 1-490 Remove the left upper cover

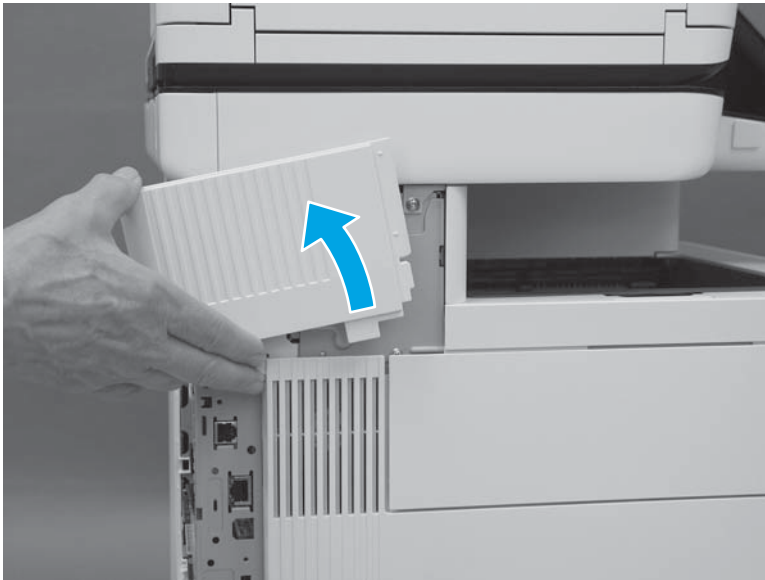

Step 4: Remove the right front upper cover (M577dn)

 **NOTE:** This step is for the M577dn model. For the M577c/f/z models, skip this step and to go [Step 5: Remove the stapler cover assembly \(M577c/f/z\) on page 302.](#)

1. Remove one screw (callout 1).

Figure 1-491 Remove one screw

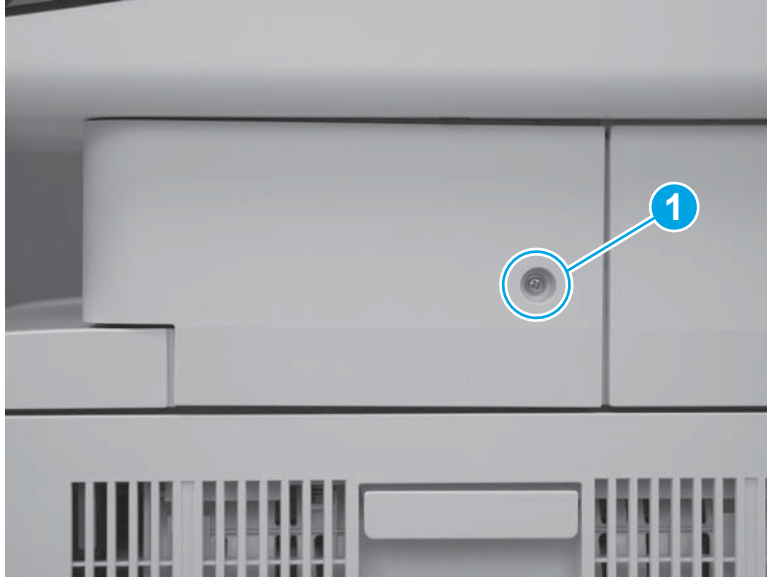

2. Release two tabs at the front edge of the cover (callout 1).

Figure 1-492 Release two tabs



3. Rotate the front of the cover to the right to remove it.

Figure 1-493 Rotate the cover



Step 5: Remove the stapler cover assembly (M577c/f/z)



NOTE: This step is for the M577c/f/z models. For the M577dn model, skip this step and to go [Step 6: Remove the integrated scanner assembly \(ISA\) \(M577\) on page 304.](#)

1. Remove one screw (callout 1).



Reinstallation tip: This is a self-tapping screw for plastic. When reinstalling, rotate the screw counterclockwise to align it with the existing thread pattern, and then carefully turn it clockwise to tighten. Do not overtighten. This will prevent stripping the threads inside the screw hole.

Figure 1-494 Remove one screw

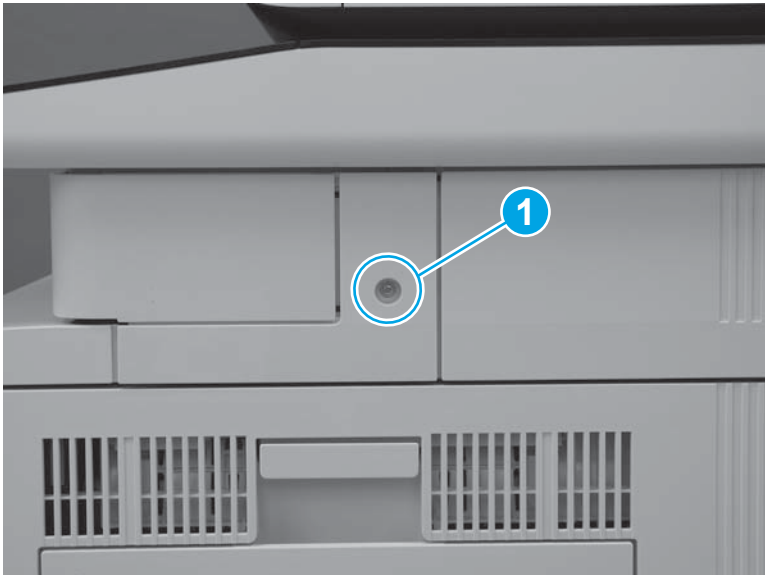

2. Release two tabs at the front edge of the cover (callout 1).

Figure 1-495 Release two tabs



3. Release the back edge of the cover.

Figure 1-496 Release the back edge of the cover



4. Rotate the cover away from the printer to remove it.

Figure 1-497 Remove the cover



Step 6: Remove the integrated scanner assembly (ISA) (M577)

 **NOTE:** The ISA includes the document feeder, image scanner, scanner control board (SCB), control panel, keyboard (M577c/z) and NFC PCA (M577z).

1. At the left side of the printer, remove one screw (callout 1).

Figure 1-498 Remove one screw

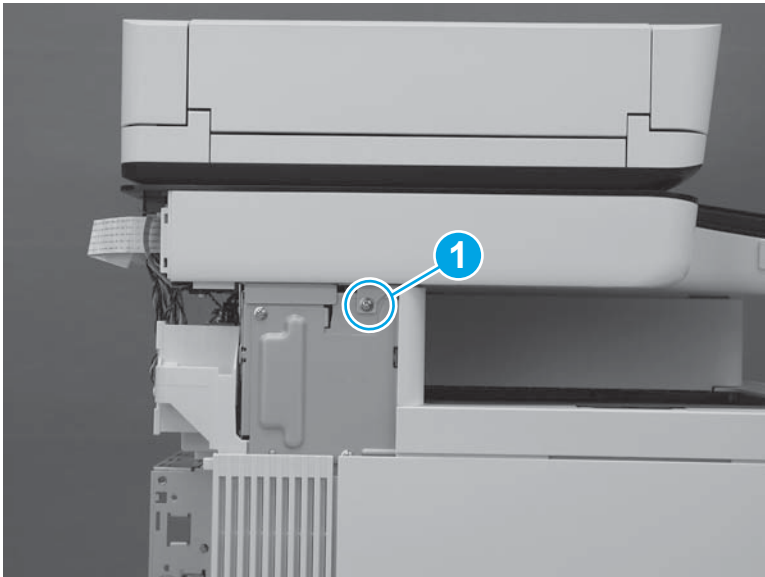

2. At the back side of the printer, remove two screws (callout 1).

Figure 1-499 Remove two screws

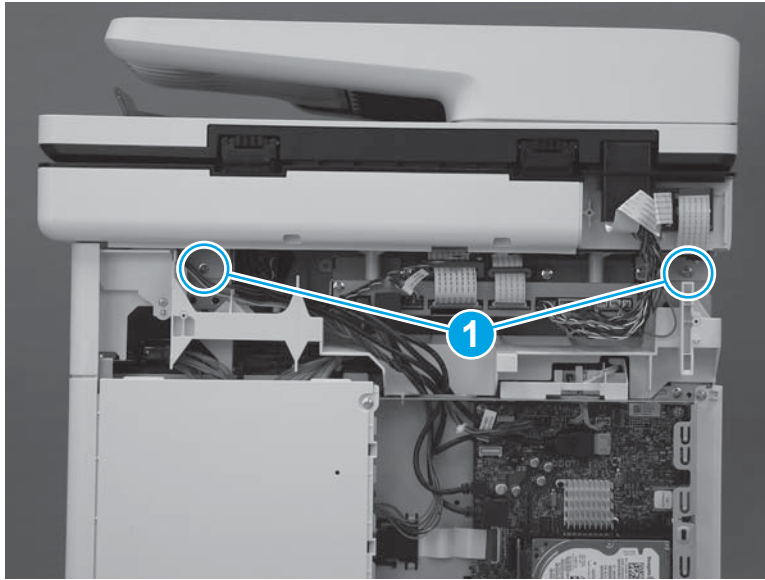

3. At the right side of the printer, remove one screw (callout 1).

Figure 1-500 Remove one screw

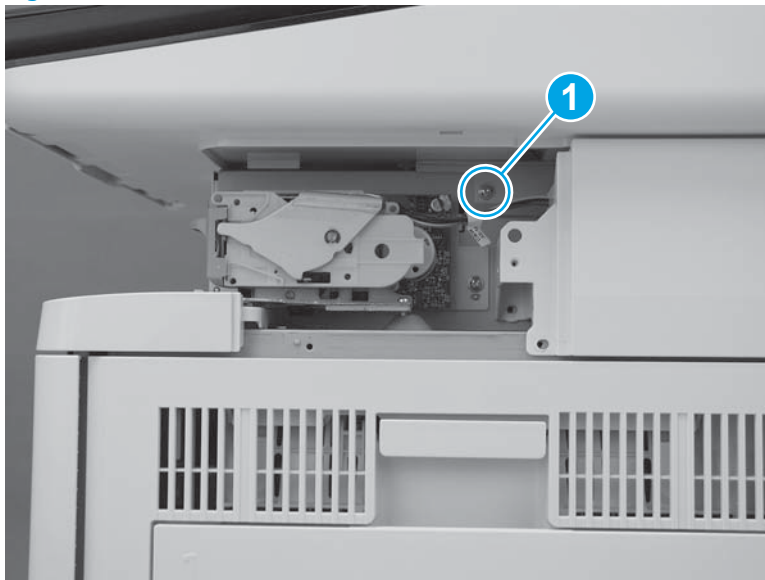

4. Disconnect four connectors on the formatter (callout 1), and then pass the wire harness and cables through the opening in the formatter case (callout 2).

Figure 1-501 Disconnect four connectors

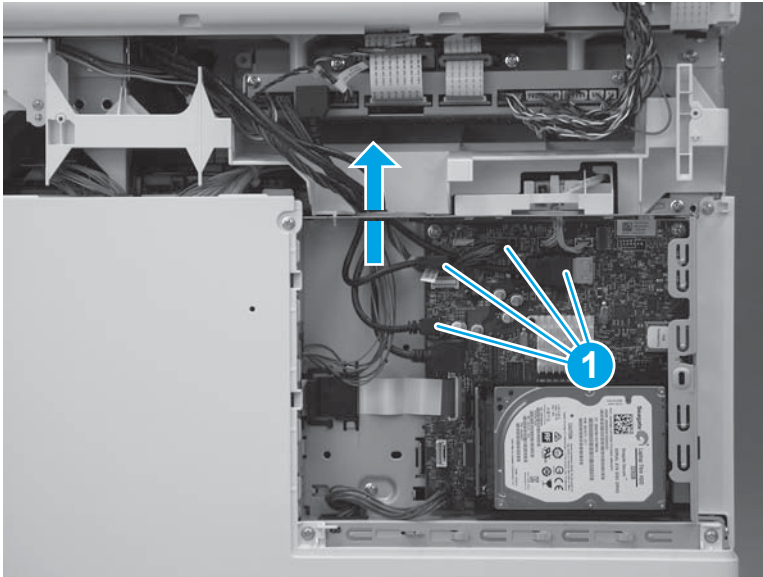

5. Disconnect two connectors on the scanner control board (callout 1).

M577c/f/z only: Disconnect one connector for the stapler on the scanner control board (callout 2).

Figure 1-502 Disconnect connectors

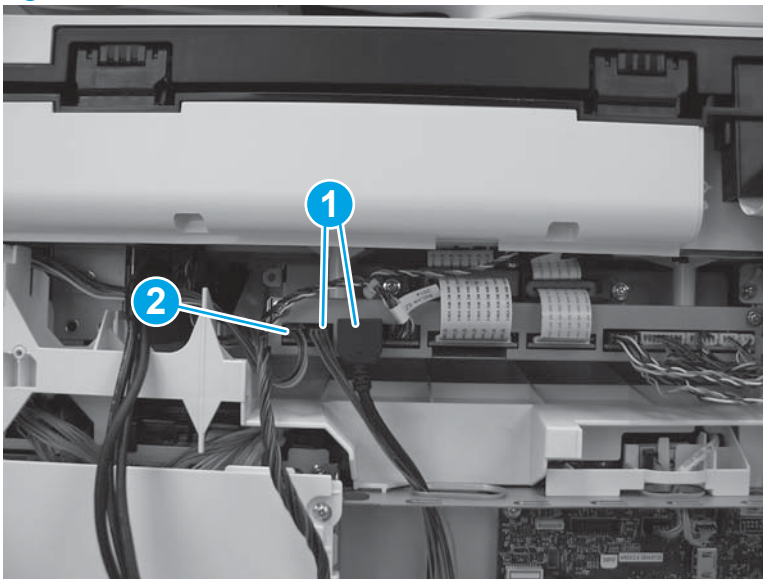

6. Slightly slide the ISA towards the back of the printer to release it.

Figure 1-503 Slide the ISA towards the back of the printer

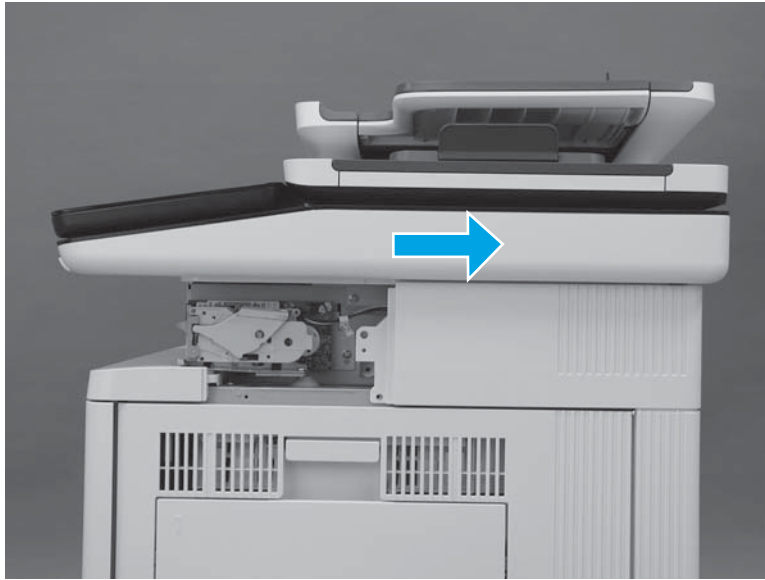

7. Lift the ISA up to remove it.

Figure 1-504 Remove the ISA

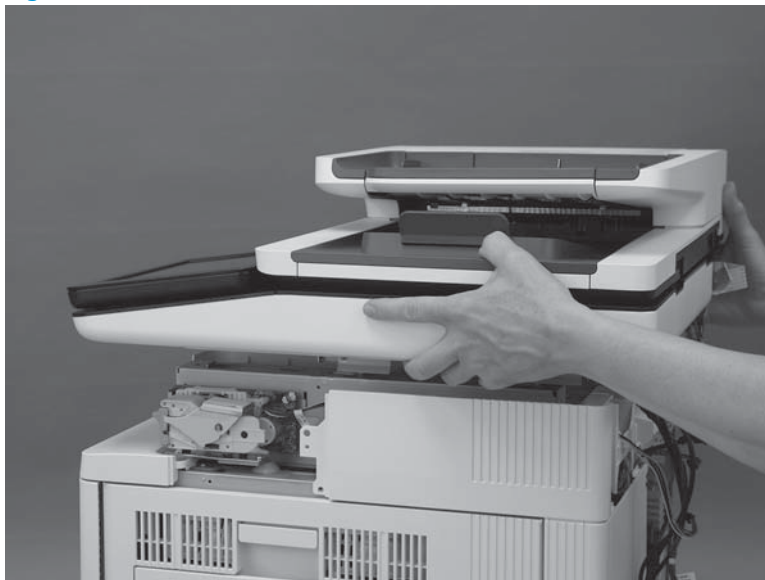

Step 7: Remove the stapler unit (M577c/f/z)

1. Disconnect one connector (callout 1), and then remove two screws (callout 2).

Figure 1-505 Disconnect connector and remove screws

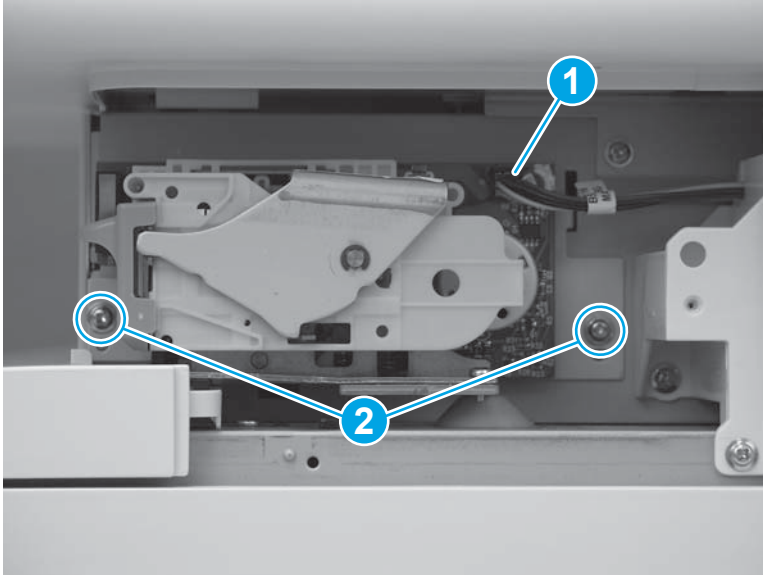

2. Slide the stapler unit up (callout 1), and then pull it away from the printer (callout 2) to remove it.

Figure 1-506 Remove the stapler unit

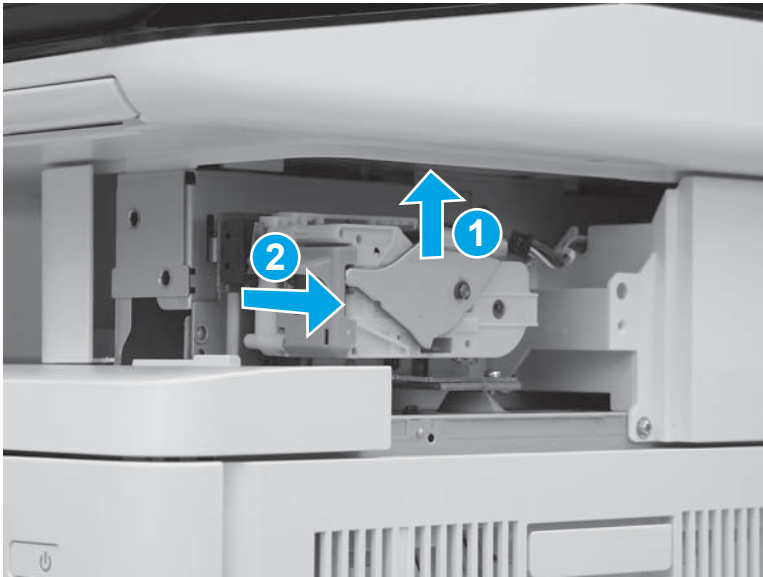

Step 8: Remove the right upper cover (M577)

 **NOTE:** The figures below show the image scanner installed. The procedures for removing and installing the right upper cover are the same whether the image scanner is installed or removed."

1. At the right side of the printer, remove two screws (callout 1).

M577c/f/z only: Disconnect one connector (callout 2), if it was not already disconnected in a previous step.

Figure 1-507 Remove two screws and one connector

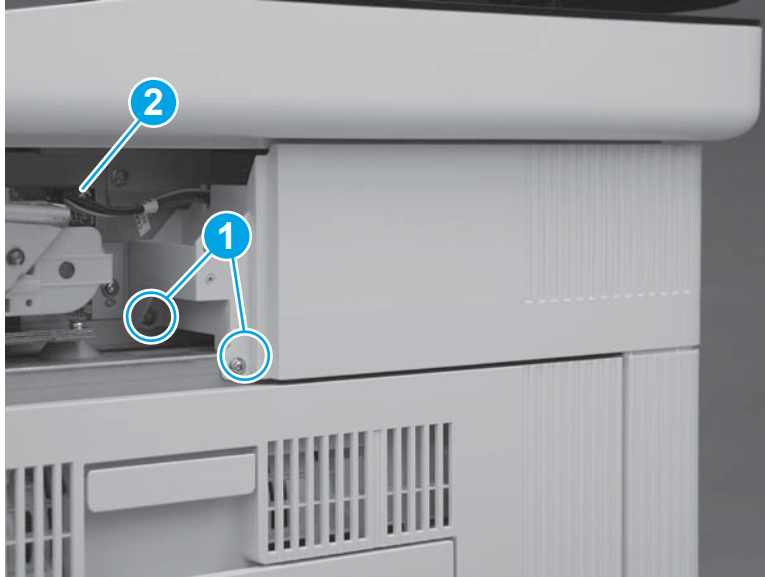

2. At the back of the printer, remove one screw (callout 1).

M577c/f/z only: Disconnect one connector (callout 2), if it was not already disconnected in a previous step.

 **Reinstallation tip:** This screw is smaller than the screws removed in the previous step. When reinstalling the right upper cover, make sure that this screw is installed in the correct position.

Figure 1-508 Remove one screw and connector



3. Slide the cover toward the back of the printer.

Figure 1-509 Slide the cover

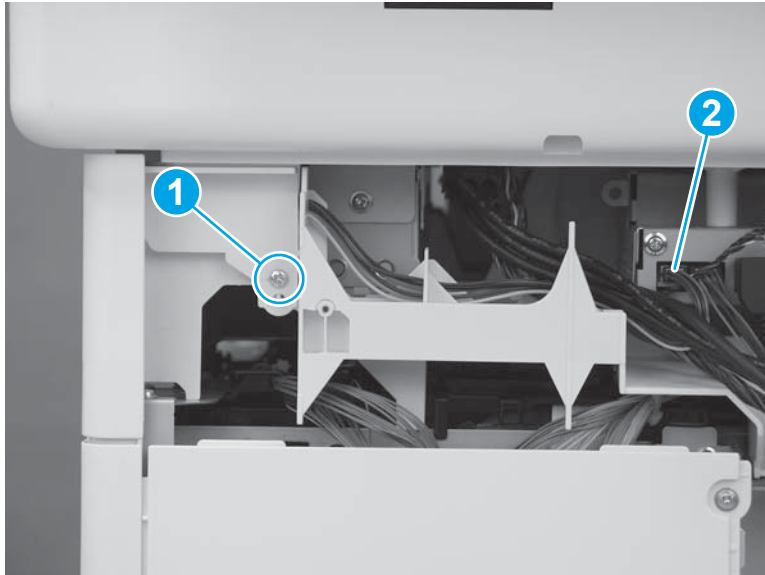
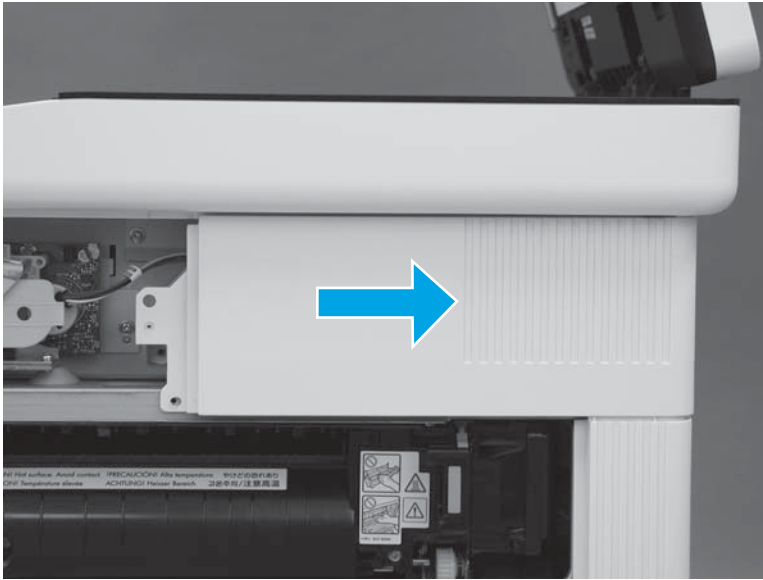

4. Lift the cover away from the printer to remove it.

M577c/f/z only: Release the cables (callout 1) through the slot (callout 2) in the printer.

Figure 1-510 Remove the cover

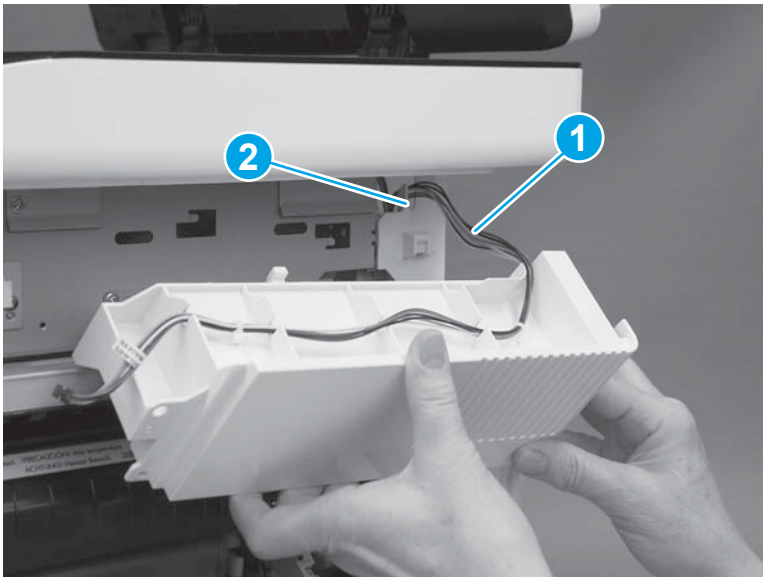

Step 9: Remove the top rear cover (M577)

1. At the top of the printer, remove five screws (callout 1).

Figure 1-511 Remove five screws

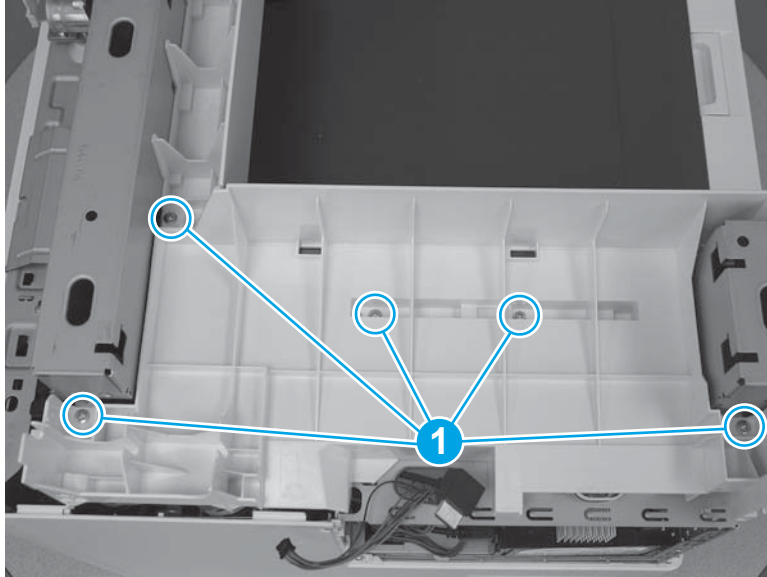

2. Release two tabs (callout 1) on the front edge of the cover.

Figure 1-512 Release two tabs

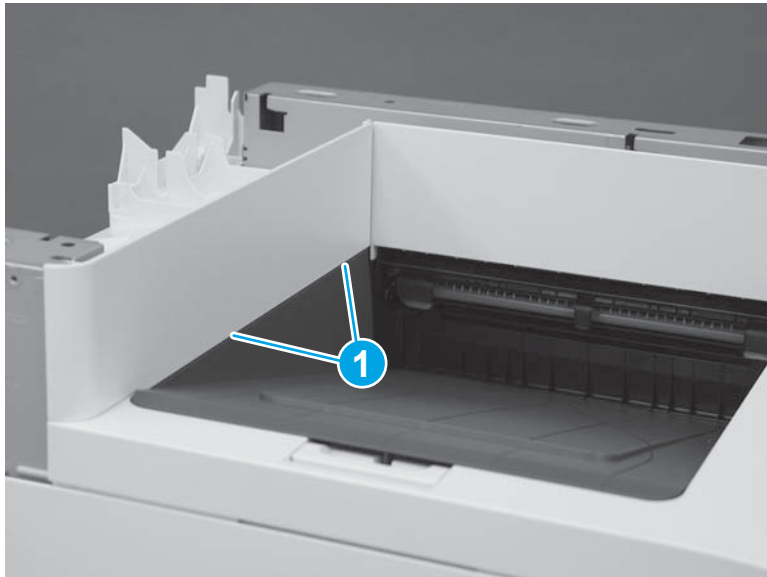

3. Remove the top rear cover.

Figure 1-513 Remove the top rear cover

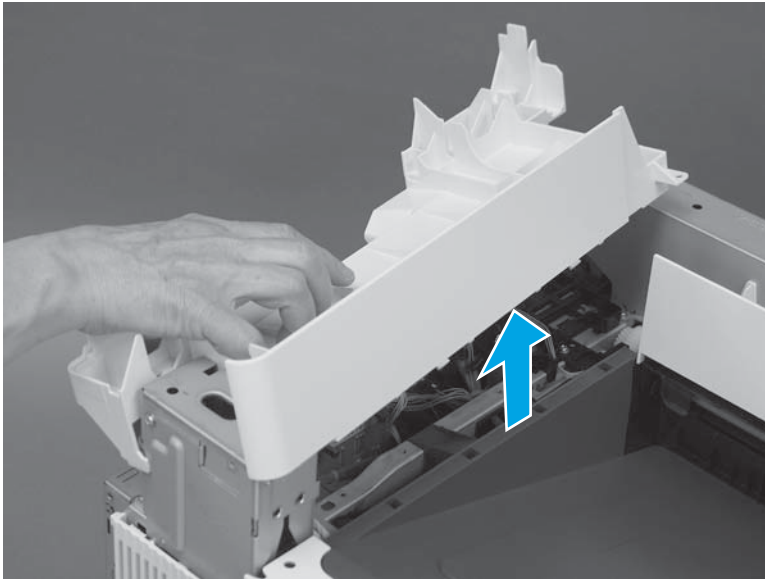

Step 10: Remove the paper feed cover (M577)

1. Remove one screw (callout 1).

Figure 1-514 Remove one screw

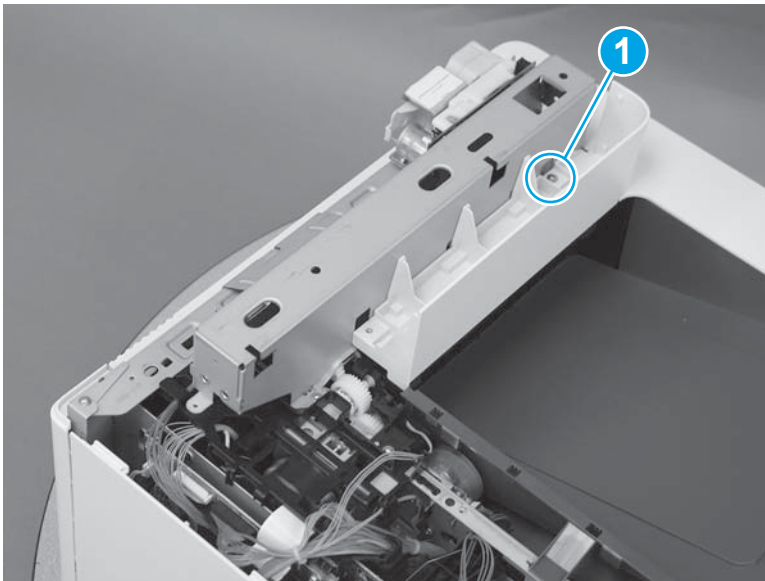

2. Lift the cover up to remove it.

Figure 1-515 Remove the cover

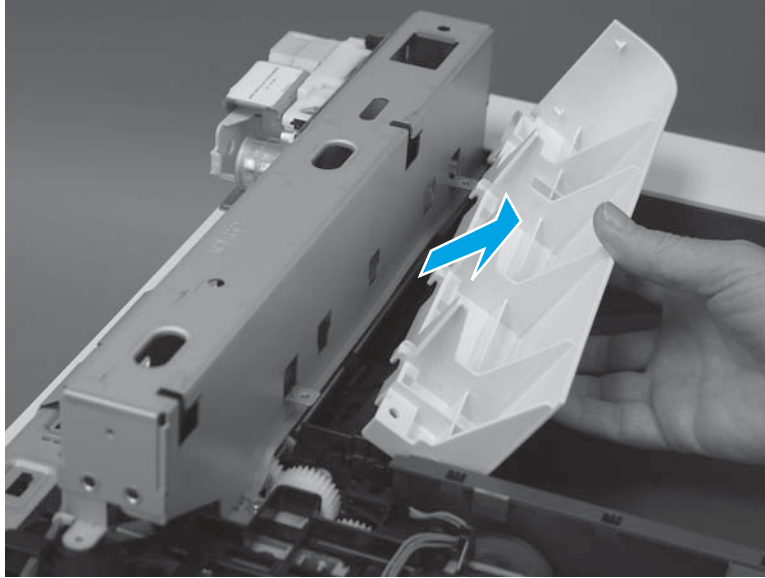

Step 11: Remove the toner collection unit (TCU)

1. Open the front door.

Figure 1-516 Open the front door



2. Open the TCU.

 **NOTE:** The toner collection hatch cover automatically closes when the TCU is opened.

Figure 1-517 Open the TCU



3. Pull the TCU away from the printer at an angle to remove it.

⚠ CAUTION: Do not open the toner collection hatch cover when handling the TCU. If toner gets on clothing, wipe it off by using a dry cloth and wash the clothes in cold water. Hot water sets toner into fabric.

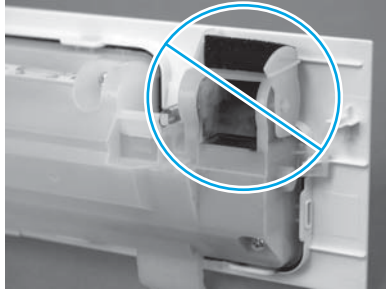
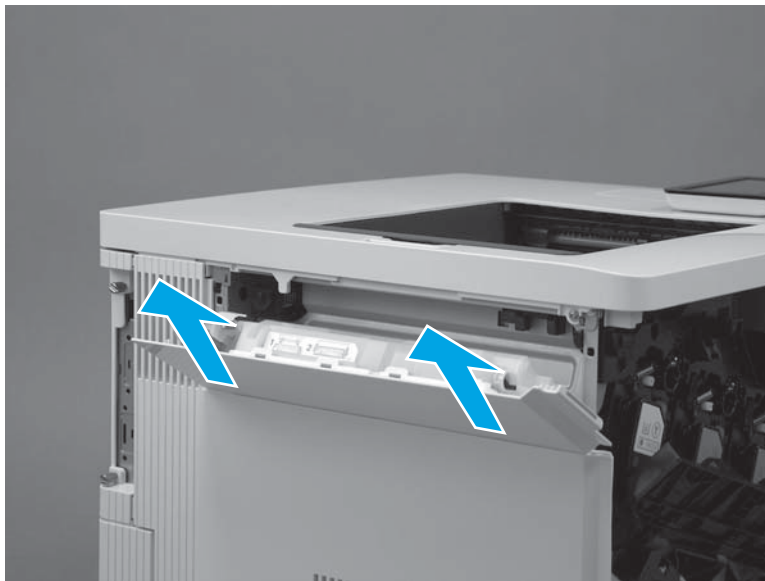

Figure 1-518 Remove the TCU



Step 12: Remove the top cover (M577)

1. At the front of the printer, remove one screw (callout 1).

💡 Reinstallation tip: This screw is longer and a different type of screw than the screw removed in the next step. When reinstalling the top cover, make sure that this screw is installed in the correct position.

Figure 1-519 Remove one screw

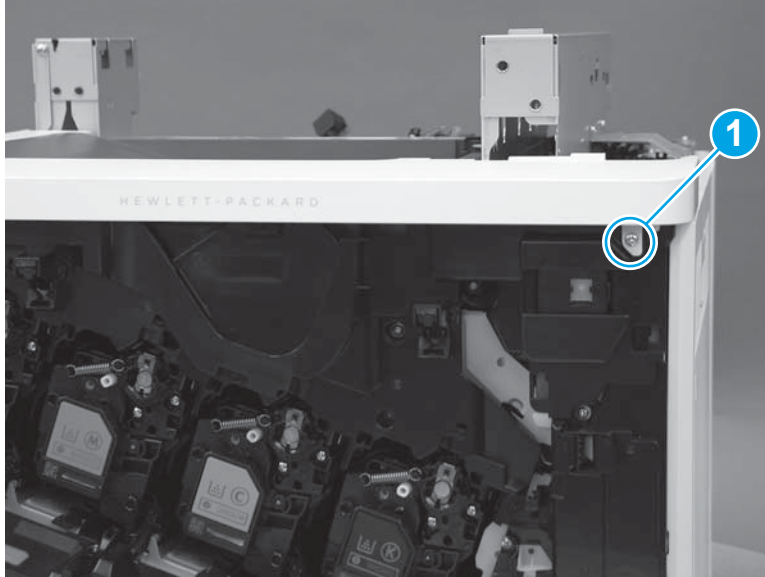

2. At the left side of the printer, remove one screw (callout 1).

Figure 1-520 Remove one screw

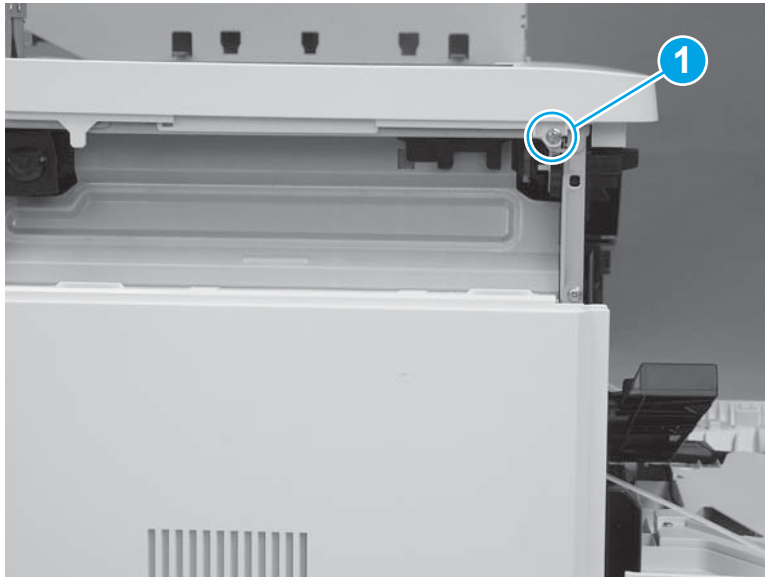

3. At the front of the printer, release one tab (callout 1).

Figure 1-521 Release one tab

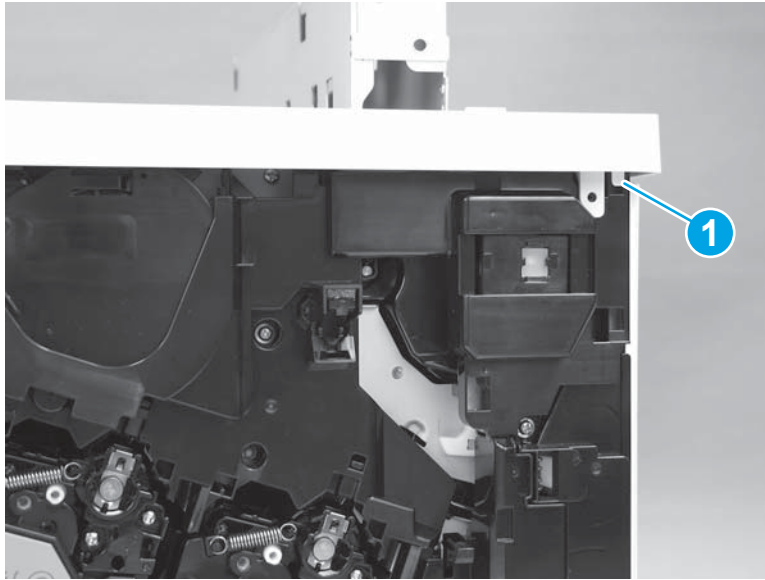

4. At the top of the printer, release two tabs (callout 1) next to the output bin, and then remove the top cover.

Figure 1-522 Release two tabs

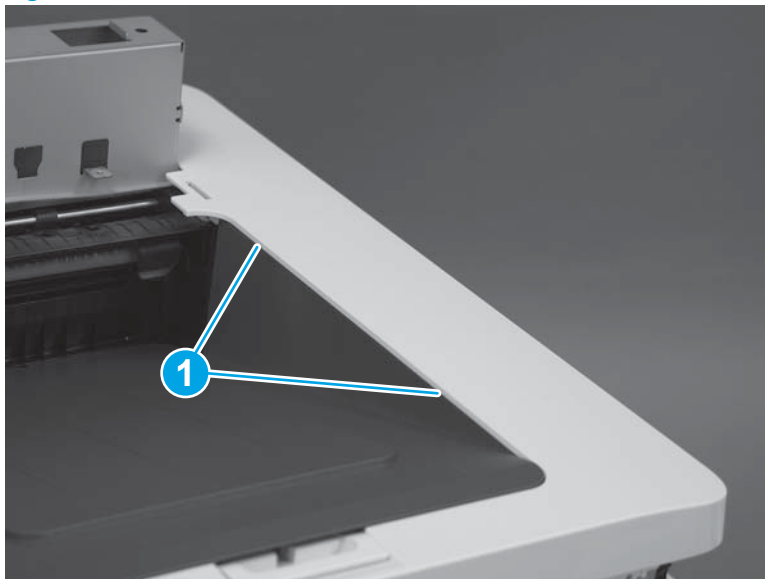

Step 13: Unpack the replacement assembly

Unpack the replacement assembly from the packaging.

For complete information on HP's recycling programs, go to [Product return and recycling](#).

 **NOTE:** HP recommends responsible disposal of the defective assembly.

Figure 1-523 Recycle and unpack

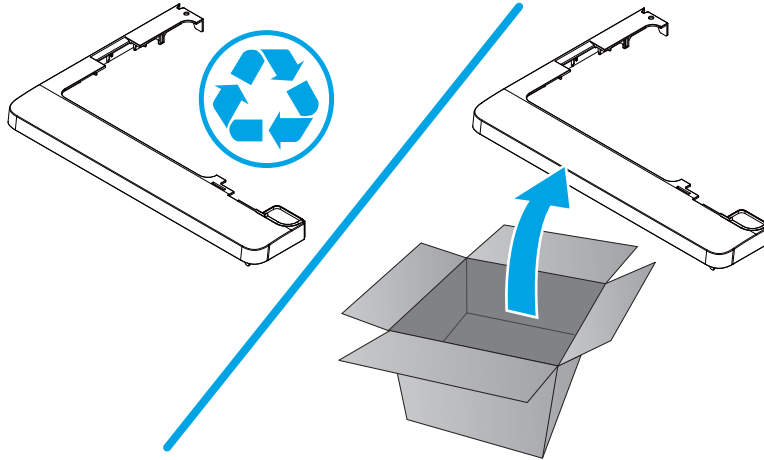

Step 14: Install the top cover

1. Position the locator pins (callout 1) on the cover in the slots (callout 2) in the printer.

Figure 1-524 Position the locator pins

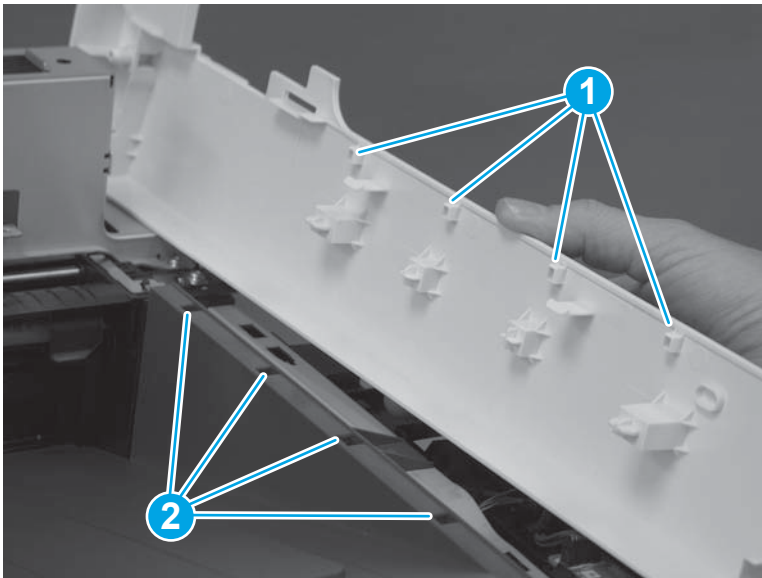

2. Press down on the cover to install it. Make sure that the tabs (callout 1) snap into place.

Figure 1-525 Press down on the cover

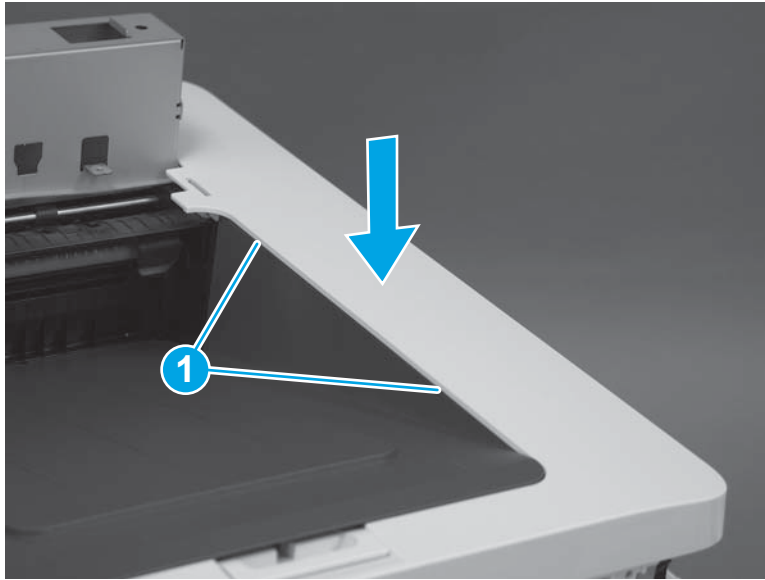

3. At the front of the printer, install one screw (callout 1).

 **Reinstallation tip:** This screw is longer and a different type of screw than the screw installed in the next step. Make sure that this screw is installed in the correct position.

Figure 1-526 Install one screw



4. At the left side of the printer, install one screw (callout 1).

Figure 1-527 Install one screw

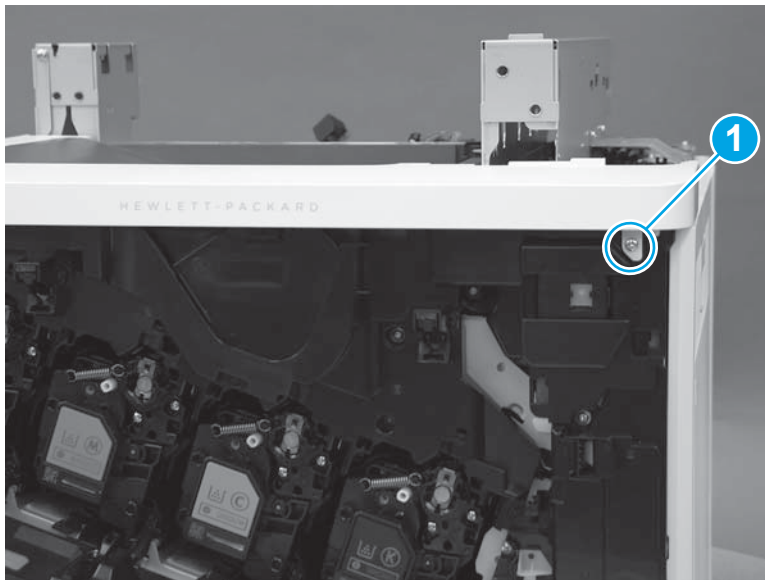
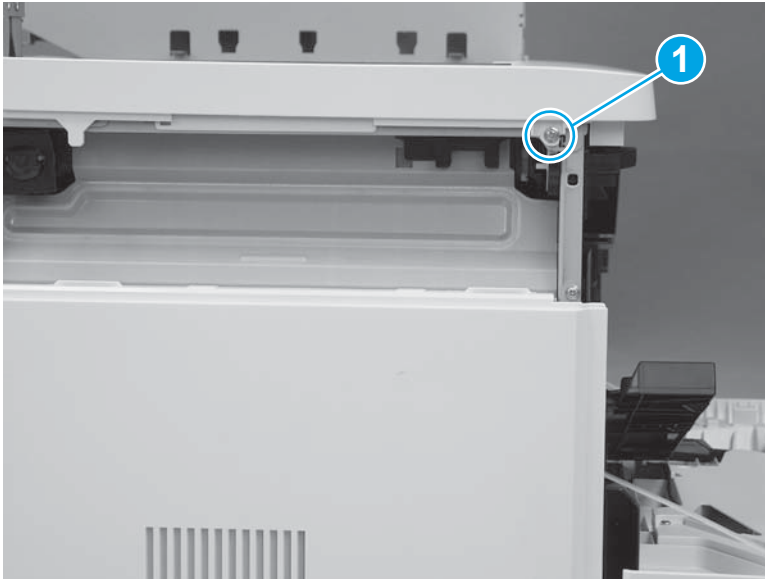

Step 15: Install the toner collection unit (TCU)

1. Verify that the toner collection hatch cover is in the closed position on the TCU.

Figure 1-528 Verify that the toner collection hatch cover is closed

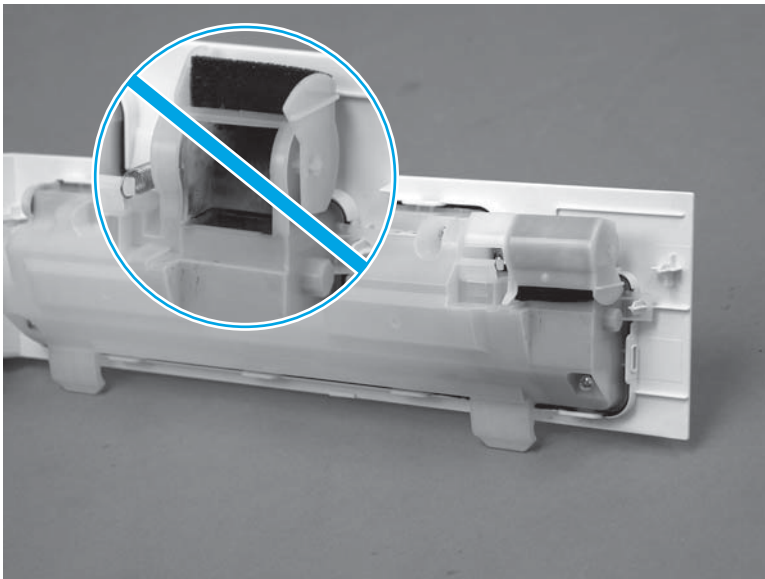

2. Position the TCU with the hinges in the slots provided in the printer (callout 1), and then rotate the TCU up and into the closed position.

 **NOTE:** The toner collection hatch cover automatically opens when the TCU is closed.

Figure 1-529 Install the TCU



3. Close the front door.

Figure 1-530 Close the front door

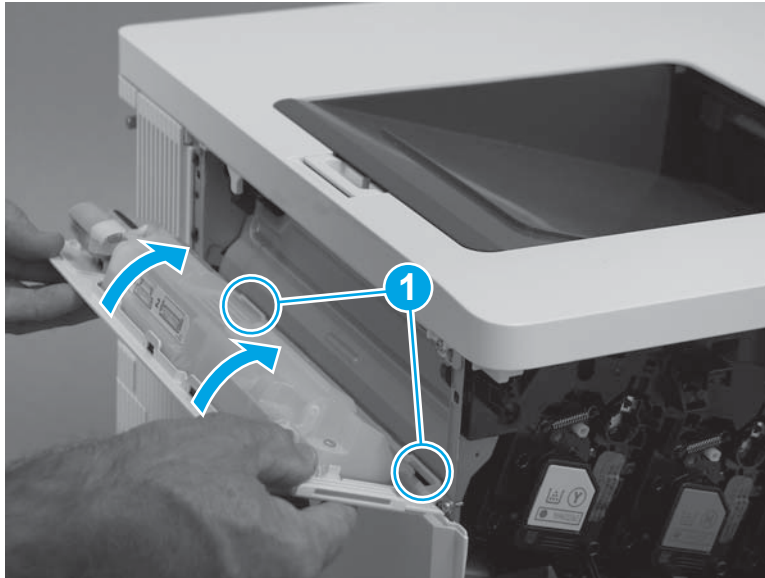

Step 16: Install the paper feed cover

1. Position the locator tabs (callout 1) on the cover in the slots (callout 2) in the printer. Press down until the cover snaps into place.

Figure 1-531 Install the cover

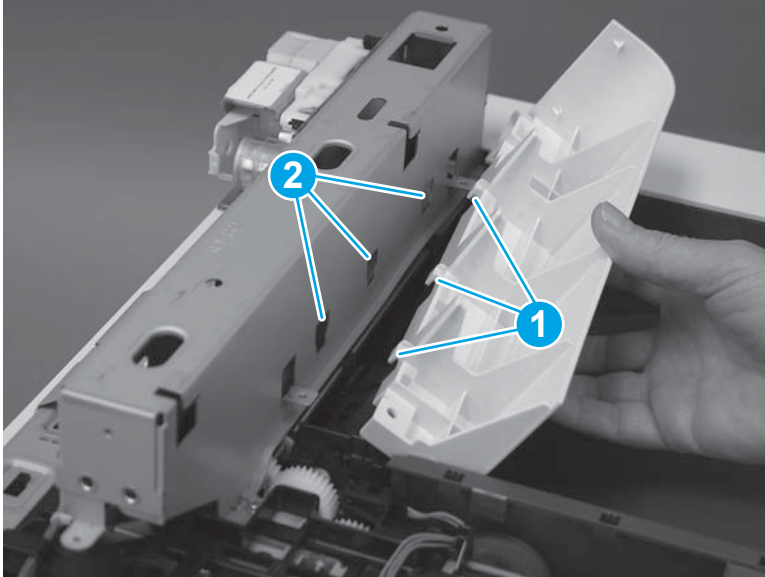

2. Install one screw (callout 1).

Figure 1-532 Install one screw

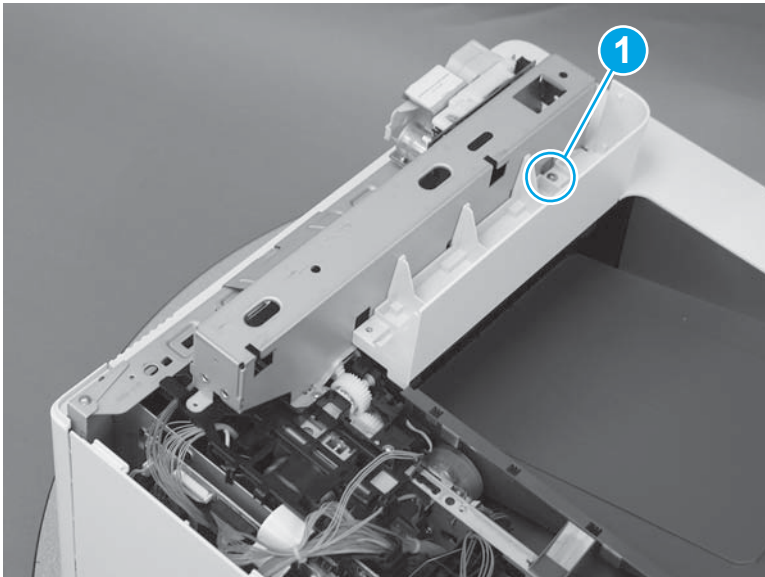

Step 17: Install the top rear cover

1. Align the locator tabs (callout 1) on the cover with the slots (callout 2) in the printer.

Figure 1-533 Align the locator tabs

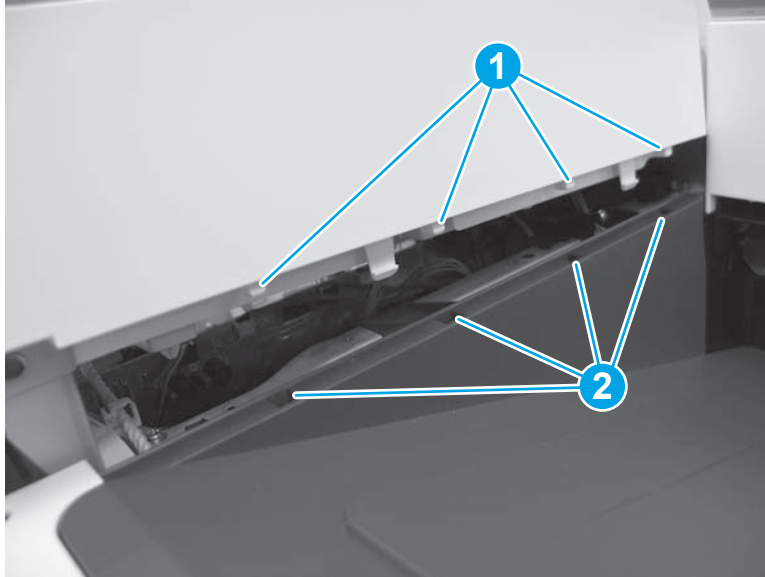

2. Press down to install the cover. Make sure that the tabs snap into place.

Figure 1-534 Install the cover

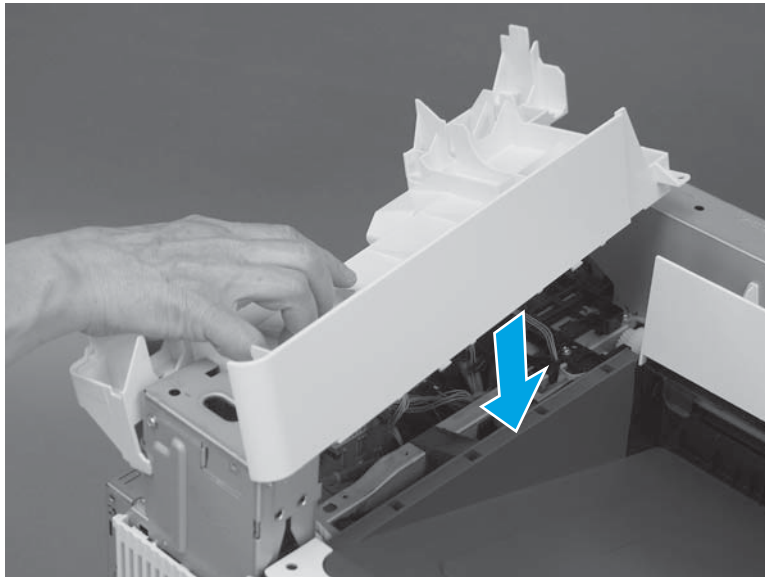

3. At the top of the printer, install five screws (callout 1).

Figure 1-535 Install five screws

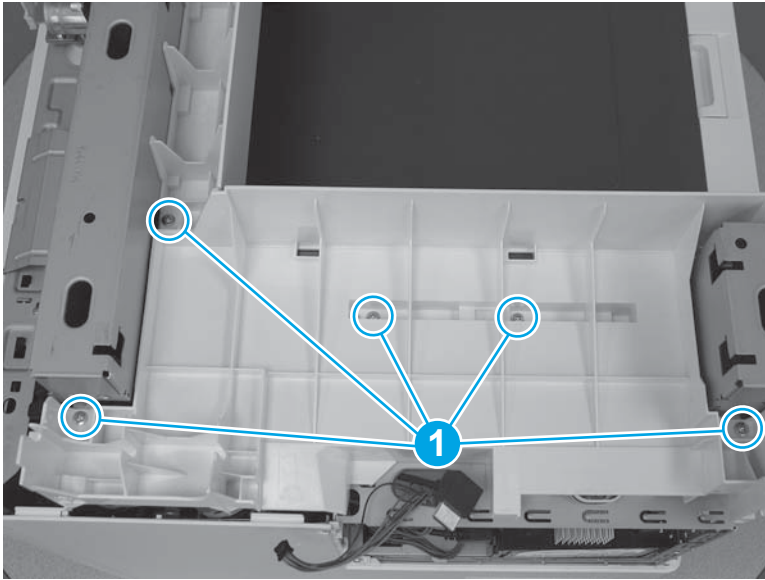

Step 18: Install the right upper cover (M577)



NOTE: The figures below show the image scanner installed. The procedures for removing and installing the right upper cover are the same whether the image scanner is installed or removed."

1. **M577c/f/z only:** Install the cables (callout 1) through the slot (callout 2) in the printer.

Figure 1-536 Install the cables

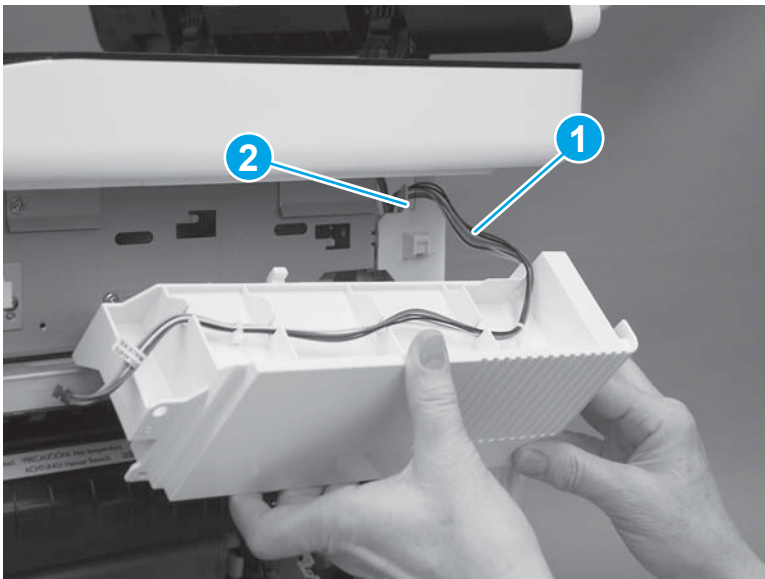

2. Position the hooks (callout 1) on the cover in the slots (callout 2) in the printer.

Figure 1-537 Position the hooks

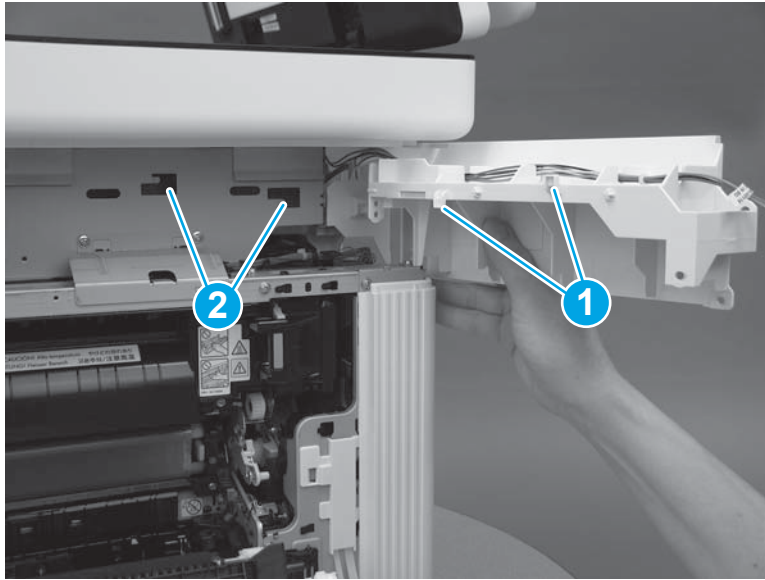

3. Slide the cover toward the front of the printer to install it.

Figure 1-538 Install the cover

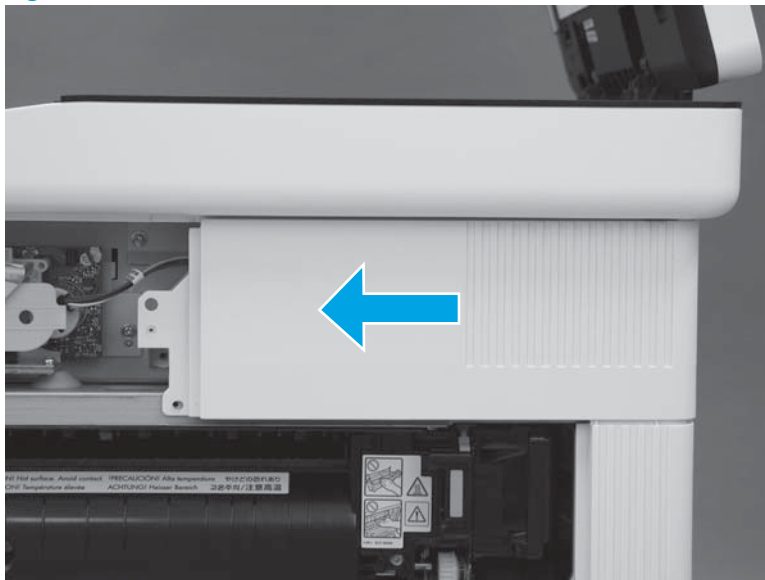

4. At the back of the printer, install one screw (callout 1).

M577c/f/z only: Connect one connector (callout 2), if the integrated scanner assembly is installed.

TIP: This screw is smaller than the screws installed in the next step. Make sure that this screw is installed in the correct position.

Figure 1-539 Install one screw and connector



5. At the right side of the printer, install two screws (callout 1).

M577c/f/z only: Connect one connector (callout 2), if the stapler is installed.

Figure 1-540 Install one screw and connector

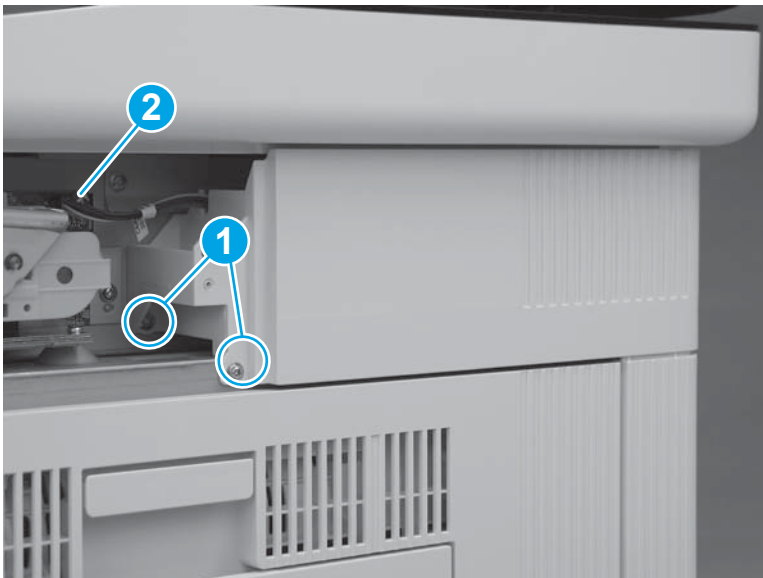

Step 19: Install the stapler unit (M577c/f/z)

1. Position the hooks (callout 1) on the stapler unit in the slots (callout 2) in the printer.

Figure 1-541 Position the hooks in the slots

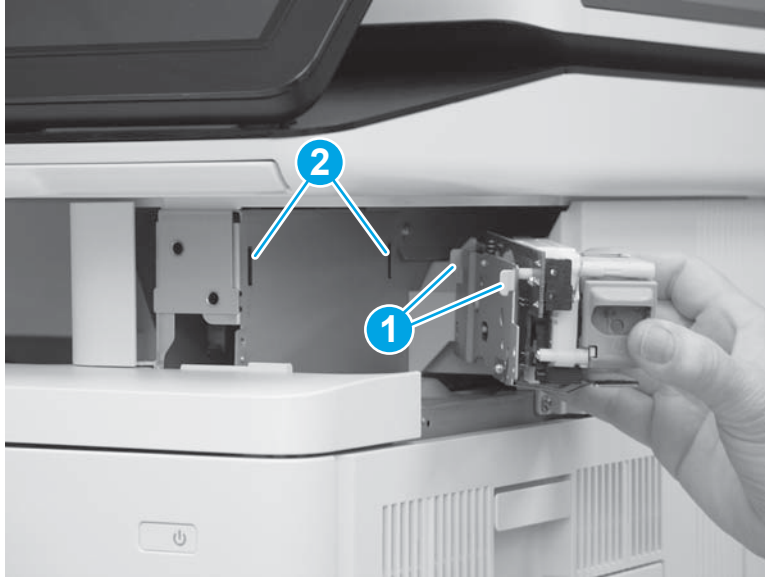

2. Connect one connector (callout 1), and then install two screws (callout 2).

Figure 1-542 Connect connector and install screws

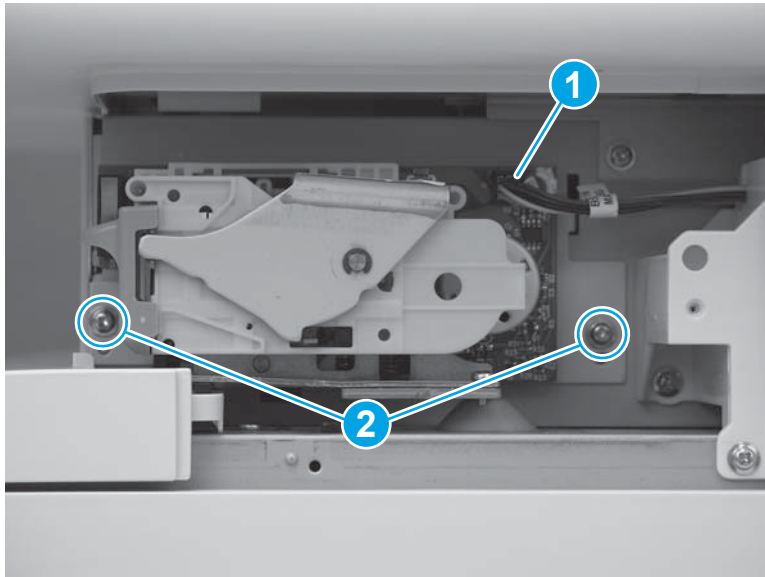

Step 20: Install the integrated scanner assembly (ISA) (M577)

 **NOTE:** The ISA includes the document feeder, image scanner, scanner control board (SCB), control panel, keyboard (M577c/z) and NFC PCA (M577z).

1. Before proceeding, locate the mounting pins (callout 1) on the bottom of the ISA and the slots (callout 2) on the printer base.

Figure 1-543 Locate the ISA mounting pins and slots

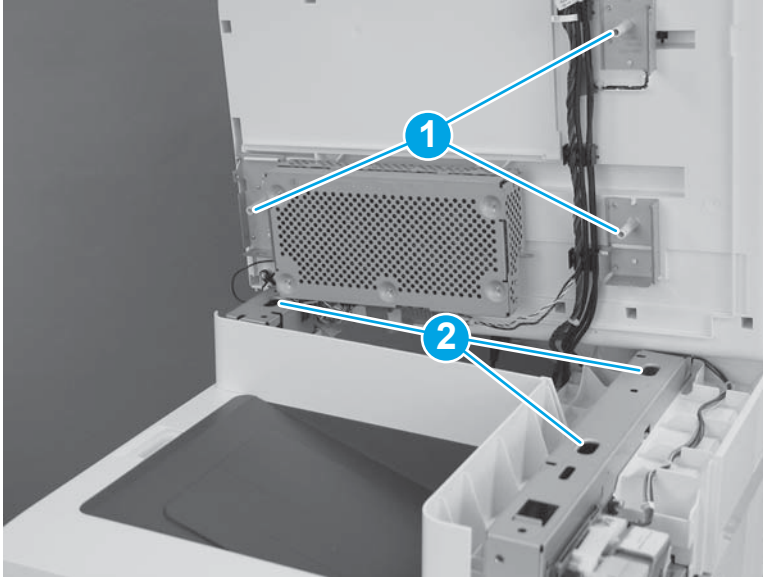

2. Position the ISA on the printer base with the pins in the slots.



NOTE: To locate the pins and slots, see [Figure 1-395 Locate the ISA mounting pins and slots on page 250](#).

Figure 1-544 Install the ISA



3. Slightly slide the ISA towards the front of the printer to engage it.

Figure 1-545 Slide the ISA towards the front of the printer

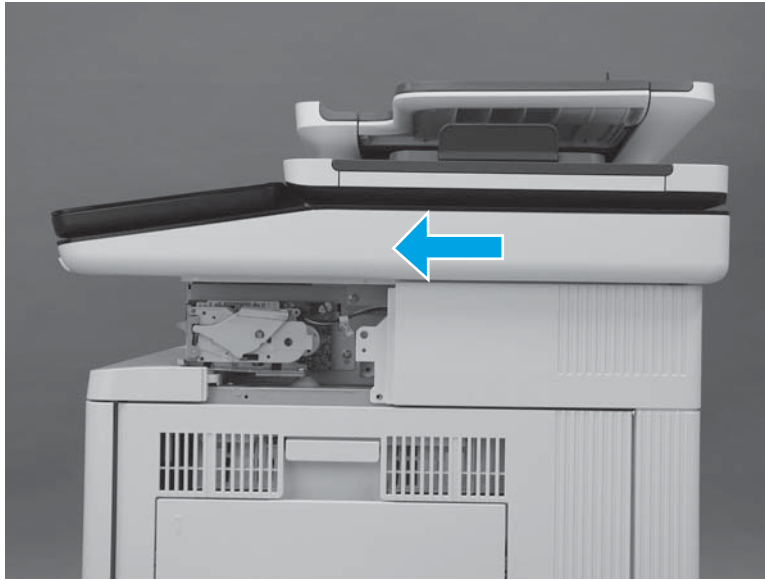

4. At the left side of the printer, install one screw (callout 1).

Figure 1-546 Install one screw

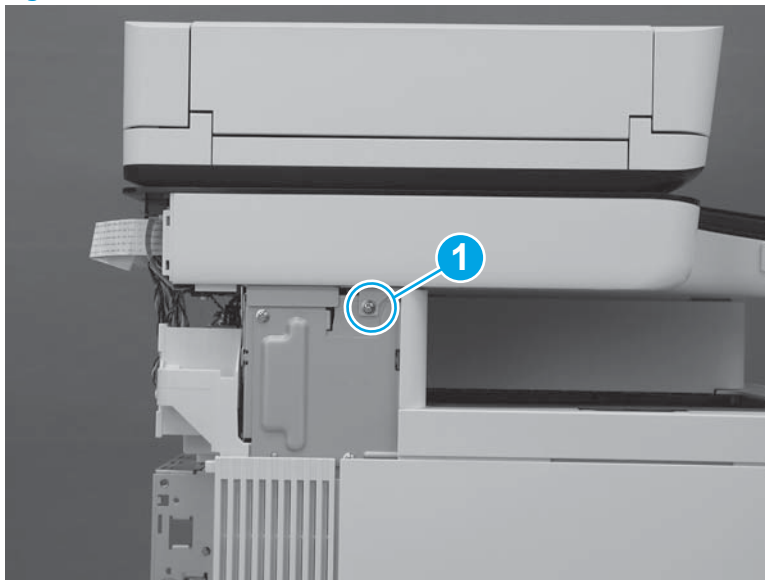

5. At the back of the printer, install two screws (callout 1).

Figure 1-547 Install two screws

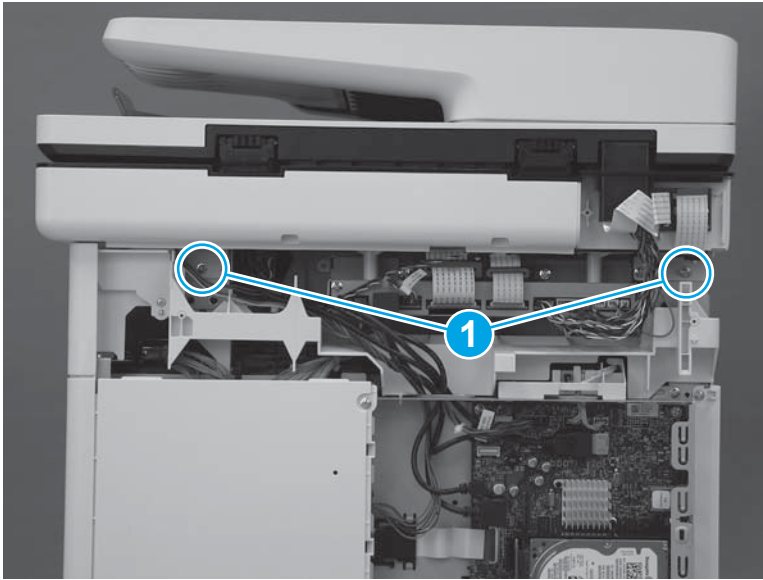

6. At the right side of the printer, install one screw (callout 1).

Figure 1-548 Install one screw

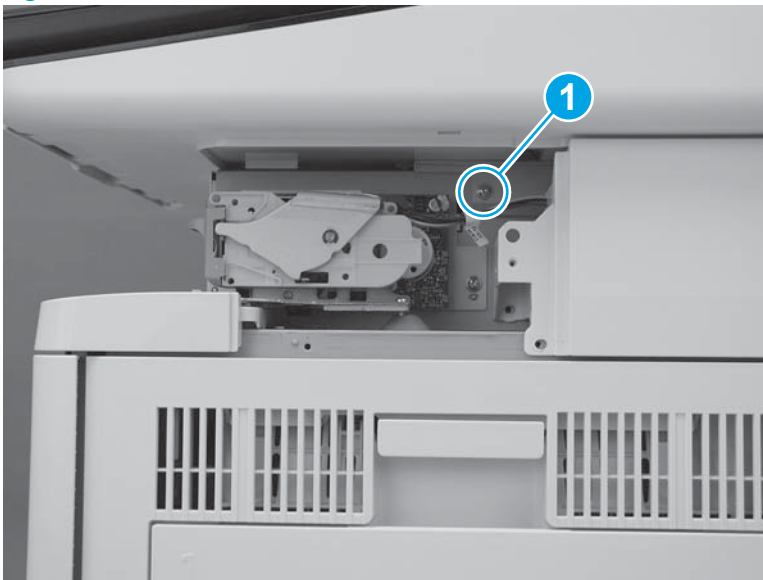

7. Connect two connectors on the scanner control board (callout 1).

M577c/f/z only: Connect one connector for the stapler on the scanner control board (callout 2).

Figure 1-549 Connect connectors

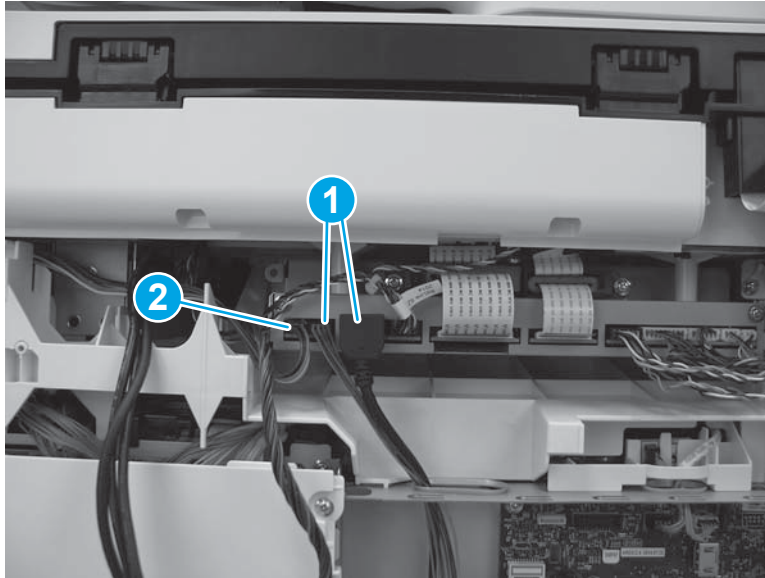

8. Install the wire harness and cables (callout 1) in the retainers (callout 2). Pass them through the opening in the top of the formatter cover (callout 3), and then connect four connectors (callout 4) on the formatter.

Figure 1-550 Connect four connectors

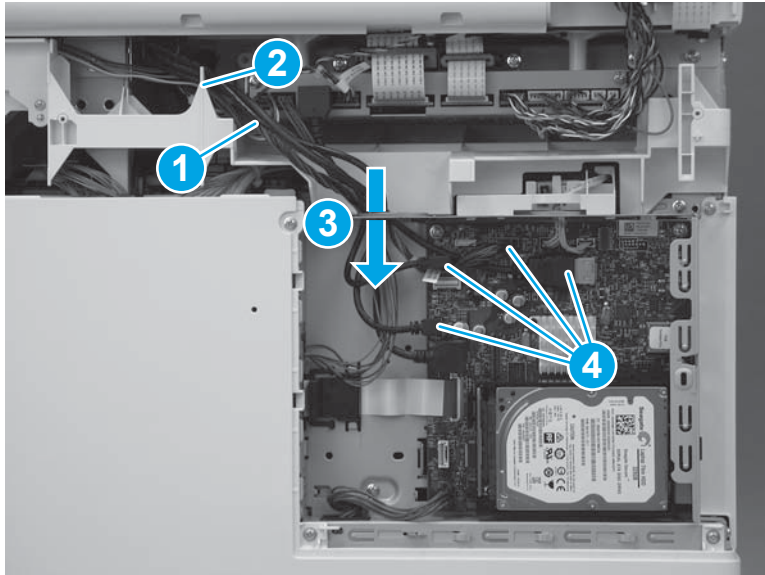

Step 21: Install the stapler cover assembly (M577c/f/z)

 **NOTE:** This step is for the M577c/f/z models only. For the M577dn model, skip this step and go to [Step 22: Install the right front upper cover \(M577dn\) on page 333.](#)

1. Install the tabs (callout 1) on the cover in the slots (callout 2) in the printer.

Figure 1-551 Install two tabs



2. Press the cover toward the left side of the printer until it snaps into place.

Figure 1-552 Install the cover assembly



3. Install one screw (callout 1).



 **IMPORTANT:** This is a self-tapping screw for plastic. Rotate it counterclockwise to align it with the existing thread pattern, and then carefully turn it clockwise to tighten. Do not overtighten. This will prevent stripping the threads inside the screw hole.

Figure 1-553 Install one screw

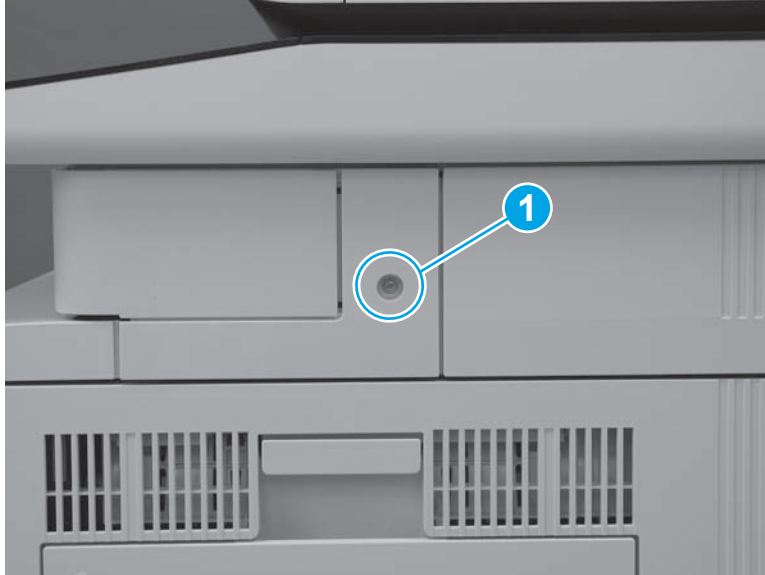

Step 22: Install the right front upper cover (M577dn)

 **NOTE:** This step is for the M577dn model only. For the M577c/f/z models, skip this step and go to [Step 23: Install the left upper cover on page 334](#).

1. Slide the cover toward the left side of the printer to install it. Make sure that the slots (callout 1) in the cover fit over the tabs (callout 2) on the inside of the paper feeder cover.

Figure 1-554 Install the cover

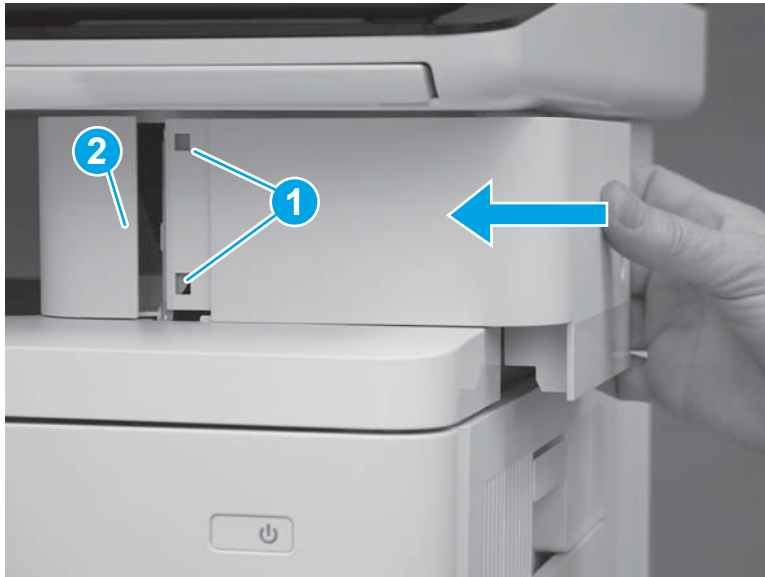

2. Press the right front upper cover (callout 1) and the paper feeder cover (callout 2) together until the tabs on the inside of the covers snap into place.

Figure 1-555 Press the cover



3. Install one screw (callout 1).

Figure 1-556 Install one screw

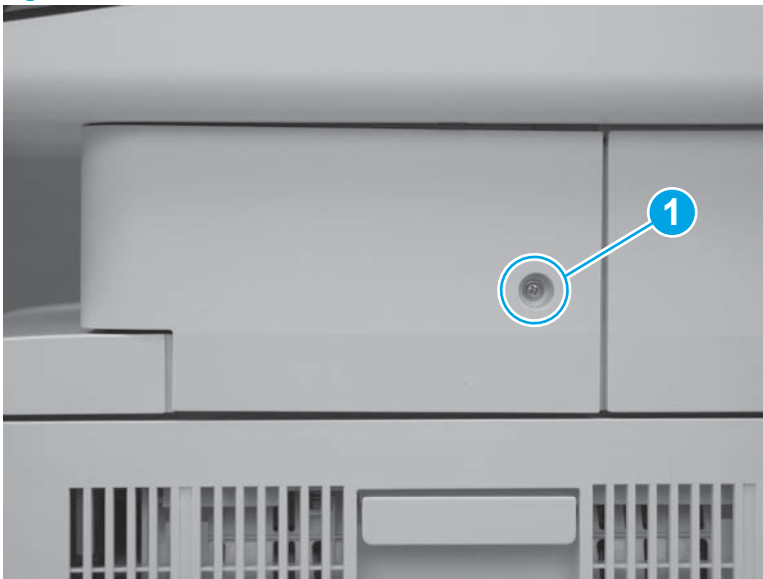

Step 23: Install the left upper cover

1. Position the tab (callout 1) on the lower edge of the cover behind the left cover (callout 2).

Figure 1-557 Position the tab

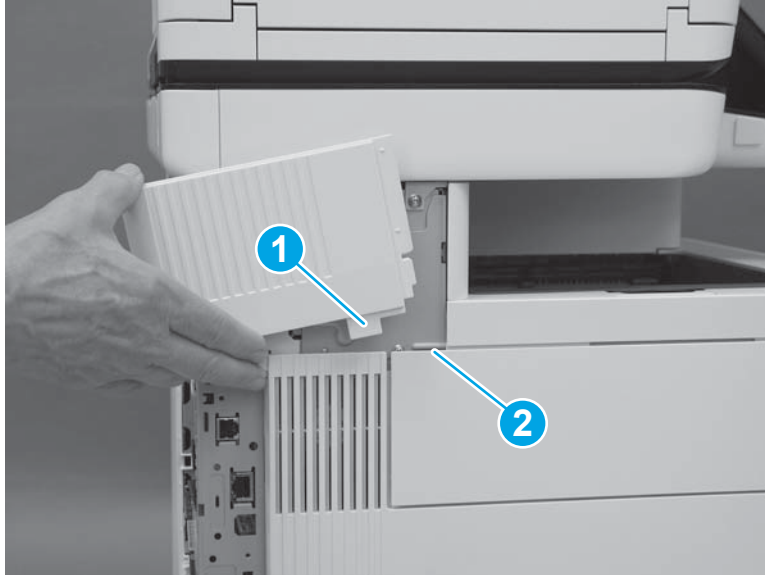

2. Slide the cover toward the front of the printer to install it. Make sure that the edge (callout 1) of the cover fits behind the edge (callout 2) of the top rear cover.

Figure 1-558 Slide the cover

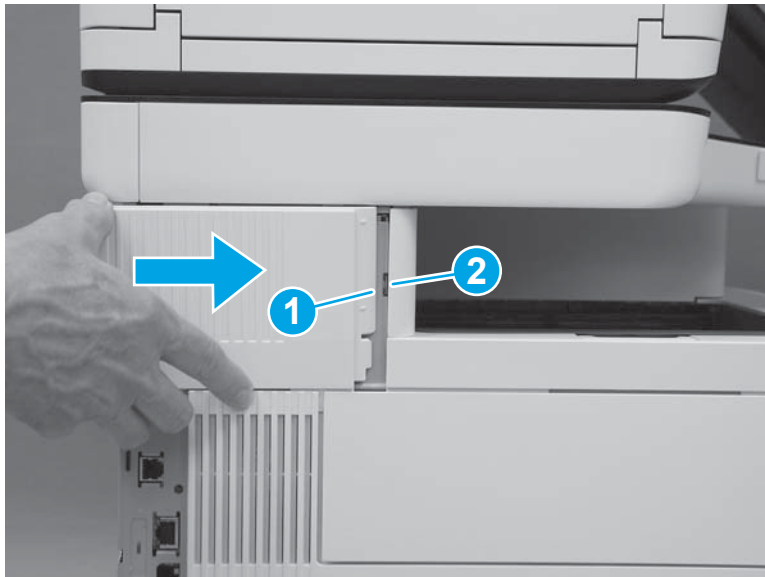

3. Make sure that the tab (callout 1) is fully installed.

Figure 1-559 Check the tab

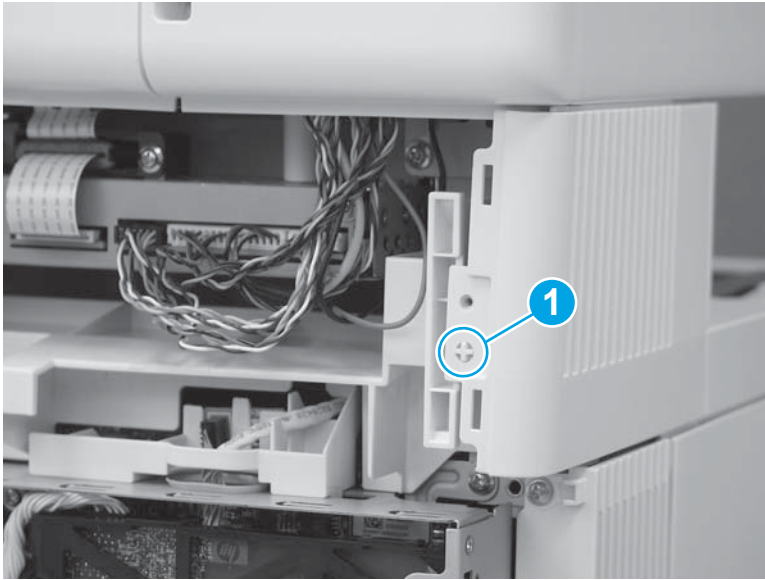

Step 24: Install the rear upper cover

1. Align the ridge (callout 1) on the lower edge of the rear upper cover in front of the tabs (callout 2) on the top edge of the rear cover.

Figure 1-560 Align the cover

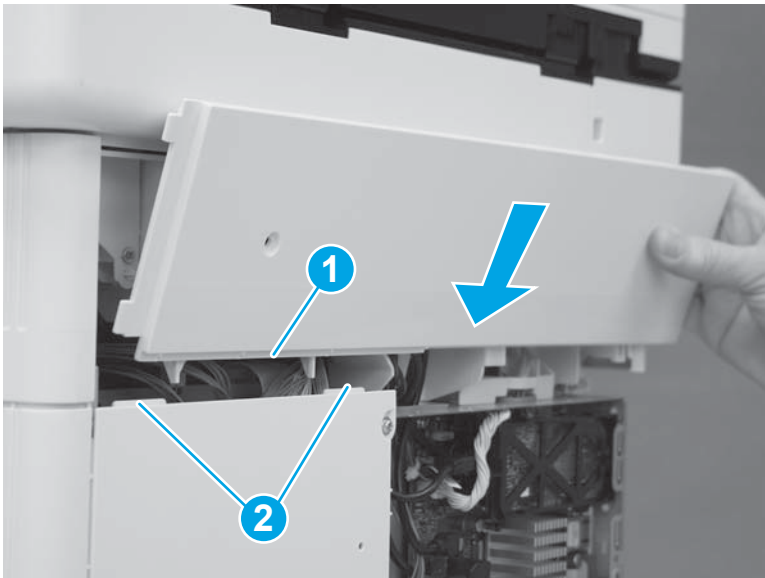

2. Rotate the top of the cover toward the printer.

Figure 1-561 Rotate the top of the cover

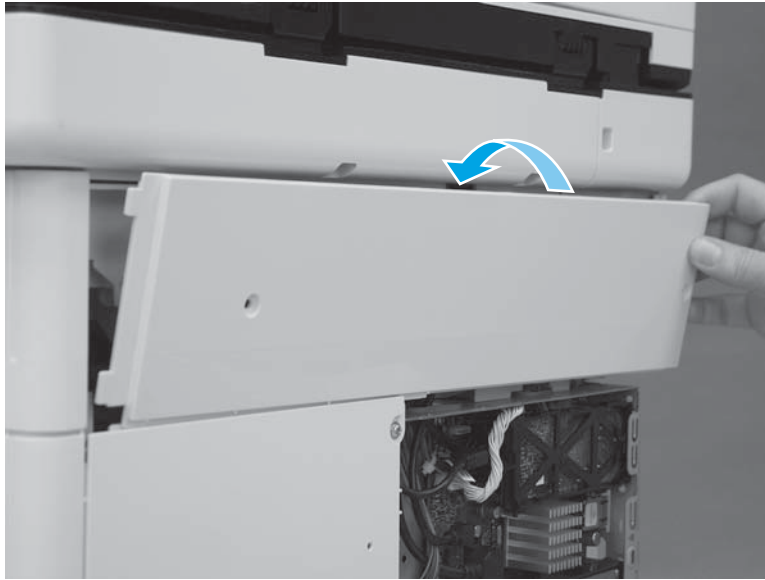

3. Slide the cover to the left (callout 1). Make sure that the tabs (callout 2) on the upper rear cover slide behind the edge (callout 3) of the right upper cover. Make sure that the cover is fully seated.

Figure 1-562 Slide the cover

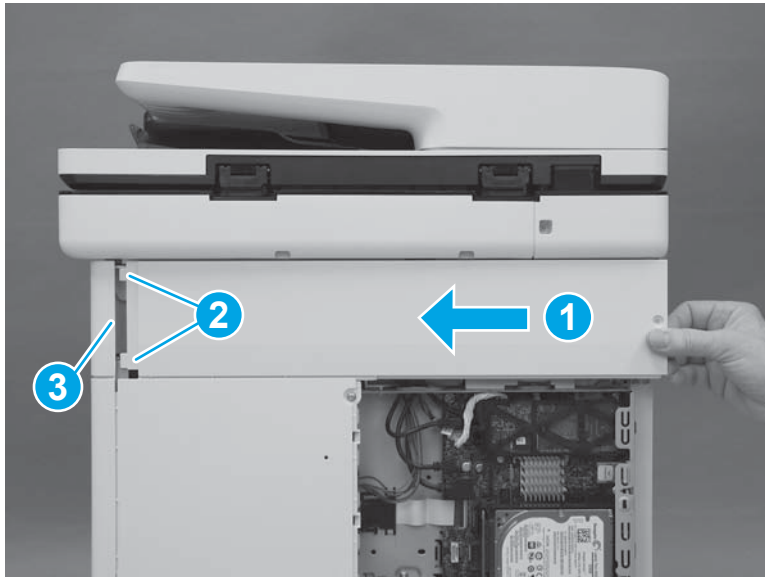

4. Install two screws (callout 1).



 **IMPORTANT:** These two screws are self-tapping screws for plastic. Rotate them counterclockwise to align them with the existing thread pattern, and then carefully turn them clockwise to tighten. Do not overtighten. This will prevent stripping the threads inside the screw holes.

Figure 1-563 Install two screws

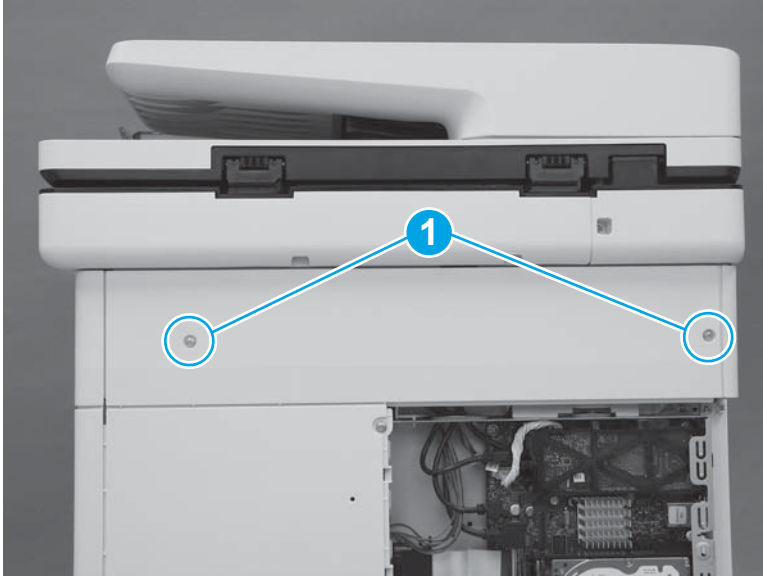

Step 25: Install the formatter cover

- ▲ Slide the cover onto the printer (callout 1) to install it.

 **NOTE:** Make sure that the tabs on the formatter cover align with the slots provided in the printer (callout 2). Tighten the two thumbscrews (callout 3).

 **TIP:** If needed, use the edge of a coin to turn the thumbscrews.

Figure 1-564 Install the cover



Removal and replacement: Right door

- [Introduction](#)
- [Step 1: Remove the right door](#)
- [Step 2: Unpack the replacement assembly](#)
- [Step 3: Install the right door](#)

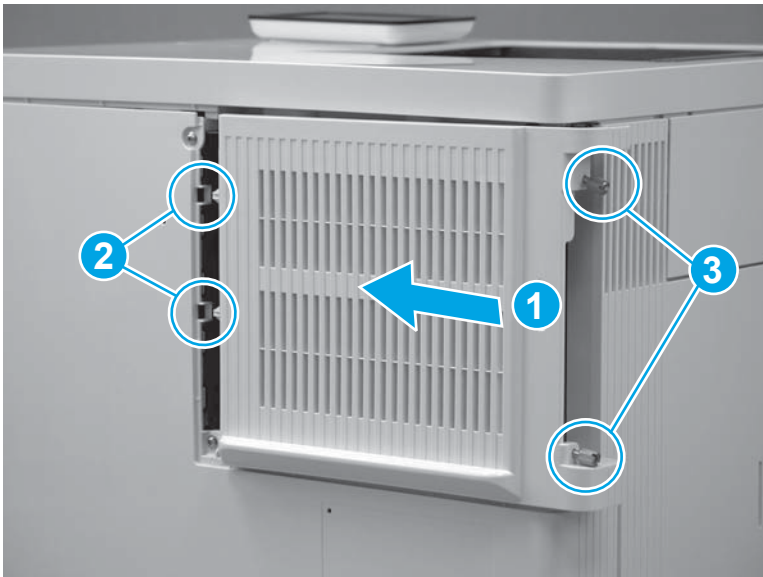
Introduction

This document provides the procedures to remove and replace the right door.

Before performing service

Turn the printer power off

- Disconnect the power cable.

 **WARNING!** To avoid damage to the printer, turn the printer off, wait 30 seconds, and then remove the power cord before attempting to service the printer.

Use the table below to identify the correct part number for your printer. To order the part, go to www.hp.com/buy/parts.

Right door part number	
RM2-0019-000CN	Right door

Required tools

- Small flat blade screwdriver
- #2 Phillips screwdriver with a magnetic tip

After performing service

Make sure that the right door closes correctly after replacing it.

Turn the printer power on

- Connect the power cable.
- Use the power switch to turn the power on.

Step 1: Remove the right door

1. Use the handle (callout 1) to open the right door.

Figure 1-565 Open the right door

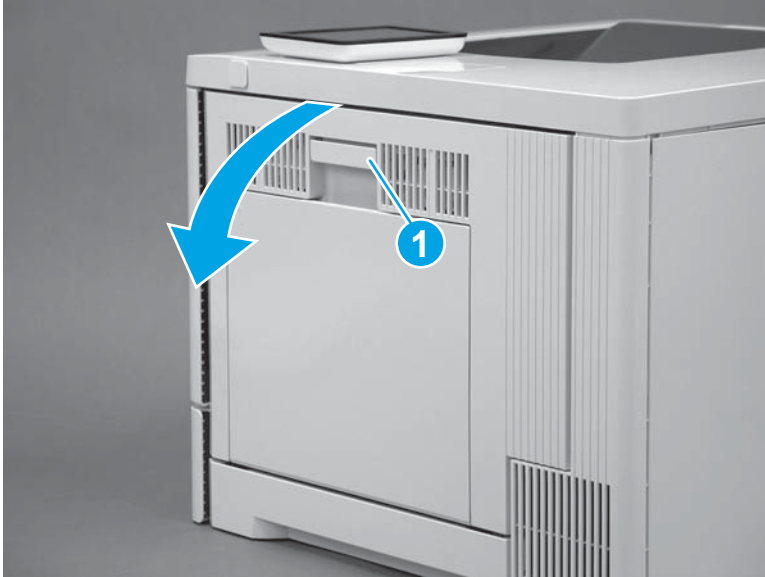

2. Rotate the secondary transfer assembly up and into the printer to move it out of the way.

Figure 1-566 Rotate the secondary transfer assembly up

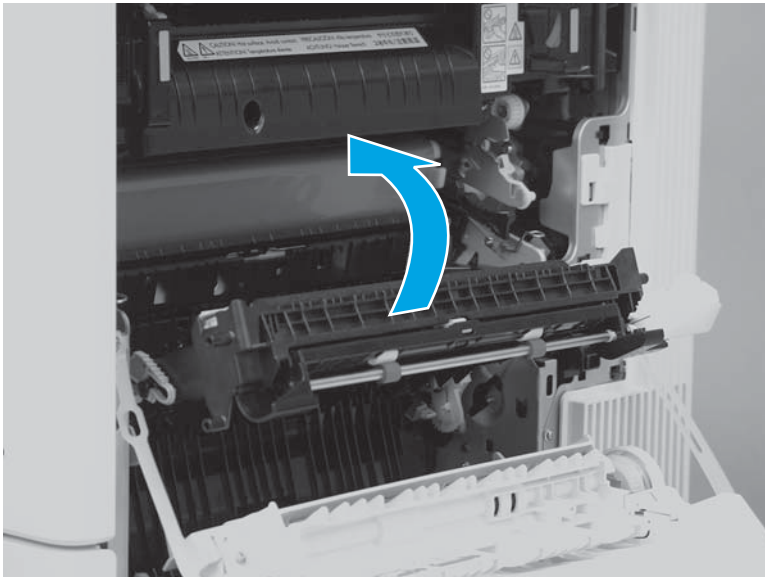

3. At the right- and left-side of the door, use a small flat blade screwdriver to release the door retainer straps (callout 1), and then pull them through the slot in the door.

Figure 1-567 Release the door retainer straps

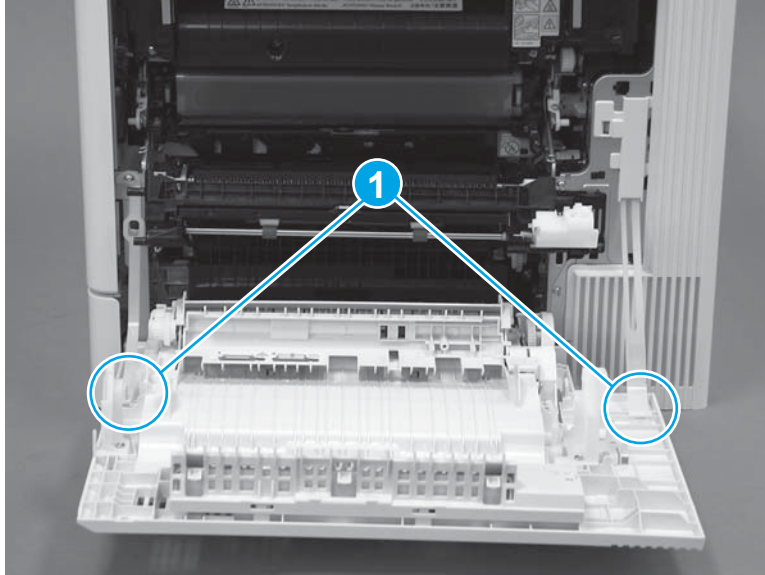

4. Locate a slot (callout 1) near the gear side of the door, push the blade of a small screwdriver into the slot (callout 2) to release one tab, and then rotate the end of the screwdriver down (callout 3) release the connector cover (callout 4).

Figure 1-568 Release the connector cover

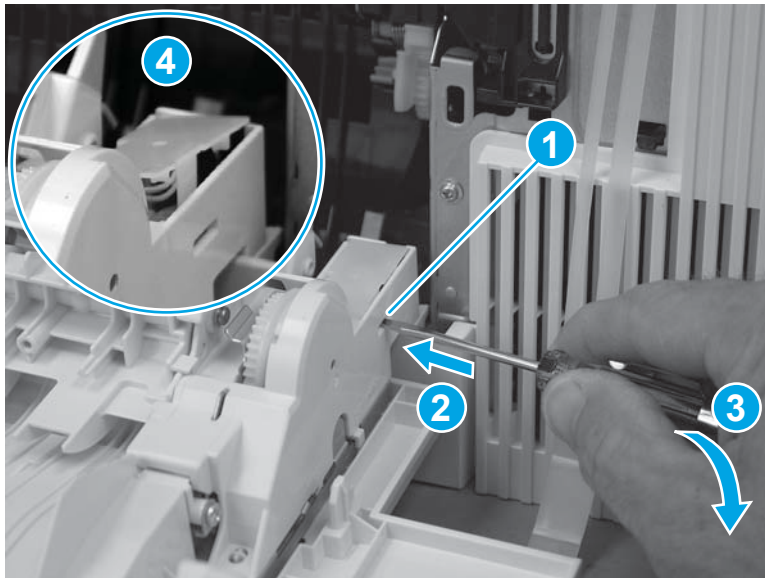

5. Remove the connector cover.

Figure 1-569 Remove the connector cover

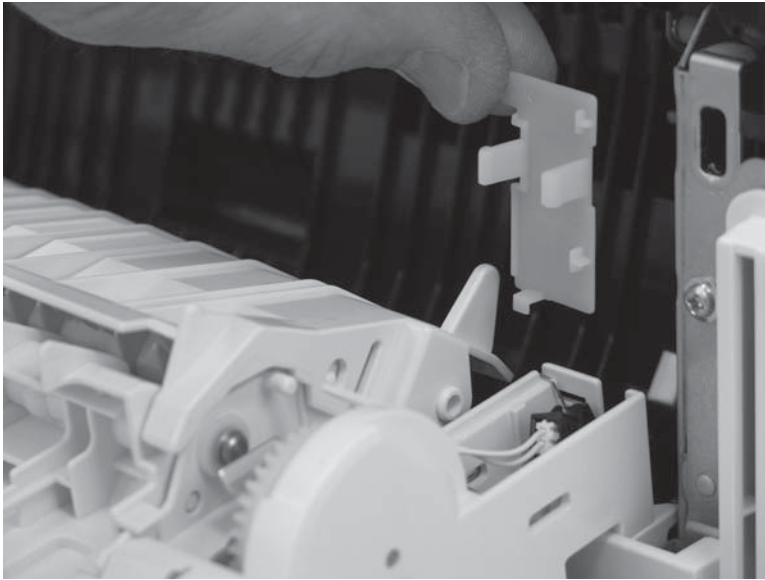

6. Disconnect two connectors (callout 1).

Figure 1-570 Disconnect two connectors

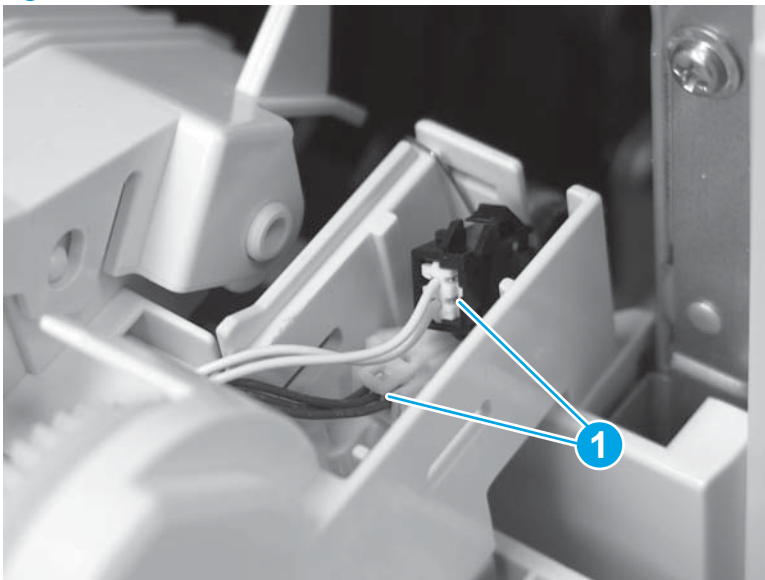

7. Remove two screws (callout 1) to release the door arm (callout 2).

 **NOTE:** The door arm is spring loaded. Keep a firm grip on it while removing the screws, and then carefully move it up and into the printer.

Figure 1-571 Remove two screws



8. Slide the door toward the front of the printer (callout 1) to release it, and then lift it up (callout 2) to remove it.

Figure 1-572 Remove the door

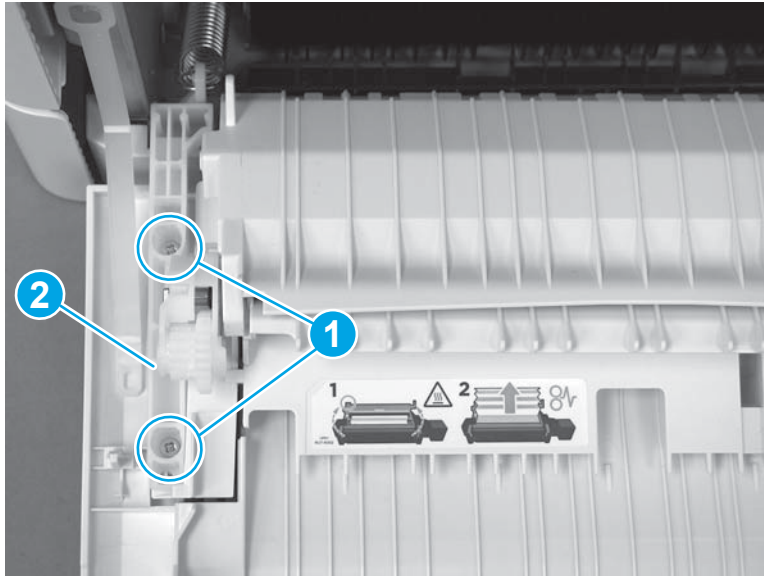
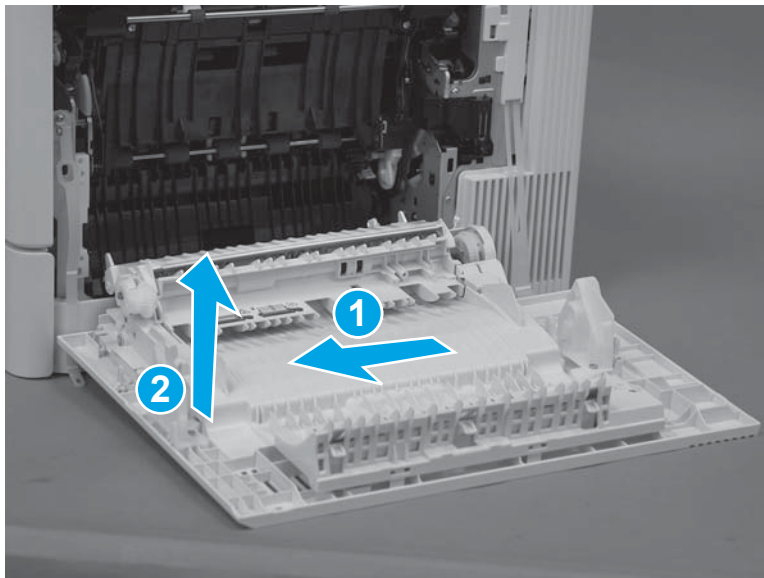

Step 2: Unpack the replacement assembly

Unpack the replacement assembly from the packaging.

For complete information on HP's recycling programs, go to [Product return and recycling](#).

 **NOTE:** HP recommends responsible disposal of the defective assembly.

Figure 1-573 Recycle and unpack

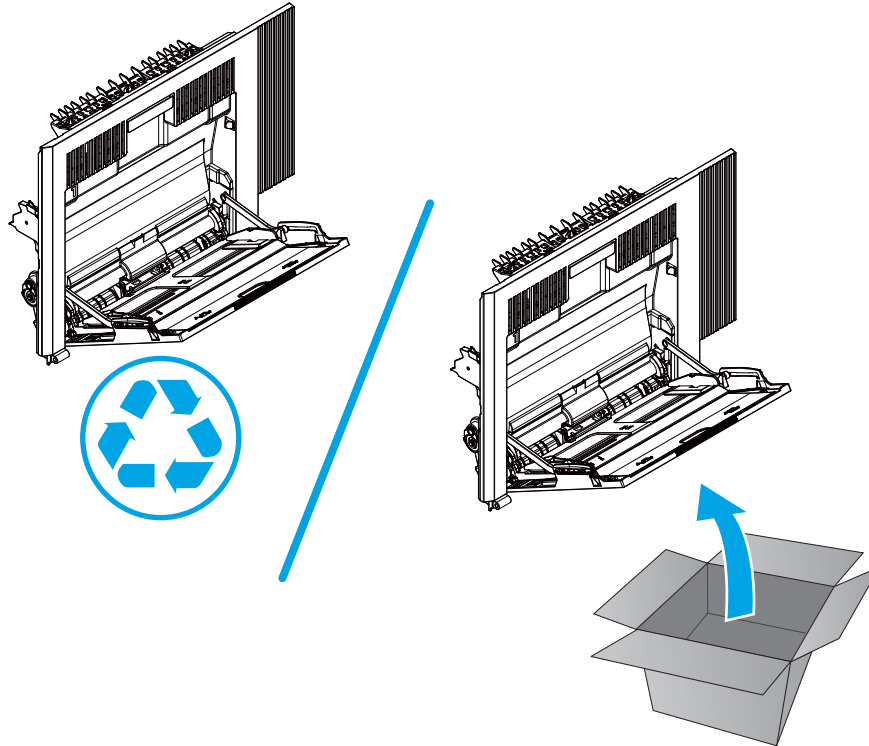

Step 3: Install the right door

1. Position the door on the printer, and then slide it toward the rear of the printer to engage the hinge pin (callout 1).

Figure 1-574 Install the door

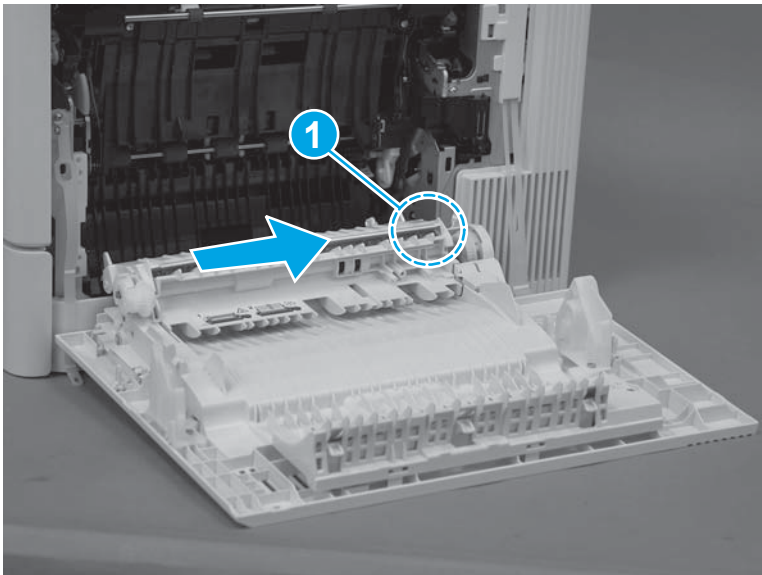

2. Rotate the door arm down onto the door.

 **NOTE:** The door arm is spring loaded. Keep a firm grip on it.

Figure 1-575 Rotate the door arm down

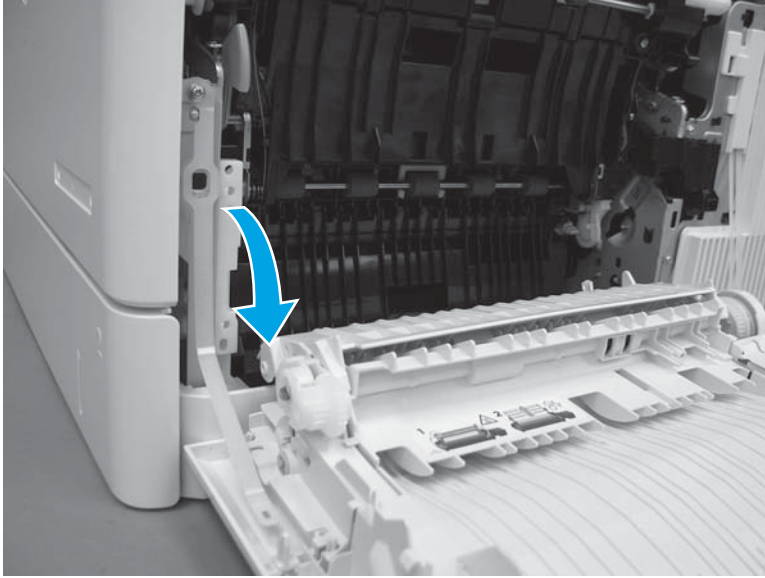

3. Install two screws (callout 1) to fasten the door arm (callout 2) to the door.

Figure 1-576 Install two screws

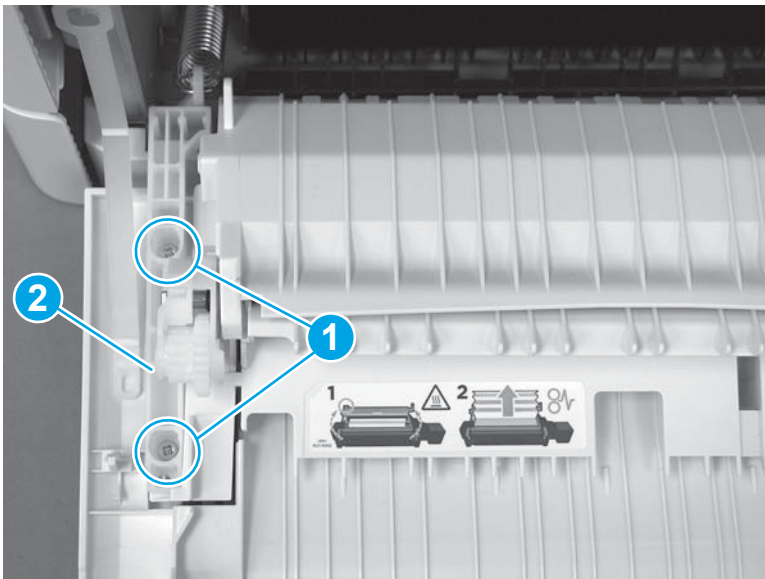

4. Connect two connectors (callout 1).

Figure 1-577 Connect two connectors

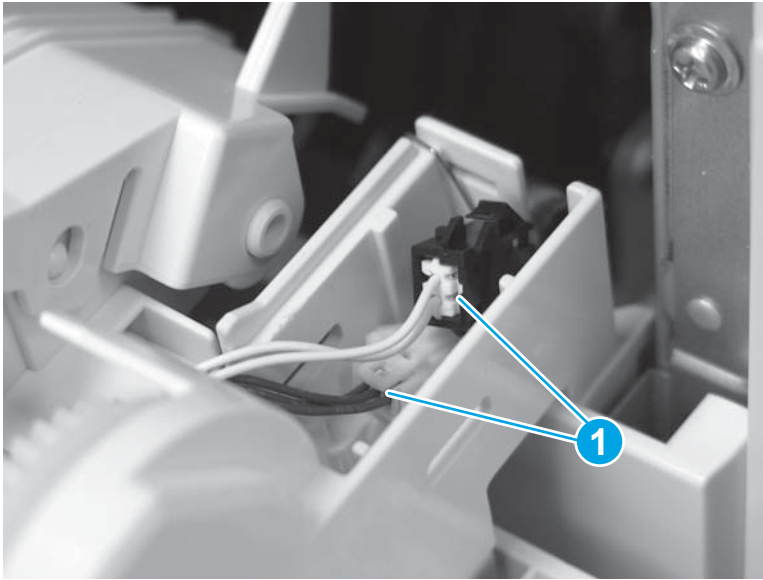

5. Install the connector cover. Position the mounting foot (callout 1) in the slot provided (callout 2), and then rotate the cover down to engage two tabs (callout 3) with the slots provided (callout 4).

 **IMPORTANT:** When correctly installed, the cover is flat against the door.

Figure 1-578 Install the connector cover

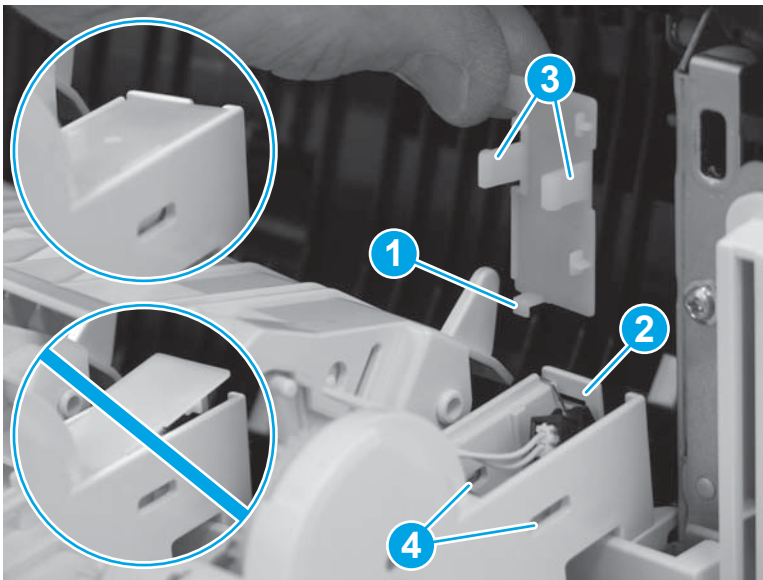

6. At the right- and left-side of the door, thread the door retainer straps (callout 1) through the holes in the door, and then secure them on the provided pins.

Figure 1-579 Install the door retainer straps

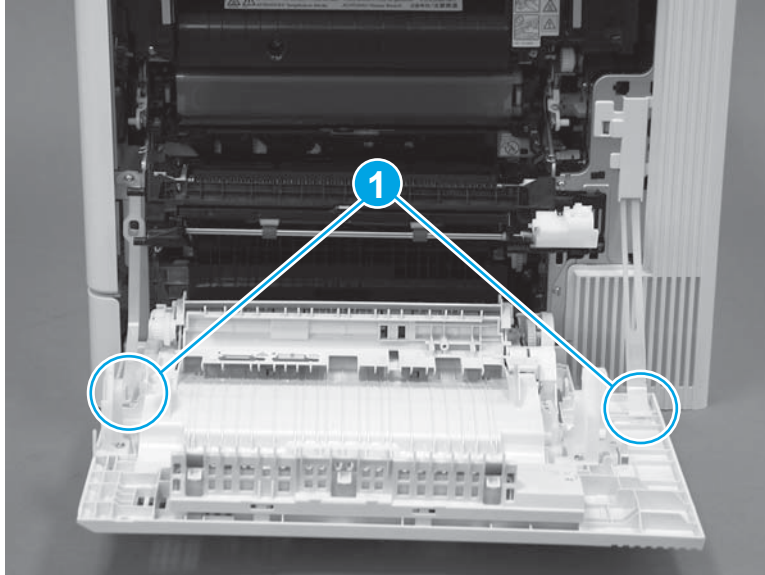

7. Close the right door.

Figure 1-580 Close the right door

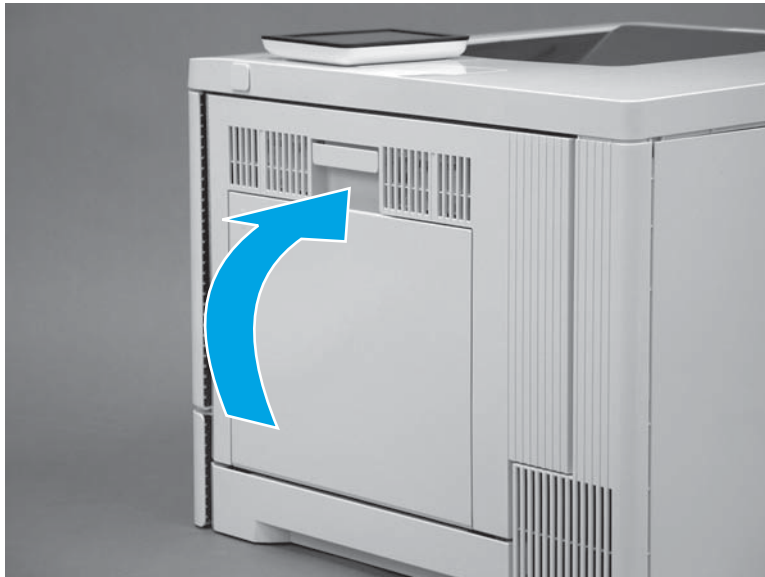

Removal and replacement: Front door

- [Introduction](#)
- [Step 1: Remove the tray](#)
- [Step 2: Remove the front door](#)
- [Step 3: Unpack the replacement front door](#)
- [Step 4: Install the front door](#)
- [Step 5: Install the tray](#)

Introduction

This document provides the procedures to remove and replace the front door.

Before performing service

Turn the printer power off

- Disconnect the power cable.

 **WARNING!** To avoid damage to the printer, turn the printer off, wait 30 seconds, and then remove the power cord before attempting to service the printer.

Use the table below to identify the correct part number for your printer. To order the part, go to www.hp.com/buy/parts.

Front door kit part number	
B5L46-67906	Front door with instruction guide

Required tools

No special tools are required to install this part.

After performing service

Make sure that the front door closes correctly after replacing it.

Turn the printer power on

- Connect the power cable.
- Use the power switch to turn the power on.

Step 1: Remove the tray

1. Pull the tray out until it stops.

Figure 1-581 Pull the tray out



2. Lift the front of the tray, and then pull it out of the printer to remove it.

Figure 1-582 Remove the tray

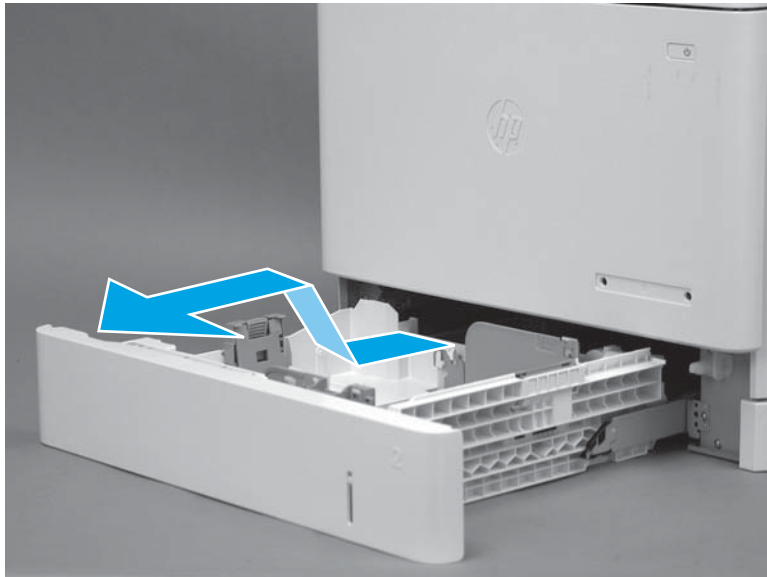

Step 2: Remove the front door

1. Open the front door.

Figure 1-583 Open the front door



2. At the right- and left-side of the door, release two tabs (callout 1), and then release the door retainer straps (callout 2).

 **TIP:** Use a pair of needle nose pliers to easily release the tabs.

Figure 1-584 Release the door retainer straps



3. Carefully push down on the door to lower it until the keyed hinge pin (callout 1) is aligned with the slot in the flange, and then slide the door to the right (callout 2) to release the left and right hinge pins (callout 1 and callout 3).

CAUTION: The keyed hinge pin (callout 1) is fragile, and can easily be broken off.

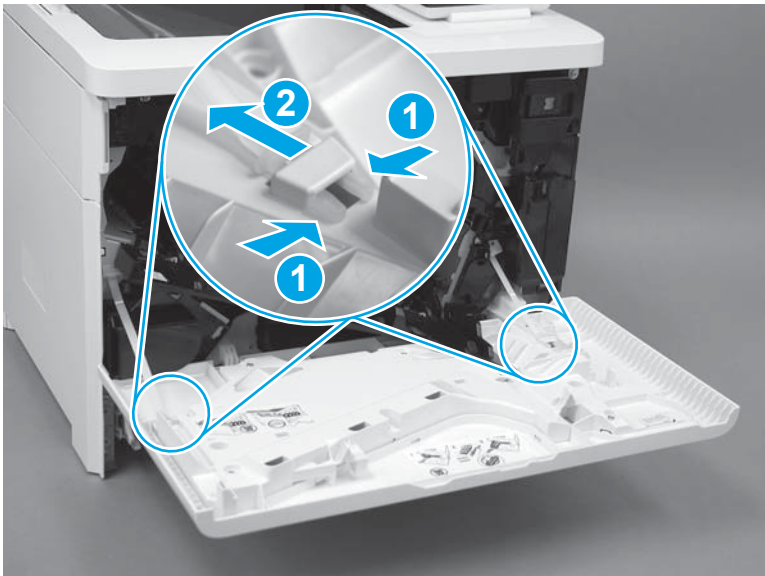
Make sure that it is correctly aligned with the slot in the flange before attempting to remove the front door from the printer.



Figure 1-585 Slide the door to the right

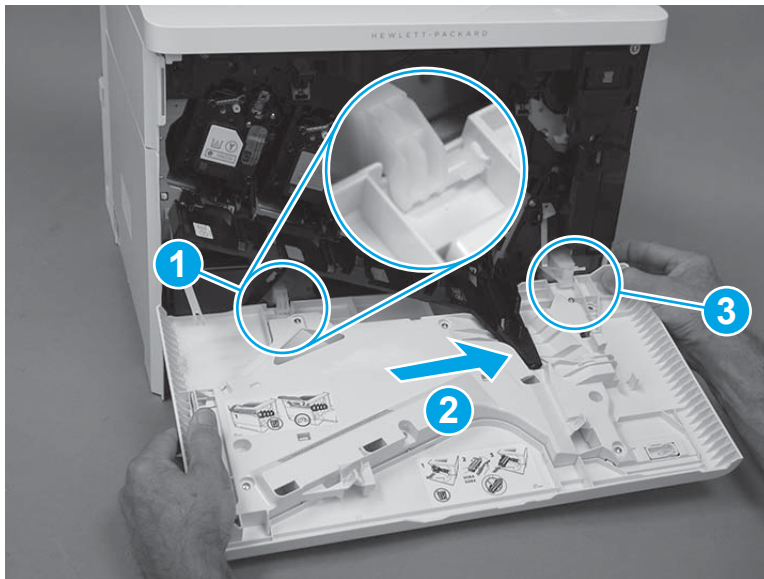

4. Pull the door toward you to release the inner door (callout 1), and then remove the front door.

CAUTION: Hold the inner door (callout 1) in place before releasing it. The inner door is spring loaded and will abruptly close and be damaged if it is not held down.

Figure 1-586 Remove the door

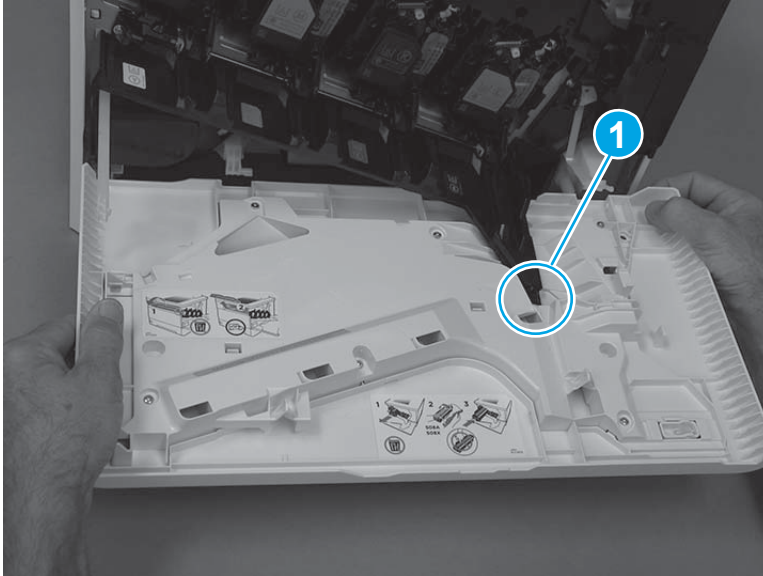

Step 3: Unpack the replacement front door

Unpack the replacement assembly from the packaging.

For complete information on HP's recycling programs, go to [Product return and recycling](#).

NOTE: HP recommends responsible disposal of the defective assembly.

Figure 1-587 Recycle and unpack

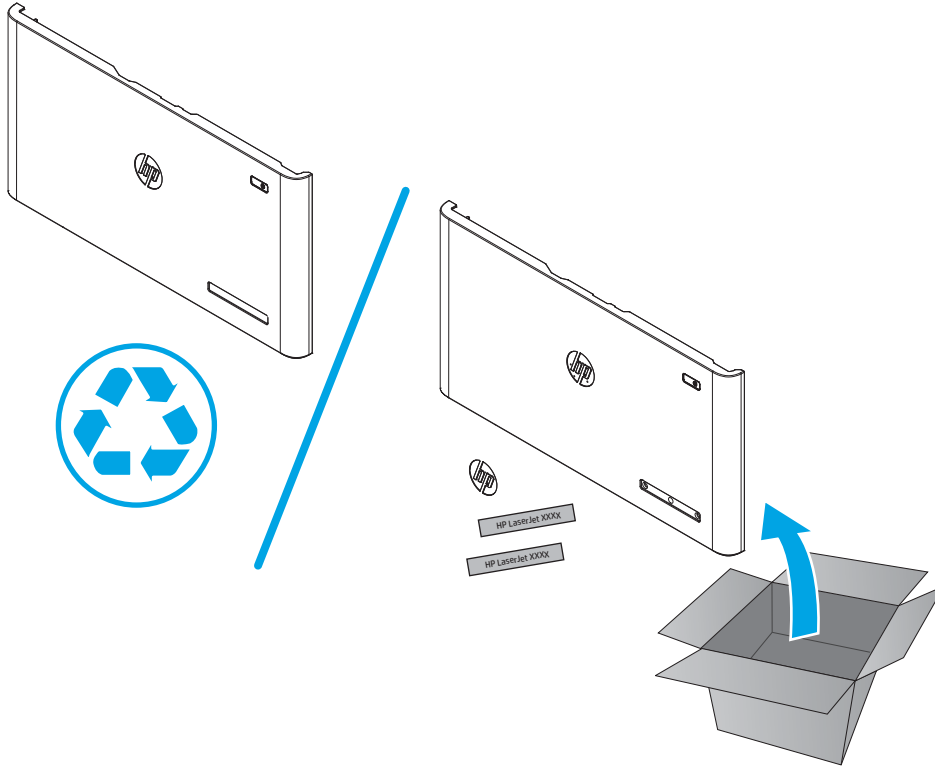

Step 4: Install the front door

1. Engage the tip of the inner door (callout 1) with the slot (callout 2) the front door.

Figure 1-588 Engage the inner door

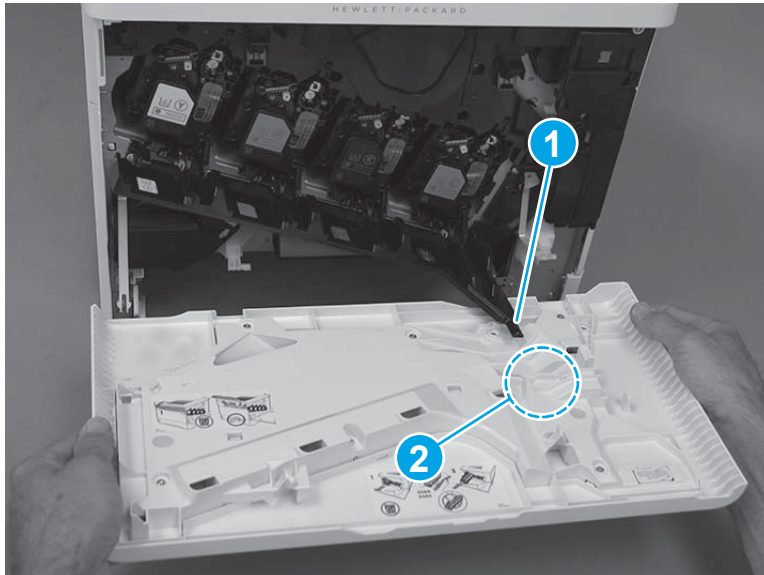

2. Position the door on the printer with the keyed hinge pin (callout 1) aligned with the slot in the flange, and then slide the door to the left (callout 2) to engage the left and right hinge pins (callout 1 and callout 3).

CAUTION: The keyed hinge pin (callout 1) is fragile, and can easily be broken off.

Make sure that it is correctly aligned with the slot in the flange before attempting to install the front door on the printer.



Figure 1-589 Install the door

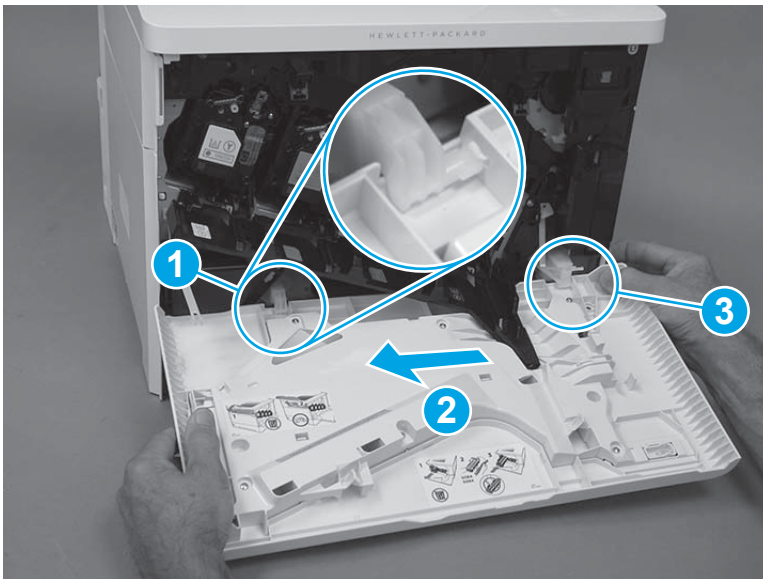

3. At the right- and left-side of the door, engage the door retainer straps with the holders on the door.

 **TIP:** Make sure that the tabs on the straps snap into place.

Figure 1-590 Engage the door retainer straps

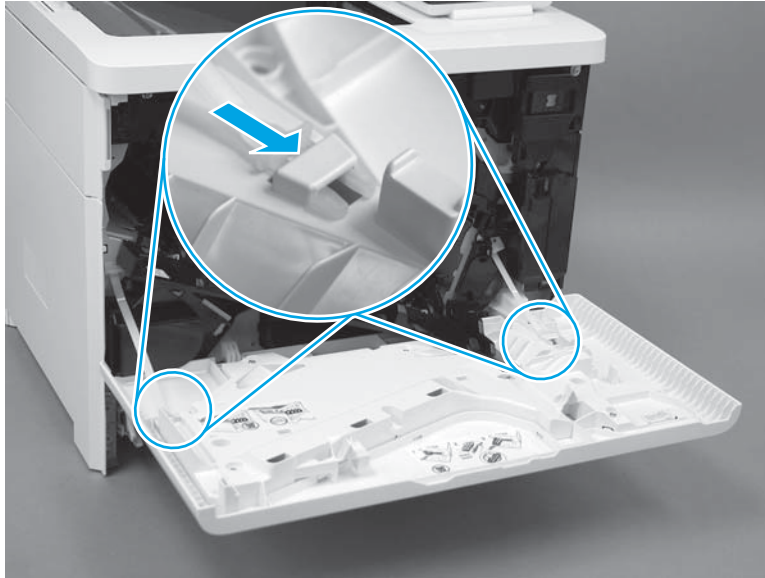

4. Close the front door.

Figure 1-591 Close the front door



5. If a replacement front door is installed, do the following:
 - a. Peel the adhesive backing away from the HP jewel, and then adhere the jewel to the front door (callout 1).
 - b. Press the nameplate mounting tabs through the holes provided in the door (callout 2) to install it.

Figure 1-592 Install nameplate and HP jewel



Step 5: Install the tray

1. With the front of the tray slightly lifted, align the sides of the tray with the rails in the printer, and then carefully slide the tray into the printer.

 **TIP:** As the tray slides into the printer, lower the front of it.

Figure 1-593 Install the tray



2. Close the tray.

Figure 1-594 Close the tray

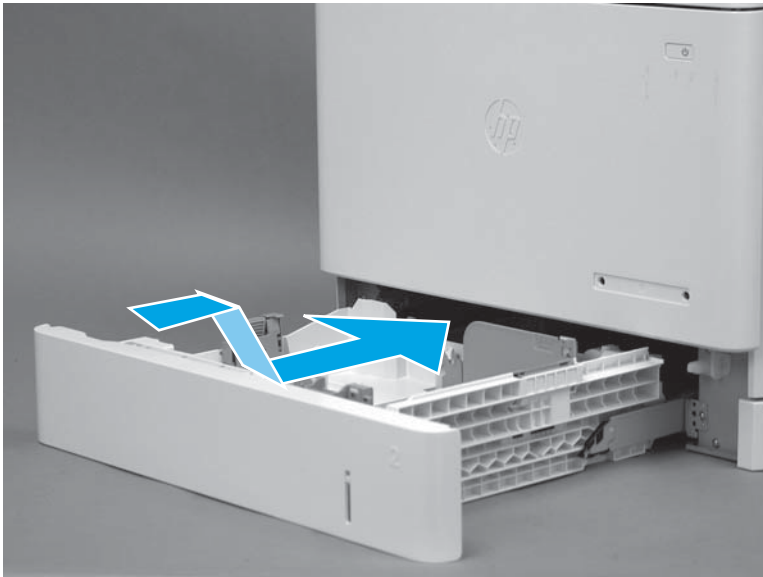

Removal and replacement: Formatter cover

- [Introduction](#)
- [Step 1: Remove the formatter cover](#)
- [Step 2: Unpack the replacement formatter cover](#)
- [Step 3: Install the formatter cover](#)

Introduction

This document provides the procedures to remove and replace the formatter cover.

Before performing service

Turn the printer power off

- Disconnect the power cable.

 **WARNING!** To avoid damage to the printer, turn the printer off, wait 30 seconds, and then remove the power cord before attempting to service the printer.

Use the table below to identify the correct part number for your printer. To order the part, go to www.hp.com/buy/parts.

Formatter cover part number

RM2-0084-000CN

Formatter cover

Required tools

No special tools are required to install this part.

After performing service

Make sure that the formatter cover is fully seated, and that the thumbscrews are finger tight after replacing it.

Turn the printer power on

- Connect the power cable.
- Use the power switch to turn the power on.

Step 1: Remove the formatter cover

1. Locate the formatter cover.

Figure 1-595 Locate the formatter cover

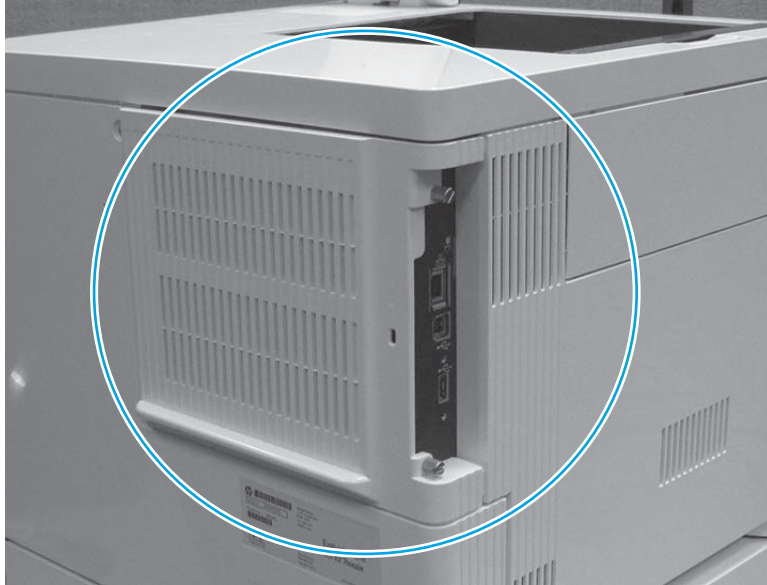

2. Loosen the two thumbscrews (callout 1). Grasp the two thumbscrews, and then slide the cover away from the printer (callout 2) to remove it.

 **TIP:** If needed, use the edge of a coin to turn the thumbscrews.

Figure 1-596 Loosen the thumbscrews



Step 2: Unpack the replacement formatter cover

Unpack the replacement assembly from the packaging.

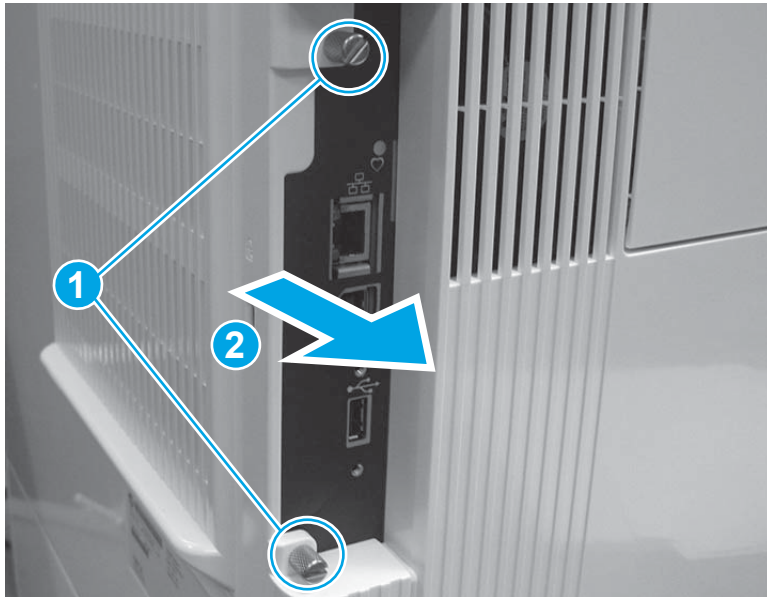
For complete information on HP's recycling programs, go to [Product return and recycling](#).

 **NOTE:** HP recommends responsible disposal of the defective assembly.

Figure 1-597 Recycle and unpack

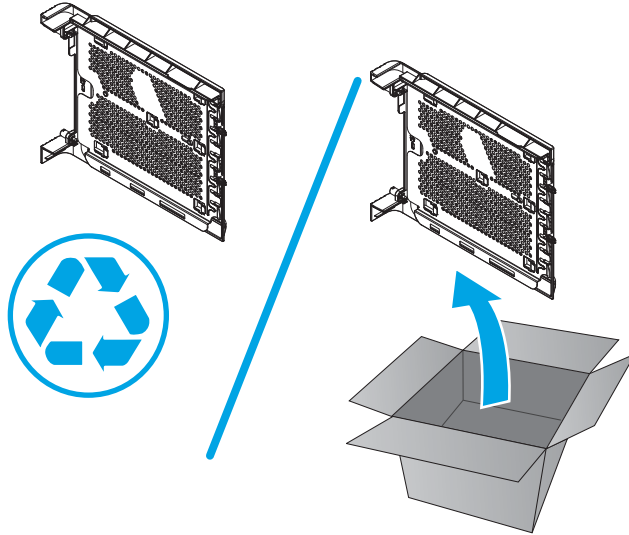

Step 3: Install the formatter cover

- ▲ Slide the cover onto the printer (callout 1) to install it.

 **NOTE:** Make sure that the tabs on the formatter cover align with the slots provided in the printer (callout 2). Tighten the two thumbscrews (callout 3).

 **TIP:** If needed, use the edge of a coin to turn the thumbscrews.

Figure 1-598 Install the cover



Removal and replacement: Rear cover (M552 and M553)

- [Introduction](#)
- [Step 1: Remove the formatter cover](#)
- [Step 2: Remove the rear cover](#)
- [Step 3: Unpack the replacement assembly](#)
- [Step 4: Install the rear cover](#)
- [Step 5: Install the formatter cover](#)

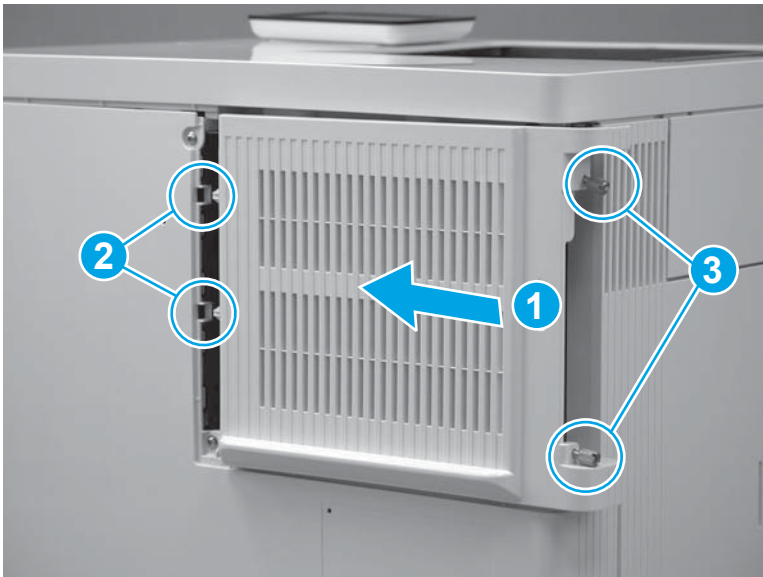
Introduction

This document provides the procedures to remove and replace the rear cover.

Before performing service

Turn the printer power off

- Disconnect the power cable.

⚠ WARNING! To avoid damage to the printer, turn the printer off, wait 30 seconds, and then remove the power cord before attempting to service the printer.

Use the table below to identify the correct part number for your printer. To order the part, go to www.hp.com/buy/parts.

Rear cover part number	
RM2-0085-000CN	Rear cover

Required tools

- #2 Phillips screwdriver with a magnetic tip

After performing service

Make sure that the formatter cover is fully seated, and that the thumbscrews are finger tight after replacing it.

Turn the printer power on

- Connect the power cable.
- Use the power switch to turn the power on.

Step 1: Remove the formatter cover

1. Locate the formatter cover.

Figure 1-599 Locate the formatter cover

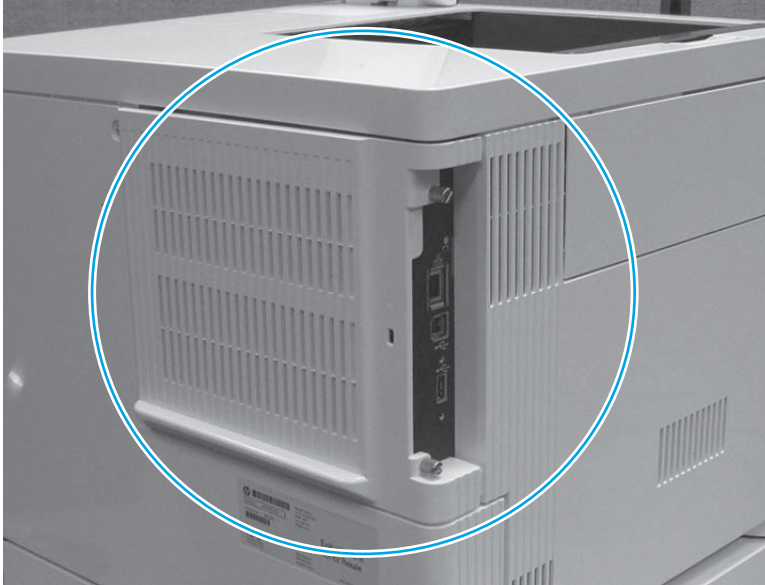

2. Loosen the two thumbscrews (callout 1). Grasp the two thumbscrews, and then slide the cover away from the printer (callout 2) to remove it.

 **TIP:** If needed, use the edge of a coin to turn the thumbscrews.

Figure 1-600 Loosen the thumbscrews



Step 2: Remove the rear cover

1. Remove four screws (callout 1).

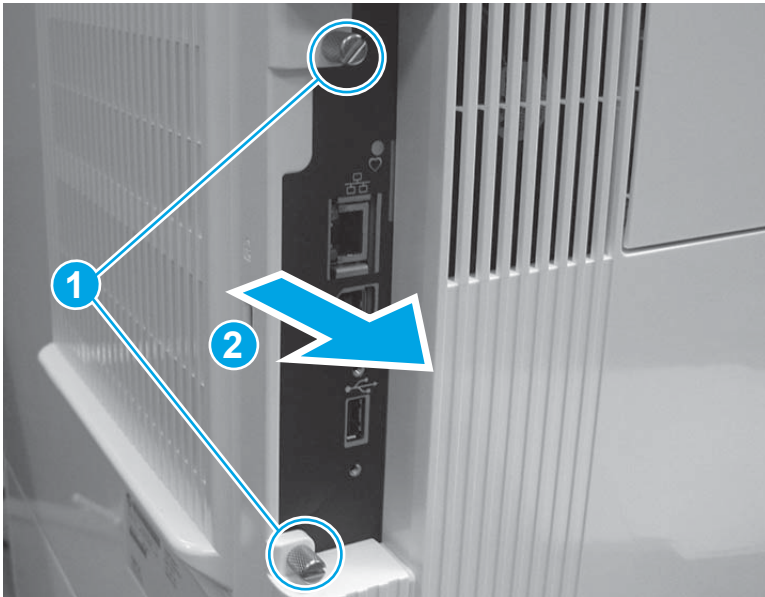
Figure 1-601 Remove four screws

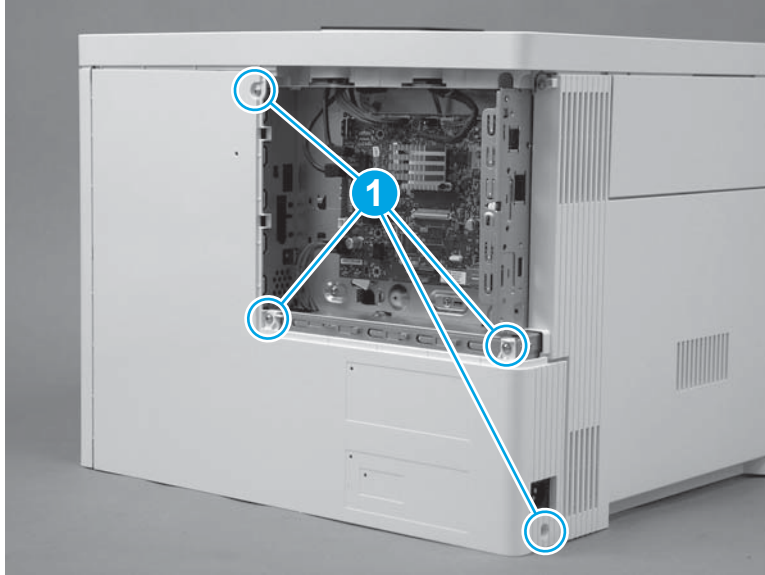

2. Slightly slide the cover to the right (callout 1), rotate the bottom of the cover away from the printer (callout 2), and then pull the top of the cover away from the printer (callout 3) to remove the cover.

Figure 1-602 Remove the cover

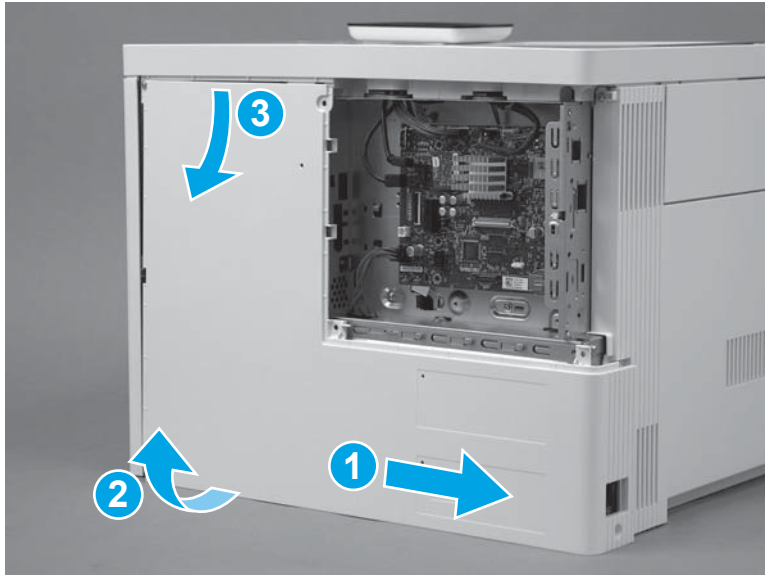

Step 3: Unpack the replacement assembly

Unpack the replacement assembly from the packaging.

For complete information on HP's recycling programs, go to [Product return and recycling](#).



NOTE: HP recommends responsible disposal of the defective assembly.

Figure 1-603 Recycle and unpack

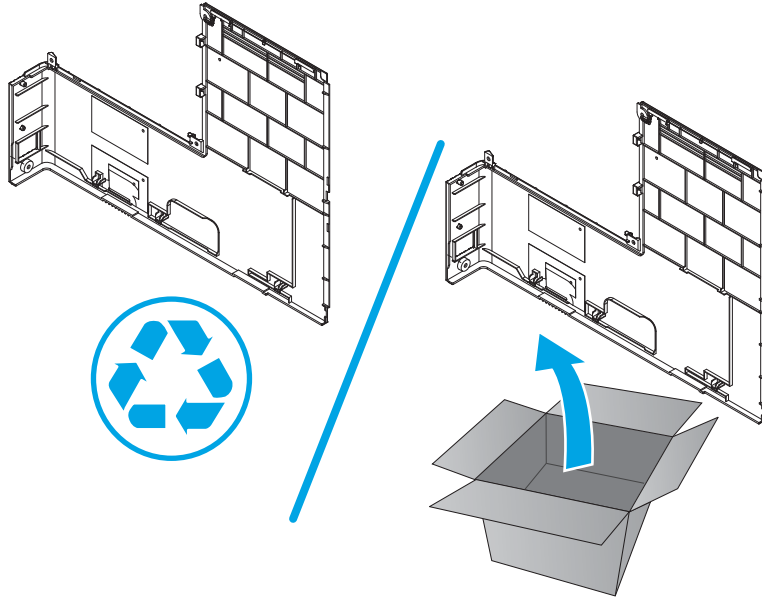

Step 4: Install the rear cover

1. Position the top of the cover under the upper cover (callout 1), rotate the bottom of the cover onto the chassis (callout 2), and then slide the cover to the left (callout 3) to install it.

Figure 1-604 Install the cover

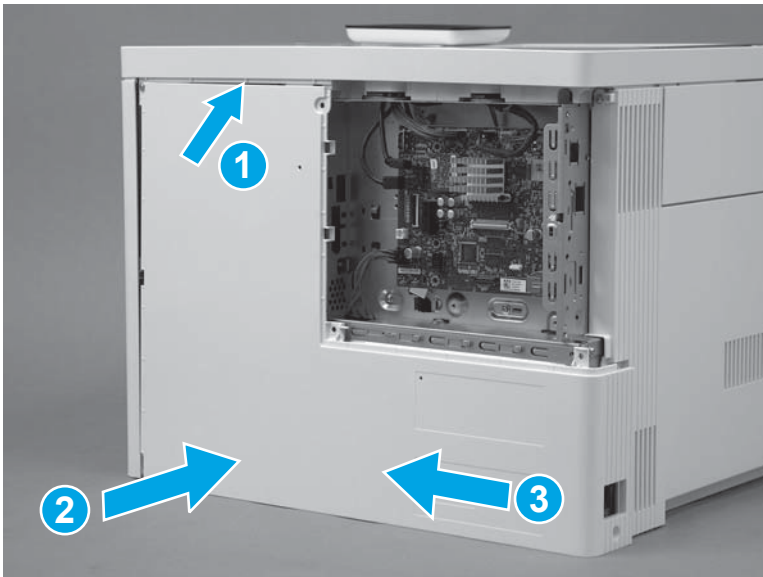

2. Install four screws (callout 1).

Figure 1-605 Install four screws cover

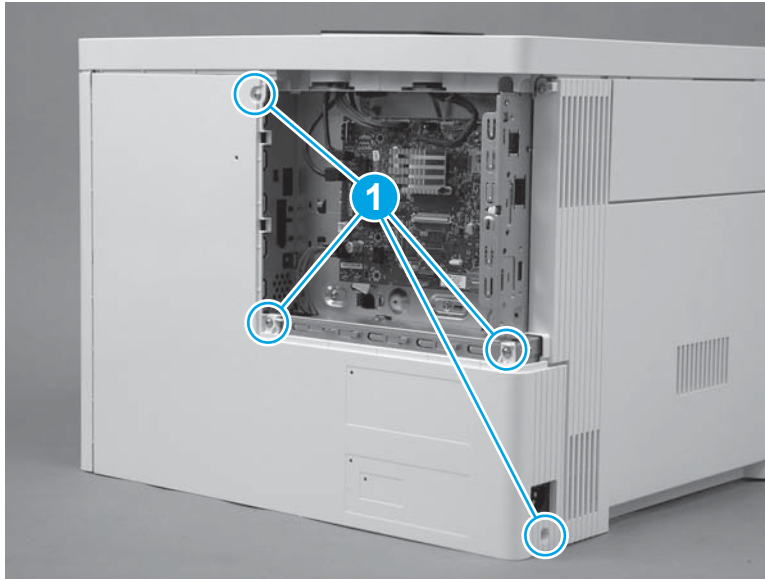

Step 5: Install the formatter cover

- ▲ Slide the cover onto the printer (callout 1) to install it.

 **NOTE:** Make sure that the tabs on the formatter cover align with the slots provided in the printer (callout 2). Tighten the two thumbscrews (callout 3).

 **TIP:** If needed, use the edge of a coin to turn the thumbscrews.

Figure 1-606 Install the cover



Removal and replacement: Rear cover (M577)

- [Introduction](#)
- [Step 1: Remove the formatter cover](#)
- [Step 2: Remove the rear upper cover](#)
- [Step 3: Remove the rear cover \(M577\)](#)
- [Step 4: Unpack the replacement assembly](#)
- [Step 5: Install the rear cover \(M577\)](#)
- [Step 6: Install the rear upper cover \(M577\)](#)
- [Step 7: Install the formatter cover](#)

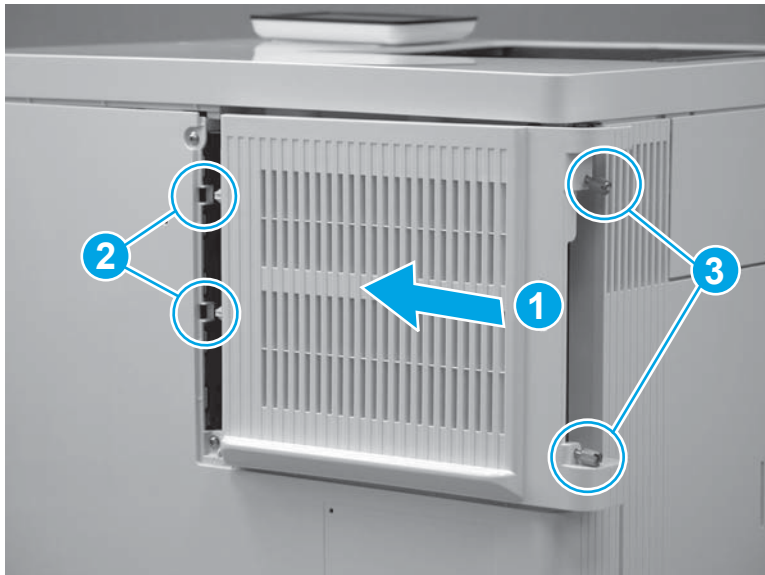
Introduction

This document provides the procedures to remove and replace the rear cover.

Before performing service

Turn the printer power off

- Disconnect the power cable.

 **WARNING!** To avoid damage to the printer, turn the printer off, wait 30 seconds, and then remove the power cord before attempting to service the printer.

Use the table below to identify the correct part number for your printer. To order the part, go to www.hp.com/buy/parts.

Rear cover part number	
RM2-0085-000CN	Rear cover

Required tools

- #2 Phillips screwdriver with a magnetic tip

After performing service

Make sure that the formatter cover is fully seated, and that the thumbscrews are finger tight after replacing it.

Turn the printer power on

- Connect the power cable.
- Use the power switch to turn the power on.

Step 1: Remove the formatter cover

1. Locate the formatter cover.

Figure 1-607 Locate the formatter cover

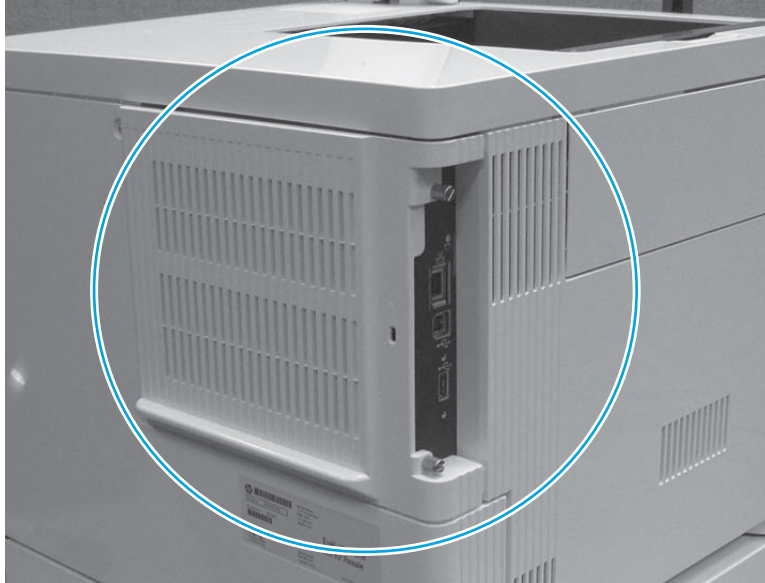

2. Loosen the two thumbscrews (callout 1). Grasp the two thumbscrews, and then slide the cover away from the printer (callout 2) to remove it.

 **TIP:** If needed, use the edge of a coin to turn the thumbscrews.

Figure 1-608 Loosen the thumbscrews



Step 2: Remove the rear upper cover

1. Remove two screws (callout 1).

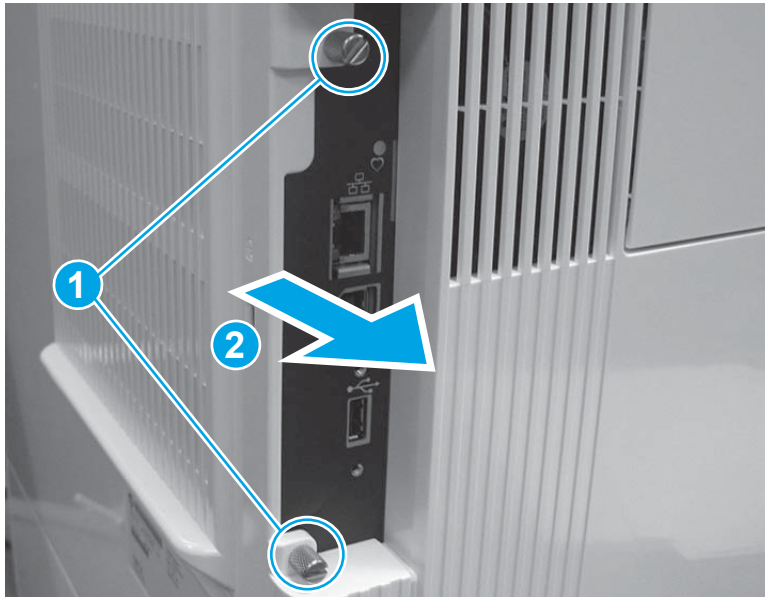
 **Reinstallation tip:** These two screws are self-tapping screws for plastic. When reinstalling them, rotate the screws counterclockwise to align them with the existing thread pattern, and then carefully turn them clockwise to tighten. Do not overtighten. This will prevent stripping the threads inside the screw holes.

Figure 1-609 Remove two screws



2. Use a small, flat blade screwdriver to release the right edge of the cover.

Figure 1-610 Release the right edge

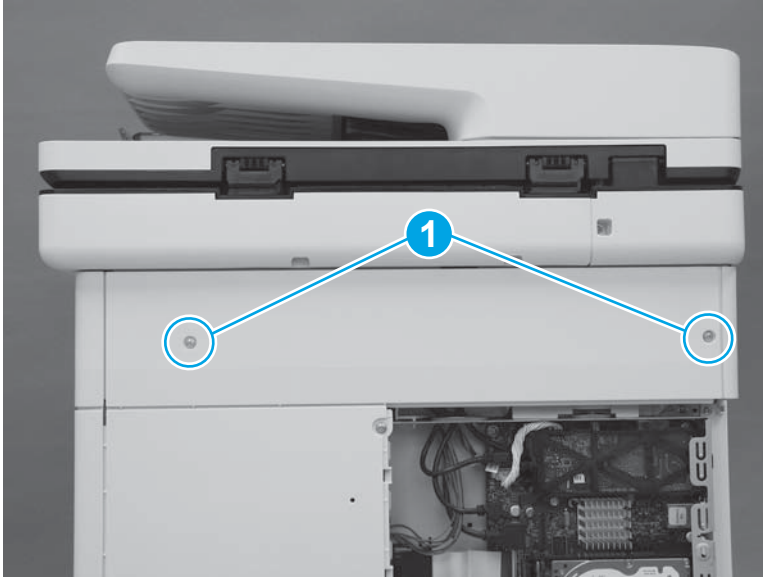
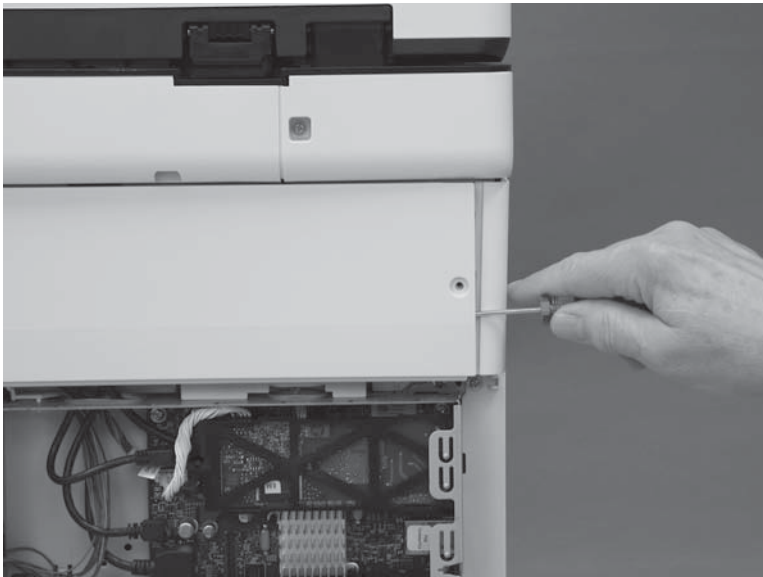

3. Pull the right edge of the cover (callout 1) away from the printer, and then slide the cover to the right (callout 2).

Figure 1-611 Slide the cover right

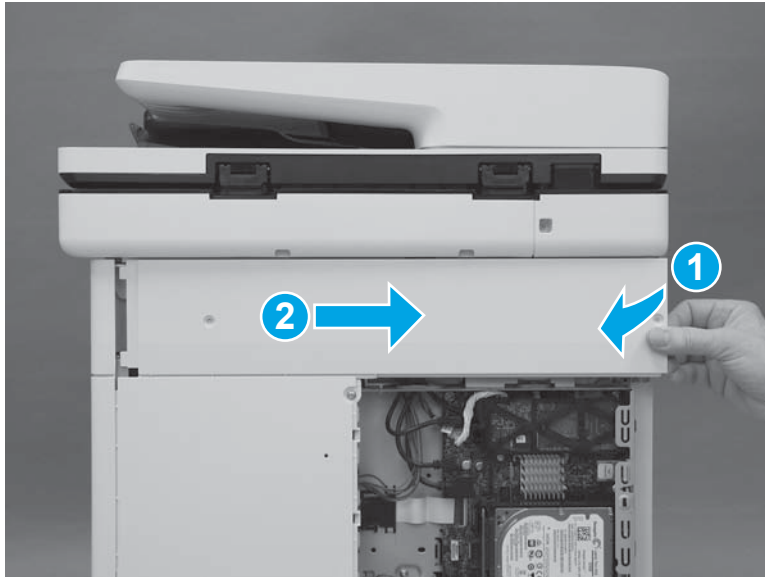

4. Remove the cover.

Figure 1-612 Remove the cover

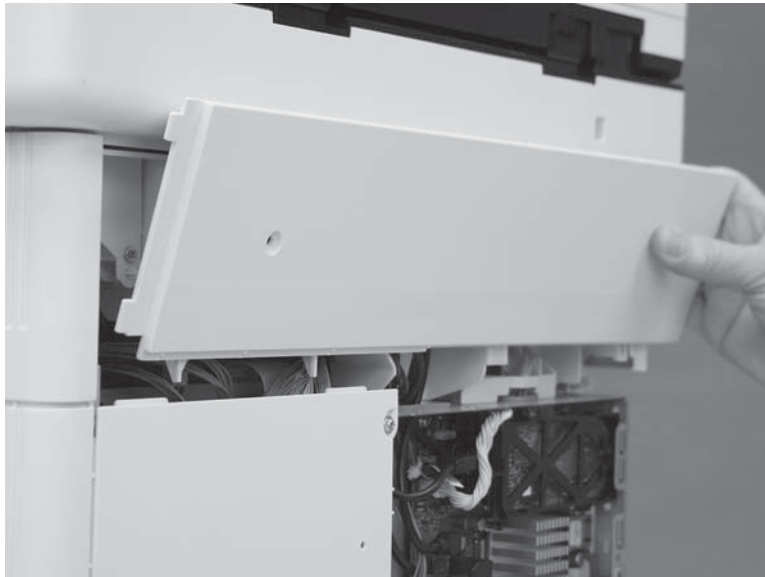

Step 3: Remove the rear cover (M577)

1. Remove four screws (callout 1).

Figure 1-613 Remove four screws

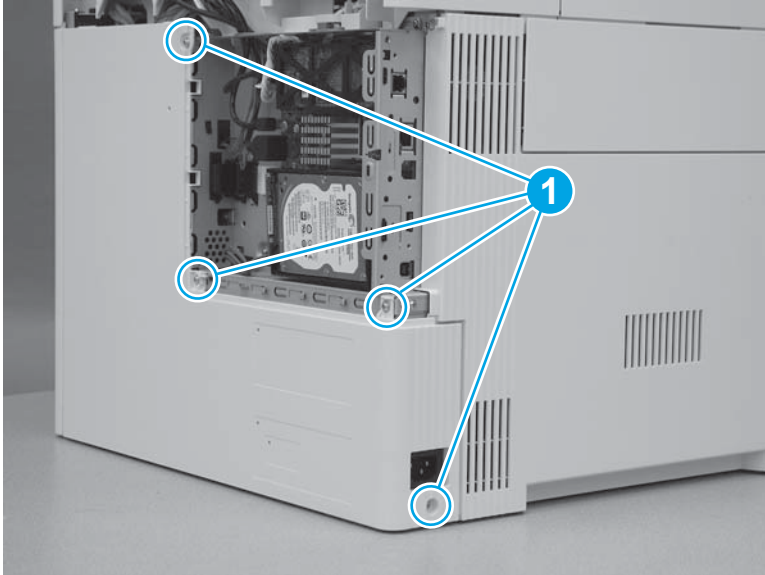

2. Slide the cover to the right to remove it.

Figure 1-614 Remove the cover

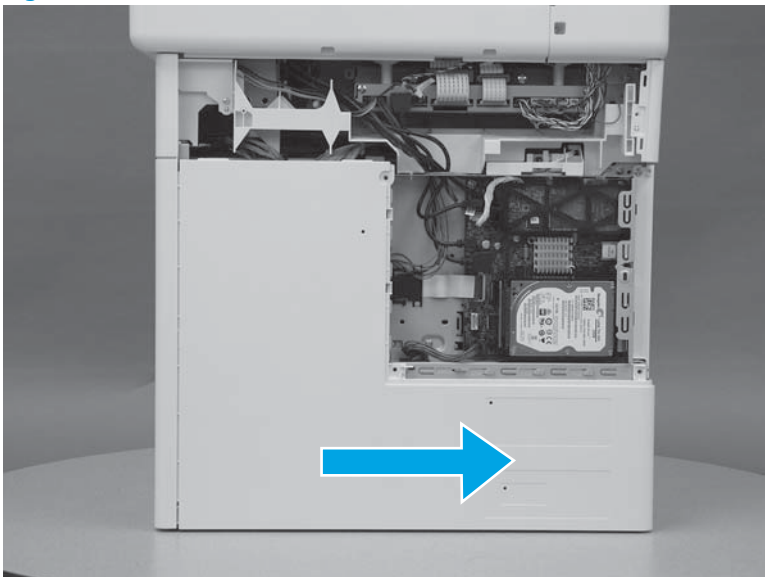

Step 4: Unpack the replacement assembly

Unpack the replacement assembly from the packaging.

For complete information on HP's recycling programs, go to [Product return and recycling](#).



NOTE: HP recommends responsible disposal of the defective assembly.

Figure 1-615 Recycle and unpack

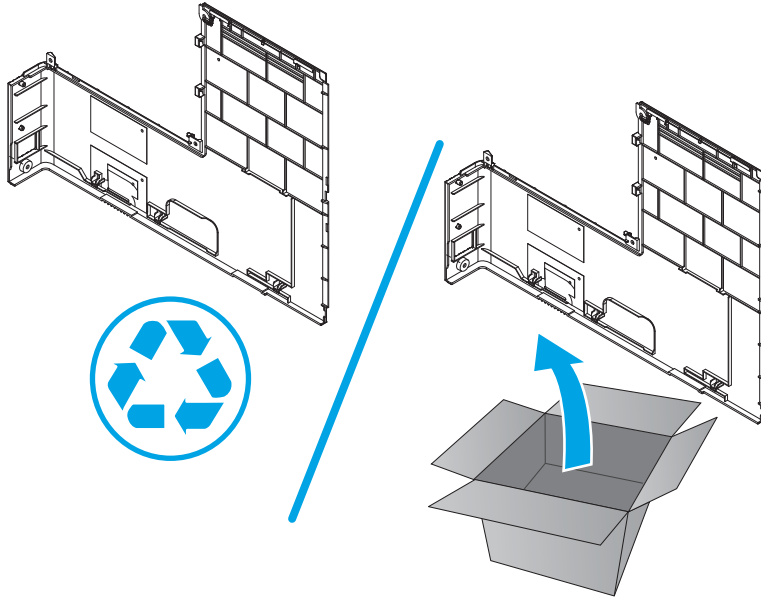

Step 5: Install the rear cover (M577)

1. Position the hooks (callout 1) on the cover in the slots (callout 2) in the printer.

Figure 1-616 Position the hooks

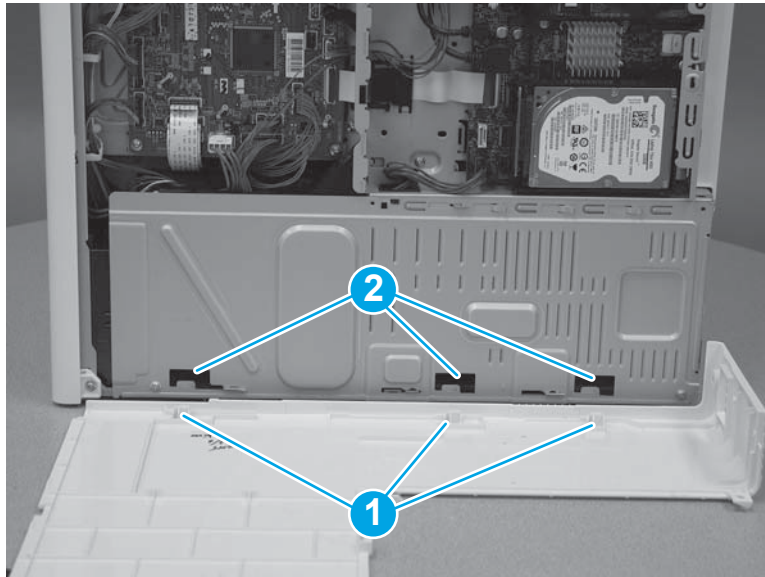

2. Position the back edge (callout 1) of the rear cover behind the edge (callout 2) of the right rear cover. Slide the cover to the left to install it.

Figure 1-617 Install the cover

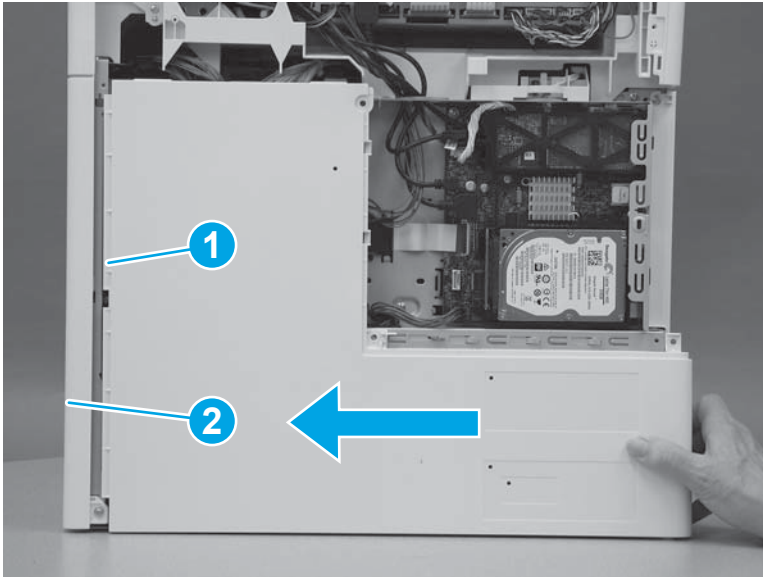

3. Install four screws (callout 1).

Figure 1-618 Install four screws cover

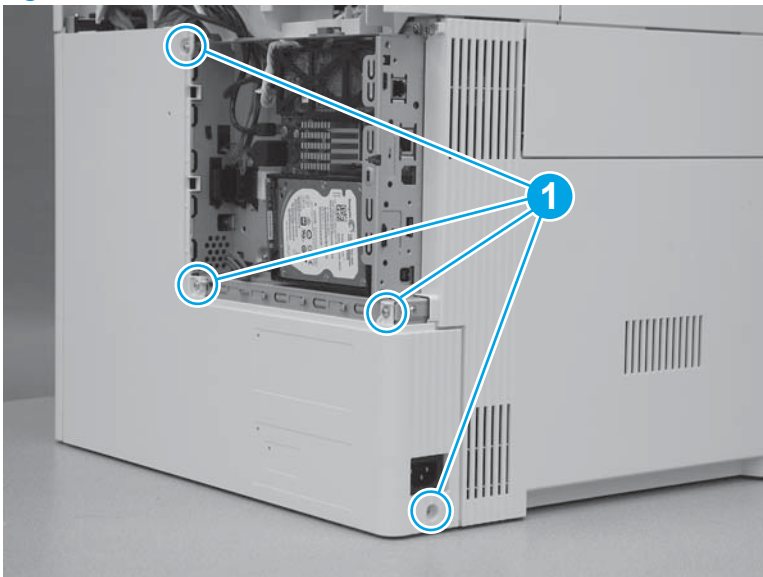

Step 6: Install the rear upper cover (M577)

1. Align the ridge (callout 1) on the lower edge of the rear upper cover in front of the tabs (callout 2) on the top edge of the rear cover.

Figure 1-619 Align the cover

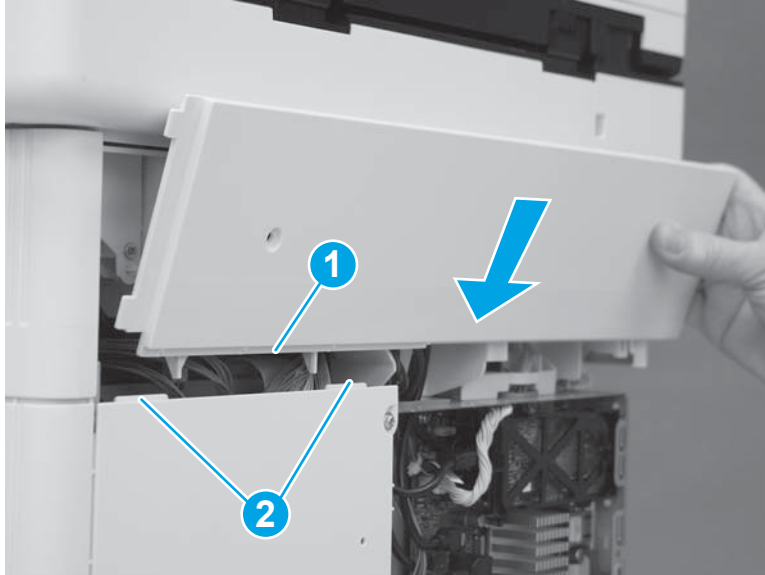

2. Rotate the top of the cover toward the printer.

Figure 1-620 Rotate the top of the cover

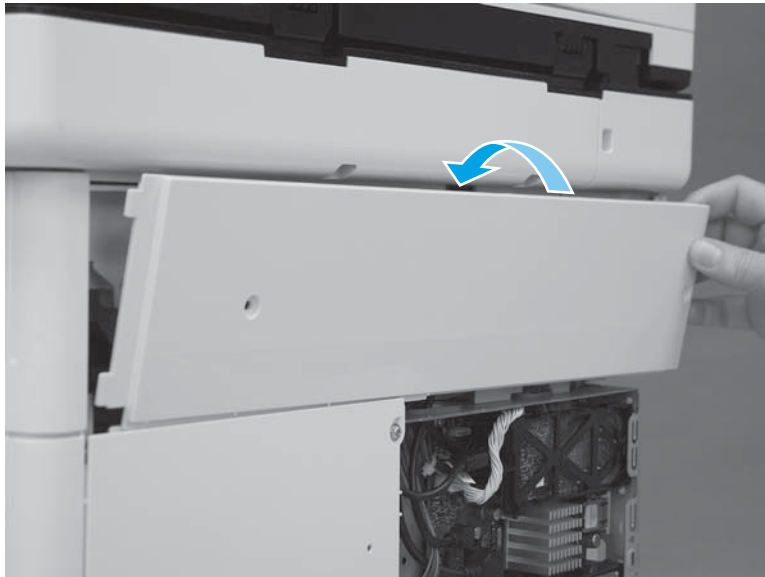

3. Slide the cover to the left (callout 1). Make sure that the tabs (callout 2) on the upper rear cover slide behind the edge (callout 3) of the right upper cover. Make sure that the cover is fully seated.

Figure 1-621 Slide the cover

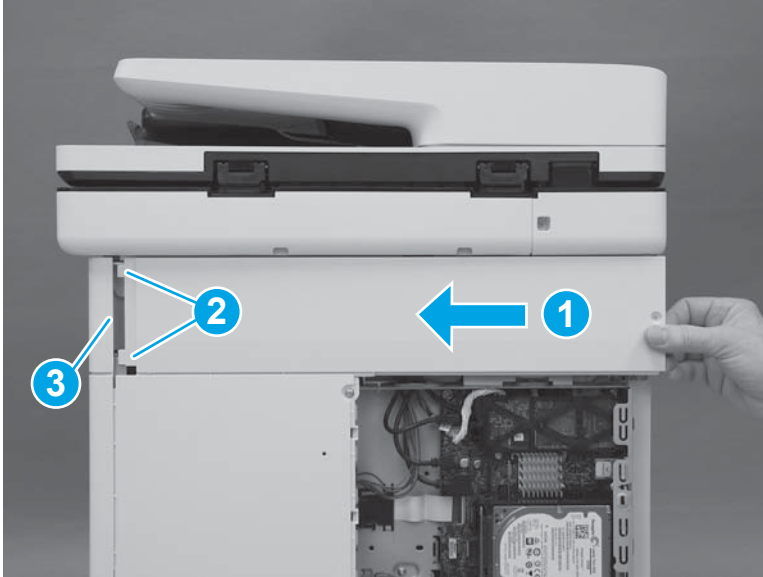

4. Install two screws (callout 1).



 **IMPORTANT:** These two screws are self-tapping screws for plastic. Rotate them counterclockwise to align them with the existing thread pattern, and then carefully turn them clockwise to tighten. Do not overtighten. This will prevent stripping the threads inside the screw holes.

Figure 1-622 Install two screws

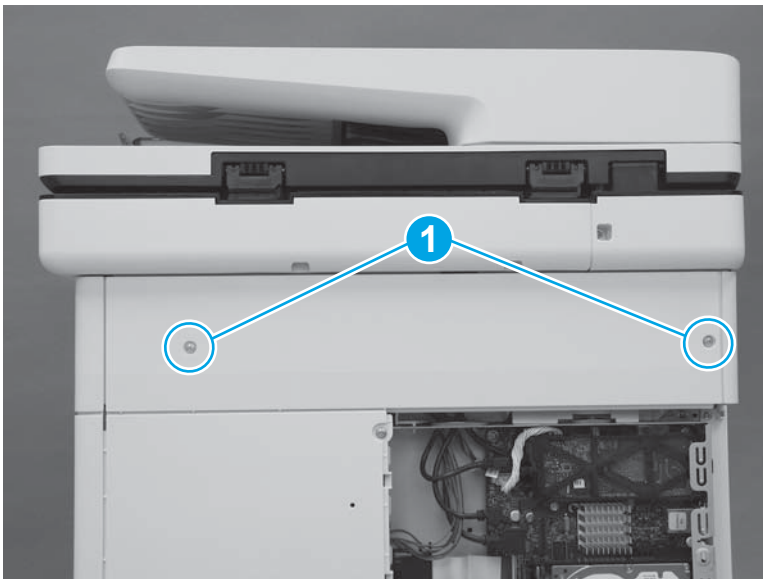

Step 7: Install the formatter cover

- ▲ Slide the cover onto the printer (callout 1) to install it.

 **NOTE:** Make sure that the tabs on the formatter cover align with the slots provided in the printer (callout 2). Tighten the two thumbscrews (callout 3).

 **TIP:** If needed, use the edge of a coin to turn the thumbscrews.

Figure 1-623 Install the cover



Removal and replacement: Left cover

- [Introduction](#)
- [Step 1: Remove the toner collection unit \(TCU\)](#)
- [Step 2: Remove the formatter cover](#)
- [Step 3: Remove the rear cover \(M552 and M553\)](#)
- [Step 4: Remove the rear upper cover \(M577\)](#)
- [Step 5: Remove the rear cover \(M577\)](#)
- [Step 6: Remove the left cover](#)
- [Step 7: Unpack the replacement assembly](#)
- [Step 8: Install the left cover](#)
- [Step 9: Install the rear cover \(M577\)](#)
- [Step 10: Install the rear upper cover \(M577\)](#)
- [Step 11: Install the rear cover \(M552 and M553\)](#)
- [Step 12: Install the formatter cover](#)
- [Step 13: Install the TCU](#)

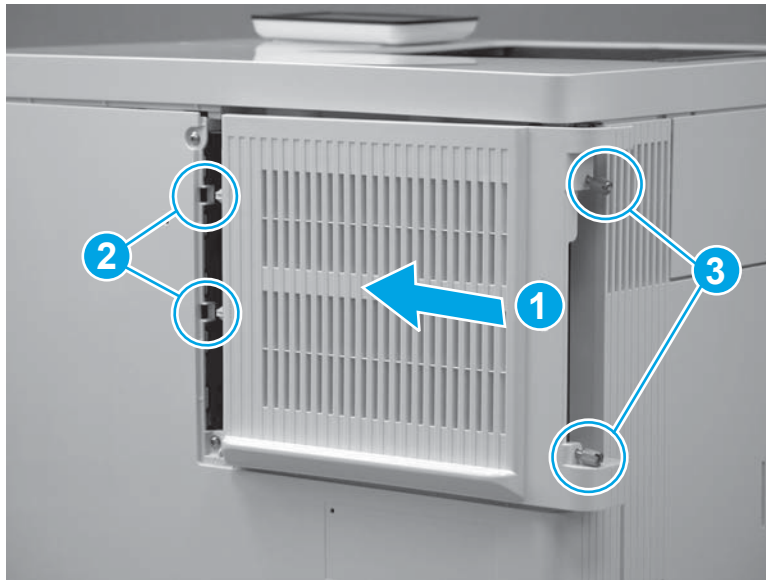
Introduction

This document provides the procedures to remove and replace the left cover.

Before performing service

Turn the printer power off

- Disconnect the power cable.

 **WARNING!** To avoid damage to the printer, turn the printer off, wait 30 seconds, and then remove the power cord before attempting to service the printer.

Use the table below to identify the correct part number for your printer. To order the part, go to www.hp.com/buy/parts.

Left cover part number

RC4-0179-000CN

Left cover

Required tools

- #2 Phillips screwdriver with a magnetic tip

After performing service

Make sure that the TCU is fully closed after replacing it.

Make sure that the formatter cover is fully seated, and that the thumbscrews are finger tight after replacing it.

Turn the printer power on

- Connect the power cable.
- Use the power switch to turn the power on.

Step 1: Remove the toner collection unit (TCU)

1. Open the front door.

Figure 1-624 Open the front door



2. Open the TCU.

 **NOTE:** The toner collection hatch cover automatically closes when the TCU is opened.

Figure 1-625 Open the TCU



3. Pull the TCU away from the printer at an angle to remove it.

⚠ CAUTION: Do not open the toner collection hatch cover when handling the TCU. If toner gets on clothing, wipe it off by using a dry cloth and wash the clothes in cold water. Hot water sets toner into fabric.

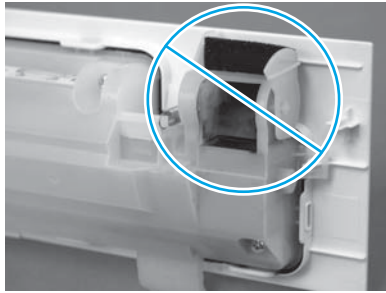
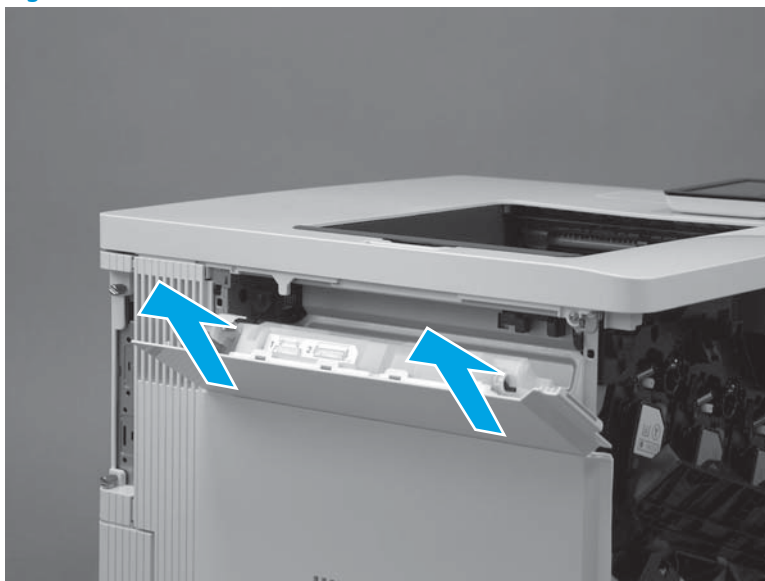

Figure 1-626 Remove the TCU



Step 2: Remove the formatter cover

1. Locate the formatter cover.

Figure 1-627 Locate the formatter cover

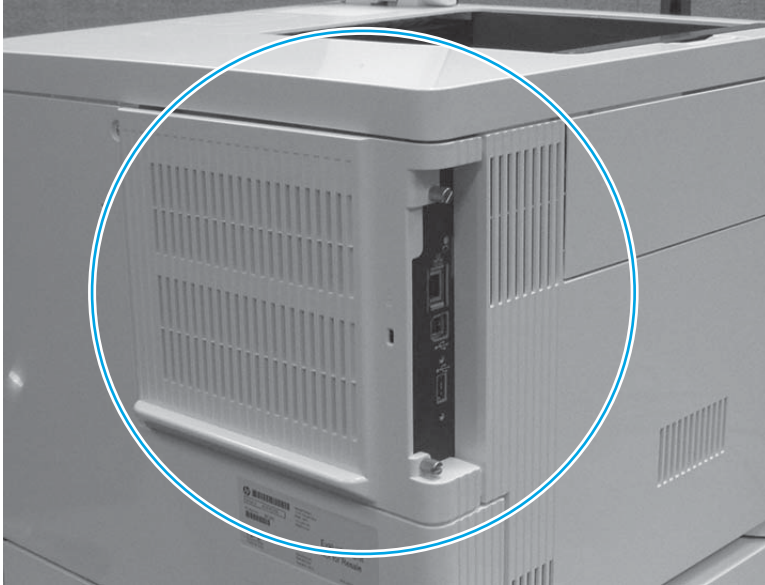

2. Loosen the two thumbscrews (callout 1). Grasp the two thumbscrews, and then slide the cover away from the printer (callout 2) to remove it.



 **TIP:** If needed, use the edge of a coin to turn the thumbscrews.

Figure 1-628 Loosen the thumbscrews

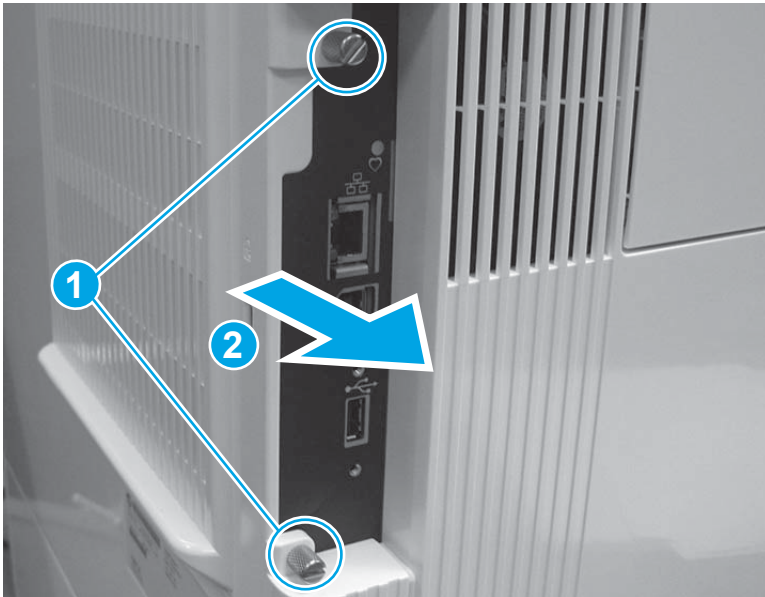

Step 3: Remove the rear cover (M552 and M553)

 **NOTE:** This step is for the M552 and M553 models. For the M577 models, skip this step and go to [Step 4: Remove the rear upper cover \(M577\) on page 381](#).

1. Remove four screws (callout 1).

Figure 1-629 Remove four screws

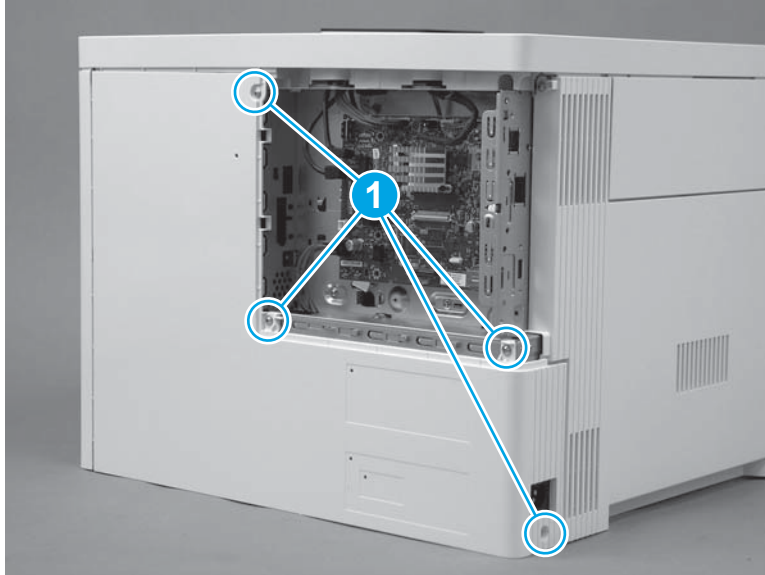

2. Slightly slide the cover to the right (callout 1), rotate the bottom of the cover away from the printer (callout 2), and then pull the top of the cover away from the printer (callout 3) to remove the cover.

Figure 1-630 Remove the cover

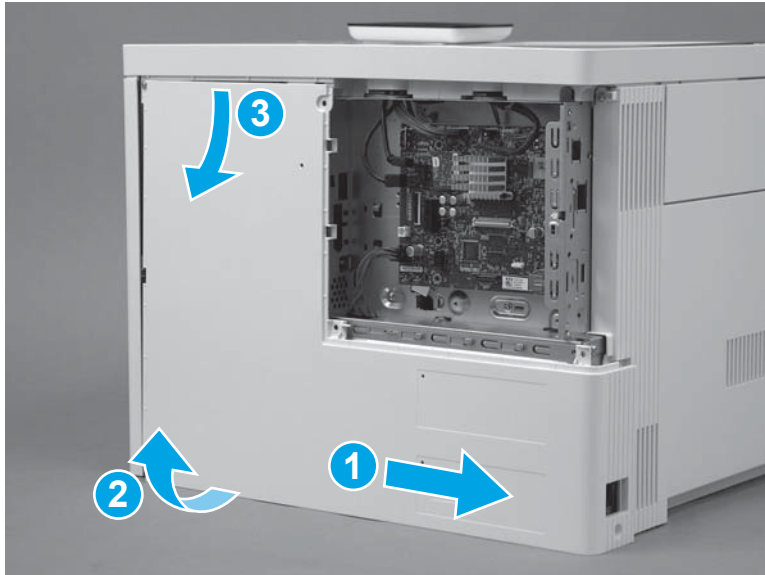

Step 4: Remove the rear upper cover (M577)



NOTE: This step is for the M577 models. For the M552 and M553 models, skip this step and go to [Step 6: Remove the left cover on page 384](#).

1. Remove two screws (callout 1).



Reinstallation tip: These two screws are self-tapping screws for plastic. When reinstalling them, rotate the screws counterclockwise to align them with the existing thread pattern, and then carefully turn them clockwise to tighten. Do not overtighten. This will prevent stripping the threads inside the screw holes.

Figure 1-631 Remove two screws

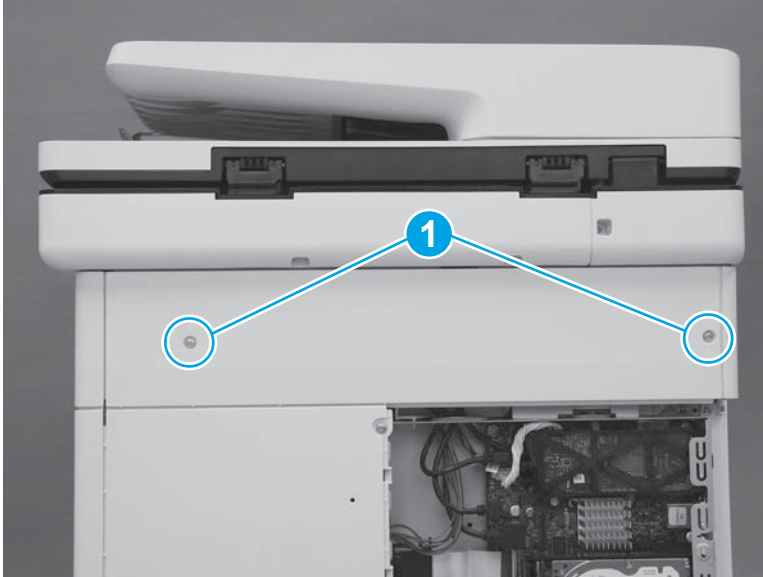

2. Use a small, flat blade screwdriver to release the right edge of the cover.

Figure 1-632 Release the right edge

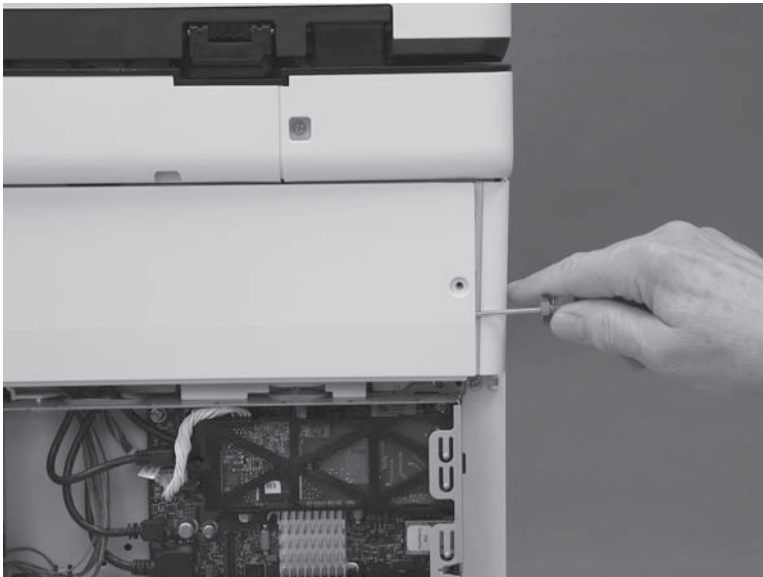

3. Pull the right edge of the cover (callout 1) away from the printer, and then slide the cover to the right (callout 2).

Figure 1-633 Slide the cover right

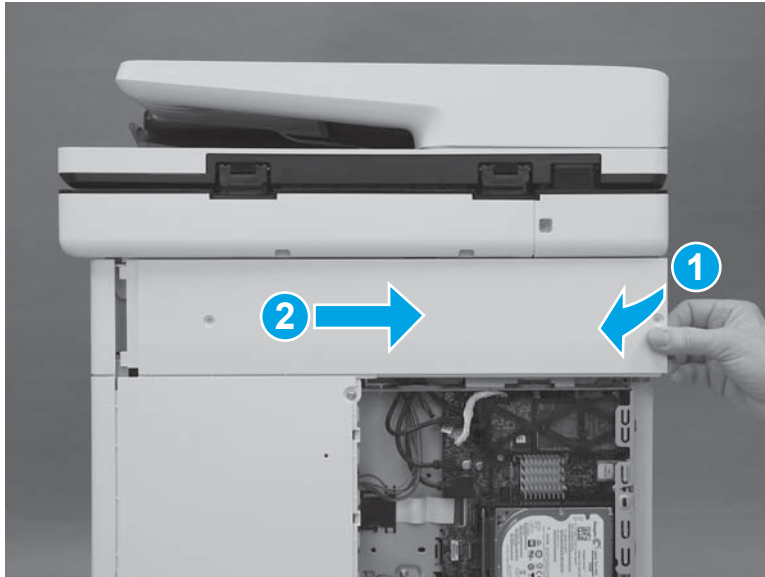

4. Remove the cover.

Figure 1-634 Remove the cover

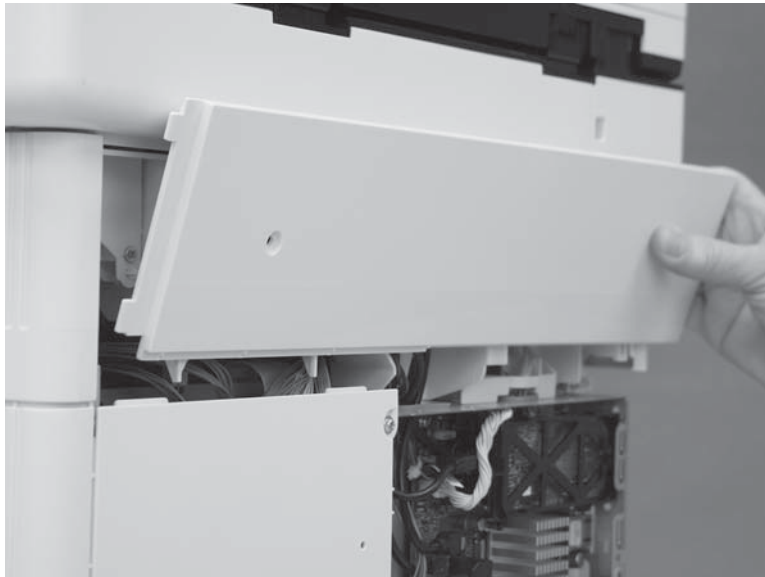

Step 5: Remove the rear cover (M577)

 **NOTE:** This step is for the M577 models. For the M552 and M553 models, skip this step and go to [Step 6: Remove the left cover on page 384.](#)

1. Remove four screws (callout 1).

Figure 1-635 Remove four screws

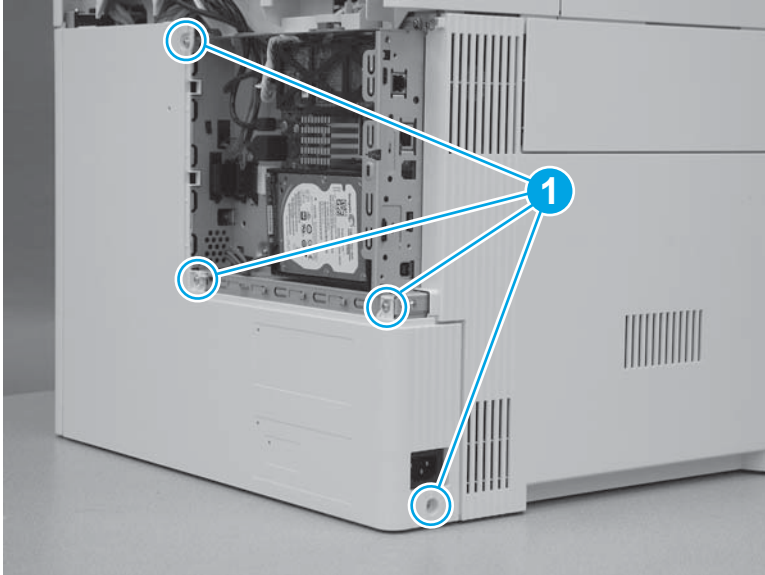

2. Slide the cover to the right to remove it.

Figure 1-636 Remove the cover

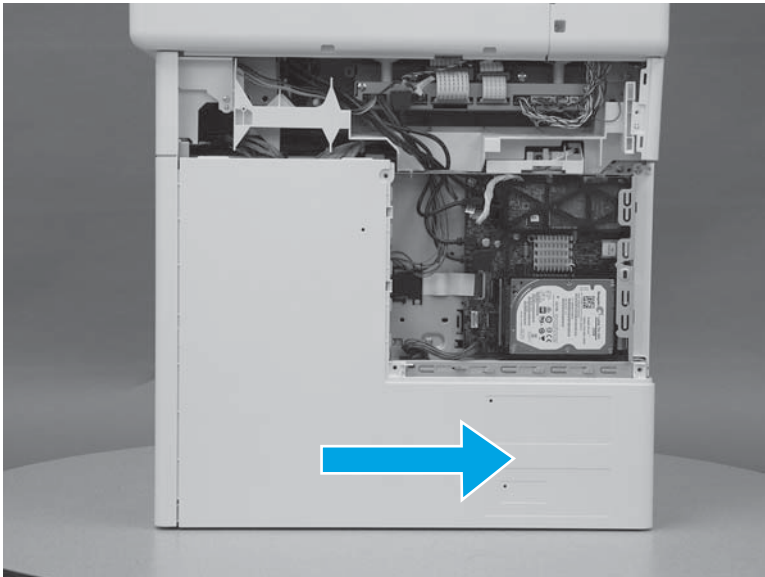

Step 6: Remove the left cover

1. At the left side of the printer, remove one screw (callout 1).

Figure 1-637 Remove one screw



2. Release one tab (callout 1), rotate the front edge of the cover away from the printer (callout 2), and then slide the cover (callout 3) toward the rear of the printer to release it.

Figure 1-638 Release the cover

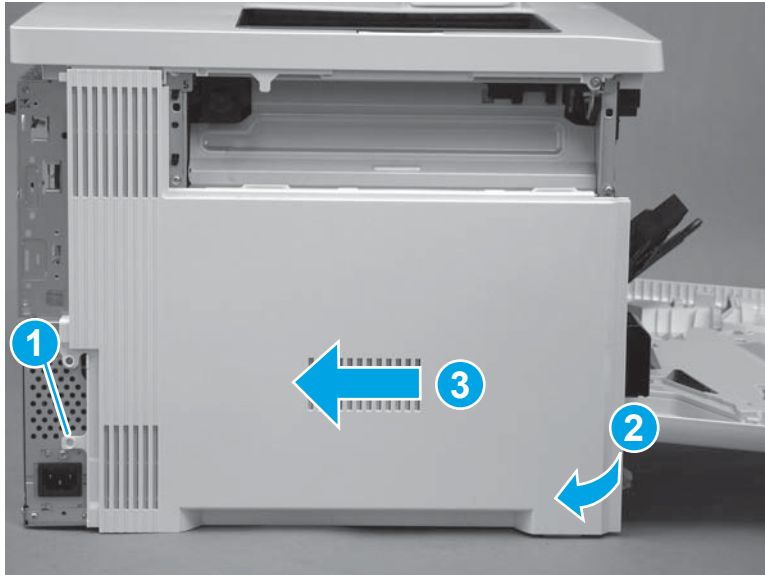

3. Remove the cover.

Figure 1-639 Remove the cover

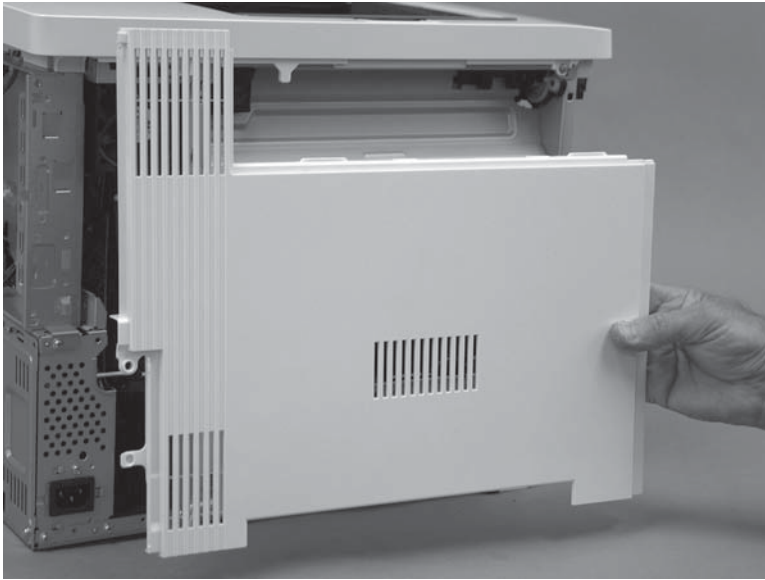

Step 7: Unpack the replacement assembly

Unpack the replacement assembly from the packaging.

For complete information on HP's recycling programs, go to [Product return and recycling](#).

 **NOTE:** HP recommends responsible disposal of the defective assembly.

Figure 1-640 Recycle and unpack

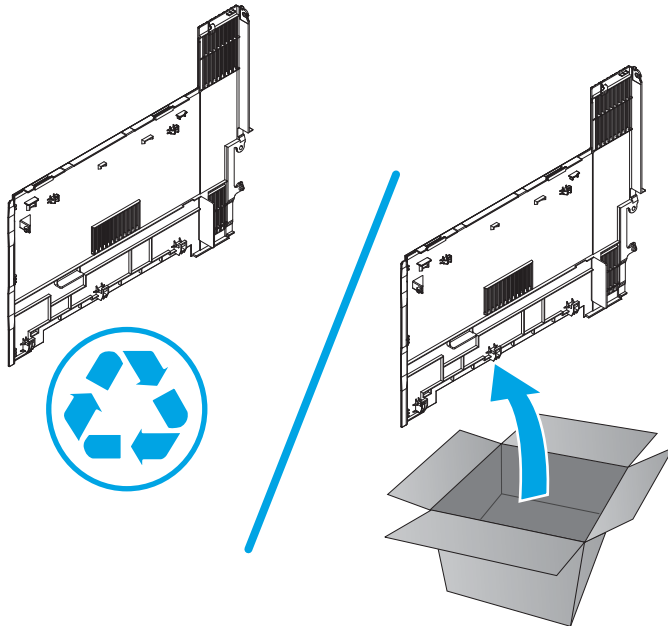

Step 8: Install the left cover

1. Position the cover on the printer.

 **NOTE:** Slightly offset the cover toward the rear of the printer.

Figure 1-641 Install the cover

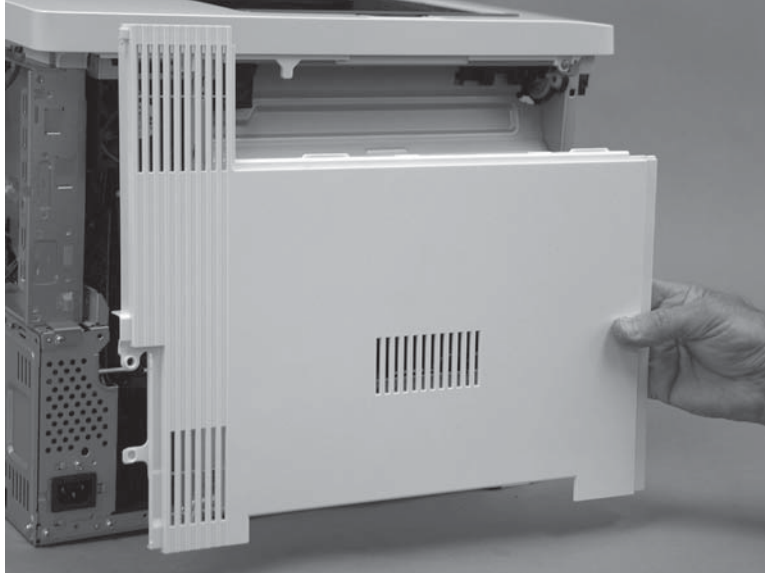

2. Slide the cover (callout 1) toward the front of the printer to engage it. Make sure that the tab (callout 2) snaps into place.

 **NOTE:** Locate the alignment pin (callout 3) on the cover from the front door side of the printer, and then make sure that it is fully engaged in the slot in the chassis.

 **TIP:** While sliding the cover into place, push in on the center of the cover (callout 1) to make sure that the hooks on the back of the cover engage with the slots in the chassis.

Figure 1-642 Engage the cover



3. At the left side of the printer, install one screw (callout 1).

Figure 1-643 Install one screw

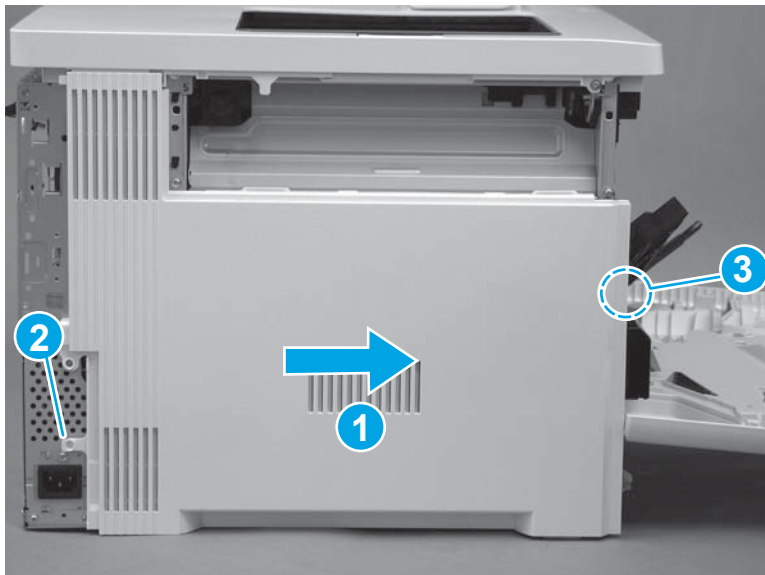

Step 9: Install the rear cover (M577)



NOTE: This step is for the M577 models. For the M552 and M553 models, skip this step and go to [Step 11: Install the rear cover \(M552 and M553\) on page 391](#).

1. Position the hooks (callout 1) on the cover in the slots (callout 2) in the printer.

Figure 1-644 Position the hooks

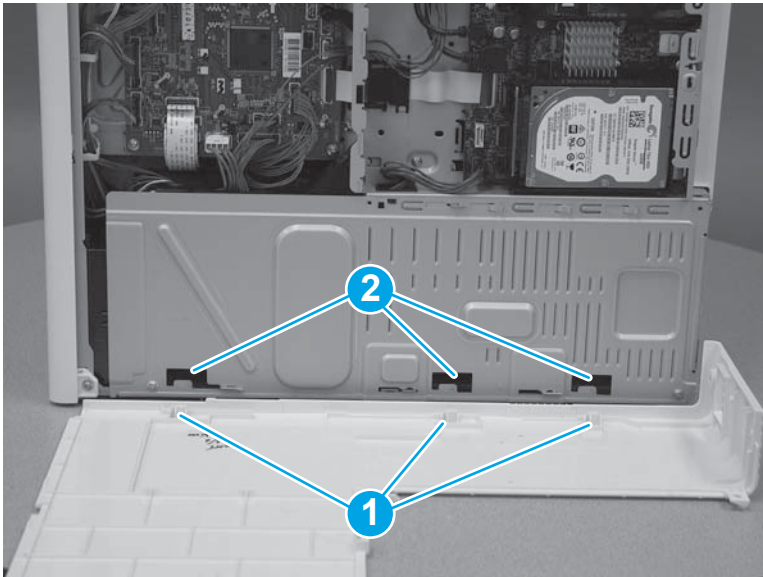

2. Position the back edge (callout 1) of the rear cover behind the edge (callout 2) of the right rear cover. Slide the cover to the left to install it.

Figure 1-645 Install the cover

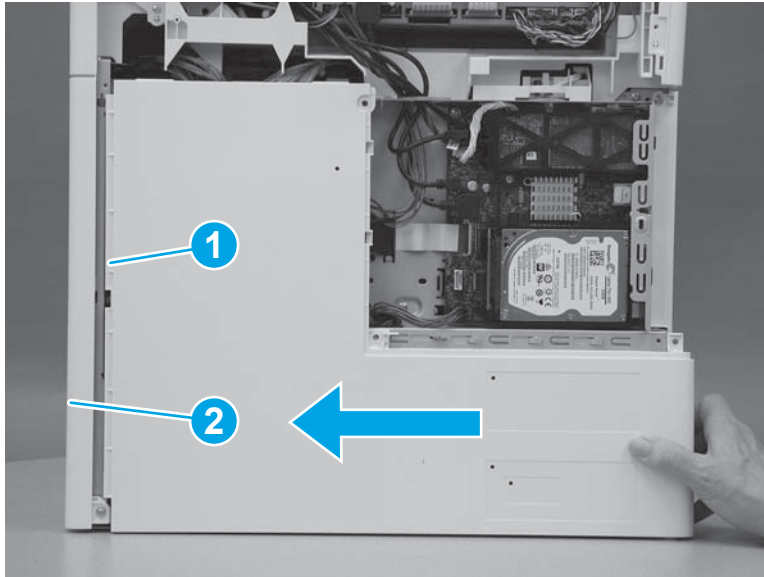

3. Install four screws (callout 1).

Figure 1-646 Install four screws cover

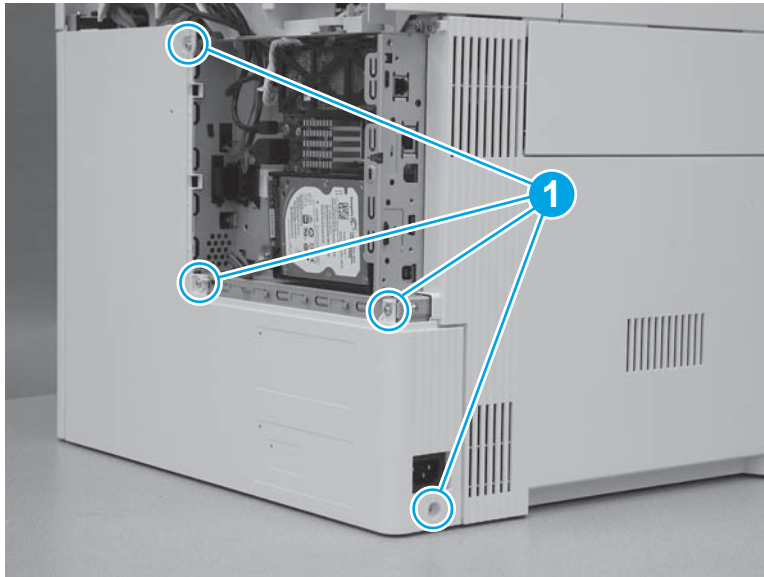

Step 10: Install the rear upper cover (M577)

 **NOTE:** This step is for the M577 models. For the M552 and M553 models, skip this step and go to [Step 11: Install the rear cover \(M552 and M553\) on page 391.](#)

1. Align the ridge (callout 1) on the lower edge of the rear upper cover in front of the tabs (callout 2) on the top edge of the rear cover.

Figure 1-647 Align the cover

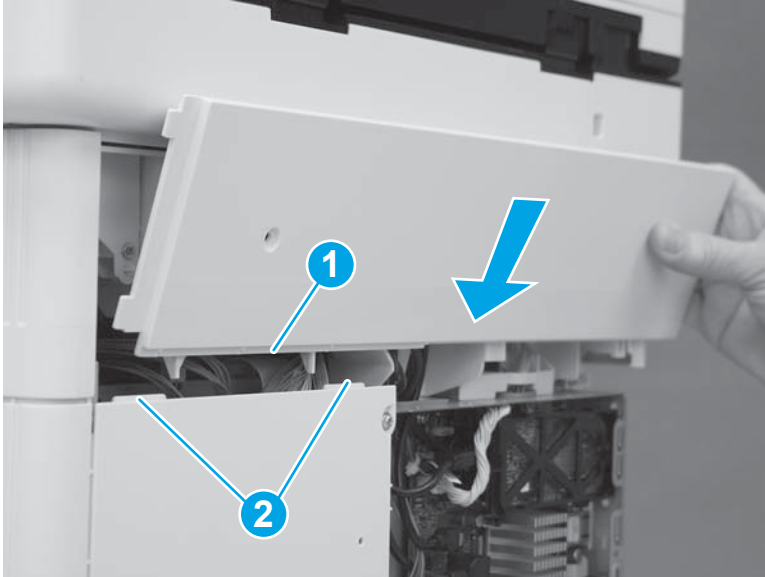

2. Rotate the top of the cover toward the printer.

Figure 1-648 Rotate the top of the cover

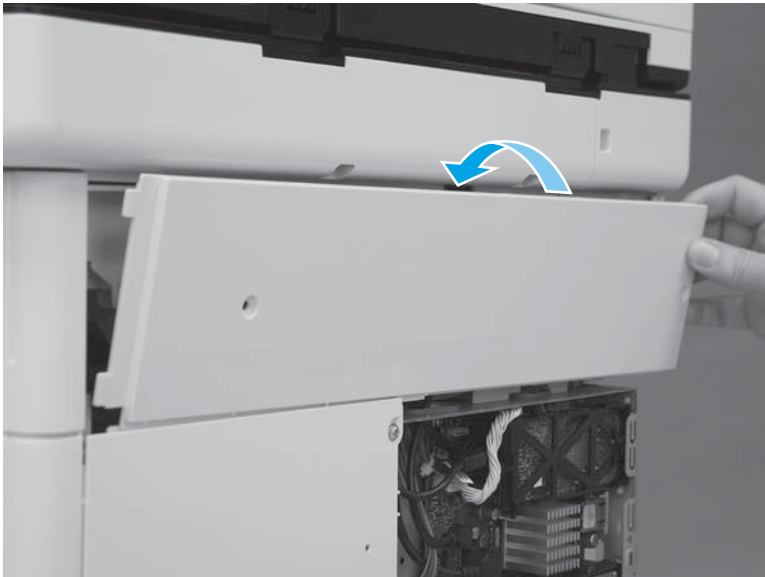

3. Slide the cover to the left (callout 1). Make sure that the tabs (callout 2) on the upper rear cover slide behind the edge (callout 3) of the right upper cover. Make sure that the cover is fully seated.

Figure 1-649 Slide the cover

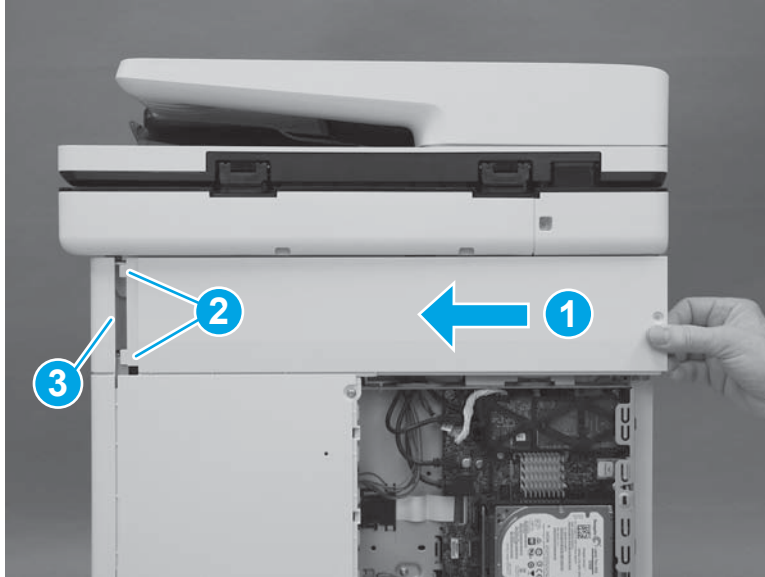

4. Install two screws (callout 1).



 **IMPORTANT:** These two screws are self-tapping screws for plastic. Rotate them counterclockwise to align them with the existing thread pattern, and then carefully turn them clockwise to tighten. Do not overtighten. This will prevent stripping the threads inside the screw holes.

Figure 1-650 Install two screws

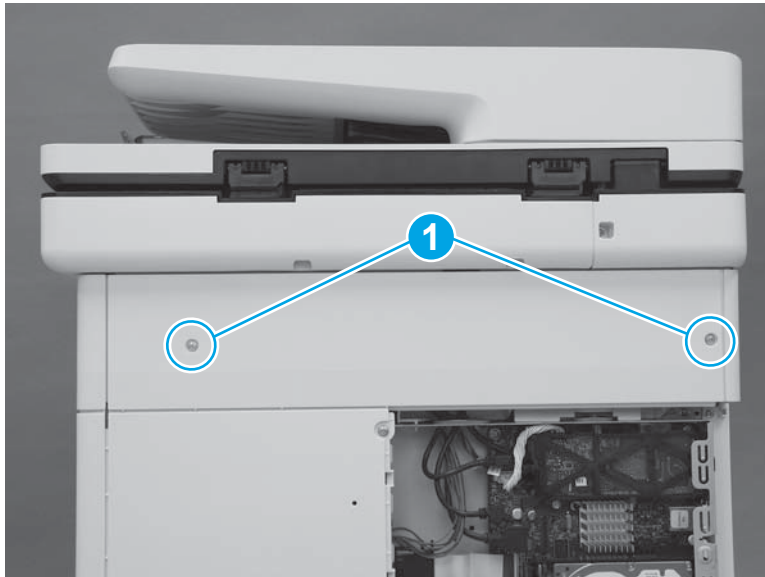

Step 11: Install the rear cover (M552 and M553)

 **NOTE:** This step is for the M552 and M553 models. For the M577 models, skip this step and go to [Step 12: Install the formatter cover on page 392](#).

1. Position the top of the cover under the upper cover (callout 1), rotate the bottom of the cover onto the chassis (callout 2), and then slide the cover to the left (callout 3) to install it.

Figure 1-651 Install the cover

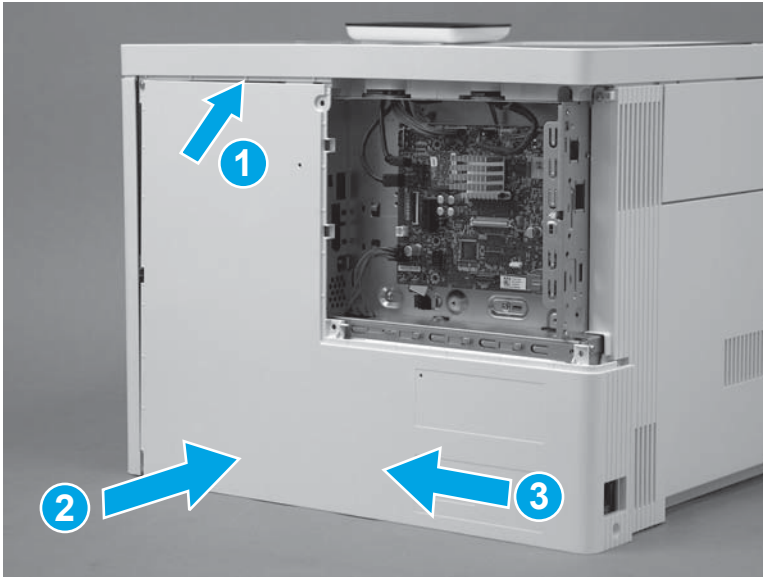

2. Install four screws (callout 1).

Figure 1-652 Install four screws cover

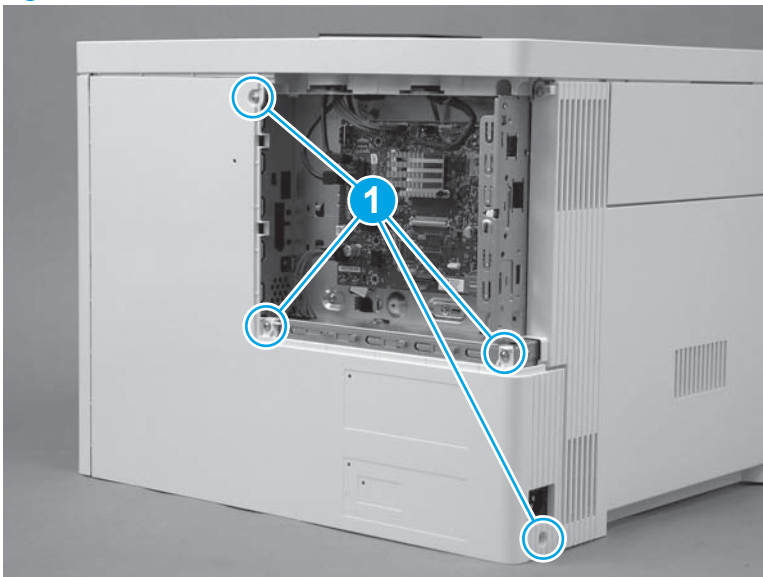

Step 12: Install the formatter cover

- ▲ Slide the cover onto the printer (callout 1) to install it.

 **NOTE:** Make sure that the tabs on the formatter cover align with the slots provided in the printer (callout 2). Tighten the two thumbscrews (callout 3).

 **TIP:** If needed, use the edge of a coin to turn the thumbscrews.

Figure 1-653 Install the cover



Step 13: Install the TCU

1. Verify that the toner collection hatch cover is in the closed position on the TCU.

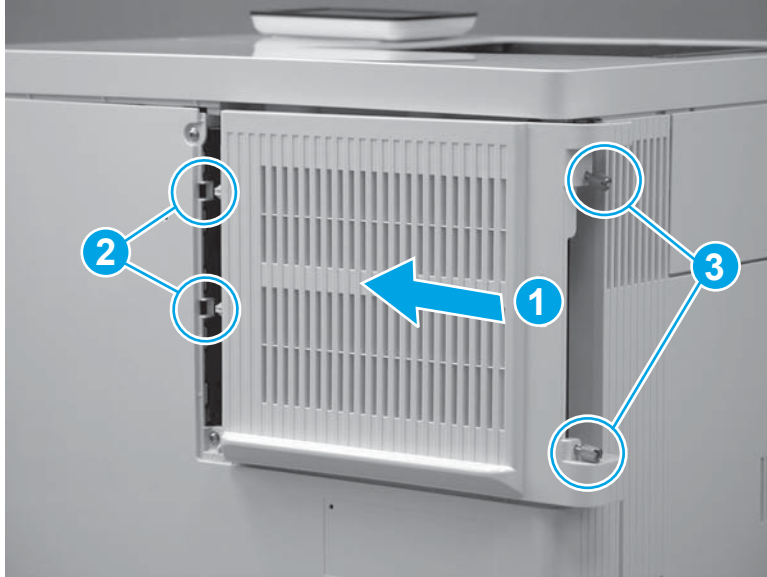
Figure 1-654 Verify that the toner collection hatch cover is closed

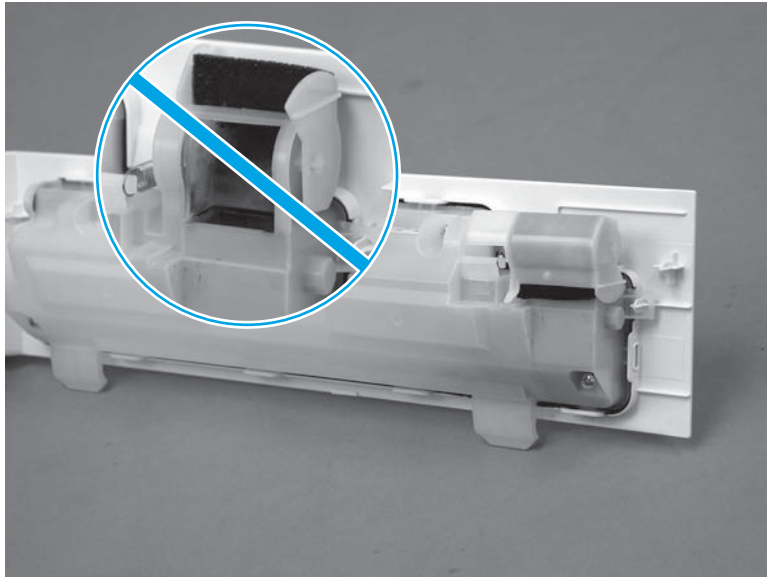

2. Position the TCU with the hinges in the slots provided in the printer (callout 1), and then rotate the TCU up and into the closed position.

 **NOTE:** The toner collection hatch cover automatically opens when the TCU is closed.

Figure 1-655 Install the TCU



3. Close the front door.

Figure 1-656 Close the front door

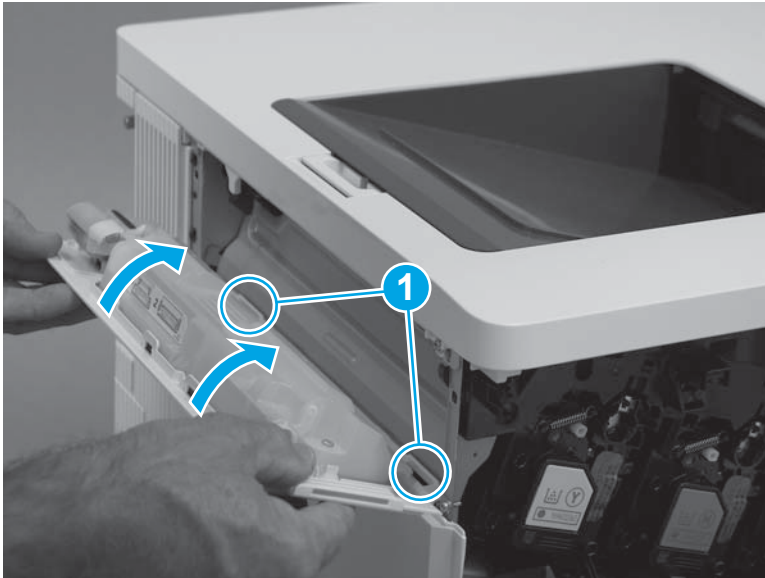

Removal and replacement: Upper cover (M552 and M553)

- [Introduction](#)
- [Step 1: Remove the USB cover](#)
- [Step 2: Remove the HIP cover](#)
- [Step 3: Remove the control panel \(M553x only\)](#)
- [Step 4: Remove the toner collection unit \(TCU\)](#)
- [Step 5: Remove the formatter cover](#)
- [Step 6: Remove the rear cover](#)
- [Step 7: Remove the left cover](#)
- [Step 8: Remove the upper cover](#)
- [Step 9: Unpack the replacement assembly](#)
- [Step 10: Install the upper cover](#)
- [Step 11: Install the left cover](#)
- [Step 12: Install the rear cover](#)
- [Step 13: Install the formatter cover](#)
- [Step 14: Install the TCU](#)
- [Step 15: Install the control-panel assembly \(M553x only\)](#)
- [Step 16: Install the HIP cover](#)
- [Step 17: Install the USB cover](#)

Introduction

This document provides the procedures to remove and replace the upper cover.

Before performing service

Turn the printer power off

- Disconnect the power cable.

 **WARNING!** To avoid damage to the printer, turn the printer off, wait 30 seconds, and then remove the power cord before attempting to service the printer.

- Open the right door.

Use the table below to identify the correct part number for your printer. To order the part, go to www.hp.com/buy/parts.

Upper cover part number

RL2-0097-000CN

Upper cover (M533x)

RL2-0098-000CNUpper cover (M533n/dn and M552dn)

Required tools

- #2 Phillips screwdriver with a magnetic tip
- Small flat blade screwdriver

After performing service

Make sure that the USB cover is fully seated after replacing it.

Make sure that the TCU is fully closed after replacing it.

Make sure that the formatter cover is fully seated, and that the thumbscrews are finger tight after replacing it.

Turn the printer power on

- Connect the power cable.
- Use the power switch to turn the power on.

Step 1: Remove the USB cover

 **TIP:** Set this cover aside for installation on the replacement upper cover.

1. Locate the USB cover.

Figure 1-657 Locate the USB cover

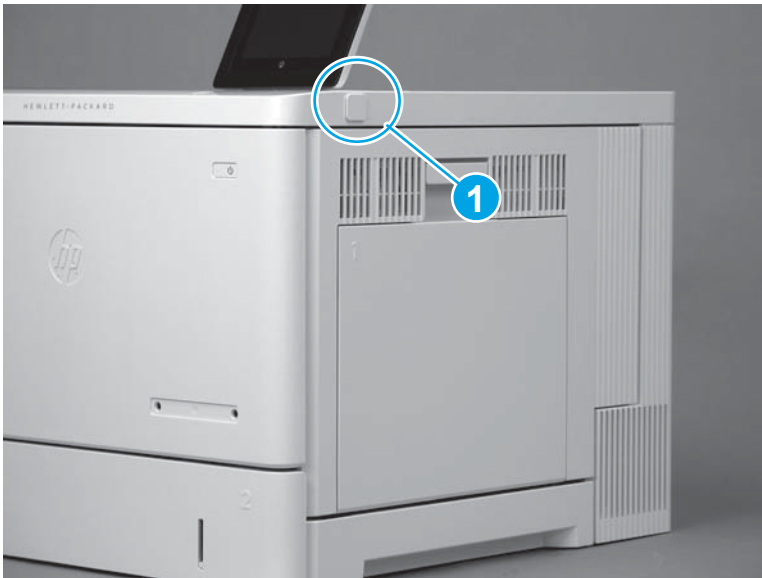

2. Pull the cover off of the printer to remove it.

Figure 1-658 Remove the cover



Step 2: Remove the HIP cover

 **TIP:** Set this cover aside for installation on the replacement upper cover.

1. Locate the HIP cover.

Figure 1-659 Locate the HIP cover



2. Before proceeding, take note of the mounting feet (callout 1) and tabs (callout 2) on the HIP cover.

Figure 1-660 Note the mounting feet and tabs

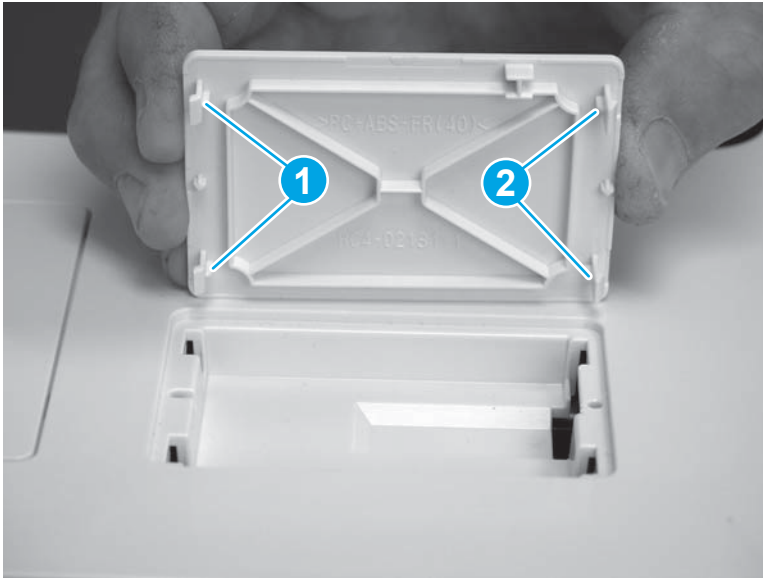

3. Use a small flat-blade screwdriver to release the tabs on the HIP cover.

Figure 1-661 Release the HIP cover tabs

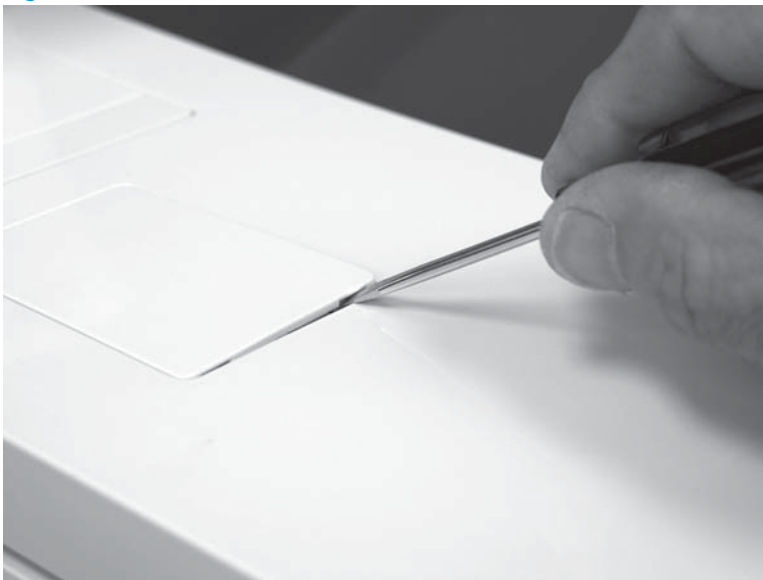

4. Rotate the cover up and off of the printer to remove it.

Figure 1-662 Remove the cover

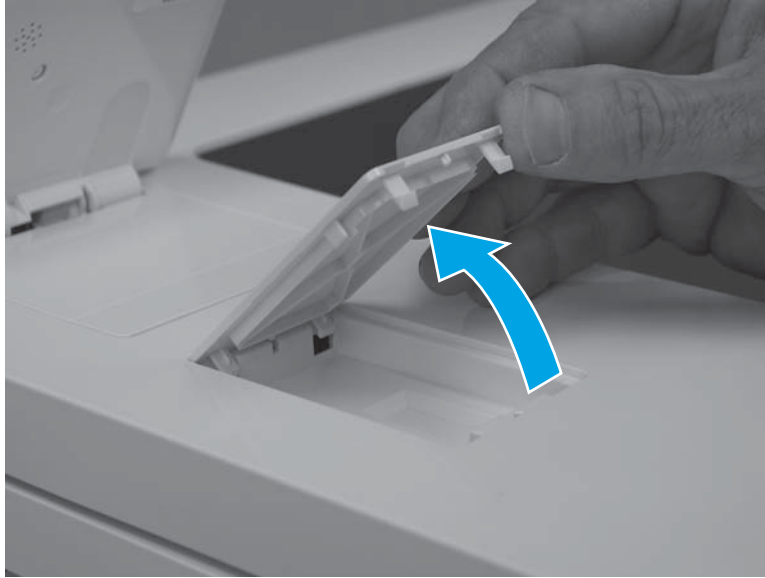

Step 3: Remove the control panel (M553x only)

 **NOTE:** For the M553n/dn and M552dn models, skip this step and go to [Step 4: Remove the toner collection unit \(TCU\) on page 403](#).

 **TIP:** Set the control panel aside for installation on the replacement upper cover.

1. Tilt the control panel up.

Figure 1-663 Tilt the control panel up



2. Use a small flat-blade screwdriver to release the control-panel screws cover tabs.

Figure 1-664 Release the control-panel screws cover tabs



3. Rotate the cover up to remove it.

Figure 1-665 Remove the cover



4. Use a small Phillips screwdriver to remove two screws (callout 1).

 **IMPORTANT:** Store the screws in a secure place where they cannot fall down into the printer.

Figure 1-666 Remove two screws



5. Rotate the control-panel base toward the front of the printer.

Figure 1-667 Rotate the control-panel base up

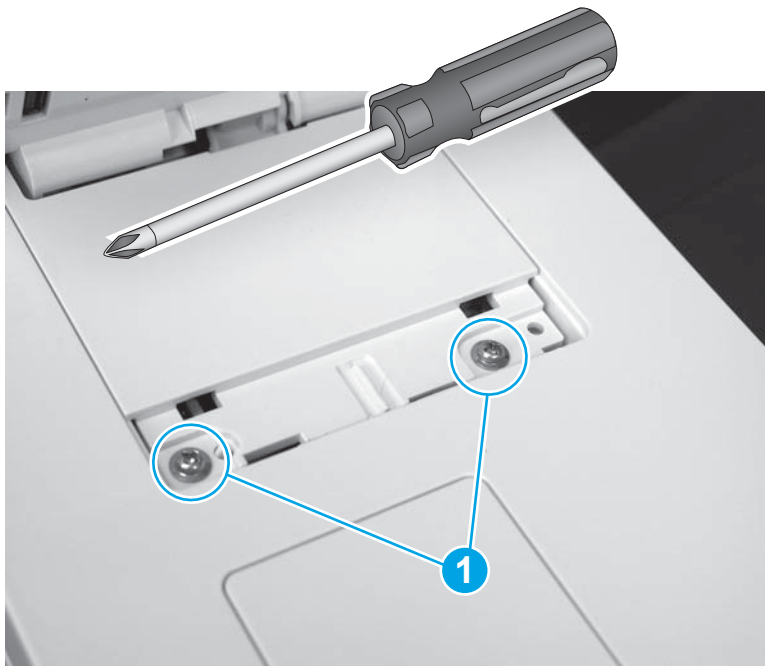

6. Slightly slide the control-panel base toward the rear of the printer (callout 1) to release it, and then turn the control panel over (callout 2) to access the bottom side.

CAUTION: The control panel is still attached to the printer. Do not attempt to completely remove the control panel.

Figure 1-668 Turn the control panel over

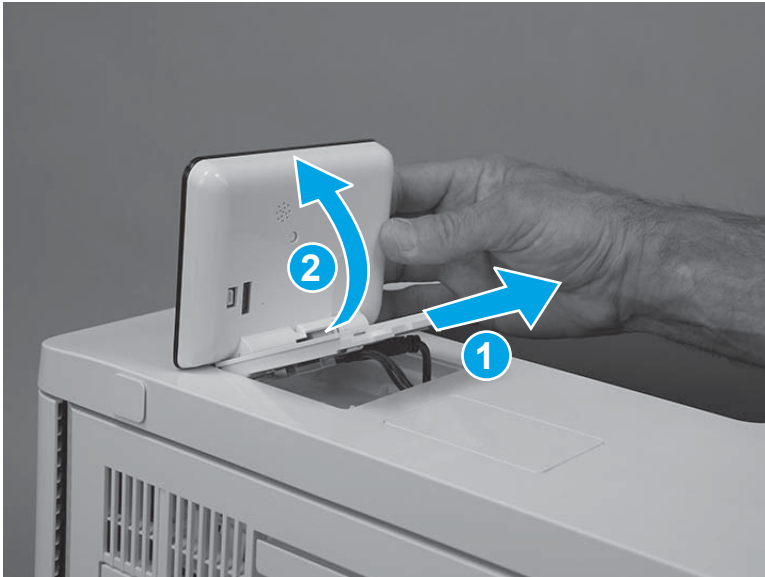

7. Disconnect one USB cable (callout 1), one connector (callout 2), and then remove the control panel.

Figure 1-669 Disconnect two connectors

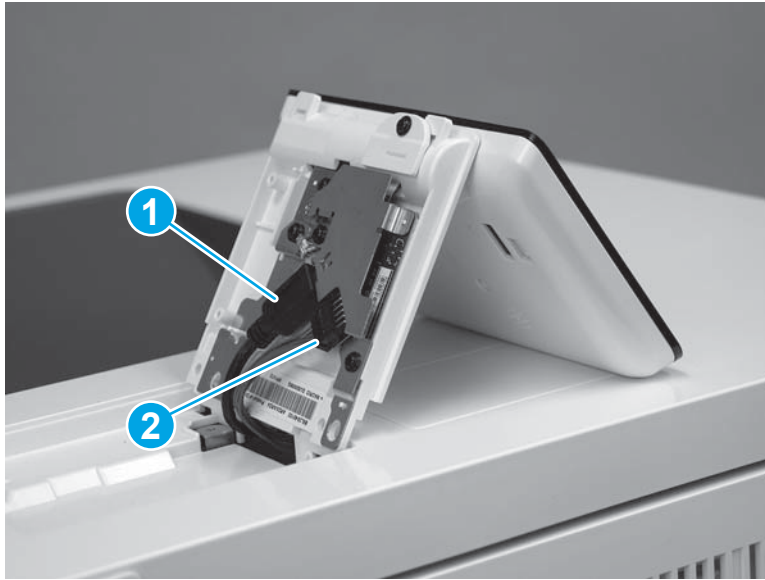

Step 4: Remove the toner collection unit (TCU)

1. Open the front door.

Figure 1-670 Open the front door



2. Open the TCU.

 **NOTE:** The toner collection hatch cover automatically closes when the TCU is opened.

Figure 1-671 Open the TCU



3. Pull the TCU away from the printer at an angle to remove it.

⚠ CAUTION: Do not open the toner collection hatch cover when handling the TCU. If toner gets on clothing, wipe it off by using a dry cloth and wash the clothes in cold water. Hot water sets toner into fabric.

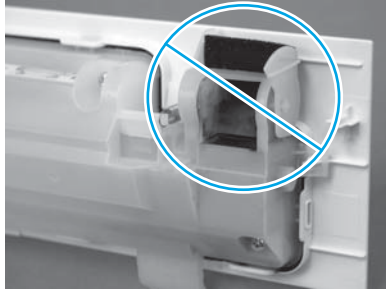
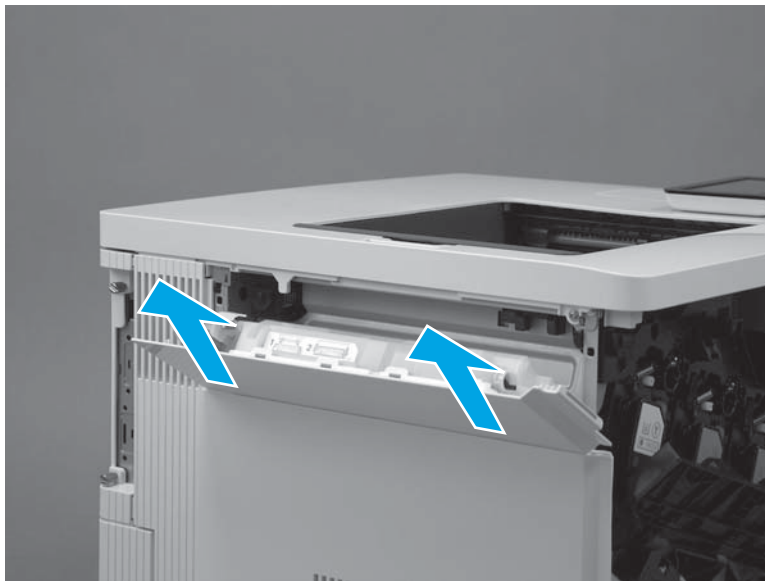

Figure 1-672 Remove the TCU



Step 5: Remove the formatter cover

1. Locate the formatter cover.

Figure 1-673 Locate the formatter cover

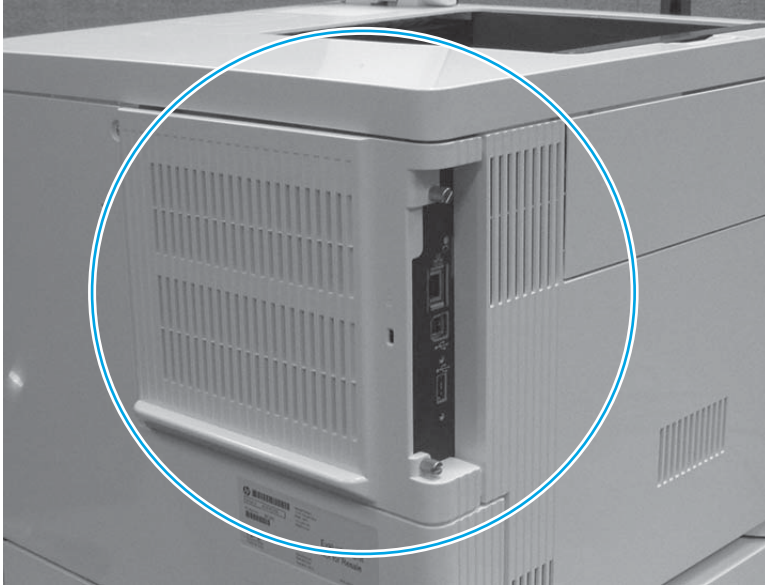

2. Loosen the two thumbscrews (callout 1). Grasp the two thumbscrews, and then slide the cover away from the printer (callout 2) to remove it.

 **TIP:** If needed, use the edge of a coin to turn the thumbscrews.

Figure 1-674 Loosen the thumbscrews



Step 6: Remove the rear cover

1. Remove four screws (callout 1).

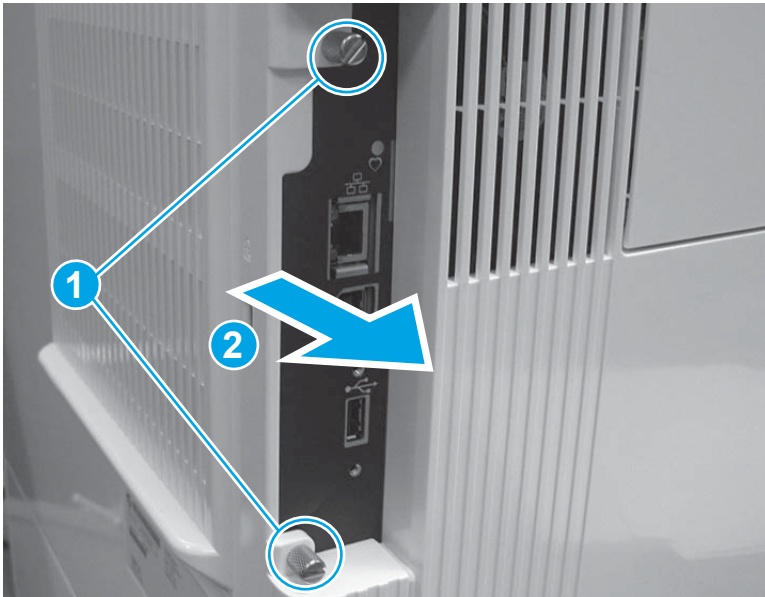
Figure 1-675 Remove four screws

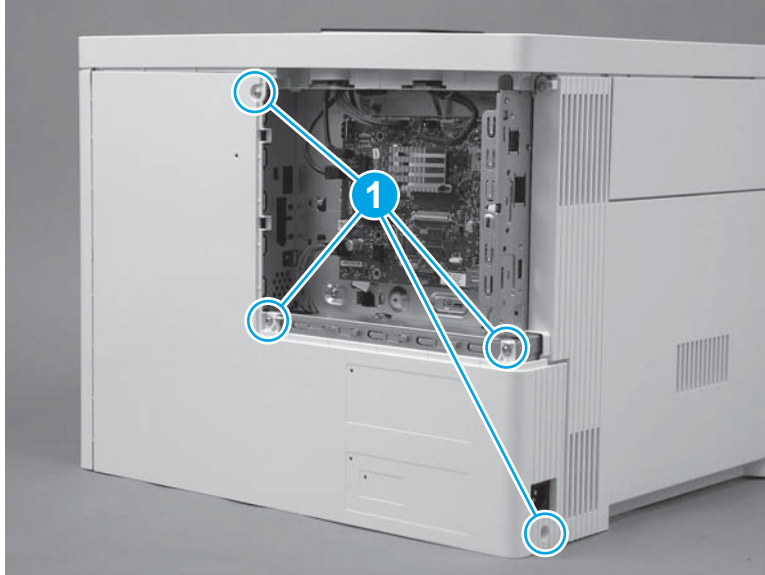

2. Slightly slide the cover to the right (callout 1), rotate the bottom of the cover away from the printer (callout 2), and then pull the top of the cover away from the printer (callout 3) to remove the cover.

Figure 1-676 Remove the cover

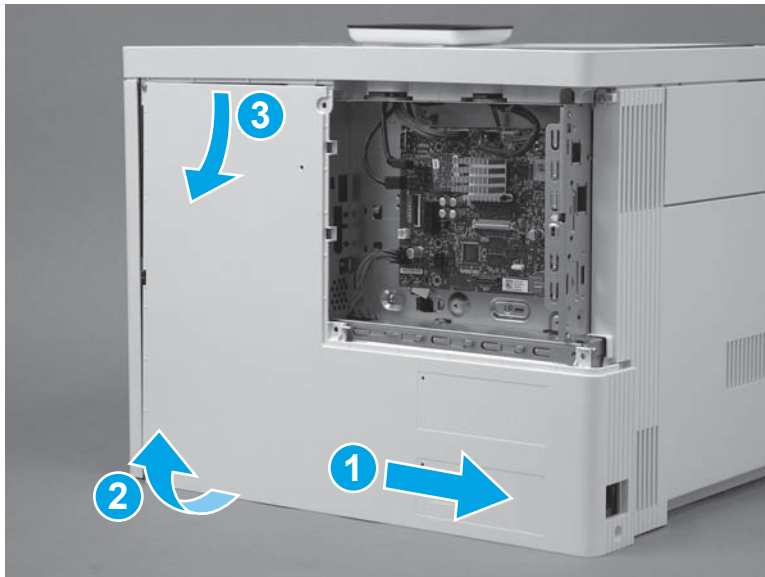

Step 7: Remove the left cover

1. At the left side of the printer, remove one screw (callout 1).

Figure 1-677 Remove one screw



2. Release one tab (callout 1), rotate the front edge of the cover away from the printer (callout 2), and then slide the cover (callout 3) toward the rear of the printer to release it.

Figure 1-678 Release the cover

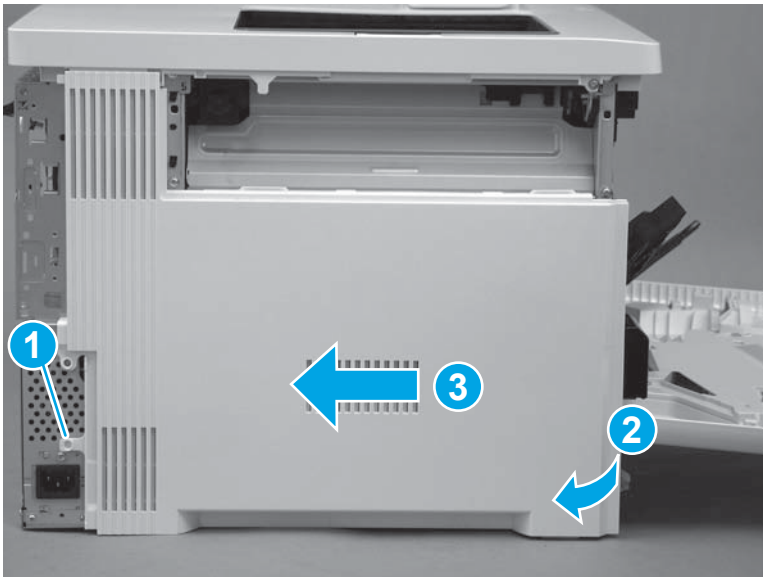

3. Remove the cover.

Figure 1-679 Remove the cover

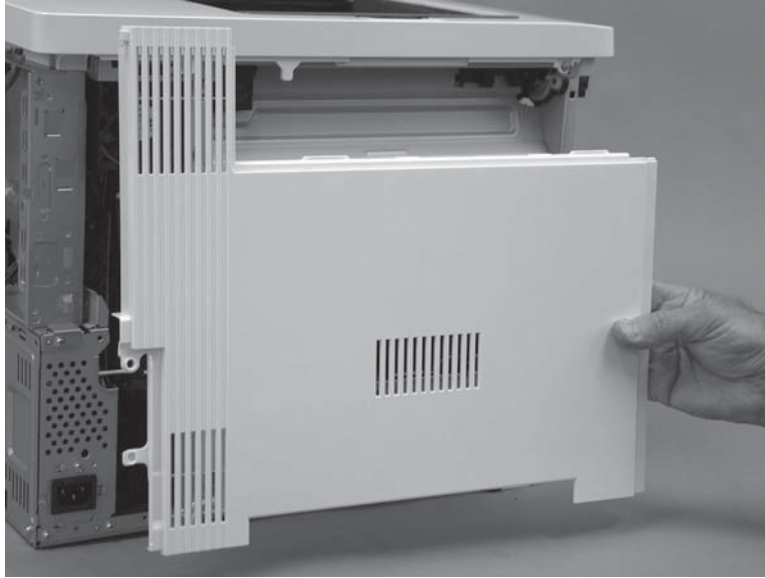

Step 8: Remove the upper cover

1. Remove three screws (callout 1).

Figure 1-680 Remove three screws

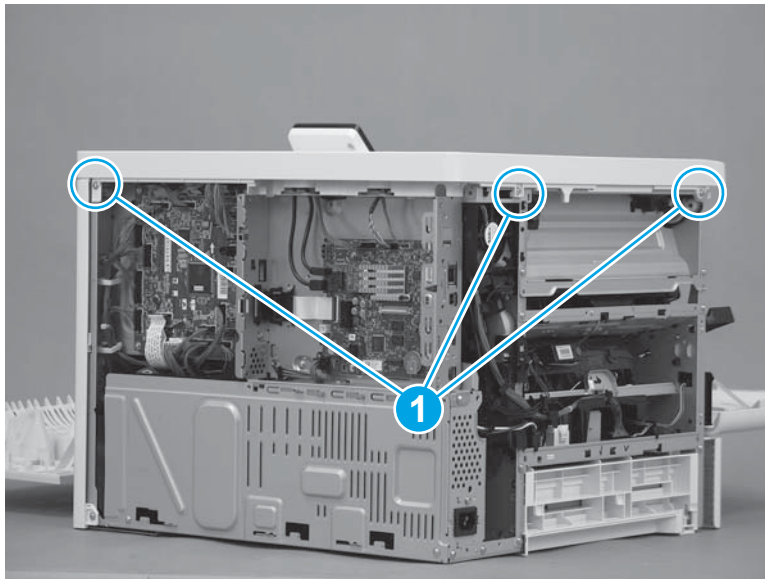

2. Remove one screw (callout 1), release one tab (callout 2), and then slightly separate the corner of the cover from the chassis.

 **NOTE:** This is a self-tapping plastic-thread screw. Make sure that this screw is used in this location when it is reinstalled.

Figure 1-681 Remove one screw and release one tab



3. Release one tab (callout 1), and then lift up on the cover to release it.

 **NOTE:** If the cover does not release, check for additional tabs by locating the triangles embossed in the cover at tab locations.

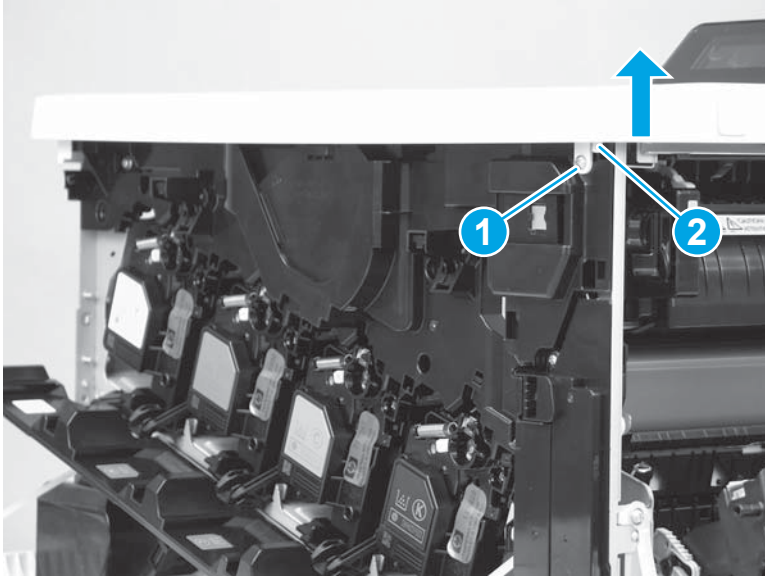
Figure 1-682 Release the cover



4. Remove the cover.

Figure 1-683 Remove the cover

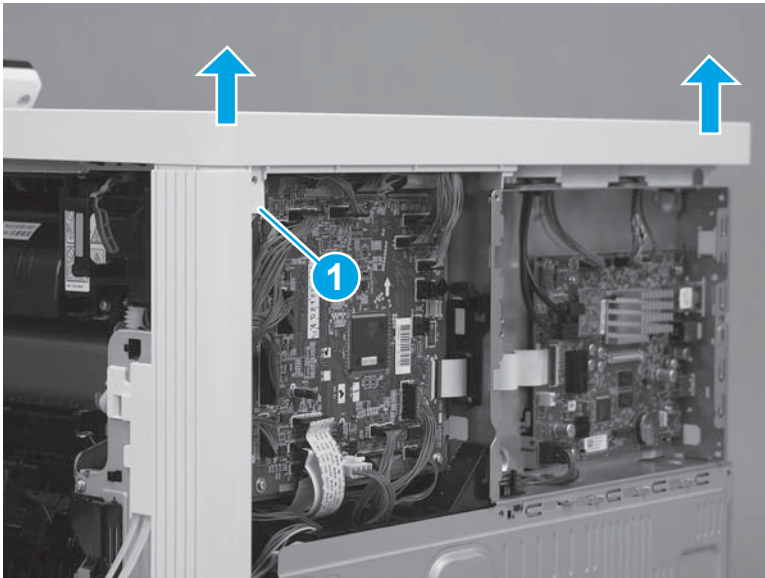
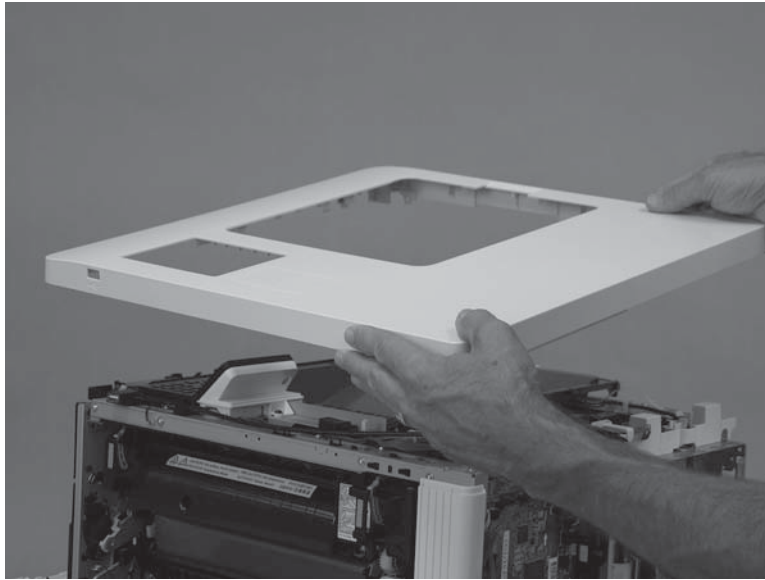

Step 9: Unpack the replacement assembly

Unpack the replacement assembly from the packaging.

For complete information on HP's recycling programs, go to [Product return and recycling](#).

 **NOTE:** HP recommends responsible disposal of the defective assembly.

Figure 1-684 Recycle and unpack

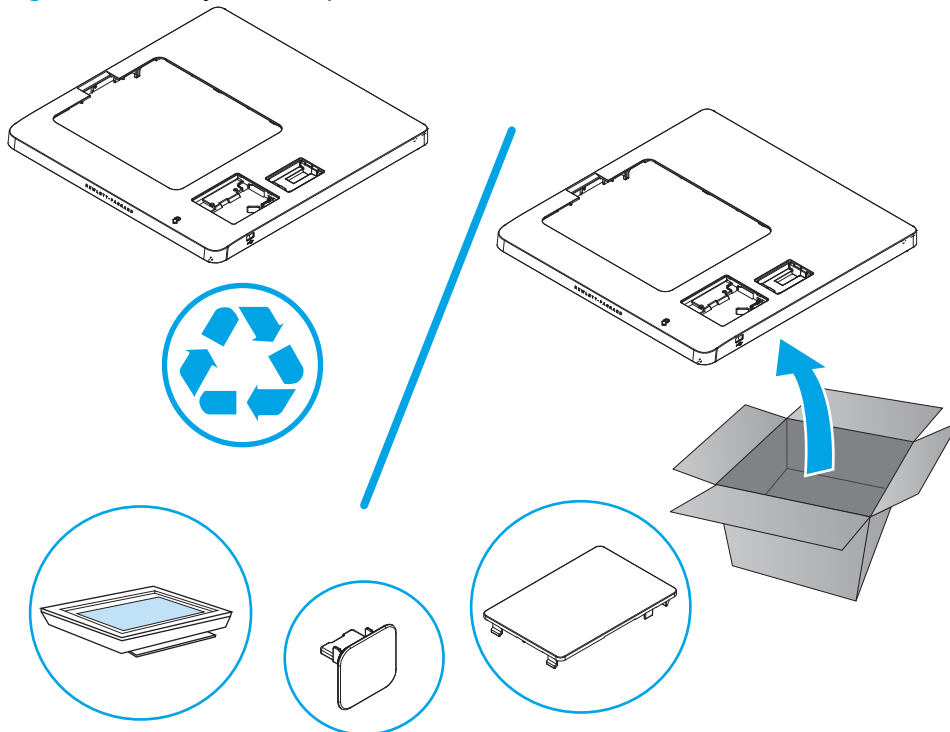

Step 10: Install the upper cover

1. Position the cover on the printer.

 **NOTE:** For the M553x model, do not forget to pass the control-panel wire harness and USB cable through the opening in the cover.

Figure 1-685 Install the cover



2. Push down on the rear corner of the cover to engage one tab (callout 1).

Figure 1-686 Engage one tab

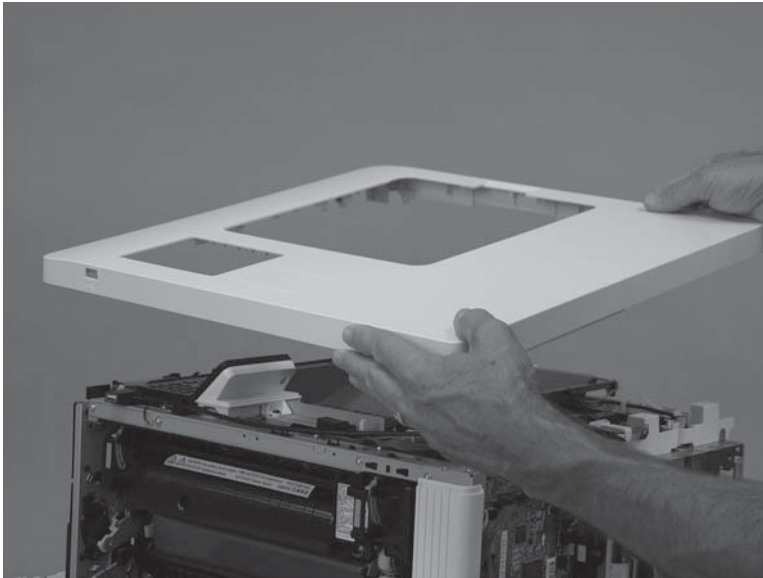
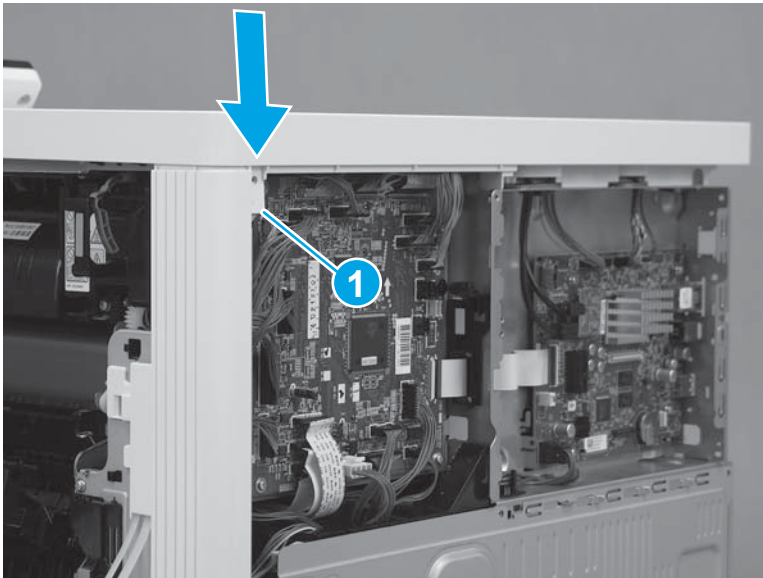

3. Push down on the front corner of the cover to engage one tab (callout 1), and then install one screw (callout 2).

 **NOTE:** This is a self-tapping plastic-thread screw. Make sure that this screw is used in this location when it is reinstalled.

Figure 1-687 Engage one tab and install one screw



4. Install three screws (callout 1).

Figure 1-688 Install three screws

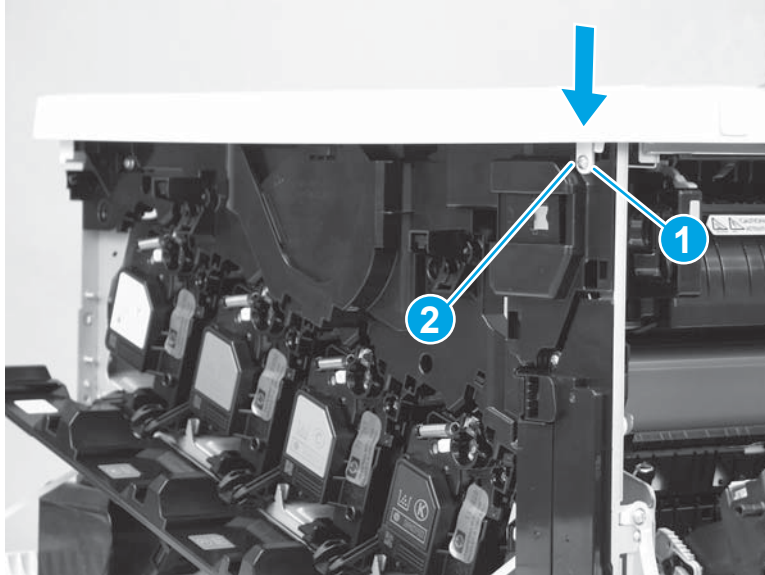
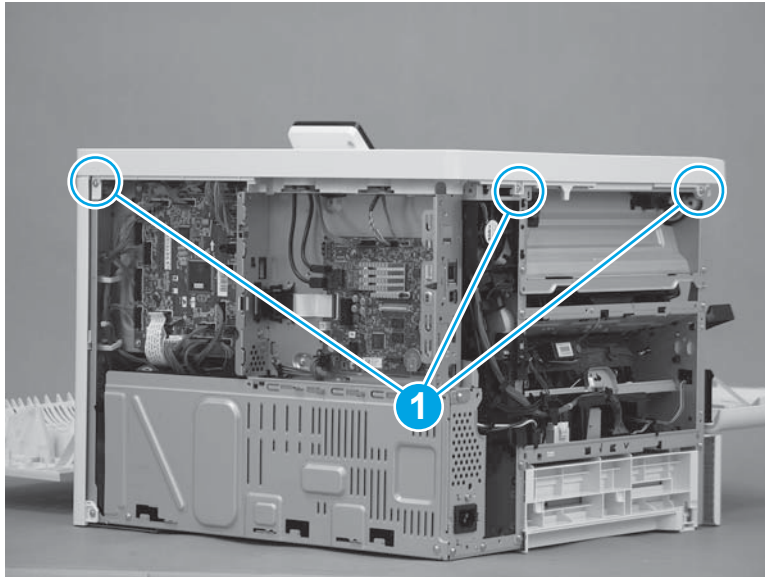

Step 11: Install the left cover

1. Position the cover on the printer.

 **NOTE:** Slightly offset the cover toward the rear of the printer.

Figure 1-689 Install the cover

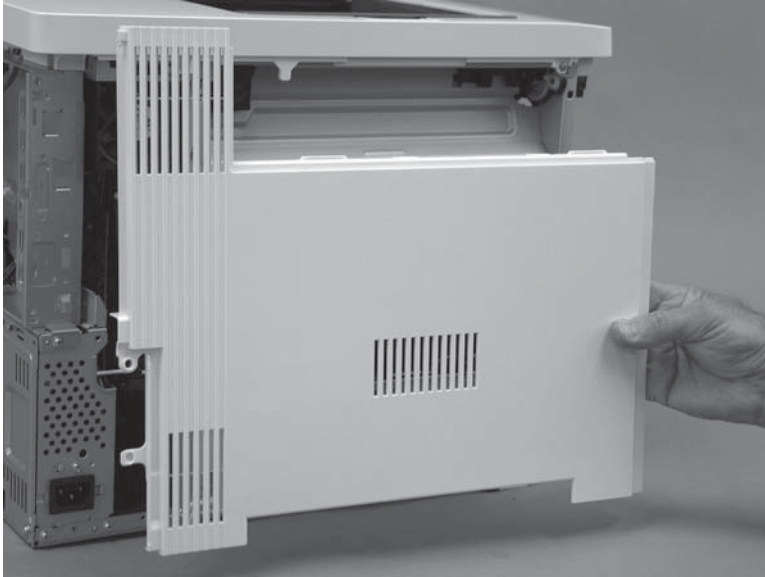

2. Slide the cover (callout 1) toward the front of the printer to engage it. Make sure that the tab (callout 2) snaps into place.

 **NOTE:** Locate the alignment pin (callout 3) on the cover from the front door side of the printer, and then make sure that it is fully engaged in the slot in the chassis.

 **TIP:** While sliding the cover into place, push in on the center of the cover (callout 1) to make sure that the hooks on the back of the cover engage with the slots in the chassis.

Figure 1-690 Engage the cover



3. At the left side of the printer, install one screw (callout 1).

Figure 1-691 Install one screw

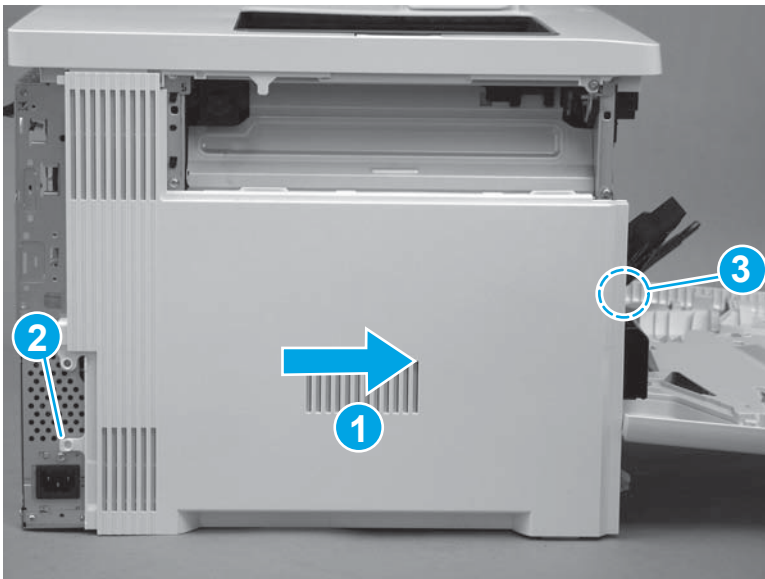

Step 12: Install the rear cover

1. Position the top of the cover under the upper cover (callout 1), rotate the bottom of the cover onto the chassis (callout 2), and then slide the cover to the left (callout 3) to install it.

Figure 1-692 Install the cover

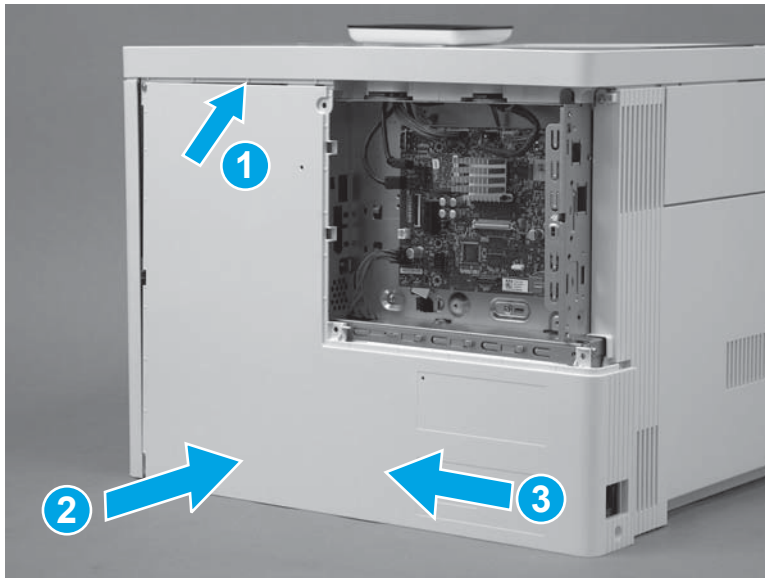

2. Install four screws (callout 1).

Figure 1-693 Install four screws cover

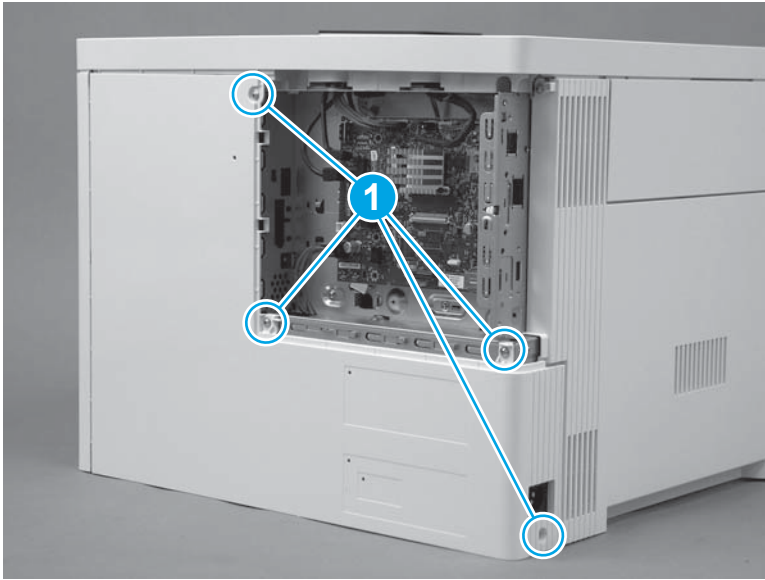

Step 13: Install the formatter cover

- ▲ Slide the cover onto the printer (callout 1) to install it.

 **NOTE:** Make sure that the tabs on the formatter cover align with the slots provided in the printer (callout 2). Tighten the two thumbscrews (callout 3).

 **TIP:** If needed, use the edge of a coin to turn the thumbscrews.

Figure 1-694 Install the cover



Step 14: Install the TCU

1. Verify that the toner collection hatch cover is in the closed position on the TCU.

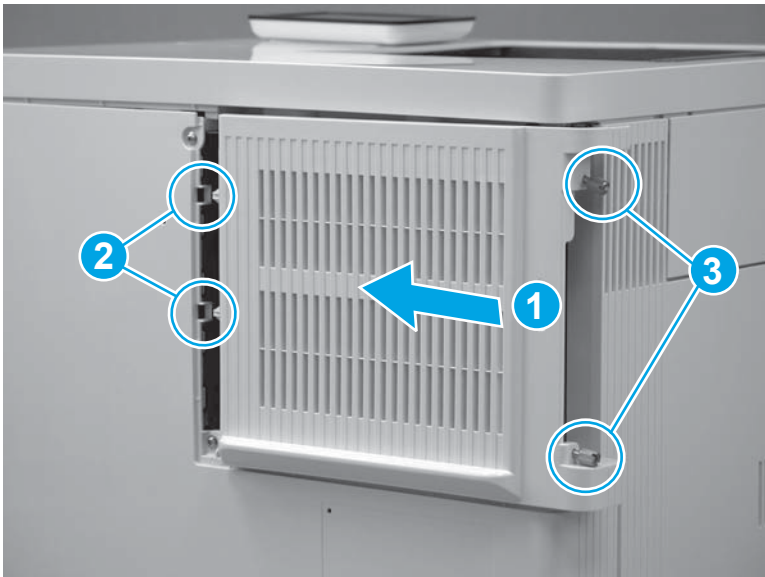
Figure 1-695 Verify that the toner collection hatch cover is closed

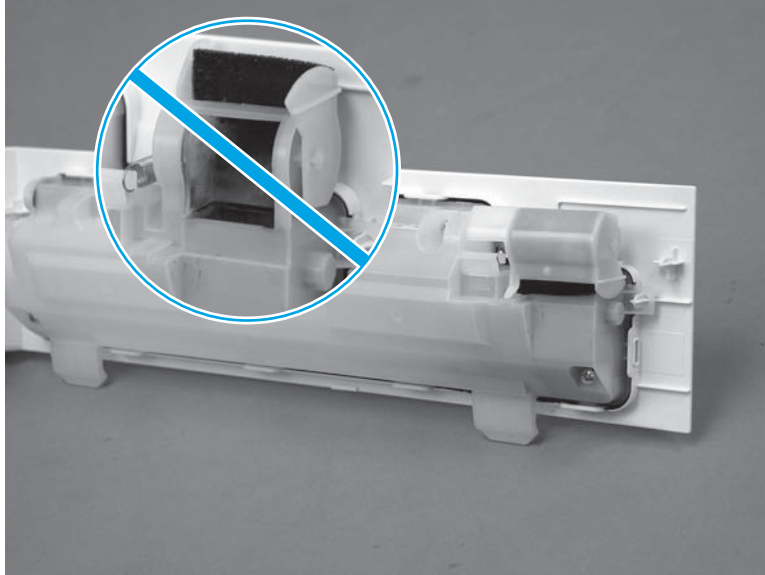

2. Position the TCU with the hinges in the slots provided in the printer (callout 1), and then rotate the TCU up and into the closed position.

 **NOTE:** The toner collection hatch cover automatically opens when the TCU is closed.

Figure 1-696 Install the TCU



3. Close the front door.

Figure 1-697 Close the front door

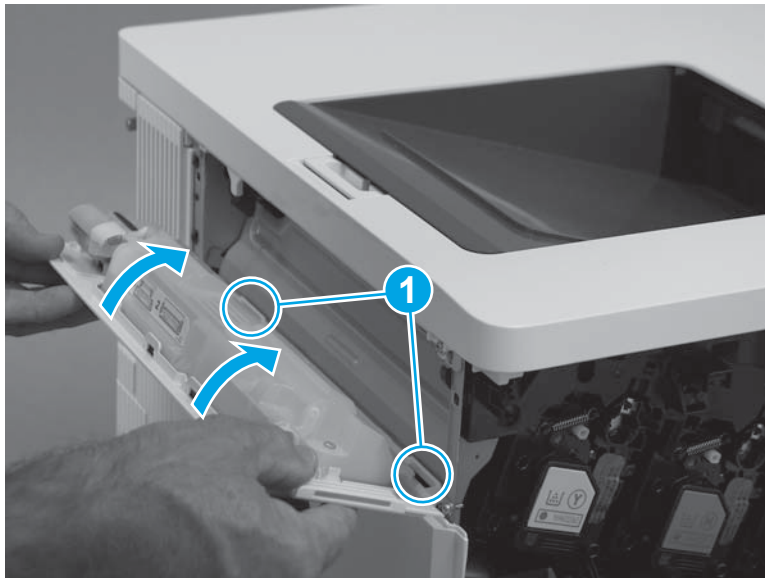

Step 15: Install the control-panel assembly (M553x only)

 **NOTE:** For the M553n/dn and M552dn models, skip this step and go to [Step 16: Install the HIP cover on page 421](#).

1. Place the control panel on the printer as shown.

Figure 1-698 Place the control panel on the product

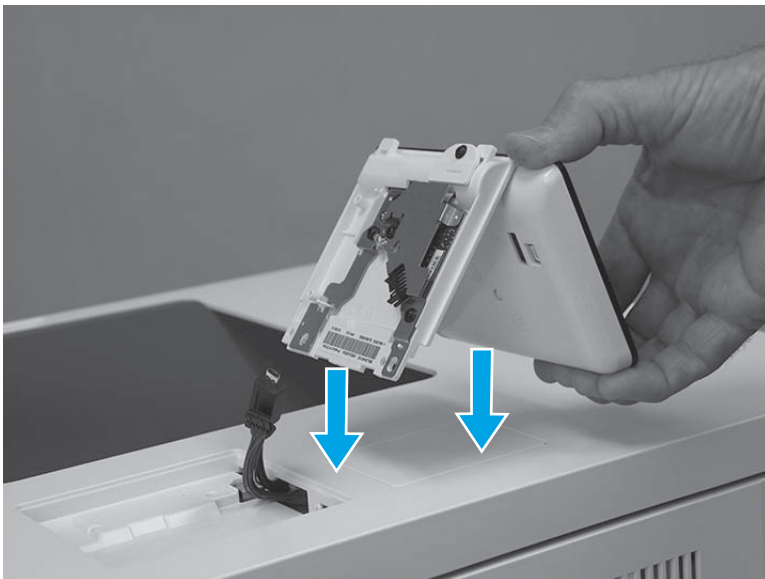

2. Connect one USB cable (callout 1), and one connector (callout 2).

 **IMPORTANT:** Take note of the location of the two mounting tabs (callout 3) on the control-panel assembly.

Figure 1-699 Connect two connectors



3. Turn the control panel over, and then position the front edge tabs in the slots in the top cover.

Figure 1-700 Turn the control panel over

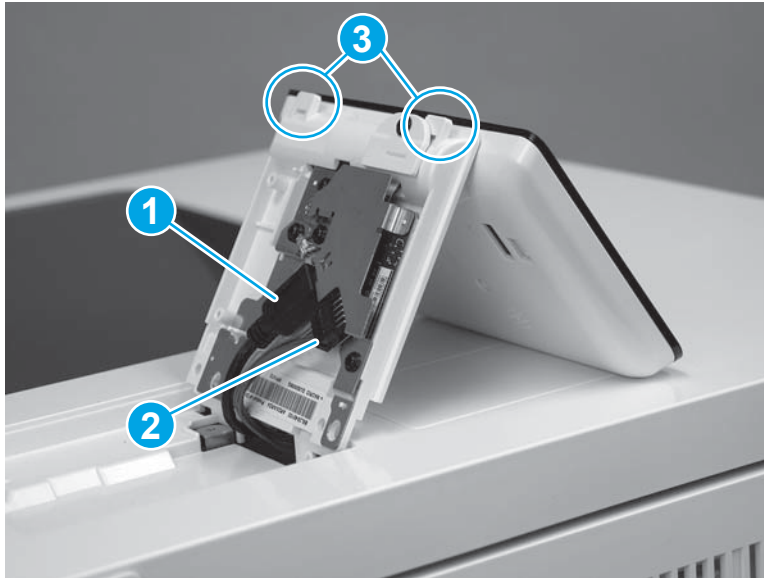
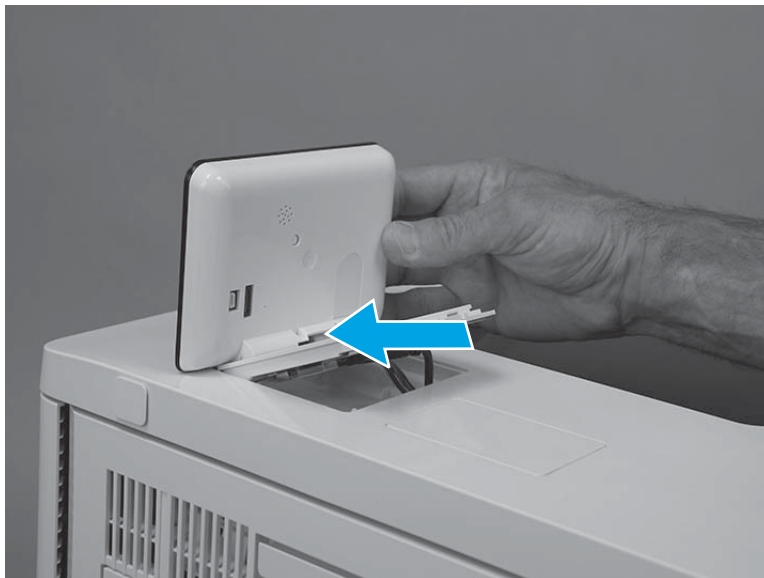

4. Rotate the control-panel base down onto the printer.

Figure 1-701 Rotate the control-panel base down



5. Use a small Phillips screwdriver to install two screws (callout 1).

Figure 1-702 Install two screws

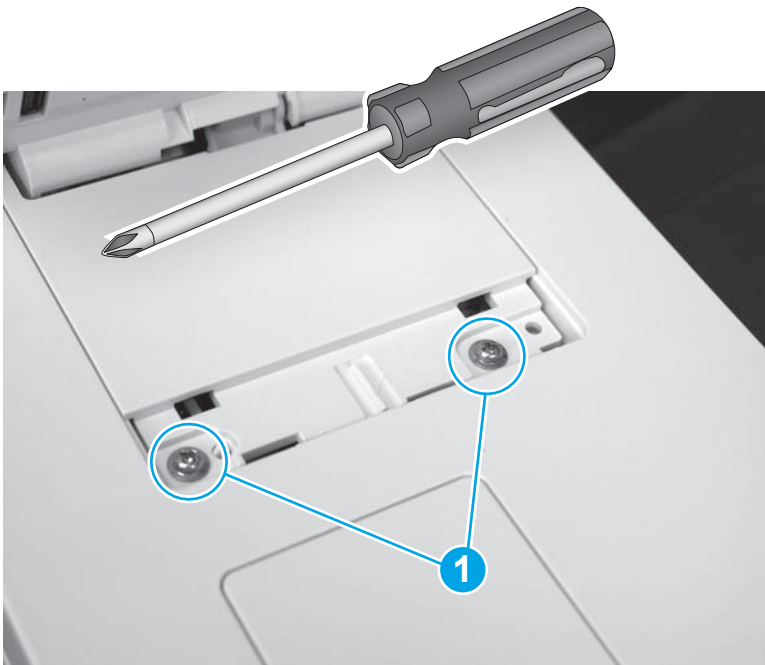

6. Position the screw cover mounting feet into the slots in the top cover (callout 1), and then rotate the cover down (callout 2) to install it.

 **NOTE:** Press down on the cover firmly to make sure that the tabs on the cover (callout 3) snap into place.

Figure 1-703 Install the cover



Step 16: Install the HIP cover

1. Position the HIP cover mounting feed in the slots (callout 1) provided in the top cover, and then rotate it down to install it.

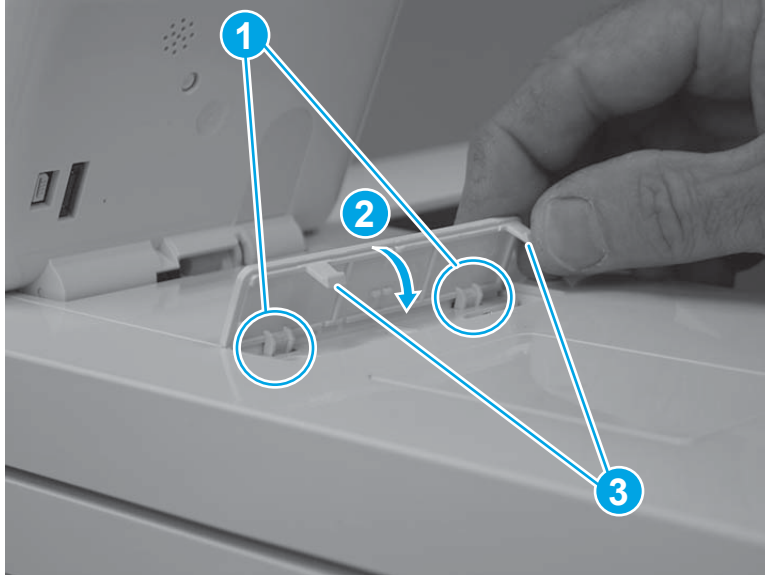
 **NOTE:** Make sure that the tabs on the cover snap into place.

Figure 1-704 Install the cover

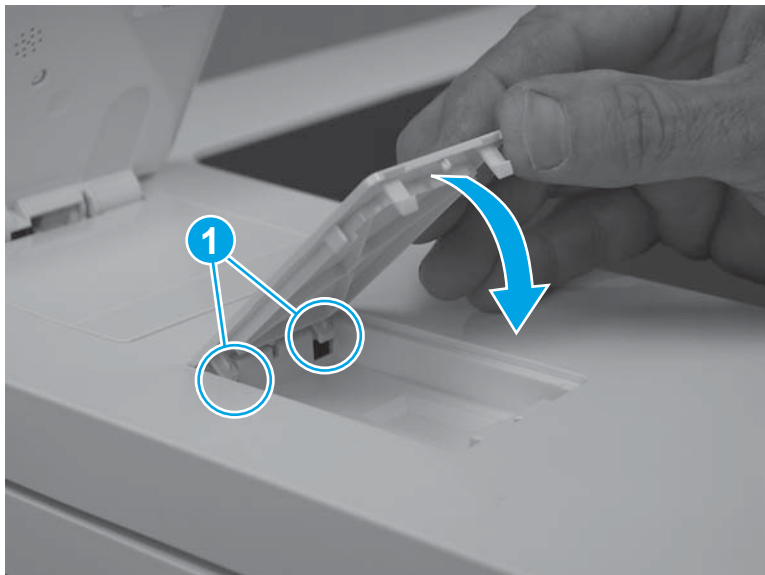

2. Make sure that the HIP cover is fully seated after installing it.

Figure 1-705 Check the installation



Step 17: Install the USB cover

1. Push the cover into the USB port to install it.

Figure 1-706 Install the cover



2. Make sure that the USB cover is fully seated after installing it.

Figure 1-707 Check the installation

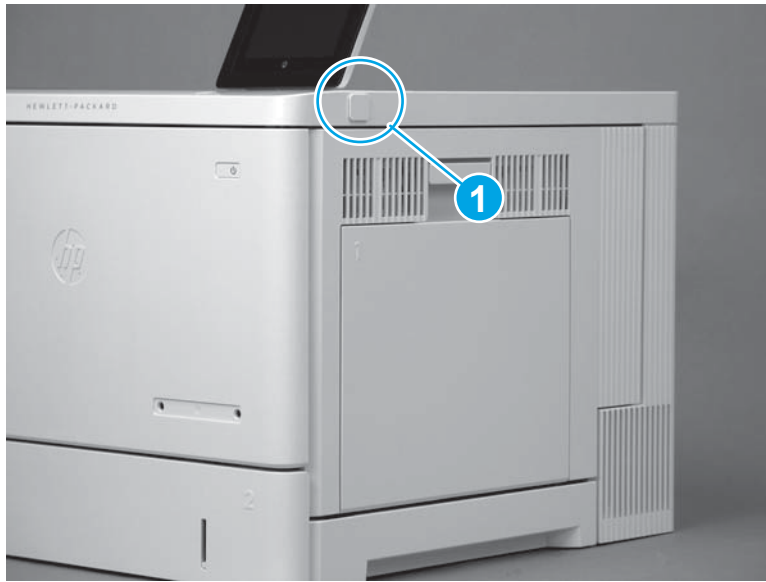

Removal and replacement: Output bin

- [Introduction](#)
- [Step 1: Remove the formatter cover](#)
- [Step 2: Remove the toner collection unit \(TCU\)](#)
- [Step 3: Remove the USB cover \(M552 and M553\)](#)
- [Step 4: Remove the control panel \(M553x only\)](#)
- [Step 5: Remove the rear cover \(M552 and M553\)](#)
- [Step 6: Remove the rear upper cover \(M577\)](#)
- [Step 7: Remove the rear cover \(M577\)](#)
- [Step 8: Remove the left cover](#)
- [Step 9: Remove the upper cover \(M552 and M553\)](#)
- [Step 10: Remove the left upper cover \(M577\)](#)
- [Step 11: Remove the right front upper cover \(M577dn\)](#)
- [Step 12: Remove the stapler cover assembly \(M577c/f/z\)](#)
- [Step 13: Remove the integrated scanner assembly \(M577\)](#)
- [Step 14: Remove the stapler \(M577c/f/z\)](#)
- [Step 15: Remove the right upper cover \(M577\)](#)
- [Step 16: Remove the top rear cover \(M577\)](#)
- [Step 17: Remove the paper feed cover \(M577\)](#)
- [Step 18: Remove the top cover \(M577\)](#)
- [Step 19: Remove the output bin](#)
- [Step 20: Unpack the replacement assembly](#)
- [Step 21: Install the output bin](#)
- [Step 22: Install the top cover \(M577\)](#)
- [Step 23: Install the paper feed cover \(M577\)](#)
- [Step 24: Install the top rear cover \(M577\)](#)
- [Step 25: Install the right upper cover \(M577\)](#)
- [Step 26: Install the stapler \(M577c/f/z\)](#)
- [Step 27: Install the integrated scanner assembly \(M577\)](#)
- [Step 28: Install the stapler cover assembly \(M577c/f/z\)](#)
- [Step 29: Install the right front upper cover \(M577dn\)](#)

- [Step 30: Install the left upper cover \(M577\)](#)
- [Step 31: Install the upper cover \(M552 and M553\)](#)
- [Step 32: Install the left cover](#)
- [Step 33: Install the rear cover \(M577\)](#)
- [Step 34: Install the rear upper cover \(M577\)](#)
- [Step 35: Install the rear cover \(M552 and M553\)](#)
- [Step 36: Install the control-panel assembly \(M553x only\)](#)
- [Step 37: Install the USB cover \(M552 and M553\)](#)
- [Step 38: Install the toner collection unit \(TCU\)](#)
- [Step 39: Install the formatter cover](#)

Introduction

This document provides the procedures to remove and replace the output bin.

Before performing service

Turn the printer power off

- Disconnect the power cable.

 **WARNING!** To avoid damage to the printer, turn the printer off, wait 30 seconds, and then remove the power cord before attempting to service the printer.

- Open the right door.

Use the table below to identify the correct part number for your printer. To order the part, go to www.hp.com/buy/parts.

Output bin part number	
RM2-0044-000CN	Output bin

Required tools

- #2 Phillips screwdriver with a magnetic tip

After performing service

Make sure that the USB cover is fully seated after replacing it.

Make sure that the TCU is fully closed after replacing it.

Make sure that the formatter cover is fully seated, and that the thumbscrews are finger tight after replacing it.

Make sure that the output bin is flat against the chassis after replacing it.

Turn the printer power on

- Connect the power cable.
- Use the power switch to turn the power on.

Step 1: Remove the formatter cover

1. Locate the formatter cover.

Figure 1-708 Locate the formatter cover

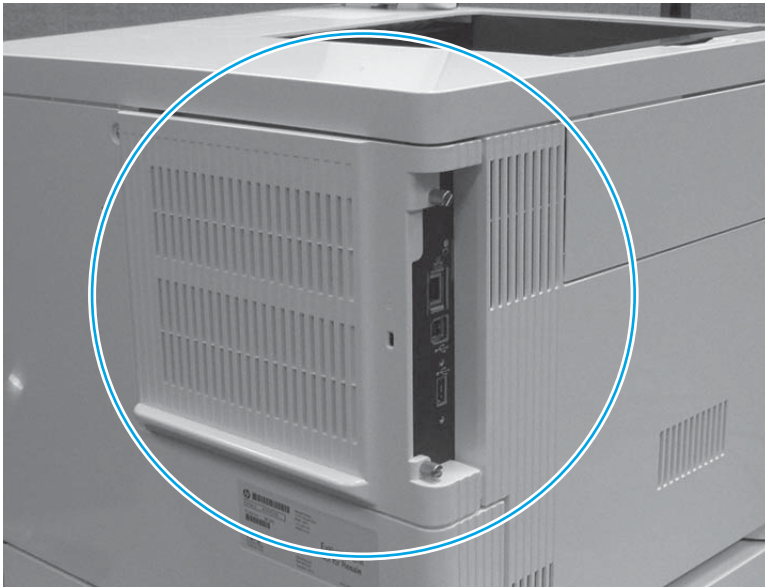

2. Loosen the two thumbscrews (callout 1). Grasp the two thumbscrews, and then slide the cover away from the printer (callout 2) to remove it.

 **TIP:** If needed, use the edge of a coin to turn the thumbscrews.

Figure 1-709 Loosen the thumbscrews



Step 2: Remove the toner collection unit (TCU)

1. Open the front door.

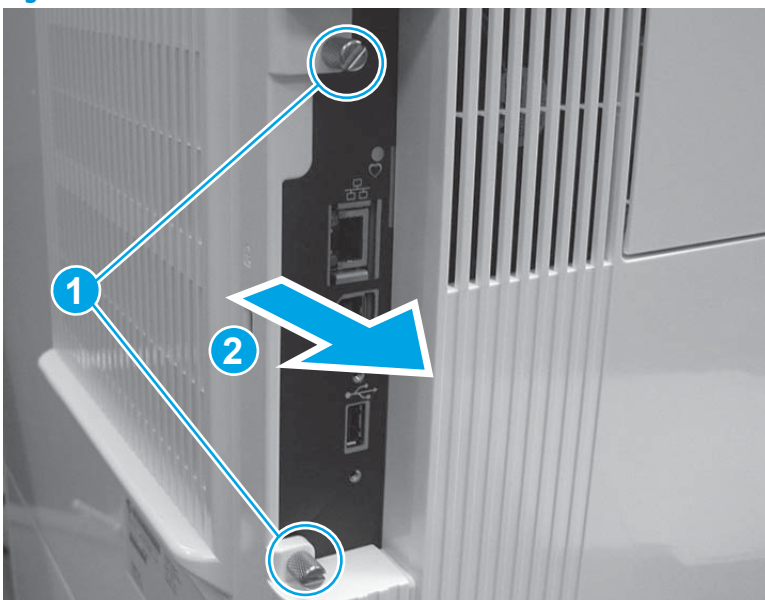
Figure 1-710 Open the front door



2. Open the TCU.

 **NOTE:** The toner collection hatch cover automatically closes when the TCU is opened.

Figure 1-711 Open the TCU



3. Pull the TCU away from the printer at an angle to remove it.

⚠ CAUTION: Do not open the toner collection hatch cover when handling the TCU. If toner gets on clothing, wipe it off by using a dry cloth and wash the clothes in cold water. Hot water sets toner into fabric.

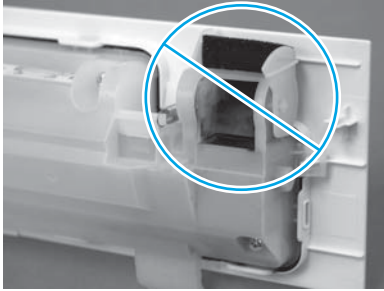
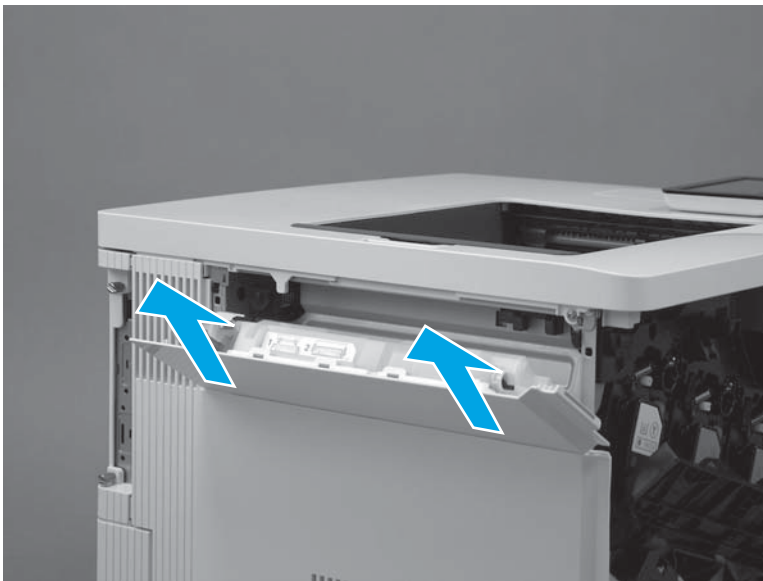

Figure 1-712 Remove the TCU



Step 3: Remove the USB cover (M552 and M553)

📝 NOTE: This step is for the M552 and M553 models. For the M577 models, skip this step and go to [Step 6: Remove the rear upper cover \(M577\) on page 434](#).

1. Locate the USB cover.

Figure 1-713 Locate the USB cover



2. Pull the cover off of the printer to remove it.

Figure 1-714 Remove the cover



Step 4: Remove the control panel (M553x only)

 **NOTE:** This step is for the M553x model only. For the M553n/dn and M552dn models, skip this step and go to [Step 5: Remove the rear cover \(M552 and M553\) on page 433](#).

For the M577 models, skip this step and go to [Step 6: Remove the rear upper cover \(M577\) on page 434](#).

1. Tilt the control panel up.

Figure 1-715 Tilt the control panel up



2. Use a small flat-blade screwdriver to release the control-panel screws cover tabs.

Figure 1-716 Release the control-panel screws cover tabs



3. Rotate the cover up to remove it.

Figure 1-717 Remove the cover



4. Use a small Phillips screwdriver to remove two screws (callout 1).

 **IMPORTANT:** Store the screws in a secure place where they cannot fall down into the printer.

Figure 1-718 Remove two screws



5. Rotate the control-panel base toward the front of the printer.

Figure 1-719 Rotate the control-panel base up

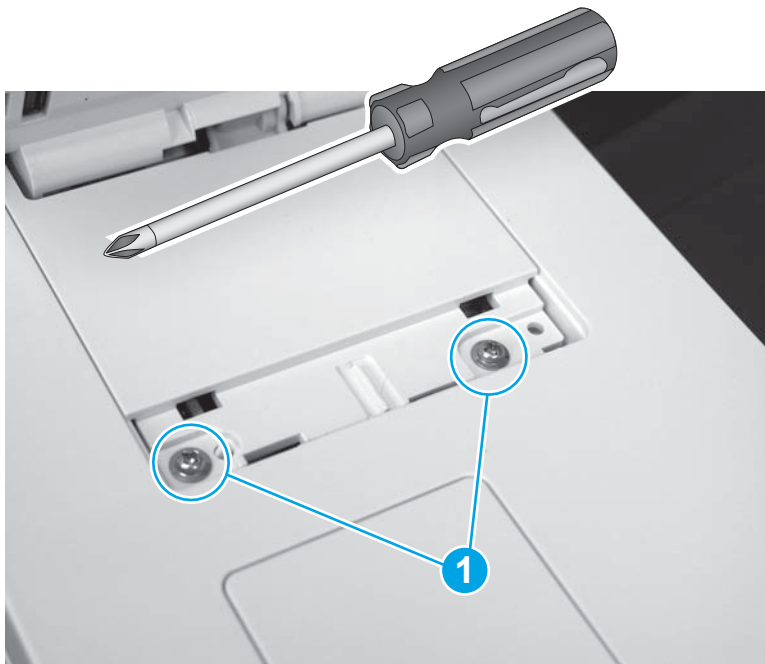

6. Slightly slide the control-panel base toward the rear of the printer (callout 1) to release it, and then turn the control panel over (callout 2) to access the bottom side.

CAUTION: The control panel is still attached to the printer. Do not attempt to completely remove the control panel.

Figure 1-720 Turn the control panel over

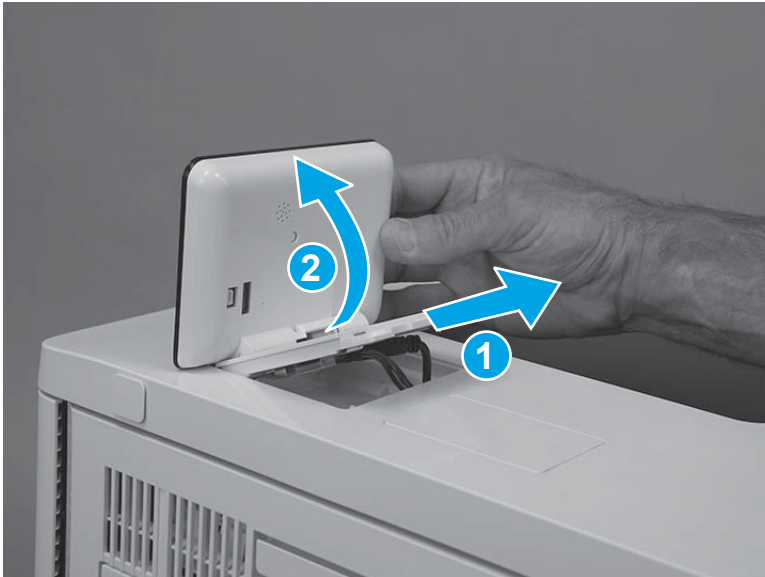

7. Disconnect one USB cable (callout 1), one connector (callout 2), and then remove the control panel.

Figure 1-721 Disconnect two connectors

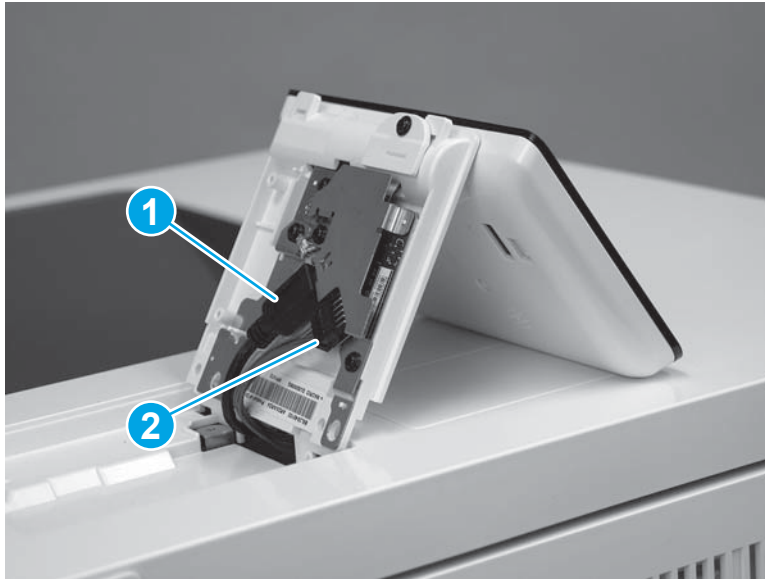

Step 5: Remove the rear cover (M552 and M553)



NOTE: This step is for the M552 and M553 models. For the M577 models, skip this step and go to [Step 6: Remove the rear upper cover \(M577\) on page 434](#).

1. Remove four screws (callout 1).

Figure 1-722 Remove four screws

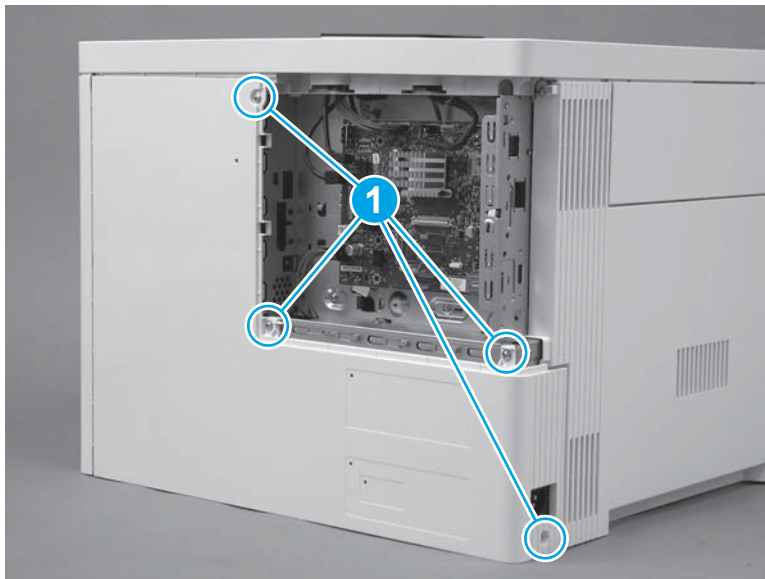

2. Slightly slide the cover to the right (callout 1), rotate the bottom of the cover away from the printer (callout 2), and then pull the top of the cover away from the printer (callout 3) to remove the cover.

Figure 1-723 Remove the cover

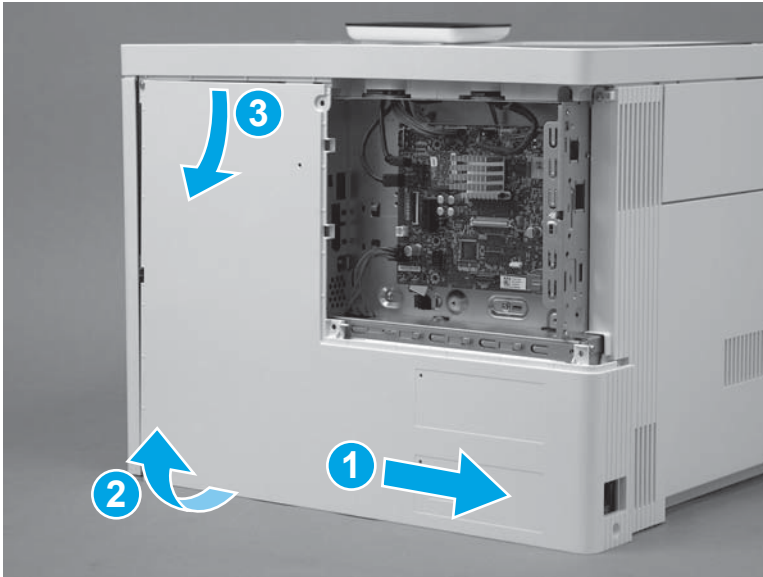

Step 6: Remove the rear upper cover (M577)

 **NOTE:** This step is for the M577 models. For the M552 and M553 models, skip this step and go to [Step 8: Remove the left cover on page 437](#).

1. Remove two screws (callout 1).

 **Reinstallation tip:** These two screws are self-tapping screws for plastic. When reinstalling them, rotate the screws counterclockwise to align them with the existing thread pattern, and then carefully turn them clockwise to tighten. Do not overtighten. This will prevent stripping the threads inside the screw holes.

Figure 1-724 Remove two screws



2. Use a small, flat blade screwdriver to release the right edge of the cover.

Figure 1-725 Release the right edge

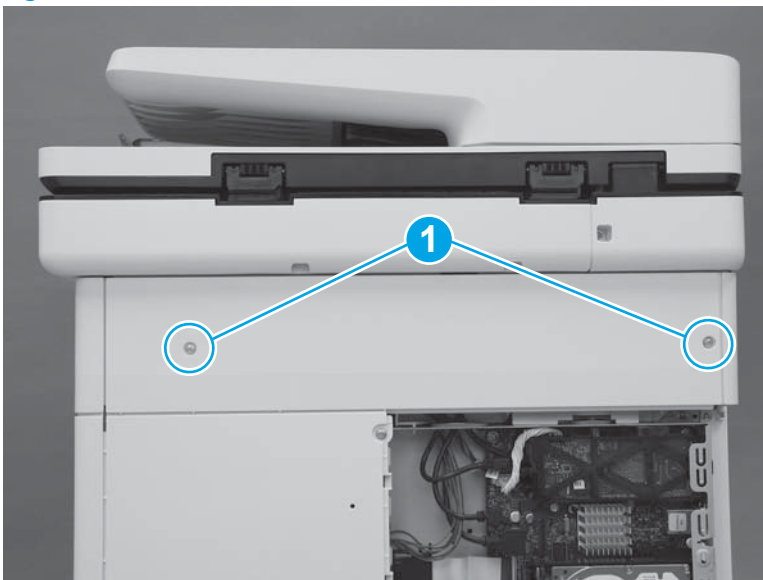
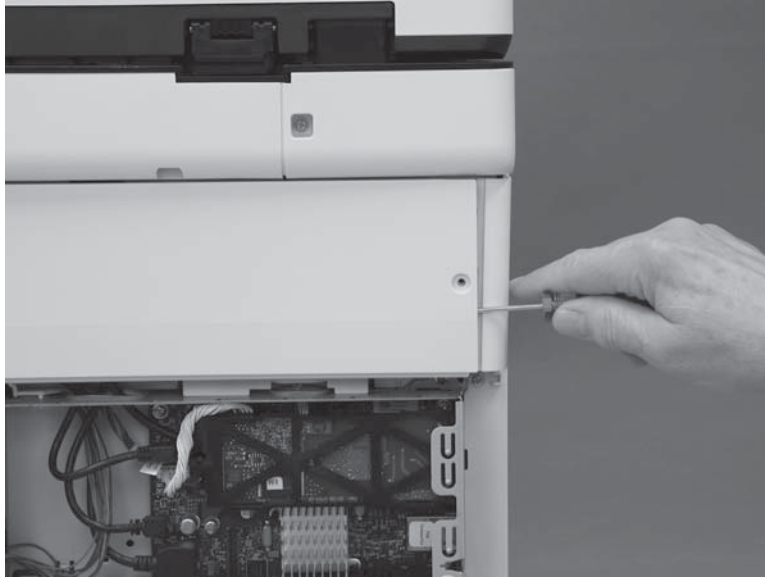

3. Pull the right edge of the cover (callout 1) away from the printer, and then slide the cover to the right (callout 2).

Figure 1-726 Slide the cover right

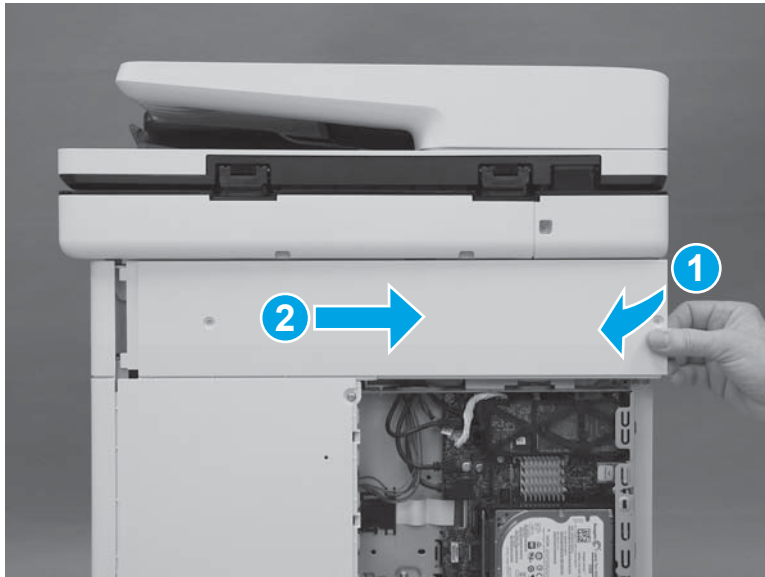

4. Remove the cover.

Figure 1-727 Remove the cover

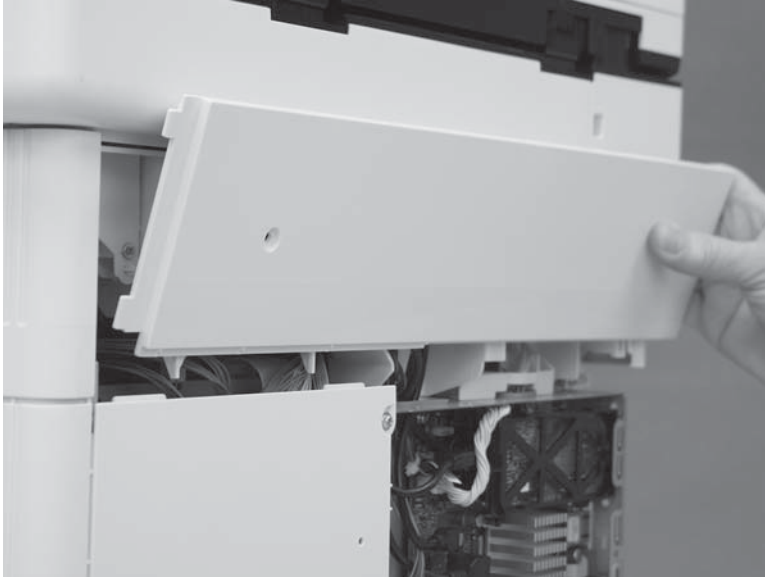

Step 7: Remove the rear cover (M577)



NOTE: This step is for the M577 models. For the M552 and M553 models, skip this step and go to [Step 8: Remove the left cover on page 437](#).

1. Remove four screws (callout 1).

Figure 1-728 Remove four screws

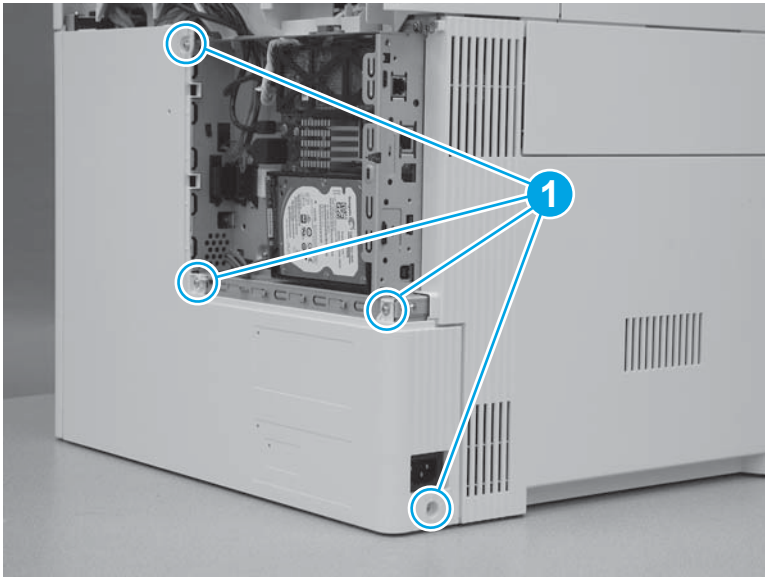

2. Slide the cover to the right to remove it.

Figure 1-729 Remove the cover

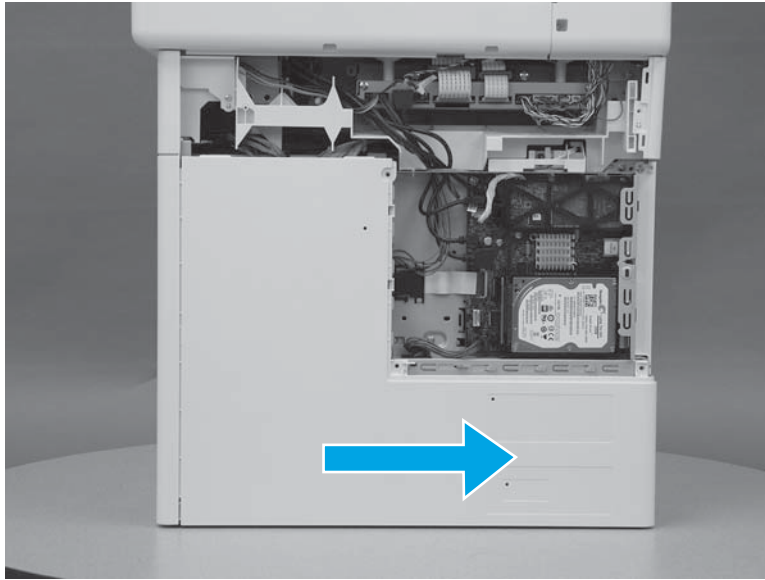

Step 8: Remove the left cover

1. At the left side of the printer, remove one screw (callout 1).

Figure 1-730 Remove one screw



2. Release one tab (callout 1), rotate the front edge of the cover away from the printer (callout 2), and then slide the cover (callout 3) toward the rear of the printer to release it.

Figure 1-731 Release the cover

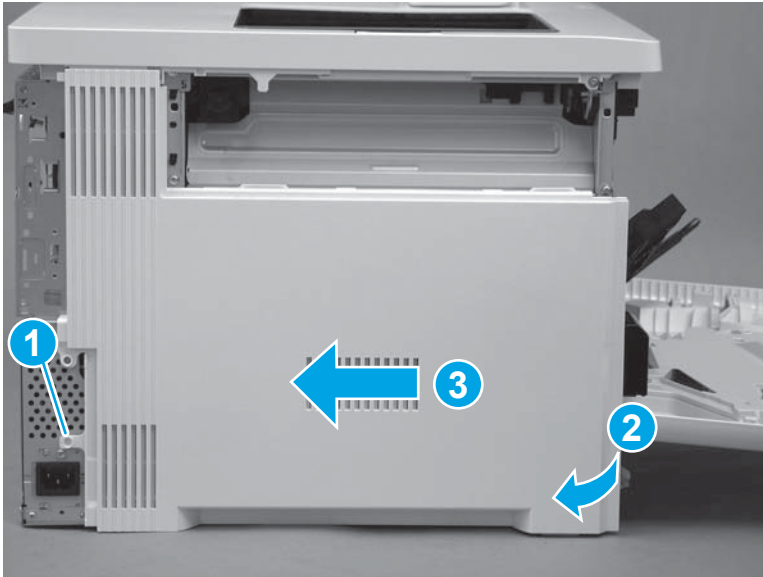

3. Remove the cover.

Figure 1-732 Remove the cover

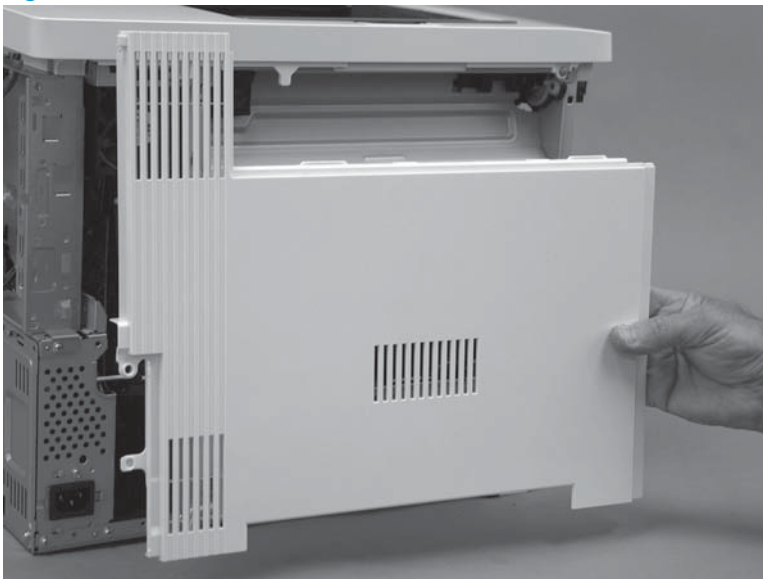

Step 9: Remove the upper cover (M552 and M553)

 **NOTE:** This step is for the M552 and M553 models. For the M577 models, skip this step and go to [Step 10: Remove the left upper cover \(M577\) on page 440.](#)

1. Remove three screws (callout 1).

Figure 1-733 Remove three screws

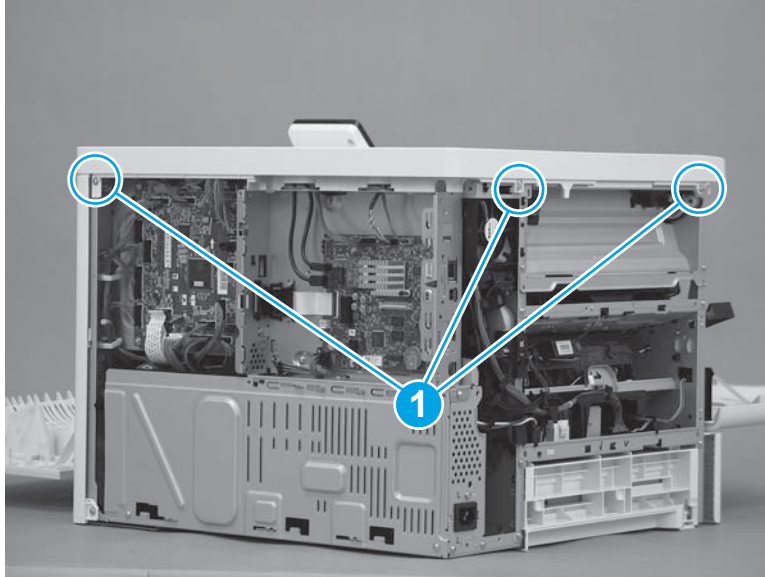

2. Remove one screw (callout 1), release one tab (callout 2), and then slightly separate the corner of the cover from the chassis.

 **NOTE:** This is a self-tapping plastic-thread screw. Make sure that this screw is used in this location when it is reinstalled.

Figure 1-734 Remove one screw and release one tab



3. Release one tab (callout 1), and then lift up on the cover to release it.

 **NOTE:** If the cover does not release, check for addition tabs by locating the triangles embossed in the cover at tab locations.

Figure 1-735 Release the cover



4. Remove the cover.

Figure 1-736 Remove the cover

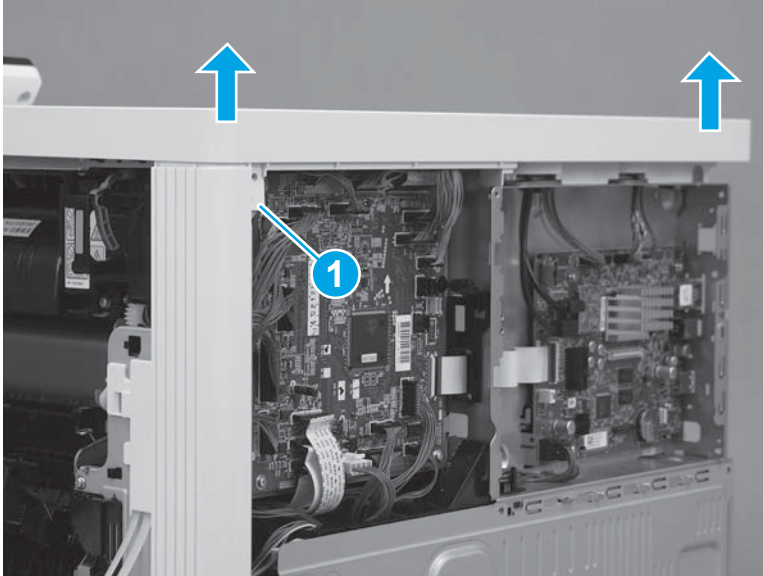
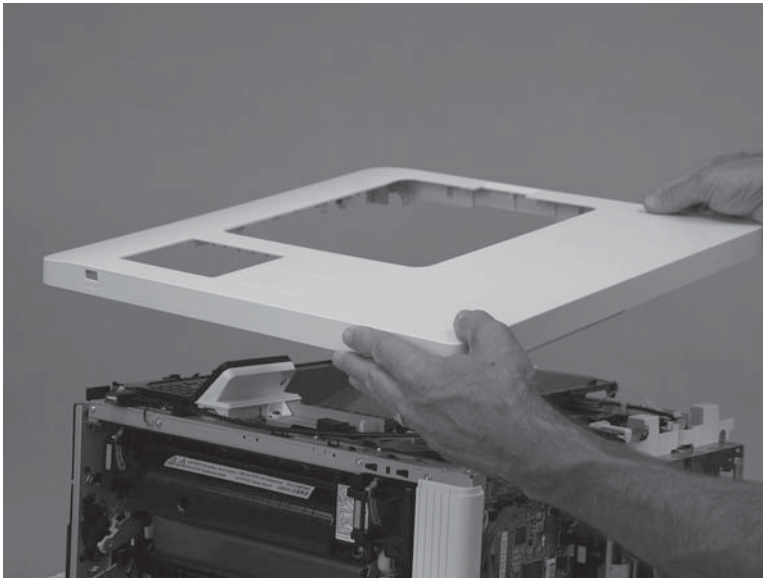

Step 10: Remove the left upper cover (M577)

 **NOTE:** This step is for the M577 models. For the M552 and M553 models, skip this step and go to [Step 19: Remove the output bin on page 456](#).

1. At the left side of the printer, release one tab (callout 1).

Figure 1-737 Release one tab

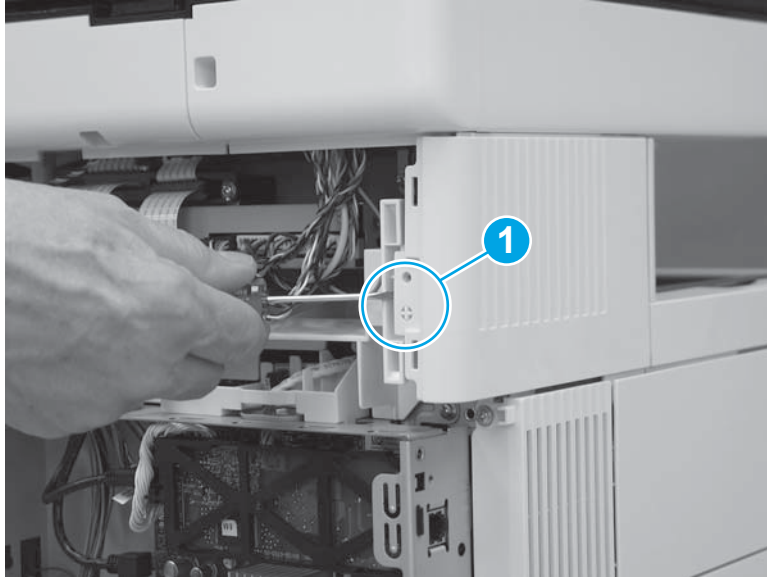

2. Slide the left upper cover toward the back of the printer.

Figure 1-738 Slide the cover back

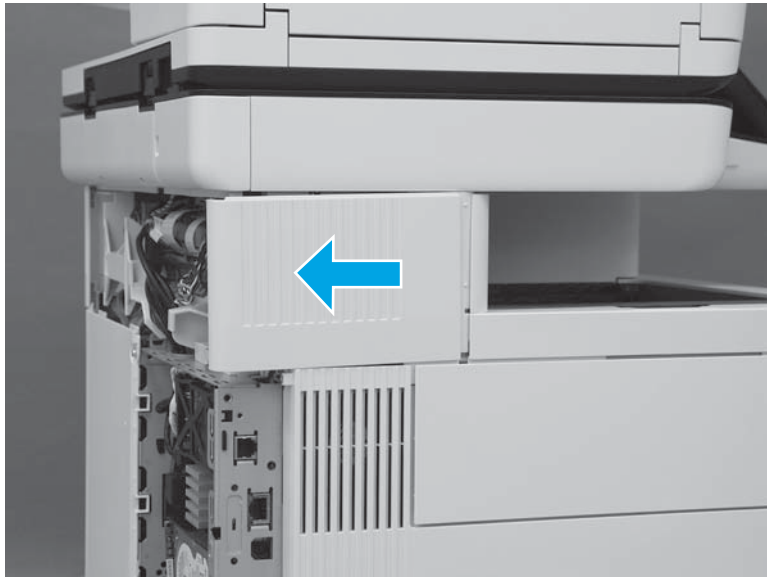

3. Rotate the cover up to remove it.

Figure 1-739 Remove the left upper cover



Step 11: Remove the right front upper cover (M577dn)



NOTE: This step is for the M577dn model. For the M577f and M577z models, skip this step and to go [Step 12: Remove the stapler cover assembly \(M577c/f/z\) on page 443](#).

For the M552 and M553 models, skip this step and go to [Step 19: Remove the output bin on page 456](#).

1. Remove one screw (callout 1).

Figure 1-740 Remove one screw

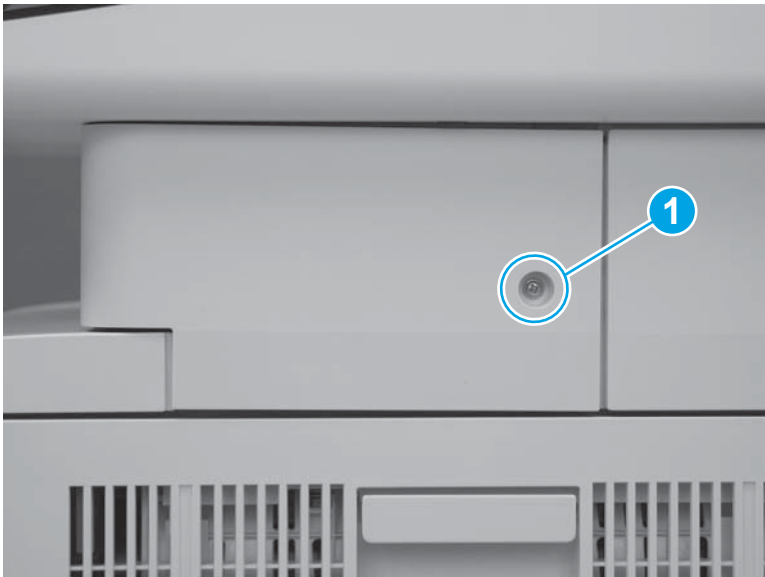

2. Release two tabs at the front edge of the cover (callout 1).

Figure 1-741 Release two tabs



3. Rotate the front of the cover to the right to remove it.

Figure 1-742 Rotate the cover



Step 12: Remove the stapler cover assembly (M577c/f/z)

 **NOTE:** This step is for the M577f and M577z models. For the M577dn model, skip this step and to go [Step 13: Remove the integrated scanner assembly \(M577\) on page 445](#).

For the M552 and M553 models, skip this step and go to [Step 19: Remove the output bin on page 456](#).

1. Remove one screw (callout 1).

 **Reinstallation tip:** This is a self-tapping screw for plastic. When reinstalling, rotate the screw counterclockwise to align it with the existing thread pattern, and then carefully turn it clockwise to tighten. Do not overtighten. This will prevent stripping the threads inside the screw hole.

Figure 1-743 Remove one screw



2. Release two tabs at the front edge of the cover (callout 1).

Figure 1-744 Release two tabs

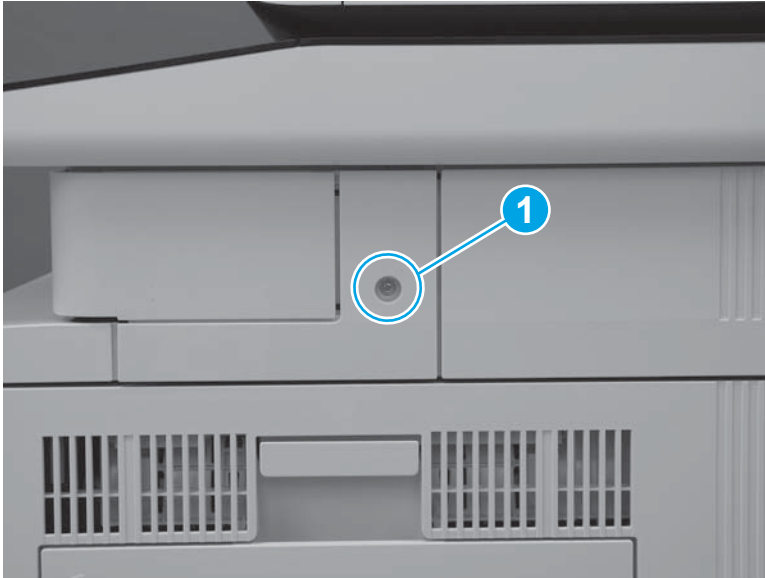

3. Release the back edge of the cover.

Figure 1-745 Release the back edge of the cover

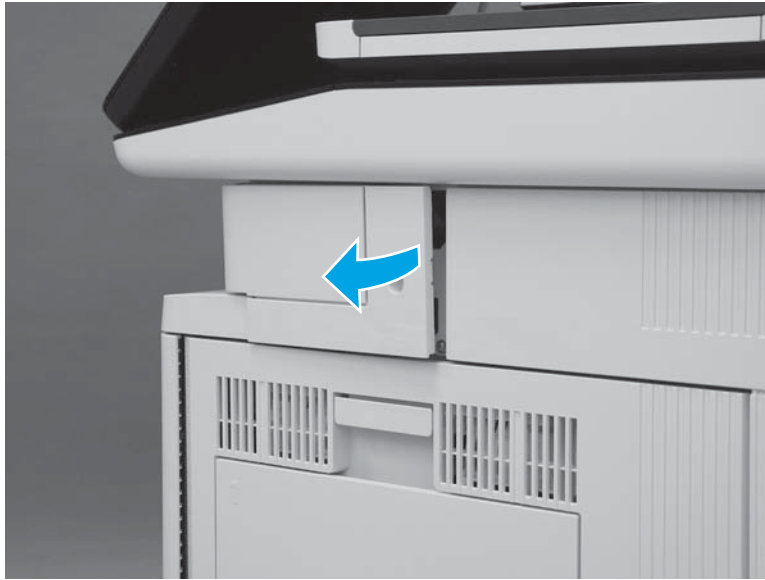



4. Rotate the cover away from the printer to remove it.

Figure 1-746 Remove the cover



Step 13: Remove the integrated scanner assembly (M577)

 **NOTE:** This step is for the M577 models. For the M552 and M553 models, skip this step and go to [Step 19: Remove the output bin on page 456](#).

 **NOTE:** The ISA includes the document feeder, image scanner, scanner control board (SCB), control panel, keyboard (M577c/z) and NFC PCA (M577z).

1. At the left side of the printer, remove one screw (callout 1).

Figure 1-747 Remove one screw

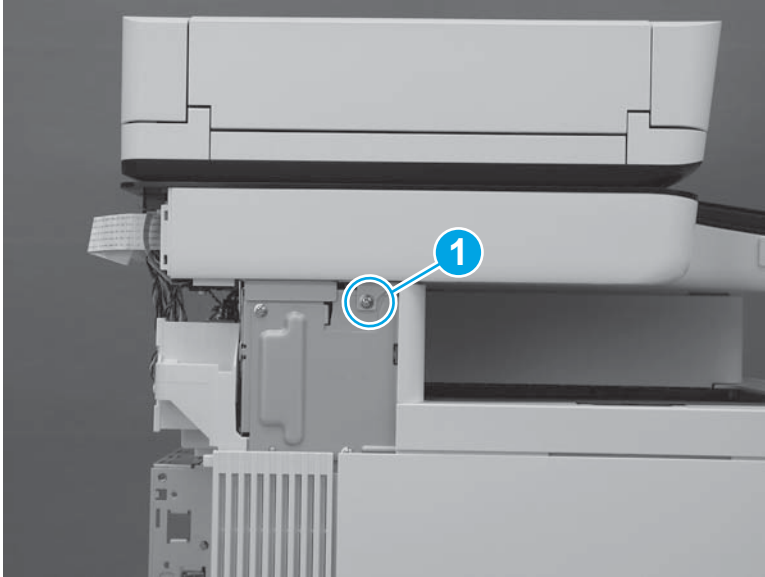

2. At the back side of the printer, remove two screws (callout 1).

Figure 1-748 Remove two screws

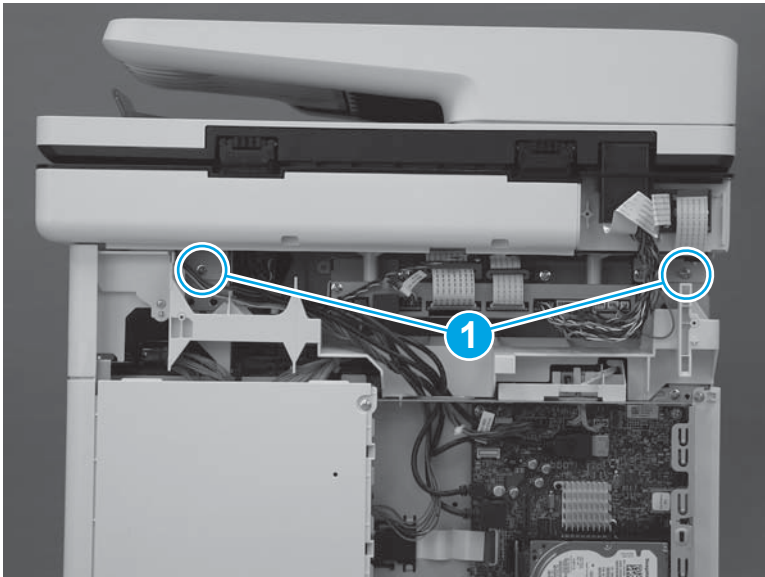

3. At the right side of the printer, remove one screw (callout 1).

Figure 1-749 Remove one screw

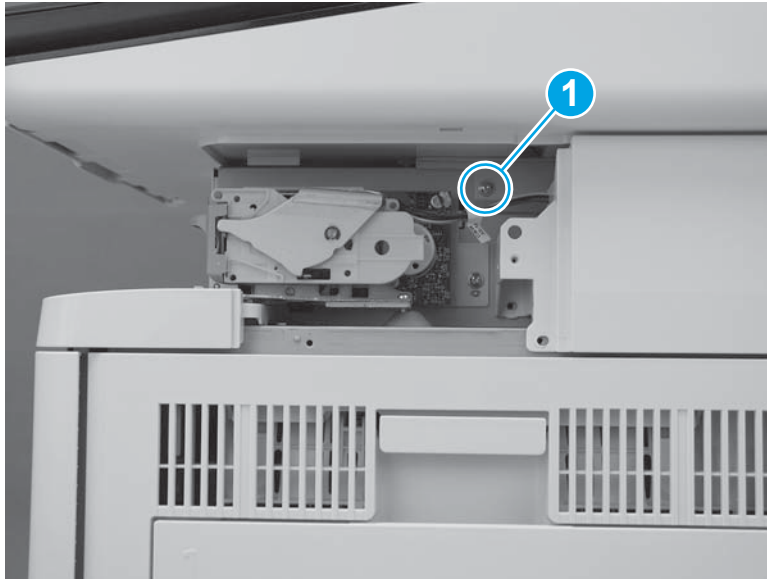

4. Disconnect four connectors on the formatter (callout 1), and then pass the wire harness and cables through the opening in the formatter case (callout 2).

Figure 1-750 Disconnect four connectors

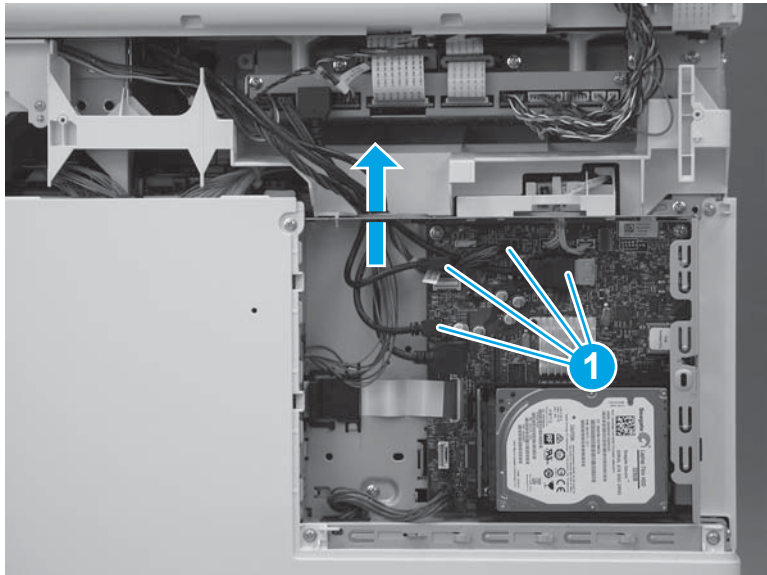

5. Disconnect two connectors on the scanner control board (callout 1).

M577c/f/z only: Disconnect one connector for the stapler on the scanner control board (callout 2).

Figure 1-751 Disconnect connectors

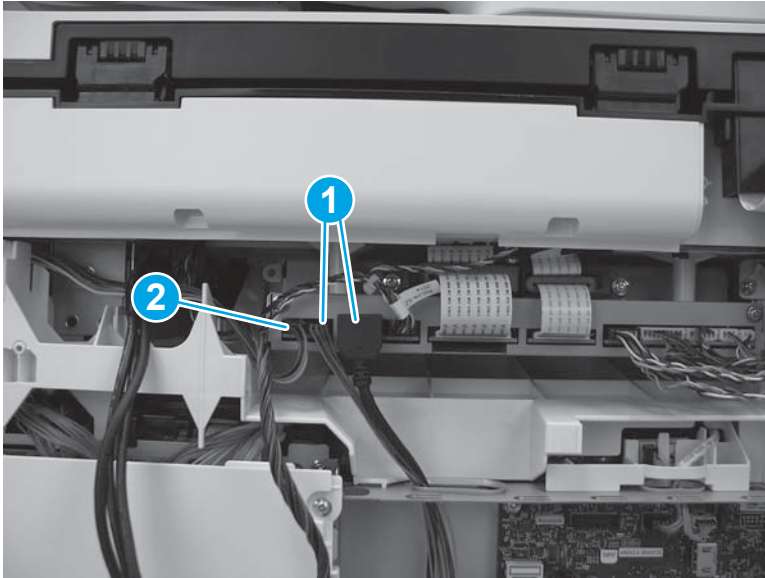

6. Slightly slide the ISA towards the back of the printer to release it.

Figure 1-752 Slide the ISA towards the back of the printer

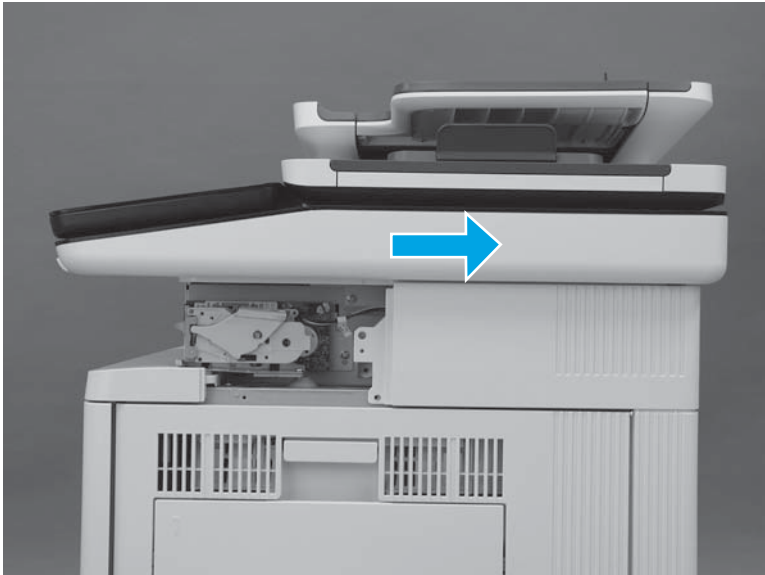

7. Lift the ISA up to remove it.

Figure 1-753 Remove the ISA

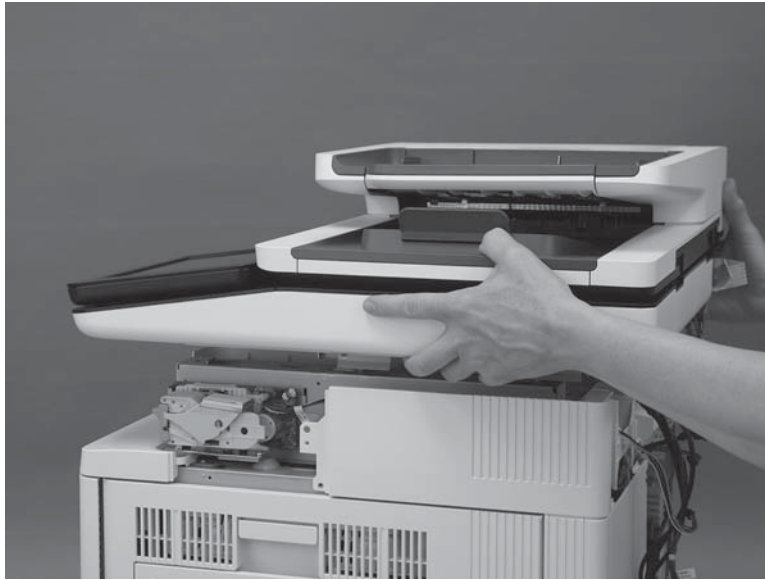

Step 14: Remove the stapler (M577c/f/z)

 **NOTE:** This step is for the M577c/f/z models. For the M577dn model, skip this step and to go [Step 15: Remove the right upper cover \(M577\) on page 450](#).

For the M552 and M553 models, skip this step and go to [Step 19: Remove the output bin on page 456](#).

1. Disconnect one connector (callout 1), and then remove two screws (callout 2).

Figure 1-754 Disconnect connector and remove screws

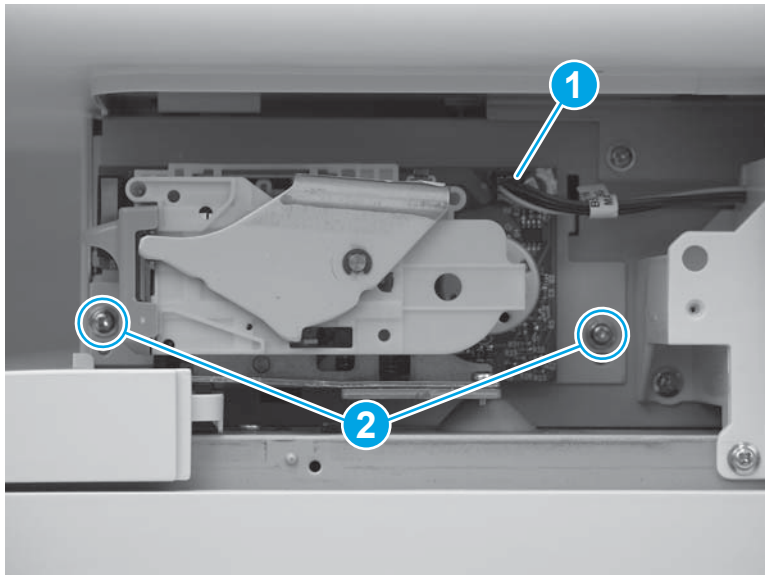

- Slide the stapler unit up (callout 1), and then pull it away from the printer (callout 2) to remove it.

Figure 1-755 Remove the stapler unit

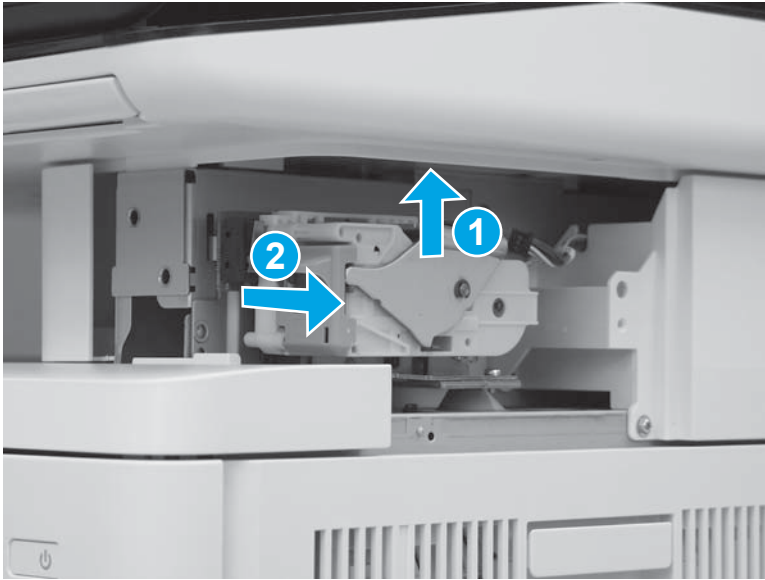

Step 15: Remove the right upper cover (M577)



NOTE: This step is for the M577 models. For the M552 and M553 models, skip this step and go to [Step 19: Remove the output bin on page 456](#).



NOTE: The figures below show the image scanner installed. The procedures for removing and installing the right upper cover are the same whether the image scanner is installed or removed."

- At the right side of the printer, remove two screws (callout 1).

M577c/f/z only: Disconnect one connector (callout 2), if it was not already disconnected in a previous step.

Figure 1-756 Remove two screws and one connector

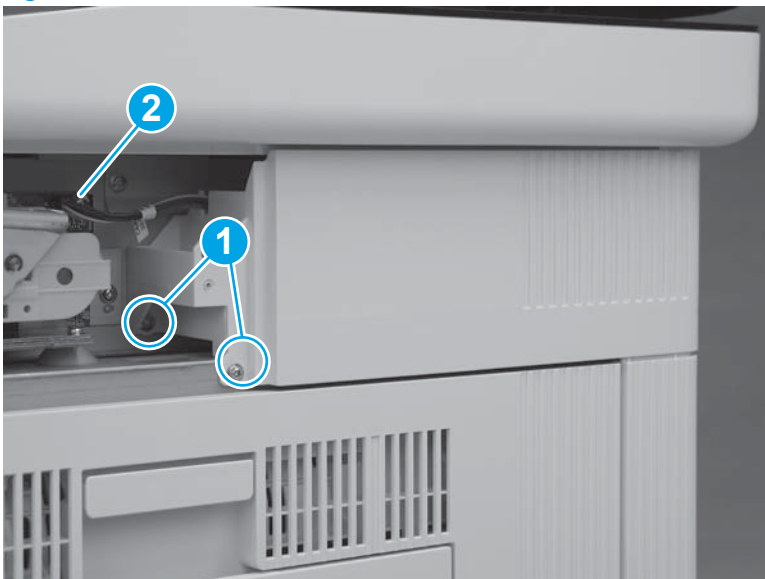

2. At the back of the printer, remove one screw (callout 1).

M577c/f/z only: Disconnect one connector (callout 2), if it was not already disconnected in a previous step.

 **Reinstallation tip:** This screw is smaller than the screws removed in the previous step. When reinstalling the right upper cover, make sure that this screw is installed in the correct position.

Figure 1-757 Remove one screw and connector



3. Slide the cover toward the back of the printer.

Figure 1-758 Slide the cover

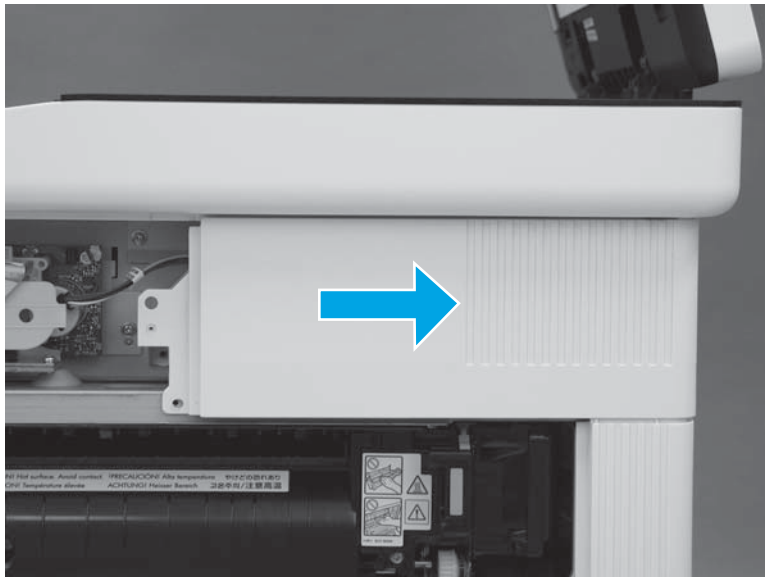

4. Lift the cover away from the printer to remove it.

M577c/f/z only: Release the cables (callout 1) through the slot (callout 2) in the printer.

Figure 1-759 Remove the cover

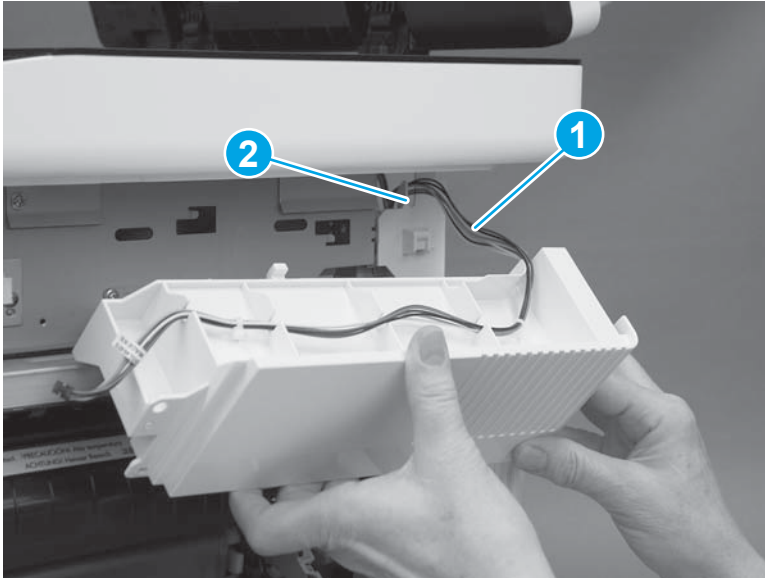

Step 16: Remove the top rear cover (M577)

 **NOTE:** This step is for the M577 models. For the M552 and M553 models, skip this step and go to [Step 19: Remove the output bin on page 456](#).

1. At the top of the printer, remove five screws (callout 1).

Figure 1-760 Remove five screws

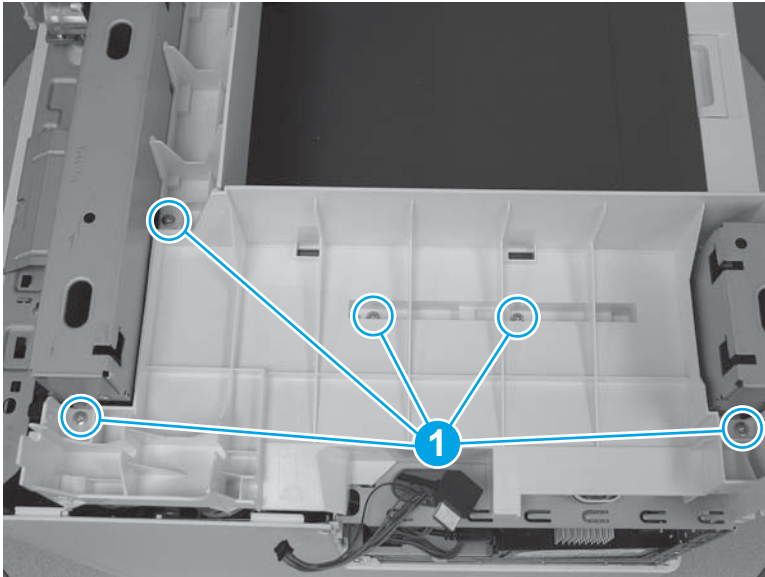

2. Release two tabs (callout 1) on the front edge of the cover.

Figure 1-761 Release two tabs

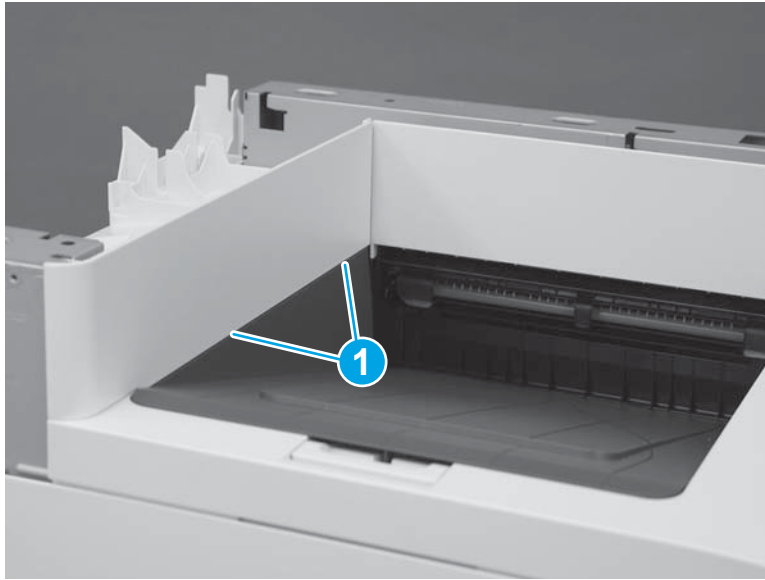

3. Remove the top rear cover.

Figure 1-762 Remove the top rear cover

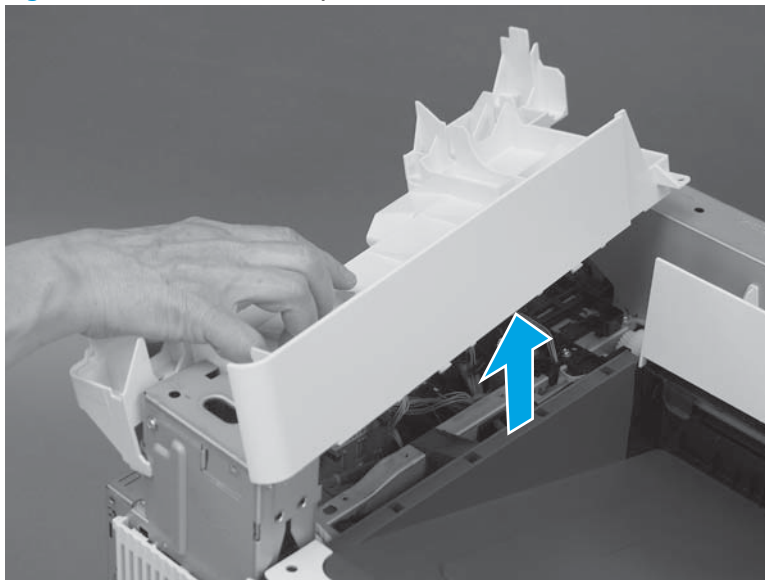

Step 17: Remove the paper feed cover (M577)

 **NOTE:** This step is for the M577 models. For the M552 and M553 models, skip this step and go to [Step 19: Remove the output bin on page 456.](#)

1. Remove one screw (callout 1).

Figure 1-763 Remove one screw

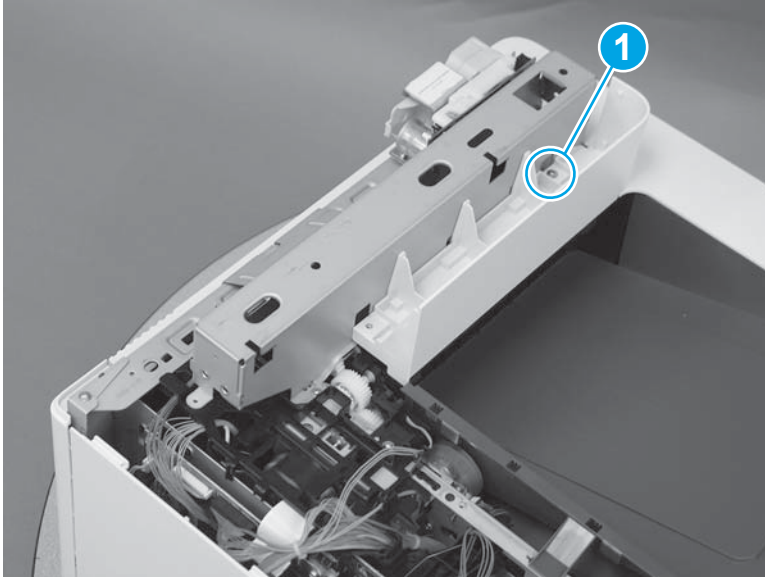

2. Lift the cover up to remove it.

Figure 1-764 Remove the cover

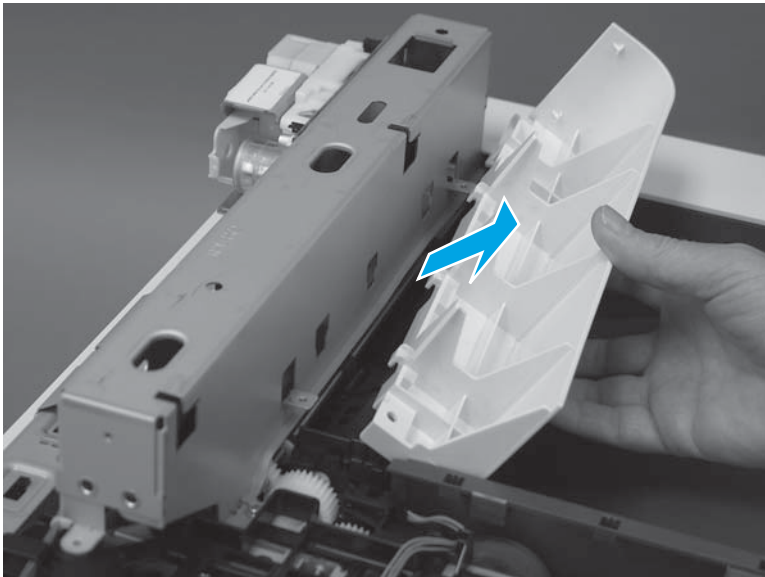

Step 18: Remove the top cover (M577)



NOTE: This step is for the M577 models. For the M552 and M553 models, skip this step and go to [Step 19: Remove the output bin on page 456](#).

1. At the front of the printer, remove one screw (callout 1).



Reinstallation tip: This screw is longer and a different type of screw than the screw removed in the next step. When reinstalling the top cover, make sure that this screw is installed in the correct position.

Figure 1-765 Remove one screw

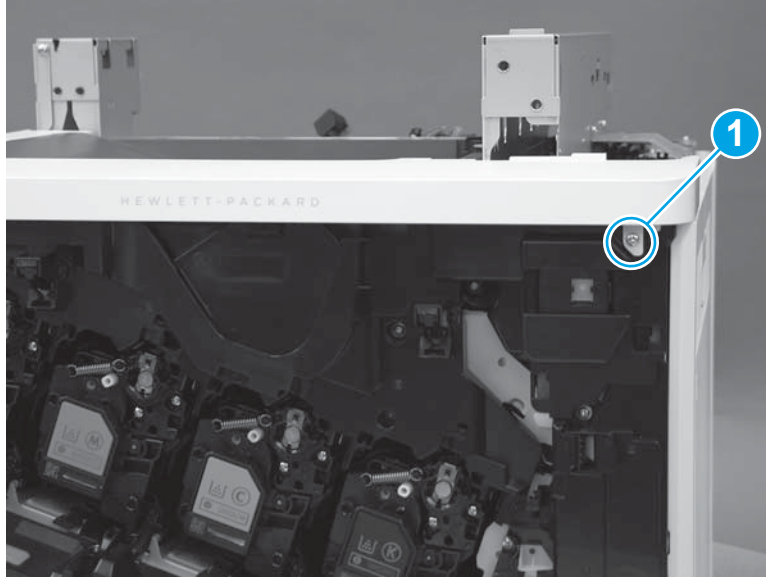

2. At the left side of the printer, remove one screw (callout 1).

Figure 1-766 Remove one screw

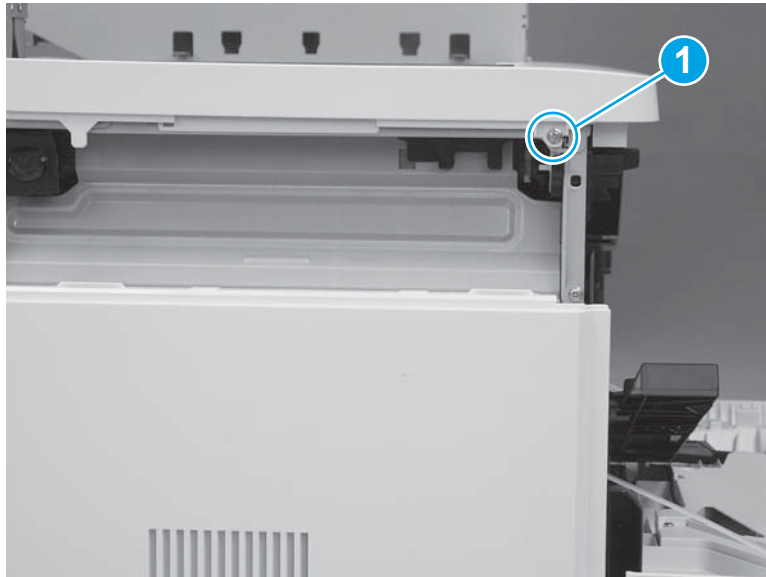

3. At the front of the printer, release one tab (callout 1).

Figure 1-767 Release one tab

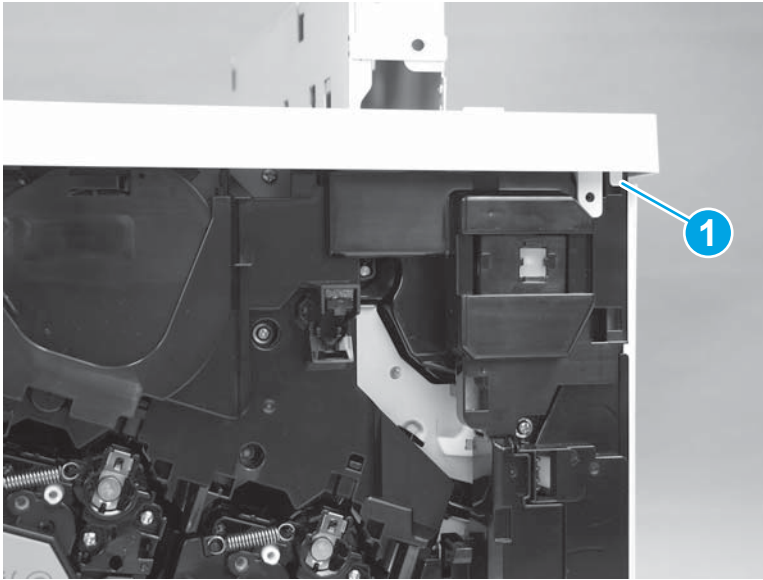

4. At the top of the printer, release two tabs (callout 1) next to the output bin, and then remove the top cover.

Figure 1-768 Release two tabs

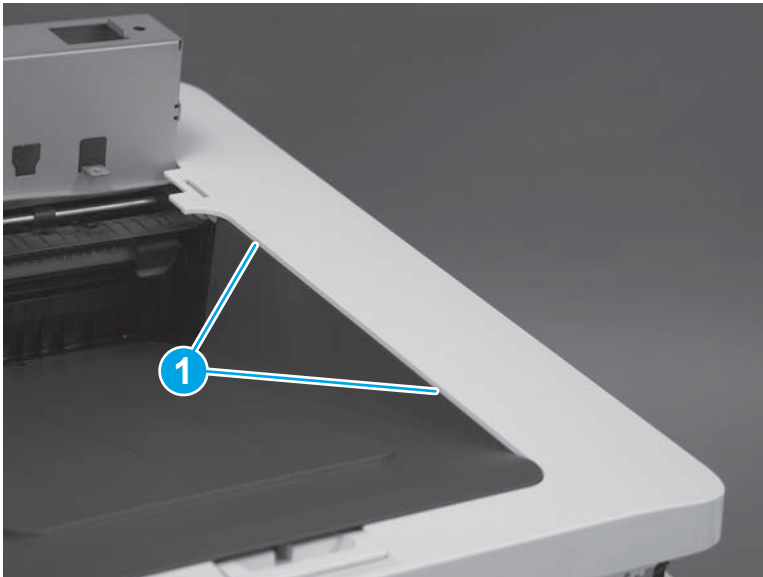

Step 19: Remove the output bin

1. Slightly slide and lift the cover to release it.

Figure 1-769 Release the cover

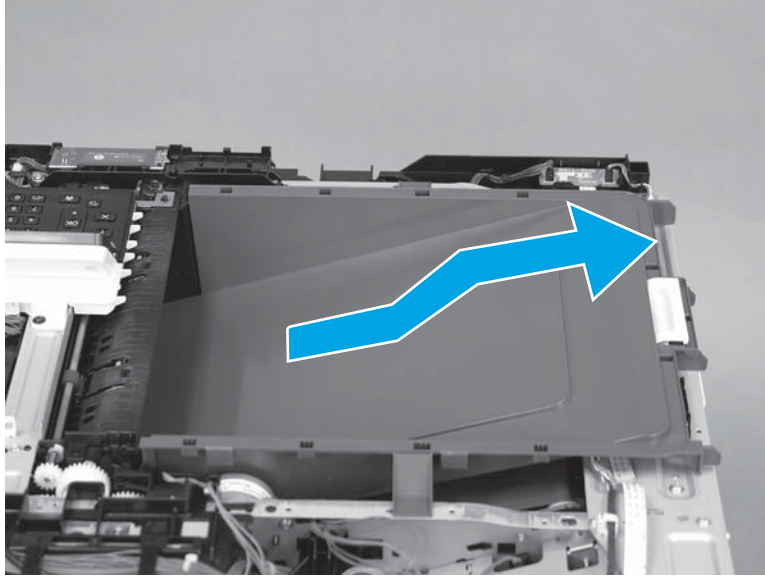

2. Remove the cover.

Figure 1-770 Remove the cover

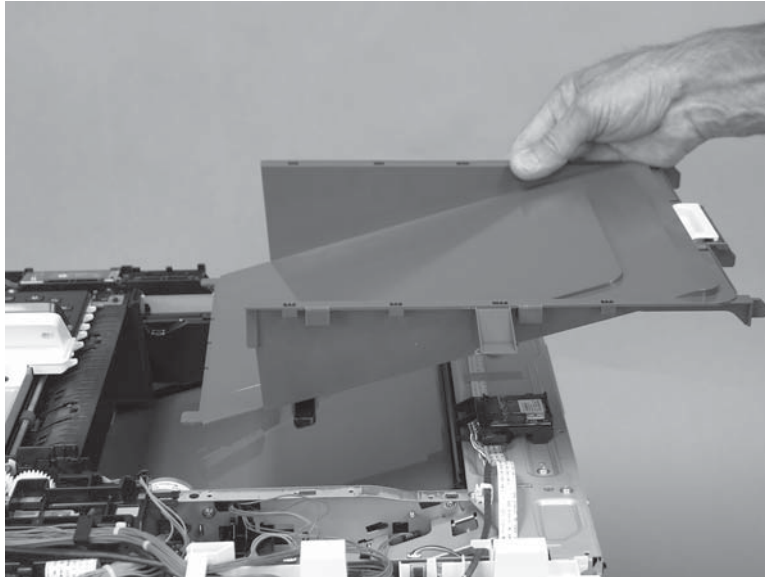

Step 20: Unpack the replacement assembly

Unpack the replacement assembly from the packaging.

For complete information on HP's recycling programs, go to [Product return and recycling](#).



NOTE: HP recommends responsible disposal of the defective assembly.

Figure 1-771 Recycle and unpack

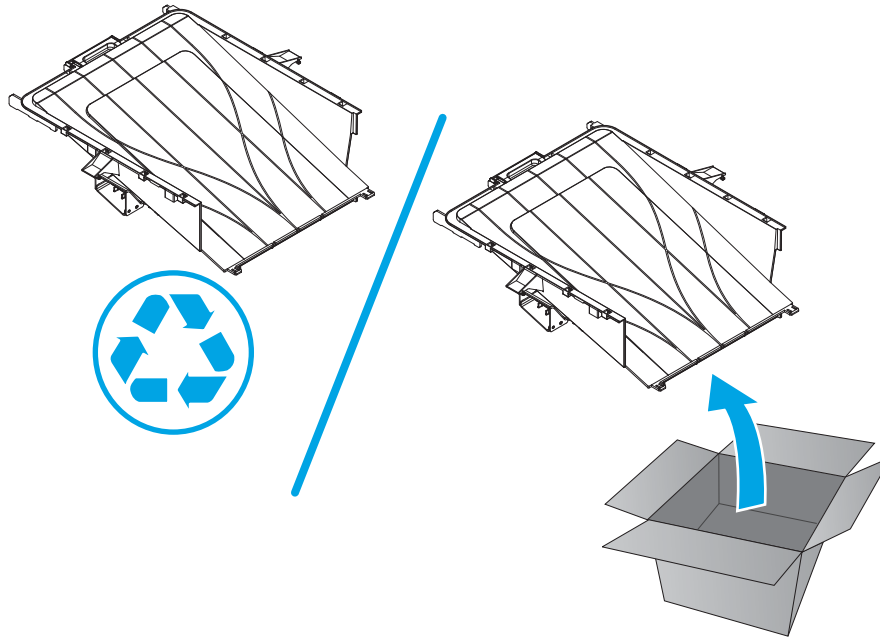

Step 21: Install the output bin

1. Position the cover near the printer.

Figure 1-772 Install the cover

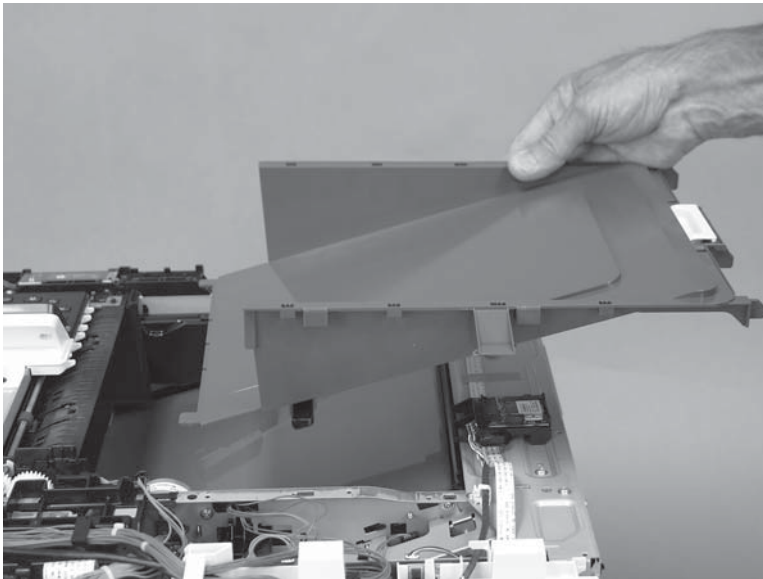

2. Align the tabs on the cover with the slots in the printer.

Figure 1-773 Align the tabs

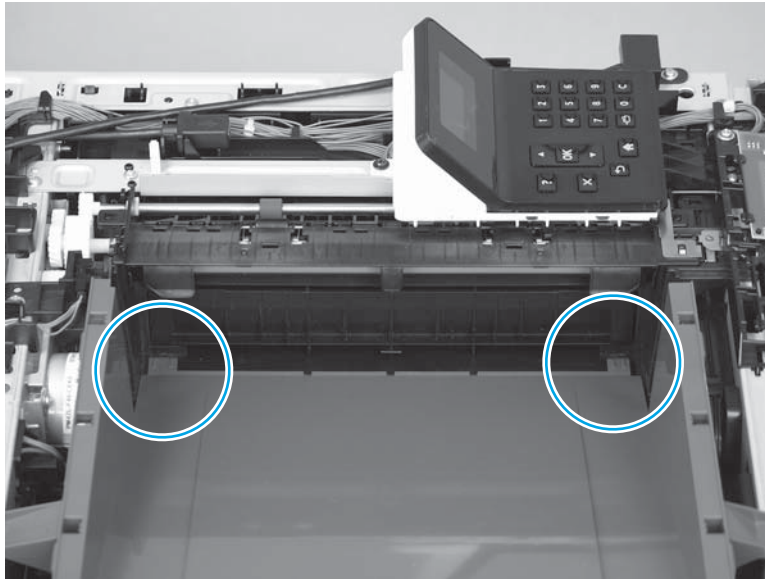

3. Slide and lower the cover onto the printer to install it.

Figure 1-774 Release the cover

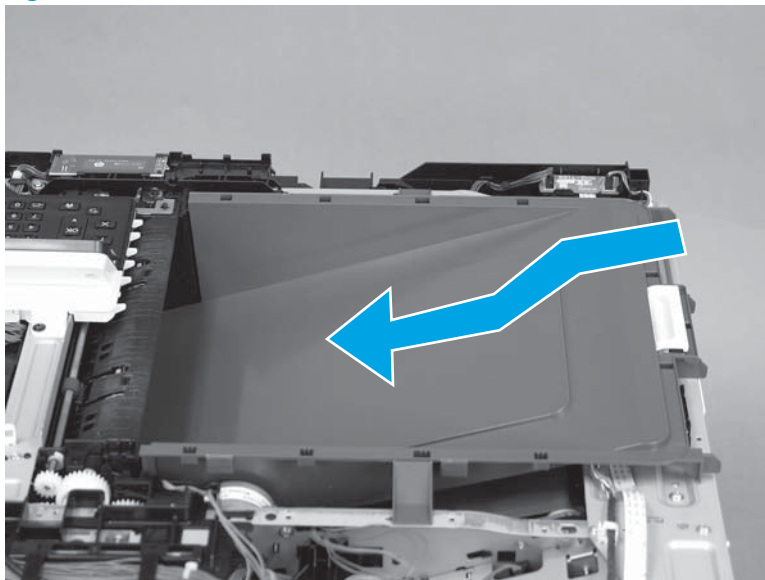

4. Verify that the tabs on the front- and rear-side of the cover are correctly installed in the slots in the chassis.

Figure 1-775 Verify the installation

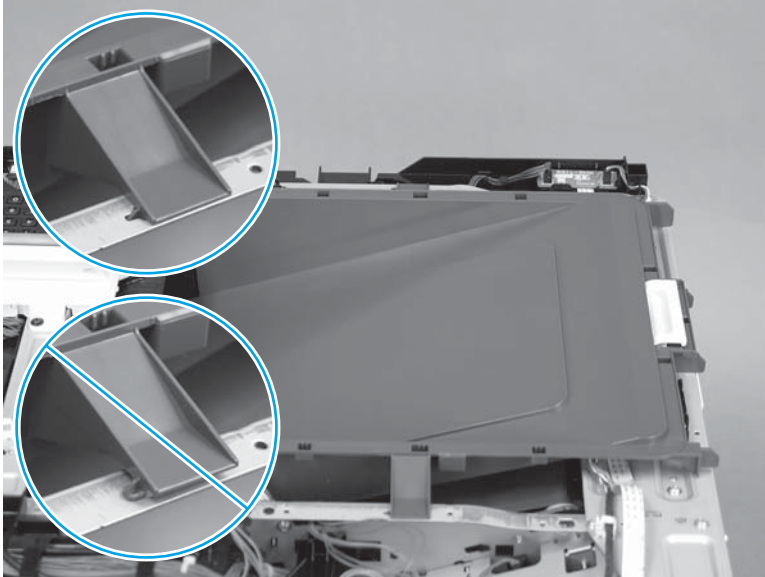

Step 22: Install the top cover (M577)



NOTE: This step is for the M577 models. For the M552 and M553 models, skip this step and go to [Step 31: Install the upper cover \(M552 and M553\) on page 476](#).

1. Position the locator pins (callout 1) on the cover in the slots (callout 2) in the printer.

Figure 1-776 Position the locator pins

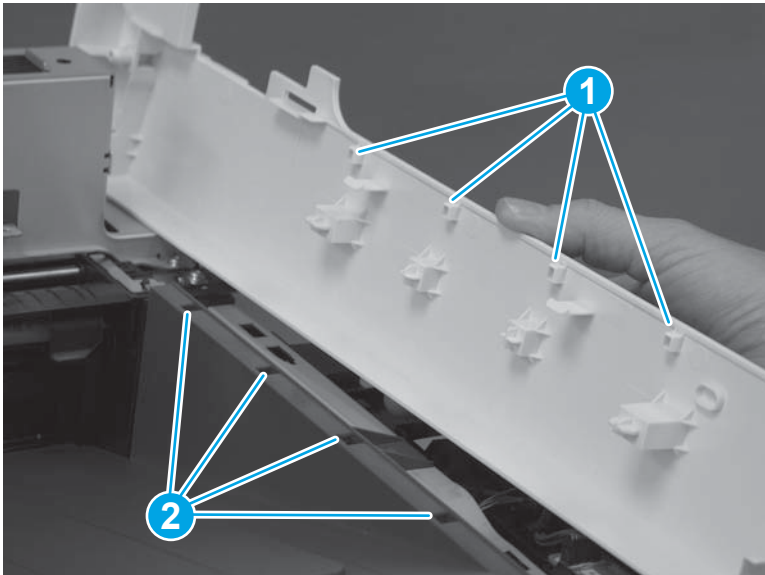

2. Press down on the cover to install it. Make sure that the tabs (callout 1) snap into place.

Figure 1-777 Press down on the cover

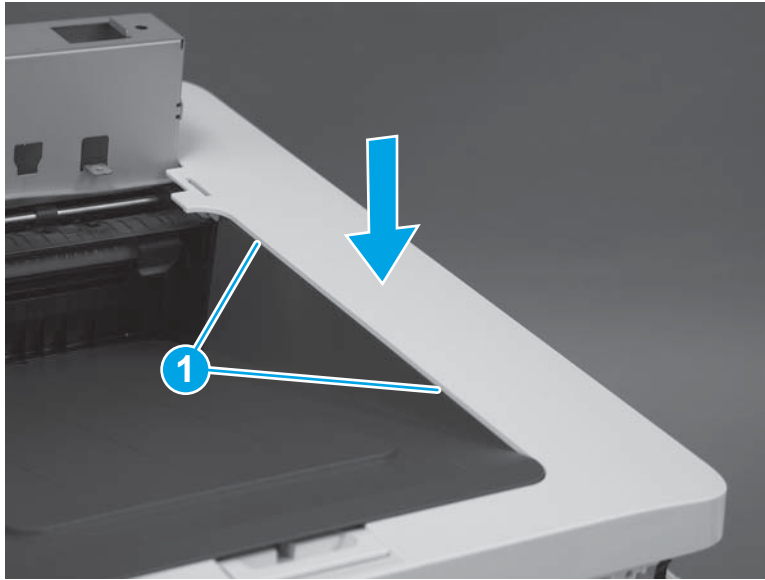

3. At the front of the printer, install one screw (callout 1).

 **Reinstallation tip:** This screw is longer and a different type of screw than the screw installed in the next step. Make sure that this screw is installed in the correct position.

Figure 1-778 Install one screw



4. At the left side of the printer, install one screw (callout 1).

Figure 1-779 Install one screw

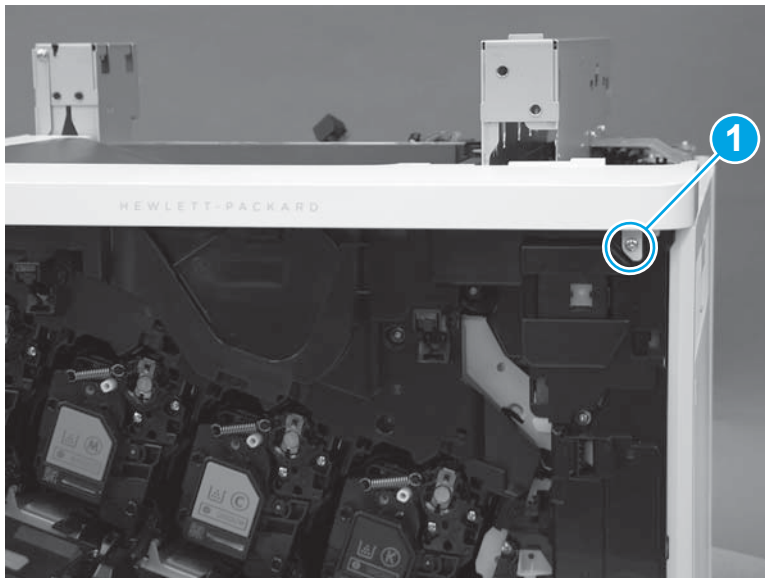
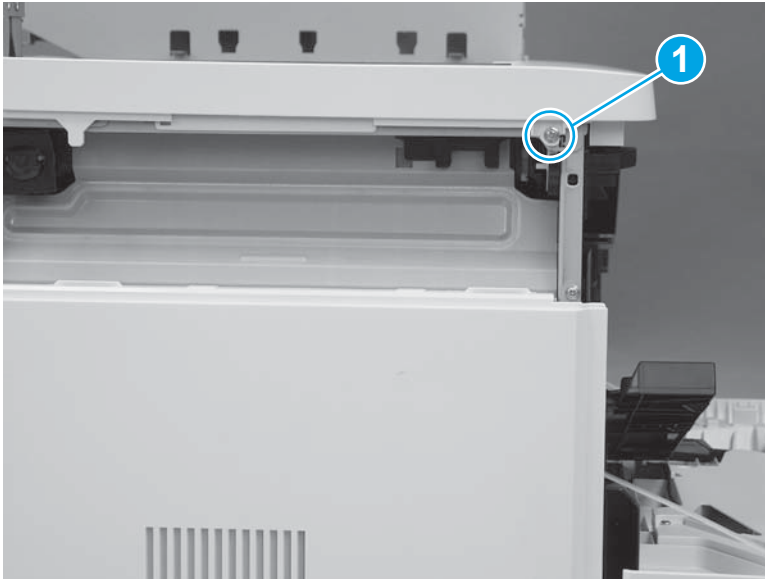

Step 23: Install the paper feed cover (M577)



NOTE: This step is for the M577 models. For the M552 and M553 models, skip this step and go to [Step 31: Install the upper cover \(M552 and M553\) on page 476](#).

1. Position the locator tabs (callout 1) on the cover in the slots (callout 2) in the printer. Press down until the cover snaps into place.

Figure 1-780 Install the cover

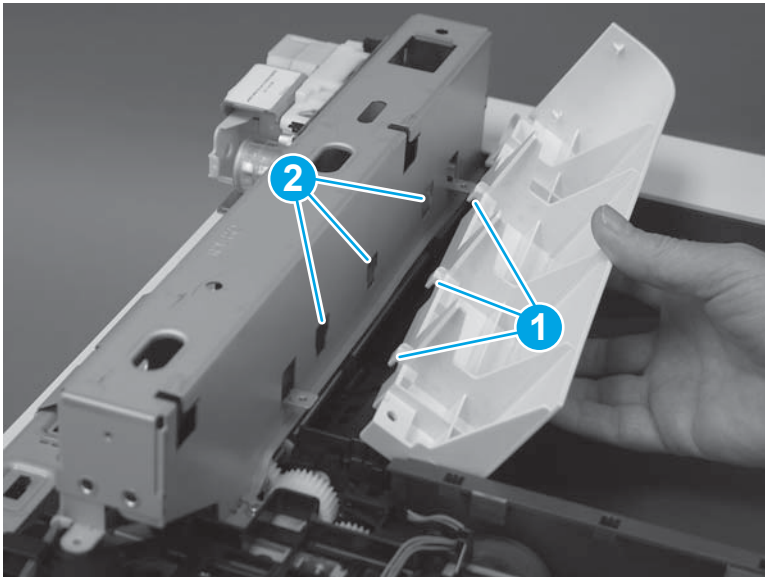

2. Install one screw (callout 1).

Figure 1-781 Install one screw

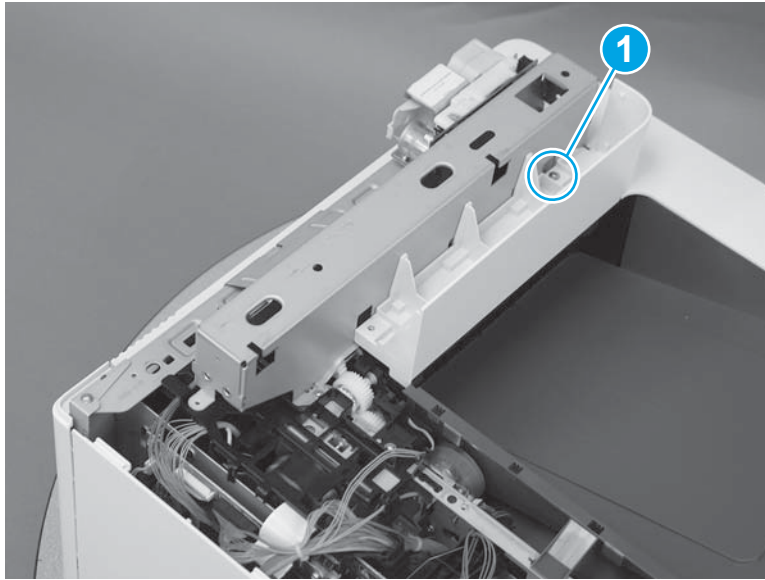

Step 24: Install the top rear cover (M577)

 **NOTE:** This step is for the M577 models. For the M552 and M553 models, skip this step and go to [Step 31: Install the upper cover \(M552 and M553\) on page 476](#).

1. Align the locator tabs (callout 1) on the cover with the slots (callout 2) in the printer.

Figure 1-782 Align the locator tabs

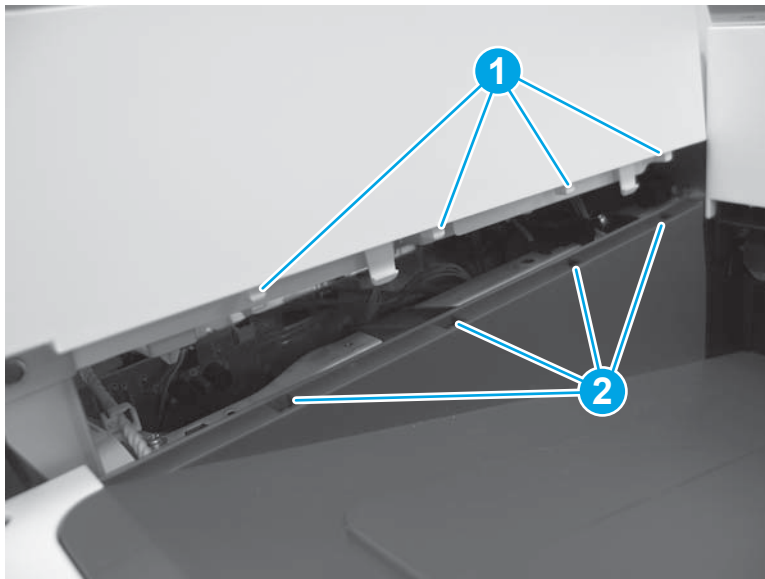

2. Press down to install the cover. Make sure that the tabs snap into place.

Figure 1-783 Install the cover

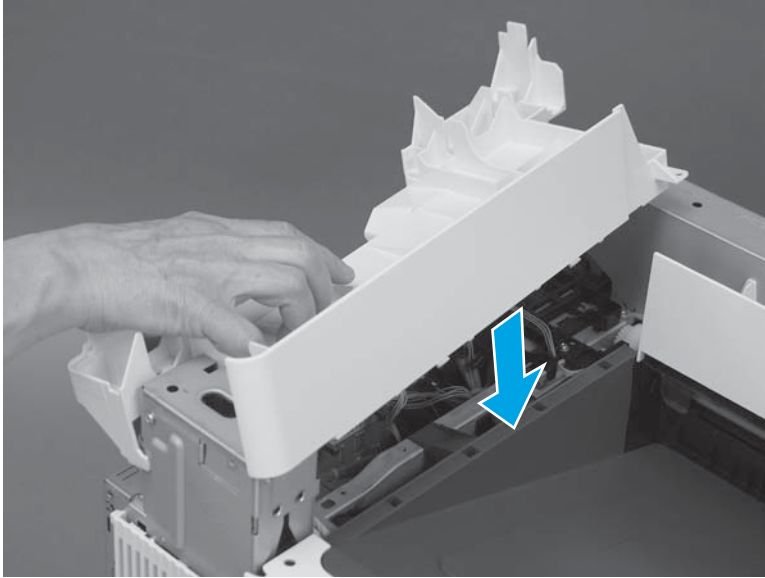

3. At the top of the printer, install five screws (callout 1).

Figure 1-784 Install five screws

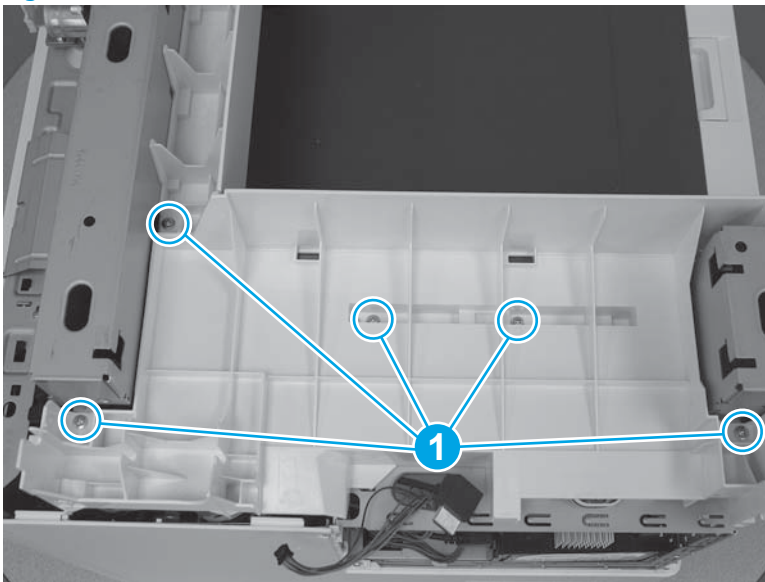

Step 25: Install the right upper cover (M577)



NOTE: This step is for the M577 models. For the M552 and M553 models, skip this step and go to [Step 31: Install the upper cover \(M552 and M553\) on page 476.](#)



NOTE: The figures below show the image scanner installed. The procedures for removing and installing the right upper cover are the same whether the image scanner is installed or removed."

1. **M577c/f/z only:** Install the cables (callout 1) through the slot (callout 2) in the printer.

Figure 1-785 Install the cables

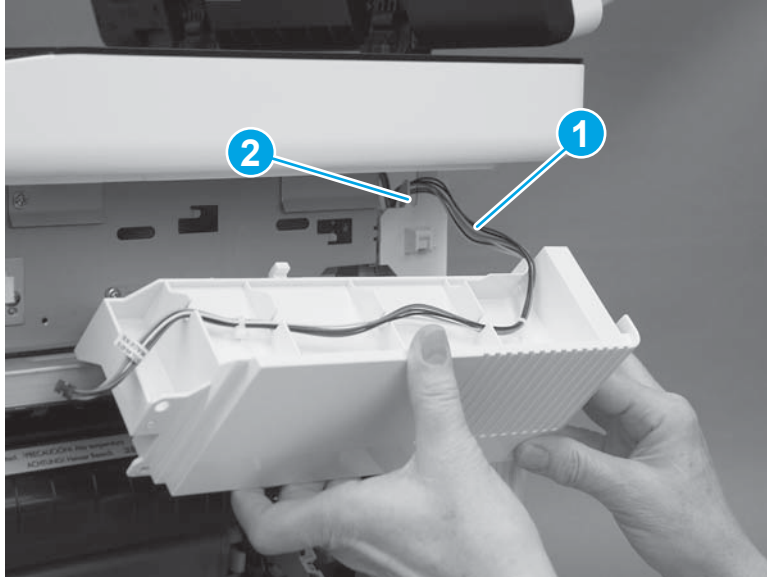

2. Position the hooks (callout 1) on the cover in the slots (callout 2) in the printer.

Figure 1-786 Position the hooks

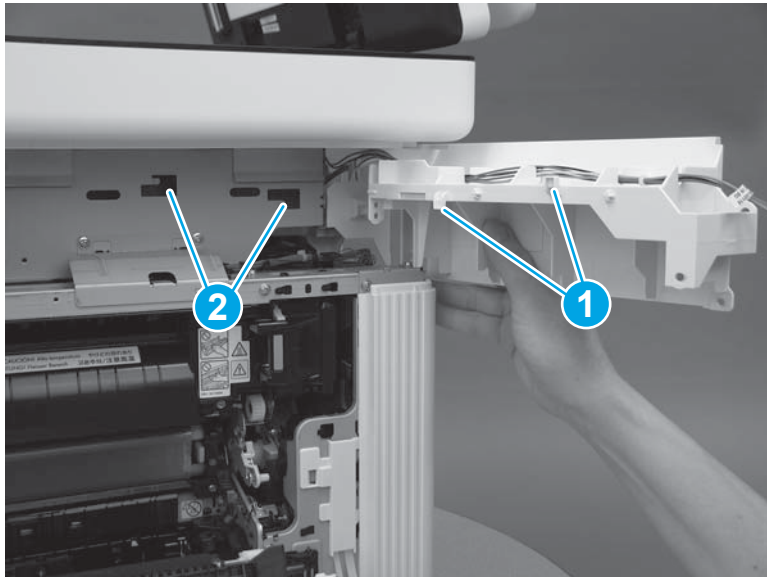

3. Slide the cover toward the front of the printer to install it.

Figure 1-787 Install the cover

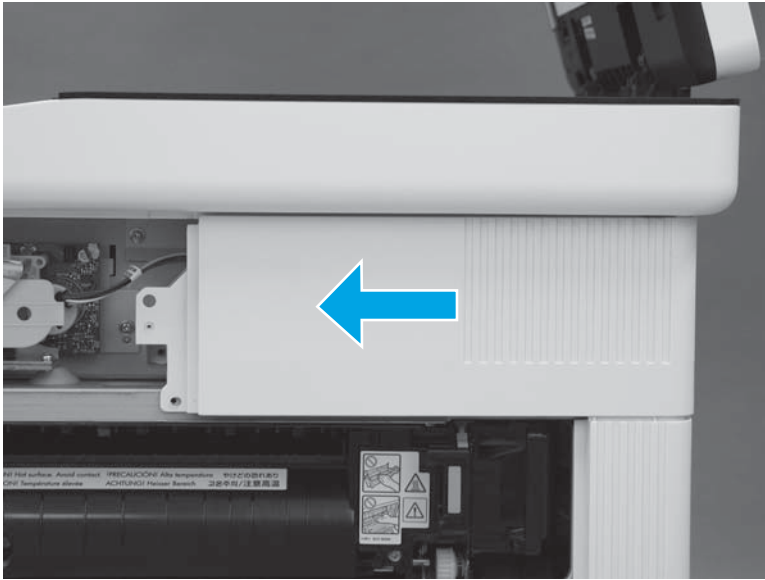

4. At the back of the printer, install one screw (callout 1).

M577c/f/z only: Connect one connector (callout 2), if the integrated scanner assembly is installed.

TIP: This screw is smaller than the screws installed in the next step. Make sure that this screw is installed in the correct position.

Figure 1-788 Install one screw and connector

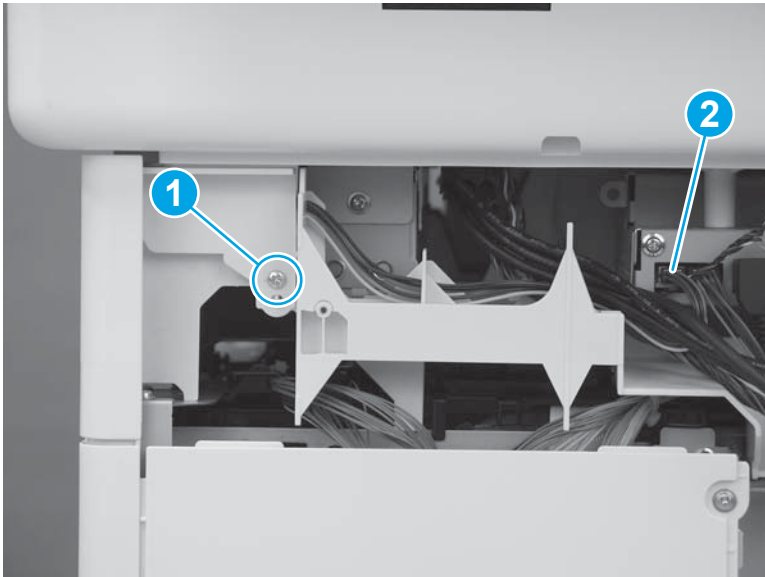

5. At the right side of the printer, install two screws (callout 1).

M577c/f/z only: Connect one connector (callout 2), if the stapler is installed.

Figure 1-789 Install one screw and connector

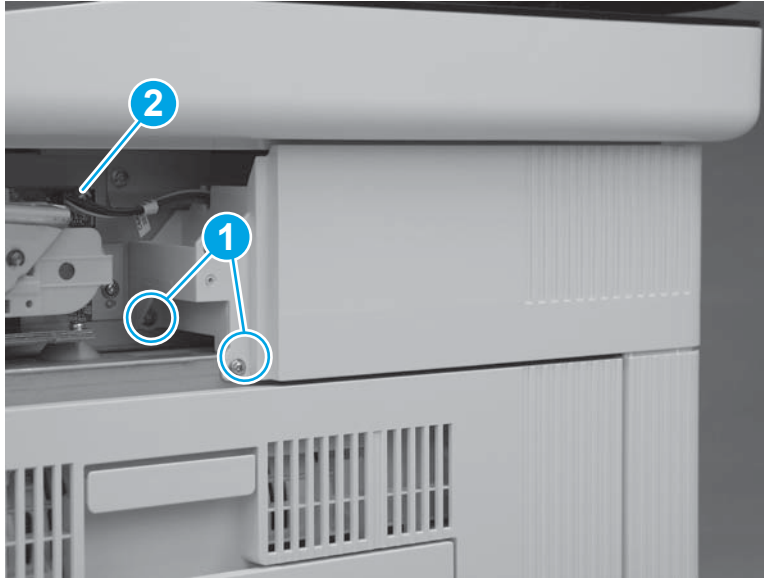

Step 26: Install the stapler (M577c/f/z)

 **NOTE:** This step is for the M577c/f/z models only. For the M577dn model, skip this step and go to [Step 27: Install the integrated scanner assembly \(M577\) on page 468.](#)

For the M552 and M553 models, skip this step and go to [Step 31: Install the upper cover \(M552 and M553\) on page 476.](#)

1. Position the hooks (callout 1) on the stapler unit in the slots (callout 2) in the printer.

Figure 1-790 Position the hooks in the slots

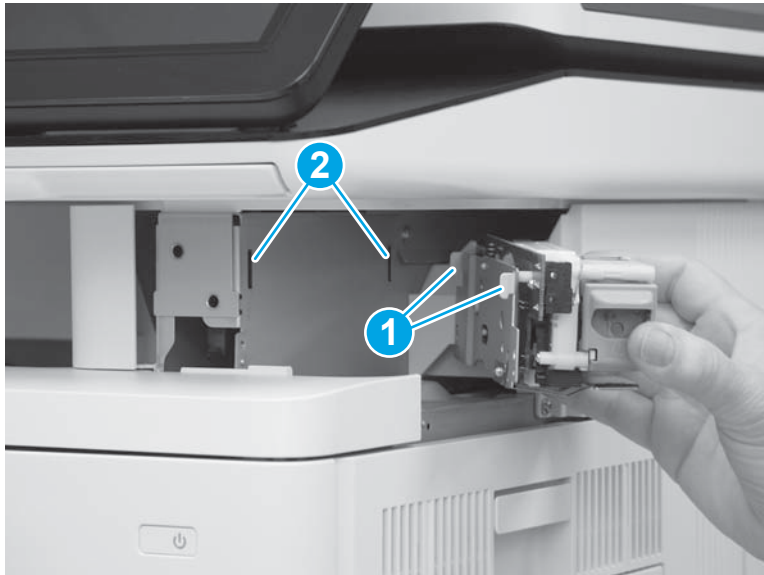

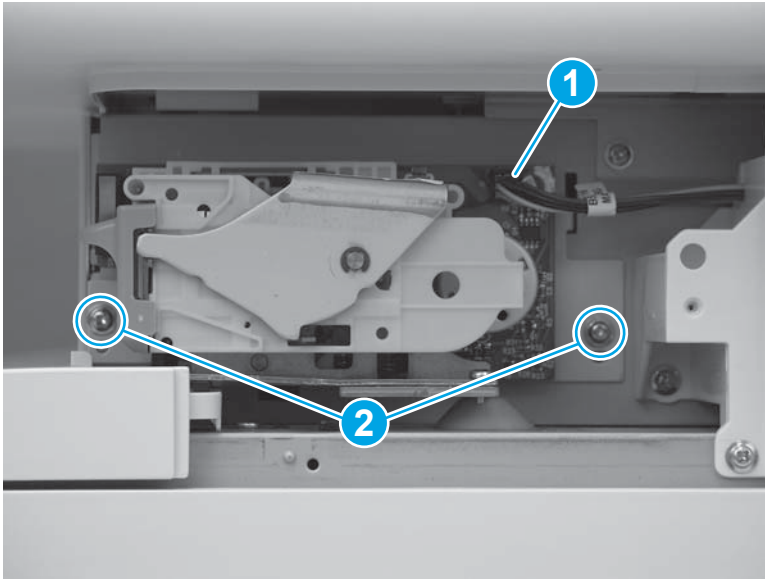

2. Connect one connector (callout 1), and then install two screws (callout 2).

Figure 1-791 Connect connector and install screws



Step 27: Install the integrated scanner assembly (M577)

 **NOTE:** This step is for the M577 models. For the M552 and M553 models, skip this step and go to [Step 31: Install the upper cover \(M552 and M553\) on page 476](#).

 **NOTE:** The ISA includes the document feeder, image scanner, scanner control board (SCB), control panel, keyboard (M577c/z) and NFC PCA (M577z).

1. Before proceeding, locate the mounting pins (callout 1) on the bottom of the ISA and the slots (callout 2) on the printer base.

Figure 1-792 Locate the ISA mounting pins and slots

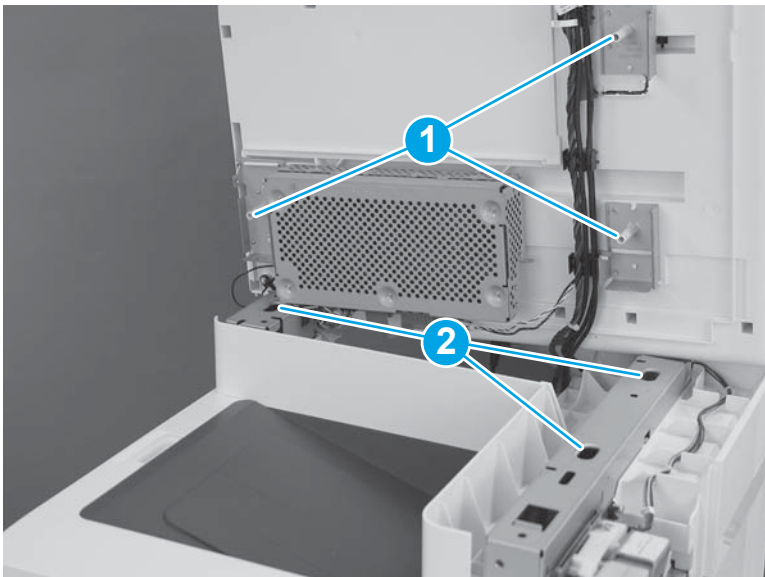

2. Position the ISA on the printer base with the pins in the slots.



NOTE: To locate the pins and slots, see [Figure 1-395 Locate the ISA mounting pins and slots on page 250](#).

Figure 1-793 Install the ISA



3. Slightly slide the ISA towards the front of the printer to engage it.

Figure 1-794 Slide the ISA towards the front of the printer

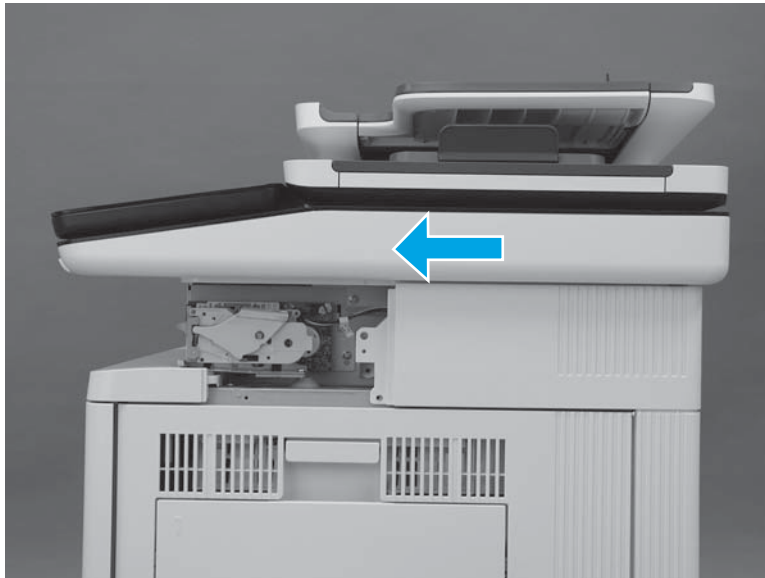

4. At the left side of the printer, install one screw (callout 1).

Figure 1-795 Install one screw

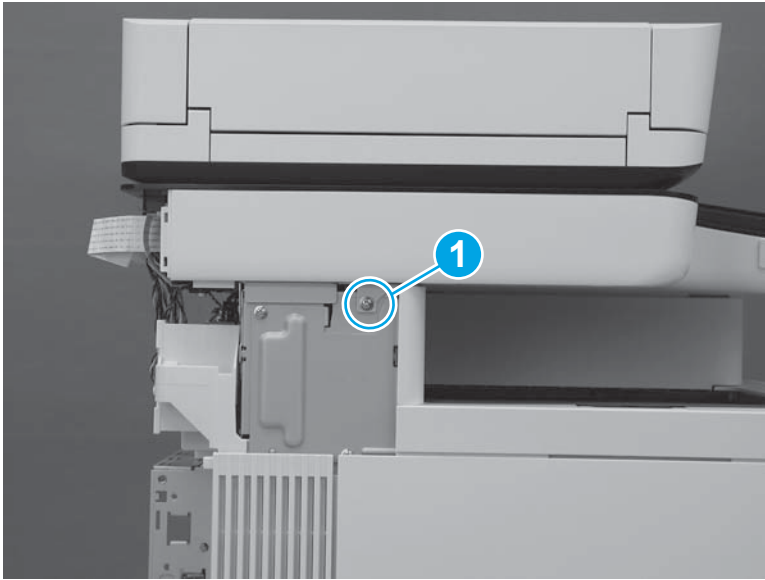

5. At the back of the printer, install two screws (callout 1).

Figure 1-796 Install two screws

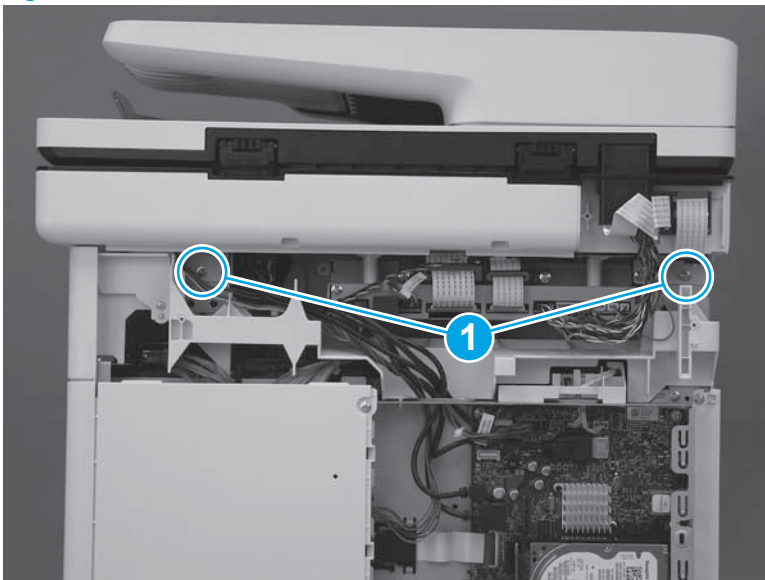

6. At the right side of the printer, install one screw (callout 1).

Figure 1-797 Install one screw

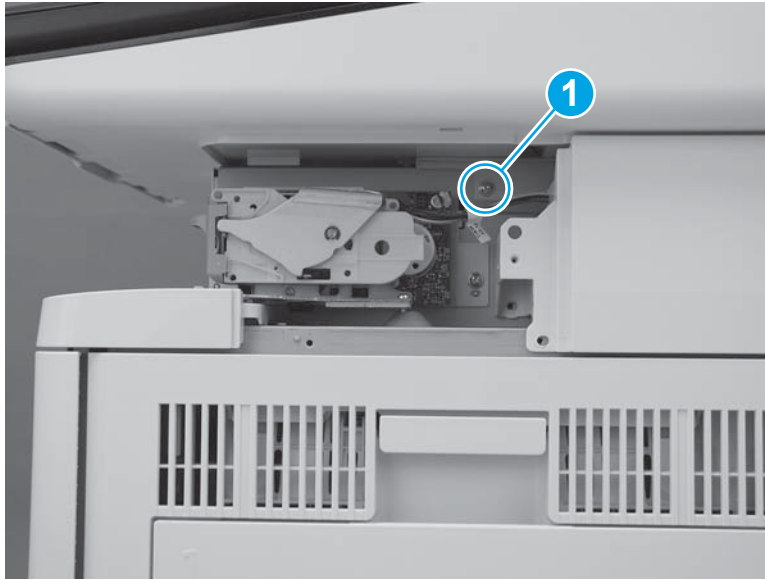

7. Connect two connectors on the scanner control board (callout 1).

M577c/f/z only: Connect one connector for the stapler on the scanner control board (callout 2).

Figure 1-798 Connect connectors

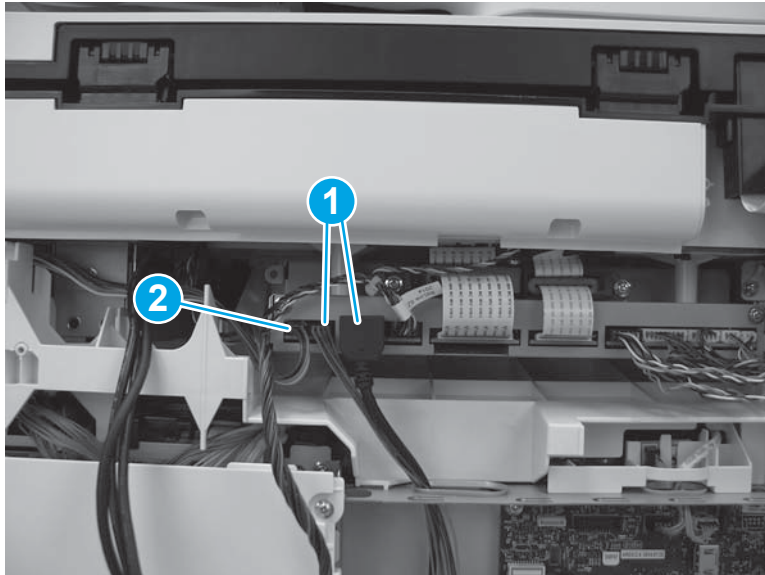

8. Install the wire harness and cables (callout 1) in the retainers (callout 2). Pass them through the opening in the top of the formatter cover (callout 3), and then connect four connectors (callout 4) on the formatter.

Figure 1-799 Connect four connectors

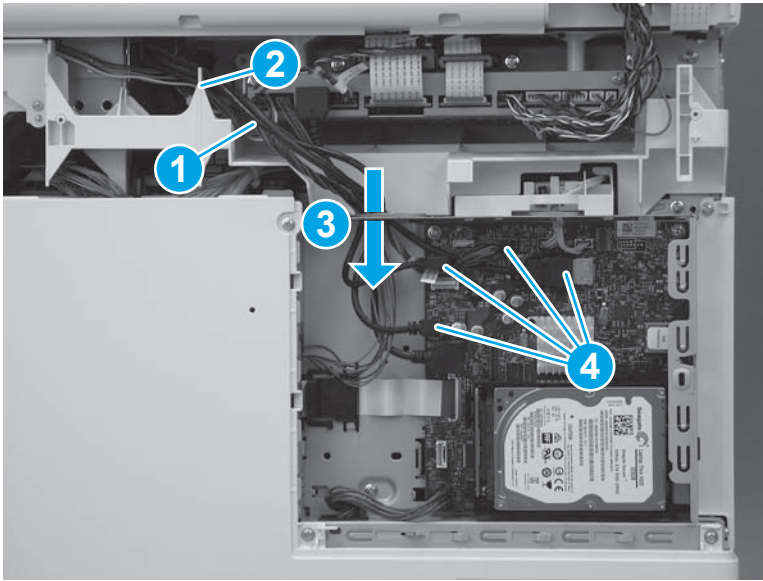

Step 28: Install the stapler cover assembly (M577c/f/z)

 **NOTE:** This step is for the M577c/f/z models only. For the M577dn model, skip this step and go to [Step 29: Install the right front upper cover \(M577dn\) on page 473](#).

For the M552 and M553 models, skip this step and go to [Step 31: Install the upper cover \(M552 and M553\) on page 476](#).

1. Install the tabs (callout 1) on the cover in the slots (callout 2) in the printer.

Figure 1-800 Install two tabs



2. Press the cover toward the left side of the printer until it snaps into place.

Figure 1-801 Install the cover assembly



3. Install one screw (callout 1).

 **IMPORTANT:** This is a self-tapping screw for plastic. Rotate it counterclockwise to align it with the existing thread pattern, and then carefully turn it clockwise to tighten. Do not overtighten. This will prevent stripping the threads inside the screw hole.

Figure 1-802 Install one screw



Step 29: Install the right front upper cover (M577dn)

 **NOTE:** This step is for the M577dn model only. For the M577f and M577z models, skip this step and go to [Step 30: Install the left upper cover \(M577\) on page 475](#).

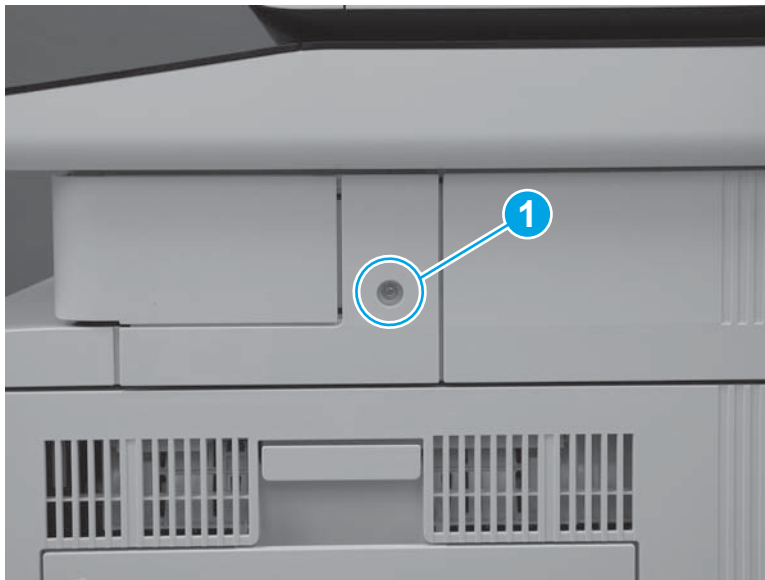
For the M552 and M553 models, skip this step and go to [Step 31: Install the upper cover \(M552 and M553\) on page 476](#).

1. Slide the cover toward the left side of the printer to install it. Make sure that the slots (callout 1) in the cover fit over the tabs (callout 2) on the inside of the paper feeder cover.

Figure 1-803 Install the cover

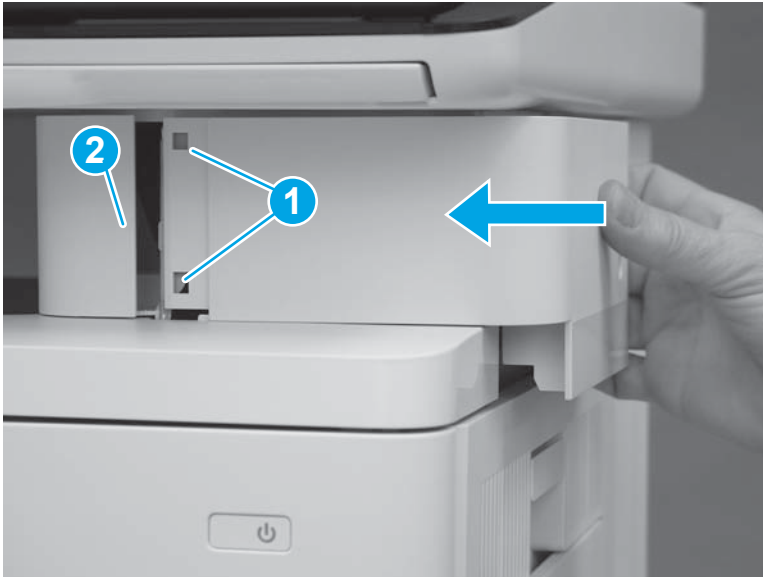

2. Press the right front upper cover (callout 1) and the paper feeder cover (callout 2) together until the tabs on the inside of the covers snap into place.

Figure 1-804 Press the cover



3. Install one screw (callout 1).

Figure 1-805 Install one screw

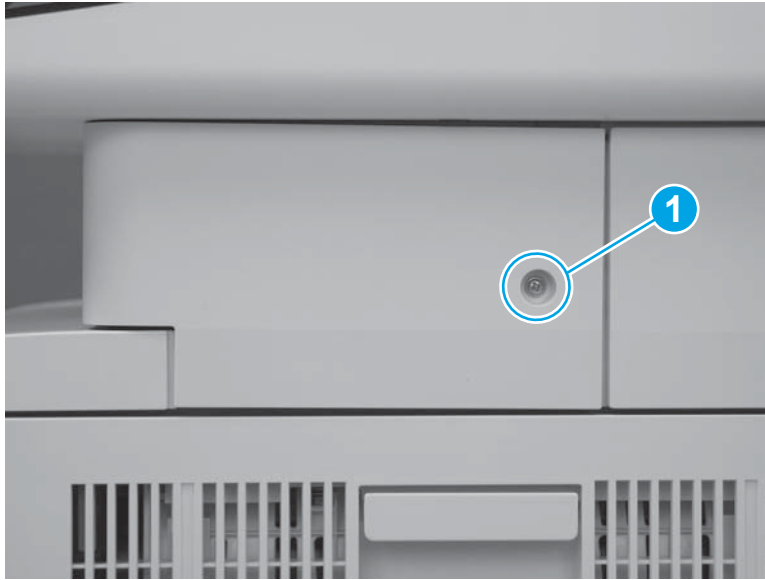

Step 30: Install the left upper cover (M577)

 **NOTE:** This step is for the M577 models. For the M552 and M553 models, skip this step and go to [Step 31: Install the upper cover \(M552 and M553\) on page 476](#).

1. Position the tab (callout 1) on the lower edge of the cover behind the left cover (callout 2).

Figure 1-806 Position the tab

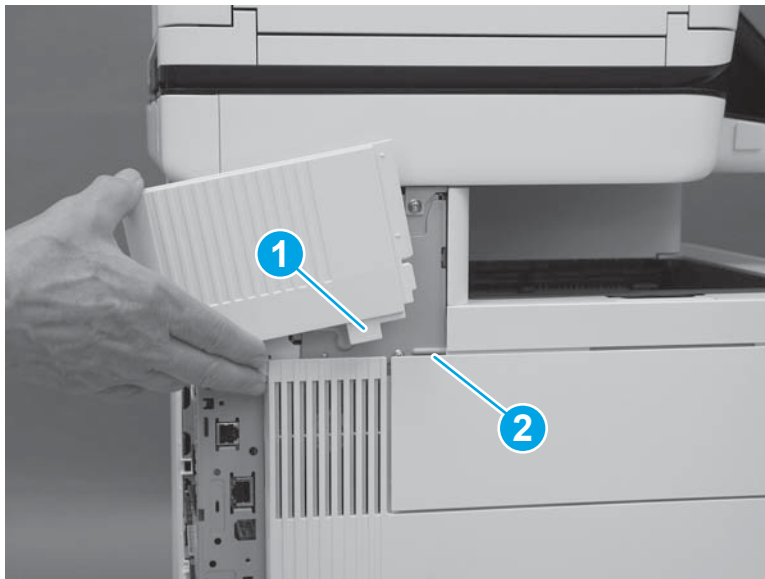

2. Slide the cover toward the front of the printer to install it. Make sure that the edge (callout 1) of the cover fits behind the edge (callout 2) of the top rear cover.

Figure 1-807 Slide the cover

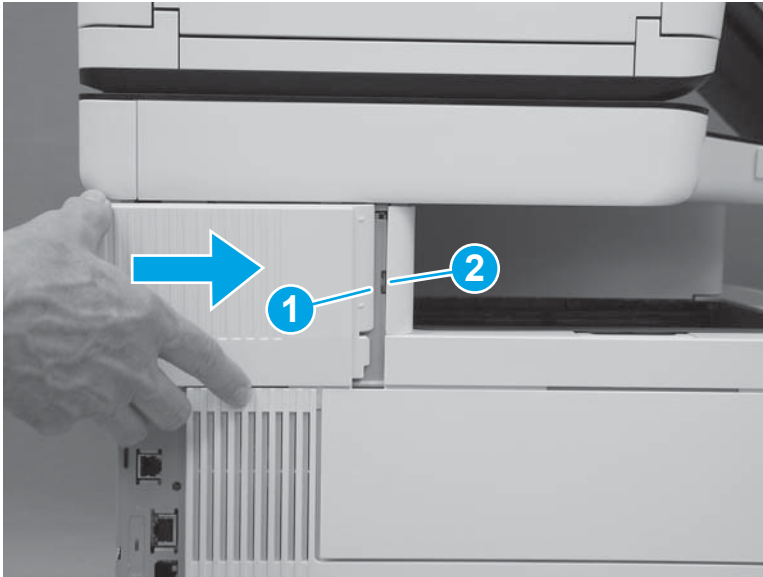

3. Make sure that the tab (callout 1) is fully installed.

Figure 1-808 Check the tab

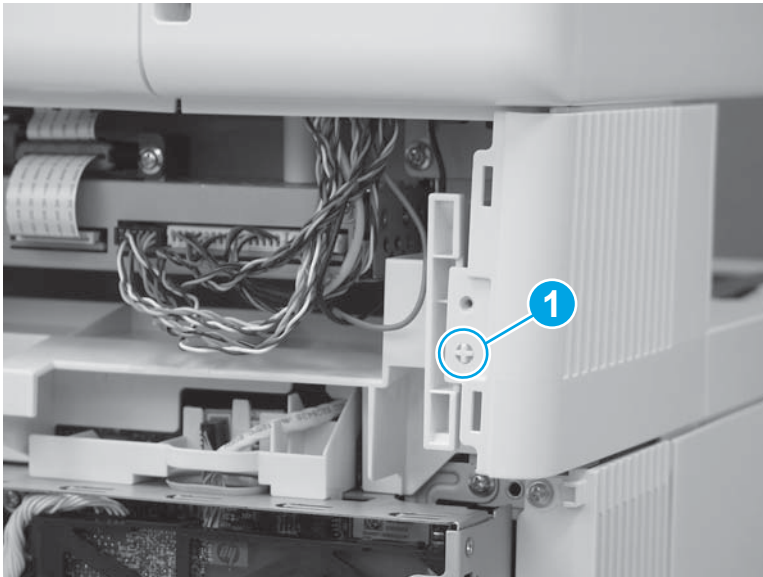

Step 31: Install the upper cover (M552 and M553)

 **NOTE:** This step is for the M552 and M553 models. For the M577 models, skip this step and go to [Step 32: Install the left cover on page 478](#).

1. Position the cover on the printer.

 **NOTE:** For the M553x model, do not forget to pass the control-panel wire harness and USB cable through the opening in the cover.

Figure 1-809 Install the cover



2. Push down on the rear corner of the cover to engage one tab (callout 1).

Figure 1-810 Engage one tab

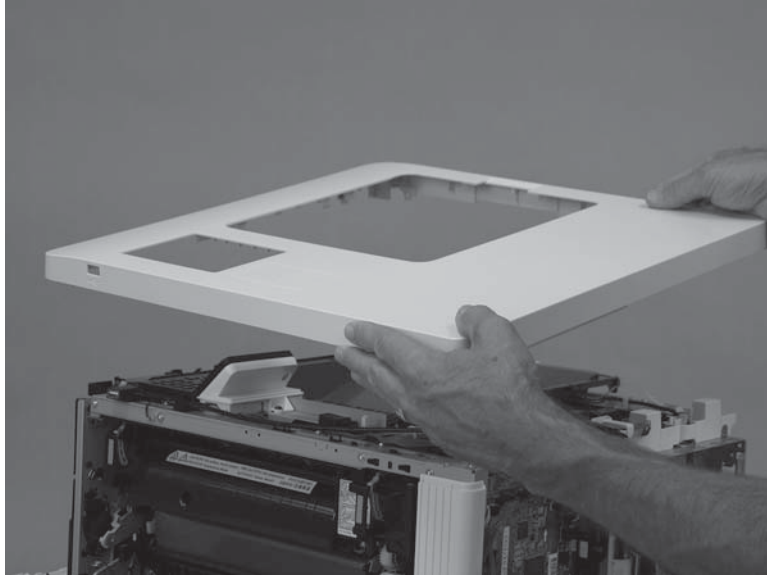
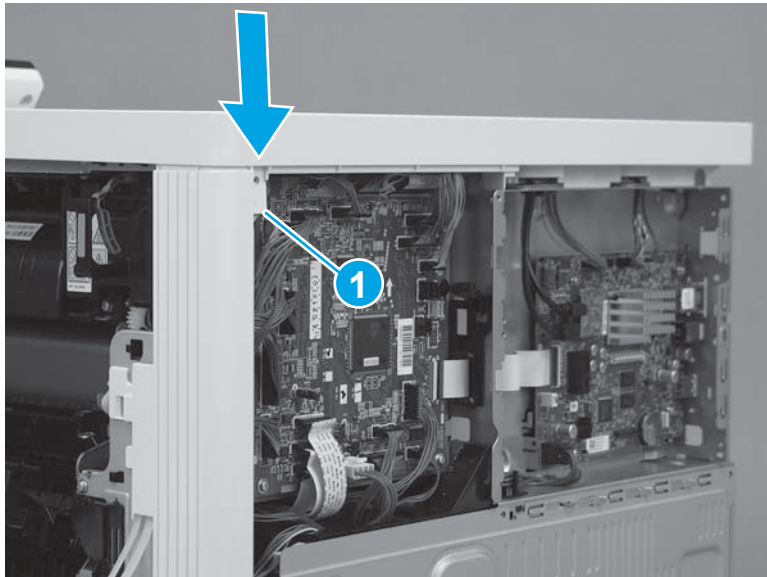

3. Push down on the front corner of the cover to engage one tab (callout 1), and then install one screw (callout 2).

 **NOTE:** This is a self-tapping plastic-thread screw. Make sure that this screw is used in this location when it is reinstalled.

Figure 1-811 Engage one tab and install one screw



4. Install three screws (callout 1).

Figure 1-812 Install three screws

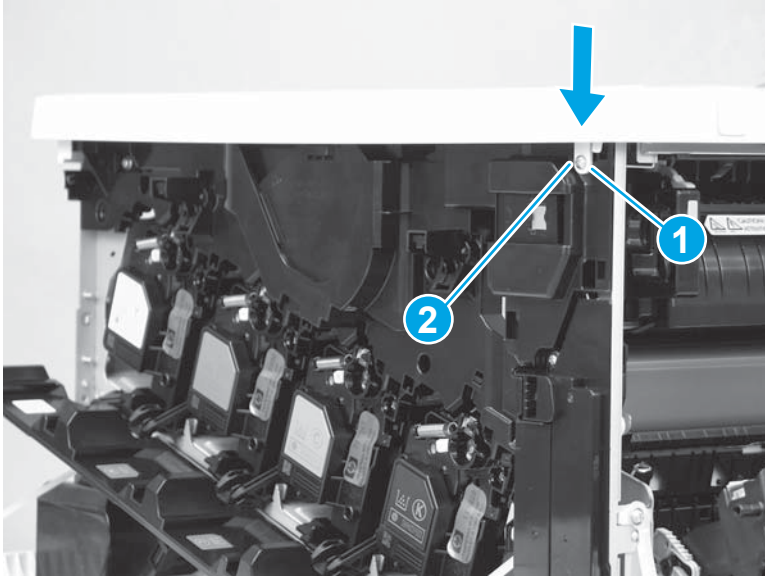
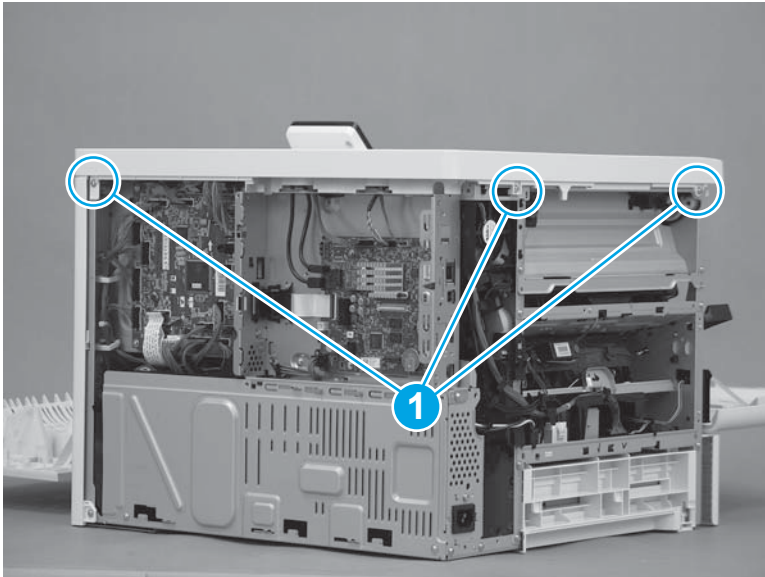

Step 32: Install the left cover

1. Position the cover on the printer.

 **NOTE:** Slightly offset the cover toward the rear of the printer.

Figure 1-813 Install the cover

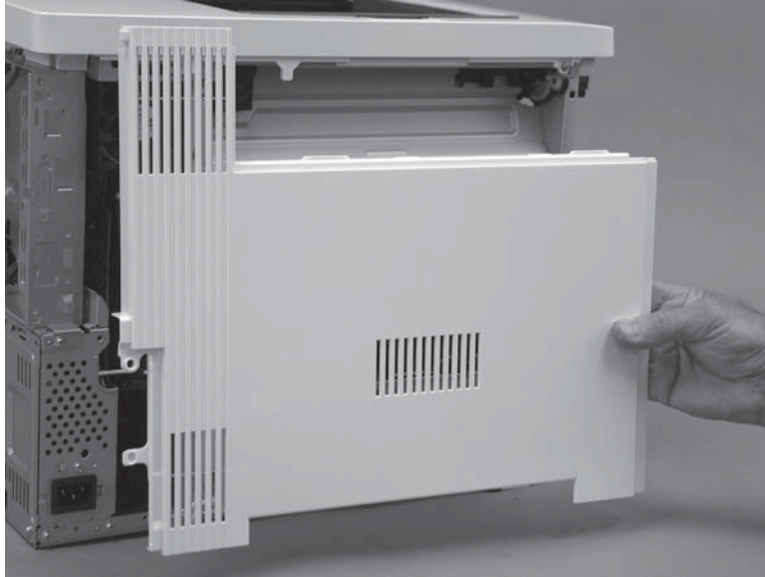

2. Slide the cover (callout 1) toward the front of the printer to engage it. Make sure that the tab (callout 2) snaps into place.

 **NOTE:** Locate the alignment pin (callout 3) on the cover from the front door side of the printer, and then make sure that it is fully engaged in the slot in the chassis.

 **TIP:** While sliding the cover into place, push in on the center of the cover (callout 1) to make sure that the hooks on the back of the cover engage with the slots in the chassis.

Figure 1-814 Engage the cover



3. At the left side of the printer, install one screw (callout 1).

Figure 1-815 Install one screw

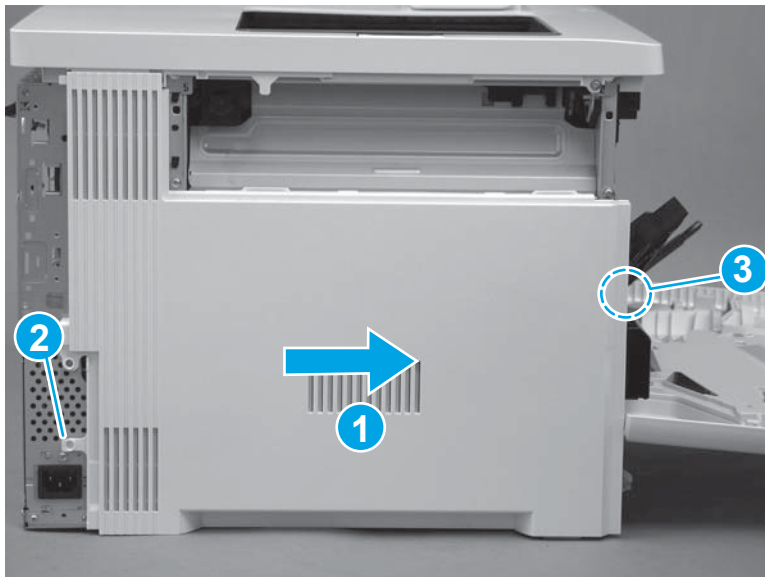

Step 33: Install the rear cover (M577)



NOTE: This step is for the M577 models. For the M552 and M553 models, skip this step and go to [Step 35: Install the rear cover \(M552 and M553\) on page 483](#).

1. Position the hooks (callout 1) on the cover in the slots (callout 2) in the printer.

Figure 1-816 Position the hooks

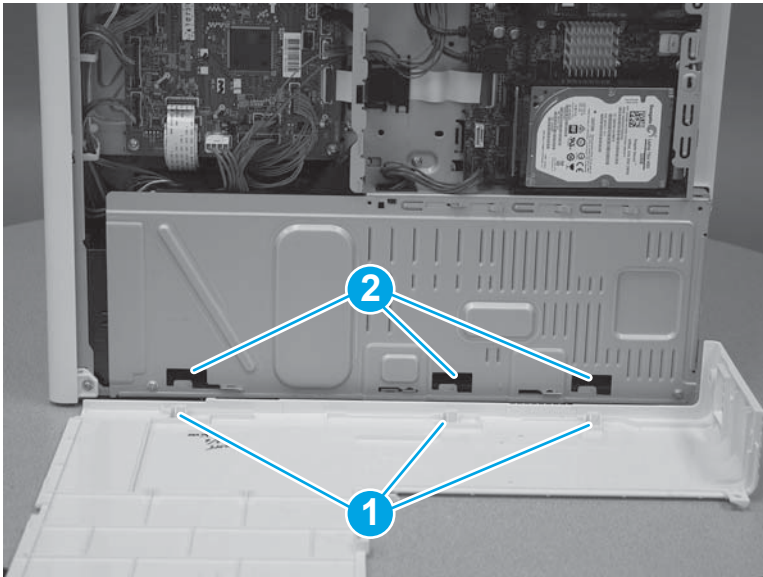

2. Position the back edge (callout 1) of the rear cover behind the edge (callout 2) of the right rear cover. Slide the cover to the left to install it.

Figure 1-817 Install the cover

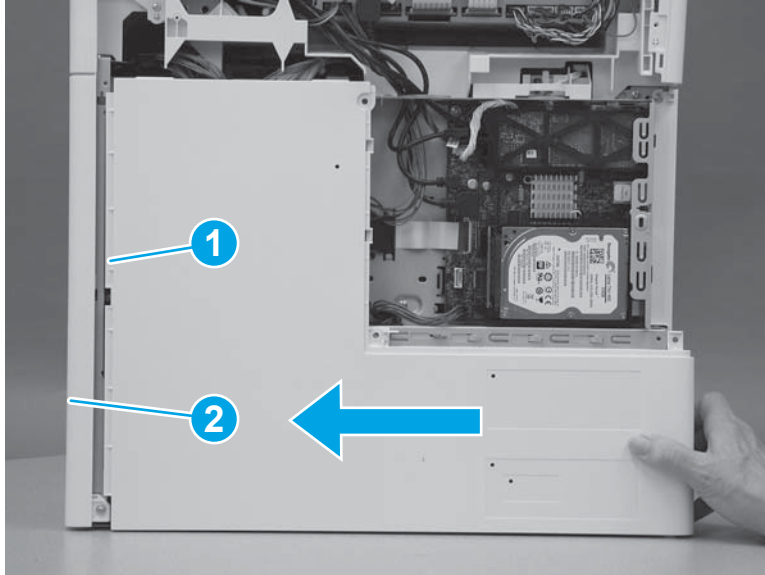

3. Install four screws (callout 1).

Figure 1-818 Install four screws cover

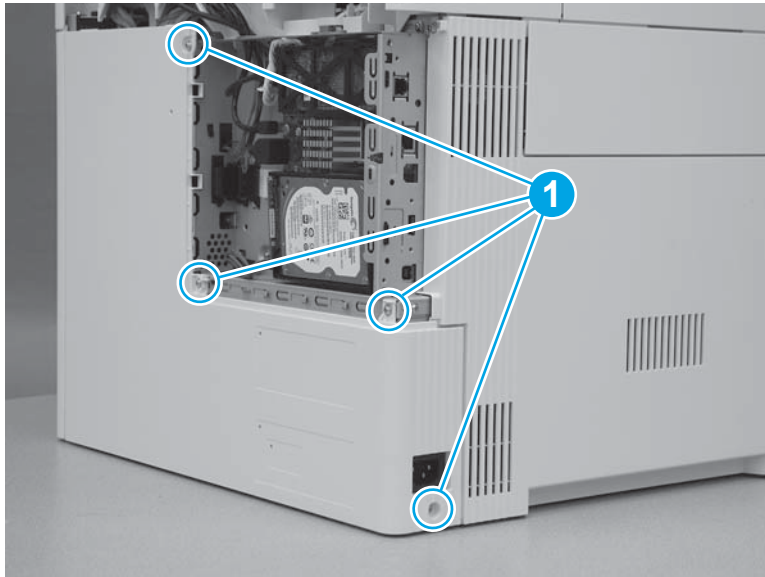

Step 34: Install the rear upper cover (M577)

 **NOTE:** This step is for the M577 models. For the M552 and M553 models, skip this step and go to [Step 35: Install the rear cover \(M552 and M553\) on page 483](#).

1. Align the ridge (callout 1) on the lower edge of the rear upper cover in front of the tabs (callout 2) on the top edge of the rear cover.

Figure 1-819 Align the cover

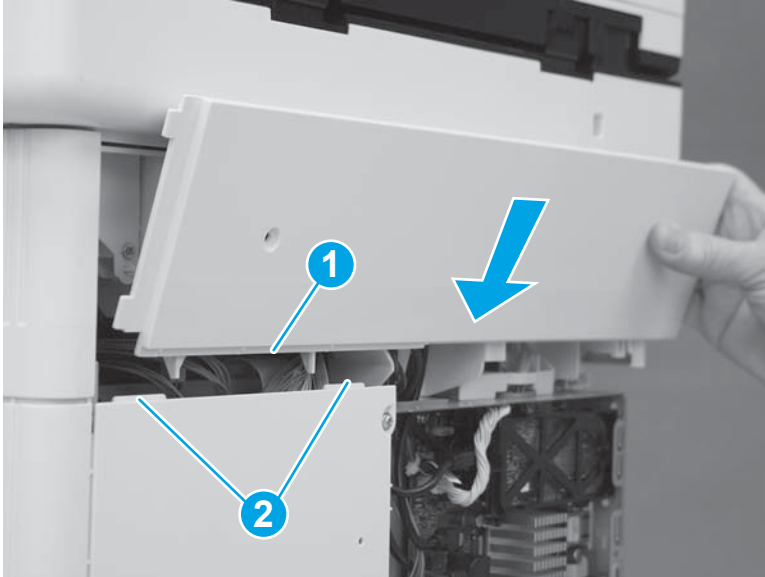

2. Rotate the top of the cover toward the printer.

Figure 1-820 Rotate the top of the cover

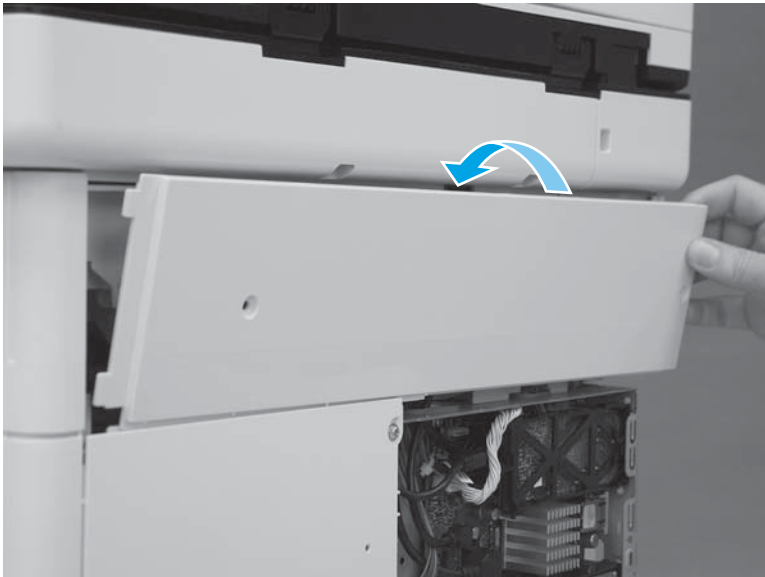

3. Slide the cover to the left (callout 1). Make sure that the tabs (callout 2) on the upper rear cover slide behind the edge (callout 3) of the right upper cover. Make sure that the cover is fully seated.

Figure 1-821 Slide the cover

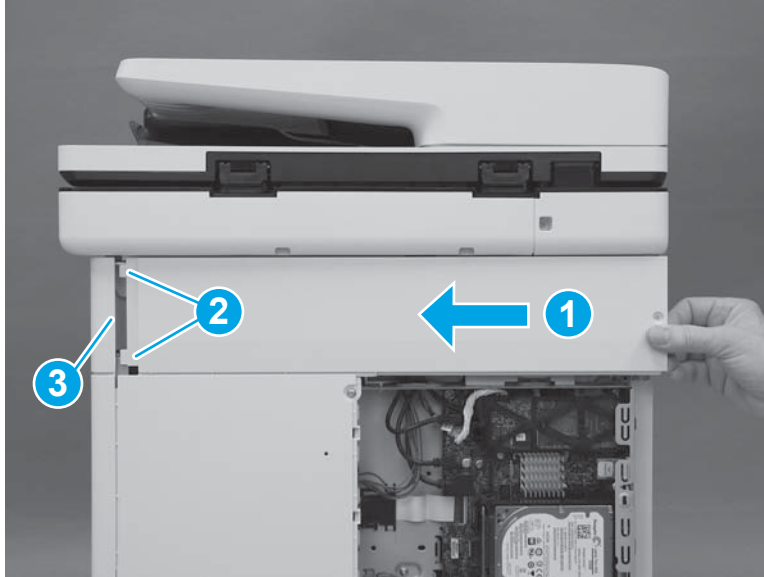

4. Install two screws (callout 1).

 **IMPORTANT:** These two screws are self-tapping screws for plastic. Rotate them counterclockwise to align them with the existing thread pattern, and then carefully turn them clockwise to tighten. Do not overtighten. This will prevent stripping the threads inside the screw holes.

Figure 1-822 Install two screws



Step 35: Install the rear cover (M552 and M553)

 **NOTE:** This step is for the M552 and M553 models. For the M577 models, skip this step and go to [Step 38: Install the toner collection unit \(TCU\) on page 488](#).

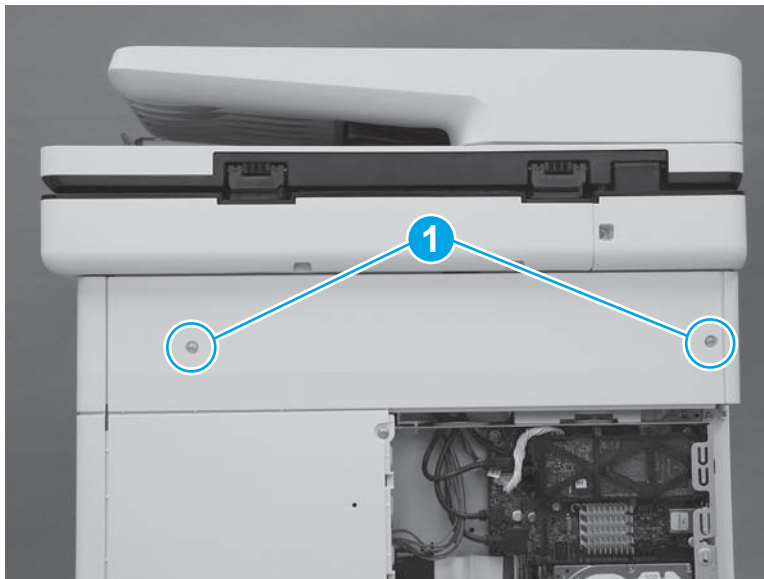
1. Position the top of the cover under the upper cover (callout 1), rotate the bottom of the cover onto the chassis (callout 2), and then slide the cover to the left (callout 3) to install it.

Figure 1-823 Install the cover

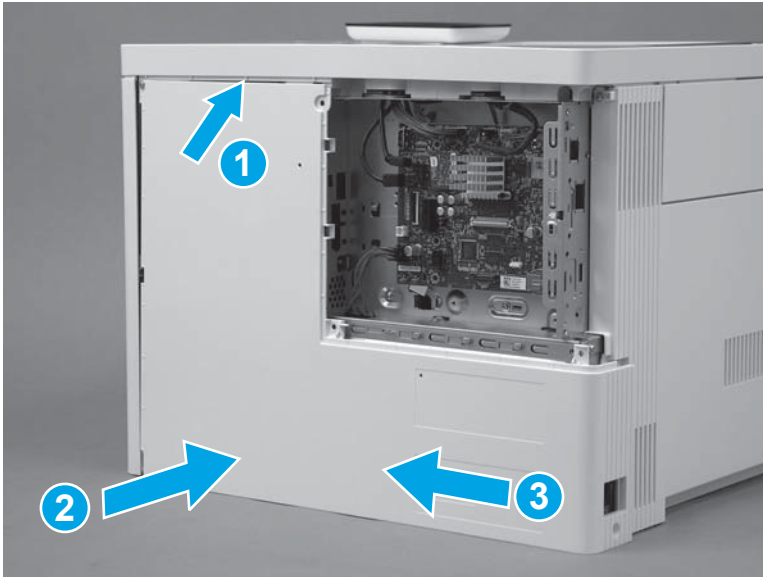

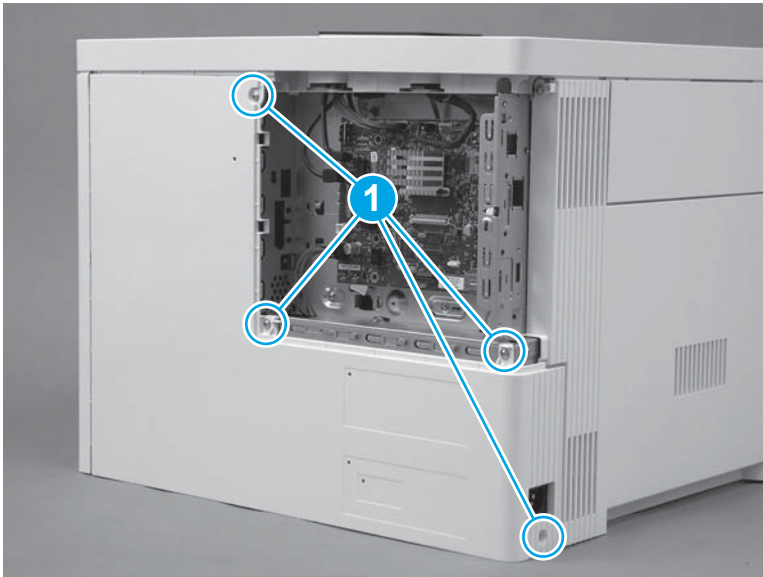

2. Install four screws (callout 1).

Figure 1-824 Install four screws cover



Step 36: Install the control-panel assembly (M553x only)

 **NOTE:** This step is for the M553x model. For the M553n/dn and M552dn models, skip this step and go to [Step 37: Install the USB cover \(M552 and M553\) on page 487](#).

 **NOTE:** For the M577 models, skip this step and go to [Step 38: Install the toner collection unit \(TCU\) on page 488](#).

1. Place the control panel on the printer as shown.

Figure 1-825 Place the control panel on the product

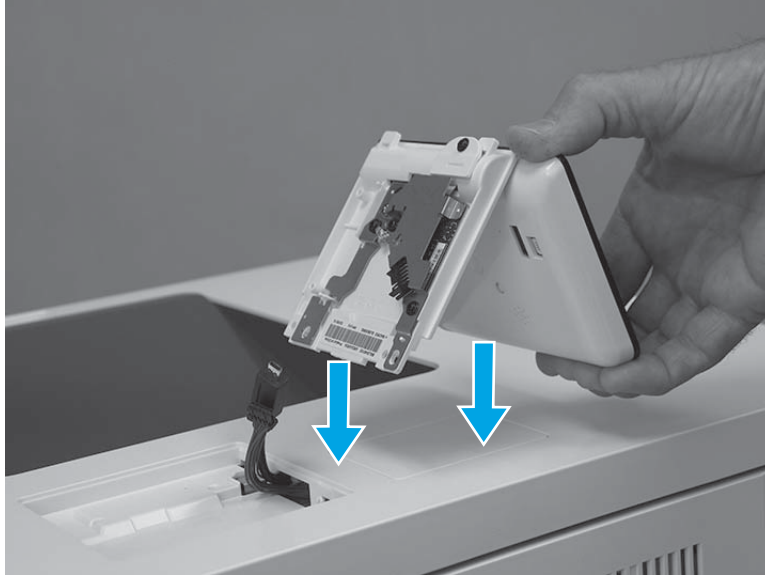

2. Connect one USB cable (callout 1), and one connector (callout 2).



IMPORTANT: Take note of the location of the two mounting tabs (callout 3) on the control-panel assembly.

Figure 1-826 Connect two connectors

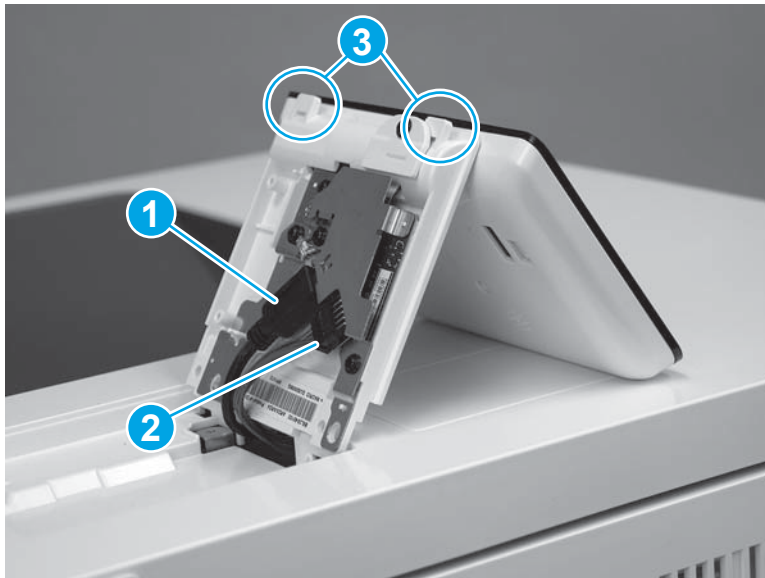

3. Turn the control panel over, and then position the front edge tabs in the slots in the top cover.

Figure 1-827 Turn the control panel over

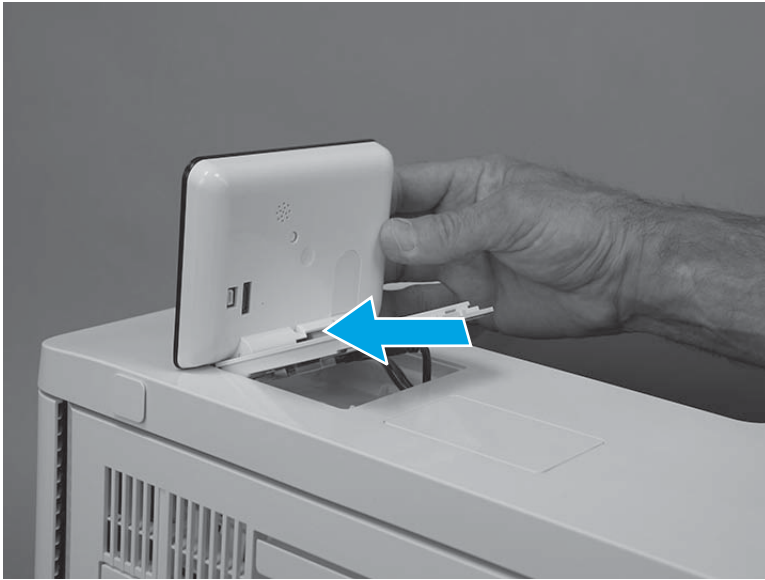

4. Rotate the control-panel base down onto the printer.

Figure 1-828 Rotate the control-panel base down



5. Use a small Phillips screwdriver to install two screws (callout 1).

Figure 1-829 Install two screws

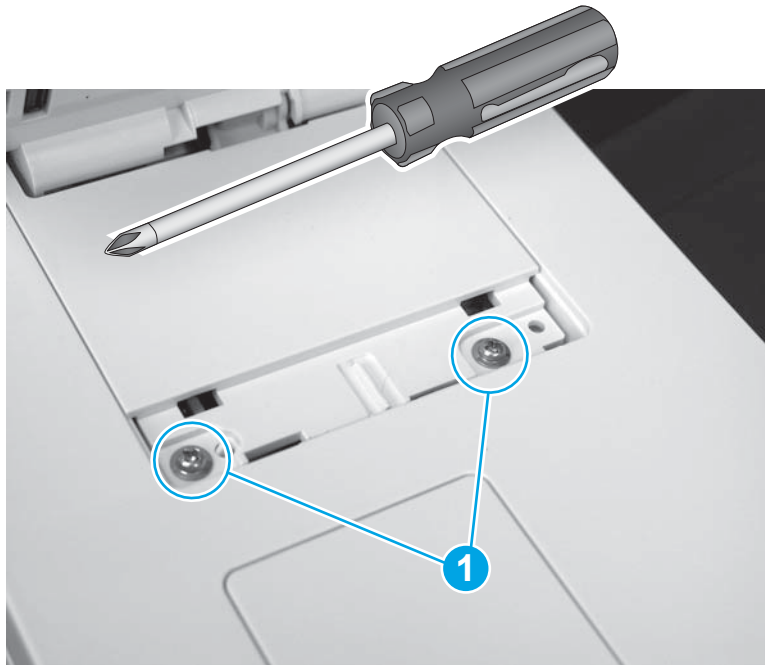

6. Position the screw cover mounting feet into the slots in the top cover (callout 1), and then rotate the cover down (callout 2) to install it.

 **NOTE:** Press down on the cover firmly to make sure that the tabs on the cover (callout 3) snap into place.

Figure 1-830 Install the cover



Step 37: Install the USB cover (M552 and M553)

 **NOTE:** This step is for the M552 and M553 models. For the M577 models, skip this step and go to [Step 38: Install the toner collection unit \(TCU\) on page 488.](#)

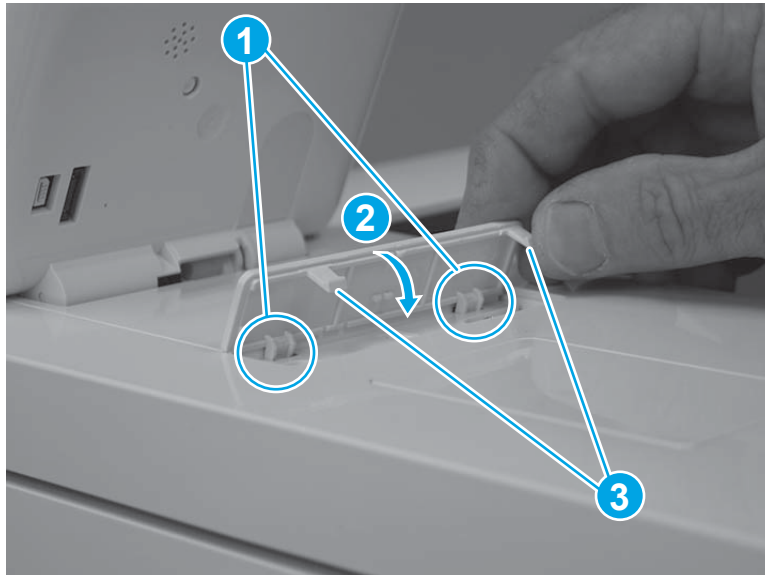
1. Push the cover into the USB port to install it.

Figure 1-831 Install the cover



2. Make sure that the USB cover is fully seated after installing it.

Figure 1-832 Check the installation



Step 38: Install the toner collection unit (TCU)

1. Verify that the toner collection hatch cover is in the closed position on the TCU.

Figure 1-833 Verify that the toner collection hatch cover is closed

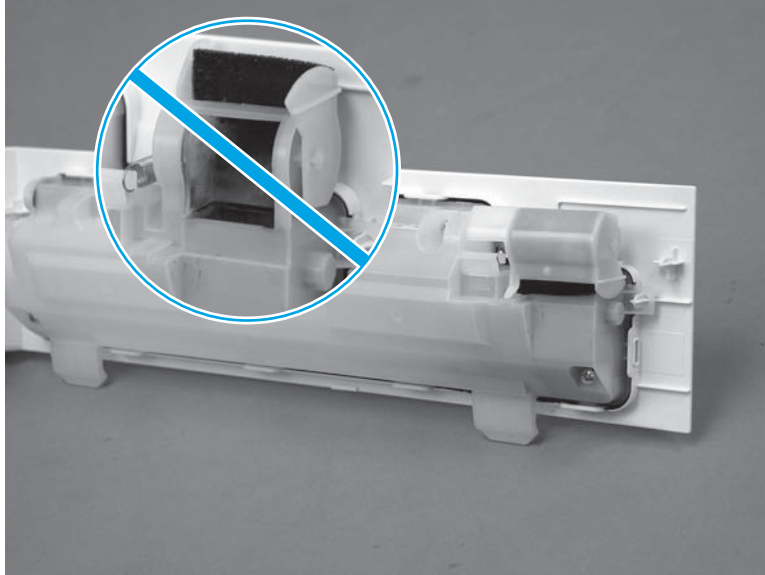

2. Position the TCU with the hinges in the slots provided in the printer (callout 1), and then rotate the TCU up and into the closed position.

 **NOTE:** The toner collection hatch cover automatically opens when the TCU is closed.

Figure 1-834 Install the TCU



3. Close the front door.

Figure 1-835 Close the front door

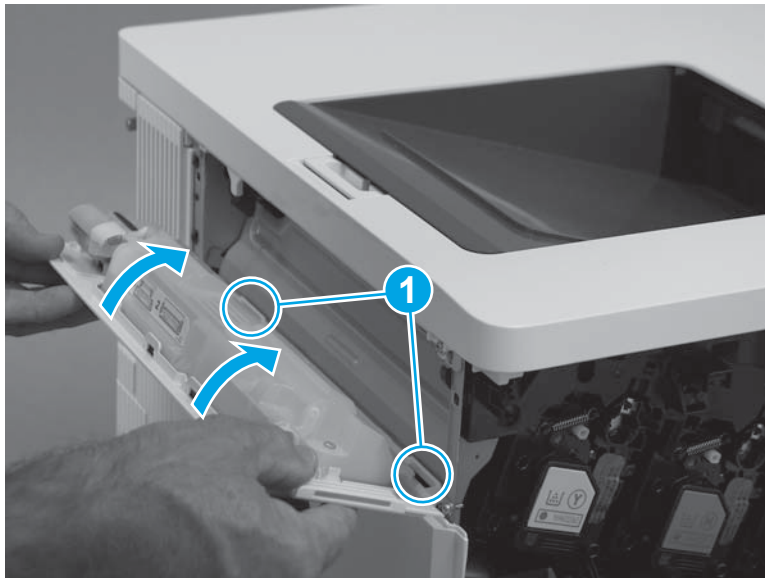

Step 39: Install the formatter cover

- ▲ Slide the cover onto the printer (callout 1) to install it.

 **NOTE:** Make sure that the tabs on the formatter cover align with the slots provided in the printer (callout 2). Tighten the two thumbscrews (callout 3).

 **TIP:** If needed, use the edge of a coin to turn the thumbscrews.

Figure 1-836 Install the cover



Removal and replacement: Right rear cover (M552 and M553)

- [Introduction](#)
- [Step 1: Remove the USB cover](#)
- [Step 2: Remove the control panel \(M553x only\)](#)
- [Step 3: Remove the toner collection unit \(TCU\)](#)
- [Step 4: Remove the formatter cover](#)
- [Step 5: Remove the rear cover](#)
- [Step 6: Remove the left cover](#)
- [Step 7: Remove the upper cover](#)
- [Step 8: Remove the right rear cover](#)
- [Step 9: Unpack the replacement assembly](#)
- [Step 10: Install the right rear cover](#)
- [Step 11: Install the upper cover](#)
- [Step 12: Install the left cover](#)
- [Step 13: Install the rear cover](#)
- [Step 14: Install the formatter cover](#)
- [Step 15: Install the TCU](#)
- [Step 16: Install the control-panel assembly \(M553x only\)](#)
- [Step 17: Install the USB cover](#)

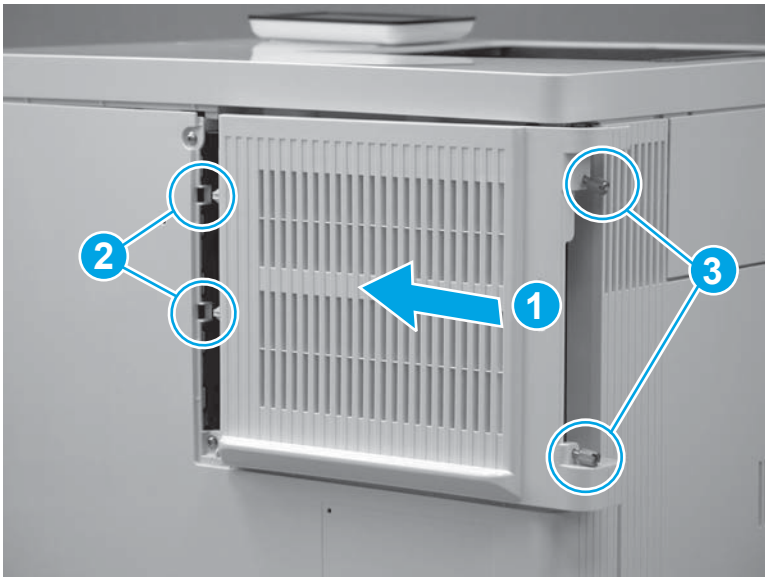
Introduction

This document provides the procedures to remove and replace the right rear cover.

Before performing service

Turn the printer power off

- Disconnect the power cable.

 **WARNING!** To avoid damage to the printer, turn the printer off, wait 30 seconds, and then remove the power cord before attempting to service the printer.

- Open the right door.

Use the table below to identify the correct part number for your printer, and then go to <http://h20141.www2.hp.com/hpparts> to order the part.

Right rear cover part number	
RC4-0178-000CN	Right rear cover

Required tools

- #2 Phillips screwdriver with a magnetic tip

After performing service

Make sure that the USB cover is fully seated after replacing it.

Make sure that the TCU is fully closed after replacing it.

Make sure that the formatter cover is fully seated, and that the thumbscrews are finger tight after replacing it.

Make sure that the output bin is flat against the chassis after replacing it.

Turn the printer power on

- Connect the power cable.
- Use the power switch to turn the power on.

Step 1: Remove the USB cover

1. Locate the USB cover.

Figure 1-837 Locate the USB cover



2. Pull the cover off of the printer to remove it.

Figure 1-838 Remove the cover



Step 2: Remove the control panel (M553x only)

 **NOTE:** For the M553n/dn and M552dn models, skip this step and go to [Step 3: Remove the toner collection unit \(TCU\) on page 497](#).

1. Tilt the control panel up.

Figure 1-839 Tilt the control panel up



2. Use a small flat-blade screwdriver to release the control-panel screws cover tabs.

Figure 1-840 Release the control-panel screws cover tabs



3. Rotate the cover up to remove it.

Figure 1-841 Remove the cover



4. Use a small Phillips screwdriver to remove two screws (callout 1).

 **IMPORTANT:** Store the screws in a secure place where they cannot fall down into the printer.

Figure 1-842 Remove two screws



5. Rotate the control-panel base toward the front of the printer.

Figure 1-843 Rotate the control-panel base up

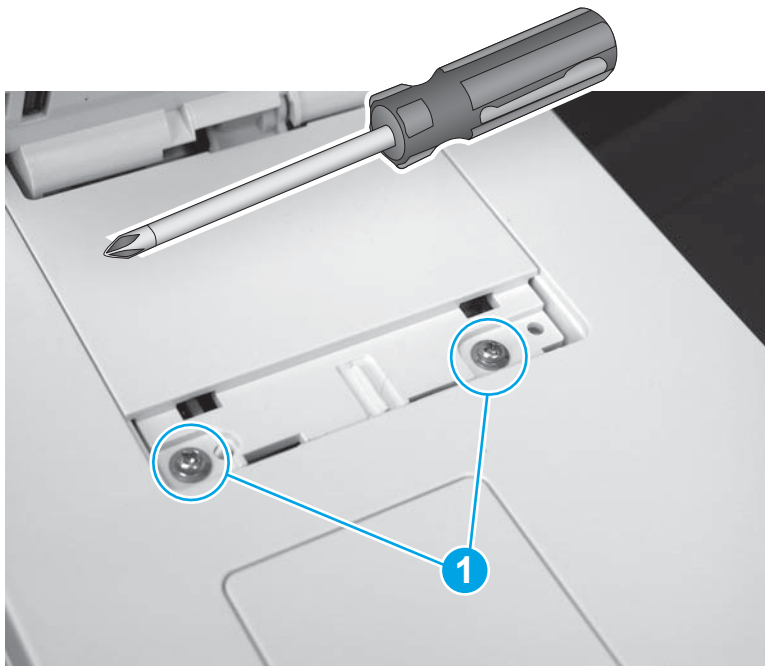

6. Slightly slide the control-panel base toward the rear of the printer (callout 1) to release it, and then turn the control panel over (callout 2) to access the bottom side.

CAUTION: The control panel is still attached to the printer. Do not attempt to completely remove the control panel.

Figure 1-844 Turn the control panel over

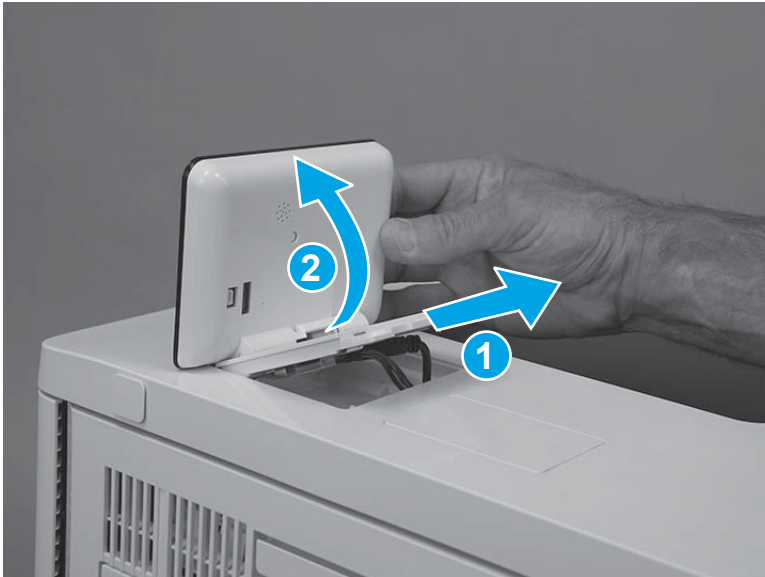

7. Disconnect one USB cable (callout 1), one connector (callout 2), and then remove the control panel.

Figure 1-845 Disconnect two connectors

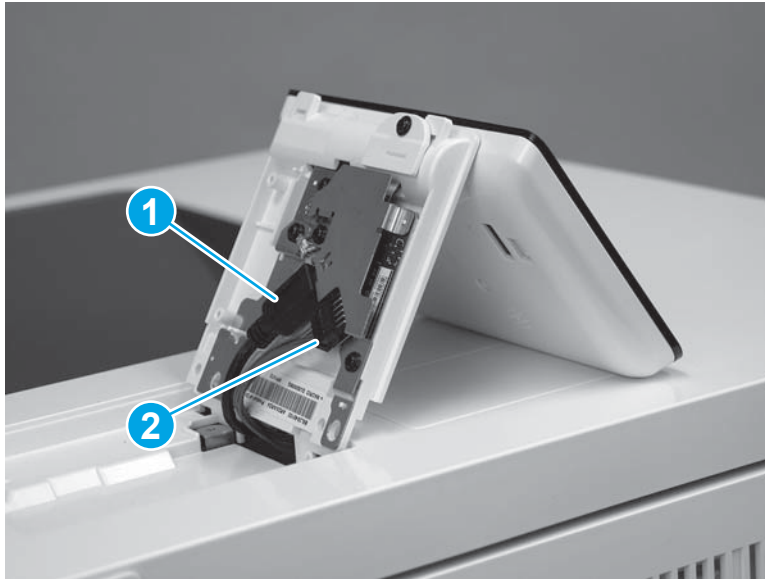

Step 3: Remove the toner collection unit (TCU)

1. Open the front door.

Figure 1-846 Open the front door



2. Open the TCU.

 **NOTE:** The toner collection hatch cover automatically closes when the TCU is opened.

Figure 1-847 Open the TCU



3. Pull the TCU away from the printer at an angle to remove it.

⚠ CAUTION: Do not open the toner collection hatch cover when handling the TCU. If toner gets on clothing, wipe it off by using a dry cloth and wash the clothes in cold water. Hot water sets toner into fabric.

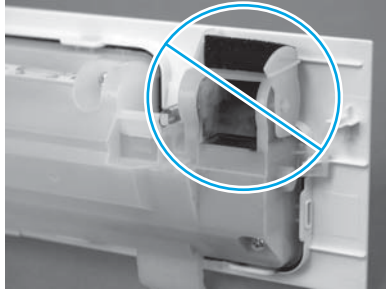
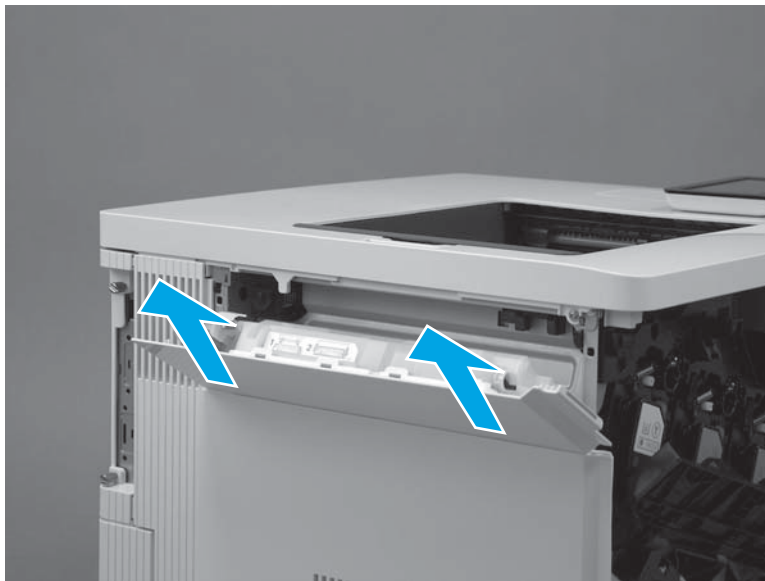

Figure 1-848 Remove the TCU



Step 4: Remove the formatter cover

1. Locate the formatter cover.

Figure 1-849 Locate the formatter cover

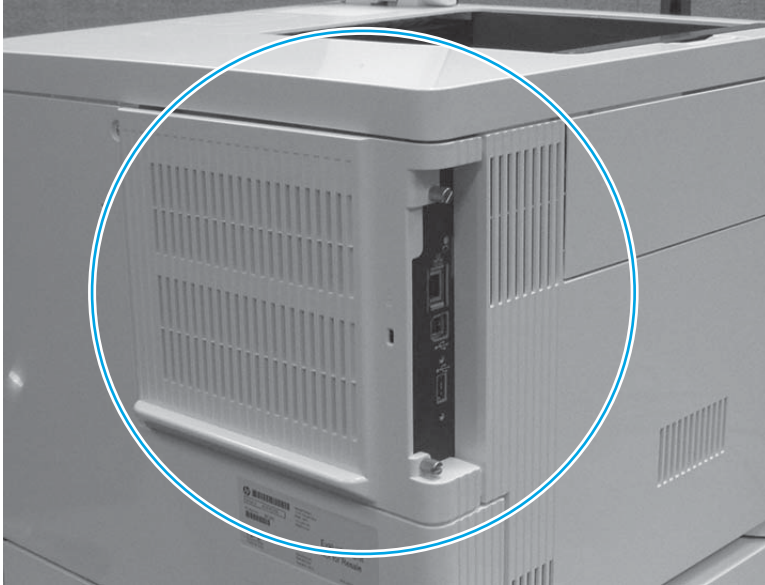

2. Loosen the two thumbscrews (callout 1). Grasp the two thumbscrews, and then slide the cover away from the printer (callout 2) to remove it.

 **TIP:** If needed, use the edge of a coin to turn the thumbscrews.

Figure 1-850 Loosen the thumbscrews



Step 5: Remove the rear cover

1. Remove four screws (callout 1).

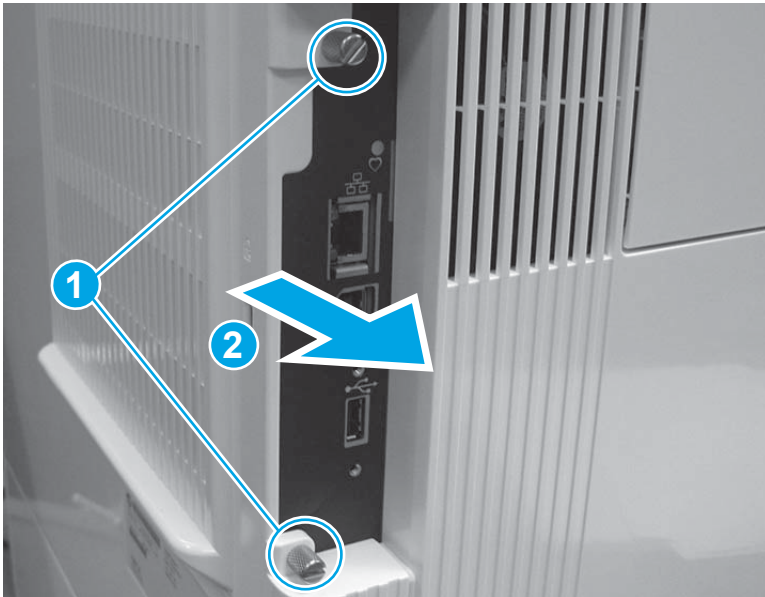
Figure 1-851 Remove four screws

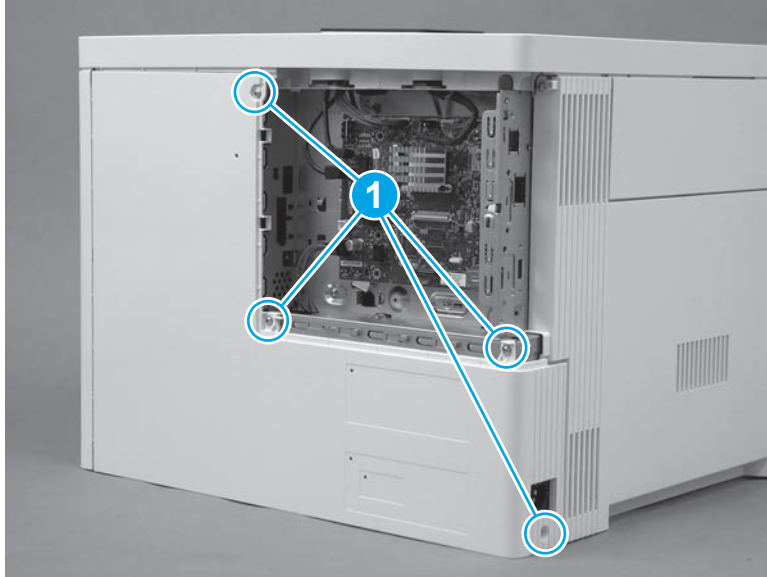

2. Slightly slide the cover to the right (callout 1), rotate the bottom of the cover away from the printer (callout 2), and then pull the top of the cover away from the printer (callout 3) to remove the cover.

Figure 1-852 Remove the cover

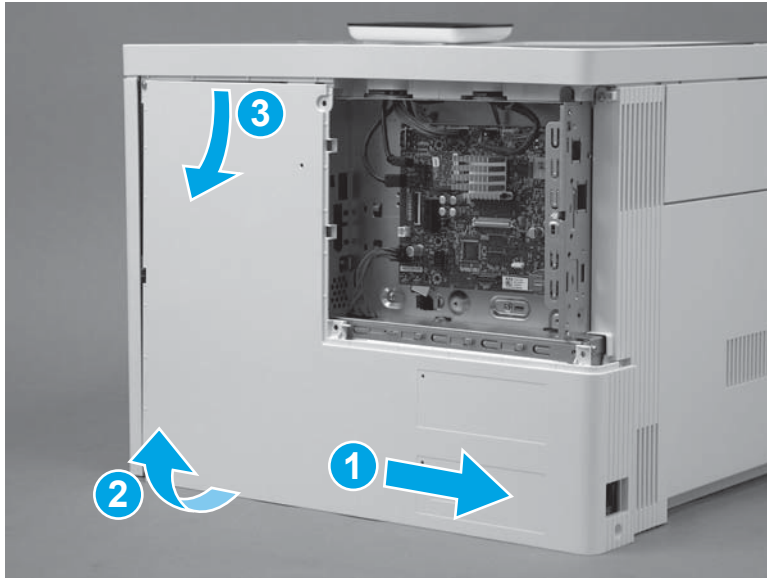

Step 6: Remove the left cover

1. At the left side of the printer, remove one screw (callout 1).

Figure 1-853 Remove one screw



2. Release one tab (callout 1), rotate the front edge of the cover away from the printer (callout 2), and then slide the cover (callout 3) toward the rear of the printer to release it.

Figure 1-854 Release the cover

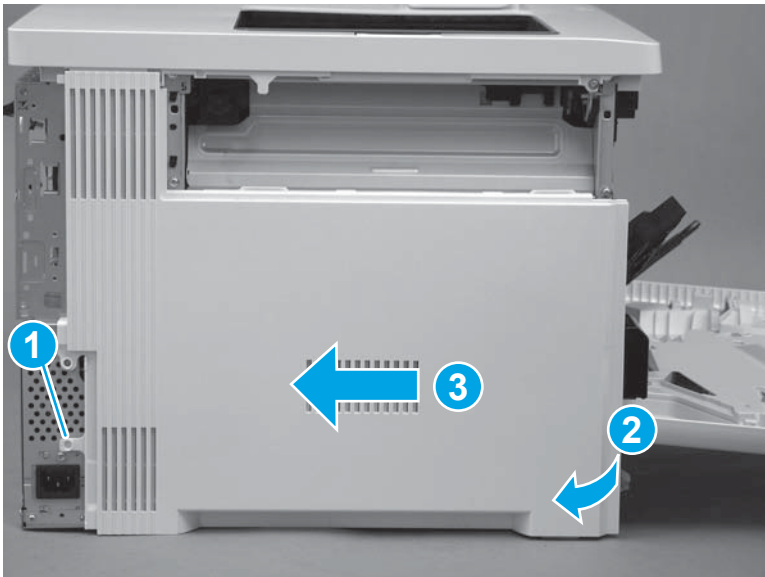

3. Remove the cover.

Figure 1-855 Remove the cover

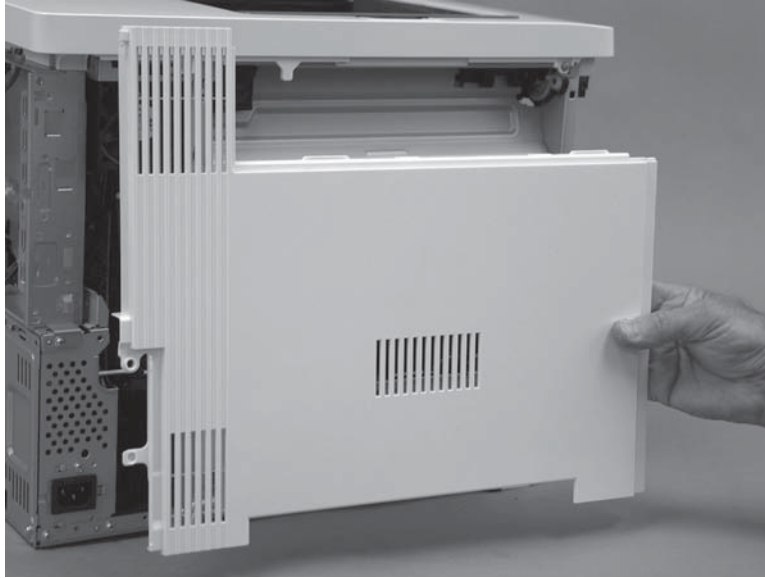

Step 7: Remove the upper cover

1. Remove three screws (callout 1).

Figure 1-856 Remove three screws

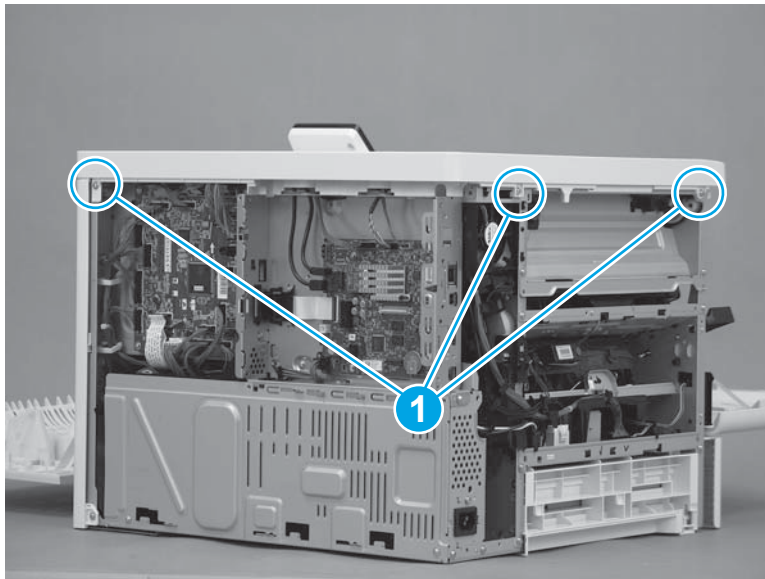

2. Remove one screw (callout 1), release one tab (callout 2), and then slightly separate the corner of the cover from the chassis.

 **NOTE:** This is a self-tapping plastic-thread screw. Make sure that this screw is used in this location when it is reinstalled.

Figure 1-857 Remove one screw and release one tab



3. Release one tab (callout 1), and then lift up on the cover to release it.

 **NOTE:** If the cover does not release, check for additional tabs by locating the triangles embossed in the cover at tab locations.

Figure 1-858 Release the cover



4. Remove the cover.

Figure 1-859 Remove the cover

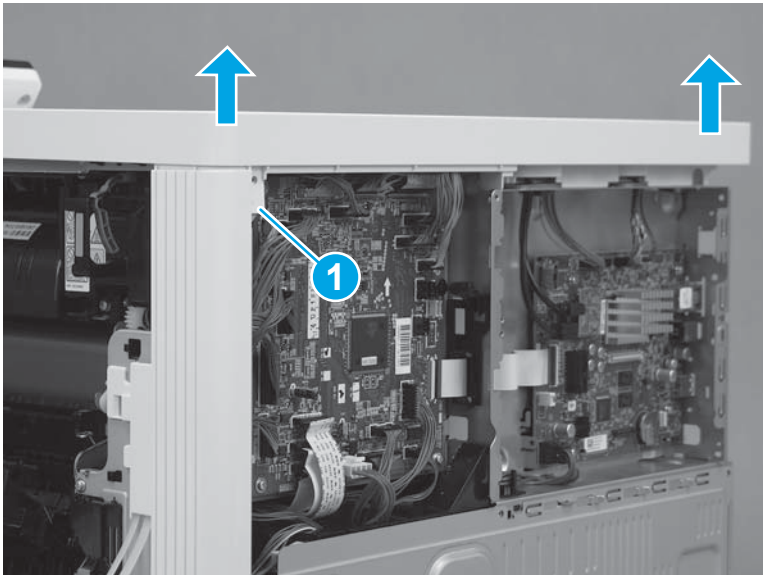
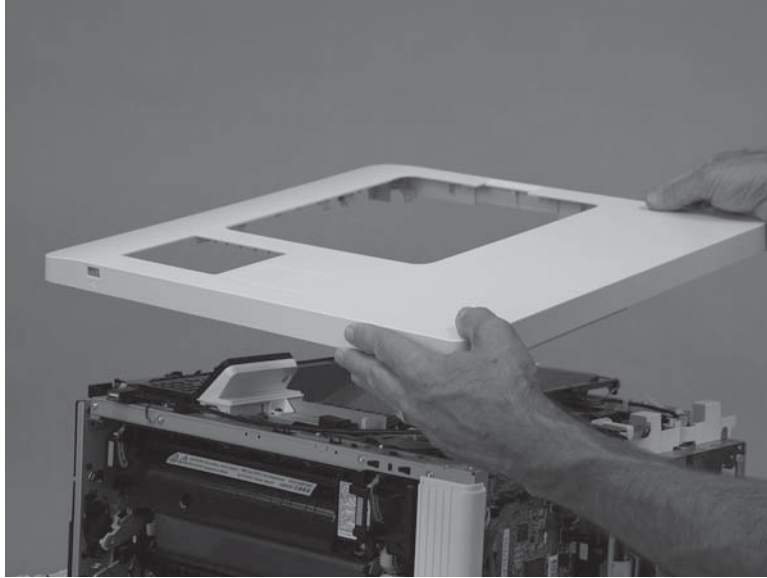

Step 8: Remove the right rear cover

1. Remove one screw (callout 1), and then slide the cover toward the rear of the printer (callout 2) to release it.

 **TIP:** If the right door is closed, open it now.

Figure 1-860 Release the cover

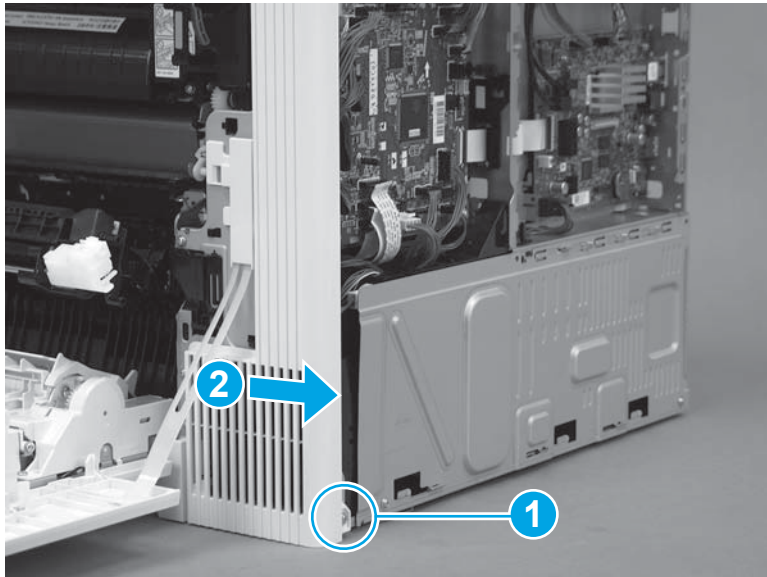

2. Remove the cover.

Figure 1-861 Remove the cover

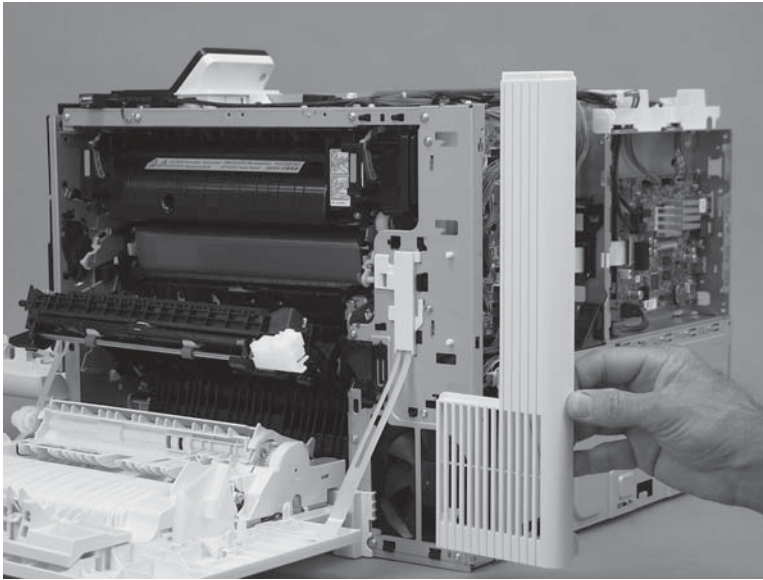

Step 9: Unpack the replacement assembly

Unpack the replacement assembly from the packaging.

For complete information on HP's recycling programs, go to [Product return and recycling](#).

 **NOTE:** HP recommends responsible disposal of the defective assembly.

Figure 1-862 Recycle and unpack

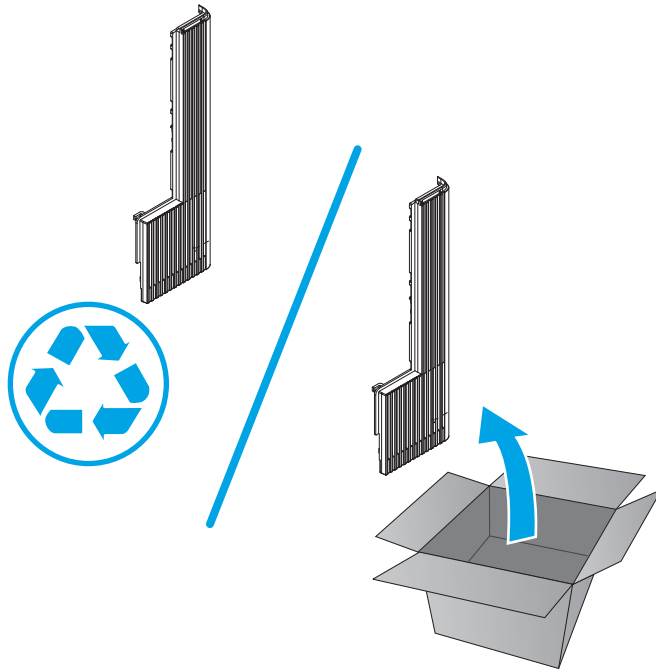

Step 10: Install the right rear cover

1. Position the cover on the printer.

Figure 1-863 Install the cover

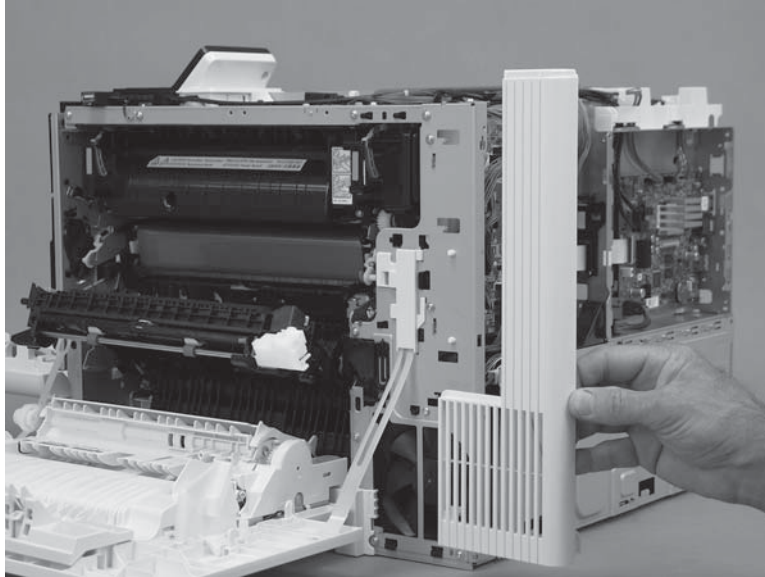

2. Slide the cover toward the right door (callout 1) to engage it with the printer, and then install one screw (callout 2).

Figure 1-864 Install one screw

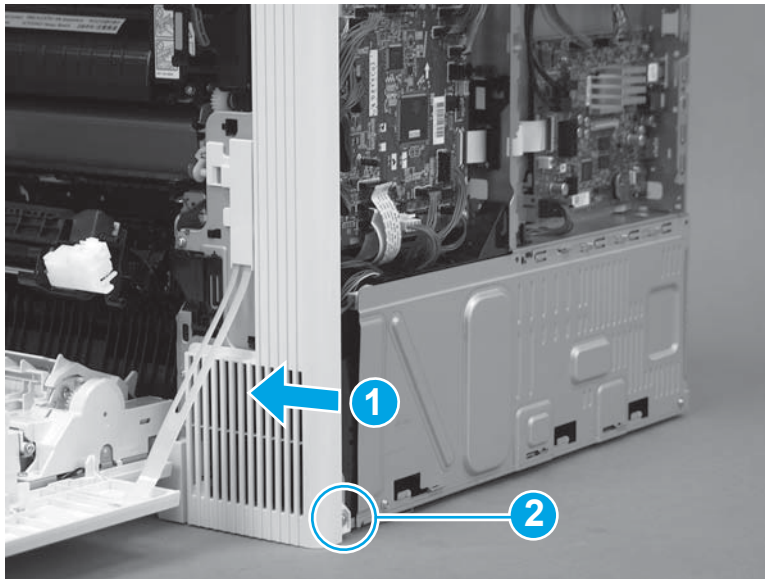

Step 11: Install the upper cover

1. Position the cover on the printer.

 **NOTE:** For the M553x model, do not forget to pass the control-panel wire harness and USB cable through the opening in the cover.

Figure 1-865 Install the cover



2. Push down on the rear corner of the cover to engage one tab (callout 1).

Figure 1-866 Engage one tab

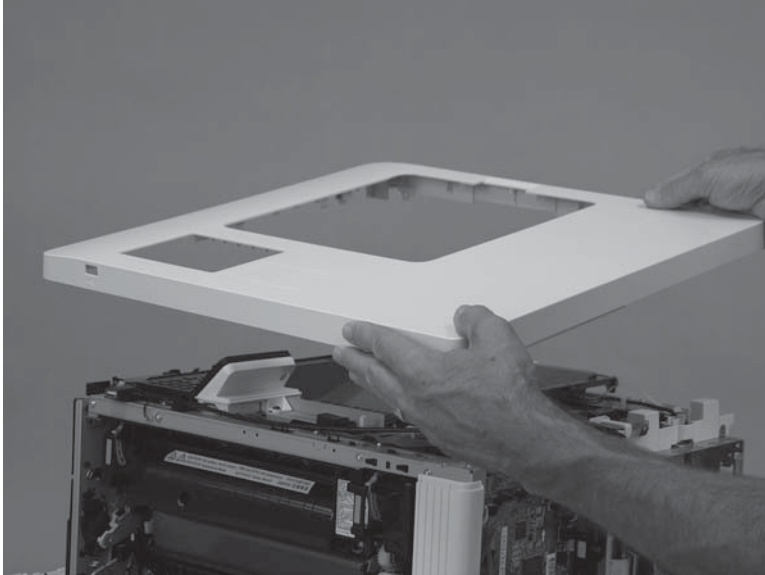
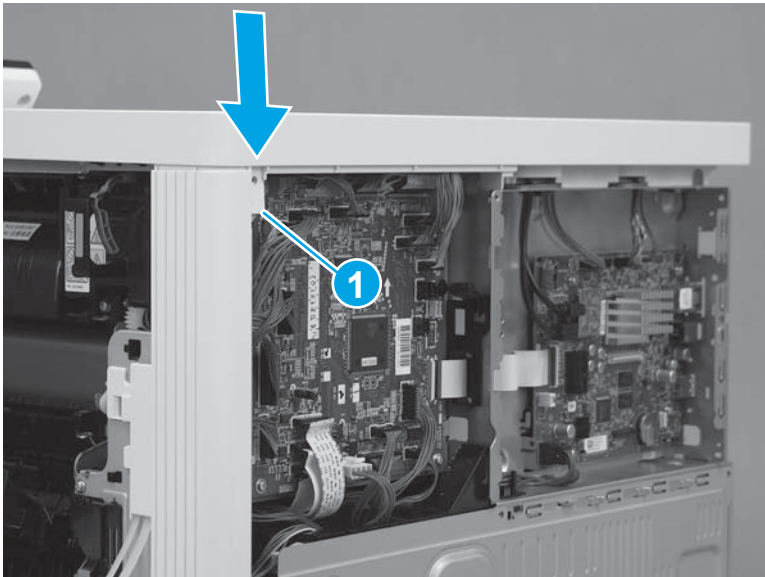

3. Push down on the front corner of the cover to engage one tab (callout 1), and then install one screw (callout 2).

 **NOTE:** This is a self-tapping plastic-thread screw. Make sure that this screw is used in this location when it is reinstalled.

Figure 1-867 Engage one tab and install one screw



4. Install three screws (callout 1).

Figure 1-868 Install three screws

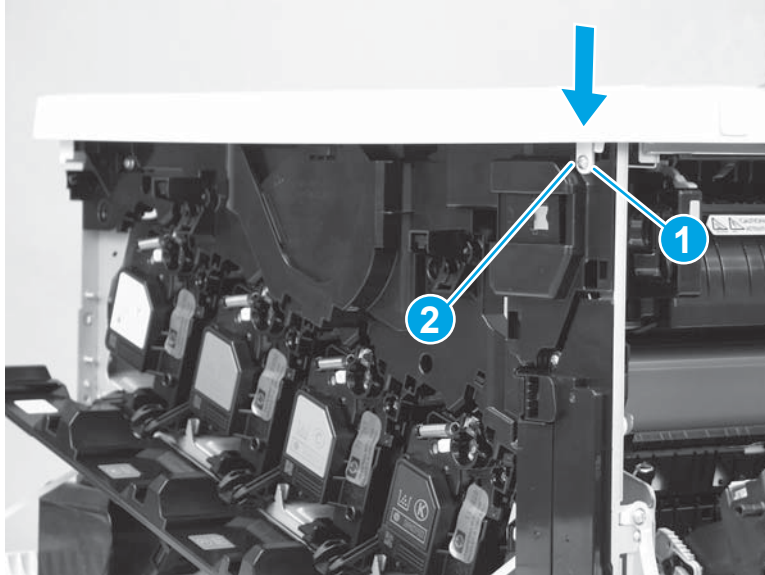
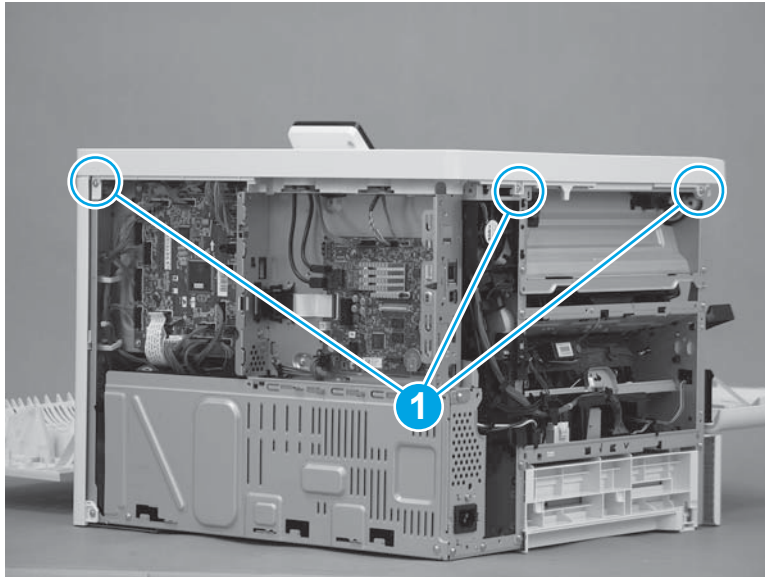

Step 12: Install the left cover

1. Position the cover on the printer.

 **NOTE:** Slightly offset the cover toward the rear of the printer.

Figure 1-869 Install the cover

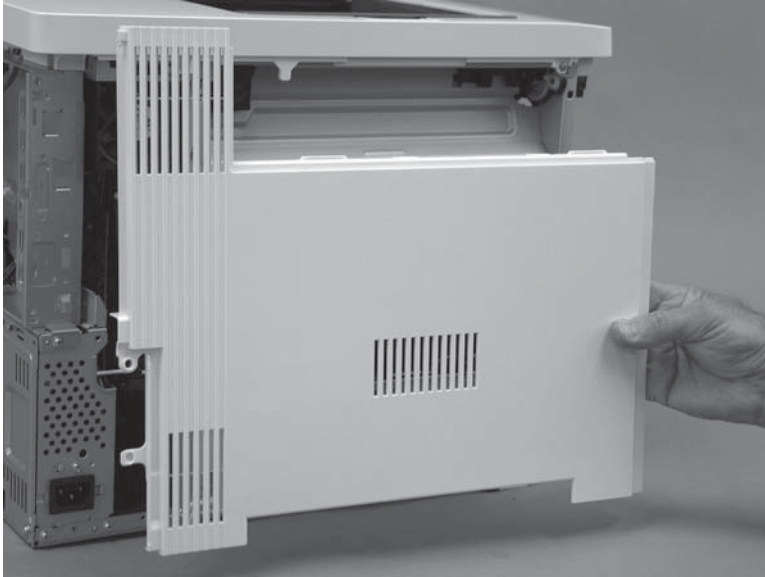

2. Slide the cover (callout 1) toward the front of the printer to engage it. Make sure that the tab (callout 2) snaps into place.

 **NOTE:** Locate the alignment pin (callout 3) on the cover from the front door side of the printer, and then make sure that it is fully engaged in the slot in the chassis.

 **TIP:** While sliding the cover into place, push in on the center of the cover (callout 1) to make sure that the hooks on the back of the cover engage with the slots in the chassis.

Figure 1-870 Engage the cover



3. At the left side of the printer, install one screw (callout 1).

Figure 1-871 Install one screw

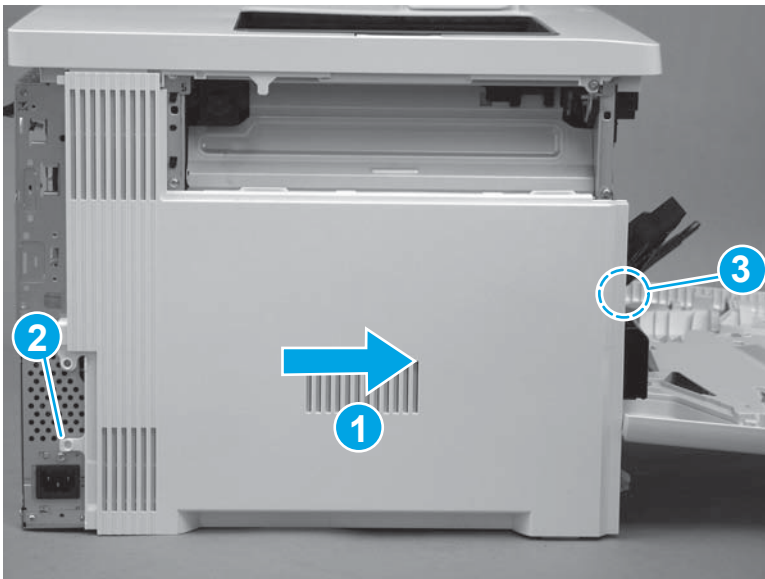

Step 13: Install the rear cover

1. Position the top of the cover under the upper cover (callout 1), rotate the bottom of the cover onto the chassis (callout 2), and then slide the cover to the left (callout 3) to install it.

Figure 1-872 Install the cover

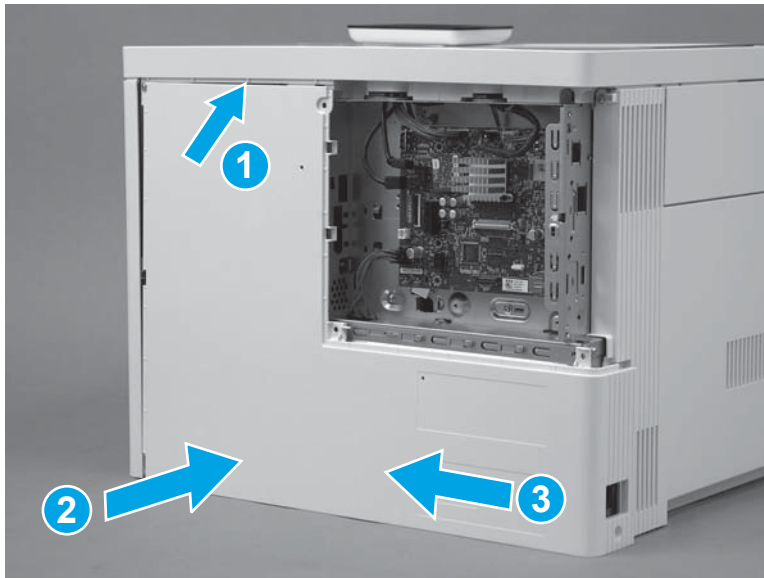

2. Install four screws (callout 1).

Figure 1-873 Install four screws cover

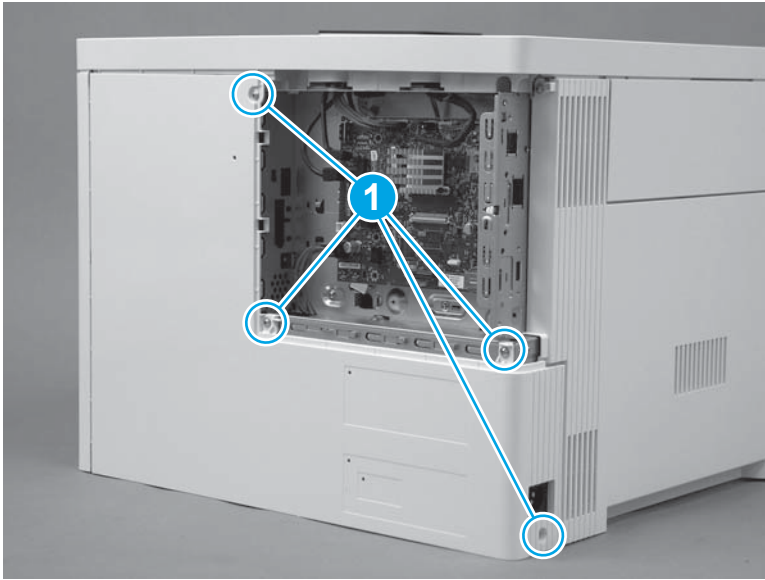

Step 14: Install the formatter cover

- ▲ Slide the cover onto the printer (callout 1) to install it.

 **NOTE:** Make sure that the tabs on the formatter cover align with the slots provided in the printer (callout 2). Tighten the two thumbscrews (callout 3).

 **TIP:** If needed, use the edge of a coin to turn the thumbscrews.

Figure 1-874 Install the cover



Step 15: Install the TCU

1. Verify that the toner collection hatch cover is in the closed position on the TCU.

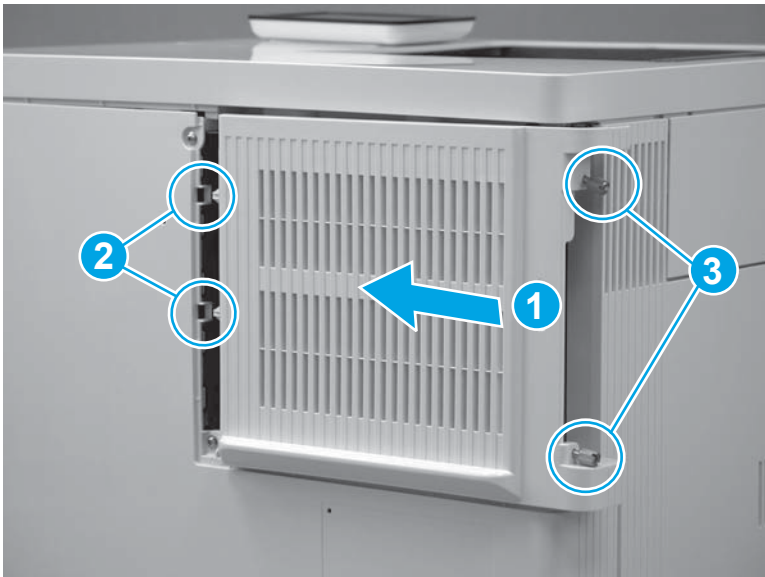
Figure 1-875 Verify that the toner collection hatch cover is closed

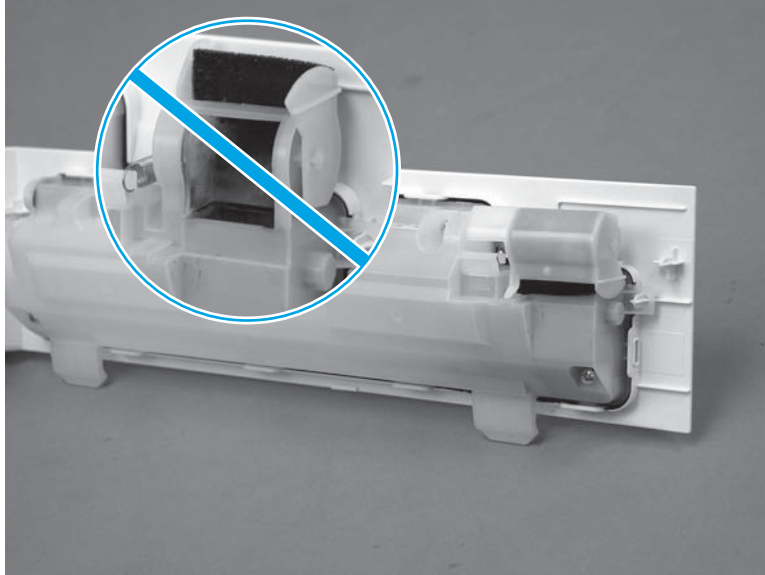

2. Position the TCU with the hinges in the slots provided in the printer (callout 1), and then rotate the TCU up and into the closed position.

 **NOTE:** The toner collection hatch cover automatically opens when the TCU is closed.

Figure 1-876 Install the TCU



3. Close the front door.

Figure 1-877 Close the front door

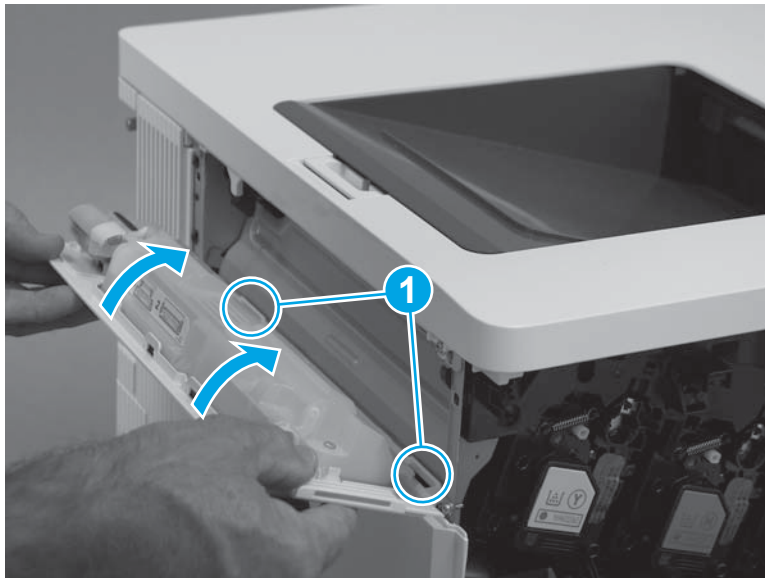

Step 16: Install the control-panel assembly (M553x only)



NOTE: For the M553n/dn and M552dn models, skip this step and go to [Step 17: Install the USB cover on page 517](#).

1. Place the control panel on the printer as shown.

Figure 1-878 Place the control panel on the product

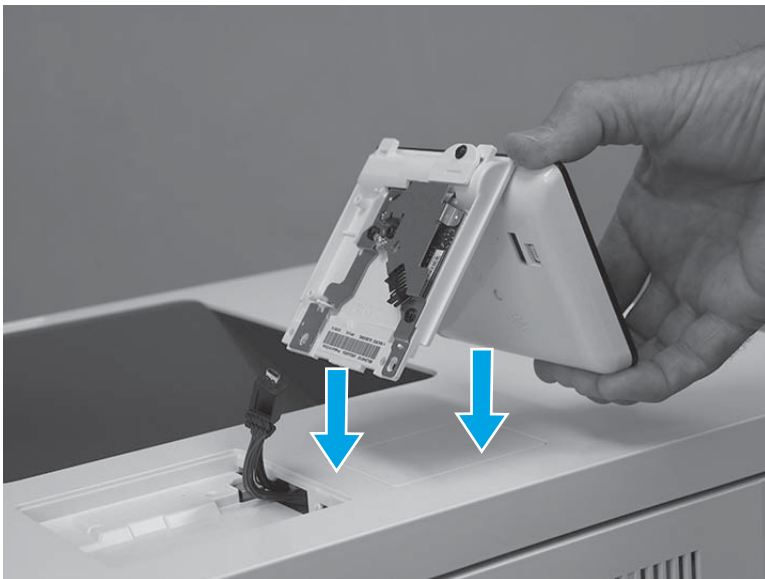

2. Connect one USB cable (callout 1), and one connector (callout 2).

 **IMPORTANT:** Take note of the location of the two mounting tabs (callout 3) on the control-panel assembly.

Figure 1-879 Connect two connectors



3. Turn the control panel over, and then position the front edge tabs in the slots in the top cover.

Figure 1-880 Turn the control panel over

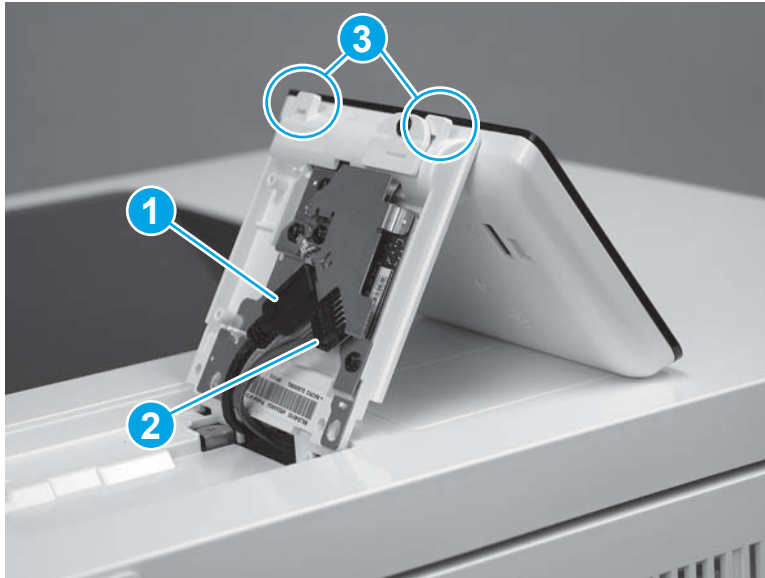
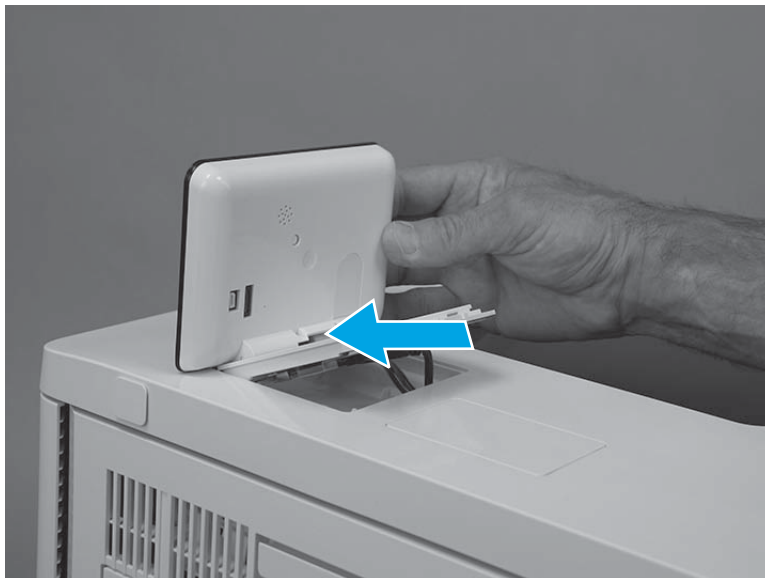

4. Rotate the control-panel base down onto the printer.

Figure 1-881 Rotate the control-panel base down



5. Use a small Phillips screwdriver to install two screws (callout 1).

Figure 1-882 Install two screws

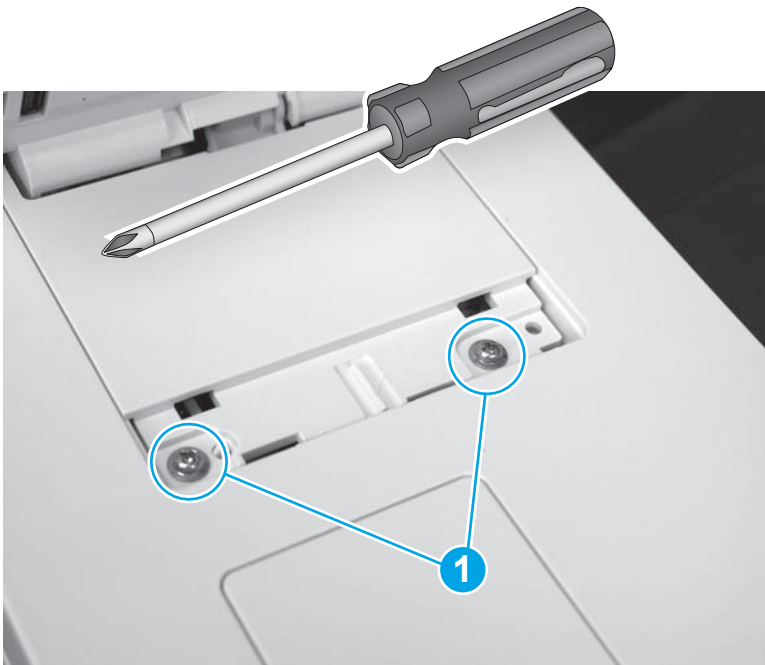

6. Position the screw cover mounting feet into the slots in the top cover (callout 1), and then rotate the cover down (callout 2) to install it.

 **NOTE:** Press down on the cover firmly to make sure that the tabs on the cover (callout 3) snap into place.

Figure 1-883 Install the cover



Step 17: Install the USB cover

1. Push the cover into the USB port to install it.

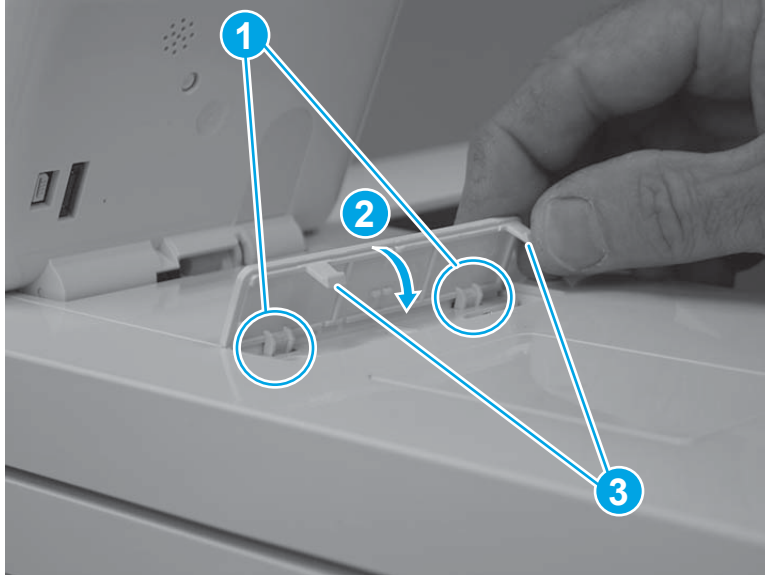
Figure 1-884 Install the cover



2. Make sure that the USB cover is fully seated after installing it.

Figure 1-885 Check the installation

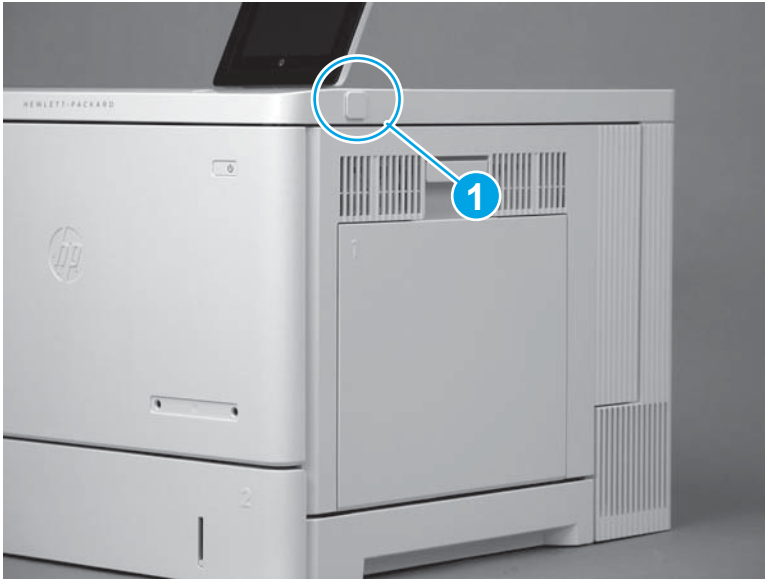

Removal and replacement: Right rear cover (M577)

- [Introduction](#)
- [Step 1: Remove the formatter cover](#)
- [Step 2: Remove the rear upper cover \(M577\)](#)
- [Step 3: Remove the right front upper cover \(M577dn\)](#)
- [Step 4: Remove the stapler cover assembly \(M577c/f/z\)](#)
- [Step 5: Remove the right upper cover \(M577\)](#)
- [Step 6: Remove the rear cover \(M577\)](#)
- [Step 7: Remove the right rear cover](#)
- [Step 9: Unpack the replacement assembly](#)
- [Step 9: Install the right rear cover](#)
- [Step 10: Install the rear cover \(M577\)](#)
- [Step 11: Install the right upper cover \(M577\)](#)
- [Step 12: Install the stapler cover assembly \(M577c/f/z\)](#)
- [Step 13: Install the right front upper cover \(M577dn\)](#)
- [Step 14: Install the rear upper cover \(M577\)](#)
- [Step 15: Install the formatter cover](#)

Introduction

This document provides the procedures to remove and replace the right rear cover on the M577.

Before performing service

Turn the printer power off

- Disconnect the power cable.

⚠ WARNING! To avoid damage to the printer, turn the printer off, wait 30 seconds, and then remove the power cord before attempting to service the printer.

- Open the right door.

Use the table below to identify the correct part number for your printer, and then go to <http://h20141.www2.hp.com/hpparts> to order the part.

Right rear cover part number	
RC4-0178-000CN	Right rear cover

Required tools

- #2 Phillips screwdriver with a magnetic tip

After performing service

Make sure that the right rear cover is fully seated after replacing it.

Make sure that the formatter cover is fully seated, and that the thumbscrews are finger tight after replacing it.

Turn the printer power on

- Connect the power cable.
- Use the power switch to turn the power on.

Step 1: Remove the formatter cover

1. Locate the formatter cover.

Figure 1-886 Locate the formatter cover

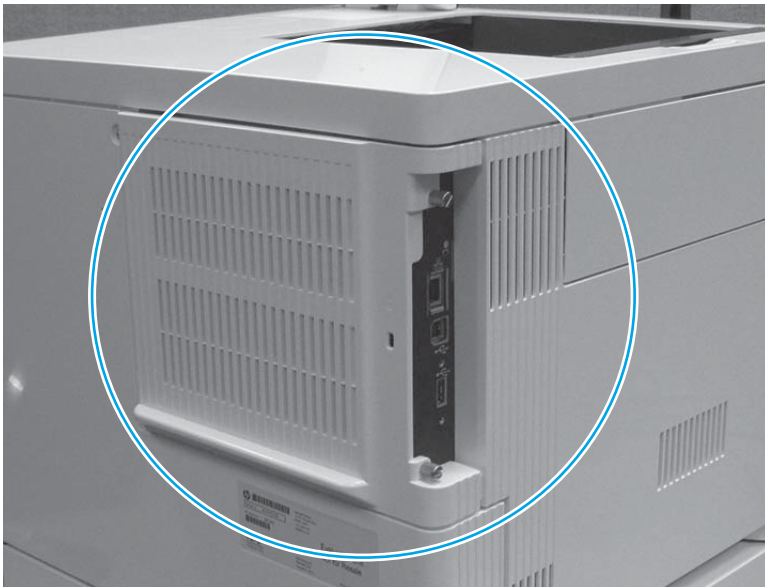

2. Loosen the two thumbscrews (callout 1). Grasp the two thumbscrews, and then slide the cover away from the printer (callout 2) to remove it.

 **TIP:** If needed, use the edge of a coin to turn the thumbscrews.

Figure 1-887 Loosen the thumbscrews



Step 2: Remove the rear upper cover (M577)

1. Remove two screws (callout 1).

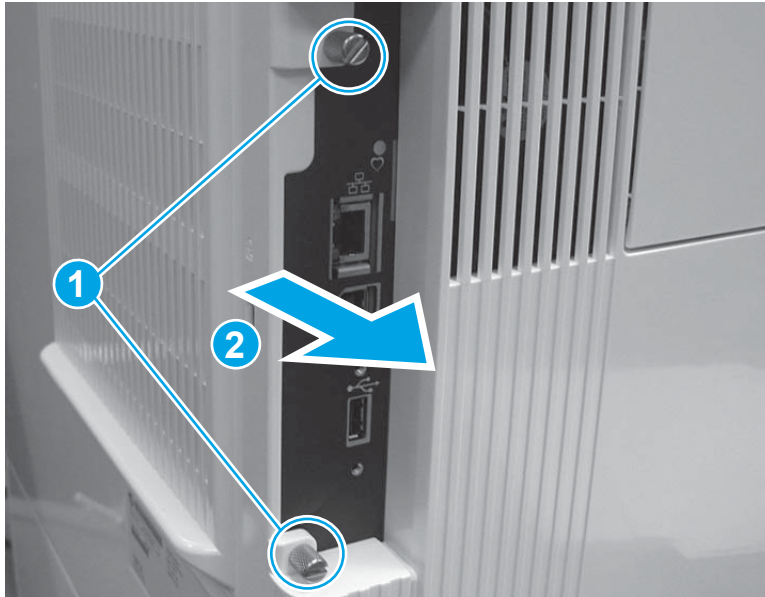
 **Reinstallation tip:** These two screws are self-tapping screws for plastic. When reinstalling them, rotate the screws counterclockwise to align them with the existing thread pattern, and then carefully turn them clockwise to tighten. Do not overtighten. This will prevent stripping the threads inside the screw holes.

Figure 1-888 Remove two screws



2. Use a small, flat blade screwdriver to release the right edge of the cover.

Figure 1-889 Release the right edge

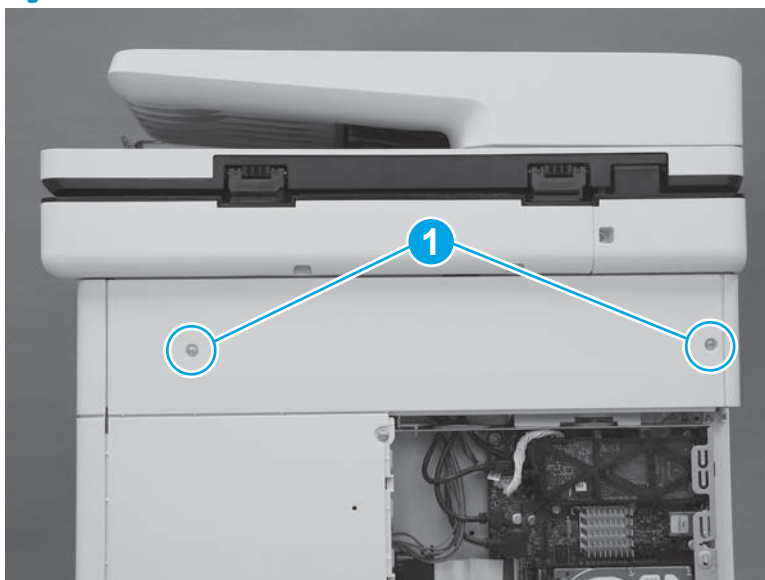
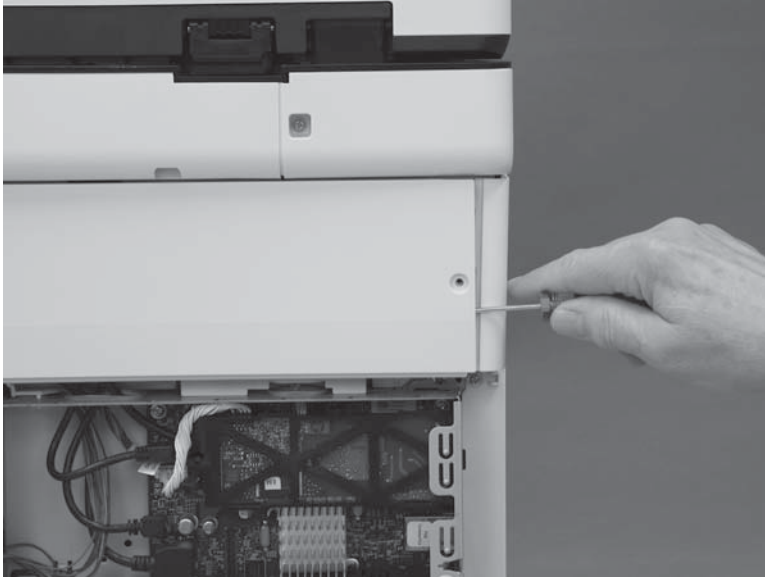

3. Pull the right edge of the cover (callout 1) away from the printer, and then slide the cover to the right (callout 2).

Figure 1-890 Slide the cover right

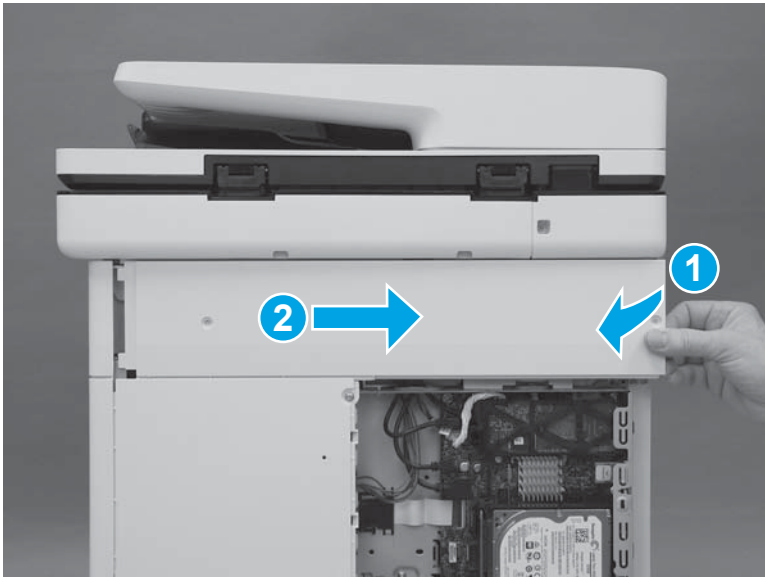

4. Remove the cover.

Figure 1-891 Remove the cover

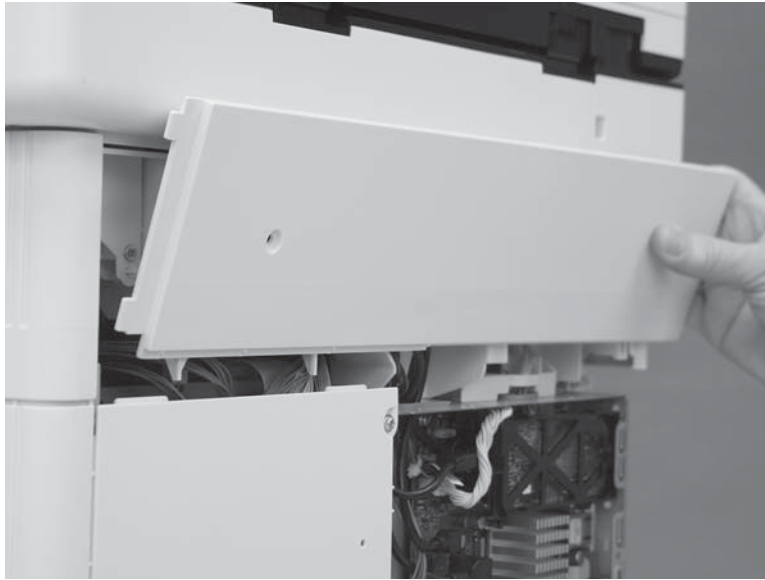

Step 3: Remove the right front upper cover (M577dn)

 **NOTE:** This step is for the M577dn model. For the M577c/f/z models, skip this step and to go [Step 4: Remove the stapler cover assembly \(M577c/f/z\) on page 524](#).

1. Remove one screw (callout 1).

Figure 1-892 Remove one screw

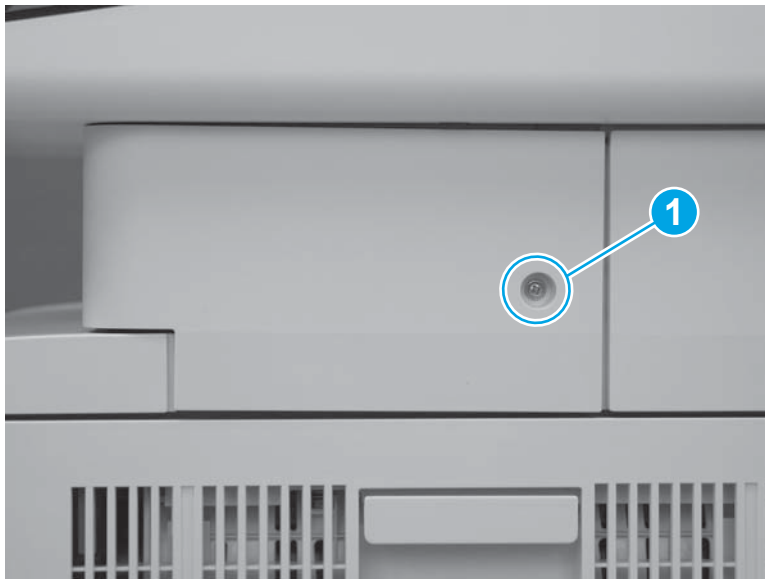

2. Release two tabs at the front edge of the cover (callout 1).

Figure 1-893 Release two tabs



3. Rotate the front of the cover to the right to remove it.

Figure 1-894 Rotate the cover



Step 4: Remove the stapler cover assembly (M577c/f/z)

 **NOTE:** This step is for the M577c/f/z models. For the M577dn model, skip this step and to go [Step 5: Remove the right upper cover \(M577\) on page 526.](#)

1. Remove one screw (callout 1).

 **Reinstallation tip:** This is a self-tapping screw for plastic. When reinstalling, rotate the screw counterclockwise to align it with the existing thread pattern, and then carefully turn it clockwise to tighten. Do not overtighten. This will prevent stripping the threads inside the screw hole.

Figure 1-895 Remove one screw



2. Release two tabs at the front edge of the cover (callout 1).

Figure 1-896 Release two tabs

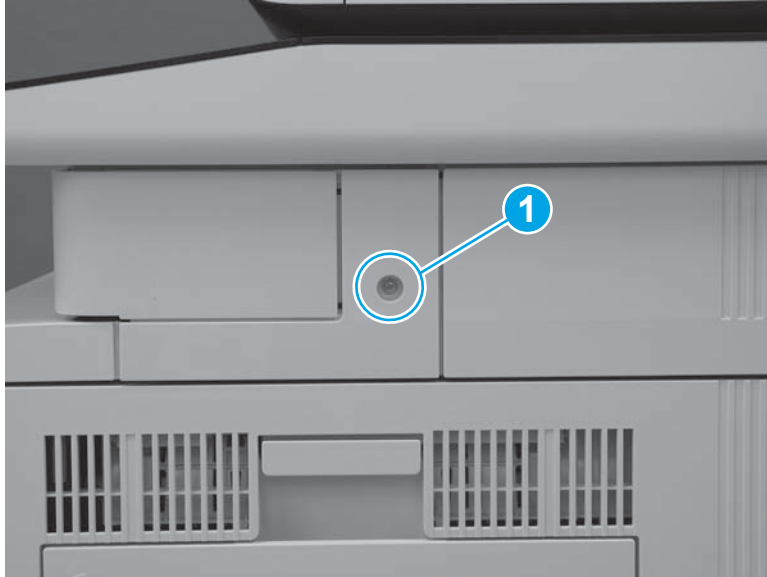

3. Release the back edge of the cover.

Figure 1-897 Release the back edge of the cover

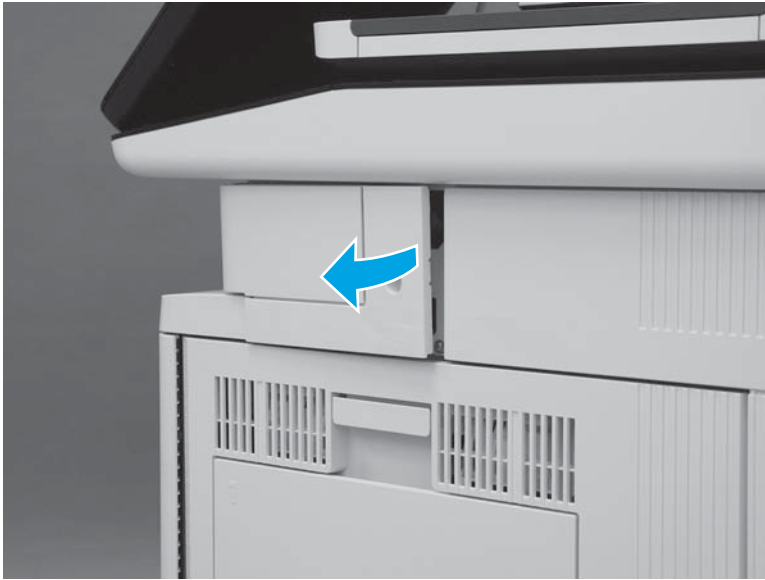

4. Rotate the cover away from the printer to remove it.

Figure 1-898 Remove the cover



Step 5: Remove the right upper cover (M577)

 **NOTE:** The figures below show the image scanner installed. The procedures for removing and installing the right upper cover are the same whether the image scanner is installed or removed."

1. At the right side of the printer, remove two screws (callout 1).

M577c/f/z only: Disconnect one connector (callout 2), if it was not already disconnected in a previous step.

Figure 1-899 Remove two screws and one connector

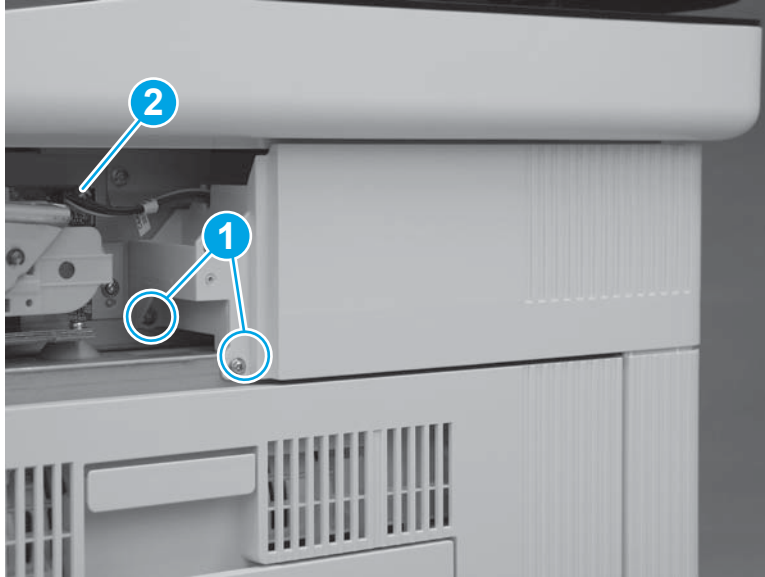

2. At the back of the printer, remove one screw (callout 1).

M577c/f/z only: Disconnect one connector (callout 2), if it was not already disconnected in a previous step.

 **Reinstallation tip:** This screw is smaller than the screws removed in the previous step. When reinstalling the right upper cover, make sure that this screw is installed in the correct position.

Figure 1-900 Remove one screw and connector



3. Slide the cover toward the back of the printer.

Figure 1-901 Slide the cover

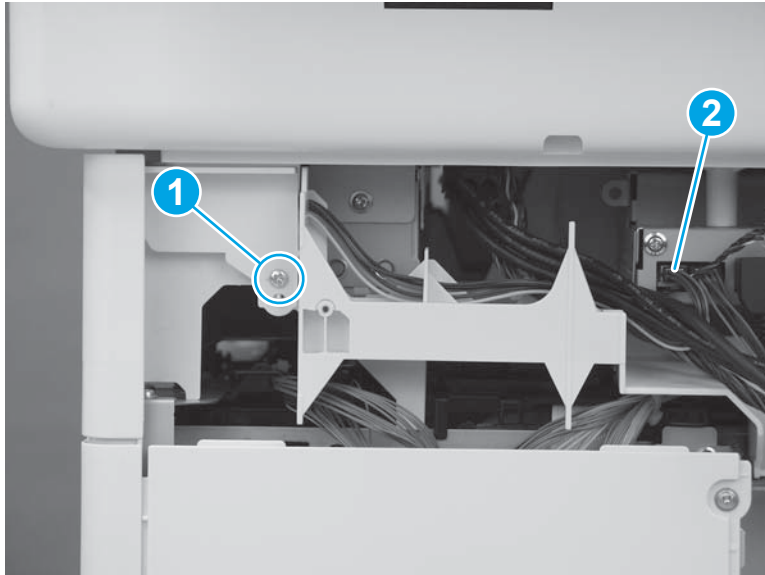
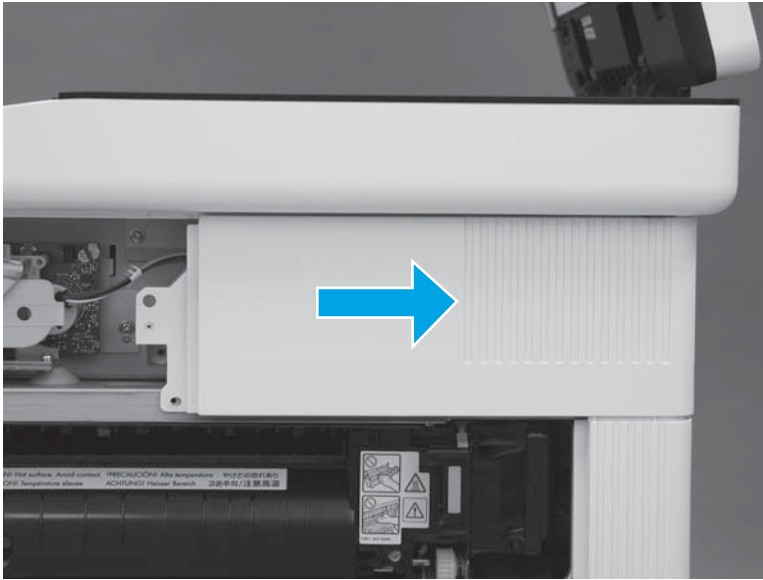

4. Lift the cover away from the printer to remove it.

M577c/f/z only: Release the cables (callout 1) through the slot (callout 2) in the printer.

Figure 1-902 Remove the cover

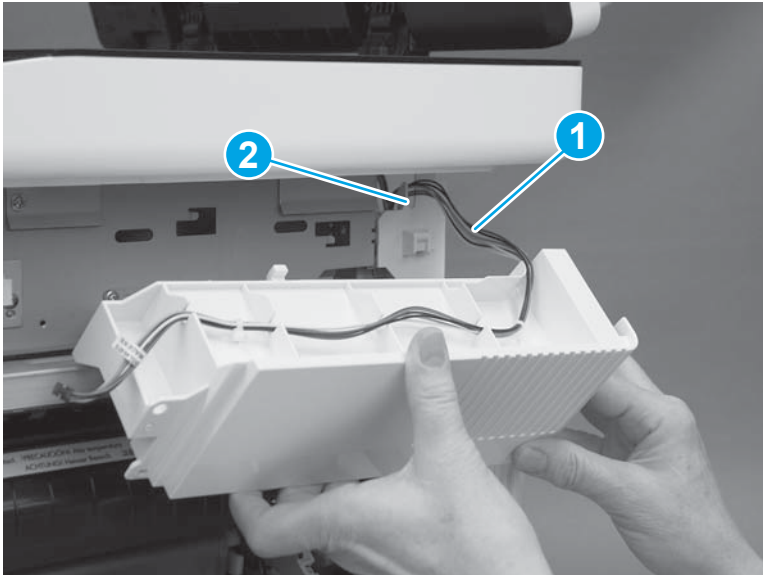

Step 6: Remove the rear cover (M577)

1. Remove four screws (callout 1).

Figure 1-903 Remove four screws

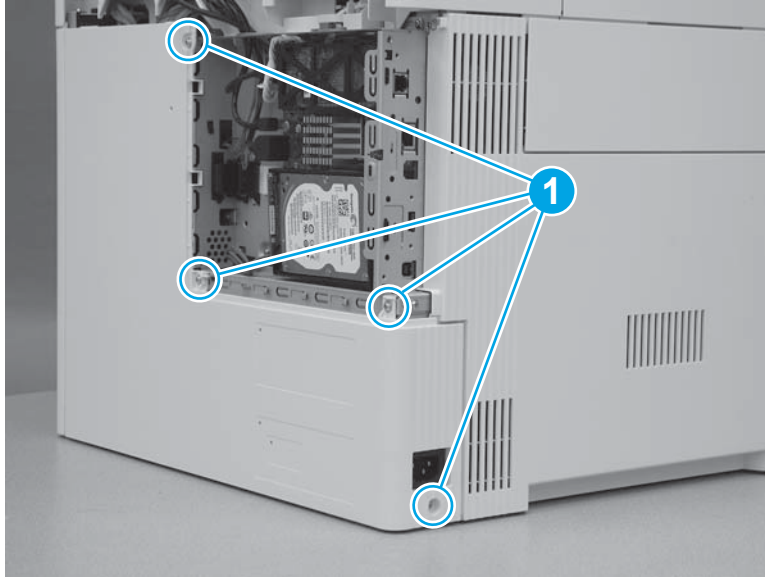

2. Slide the cover to the right to remove it.

Figure 1-904 Remove the cover

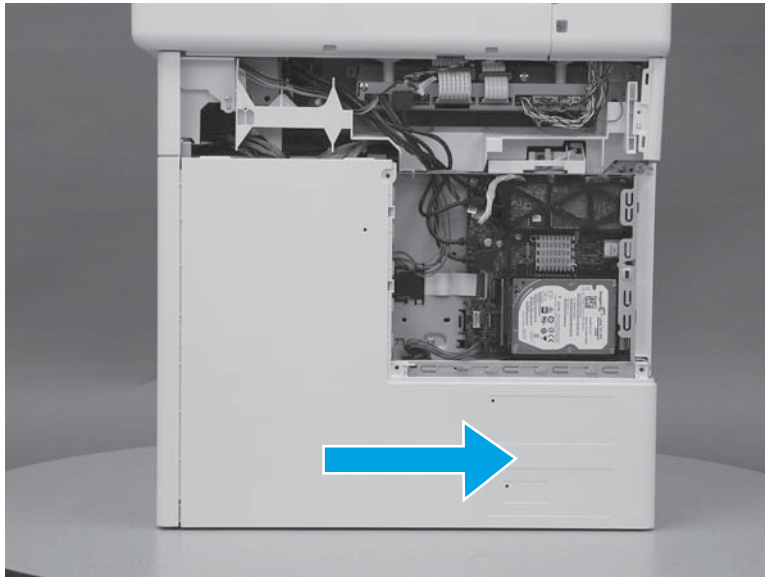

Step 7: Remove the right rear cover

1. Remove one screw (callout 1), and then slide the cover toward the rear of the printer (callout 2) to release it.

 **TIP:** If the right door is closed, open it now.

Figure 1-905 Release the cover

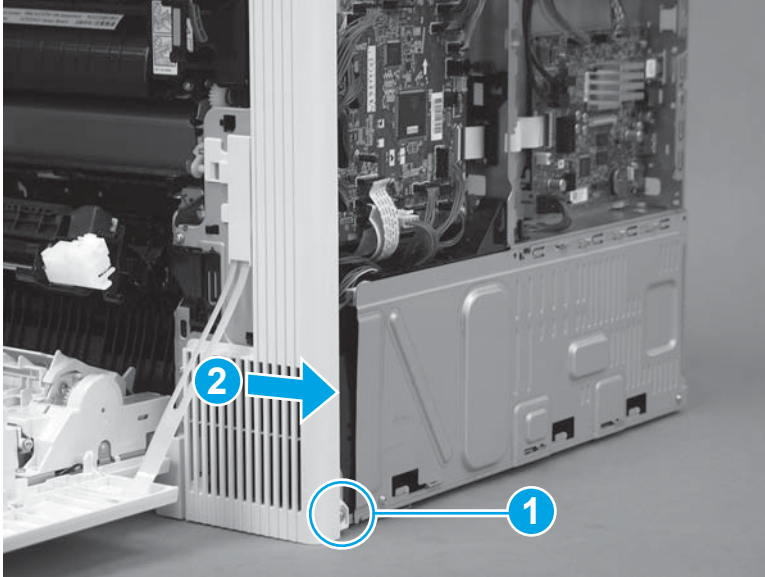

2. Remove the cover.

Figure 1-906 Remove the cover

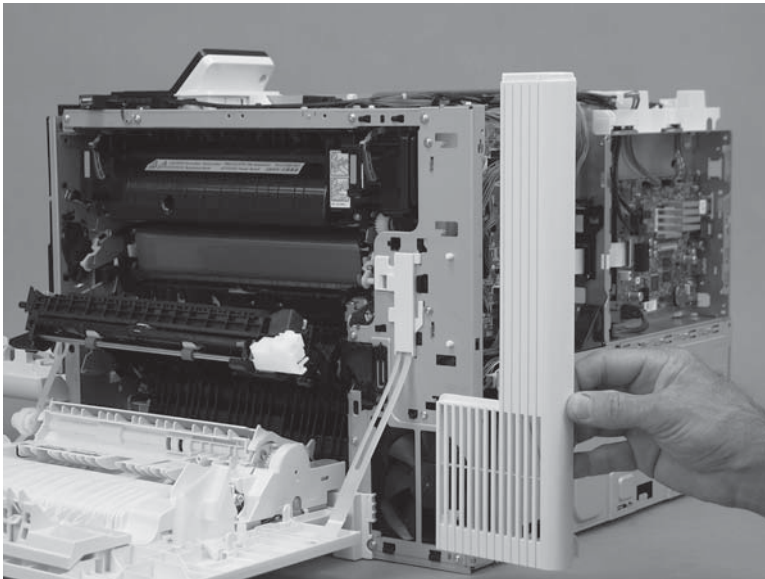

Step 9: Unpack the replacement assembly

Unpack the replacement assembly from the packaging.

For complete information on HP's recycling programs, go to [Product return and recycling](#).

 **NOTE:** HP recommends responsible disposal of the defective assembly.

Figure 1-907 Recycle and unpack

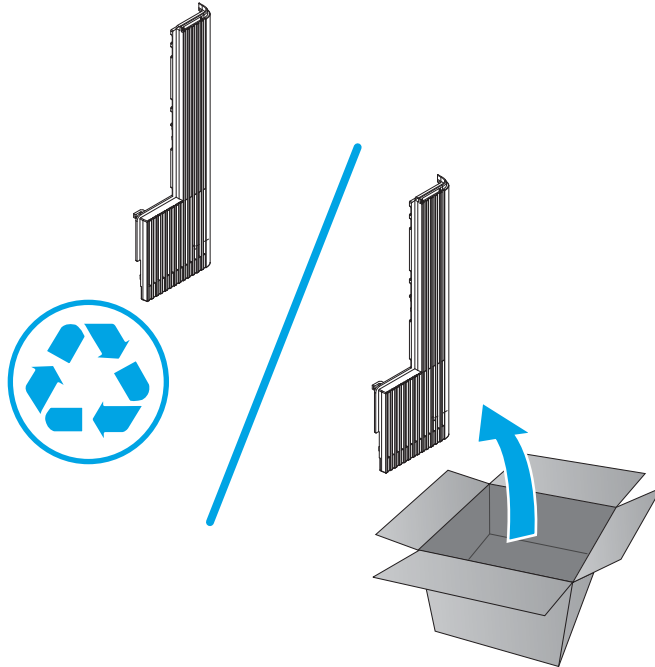

Step 9: Install the right rear cover

1. Position the cover on the printer.

Figure 1-908 Install the cover

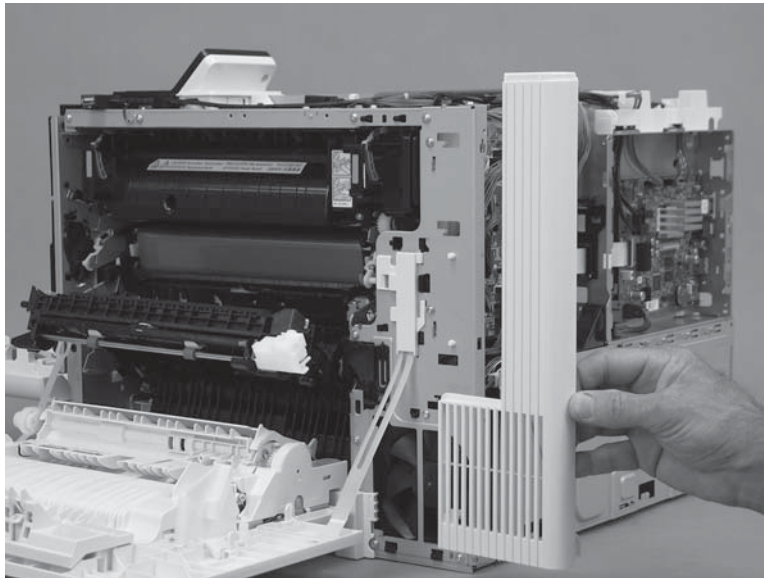

2. Slide the cover toward the right door (callout 1) to engage it with the printer, and then install one screw (callout 2).

Figure 1-909 Install one screw

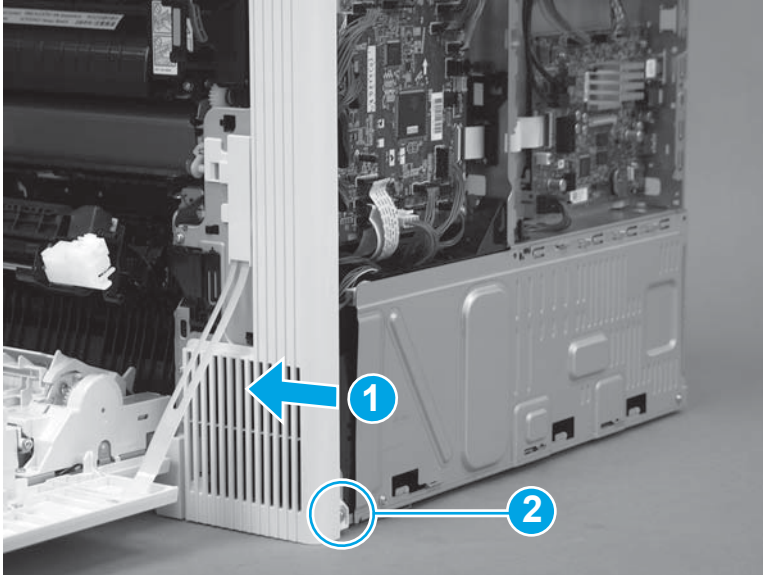

Step 10: Install the rear cover (M577)

1. Position the hooks (callout 1) on the cover in the slots (callout 2) in the printer.

Figure 1-910 Position the hooks

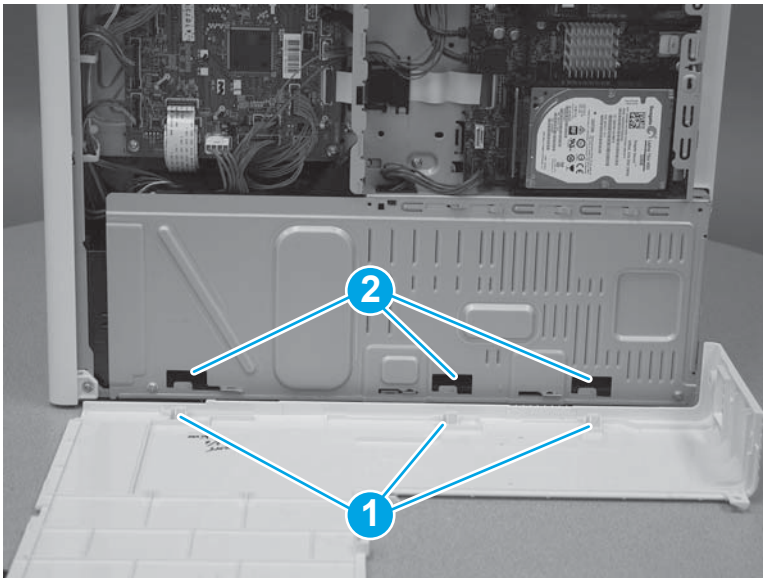

2. Position the back edge (callout 1) of the rear cover behind the edge (callout 2) of the right rear cover. Slide the cover to the left to install it.

Figure 1-911 Install the cover

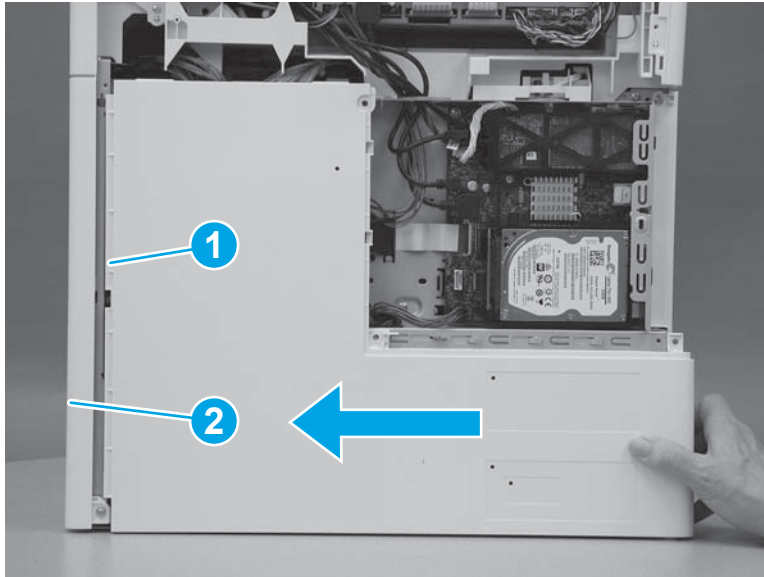

3. Install four screws (callout 1).

Figure 1-912 Install four screws cover

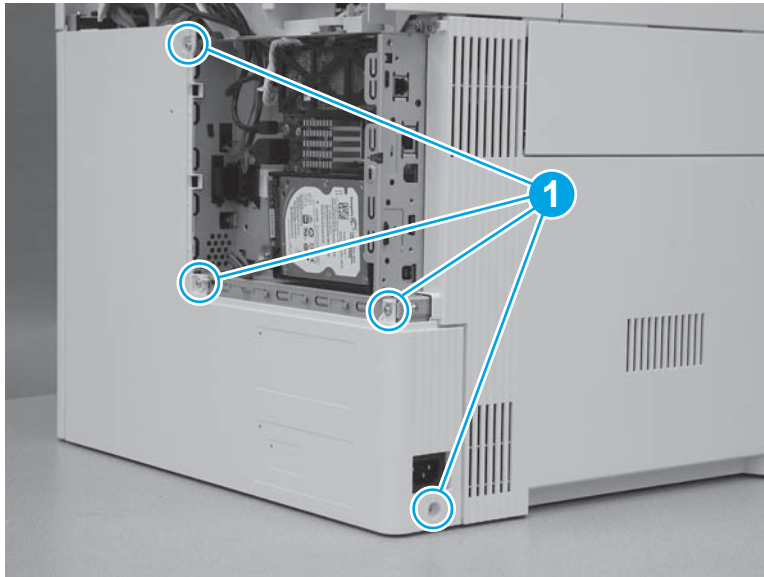

Step 11: Install the right upper cover (M577)

 **NOTE:** The figures below show the image scanner installed. The procedures for removing and installing the right upper cover are the same whether the image scanner is installed or removed."

1. **M577c/f/z only:** Install the cables (callout 1) through the slot (callout 2) in the printer.

Figure 1-913 Install the cables

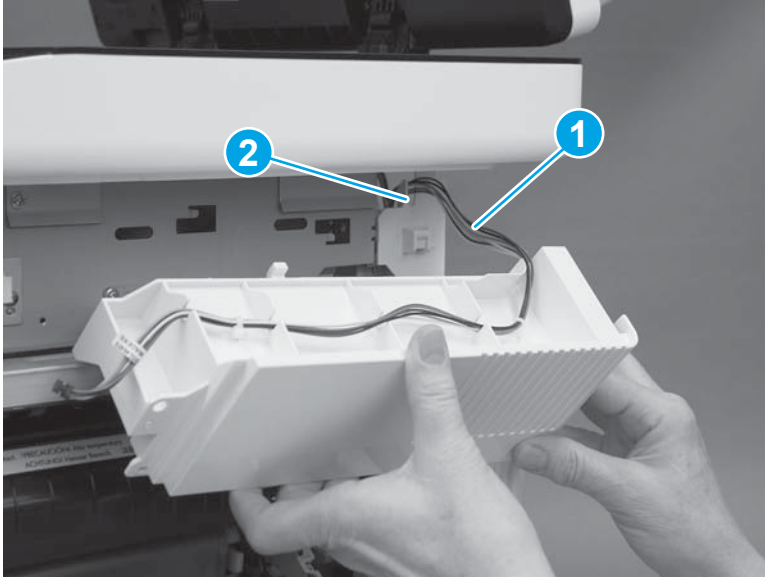

2. Position the hooks (callout 1) on the cover in the slots (callout 2) in the printer.

Figure 1-914 Position the hooks

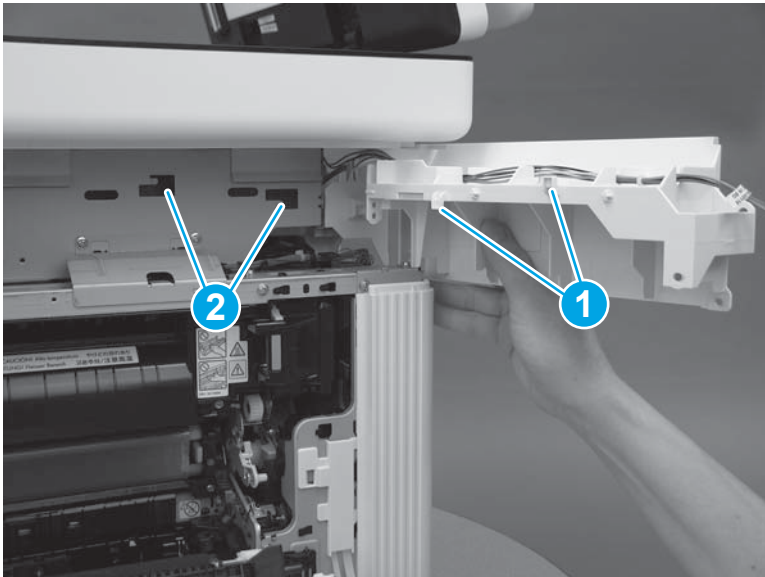

3. Slide the cover toward the front of the printer to install it.

Figure 1-915 Install the cover

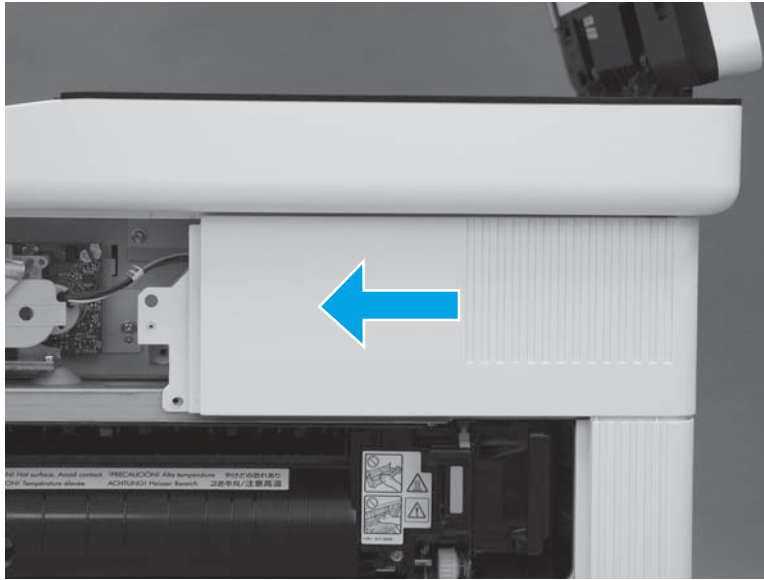

4. At the back of the printer, install one screw (callout 1).

M577c/f/z only: Connect one connector (callout 2), if the integrated scanner assembly is installed.

 **TIP:** This screw is smaller than the screws installed in the next step. Make sure that this screw is installed in the correct position.

Figure 1-916 Install one screw and connector

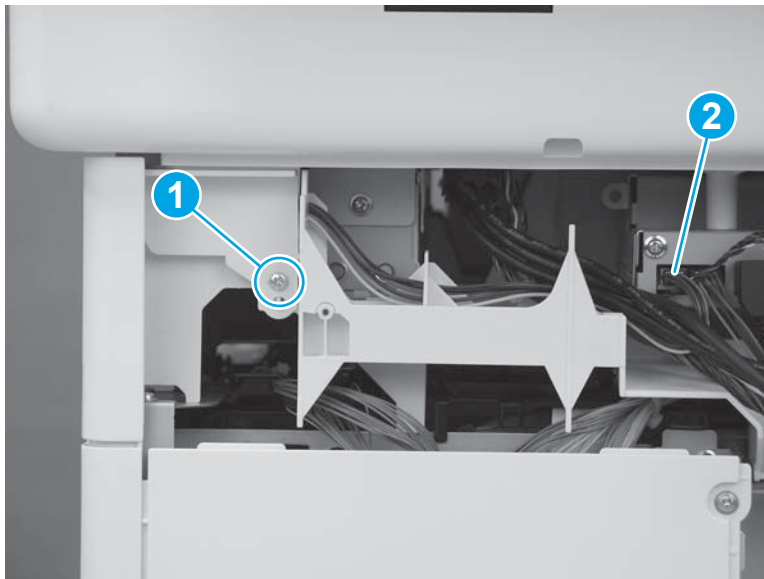

5. At the right side of the printer, install two screws (callout 1).
M577c/f/z only: Connect one connector (callout 2), if the stapler is installed.

Figure 1-917 Install one screw and connector

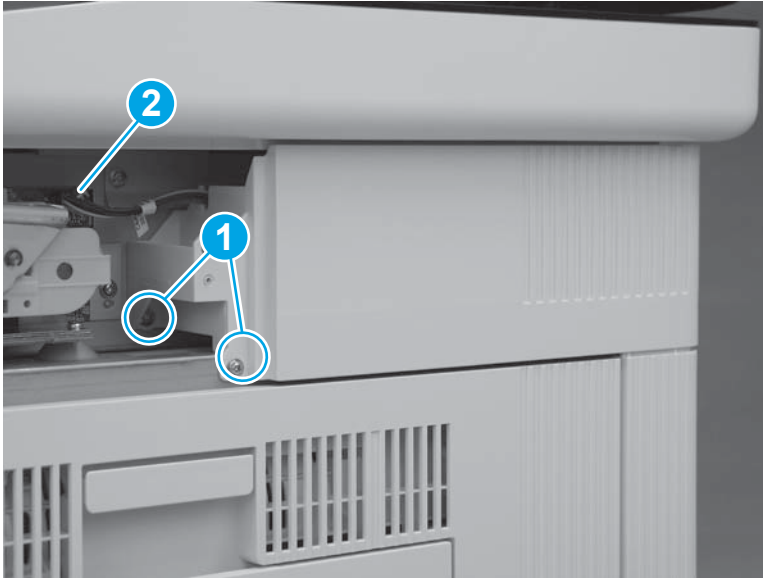

Step 12: Install the stapler cover assembly (M577c/f/z)

 **NOTE:** This step is for the M577c/f/z models only. For the M577dn model, skip this step and go to [Step 13: Install the right front upper cover \(M577dn\) on page 537.](#)

1. Install the tabs (callout 1) on the cover in the slots (callout 2) in the printer.

Figure 1-918 Install two tabs



2. Press the cover toward the left side of the printer until it snaps into place.

Figure 1-919 Install the cover assembly



3. Install one screw (callout 1).



 **IMPORTANT:** This is a self-tapping screw for plastic. Rotate it counterclockwise to align it with the existing thread pattern, and then carefully turn it clockwise to tighten. Do not overtighten. This will prevent stripping the threads inside the screw hole.

Figure 1-920 Install one screw

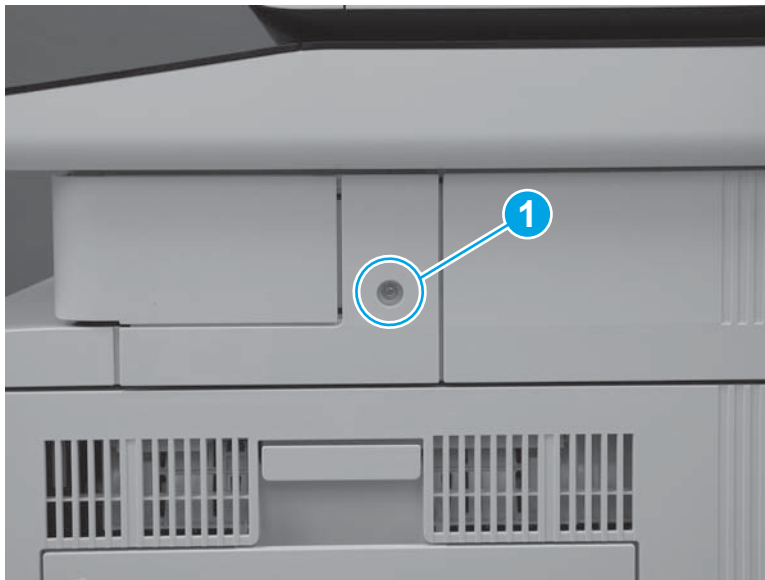

Step 13: Install the right front upper cover (M577dn)

 **NOTE:** This step is for the M577dn model only. For the M577c/f/z models, skip this step and go to [Step 14: Install the rear upper cover \(M577\) on page 539.](#)

1. Slide the cover toward the left side of the printer to install it. Make sure that the slots (callout 1) in the cover fit over the tabs (callout 2) on the inside of the paper feeder cover.

Figure 1-921 Install the cover



2. Press the right front upper cover (callout 1) and the paper feeder cover (callout 2) together until the tabs on the inside of the covers snap into place.

Figure 1-922 Press the cover



3. Install one screw (callout 1).

Figure 1-923 Install one screw

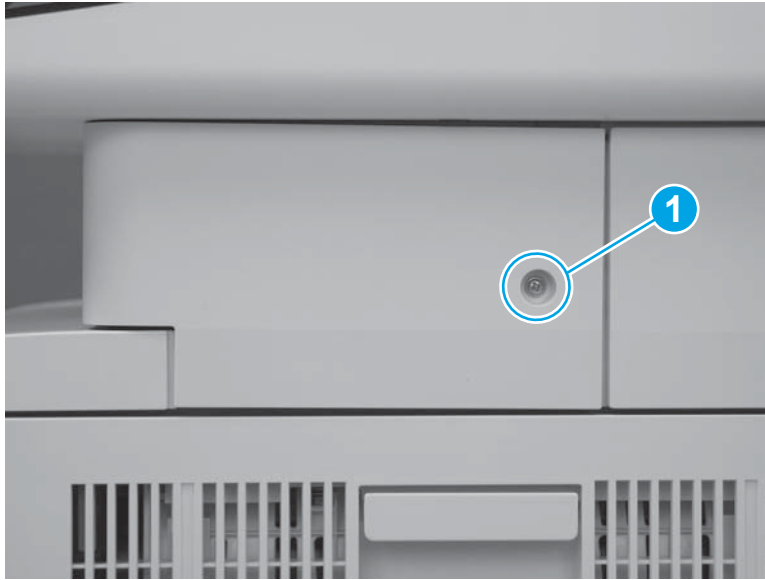

Step 14: Install the rear upper cover (M577)

1. Align the ridge (callout 1) on the lower edge of the rear upper cover in front of the tabs (callout 2) on the top edge of the rear cover.

Figure 1-924 Align the cover

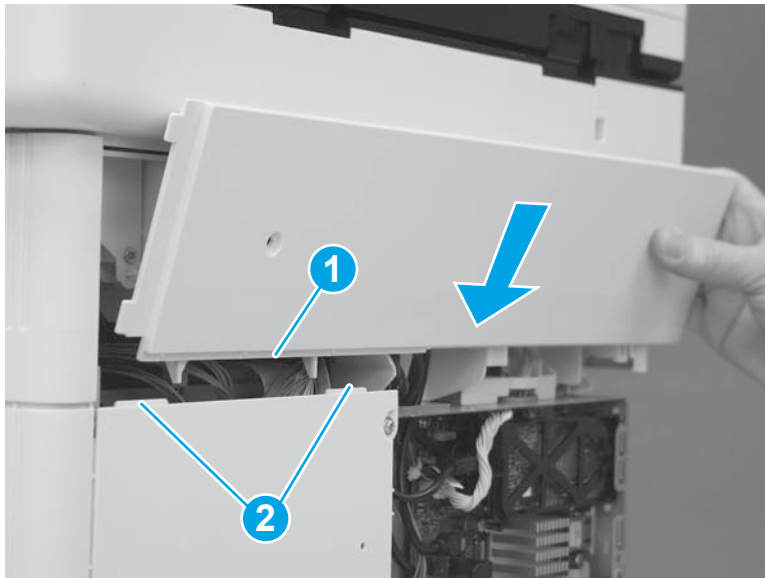

2. Rotate the top of the cover toward the printer.

Figure 1-925 Rotate the top of the cover

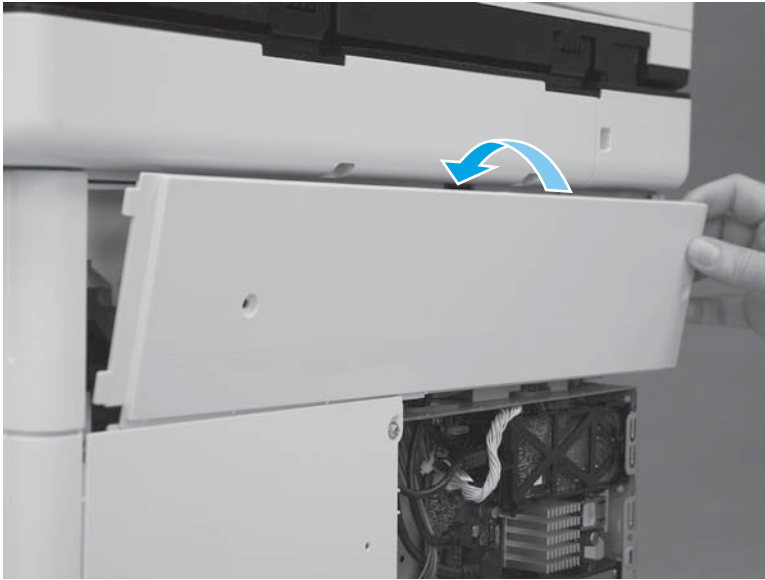

3. Slide the cover to the left (callout 1). Make sure that the tabs (callout 2) on the upper rear cover slide behind the edge (callout 3) of the right upper cover. Make sure that the cover is fully seated.

Figure 1-926 Slide the cover

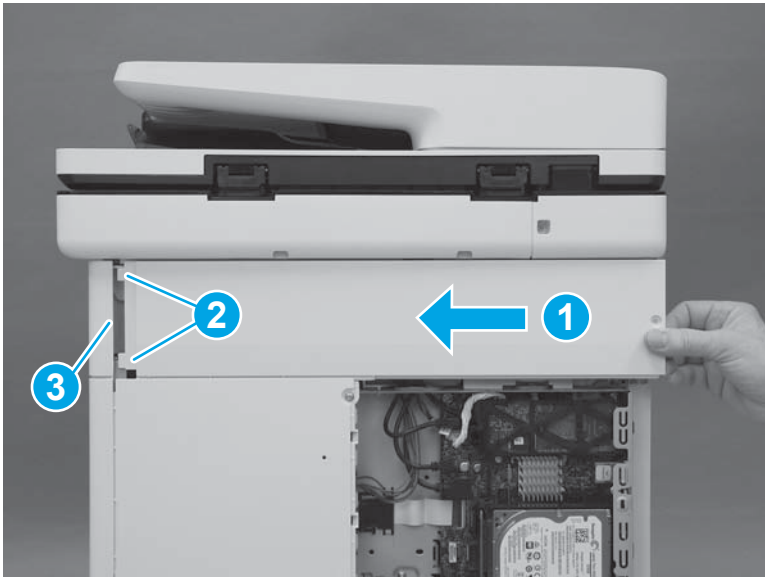

4. Install two screws (callout 1).



 **IMPORTANT:** These two screws are self-tapping screws for plastic. Rotate them counterclockwise to align them with the existing thread pattern, and then carefully turn them clockwise to tighten. Do not overtighten. This will prevent stripping the threads inside the screw holes.

Figure 1-927 Install two screws

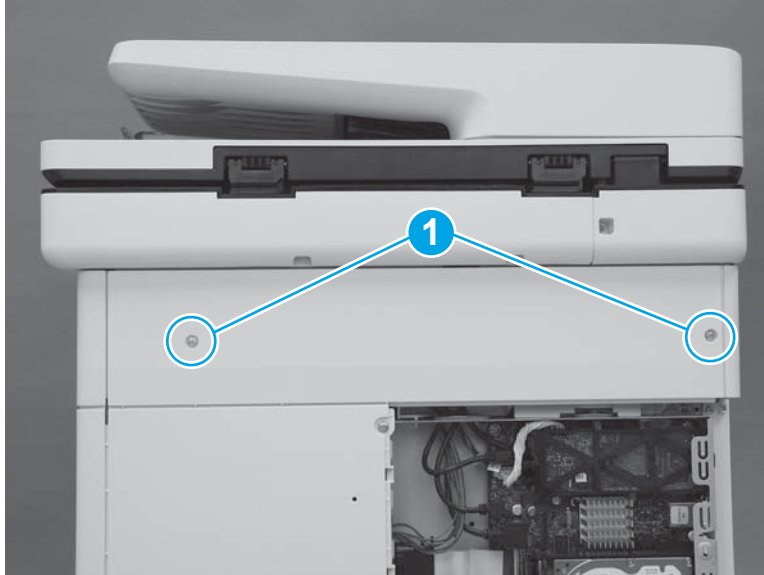

Step 15: Install the formatter cover

- ▲ Slide the cover onto the printer (callout 1) to install it.

 **NOTE:** Make sure that the tabs on the formatter cover align with the slots provided in the printer (callout 2). Tighten the two thumbscrews (callout 3).

 **TIP:** If needed, use the edge of a coin to turn the thumbscrews.

Figure 1-928 Install the cover



Removal and replacement: Control panel (M553n/dn and M552dn only)

- [Introduction](#)
- [Step 1: Remove the USB cover](#)
- [Step 2: Remove the toner collection unit \(TCU\)](#)
- [Step 3: Remove the formatter cover](#)
- [Step 4: Remove the rear cover](#)
- [Step 5: Remove the left cover](#)
- [Step 6: Remove the upper cover](#)
- [Step 7: Remove the control panel](#)
- [Step 8: Unpack the replacement assembly](#)
- [Step 9: Install the control panel](#)
- [Step 10: Install the upper cover](#)
- [Step 11: Install the left cover](#)
- [Step 12: Install the rear cover](#)
- [Step 13: Install the formatter cover](#)
- [Step 14: Install the TCU](#)
- [Step 15: Install the USB cover](#)

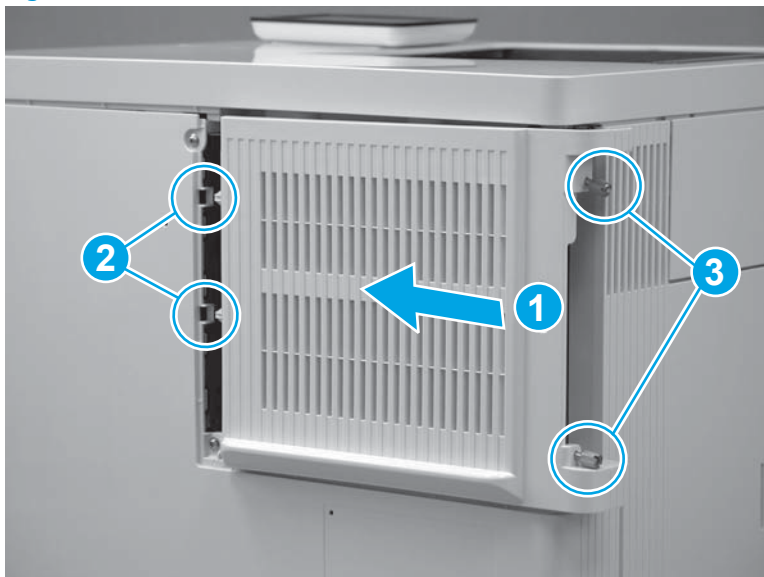
Introduction

This document provides the procedures to remove and replace the M553n/dn and M552dn control panel.

Before performing service

Turn the printer power off

- Disconnect the power cable.

 **WARNING!** To avoid damage to the printer, turn the printer off, wait 30 seconds, and then remove the power cord before attempting to service the printer.

- Open the right door.

Use the table below to identify the correct part number for your printer. To order the part, go to www.hp.com/buy/parts.

Control panel (M553n/dn and M552dn) part number

RM2-7180-000CNControl panel (M553n/dn and M552dn)

Required tools

- #2 Phillips screwdriver with a magnetic tip

After performing service

Make sure that the USB cover is fully seated after replacing it.

Make sure that the TCU is fully closed after replacing it.

Make sure that the formatter cover is fully seated, and that the thumbscrews are finger tight after replacing it.

Turn the printer power on

- Connect the power cable.
- Use the power switch to turn the power on.

Step 1: Remove the USB cover

1. Locate the USB cover.

Figure 1-929 Locate the USB cover



2. Pull the cover off of the printer to remove it.

Figure 1-930 Remove the cover



Step 2: Remove the toner collection unit (TCU)

1. Open the front door.

Figure 1-931 Open the front door



2. Open the TCU.



NOTE: The toner collection hatch cover automatically closes when the TCU is opened.

Figure 1-932 Open the TCU



3. Pull the TCU away from the printer at an angle to remove it.

⚠ CAUTION: Do not open the toner collection hatch cover when handling the TCU. If toner gets on clothing, wipe it off by using a dry cloth and wash the clothes in cold water. Hot water sets toner into fabric.

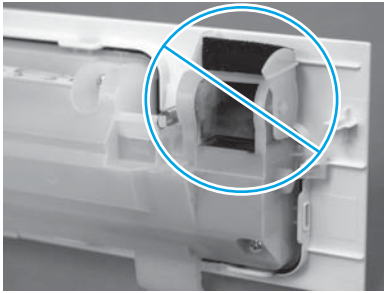
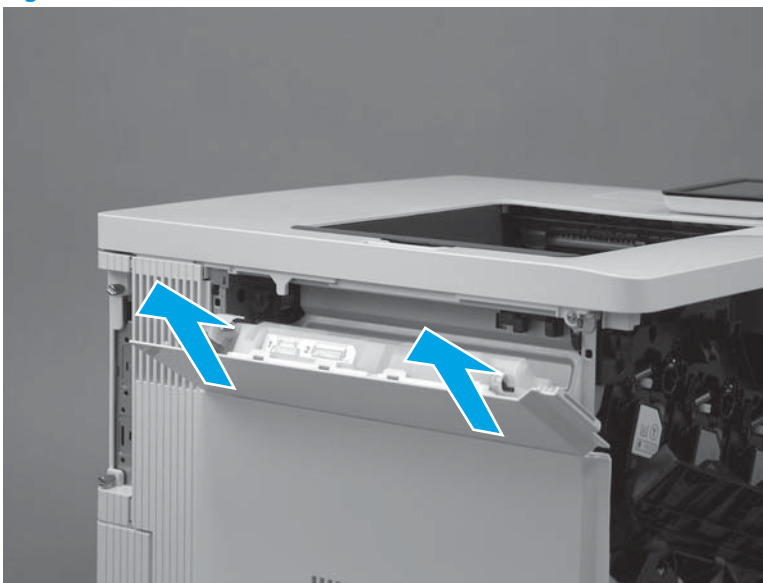

Figure 1-933 Remove the TCU



Step 3: Remove the formatter cover

1. Locate the formatter cover.

Figure 1-934 Locate the formatter cover

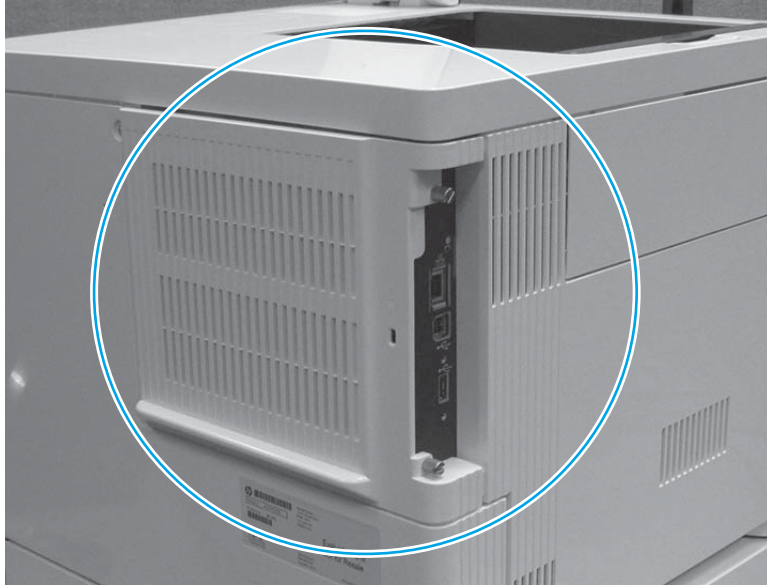

2. Loosen the two thumbscrews (callout 1). Grasp the two thumbscrews, and then slide the cover away from the printer (callout 2) to remove it.

 **TIP:** If needed, use the edge of a coin to turn the thumbscrews.

Figure 1-935 Loosen the thumbscrews



Step 4: Remove the rear cover

1. Remove four screws (callout 1).

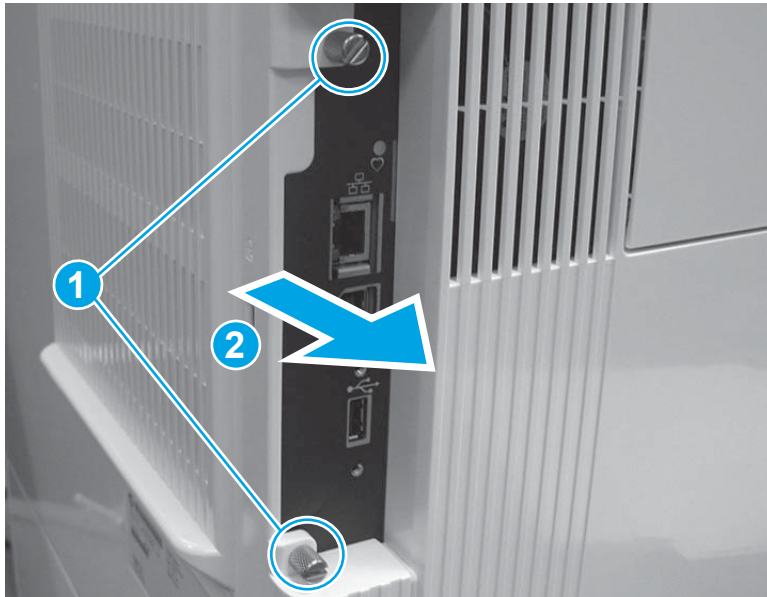
Figure 1-936 Remove four screws

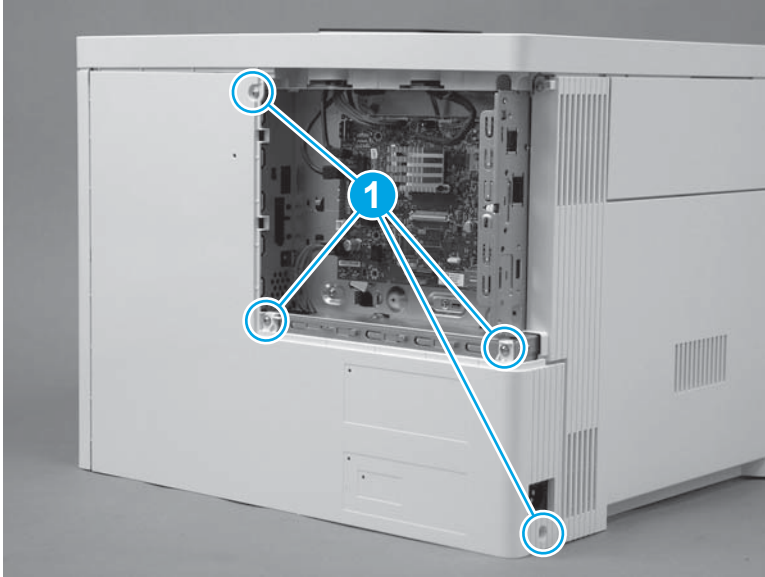

2. Slightly slide the cover to the right (callout 1), rotate the bottom of the cover away from the printer (callout 2), and then pull the top of the cover away from the printer (callout 3) to remove the cover.

Figure 1-937 Remove the cover

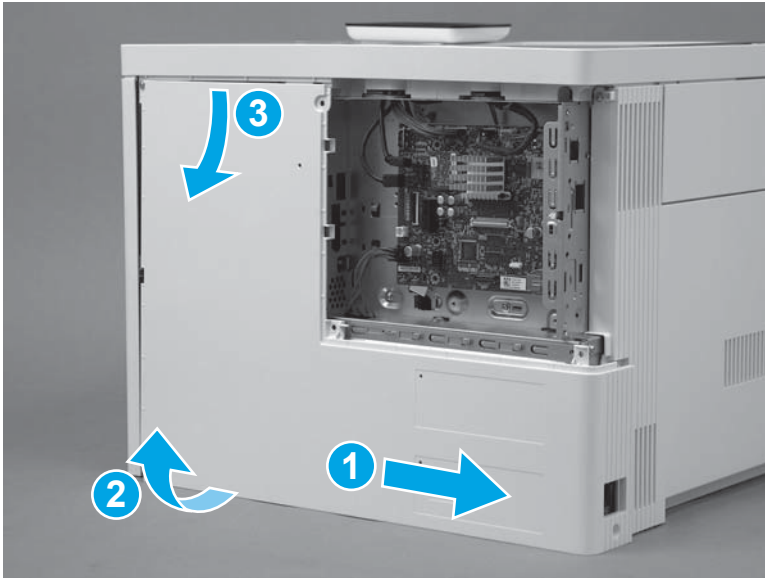

Step 5: Remove the left cover

1. At the left side of the printer, remove one screw (callout 1).

Figure 1-938 Remove one screw



2. Release one tab (callout 1), rotate the front edge of the cover away from the printer (callout 2), and then slide the cover (callout 3) toward the rear of the printer to release it.

Figure 1-939 Release the cover

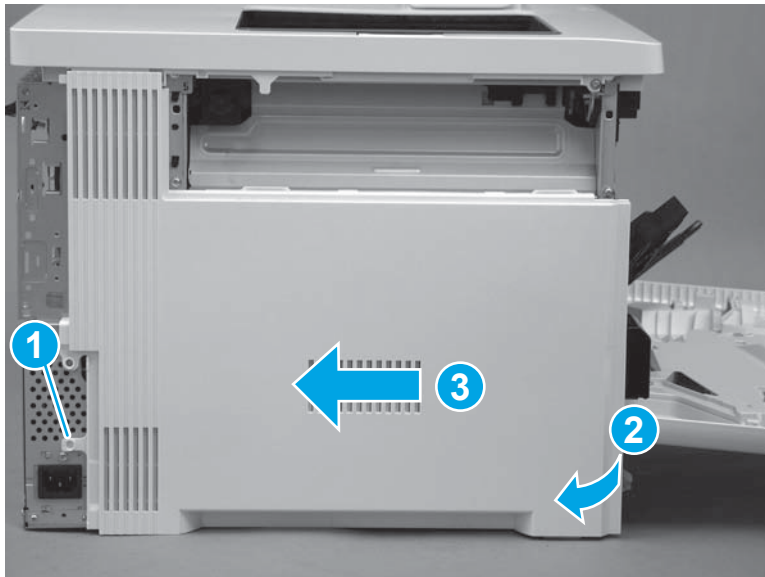

3. Remove the cover.

Figure 1-940 Remove the cover

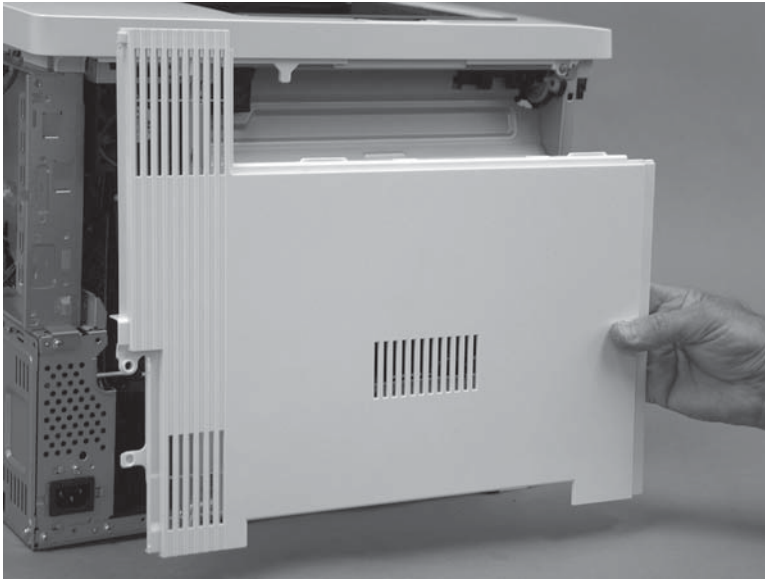

Step 6: Remove the upper cover

1. Remove three screws (callout 1).

Figure 1-941 Remove three screws

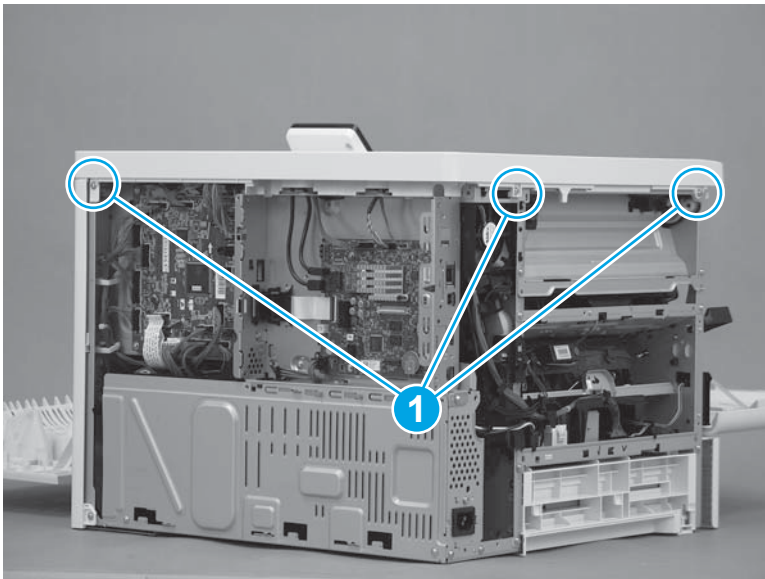

2. Remove one screw (callout 1), release one tab (callout 2), and then slightly separate the corner of the cover from the chassis.

 **NOTE:** This is a self-tapping plastic-thread screw. Make sure that this screw is used in this location when it is reinstalled.

Figure 1-942 Remove one screw and release one tab



3. Release one tab (callout 1), and then lift up on the cover to release it.

 **NOTE:** If the cover does not release, check for additional tabs by locating the triangles embossed in the cover at tab locations.

Figure 1-943 Release the cover



4. Remove the cover.

Figure 1-944 Remove the cover

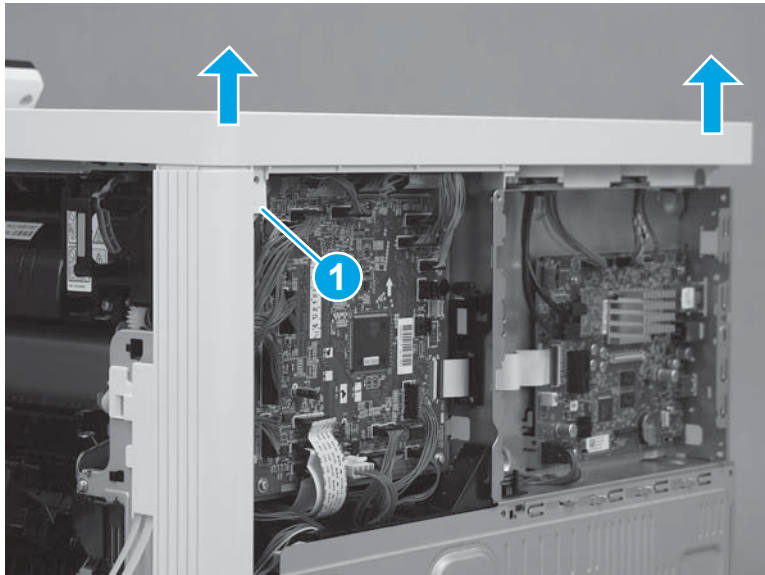
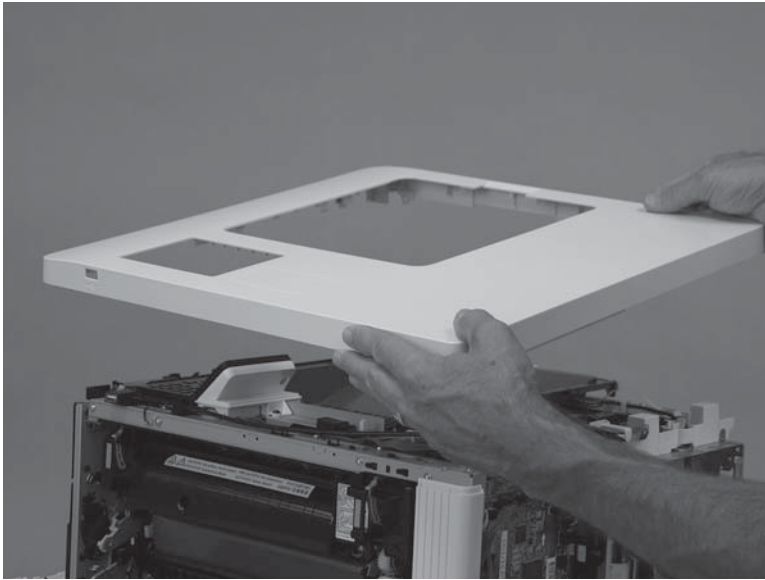

Step 7: Remove the control panel

1. Remove one screw (callout 1).

Figure 1-945 Remove one screw

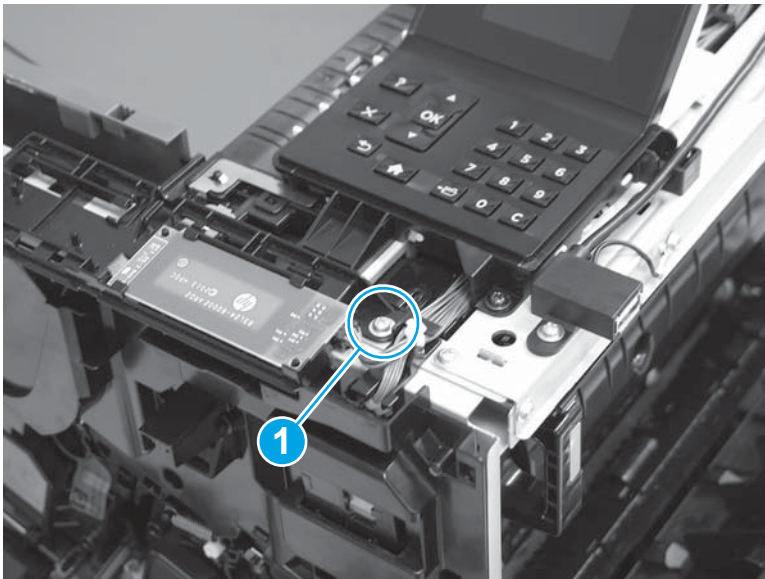

2. Disconnect one connector (callout 1). Rotate the near field communication (NFC) PCA holder up (callout 2), and then slide it to the right (callout 3) to remove it.

Figure 1-946 Remove the PCA holder

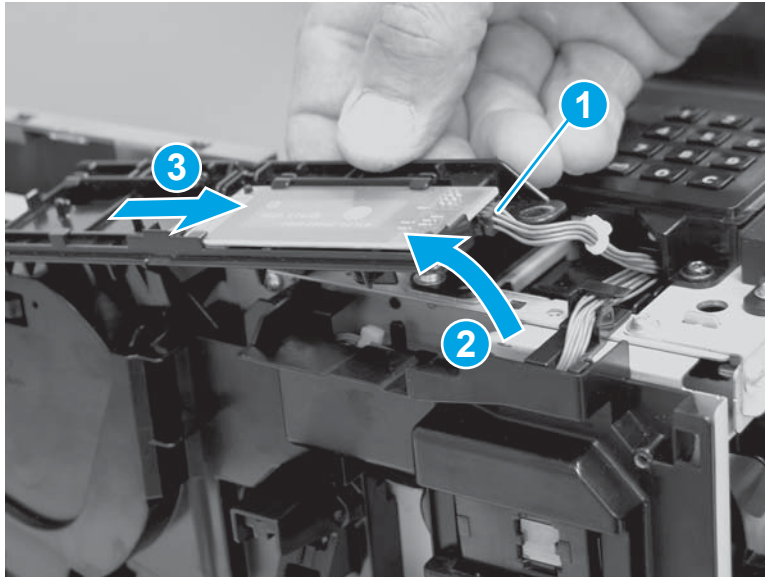

3. Remove one cable from the guide.

Figure 1-947 Remove one cable



4. Remove four screws (callout 1), and then turn the control panel over (callout 2) to access the bottom side.

CAUTION: The control panel is still attached to the printer. Do not attempt to completely remove the control panel.

Figure 1-948 Remove four screws

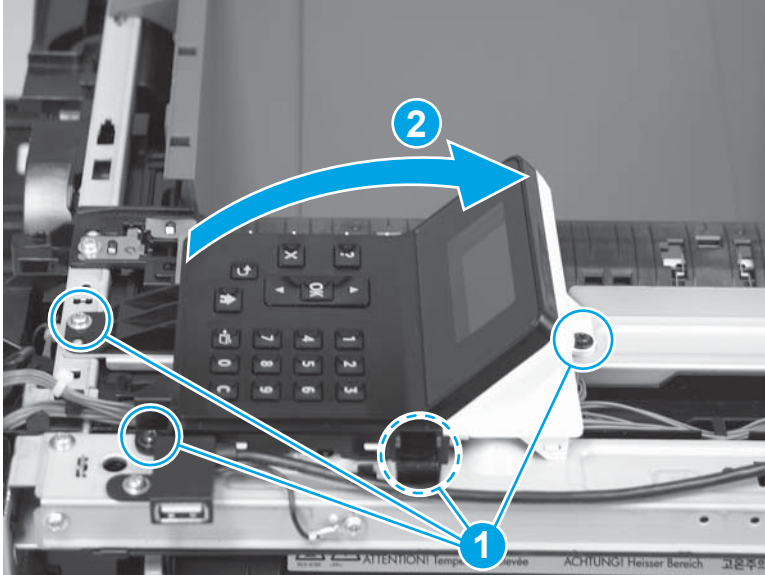

5. Disconnect one connector (callout 1), and then remove the control panel.

Figure 1-949 Remove the control panel

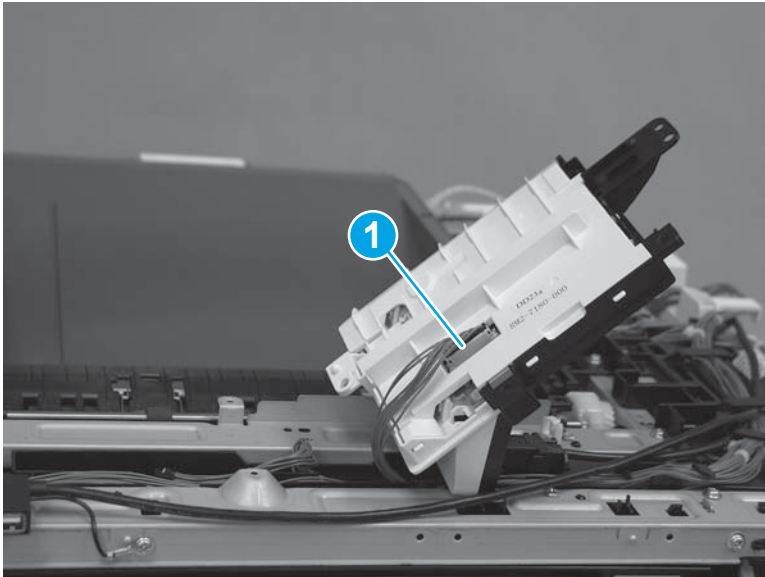

Step 8: Unpack the replacement assembly

Unpack the replacement assembly from the packaging.

For complete information on HP's recycling programs, go to [Product return and recycling](#).

NOTE: HP recommends responsible disposal of the defective assembly.

Figure 1-950 Recycle and unpack

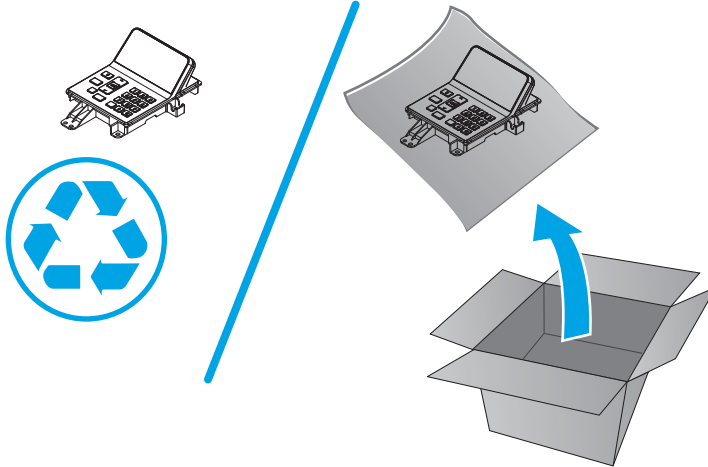

Step 9: Install the control panel

1. Position the control panel on the printer, and then connect one connector (callout 1).

Figure 1-951 Connect one connector

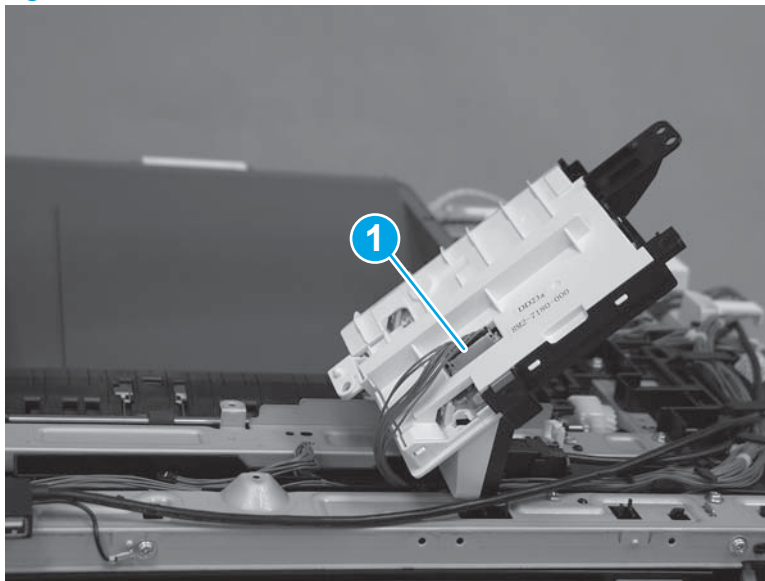

2. Turn the control panel over (callout 1), and then install four screws (callout 2).

Figure 1-952 Install four screws

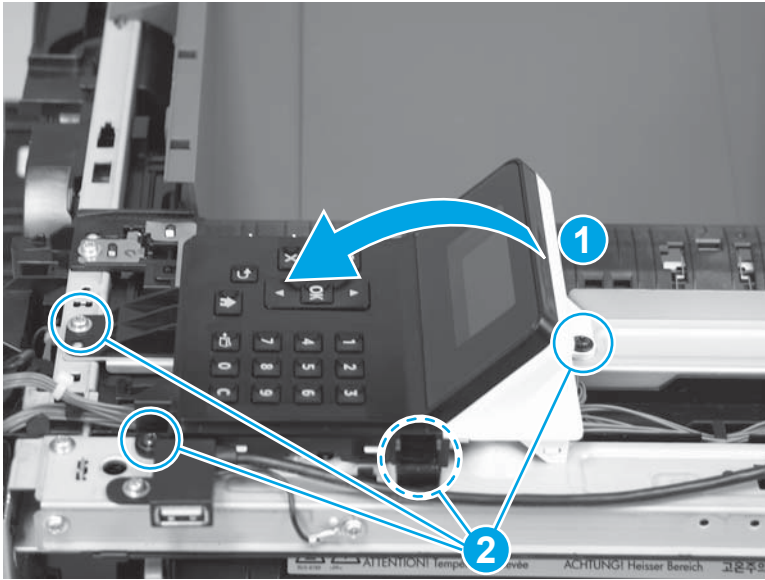

3. Place one cable in the guide.

Figure 1-953 Place one cable in the guide



4. Install the tab on the NFC PCA holder (callout 1) in the slot (callout 2) in the chassis.

Figure 1-954 Install the tab

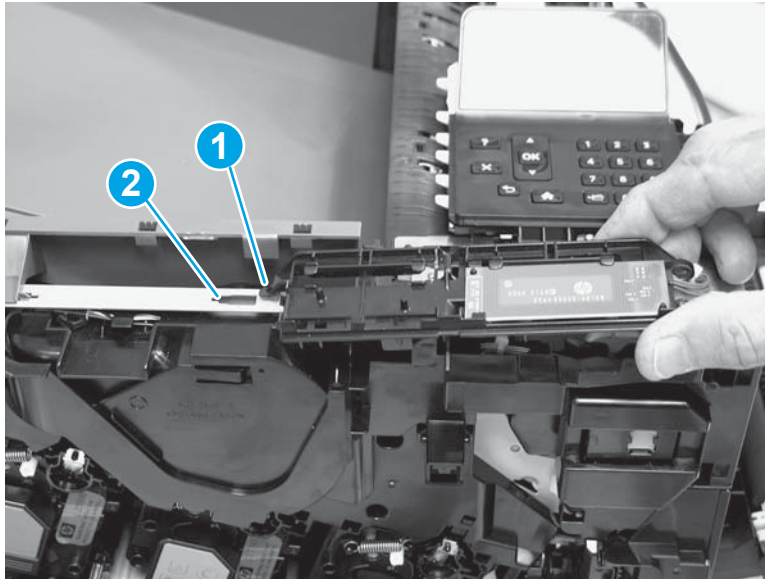

5. Rotate the NFC PCA holder down (callout 1) to install it, connect one connector (callout 2), and then install one screw (callout 3).

Figure 1-955 Install one screw

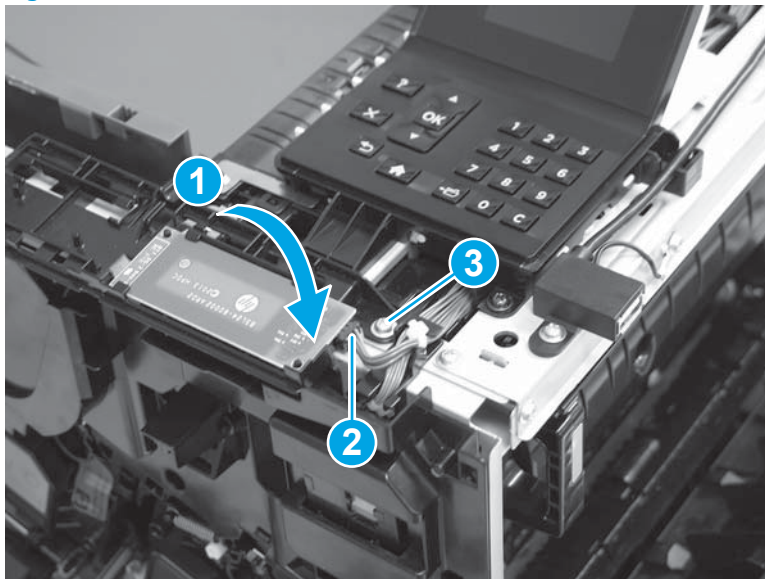

Step 10: Install the upper cover

1. Position the cover on the printer.

 **NOTE:** For the M553x model, do not forget to pass the control-panel wire harness and USB cable through the opening in the cover.

Figure 1-956 Install the cover



2. Push down on the rear corner of the cover to engage one tab (callout 1).

Figure 1-957 Engage one tab

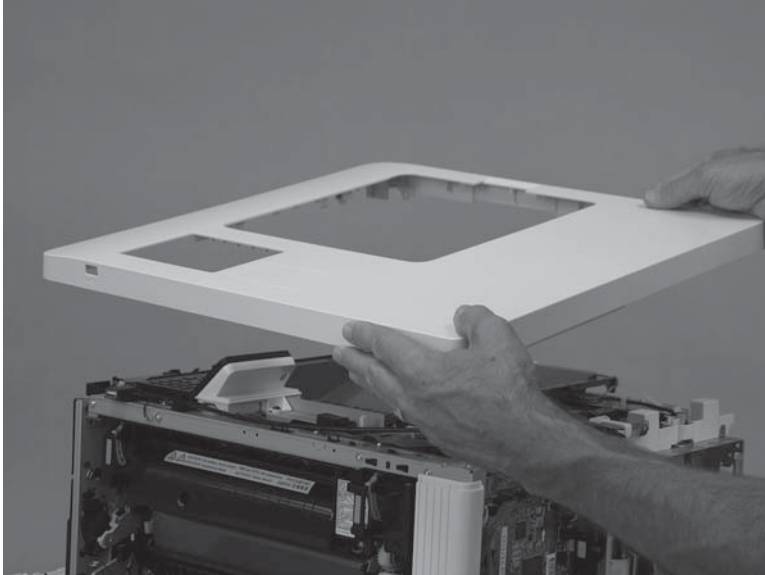
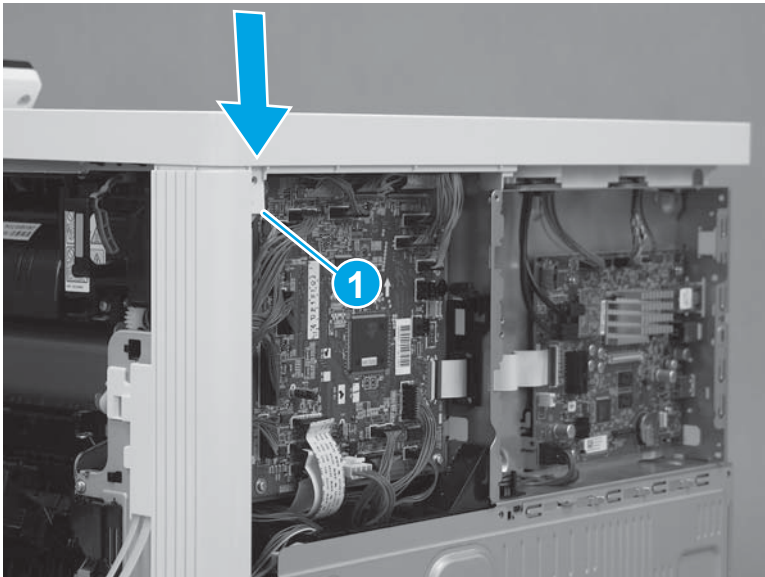

3. Push down on the front corner of the cover to engage one tab (callout 1), and then install one screw (callout 2).

 **NOTE:** This is a self-tapping plastic-thread screw. Make sure that this screw is used in this location when it is reinstalled.

Figure 1-958 Engage one tab and install one screw



4. Install three screws (callout 1).

Figure 1-959 Install three screws

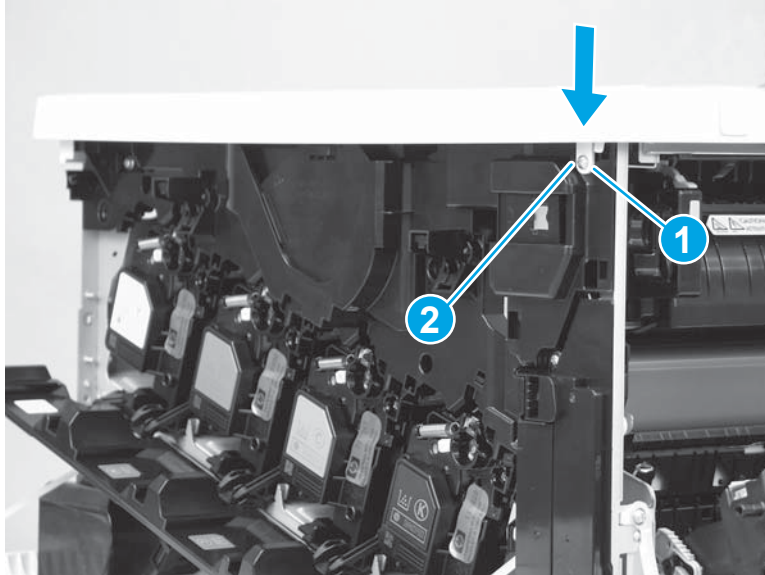
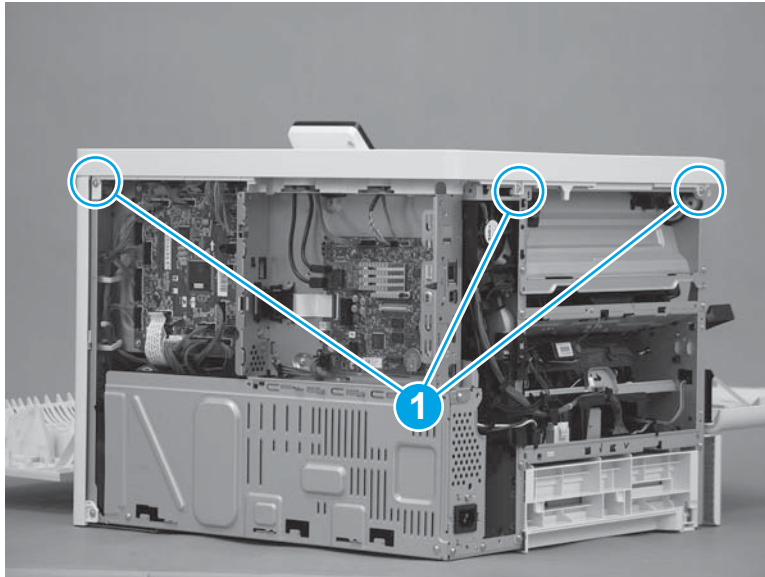

Step 11: Install the left cover

1. Position the cover on the printer.

 **NOTE:** Slightly offset the cover toward the rear of the printer.

Figure 1-960 Install the cover

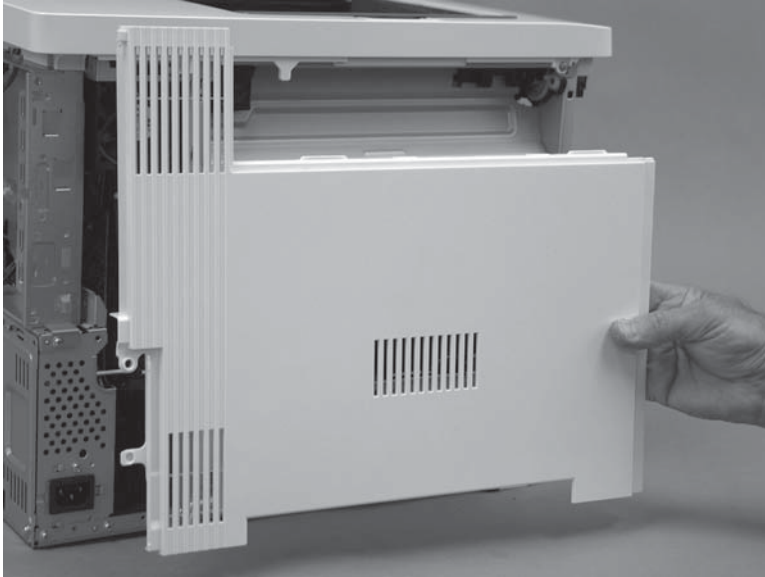

2. Slide the cover (callout 1) toward the front of the printer to engage it. Make sure that the tab (callout 2) snaps into place.

 **NOTE:** Locate the alignment pin (callout 3) on the cover from the front door side of the printer, and then make sure that it is fully engaged in the slot in the chassis.

 **TIP:** While sliding the cover into place, push in on the center of the cover (callout 1) to make sure that the hooks on the back of the cover engage with the slots in the chassis.

Figure 1-961 Engage the cover



3. At the left side of the printer, install one screw (callout 1).

Figure 1-962 Install one screw

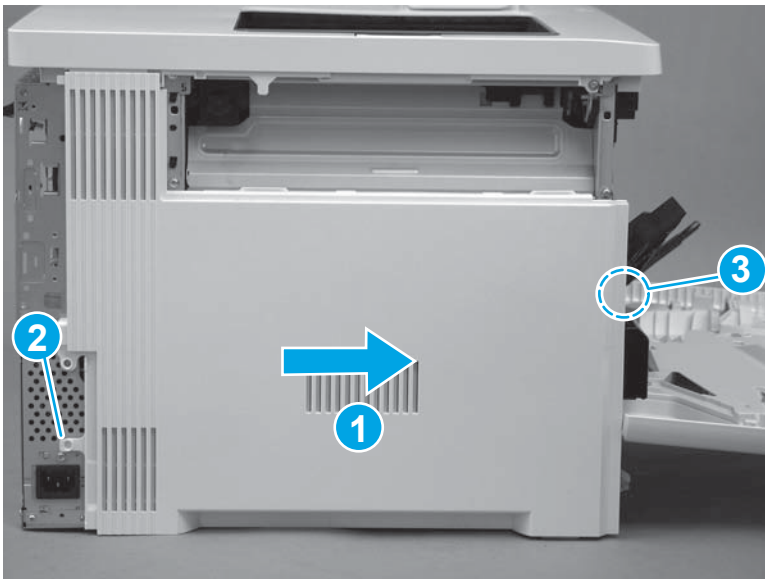

Step 12: Install the rear cover

1. Position the top of the cover under the upper cover (callout 1), rotate the bottom of the cover onto the chassis (callout 2), and then slide the cover to the left (callout 3) to install it.

Figure 1-963 Install the cover

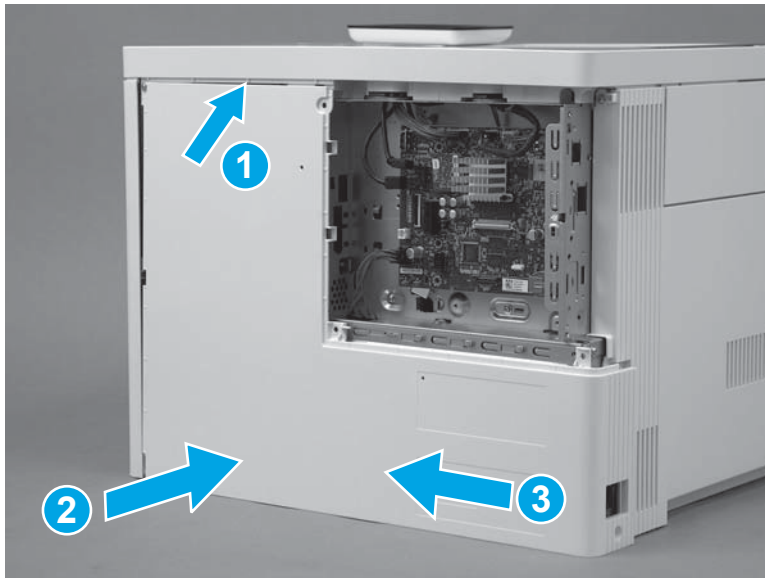

2. Install four screws (callout 1).

Figure 1-964 Install four screws cover

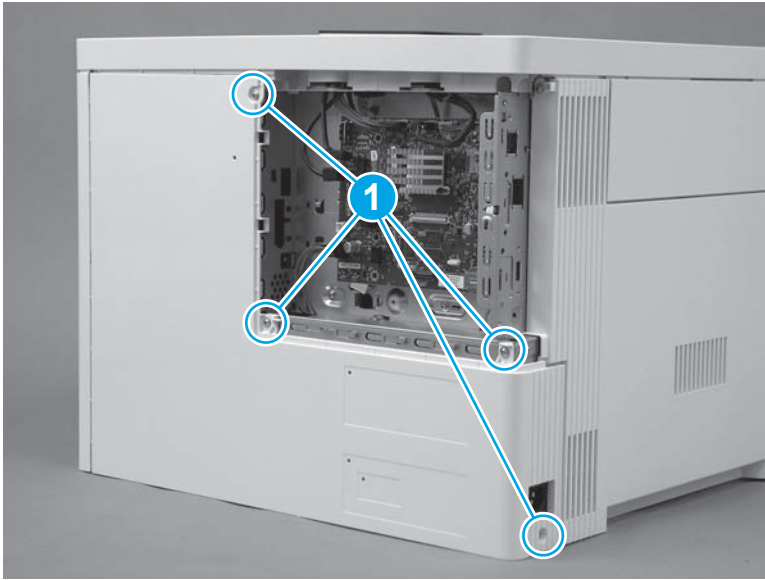

Step 13: Install the formatter cover

- ▲ Slide the cover onto the printer (callout 1) to install it.

 **NOTE:** Make sure that the tabs on the formatter cover align with the slots provided in the printer (callout 2). Tighten the two thumbscrews (callout 3).

 **TIP:** If needed, use the edge of a coin to turn the thumbscrews.

Figure 1-965 Install the cover



Step 14: Install the TCU

1. Verify that the toner collection hatch cover is in the closed position on the TCU.

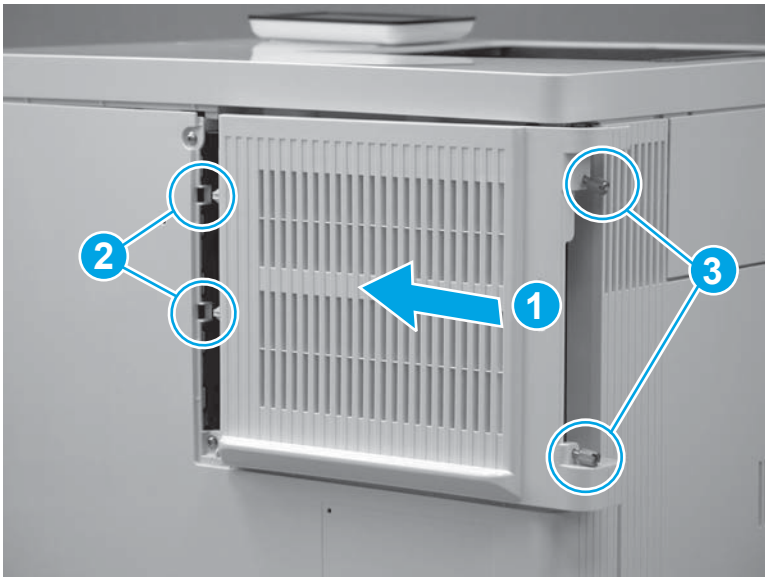
Figure 1-966 Verify that the toner collection hatch cover is closed

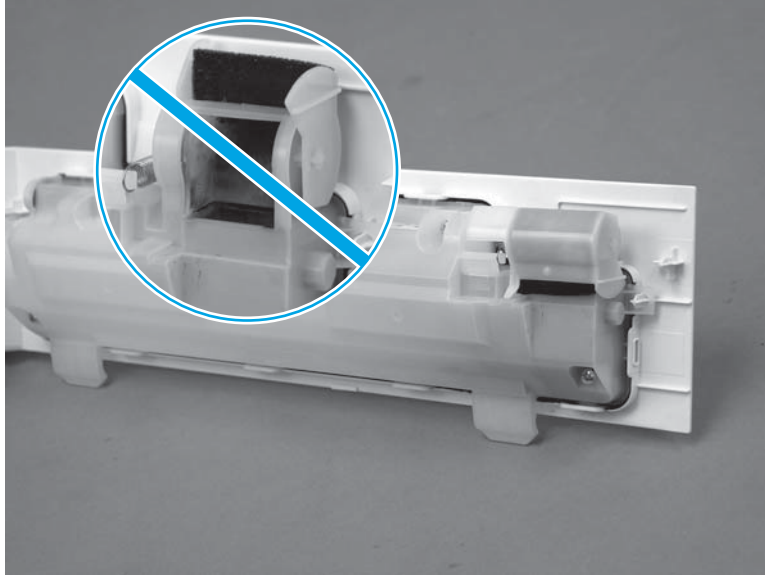

2. Position the TCU with the hinges in the slots provided in the printer (callout 1), and then rotate the TCU up and into the closed position.

 **NOTE:** The toner collection hatch cover automatically opens when the TCU is closed.

Figure 1-967 Install the TCU



3. Close the front door.

Figure 1-968 Close the front door

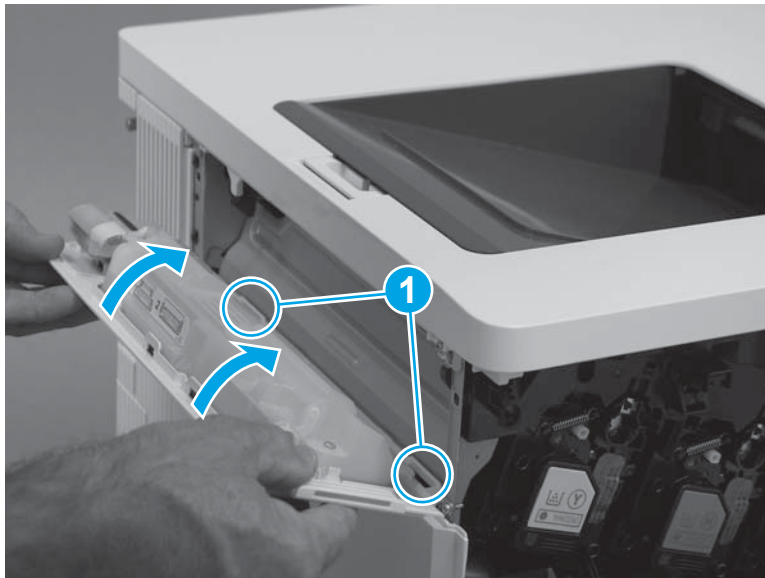

Step 15: Install the USB cover

1. Push the cover into the USB port to install it.

Figure 1-969 Install the cover



2. Make sure that the USB cover is fully seated after installing it.

Figure 1-970 Check the installation

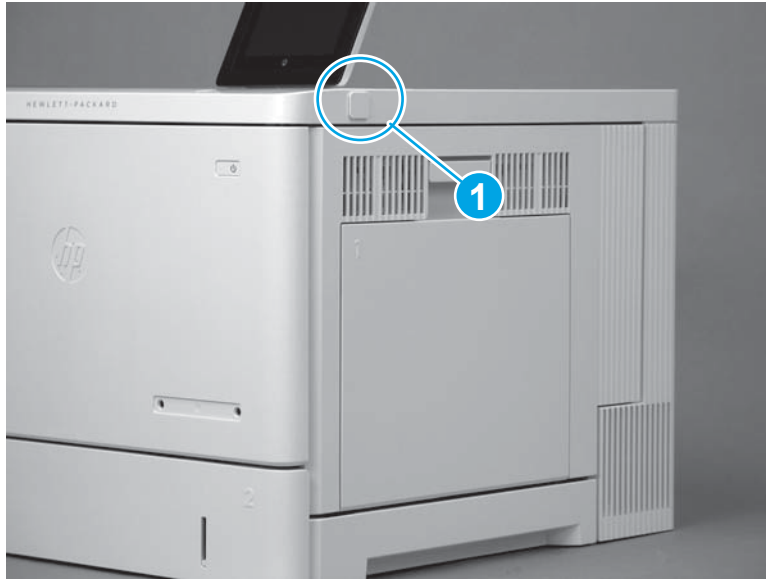

Removal and replacement: Internal parts and assemblies

- [Removal and replacement: Tray 1 pickup and separation rollers](#)
- [Removal and replacement: Secondary transfer assembly](#)
- [Removal and replacement: Near field communication \(NFC\) PCA \(M553x\)](#)
- [Removal and replacement: Near field communication \(NFC\) PCA \(M577z\)](#)
- [Removal and replacement: Wireless PCA \(M553 and M577\)](#)
- [Removal and replacement: Stapler unit \(M577c/f/z\)](#)
- [Removal and replacement: DC controller](#)
- [Removal and replacement: Delivery assembly](#)
- [Removal and replacement: Formatter \(M552 and M553\)](#)
- [Removal and replacement: Formatter \(M577\)](#)
- [Removal and replacement: Formatter case assembly](#)
- [Removal and replacement: Fuser power supply](#)
- [Removal and replacement: Low-voltage power supply \(LVPS\)](#)
- [Removal and replacement: High-voltage power supply D \(HVPSD\)](#)
- [Removal and replacement: Drum motor 1 \(M1\)](#)
- [Removal and replacement: Power-supply fan \(FM1\)](#)
- [Removal and replacement: Developing disengagement motor \(M6\)](#)
- [Removal and replacement: Auto close assembly](#)
- [Removal and replacement: Lifter drive assembly](#)
- [Removal and replacement: Laser/scanner assembly](#)
- [Removal and replacement: Delivery fan \(FM3\)](#)
- [Removal and replacement: High-voltage power supply T \(HVPST\)](#)
- [Removal and replacement: Drum motor 2 \(M2\)](#)
- [Removal and replacement: Drum motor 3 \(M3\)](#)
- [Removal and replacement: Fuser motor \(M4\)](#)
- [Removal and replacement: Environmental sensor printed circuit assembly \(PCA\)](#)
- [Removal and replacement: Fuser drive assembly](#)
- [Removal and replacement: Duplex drive assembly and motor](#)
- [Removal and replacement: Pickup drive assembly and motor \(M5\)](#)
- [Removal and replacement: Registration assembly](#)

- [Removal and replacement: Paper pickup assembly](#)
- [Removal and replacement: Density-detect assembly](#)
- [Removal and replacement: Main drive assembly](#)

Removal and replacement: Tray 1 pickup and separation rollers

- [Introduction](#)
- [Step 1: Remove the Tray 1 pickup roller](#)
- [Step 2: Remove the Tray 1 separation roller](#)
- [Step 3: Unpack the replacement assemblies](#)
- [Step 4: Install the Tray 1 separation roller](#)
- [Step 5: Install the Tray 1 pickup roller](#)

Introduction

This document provides the procedures to remove and replace the Tray 1 pickup and separation rollers.

Before performing service

Turn the printer power off

- Disconnect the power cable.

 **WARNING!** To avoid damage to the printer, turn the printer off, wait 30 seconds, and then remove the power cord before attempting to service the printer.

Use the table below to identify the correct part number for your printer. To order the part, go to www.hp.com/buy/parts.

Tray 1 pickup and separation rollers kit part number	
--	--

B5L24-67905

Tray 1 pickup and separation rollers with instruction guide

Required tools

No special tools are required to install this part.

After performing service

Make sure that Tray 1 is fully closed after replacing the rollers.

Turn the printer power on

- Connect the power cable.
- Use the power switch to turn the power on.

Post service test

Print a configuration page to make sure that the printer is functioning correctly.

Step 1: Remove the Tray 1 pickup roller

1. Open Tray 1.

Figure 1-971 Open Tray 1



2. Pull on the center of the cover to open it.

Figure 1-972 Open the roller cover

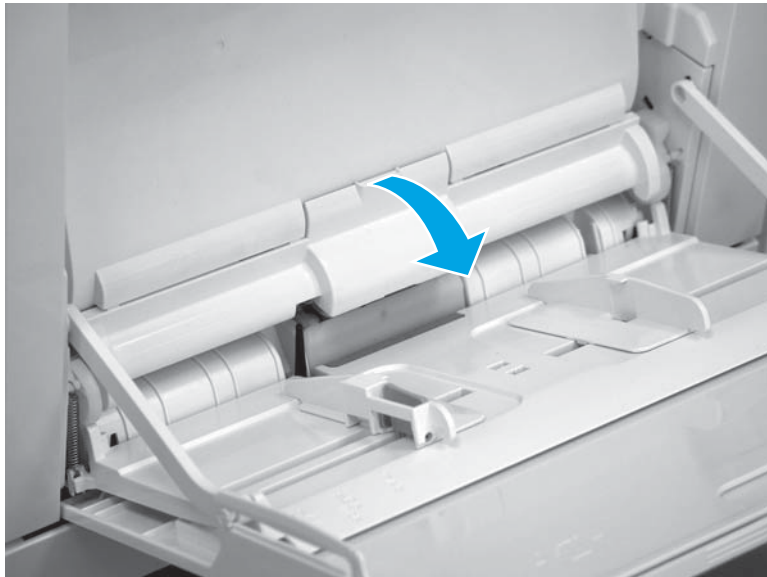

3. Pull the cover straight off of the printer to remove it.

Figure 1-973 Remove the cover

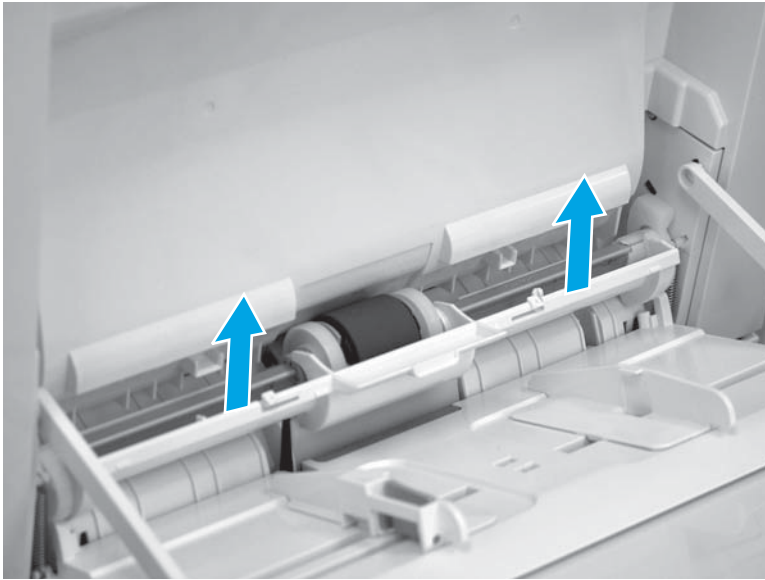

4. Release two tabs (callout 1) between the roller collar and roller, and then rotate the top of the roller (callout 2) out and away from the printer.

 **TIP:** Pushing down on the top of the roller might make it easier to release the tabs.

Figure 1-974 Release two tabs



5. Remove the roller.

Figure 1-975 Remove the roller

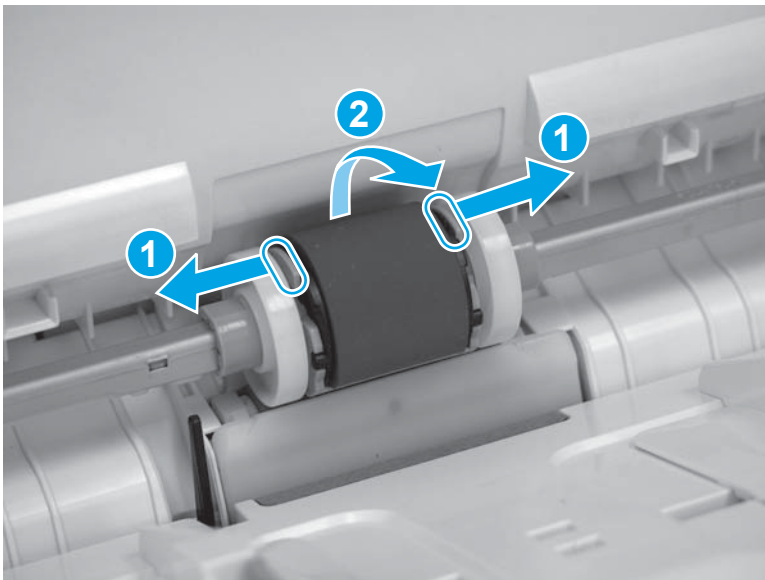
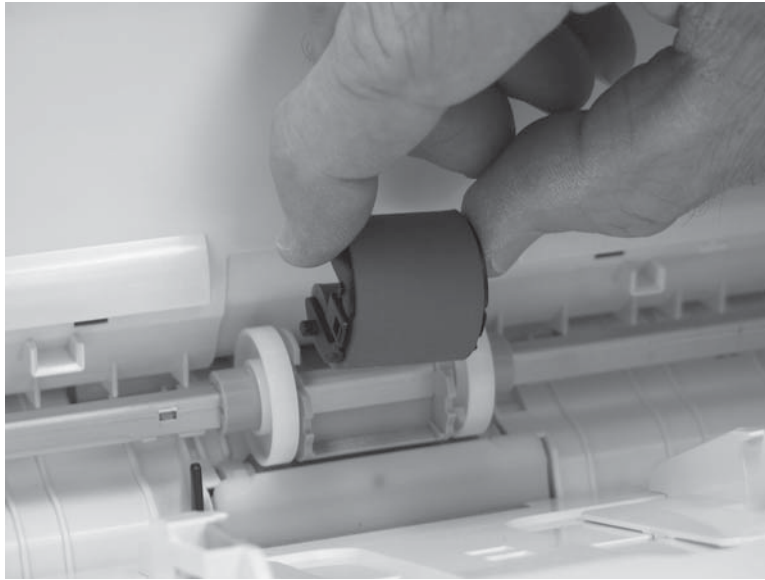

Step 2: Remove the Tray 1 separation roller

1. Carefully flex the right- and left-side tray retainers to release them.

 **TIP:** Raise the tray to the halfway closed position to make it is easier to release the retainers.

Figure 1-976 Release the tray retainers

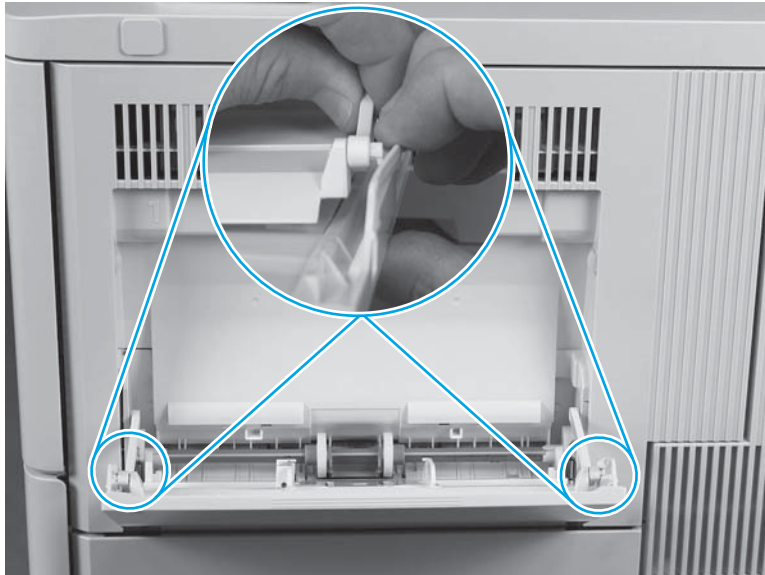

- Carefully raise Tray 1 up into the printer.

Figure 1-977 Raise Tray 1 up

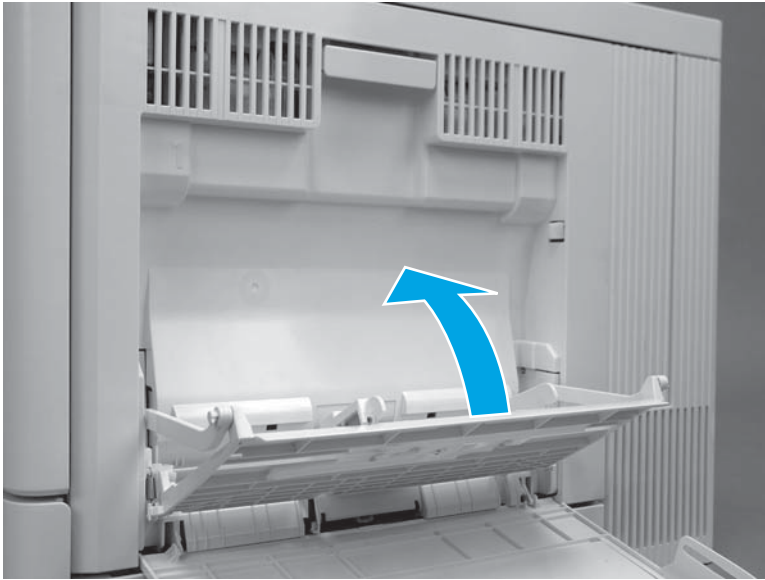

- Firmly grasp the corners of the separation roller cover, and then rotate it down and away from the printer to remove it.

Figure 1-978 Open the roller cover

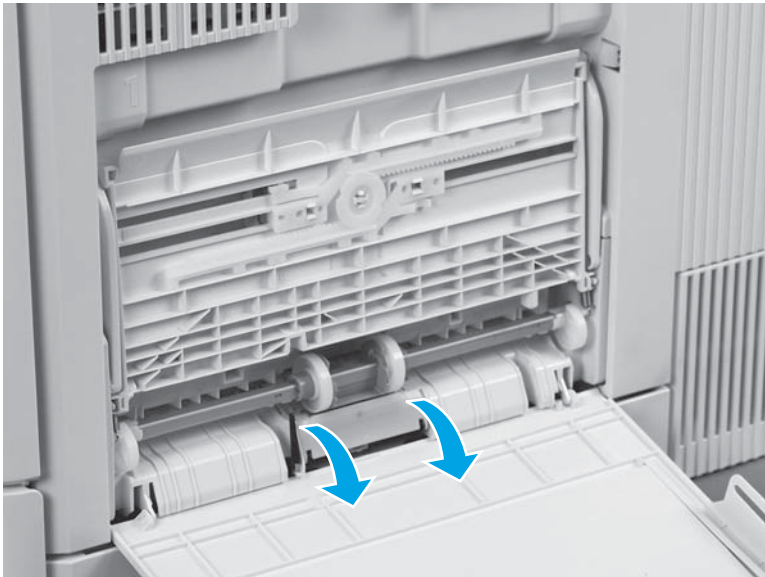

4. Release one tab (callout 1), and then rotate the end of the roller out and away from the holder (callout 2).

 **TIP:** It might be necessary to use a small flat-blade screwdriver to complete this step.

Figure 1-979 Release one tab



5. Slide the roller out of the holder to remove it.

Figure 1-980 Remove the roller

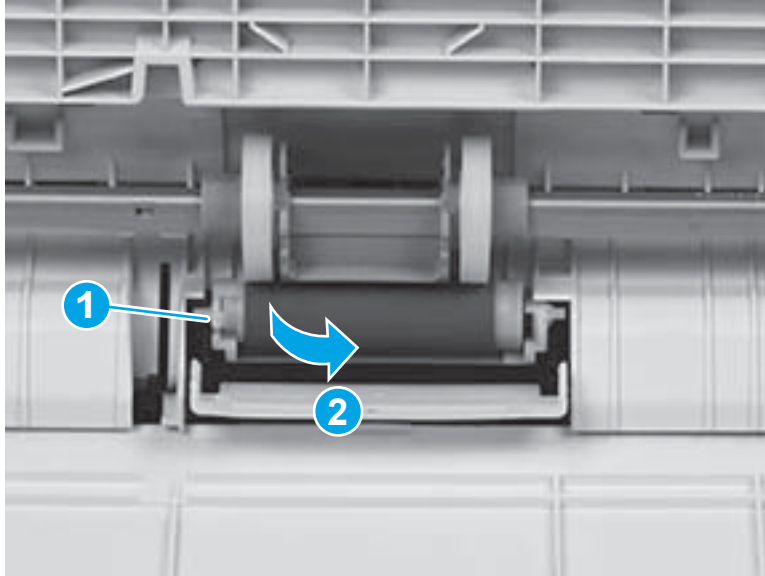
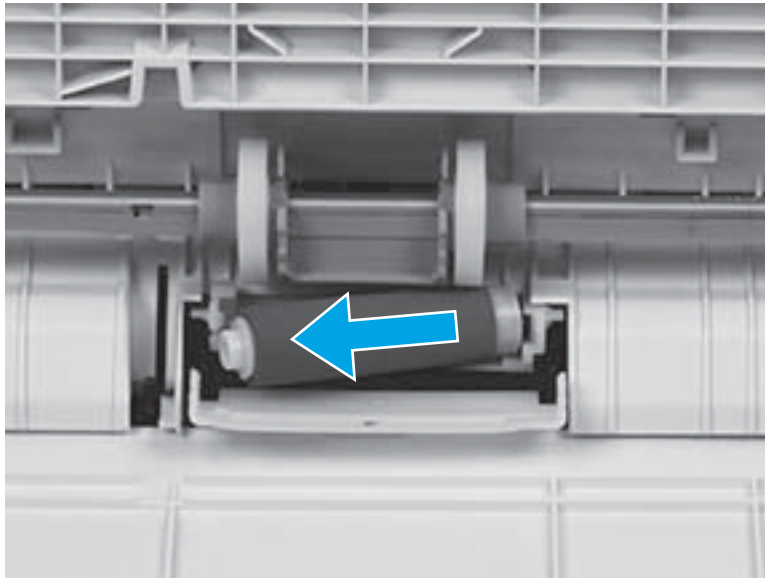

Step 3: Unpack the replacement assemblies

Unpack the replacement assemblies from the packaging.

 **CAUTION:** Avoid touching the surface of the replacement rollers. Skin oils on the rollers can cause print-quality problems. Thoroughly wash your hands with soap and water to remove skin oils, and then completely dry them.

For complete information on HP's recycling programs, go to [Product return and recycling](#).

 **NOTE:** HP recommends responsible disposal of the defective assemblies.

Figure 1-981 Recycle and unpack



Step 4: Install the Tray 1 separation roller

1. Before beginning, locate the keyed end of the replacement separation roller (callout 1) and the holder (callout 2).

Figure 1-982 Locate the keyed end of the roller and the holder

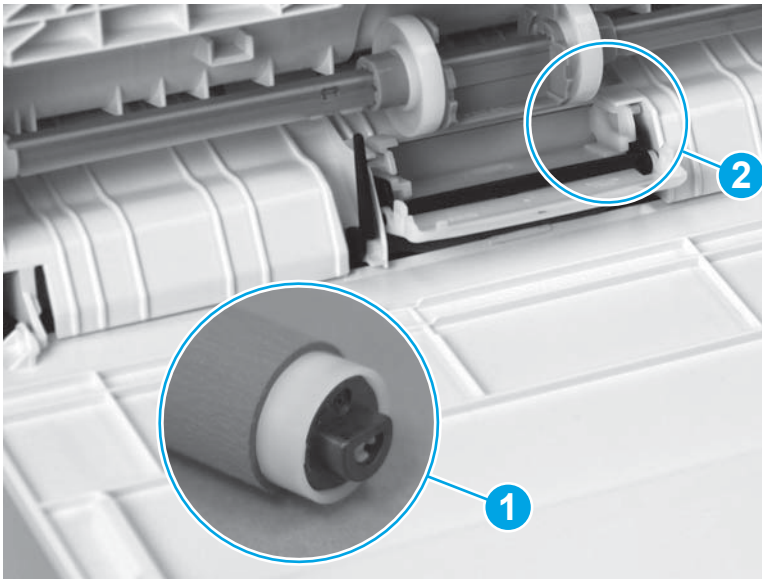

2. Slide the keyed end of the roller into the holder to install it.

Figure 1-983 Install the roller

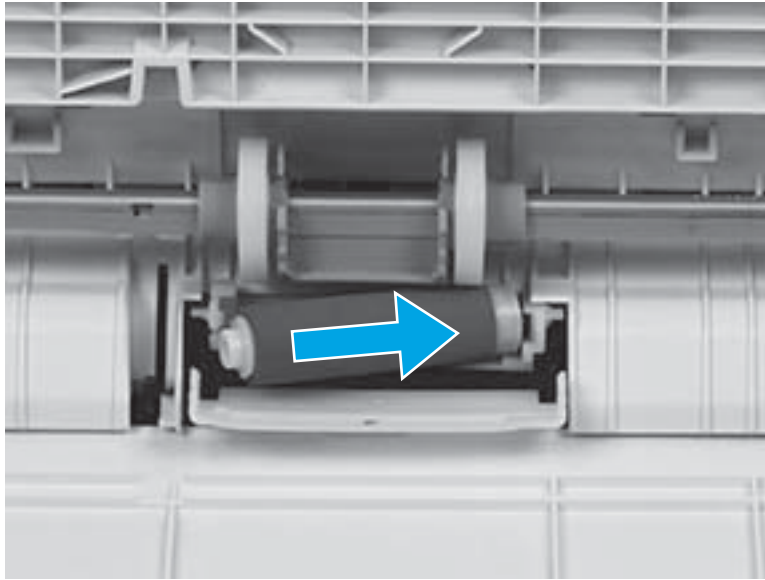

3. Rotate the end of the roller into the holder (callout 1) until the tab (callout 2) snaps into place.

Figure 1-984 Rotate the end of the roller into the holder

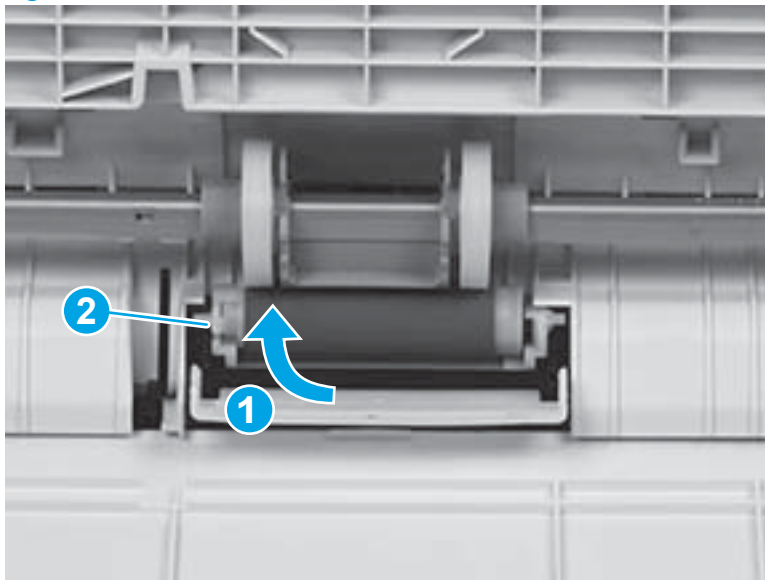

4. Position the separation roller cover on the printer, and then rotate it up and towards the printer to install it.

Figure 1-985 Close the roller cover

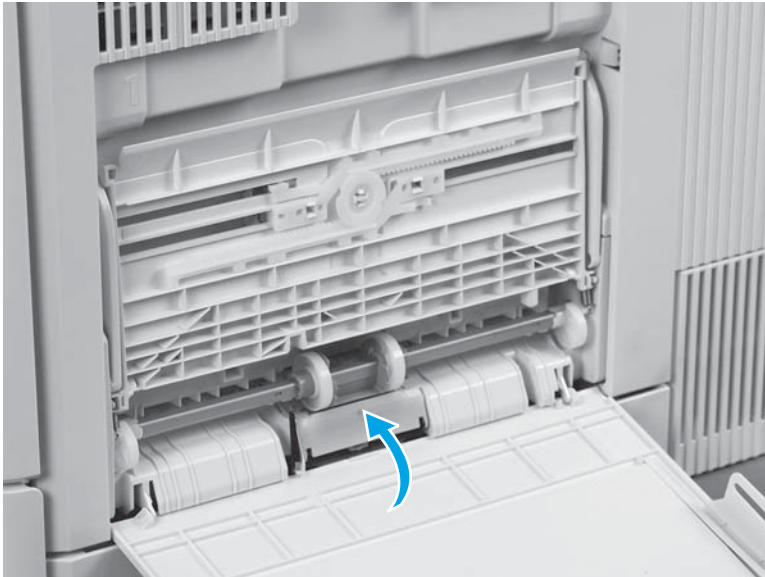

5. Carefully lower Tray 1 down.

Figure 1-986 Lower Tray 1 down

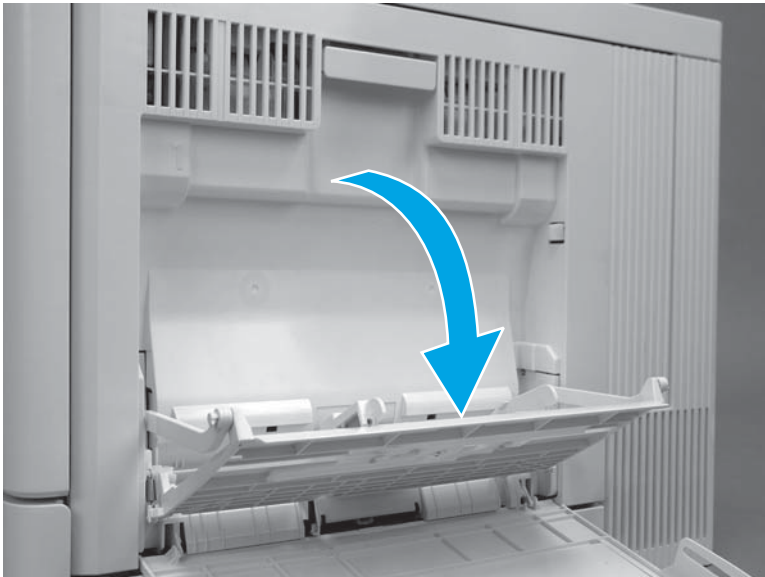

6. Carefully flex the right- and left-side tray retainers to reconnect them.

Figure 1-987 Reconnect the tray retainers

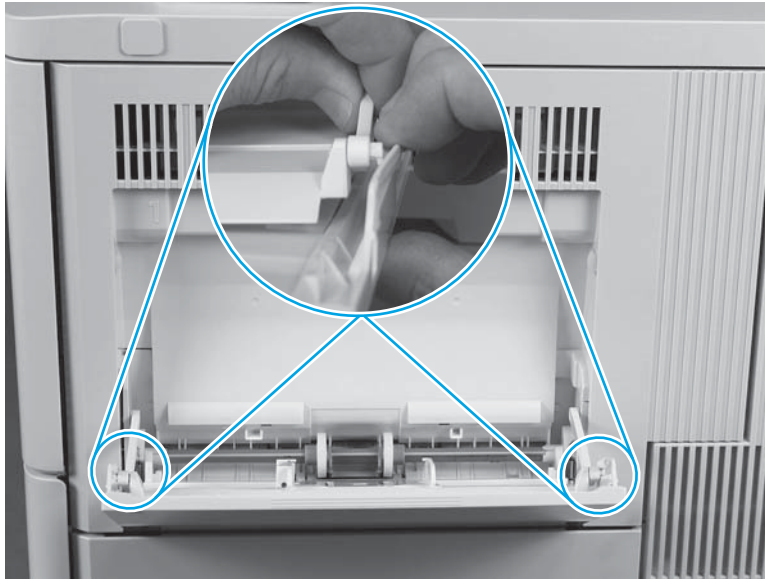

Step 5: Install the Tray 1 pickup roller

1. Position the replacement pickup roller with the pins in the provided slots on the holder, and then rotate the top of the roller up and toward the printer.

Figure 1-988 Install the roller

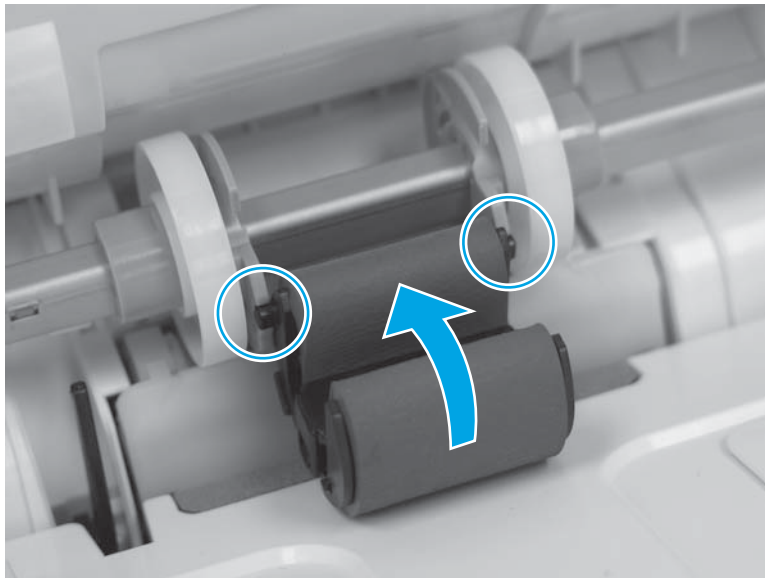

2. Continue to rotate the top of the roller toward the printer (callout 1), until two tabs (callout 2) snap into place.

Figure 1-989 Reconnect two tabs

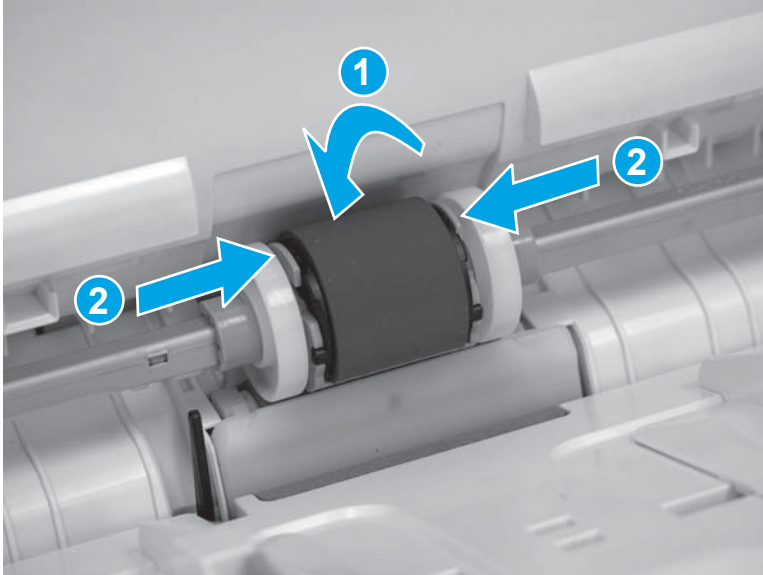

3. Install the roller cover.

Figure 1-990 Install the roller cover

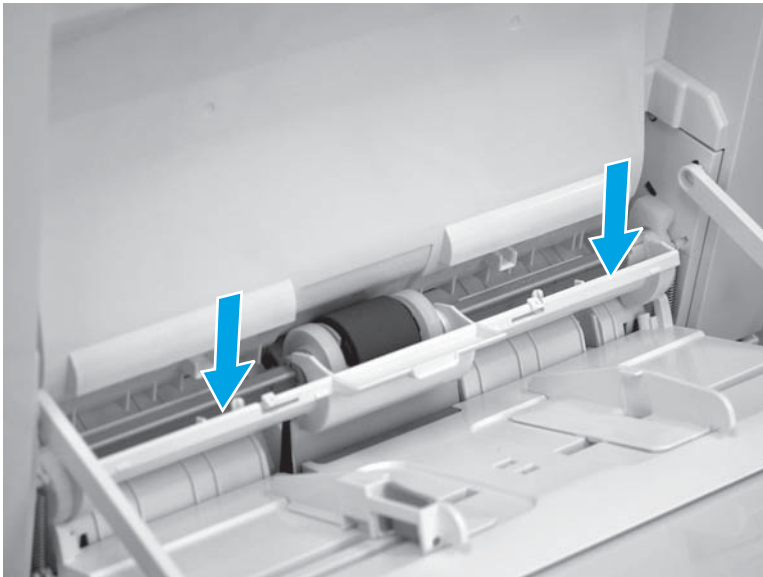

4. Close the roller cover.

Figure 1-991 Close the roller cover

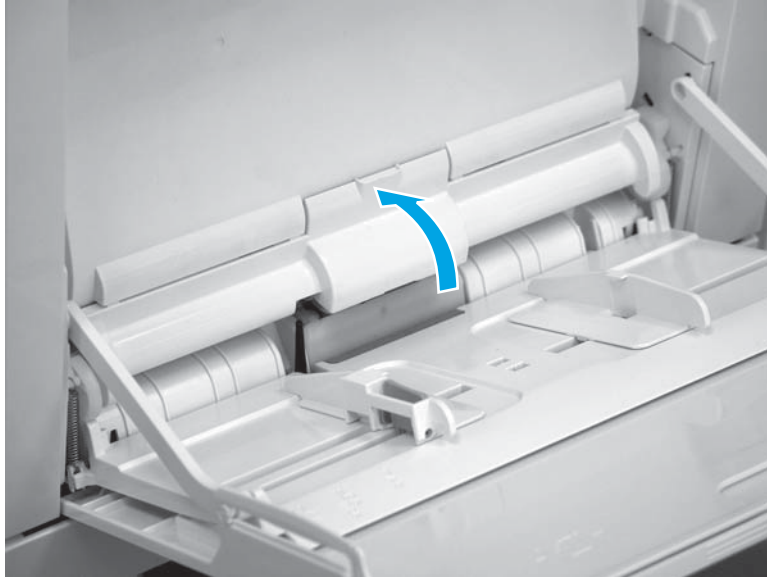

5. Close Tray 1.

Figure 1-992 Close Tray 1



Removal and replacement: Secondary transfer assembly

- [Introduction](#)
- [Step 1: Remove the secondary transfer assembly](#)
- [Step 2: Unpack the replacement assembly](#)
- [Step 3: Install the secondary transfer assembly](#)

Introduction

This document provides the procedures to remove and replace the secondary transfer assembly.

Before performing service

Turn the printer power off

- Disconnect the power cable.

 **WARNING!** To avoid damage to the printer, turn the printer off, wait 30 seconds, and then remove the power cord before attempting to service the printer.

Use the table below to identify the correct part number for your printer, and then go to <http://h20141.www2.hp.com/hpparts> to order the part.

Secondary transfer assembly part number	
RM2-0090-000CN	Secondary transfer assembly (M553n)
RM2-0022-000CN	Secondary transfer assembly (M552dn, M553dn, M553x, M577)

Required tools

- #2 Phillips screwdriver with a magnetic tip

After performing service

Make sure that the right door is fully closed after replacing the secondary transfer roller assembly.

Turn the printer power on

- Connect the power cable.
- Use the power switch to turn the power on.

Post service test

Print a configuration page to make sure that the printer is functioning correctly.

Step 1: Remove the secondary transfer assembly

1. Open the right door.

Figure 1-993 Open the right door



2. Release the blue arm, and then let the secondary transfer assembly rotate down to the half-way open position.

 **NOTE:** The assembly should stop at the halfway down point—the pin will stop at the notch in the slot in the blue arm.

Figure 1-994 Release the secondary transfer roller assembly



3. Carefully flex the top portion of the blue arm—as shown in the figure—to start to disengage it from the pin.

Figure 1-995 Carefully flex the top portion of the blue arm

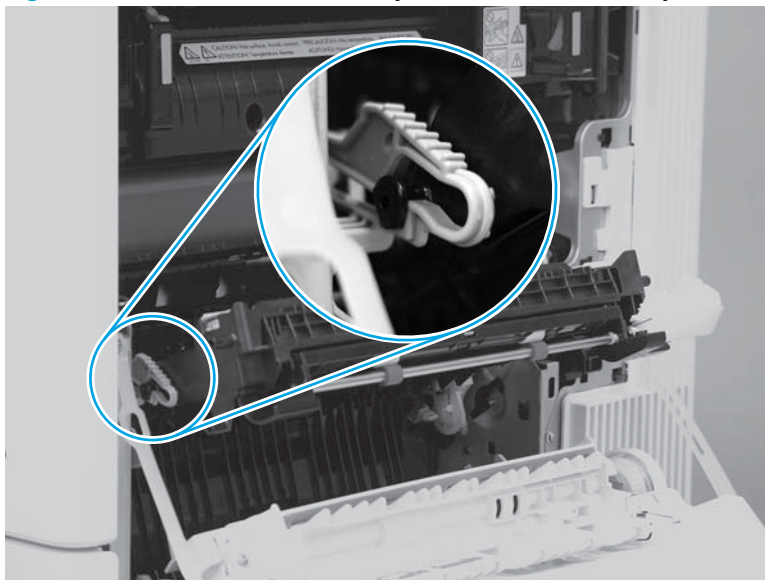

4. Continue to flex the blue arm until it disengages from the pin.

Figure 1-996 Disengage the blue arm and pin



5. Slide the assembly toward the front of the printer to release it (callout 1), and then rotate it down and away from the printer to remove it (callout 2).



 **Reinstallation tip:** Before removing the assembly, take note of where the assembly hinge pins fit into the holes provided in the printer.

Figure 1-997 Remove the secondary transfer roller assembly

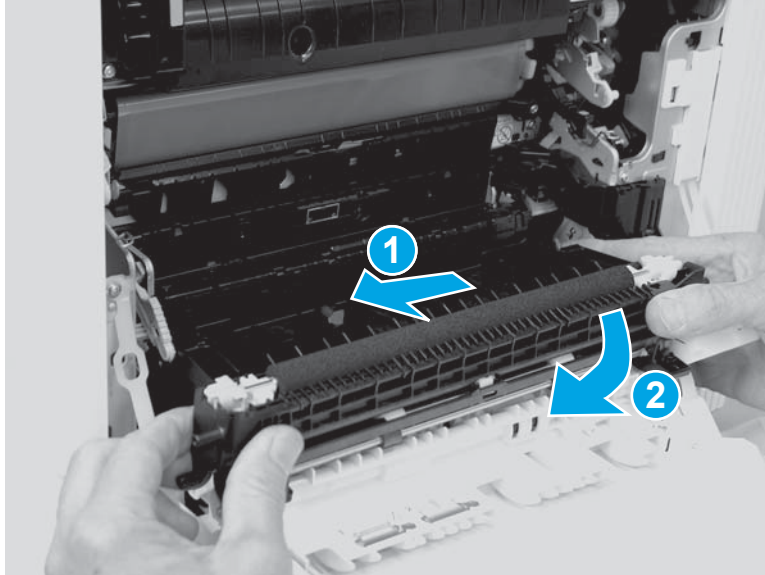

Step 2: Unpack the replacement assembly

Unpack the replacement assembly from the packaging.

 **CAUTION:** Skin oils on the roller can cause print-quality problems. Avoid touching the black spongy roller on the assembly.

For complete information on HP's recycling programs, go to [Product return and recycling](#).

 **NOTE:** HP recommends responsible disposal of the defective assembly.

Figure 1-998 Recycle and unpack

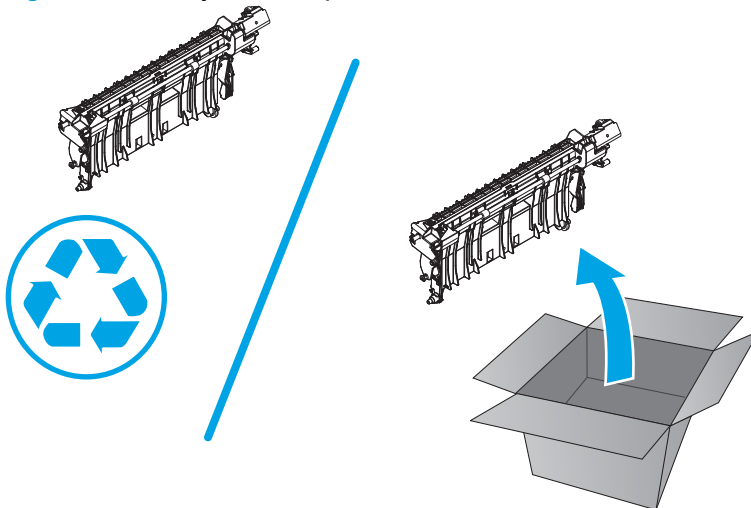

Step 3: Install the secondary transfer assembly

1. Move the registration sensor assembly (callout 1) out of the way, and then position the secondary transfer assembly right hinge (callout 2) into the hole provided in the printer.

Figure 1-999 Install the right hinge

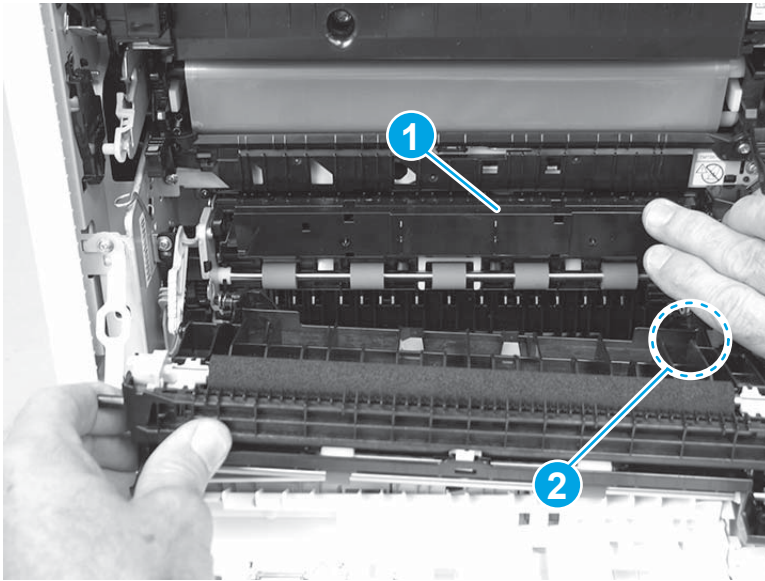

2. Position the assembly left-side hinge near the hole provided in the printer, and then slide the assembly toward the front of the printer to install the hinge in the hole.

Figure 1-1000 Install the left hinge

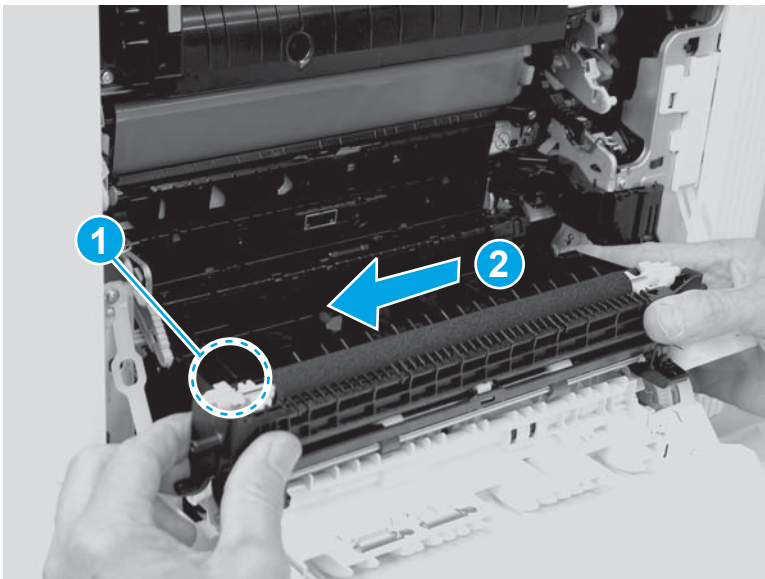

- Carefully flex the blue arm, and then push it over the pin on the assembly to engage it.



NOTE: Make sure that the pin is correctly installed in the slot on the blue arm.

Figure 1-1001 Engage the blue arm with the pin

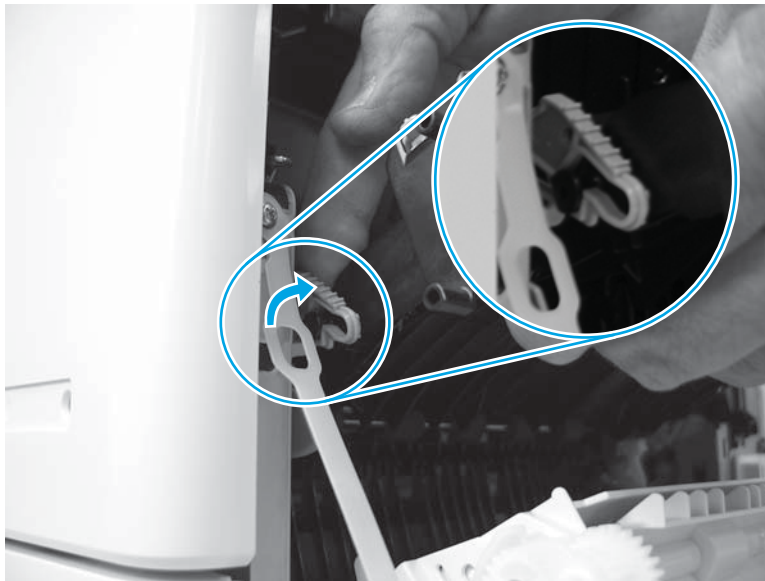

- Close the right door.



TIP: The right door should close easily if the secondary transfer assembly is correctly installed.

Figure 1-1002 Close the right door



Removal and replacement: Near field communication (NFC) PCA (M553x)

- [Introduction](#)
- [Step 1: Remove the USB cover](#)
- [Step 2: Remove the control panel \(M553x only\)](#)
- [Step 3: Remove the toner collection unit \(TCU\)](#)
- [Step 4: Remove the formatter cover](#)
- [Step 5: Remove the rear cover](#)
- [Step 6: Remove the left cover](#)
- [Step 7: Remove the upper cover](#)
- [Step 8: Remove the NFC PCA](#)
- [Step 9: Unpack the replacement assembly](#)
- [Step 10: Install the NFC PCA](#)
- [Step 11: Install the upper cover](#)
- [Step 12: Install the left cover](#)
- [Step 13: Install the rear cover](#)
- [Step 14: Install the formatter cover](#)
- [Step 15: Install the TCU](#)
- [Step 16: Install the control-panel assembly \(M553x only\)](#)
- [Step 17: Install the USB cover](#)

Introduction

This document provides the procedures to remove and replace the near field communication (NFC) printed circuit assembly (PCA).



Before performing service

Turn the printer power off

- Disconnect the power cable.

 **WARNING!** To avoid damage to the printer, turn the printer off, wait 30 seconds, and then remove the power cord before attempting to service the printer.

- Open the right door.

 **CAUTION:**  This part contains components that are electrostatic discharge (ESD) sensitive. To reduce the possibility of ESD damage, always touch the sheet-metal chassis to ground yourself before touching an ESD sensitive part.

Use the table below to identify the correct part number for your printer, and then go to <http://h20141.www2.hp.com/hpparts> to order the part.

NFC PCA part number	
B5L24-60002	NFC PCA

Required tools

- #2 Phillips screwdriver with a magnetic tip
- Small flat blade screwdriver

After performing service

Make sure that the USB cover is fully seated after replacing it.

Make sure that the TCU is fully closed after replacing it.

Make sure that the formatter cover is fully seated, and that the thumbscrews are finger tight after replacing it.

With the printer in the Ready state, send a print job using the NFC PCA.

Turn the printer power on

- Connect the power cable.
- Use the power switch to turn the power on.

Step 1: Remove the USB cover

1. Locate the USB cover.

Figure 1-1003 Locate the USB cover



2. Pull the cover off of the printer to remove it.

Figure 1-1004 Remove the cover



Step 2: Remove the control panel (M553x only)

 **NOTE:** For the M553n/dn and M552dn models, skip this step and go to [Step 3: Remove the toner collection unit \(TCU\) on page 592](#).

1. Tilt the control panel up.

Figure 1-1005 Tilt the control panel up



2. Use a small flat-blade screwdriver to release the control-panel screws cover tabs.

Figure 1-1006 Release the control-panel screws cover tabs



3. Rotate the cover up to remove it.

Figure 1-1007 Remove the cover

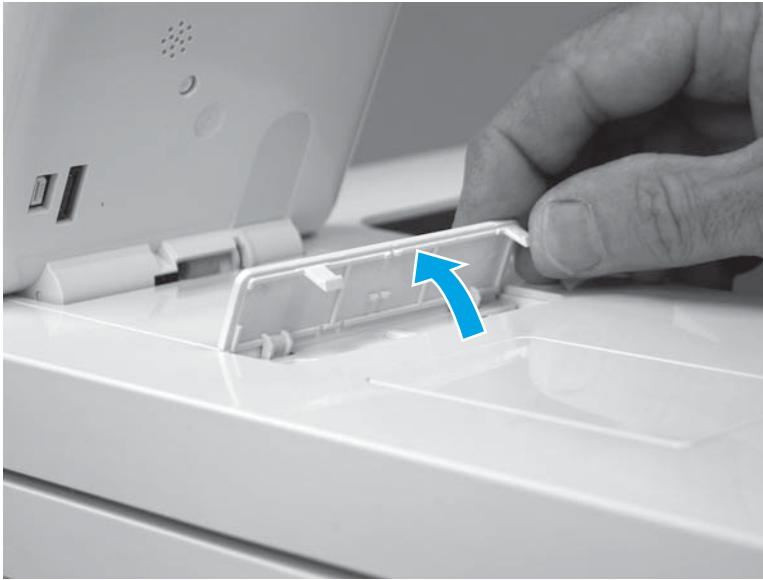

4. Use a small Phillips screwdriver to remove two screws (callout 1).

 **IMPORTANT:** Store the screws in a secure place where they cannot fall down into the printer.

Figure 1-1008 Remove two screws

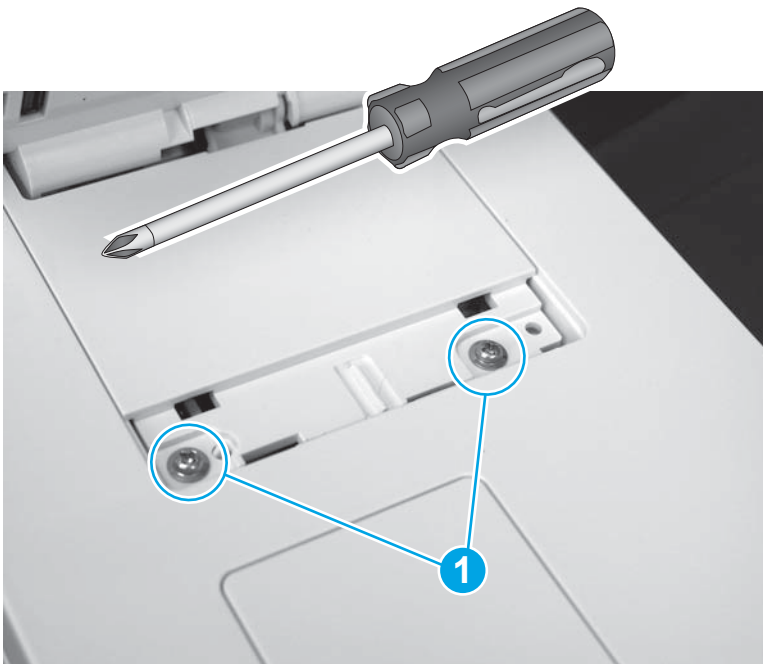

5. Rotate the control-panel base toward the front of the printer.

Figure 1-1009 Rotate the control-panel base up



6. Slightly slide the control-panel base toward the rear of the printer (callout 1) to release it, and then turn the control panel over (callout 2) to access the bottom side.

⚠ CAUTION: The control panel is still attached to the printer. Do not attempt to completely remove the control panel.

Figure 1-1010 Turn the control panel over

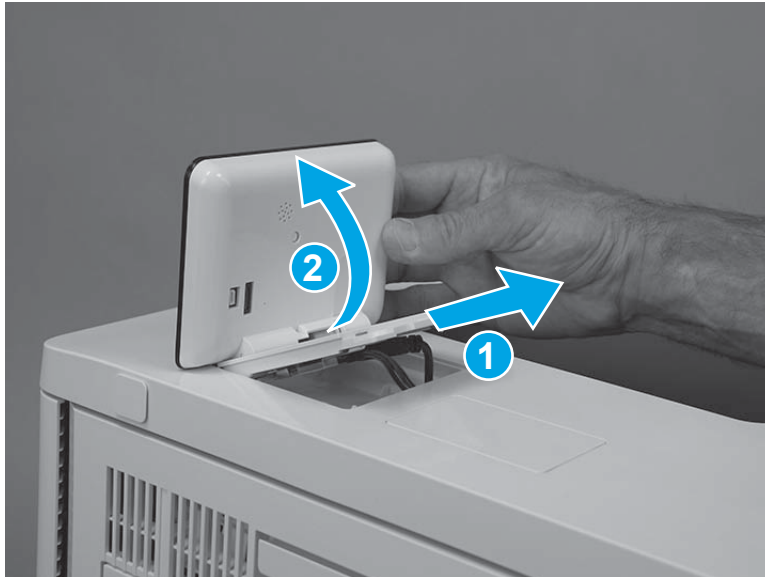

7. Disconnect one USB cable (callout 1), one connector (callout 2), and then remove the control panel.

Figure 1-1011 Disconnect two connectors

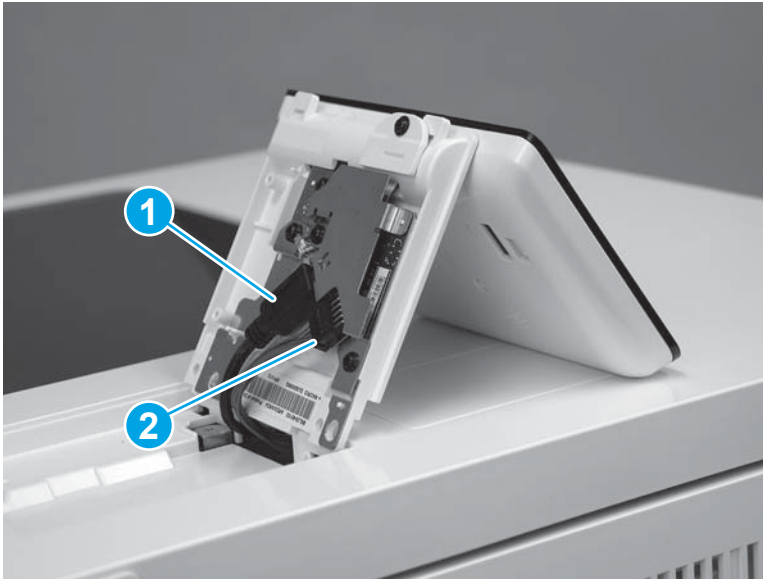

Step 3: Remove the toner collection unit (TCU)

1. Open the front door.

Figure 1-1012 Open the front door



2. Open the TCU.



NOTE: The toner collection hatch cover automatically closes when the TCU is opened.

Figure 1-1013 Open the TCU



3. Pull the TCU away from the printer at an angle to remove it.

⚠ CAUTION: Do not open the toner collection hatch cover when handling the TCU. If toner gets on clothing, wipe it off by using a dry cloth and wash the clothes in cold water. Hot water sets toner into fabric.

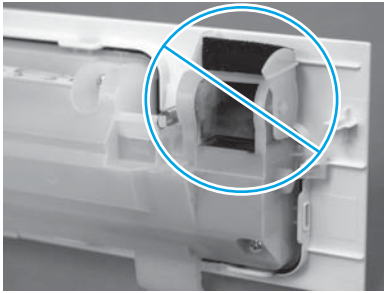
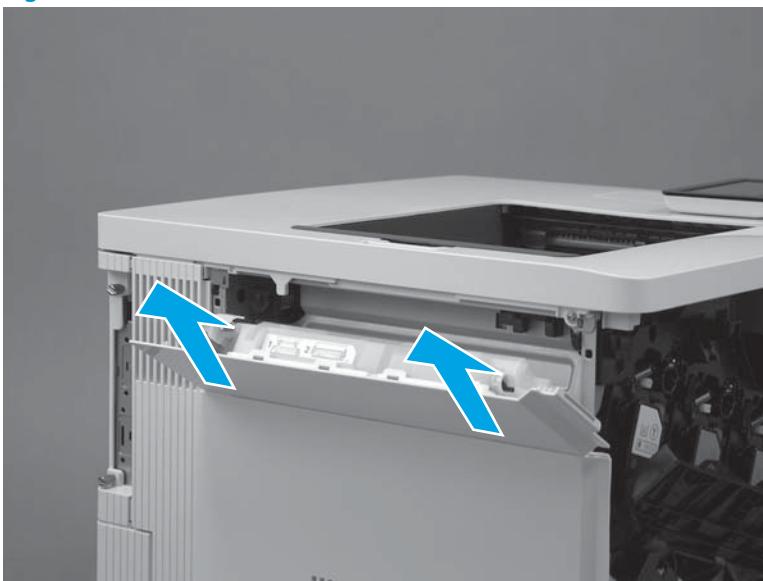

Figure 1-1014 Remove the TCU



Step 4: Remove the formatter cover

1. Locate the formatter cover.

Figure 1-1015 Locate the formatter cover

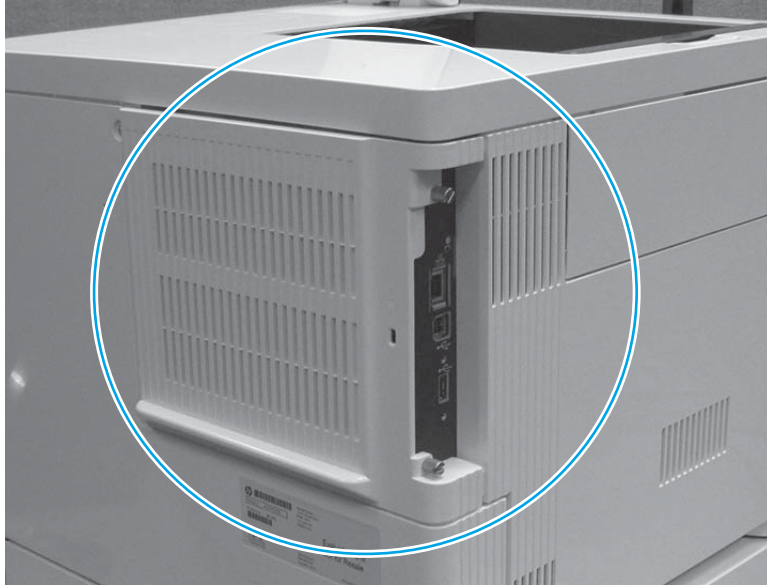

2. Loosen the two thumbscrews (callout 1). Grasp the two thumbscrews, and then slide the cover away from the printer (callout 2) to remove it.

 **TIP:** If needed, use the edge of a coin to turn the thumbscrews.

Figure 1-1016 Loosen the thumbscrews



Step 5: Remove the rear cover

1. Remove four screws (callout 1).

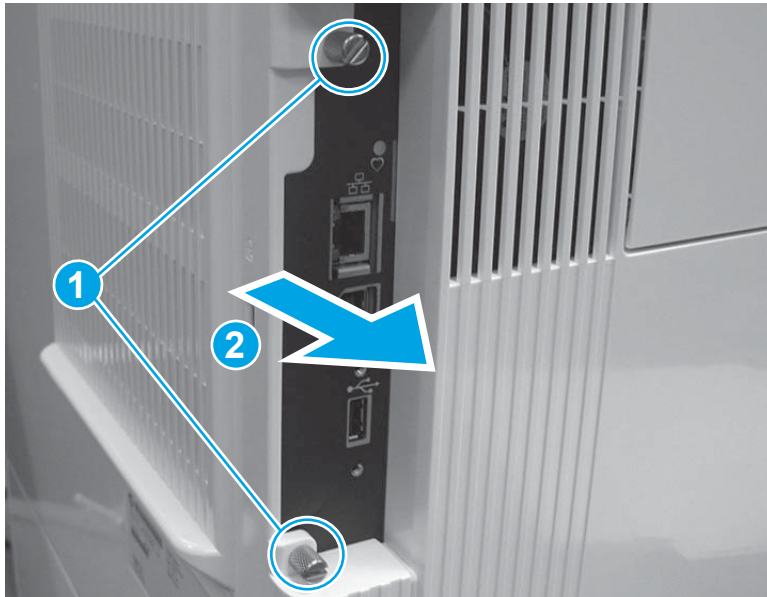
Figure 1-1017 Remove four screws

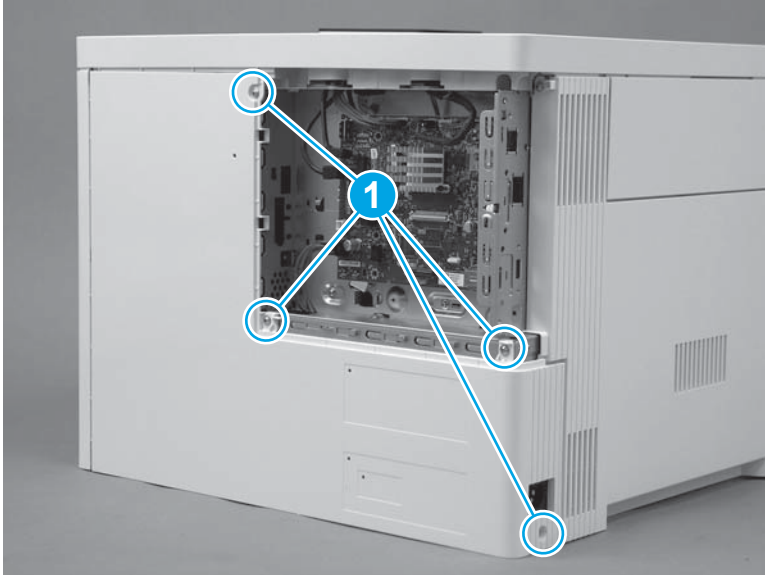

2. Slightly slide the cover to the right (callout 1), rotate the bottom of the cover away from the printer (callout 2), and then pull the top of the cover away from the printer (callout 3) to remove the cover.

Figure 1-1018 Remove the cover

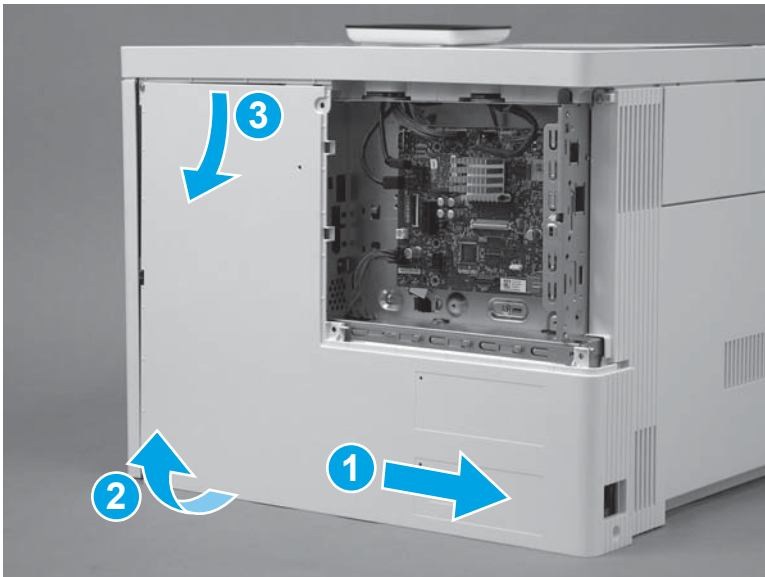

Step 6: Remove the left cover

1. At the left side of the printer, remove one screw (callout 1).

Figure 1-1019 Remove one screw



2. Release one tab (callout 1), rotate the front edge of the cover away from the printer (callout 2), and then slide the cover (callout 3) toward the rear of the printer to release it.

Figure 1-1020 Release the cover

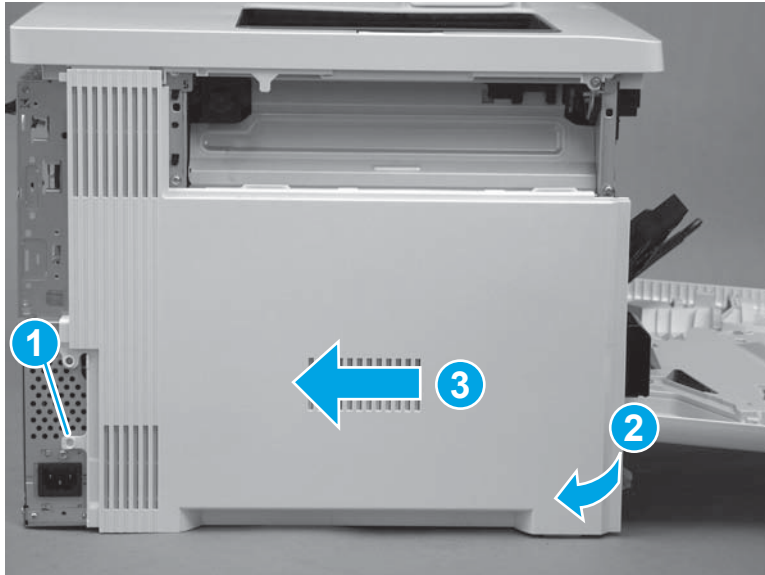

3. Remove the cover.

Figure 1-1021 Remove the cover

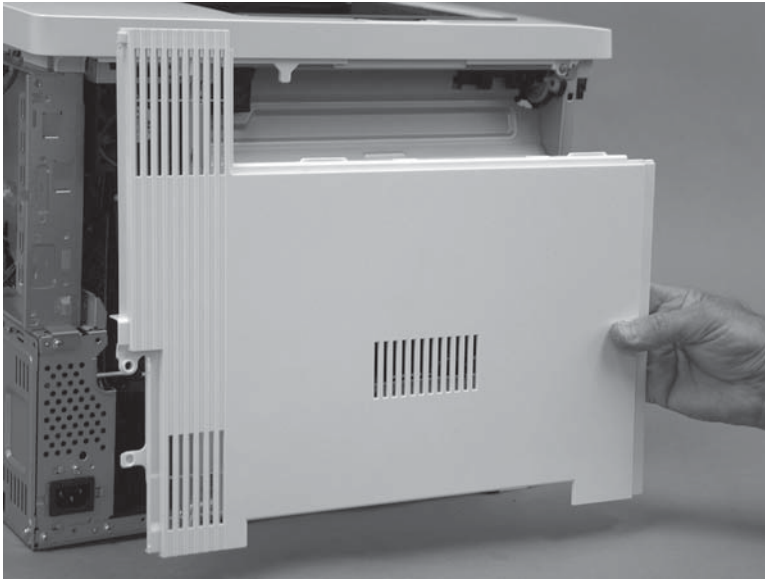

Step 7: Remove the upper cover

1. Remove three screws (callout 1).

Figure 1-1022 Remove three screws

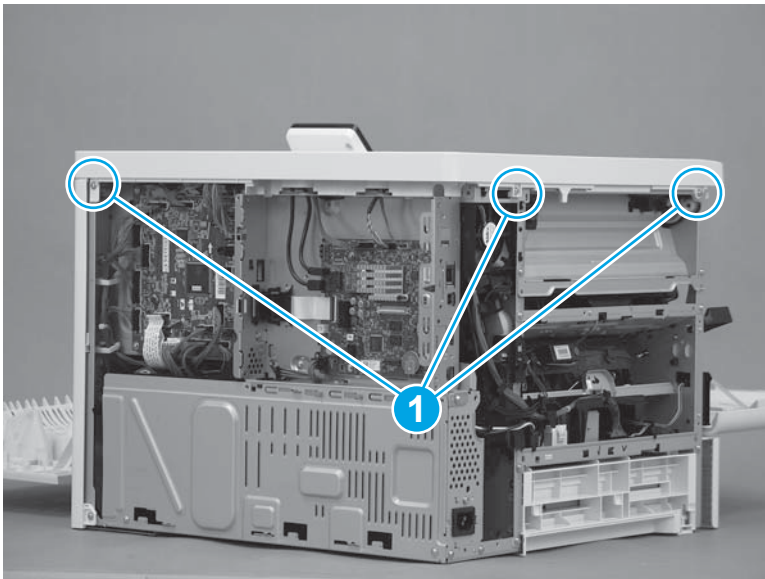

2. Remove one screw (callout 1), release one tab (callout 2), and then slightly separate the corner of the cover from the chassis.

 **NOTE:** This is a self-tapping plastic-thread screw. Make sure that this screw is used in this location when it is reinstalled.

Figure 1-1023 Remove one screw and release one tab



3. Release one tab (callout 1), and then lift up on the cover to release it.

 **NOTE:** If the cover does not release, check for additional tabs by locating the triangles embossed in the cover at tab locations.

Figure 1-1024 Release the cover



4. Remove the cover.

Figure 1-1025 Remove the cover

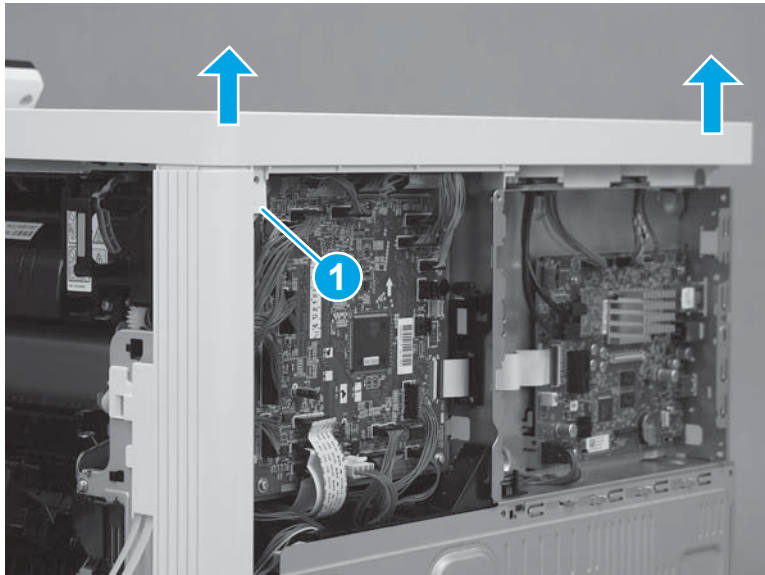
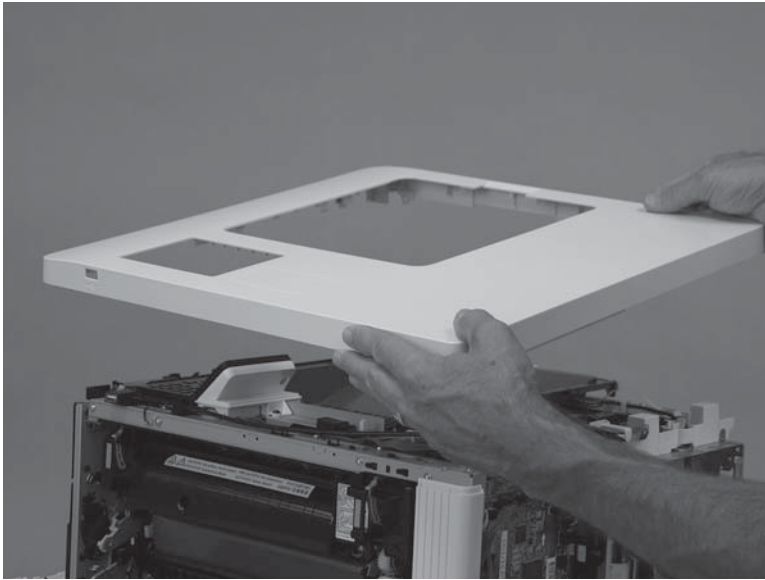

Step 8: Remove the NFC PCA

- ▲ Disconnect one connector (callout 1), release two tabs (callout 2), and then remove the NFC PCA (callout 3).

Figure 1-1026 Remove the NFC PCA

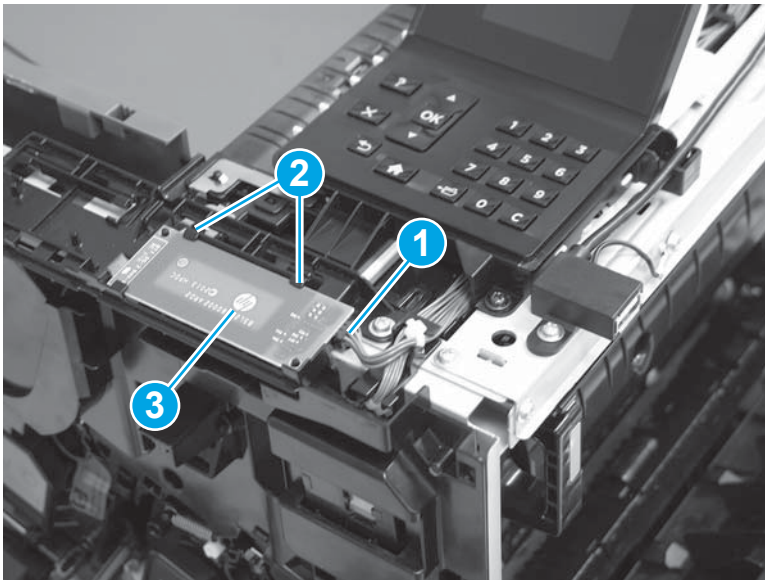

Step 9: Unpack the replacement assembly

Unpack the replacement assembly from the packaging.

For complete information on HP's recycling programs, go to [Product return and recycling](#).

 **CAUTION:**  ESD-sensitive part.

 **NOTE:** HP recommends responsible disposal of the defective assembly.

Figure 1-1027 Recycle and unpack

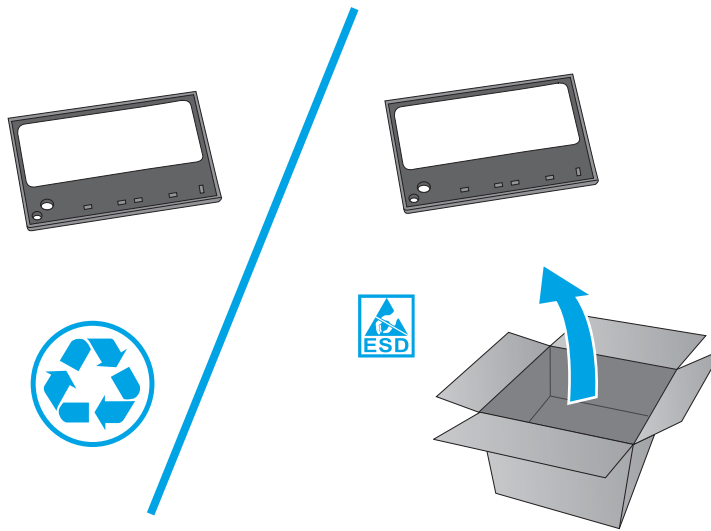

Step 10: Install the NFC PCA

- ▲ Position the NFC PCA (callout 1) on the printer, connect one connector (callout 2), and then make sure the two tabs (callout 3) are firmly holding the PCA in the holder.

Figure 1-1028 Install the NFC PCA

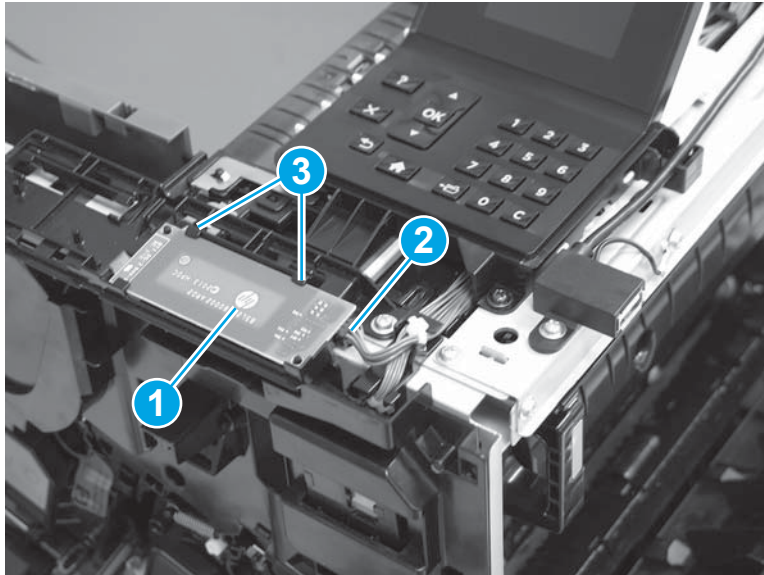

Step 11: Install the upper cover

1. Position the cover on the printer.

 **NOTE:** For the M553x model, do not forget to pass the control-panel wire harness and USB cable through the opening in the cover.

Figure 1-1029 Install the cover



2. Push down on the rear corner of the cover to engage one tab (callout 1).

Figure 1-1030 Engage one tab

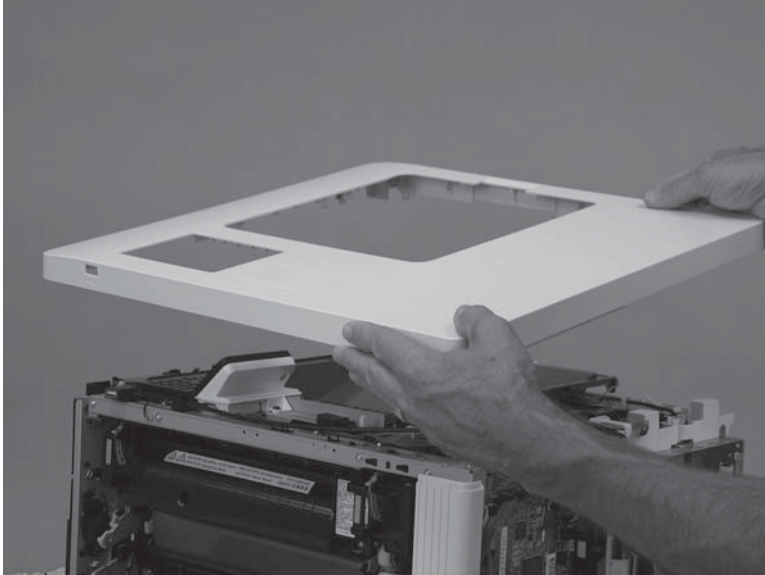
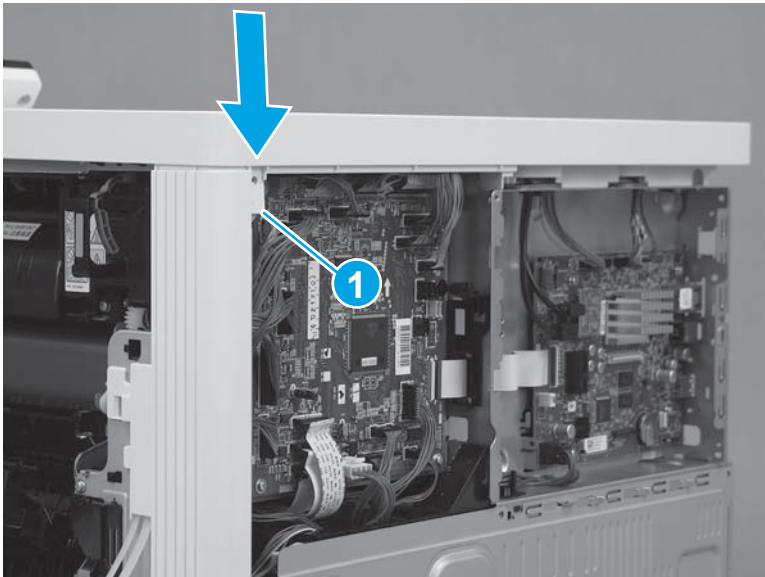

3. Push down on the front corner of the cover to engage one tab (callout 1), and then install one screw (callout 2).

 **NOTE:** This is a self-tapping plastic-thread screw. Make sure that this screw is used in this location when it is reinstalled.

Figure 1-1031 Engage one tab and install one screw



4. Install three screws (callout 1).

Figure 1-1032 Install three screws

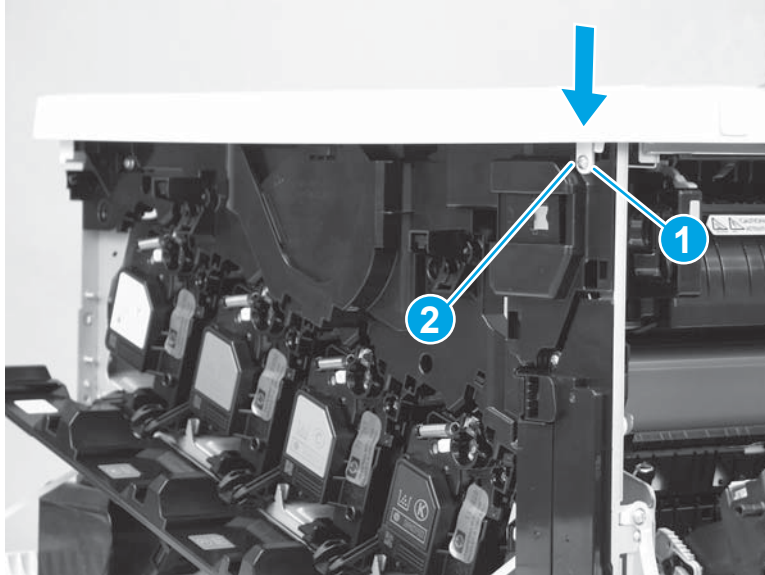
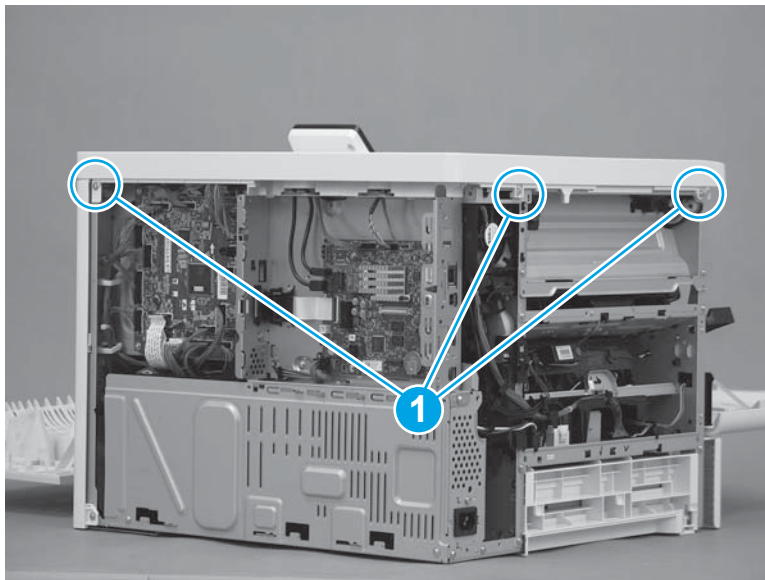

Step 12: Install the left cover

1. Position the cover on the printer.

 **NOTE:** Slightly offset the cover toward the rear of the printer.

Figure 1-1033 Install the cover

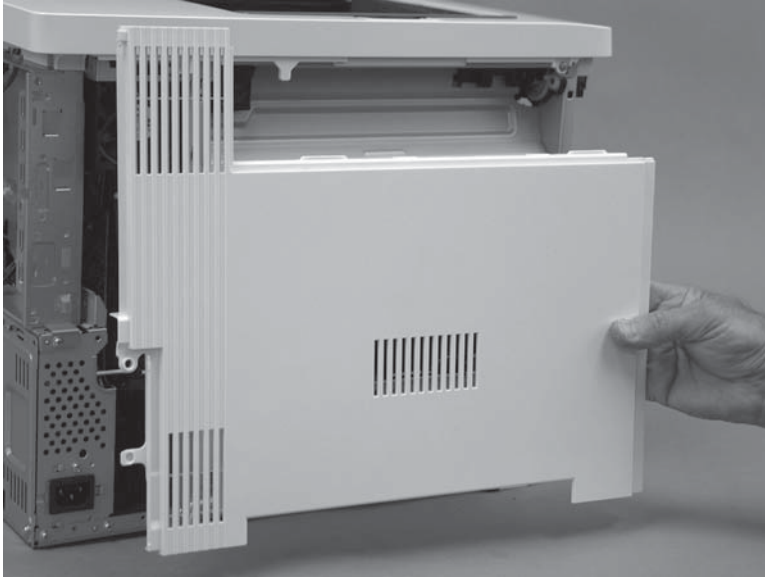

2. Slide the cover (callout 1) toward the front of the printer to engage it. Make sure that the tab (callout 2) snaps into place.

 **NOTE:** Locate the alignment pin (callout 3) on the cover from the front door side of the printer, and then make sure that it is fully engaged in the slot in the chassis.

 **TIP:** While sliding the cover into place, push in on the center of the cover (callout 1) to make sure that the hooks on the back of the cover engage with the slots in the chassis.

Figure 1-1034 Engage the cover



3. At the left side of the printer, install one screw (callout 1).

Figure 1-1035 Install one screw

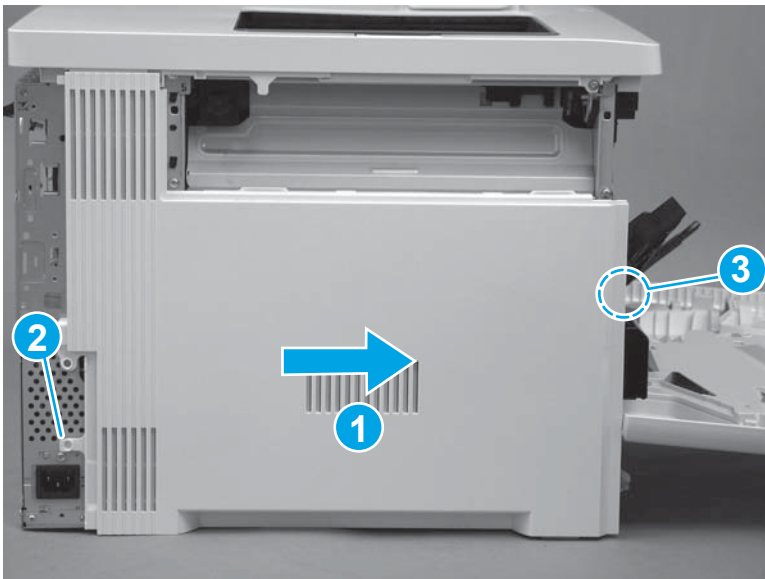

Step 13: Install the rear cover

1. Position the top of the cover under the upper cover (callout 1), rotate the bottom of the cover onto the chassis (callout 2), and then slide the cover to the left (callout 3) to install it.

Figure 1-1036 Install the cover

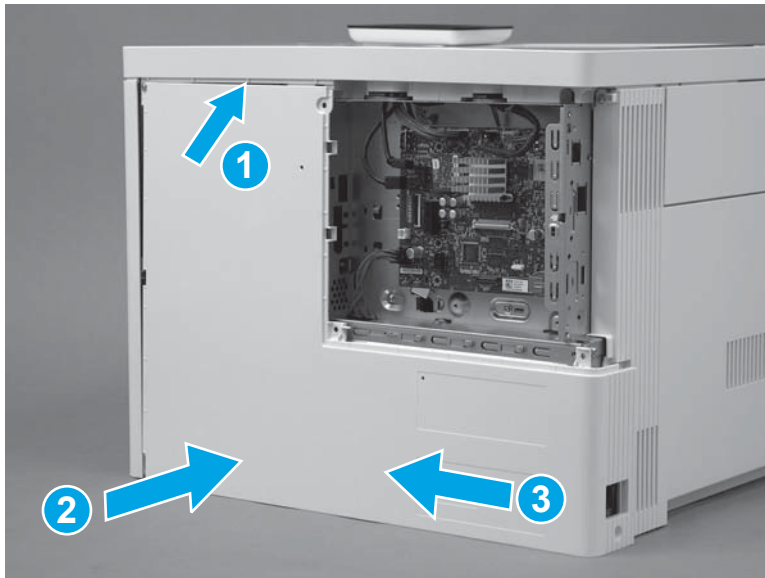

2. Install four screws (callout 1).

Figure 1-1037 Install four screws cover

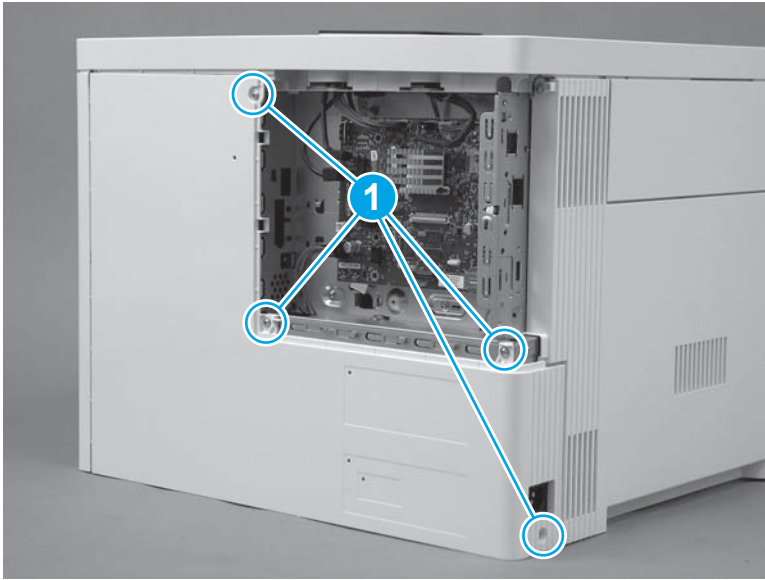

Step 14: Install the formatter cover

- ▲ Slide the cover onto the printer (callout 1) to install it.

 **NOTE:** Make sure that the tabs on the formatter cover align with the slots provided in the printer (callout 2). Tighten the two thumbscrews (callout 3).

 **TIP:** If needed, use the edge of a coin to turn the thumbscrews.

Figure 1-1038 Install the cover



Step 15: Install the TCU

1. Verify that the toner collection hatch cover is in the closed position on the TCU.

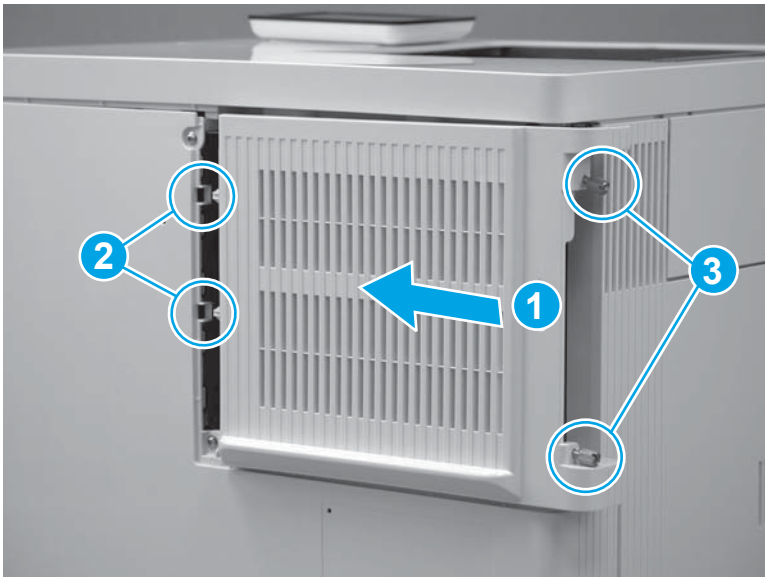
Figure 1-1039 Verify that the toner collection hatch cover is closed

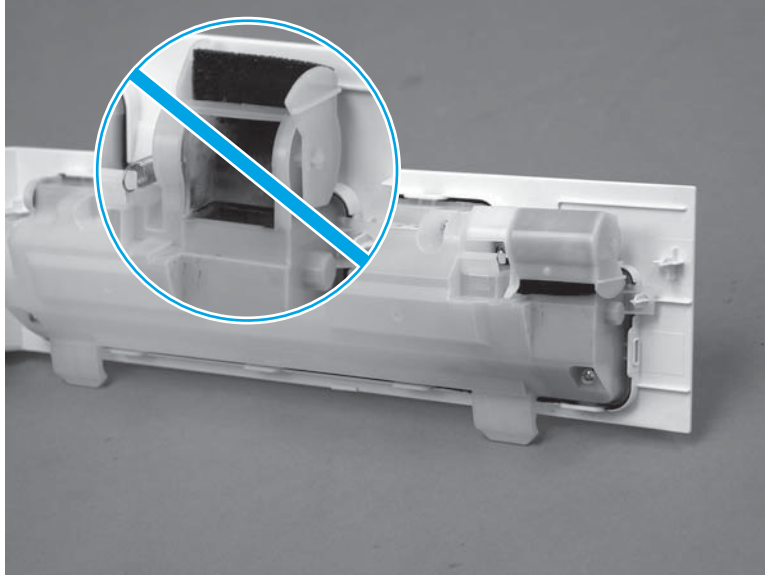

2. Position the TCU with the hinges in the slots provided in the printer (callout 1), and then rotate the TCU up and into the closed position.

 **NOTE:** The toner collection hatch cover automatically opens when the TCU is closed.

Figure 1-1040 Install the TCU



3. Close the front door.

Figure 1-1041 Close the front door

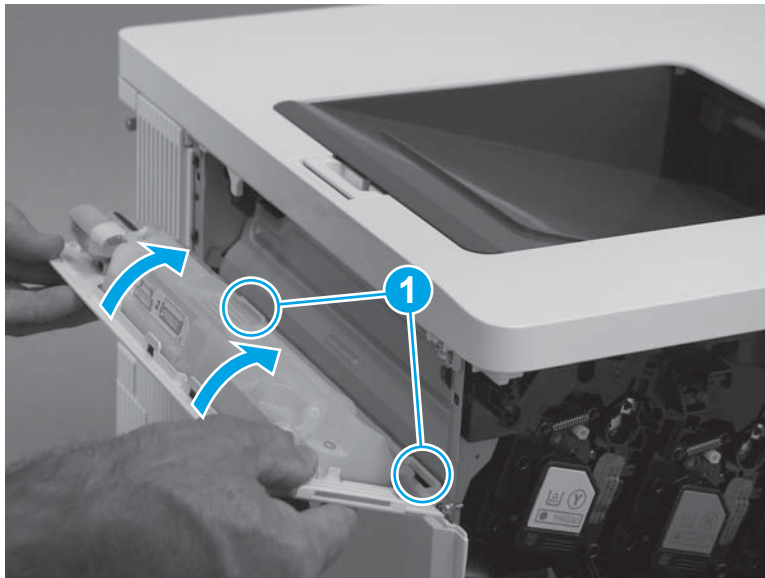

Step 16: Install the control-panel assembly (M553x only)



NOTE: For the M553n/dn and M552dn models, skip this step and go to [Step 17: Install the USB cover on page 611](#).

1. Place the control panel on the printer as shown.

Figure 1-1042 Place the control panel on the product

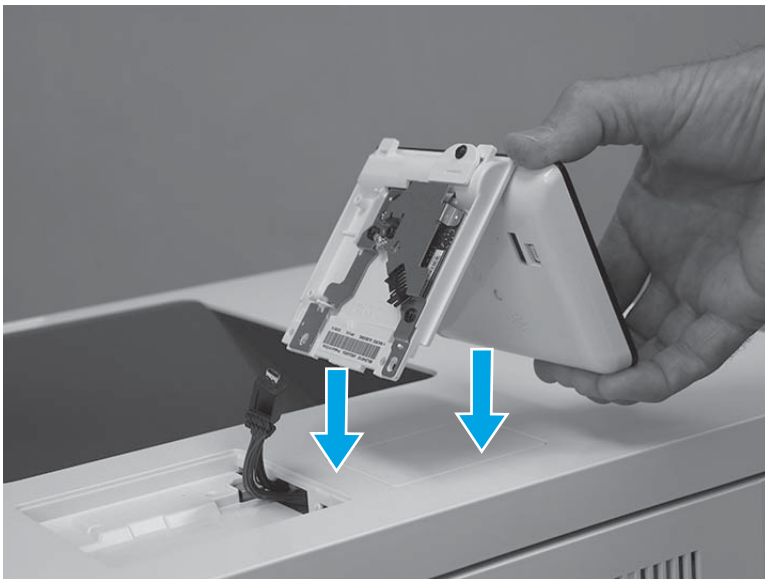

2. Connect one USB cable (callout 1), and one connector (callout 2).

 **IMPORTANT:** Take note of the location of the two mounting tabs (callout 3) on the control-panel assembly.

Figure 1-1043 Connect two connectors



3. Turn the control panel over, and then position the front edge tabs in the slots in the top cover.

Figure 1-1044 Turn the control panel over

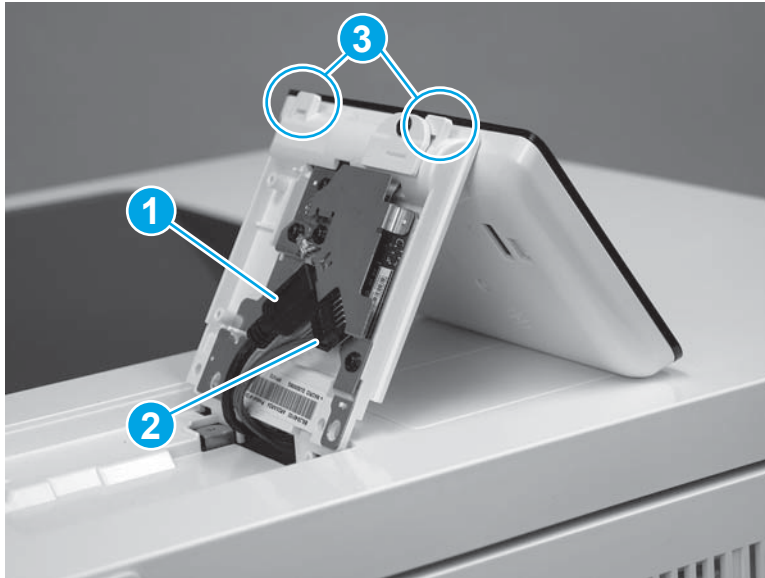
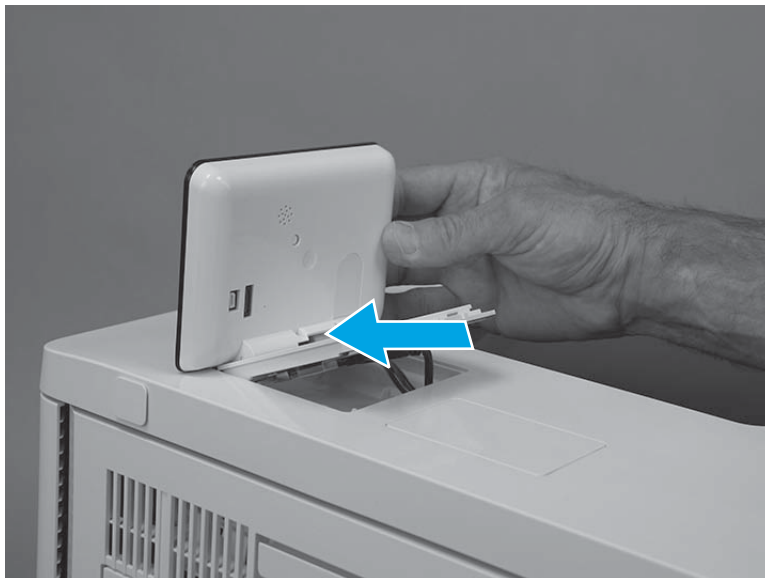

4. Rotate the control-panel base down onto the printer.

Figure 1-1045 Rotate the control-panel base down



5. Use a small Phillips screwdriver to install two screws (callout 1).

Figure 1-1046 Install two screws

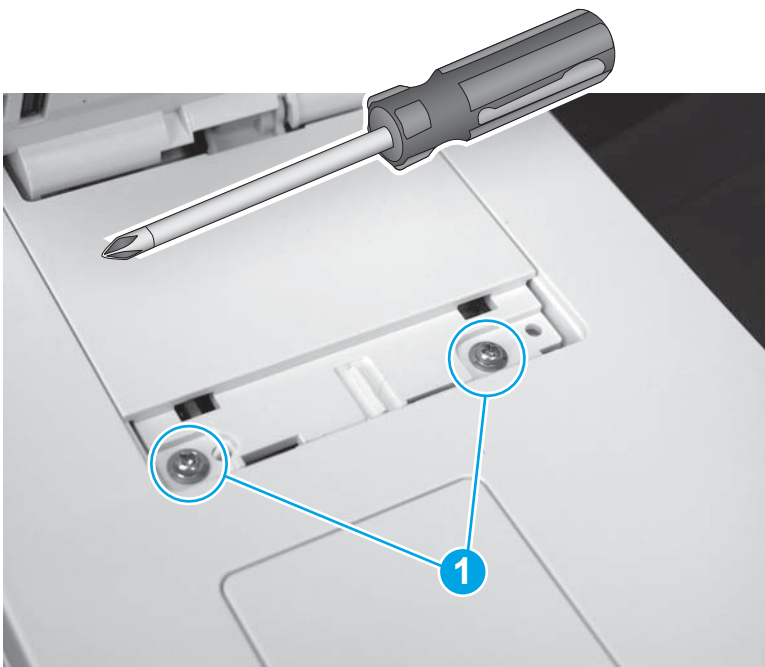

6. Position the screw cover mounting feet into the slots in the top cover (callout 1), and then rotate the cover down (callout 2) to install it.

 **NOTE:** Press down on the cover firmly to make sure that the tabs on the cover (callout 3) snap into place.

Figure 1-1047 Install the cover



Step 17: Install the USB cover

1. Push the cover into the USB port to install it.

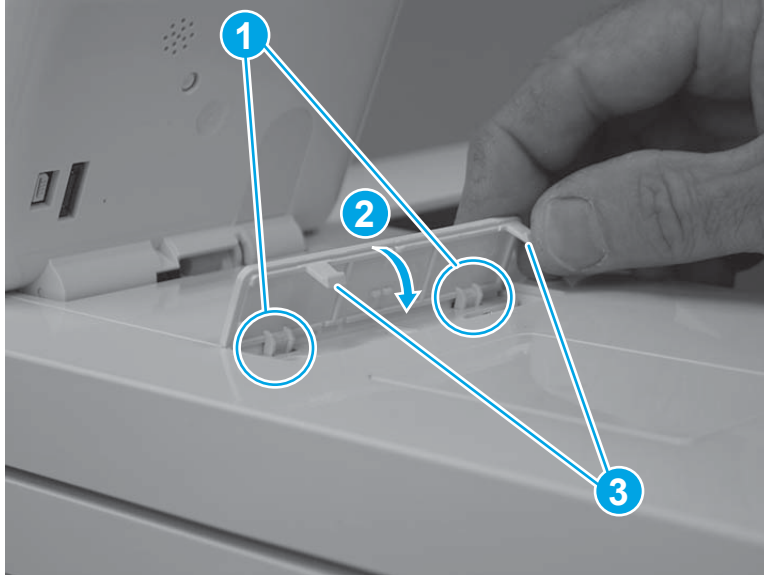
Figure 1-1048 Install the cover



2. Make sure that the USB cover is fully seated after installing it.

Figure 1-1049 Check the installation

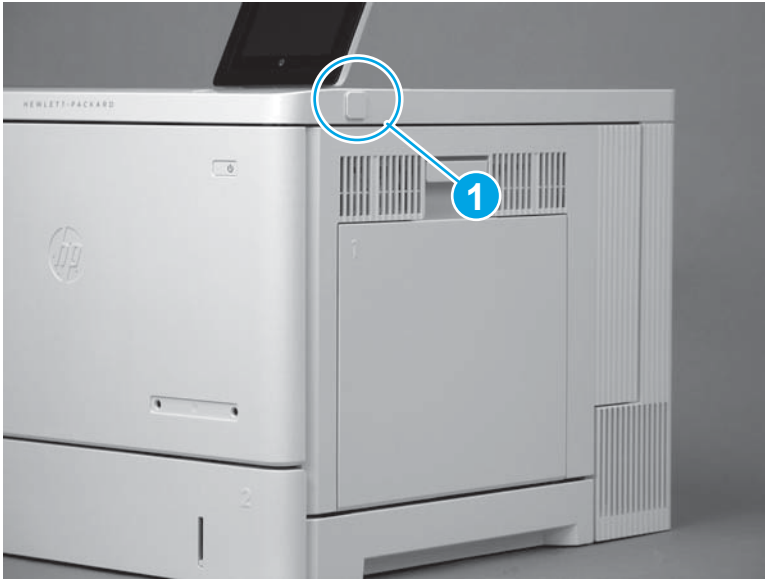

Removal and replacement: Near field communication (NFC) PCA (M577z)

- [Introduction](#)
- [Step 1: Remove the NFC](#)
- [Step 2: Unpack the replacement assembly](#)
- [Step 3: Install the NFC PCA](#)

Introduction

This document provides the procedures to remove and replace the NFC PCA for the M577.

Before performing service

Turn the printer power off

- Disconnect the power cable.

 **WARNING!** To avoid damage to the printer, turn the printer off, wait 30 seconds, and then remove the power cord before attempting to service the printer.

Use the table below to identify the correct part number for your printer. To order the part, go to www.hp.com/buy/parts.

NFC PCA part number	
B5L24-60001	NFC PCA

Required tools

- No special tools are required to replace this part.

After performing service

Turn the printer power on

- Connect the power cable.
- Use the power switch to turn the power on.

Post service test

Print a configuration page to make sure that the printer is functioning correctly.

Step 1: Remove the NFC

1. Open the document feeder (callout 1).

 **NOTE:** If the control panel is not fully tilted forward, tilt it forward now until it stops (callout 2).

Figure 1-1050 Open the document feeder



2. Beginning at the right side of the control-panel cover, carefully release five tabs along the top edge of the cover.

Figure 1-1051 Release five tabs

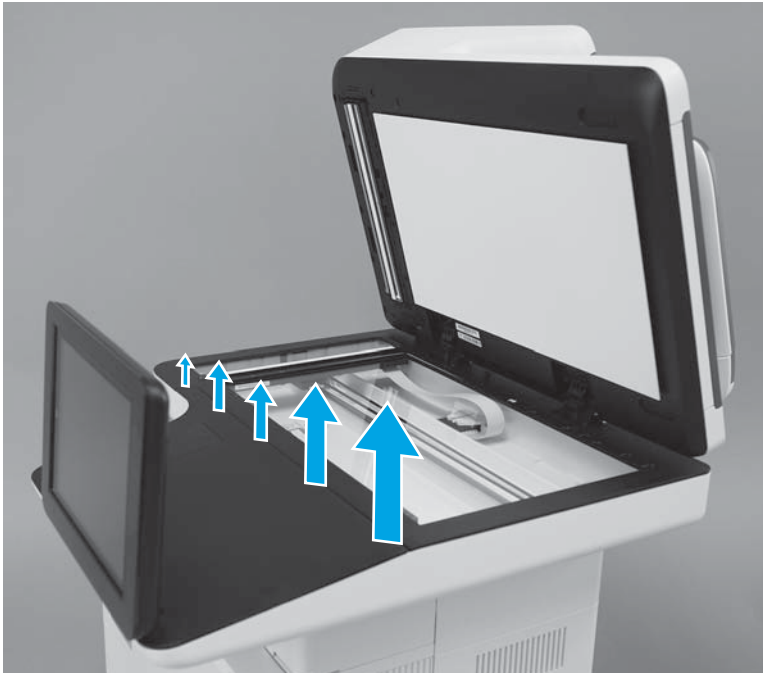

3. Continue to rotate the top edge of the cover away from the printer, and then remove the cover.

Figure 1-1052 Remove the cover



4. Locate the NFC.

Figure 1-1053 Locate the NFC



5. Release four tabs (callout 1).

Figure 1-1054 Release four tabs

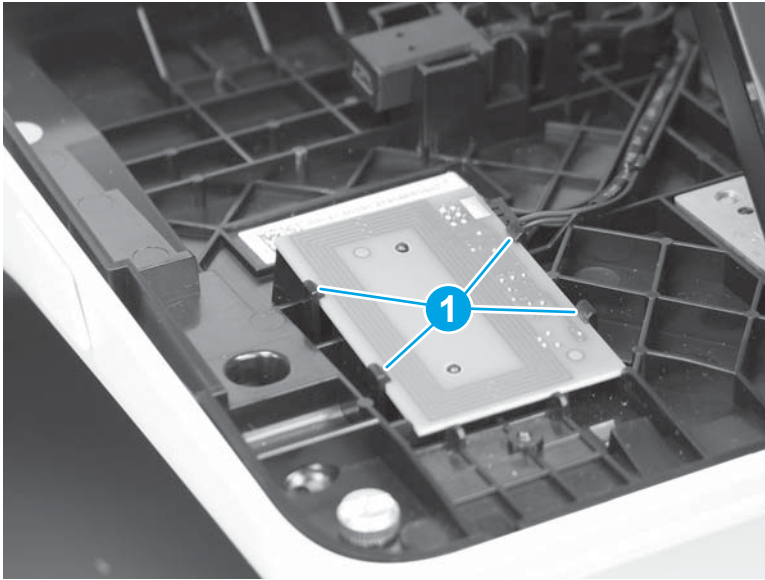

6. Lift the NFC PCA up, and then disconnect one connector (callout 1).

Figure 1-1055 Disconnect one connector

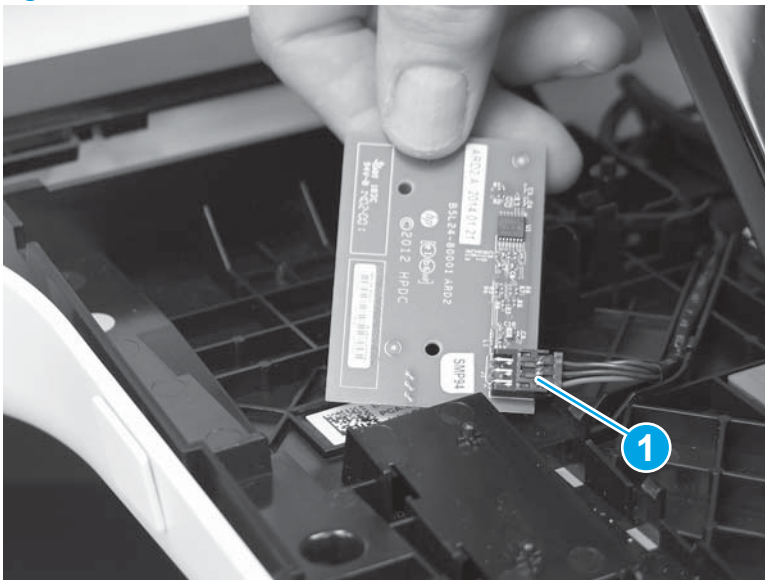

Step 2: Unpack the replacement assembly

Unpack the replacement assembly from the packaging.

For complete information on HP's recycling programs, go to [Product return and recycling](#).



NOTE: HP recommends responsible disposal of the defective part.

Figure 1-1056 Recycle and unpack

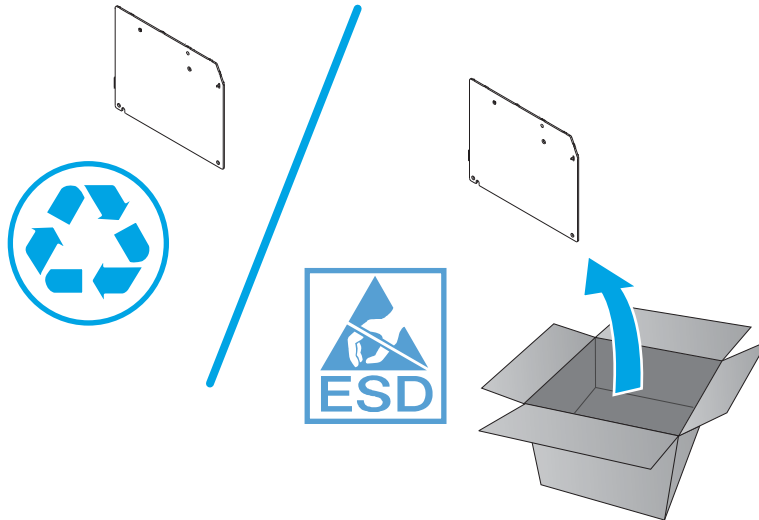

Step 3: Install the NFC PCA

1. Connect one connector (callout 1).

Figure 1-1057 Connect one connector

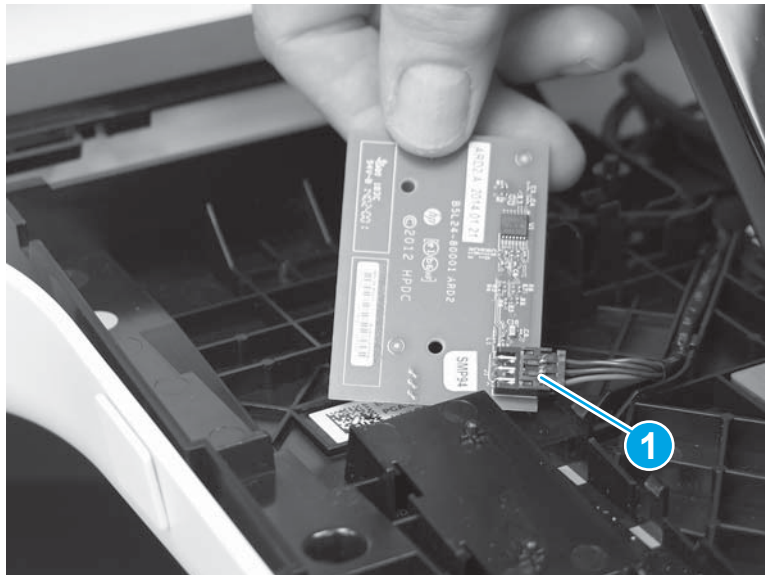

2. Position the holes in the NFC PCA (callout 1) over the posts (callout 2) on the printer.

Figure 1-1058 Position the NFC PCA

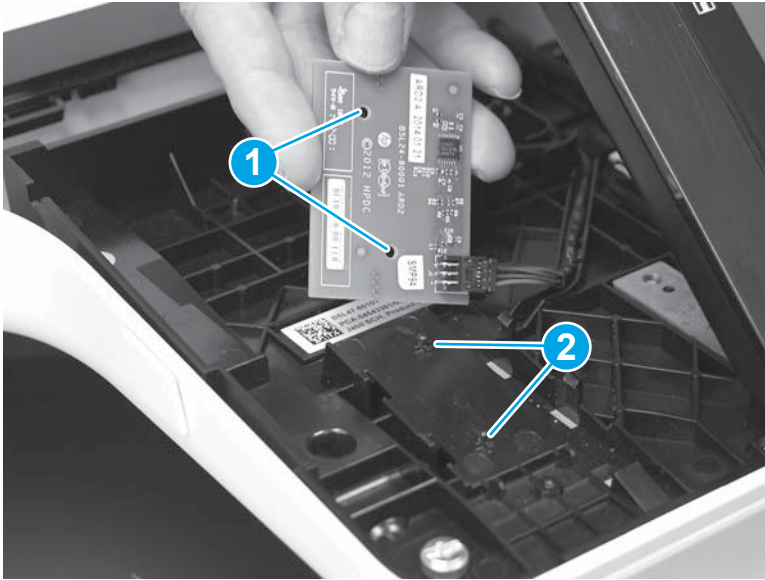

3. Install four tabs (callout 1) around the NFC PCA.

Figure 1-1059 Install four tabs

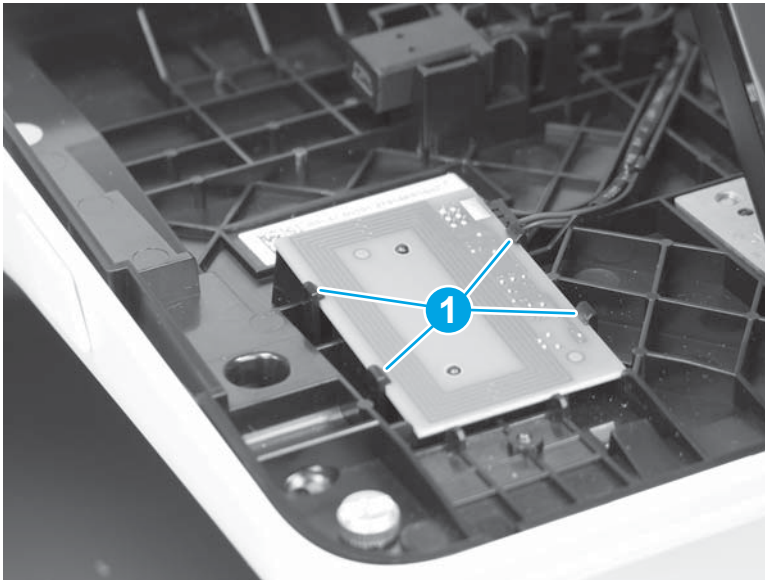

4. Position the control-panel cover on the printer.

Figure 1-1060 Position the control-panel cover on the printer



5. Beginning at the left side of the control-panel cover, carefully engage five tabs along the top edge of the cover.

Figure 1-1061 Engage five tabs

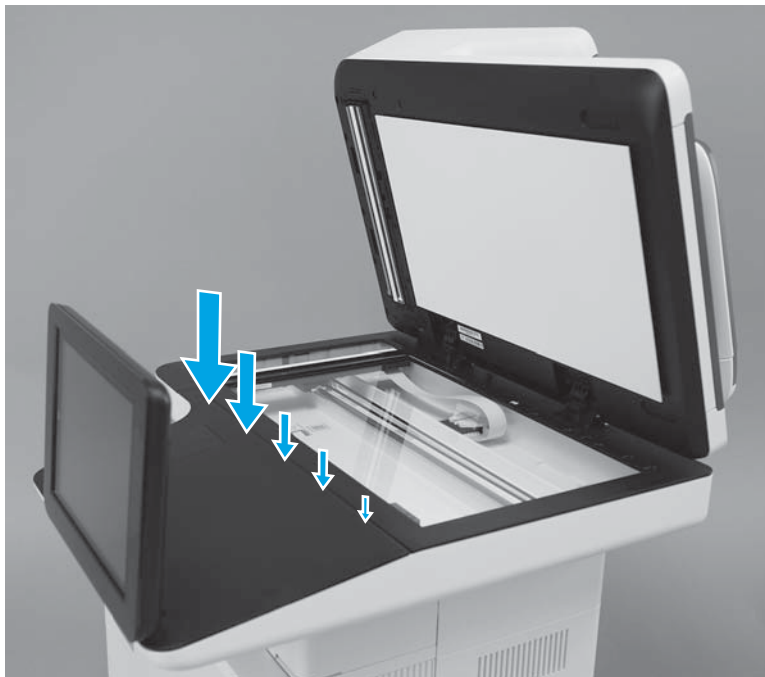

6. Close the document feeder.

 **NOTE:** Adjust the control panel to the desired angle.

Figure 1-1062 Close the document feeder



Removal and replacement: Wireless PCA (M553 and M577)

- [Introduction](#)
- [Step 1: Remove the formatter cover](#)
- [Step 2: Remove the toner collection unit \(TCU\)](#)
- [Step 3: Remove the USB cover \(M553\)](#)
- [Step 4: Remove the control panel \(M553x only\)](#)
- [Step 5: Remove the rear cover \(M553\)](#)
- [Step 6: Remove the left cover \(M553\)](#)
- [Step 7: Remove the upper cover \(M553\)](#)
- [Step 8: Remove the rear upper cover \(M577\)](#)
- [Step 9: Remove the left upper cover \(M577\)](#)
- [Step 10: Remove the right front upper cover \(M577dn\)](#)
- [Step 11: Remove the stapler cover assembly \(M577c/f/z\)](#)
- [Step 12: Remove the integrated scanner assembly \(M577\)](#)
- [Step 13: Remove the stapler unit \(M577f and M577z\)](#)
- [Step 14: Remove the right upper cover \(M577\)](#)
- [Step 15: Remove the top rear cover \(M577\)](#)
- [Step 16: Remove the paper feed cover \(M577\)](#)
- [Step 17: Remove the top cover \(M577\)](#)
- [Step 18: Remove the output bin](#)
- [Step 19: Remove the wireless PCA \(M553 and M577\)](#)
- [Step 20: Unpack the replacement assembly](#)
- [Step 21: Install the wireless PCA \(M553 and M577\)](#)
- [Step 22: Install the output bin](#)
- [Step 23: Install the top cover \(M577\)](#)
- [Step 24: Install the paper feed cover \(M577\)](#)
- [Step 25: Install the top rear cover \(M577\)](#)
- [Step 26: Install the right upper cover \(M577\)](#)
- [Step 27: Install the stapler unit \(M577f and M577z\)](#)
- [Step 28: Install the integrated scanner assembly \(M577\)](#)
- [Step 29: Install the stapler cover assembly \(M577c/f/z\)](#)

- [Step 30: Install the right front upper cover \(M577dn\)](#)
- [Step 31: Install the left upper cover \(M577\)](#)
- [Step 32: Install the rear upper cover \(M577\)](#)
- [Step 33: Install the upper cover \(M553\)](#)
- [Step 34: Install the left cover \(M553\)](#)
- [Step 35: Install the rear cover \(M553\)](#)
- [Step 36: Install the control-panel \(M553x only\)](#)
- [Step 37: Install the USB cover \(M553\)](#)
- [Step 38: Install the TCU](#)
- [Step 39: Install the formatter cover](#)

Introduction

This document provides the procedures to remove and replace the wireless printed circuit assembly (PCA).



Before performing service

Turn the printer power off

- Disconnect the power cable.

 **WARNING!** To avoid damage to the printer, turn the printer off, wait 30 seconds, and then remove the power cord before attempting to service the printer.

- Open the right door.

 **CAUTION:**  This part contains components that are electrostatic discharge (ESD) sensitive. To reduce the possibility of ESD damage, always touch the sheet-metal chassis to ground yourself before touching an ESD sensitive part.

Use the table below to identify the correct part number for your printer, and then go to <http://h20141.www2.hp.com/hpparts> to order the part.

Upper cover part number	
1150-7968	Wireless PCA

Required tools

- #2 Phillips screwdriver with a magnetic tip
- Small flat blade screwdriver

After performing service

Make sure that the USB cover is fully seated after replacing it.

Make sure that the TCU is fully closed after replacing it.

Make sure that the formatter cover is fully seated, and that the thumbscrews are finger tight after replacing it.

With the printer in the Ready state, send a print job using the wireless PCA.

Turn the printer power on

- Connect the power cable.
- Use the power switch to turn the power on.

Step 1: Remove the formatter cover

1. Locate the formatter cover.

Figure 1-1063 Locate the formatter cover

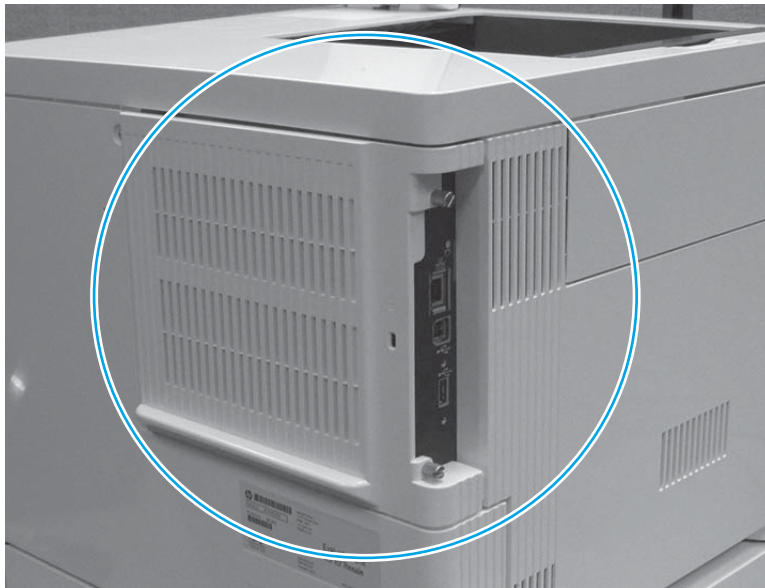

2. Loosen the two thumbscrews (callout 1). Grasp the two thumbscrews, and then slide the cover away from the printer (callout 2) to remove it.

 **TIP:** If needed, use the edge of a coin to turn the thumbscrews.

Figure 1-1064 Loosen the thumbscrews



Step 2: Remove the toner collection unit (TCU)

1. Open the front door.

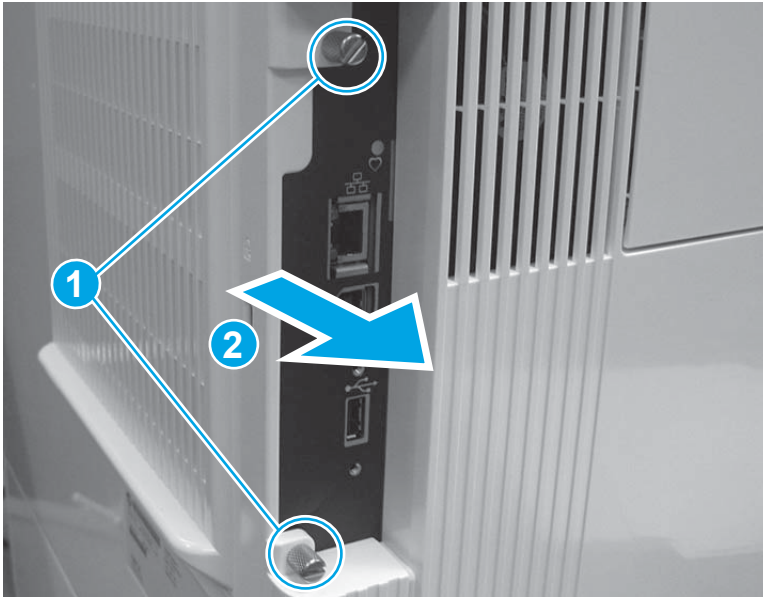
Figure 1-1065 Open the front door



2. Open the TCU.



NOTE: The toner collection hatch cover automatically closes when the TCU is opened.

Figure 1-1066 Open the TCU



3. Pull the TCU away from the printer at an angle to remove it.

⚠ CAUTION: Do not open the toner collection hatch cover when handling the TCU. If toner gets on clothing, wipe it off by using a dry cloth and wash the clothes in cold water. Hot water sets toner into fabric.

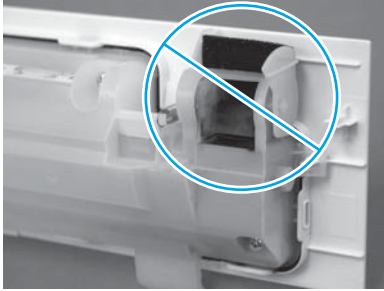
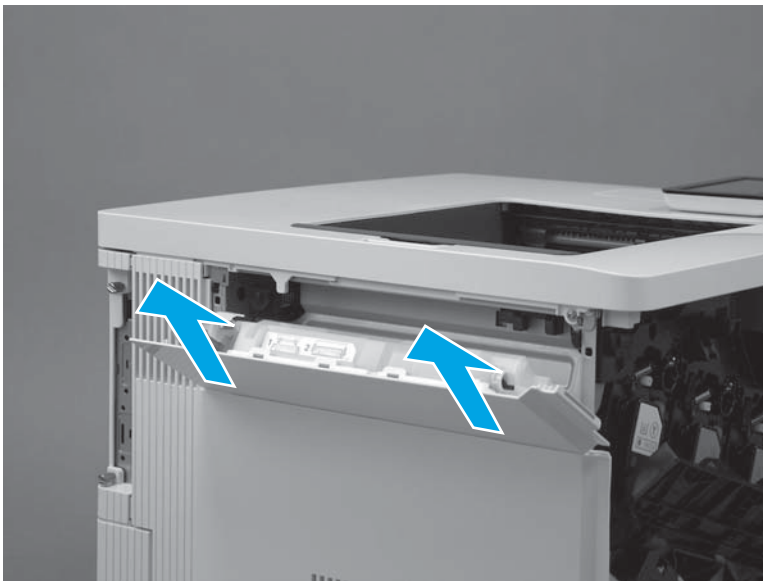

Figure 1-1067 Remove the TCU



Step 3: Remove the USB cover (M553)

📝 NOTE: This step is for the M552 and M553 models. For the M577 models, skip this step and go to [Step 8: Remove the rear upper cover \(M577\) on page 635](#).

1. Locate the USB cover.

Figure 1-1068 Locate the USB cover

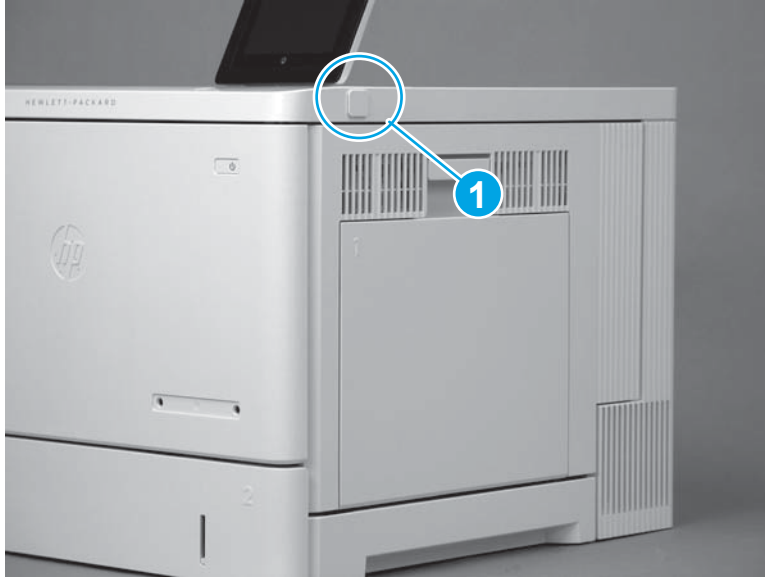

2. Pull the cover off of the printer to remove it.

Figure 1-1069 Remove the cover



Step 4: Remove the control panel (M553x only)

 **NOTE:** For the M553n/dn and M552dn models, skip this step and go to [Step 5: Remove the rear cover \(M553\) on page 631](#).

For the M577, skip this step and go to [Step 8: Remove the rear upper cover \(M577\) on page 635](#).

1. Tilt the control panel up.

Figure 1-1070 Tilt the control panel up



2. Use a small flat-blade screwdriver to release the control-panel screws cover tabs.

Figure 1-1071 Release the control-panel screws cover tabs



3. Rotate the cover up to remove it.

Figure 1-1072 Remove the cover



4. Use a small Phillips screwdriver to remove two screws (callout 1).

 **IMPORTANT:** Store the screws in a secure place where they cannot fall down into the printer.

Figure 1-1073 Remove two screws

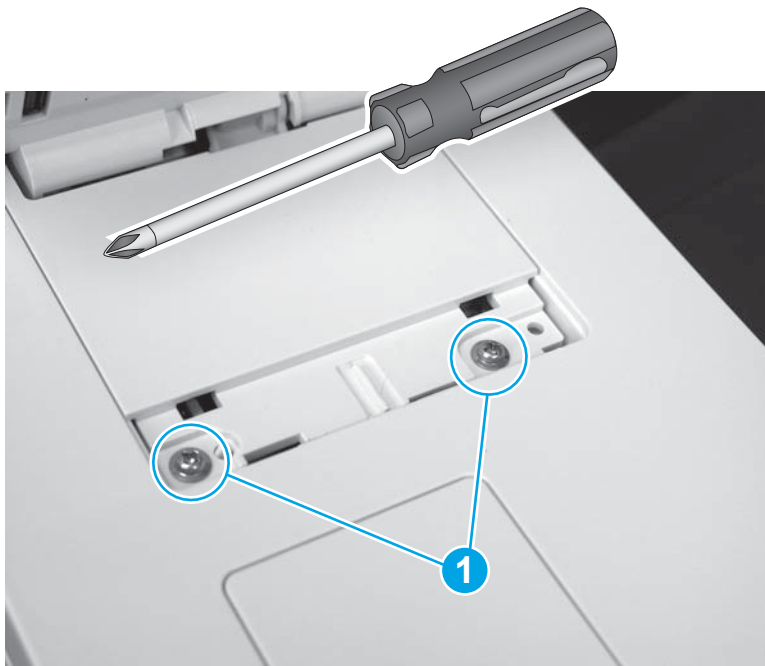

5. Rotate the control-panel base toward the front of the printer.

Figure 1-1074 Rotate the control-panel base up



6. Slightly slide the control-panel base toward the rear of the printer (callout 1) to release it, and then turn the control panel over (callout 2) to access the bottom side.

CAUTION: The control panel is still attached to the printer. Do not attempt to completely remove the control panel.

Figure 1-1075 Turn the control panel over

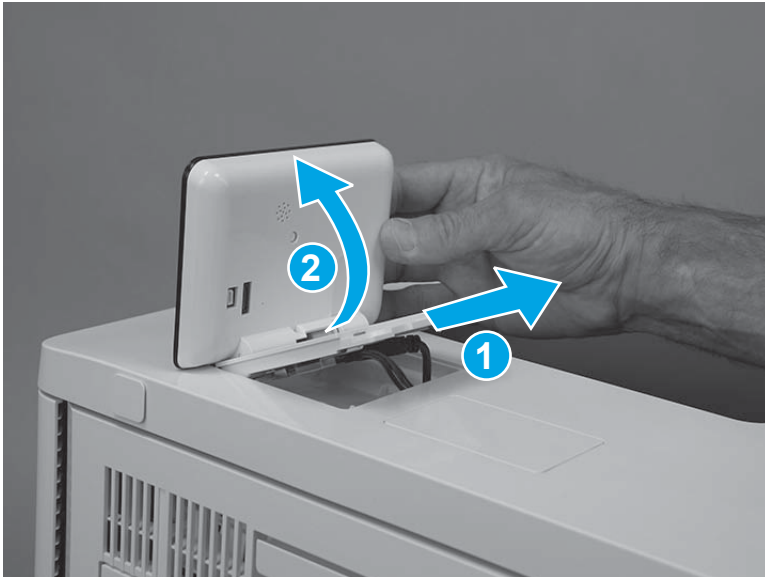

7. Disconnect one USB cable (callout 1), one connector (callout 2), and then remove the control panel.

Figure 1-1076 Disconnect two connectors

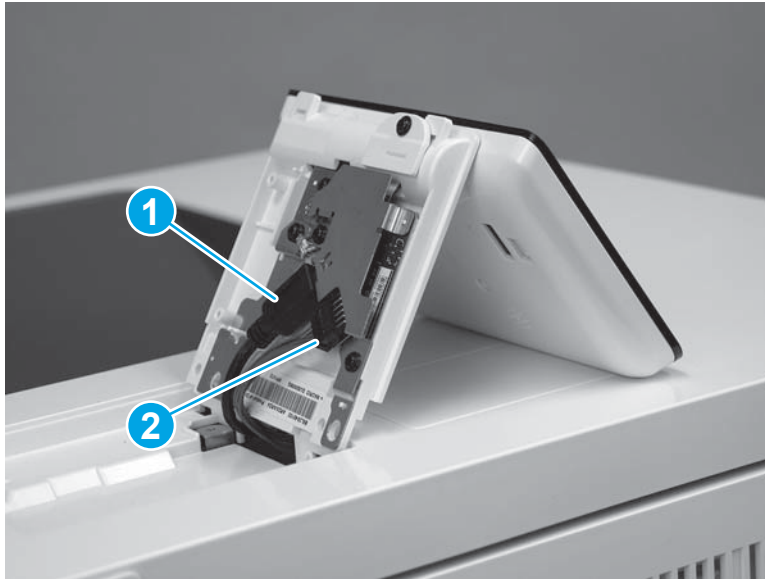

Step 5: Remove the rear cover (M553)

 **NOTE:** This step is for the M552 and M553 models. For the M577 models, skip this step and go to [Step 8: Remove the rear upper cover \(M577\) on page 635](#).

1. Remove four screws (callout 1).

Figure 1-1077 Remove four screws

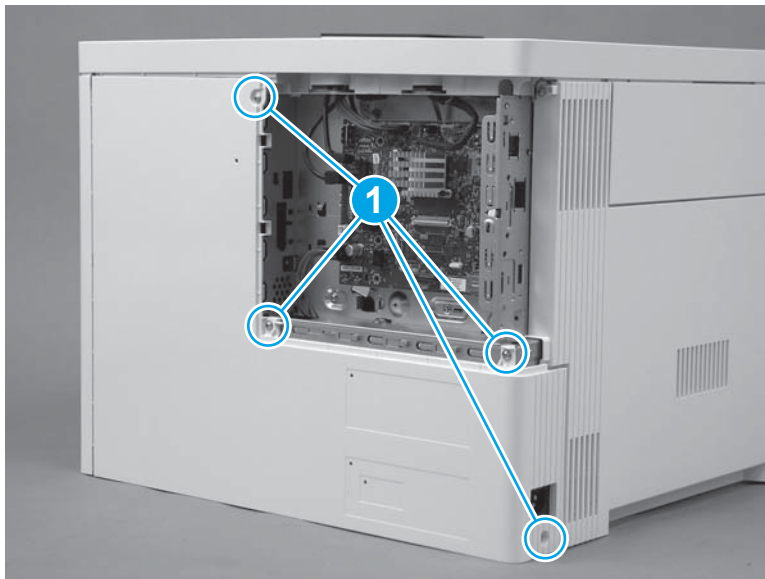

2. Slightly slide the cover to the right (callout 1), rotate the bottom of the cover away from the printer (callout 2), and then pull the top of the cover away from the printer (callout 3) to remove the cover.

Figure 1-1078 Remove the cover

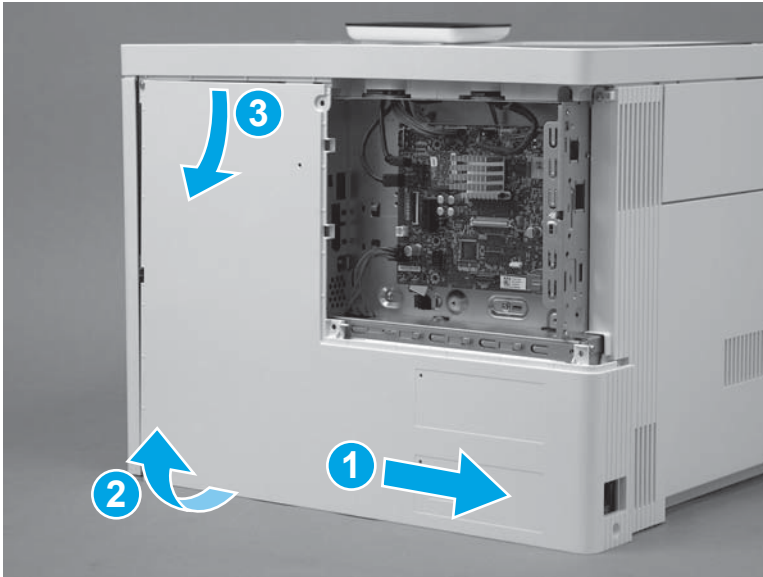

Step 6: Remove the left cover (M553)



NOTE: This step is for the M552 and M553 models. For the M577 models, skip this step and go to [Step 8: Remove the rear upper cover \(M577\) on page 635](#).

1. At the left side of the printer, remove one screw (callout 1).

Figure 1-1079 Remove one screw



2. Release one tab (callout 1), rotate the front edge of the cover away from the printer (callout 2), and then slide the cover (callout 3) toward the rear of the printer to release it.

Figure 1-1080 Release the cover

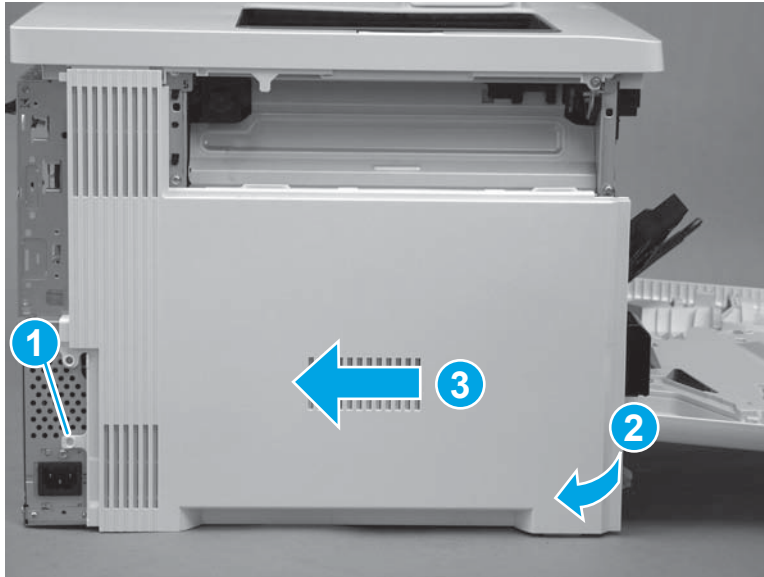

3. Remove the cover.

Figure 1-1081 Remove the cover

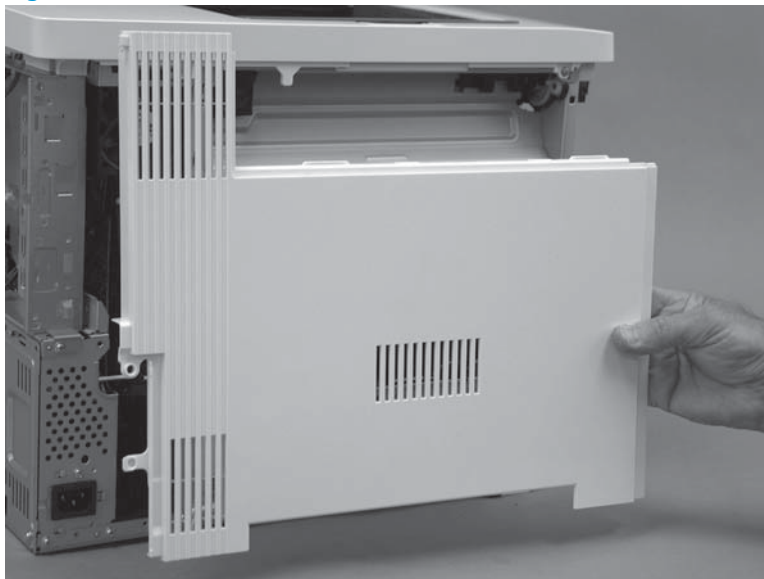

Step 7: Remove the upper cover (M553)

 **NOTE:** This step is for the M552 and M553 models. For the M577 models, skip this step and go to [Step 8: Remove the rear upper cover \(M577\) on page 635.](#)

1. Remove three screws (callout 1).

Figure 1-1082 Remove three screws

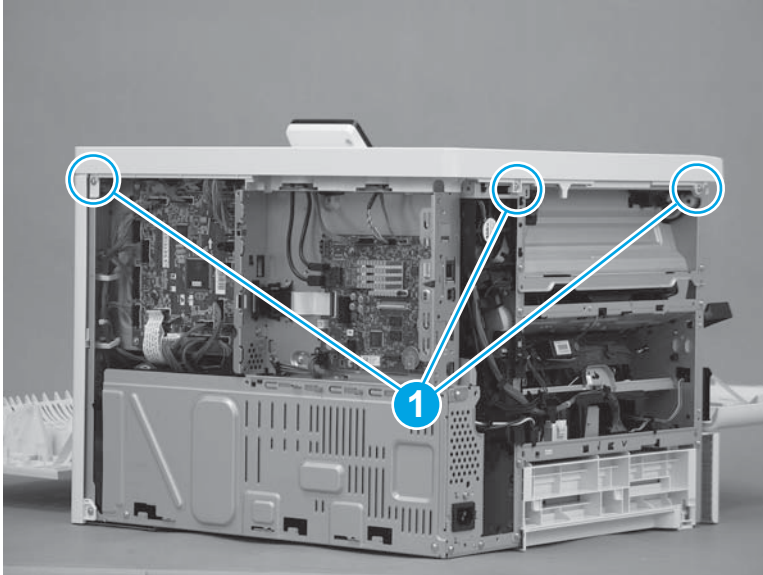

2. Remove one screw (callout 1), release one tab (callout 2), and then slightly separate the corner of the cover from the chassis.

 **NOTE:** This is a self-tapping plastic-thread screw. Make sure that this screw is used in this location when it is reinstalled.

Figure 1-1083 Remove one screw and release one tab



3. Release one tab (callout 1), and then lift up on the cover to release it.

 **NOTE:** If the cover does not release, check for addition tabs by locating the triangles embossed in the cover at tab locations.

Figure 1-1084 Release the cover



4. Remove the cover.

Figure 1-1085 Remove the cover

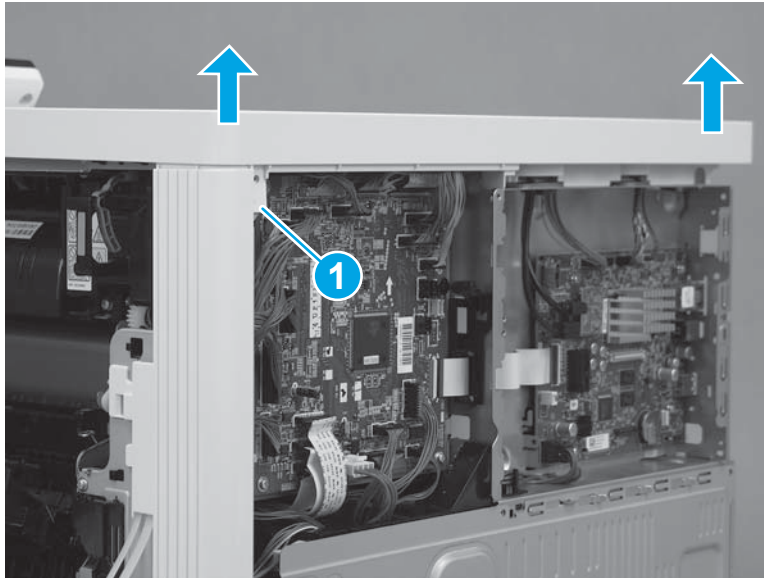
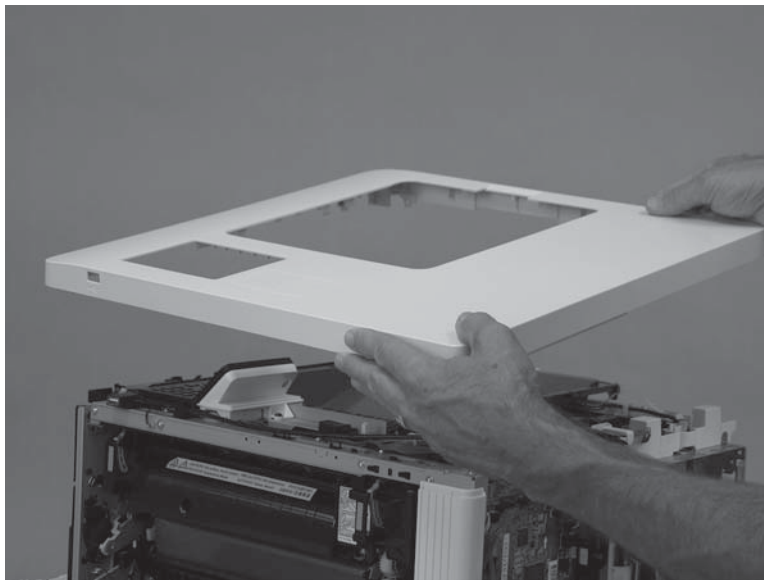

Step 8: Remove the rear upper cover (M577)

 **NOTE:** This step is for the M577 models. For the M552 and M553 models, skip this step and go to [Step 18: Remove the output bin on page 653](#).

1. Remove two screws (callout 1).

 **Reinstallation tip:** These two screws are self-tapping screws for plastic. When reinstalling them, rotate the screws counterclockwise to align them with the existing thread pattern, and then carefully turn them clockwise to tighten. Do not overtighten. This will prevent stripping the threads inside the screw holes.

Figure 1-1086 Remove two screws



2. Use a small, flat blade screwdriver to release the right edge of the cover.

Figure 1-1087 Release the right edge

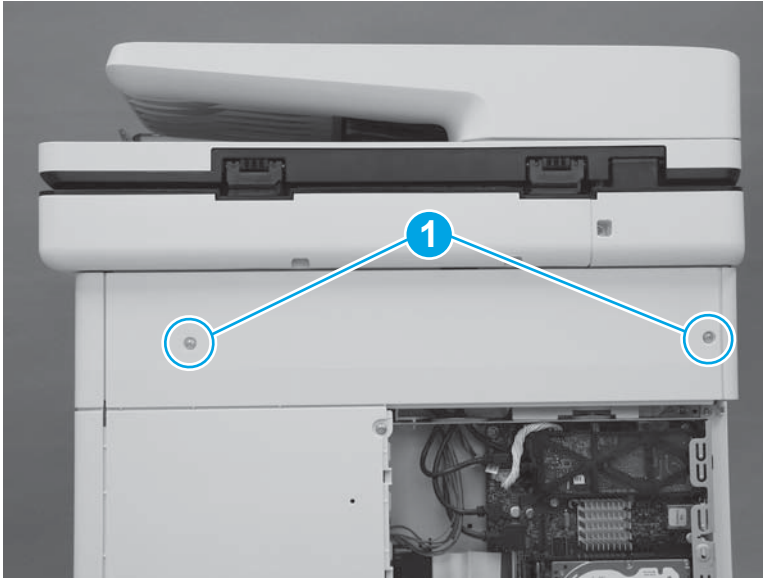
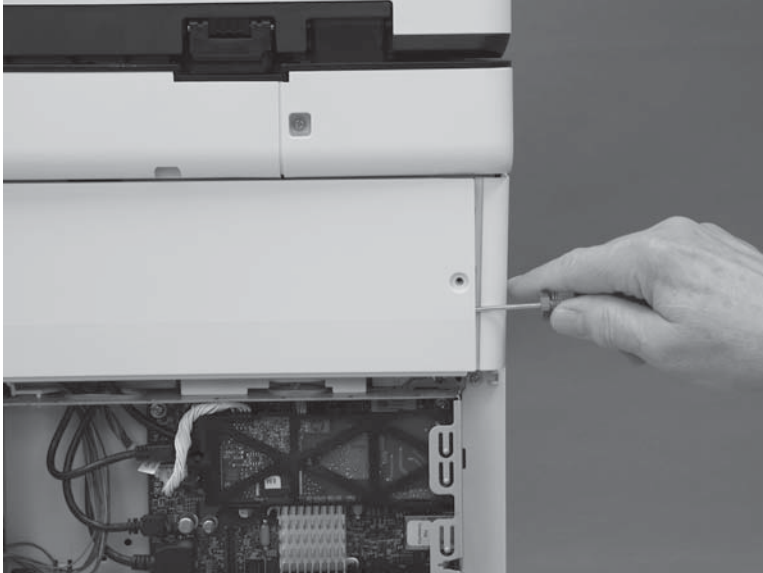

3. Pull the right edge of the cover (callout 1) away from the printer, and then slide the cover to the right (callout 2).

Figure 1-1088 Slide the cover right

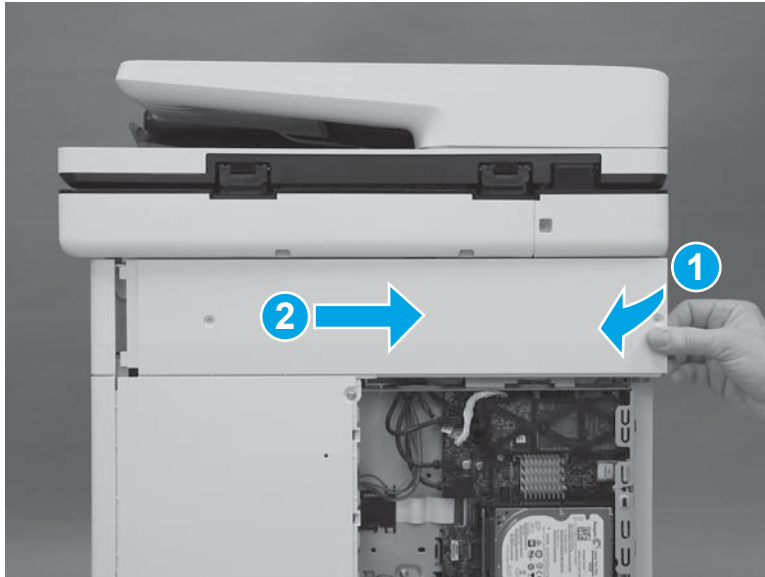

4. Remove the cover.

Figure 1-1089 Remove the cover

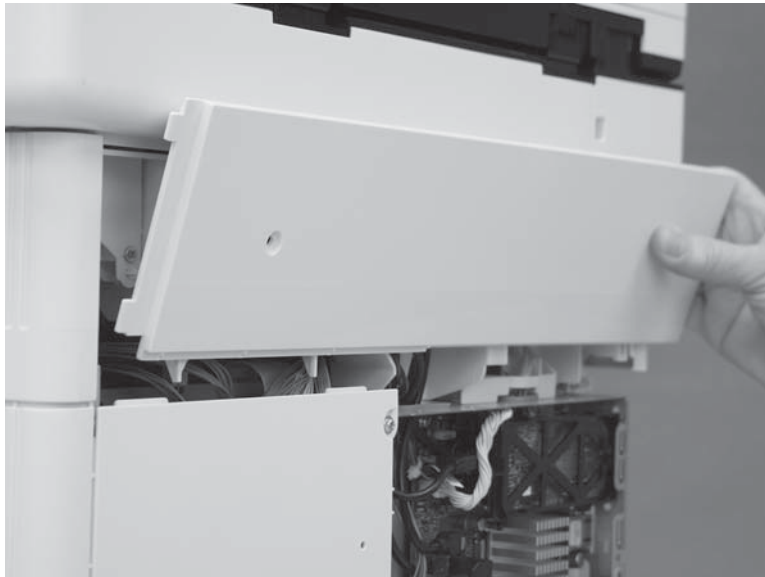

Step 9: Remove the left upper cover (M577)

 **NOTE:** This step is for the M577 models. For the M552 and M553 models, skip this step and go to [Step 18: Remove the output bin on page 653](#).

1. At the left side of the printer, release one tab (callout 1).

Figure 1-1090 Release one tab

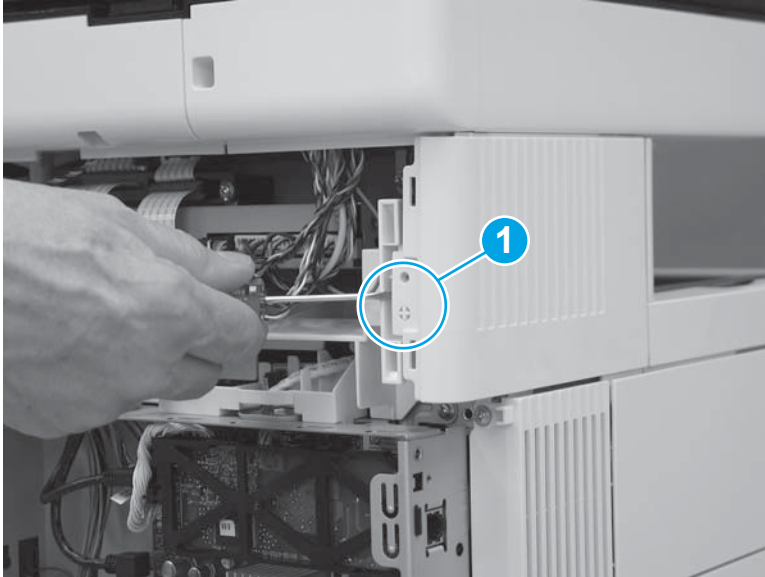

2. Slide the left upper cover toward the back of the printer.

Figure 1-1091 Slide the cover back

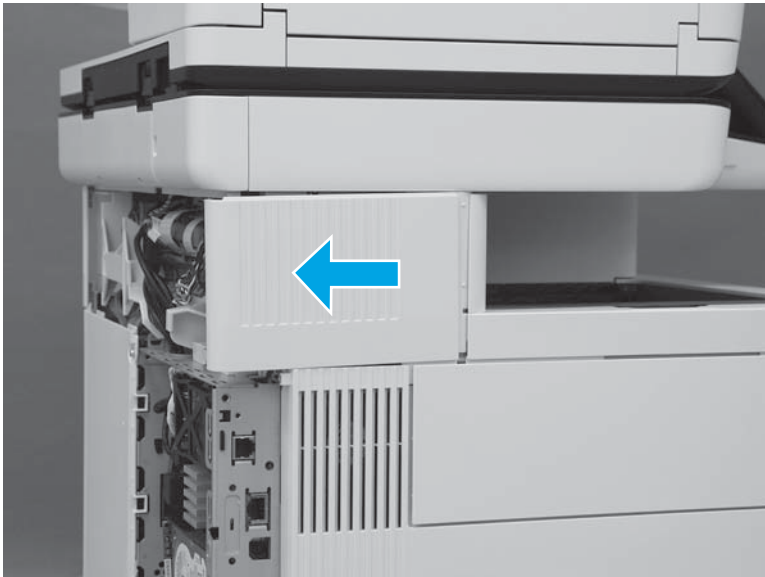

3. Rotate the cover up to remove it.

Figure 1-1092 Remove the left upper cover



Step 10: Remove the right front upper cover (M577dn)

 **NOTE:** This step is for the M577dn model. For the M577c/f/z models, skip this step and go to [Step 11: Remove the stapler cover assembly \(M577c/f/z\) on page 640.](#)

For the M552 and M553 models, skip this step and go to [Step 18: Remove the output bin on page 653.](#)

1. Remove one screw (callout 1).

Figure 1-1093 Remove one screw

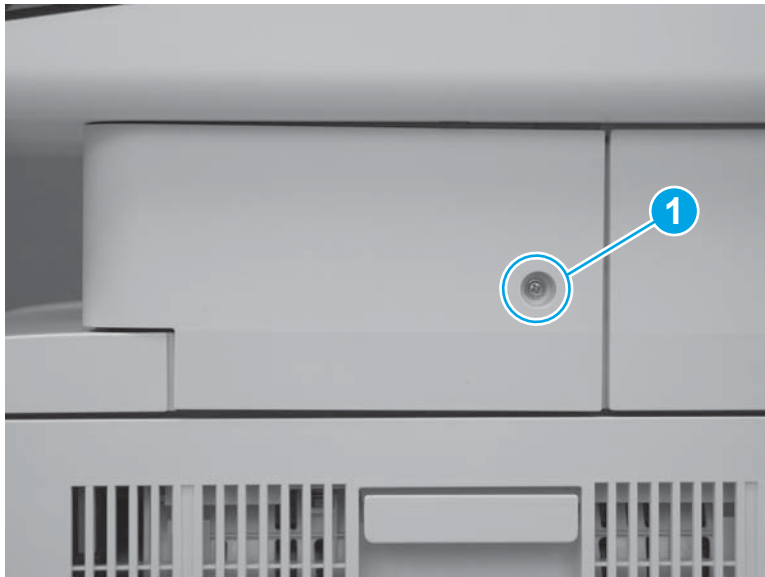

2. Release two tabs at the front edge of the cover (callout 1).

Figure 1-1094 Release two tabs



3. Rotate the front of the cover to the right to remove it.

Figure 1-1095 Rotate the cover



Step 11: Remove the stapler cover assembly (M577c/f/z)



NOTE: This step is for the M577c/f/z models. For the M577dn model, skip this step and go to [Step 12: Remove the integrated scanner assembly \(M577\) on page 642.](#)

For the M552 and M553 models, skip this step and go to [Step 18: Remove the output bin on page 653.](#)

1. Remove one screw (callout 1).

 **Reinstallation tip:** This is a self-tapping screw for plastic. When reinstalling, rotate the screw counterclockwise to align it with the existing thread pattern, and then carefully turn it clockwise to tighten. Do not overtighten. This will prevent stripping the threads inside the screw hole.

Figure 1-1096 Remove one screw



2. Release two tabs at the front edge of the cover (callout 1).

Figure 1-1097 Release two tabs

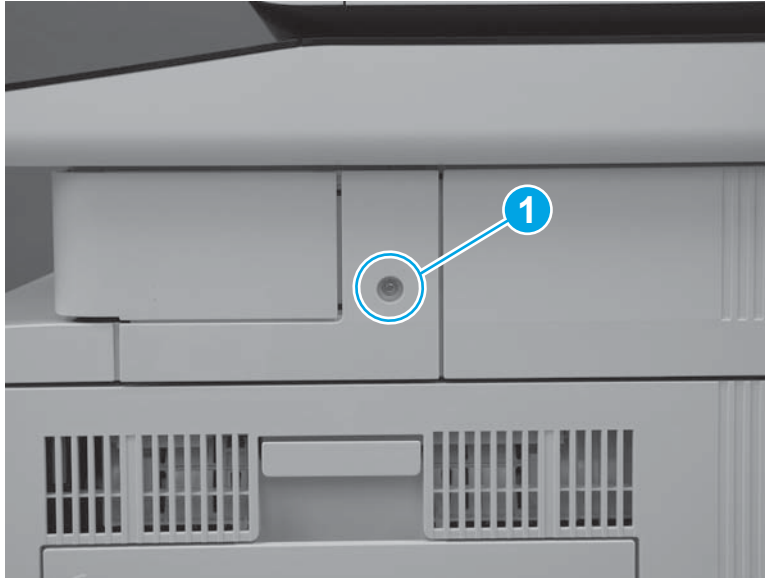

3. Release the back edge of the cover.

Figure 1-1098 Release the back edge of the cover

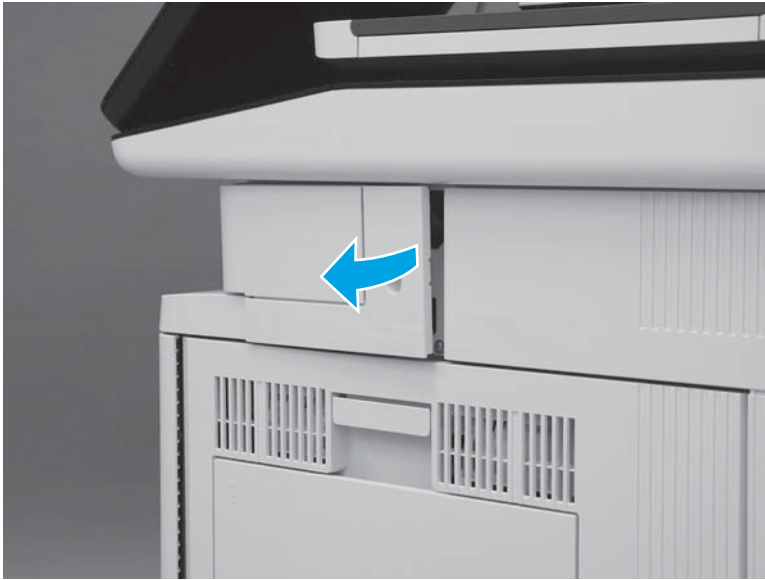



4. Rotate the cover away from the printer to remove it.

Figure 1-1099 Remove the cover



Step 12: Remove the integrated scanner assembly (M577)

 **NOTE:** This step is for the M577 models. For the M552 and M553 models, skip this step and go to [Step 18: Remove the output bin on page 653](#).

 **NOTE:** The ISA includes the document feeder, image scanner, scanner control board (SCB), control panel, keyboard (M577c/z) and NFC PCA (M577z).

1. At the left side of the printer, remove one screw (callout 1).

Figure 1-1100 Remove one screw

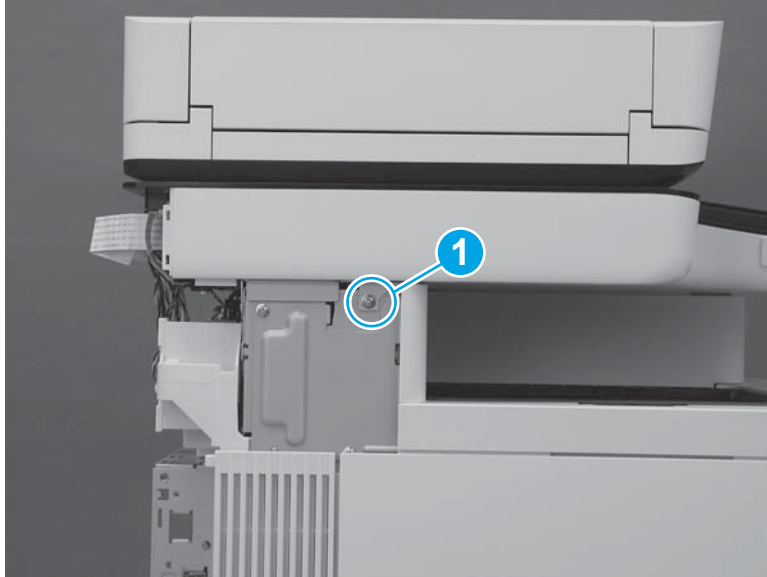

2. At the back side of the printer, remove two screws (callout 1).

Figure 1-1101 Remove two screws

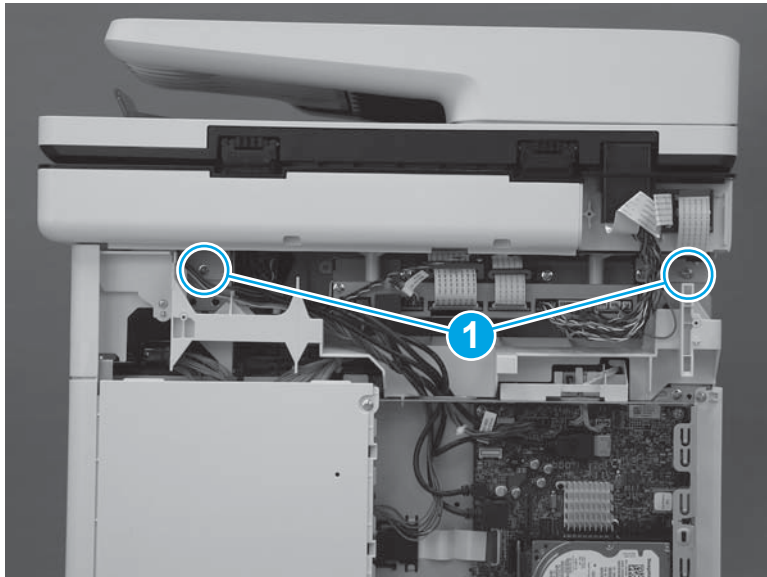

3. At the right side of the printer, remove one screw (callout 1).

Figure 1-1102 Remove one screw

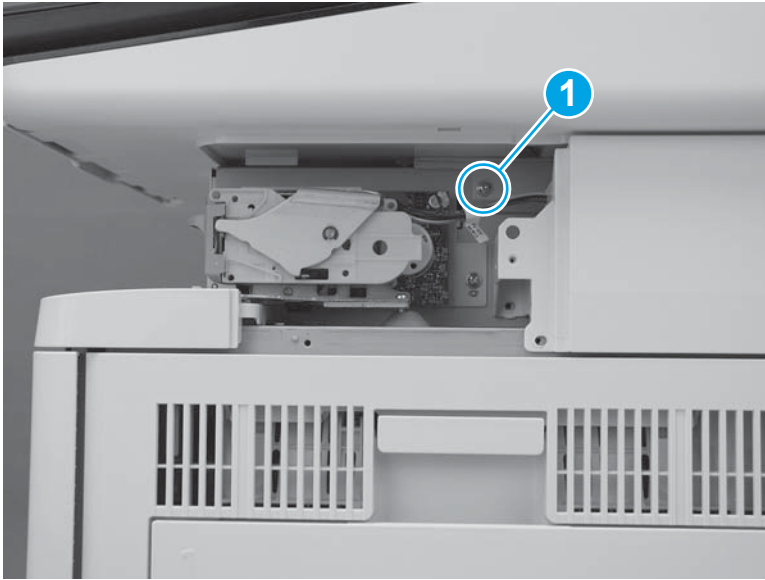

4. Disconnect four connectors on the formatter (callout 1), and then pass the wire harness and cables through the opening in the formatter case (callout 2).

Figure 1-1103 Disconnect four connectors

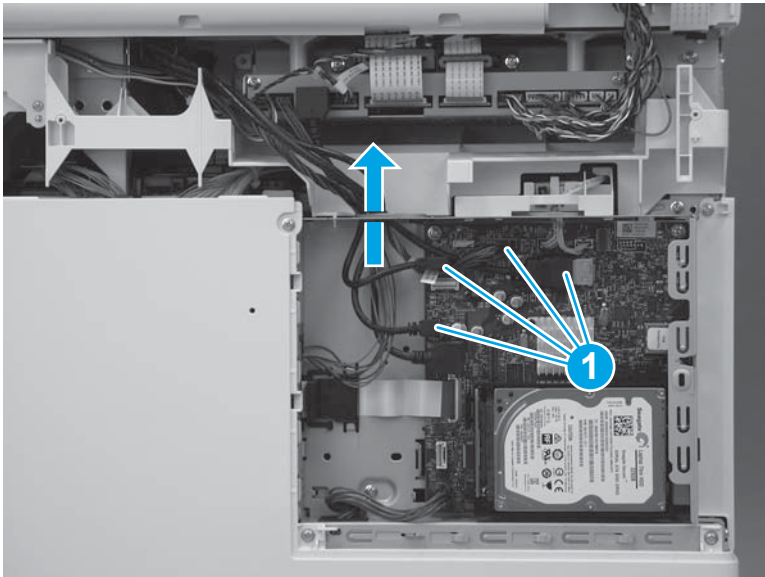

5. Disconnect two connectors on the scanner control board (callout 1).

M577c/f/z only: Disconnect one connector for the stapler on the scanner control board (callout 2).

Figure 1-1104 Disconnect connectors

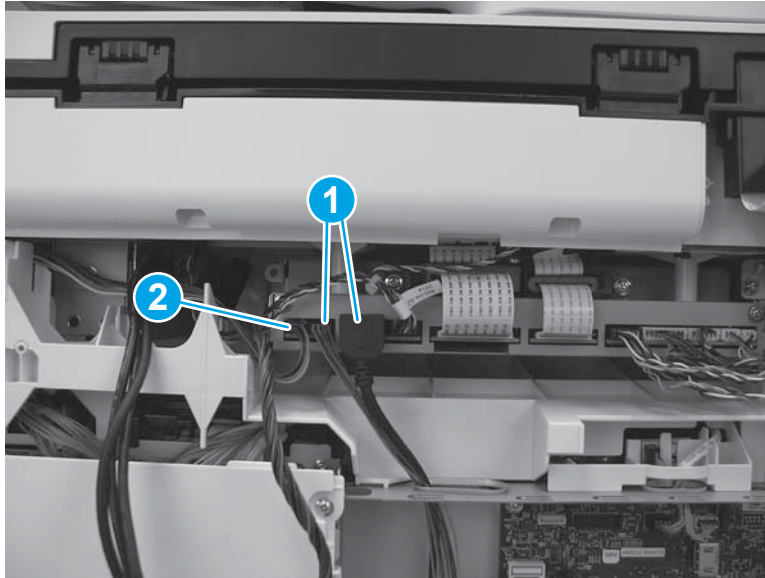

6. Slightly slide the ISA towards the back of the printer to release it.

Figure 1-1105 Slide the ISA towards the back of the printer

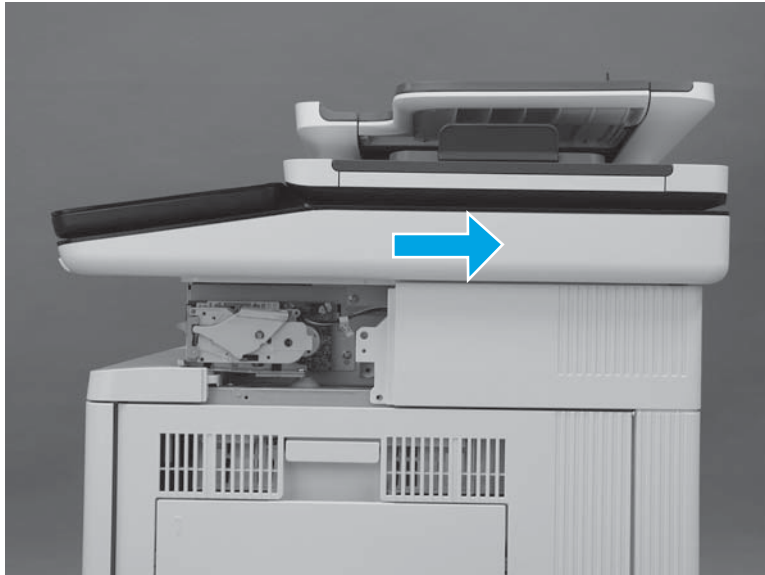

7. Lift the ISA up to remove it.

Figure 1-1106 Remove the ISA

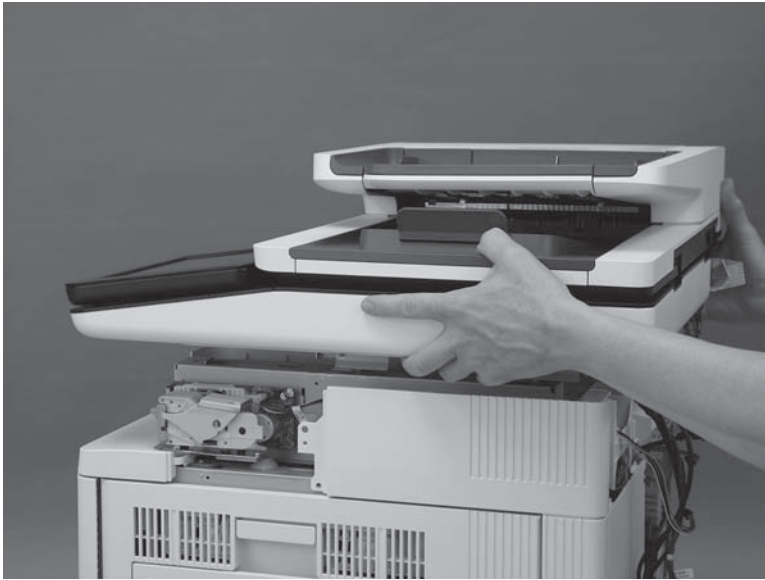

Step 13: Remove the stapler unit (M577f and M577z)



NOTE: This step is for the M577f and M577z models. For the M577dn model, skip this step and to go [Step 14: Remove the right upper cover \(M577\) on page 647](#).

This step is for the M577 models. For the M552 and M553 models, skip this step and go to [Step 18: Remove the output bin on page 653](#).

1. Disconnect one connector (callout 1), and then remove two screws (callout 2).

Figure 1-1107 Disconnect connector and remove screws

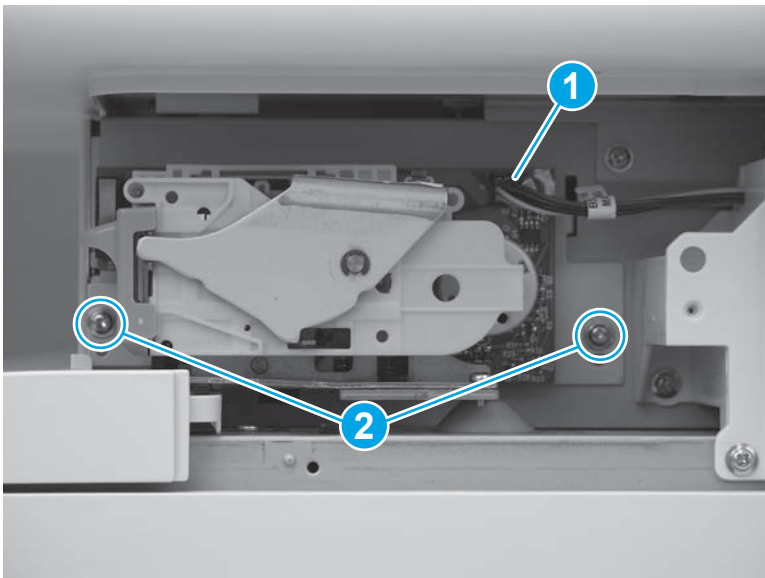

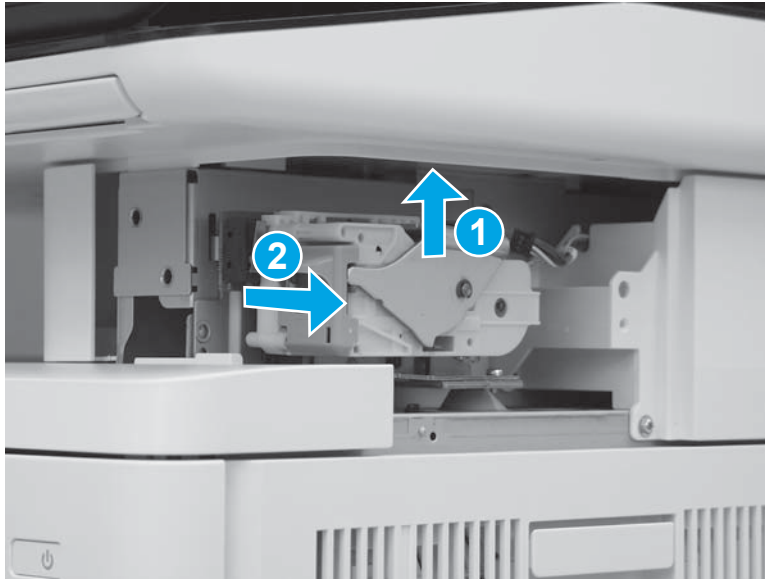

2. Slide the stapler unit up (callout 1), and then pull it away from the printer (callout 2) to remove it.

Figure 1-1108 Remove the stapler unit



Step 14: Remove the right upper cover (M577)

 **NOTE:** This step is for the M577 models. For the M552 and M553 models, skip this step and go to [Step 18: Remove the output bin on page 653](#).

 **NOTE:** The figures below show the image scanner installed. The procedures for removing and installing the right upper cover are the same whether the image scanner is installed or removed."

1. At the right side of the printer, remove two screws (callout 1).

M577c/f/z only: Disconnect one connector (callout 2), if it was not already disconnected in a previous step.

Figure 1-1109 Remove two screws and one connector

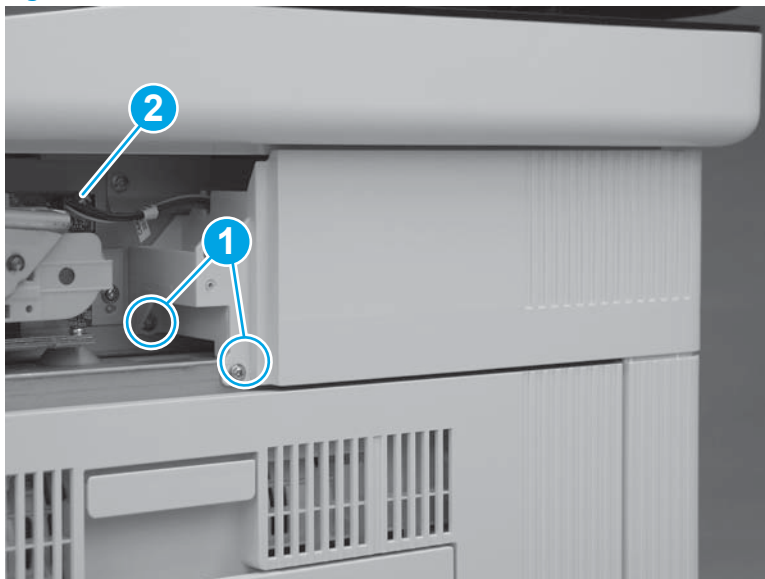

2. At the back of the printer, remove one screw (callout 1).

M577c/f/z only: Disconnect one connector (callout 2), if it was not already disconnected in a previous step.

 **Reinstallation tip:** This screw is smaller than the screws removed in the previous step. When reinstalling the right upper cover, make sure that this screw is installed in the correct position.

Figure 1-1110 Remove one screw and connector



3. Slide the cover toward the back of the printer.

Figure 1-1111 Slide the cover

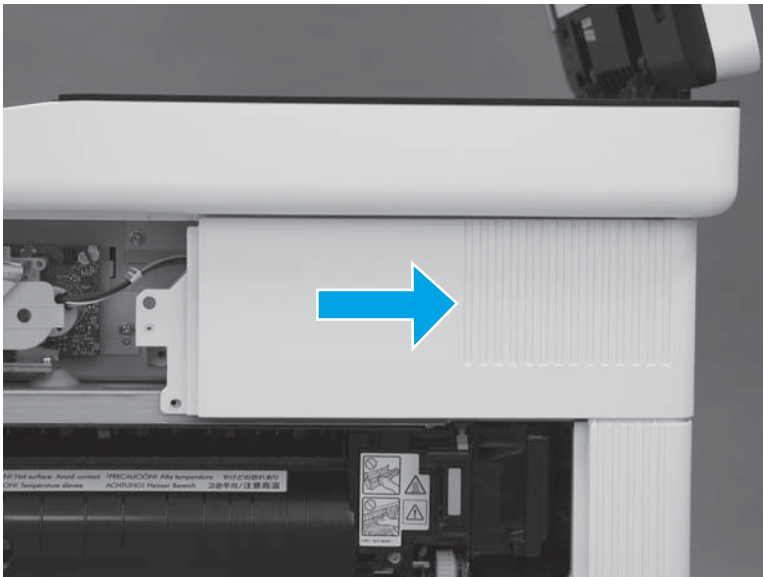

4. Lift the cover away from the printer to remove it.

M577c/f/z only: Release the cables (callout 1) through the slot (callout 2) in the printer.

Figure 1-1112 Remove the cover

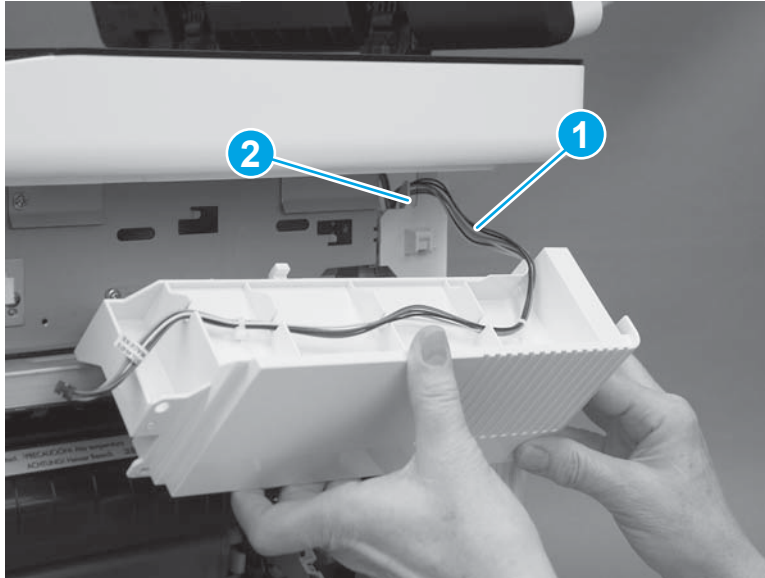

Step 15: Remove the top rear cover (M577)

 **NOTE:** This step is for the M577 models. For the M552 and M553 models, skip this step and go to [Step 18: Remove the output bin on page 653](#).

1. At the top of the printer, remove five screws (callout 1).

Figure 1-1113 Remove five screws

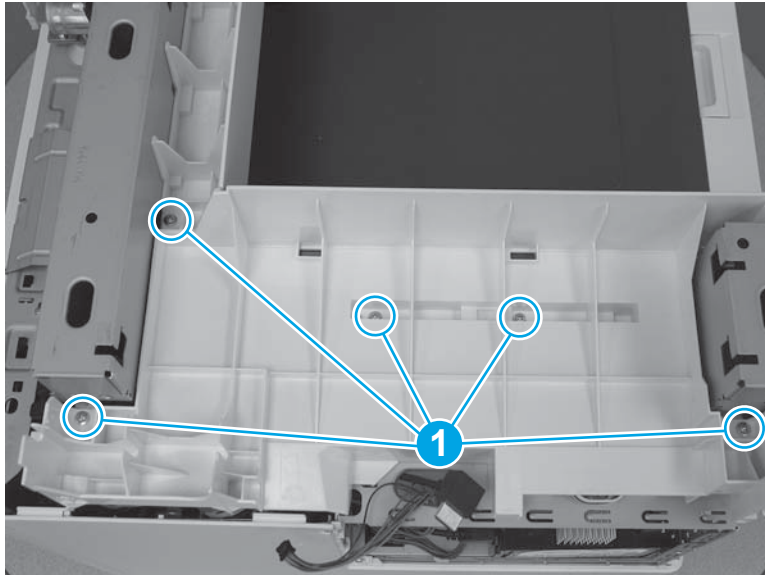

2. Release two tabs (callout 1) on the front edge of the cover.

Figure 1-1114 Release two tabs

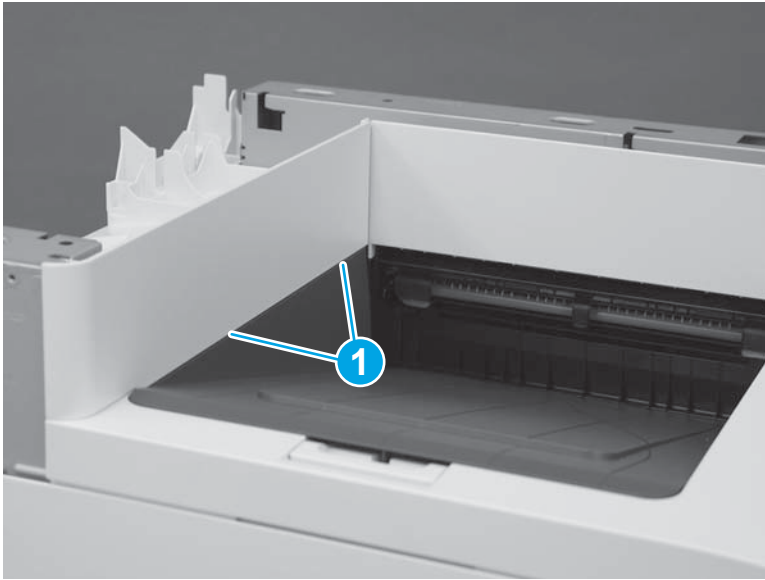

3. Remove the top rear cover.

Figure 1-1115 Remove the top rear cover

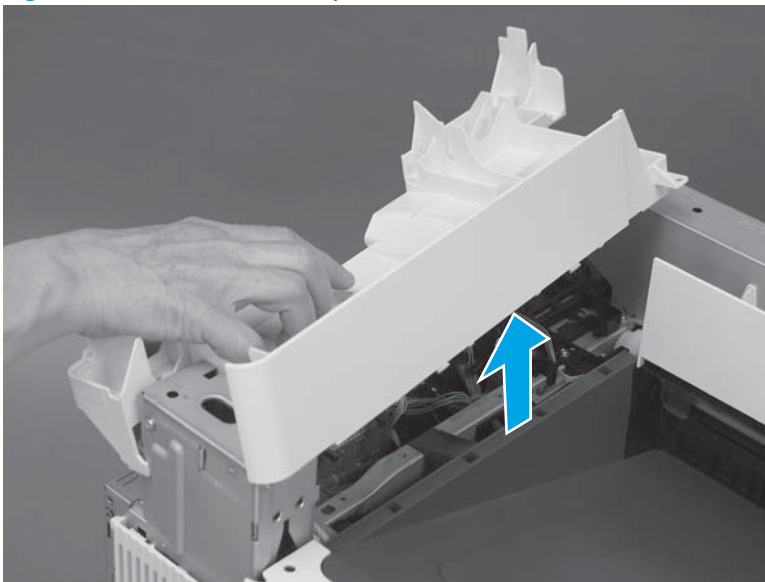

Step 16: Remove the paper feed cover (M577)



NOTE: This step is for the M577 models. For the M552 and M553 models, skip this step and go to [Step 18: Remove the output bin on page 653](#).

1. Remove one screw (callout 1).

Figure 1-1116 Remove one screw

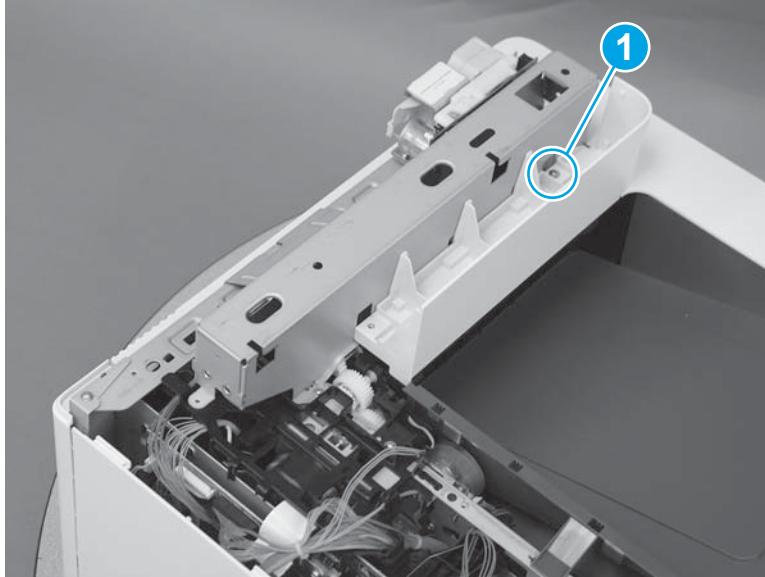

2. Lift the cover up to remove it.

Figure 1-1117 Remove the cover

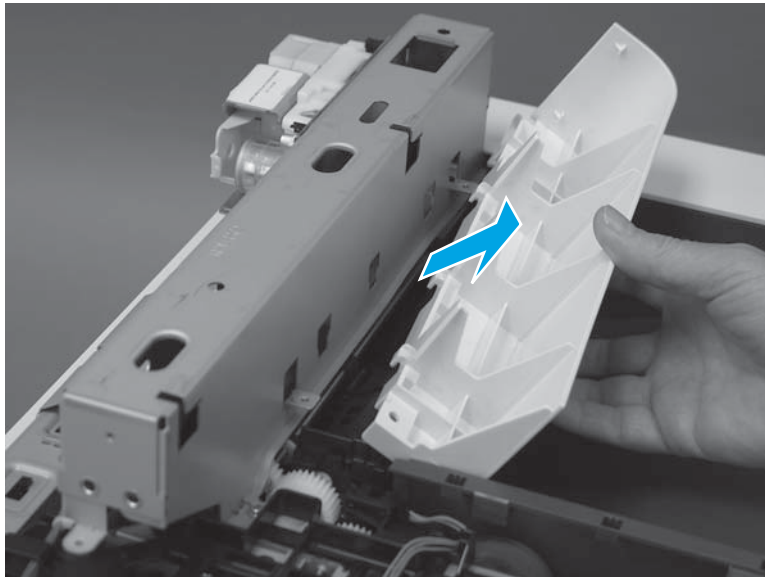

Step 17: Remove the top cover (M577)



NOTE: This step is for the M577 models. For the M552 and M553 models, skip this step and go to [Step 18: Remove the output bin on page 653](#).

1. At the front of the printer, remove one screw (callout 1).



Reinstallation tip: This screw is longer and a different type of screw than the screw removed in the next step. When reinstalling the top cover, make sure that this screw is installed in the correct position.

Figure 1-1118 Remove one screw

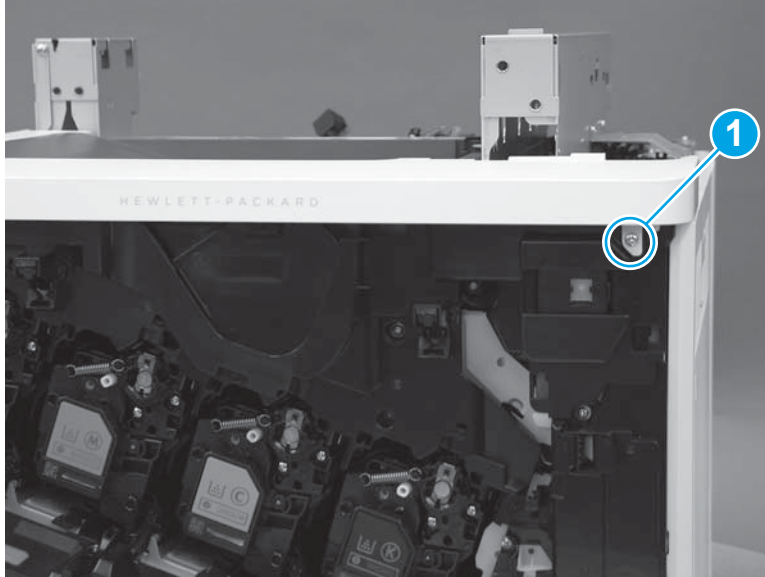

2. At the left side of the printer, remove one screw (callout 1).

Figure 1-1119 Remove one screw

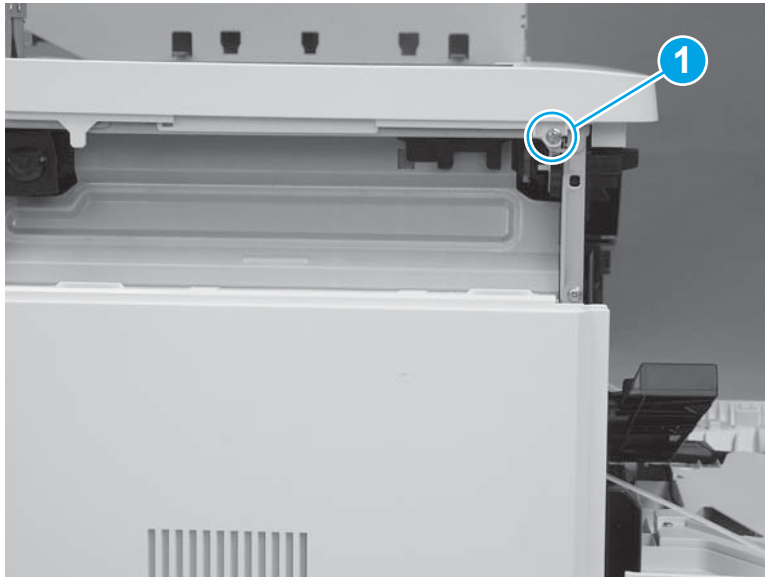

3. At the front of the printer, release one tab (callout 1).

Figure 1-1120 Release one tab

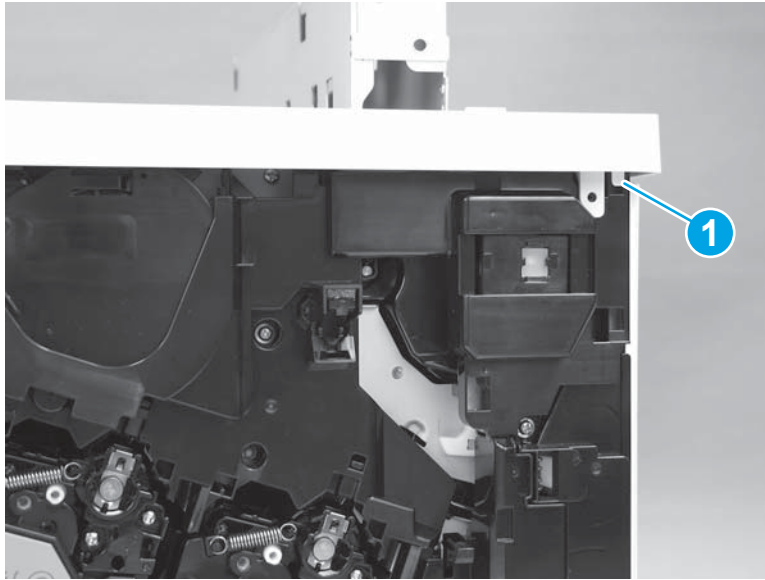

4. At the top of the printer, release two tabs (callout 1) next to the output bin, and then remove the top cover.

Figure 1-1121 Release two tabs

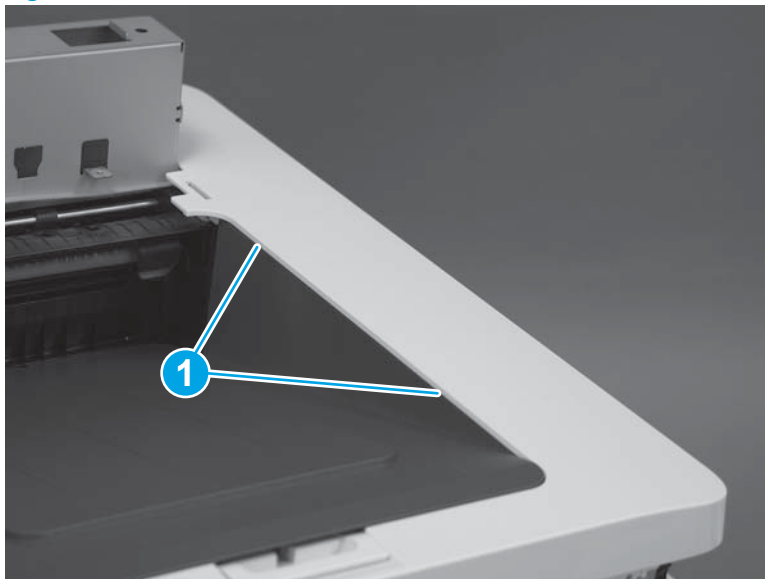

Step 18: Remove the output bin

1. Slightly slide and lift the cover to release it.

Figure 1-1122 Release the cover

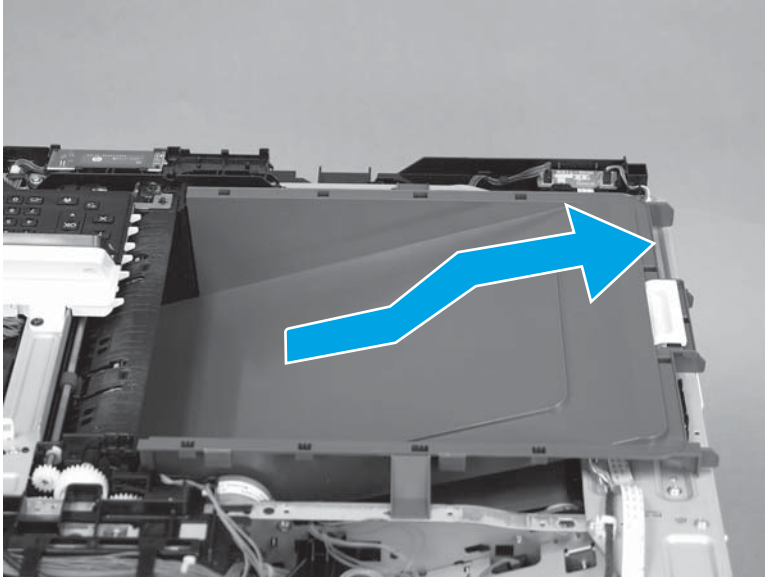

2. Remove the cover.

Figure 1-1123 Remove the cover

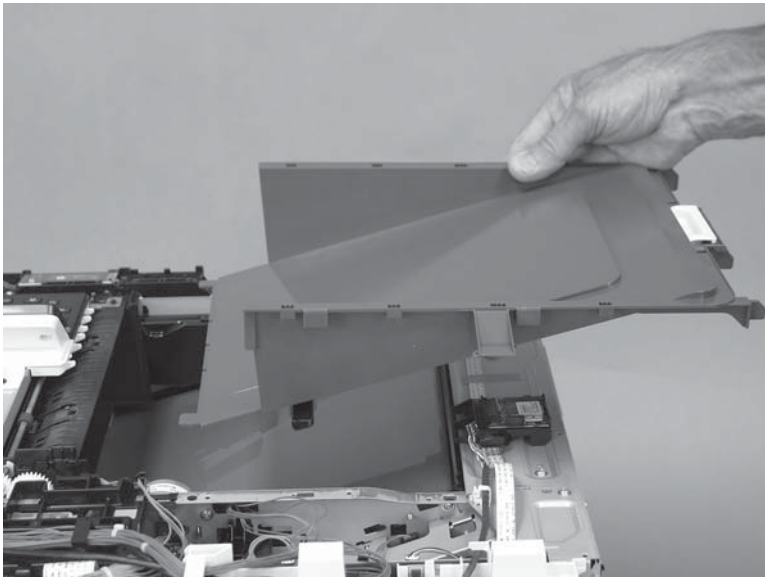

Step 19: Remove the wireless PCA (M553 and M577)

- ▲ Disconnect one connector (callout 1), release two tabs (callout 2), and then remove the wireless PCA (callout 3).

Figure 1-1124 Remove the wireless PCA

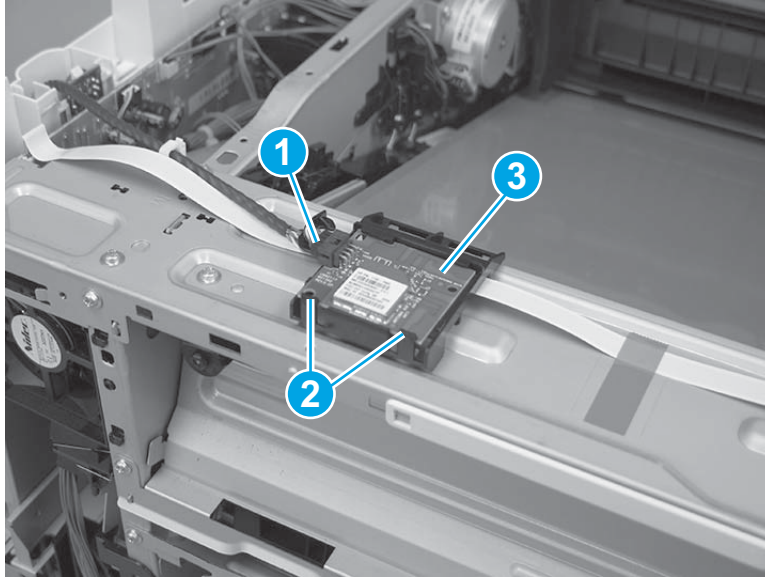

Step 20: **Unpack the replacement assembly**

Unpack the replacement assembly from the packaging.

For complete information on HP's recycling programs, go to [Product return and recycling](#).

 **CAUTION:**  ESD-sensitive part.

 **NOTE:** HP recommends responsible disposal of the defective assembly.

Figure 1-1125 Recycle and unpack



Step 21: **Install the wireless PCA (M553 and M577)**

- ▲ Position the wireless PCA (callout 1) on the printer, connect one connector (callout 2), and then make sure the two tabs (callout 3) are firmly holding the PCA in the holder.

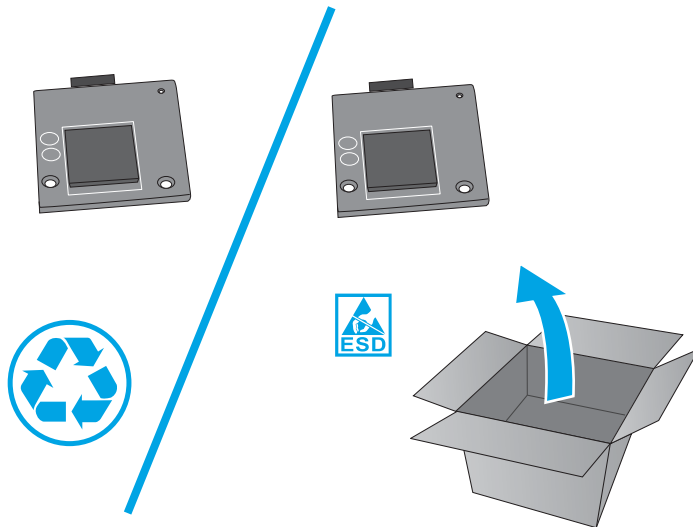
Figure 1-1126 Install the wireless PCA

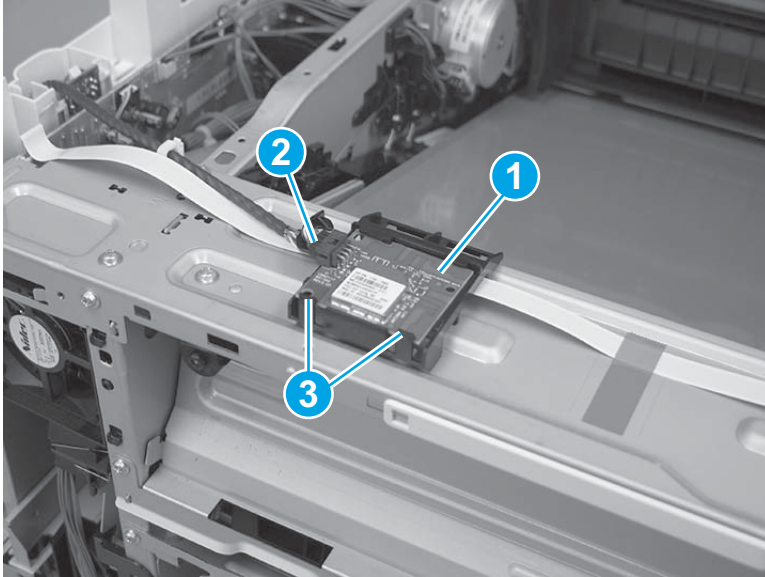

Step 22: Install the output bin

1. Position the cover near the printer.

Figure 1-1127 Install the cover

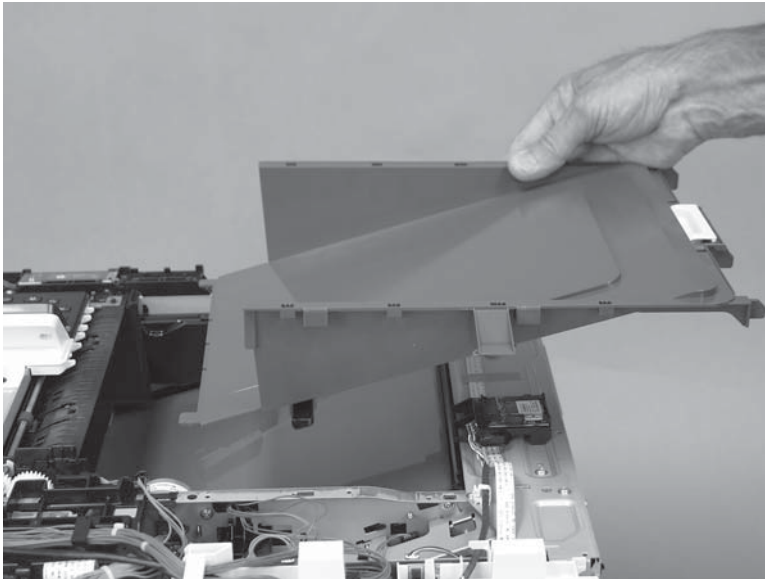

2. Align the tabs on the cover with the slots in the printer.

Figure 1-1128 Align the tabs

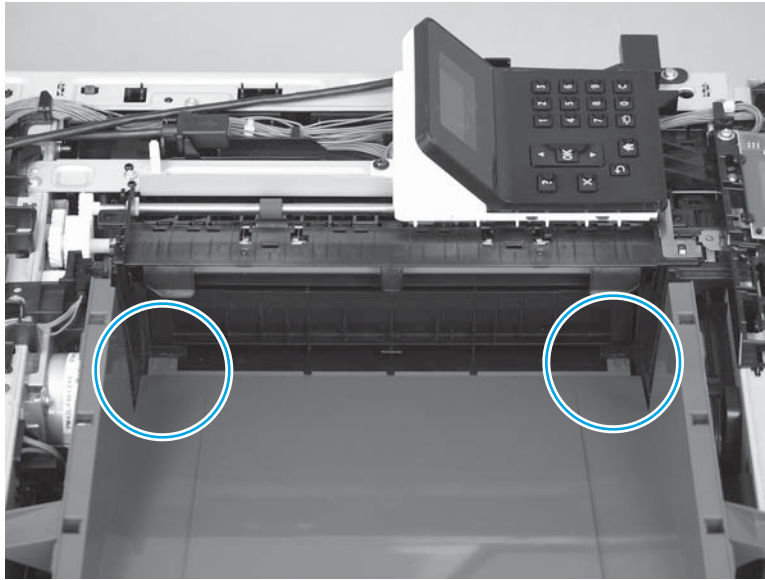

3. Slide and lower the cover onto the printer to install it.

Figure 1-1129 Release the cover

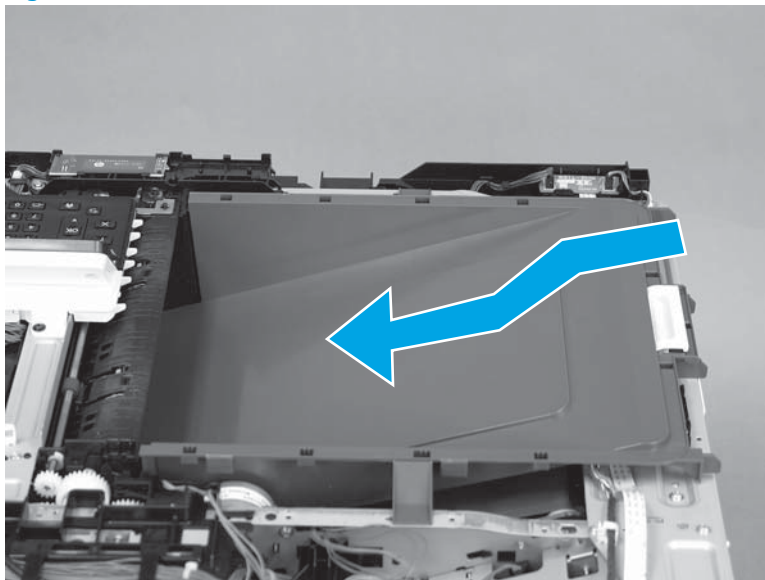

4. Verify that the tabs on the front- and rear-side of the cover are correctly installed in the slots in the chassis.

Figure 1-1130 Verify the installation

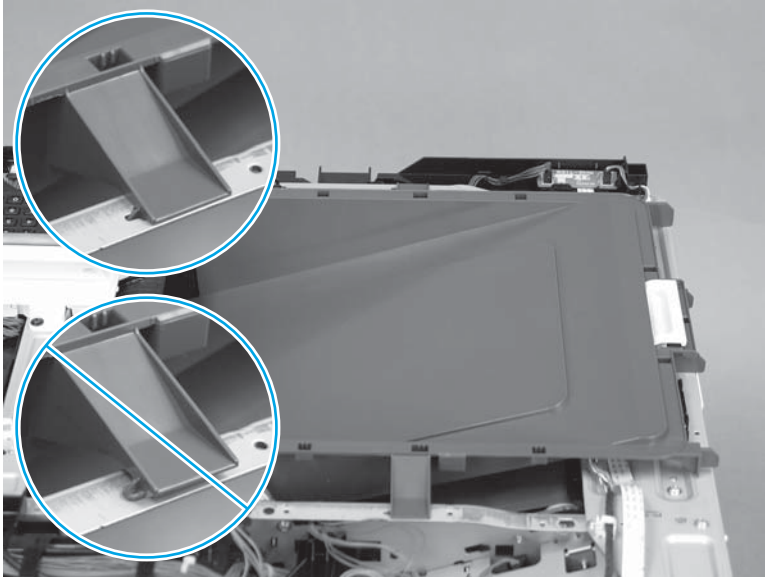

Step 23: Install the top cover (M577)



NOTE: This step is for the M577 models. For the M552 and M553 models, skip this step and go to [Step 33: Install the upper cover \(M553\) on page 676](#).

1. Position the locator pins (callout 1) on the cover in the slots (callout 2) in the printer.

Figure 1-1131 Position the locator pins

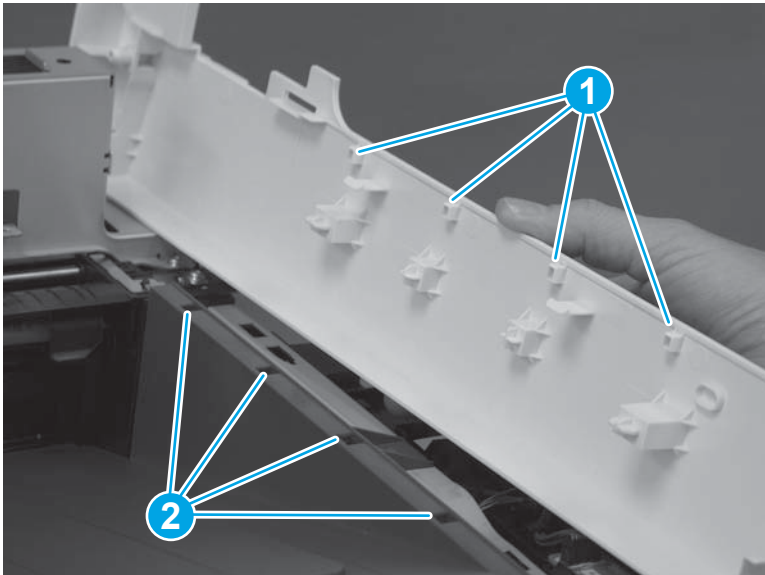

2. Press down on the cover to install it. Make sure that the tabs (callout 1) snap into place.

Figure 1-1132 Press down on the cover

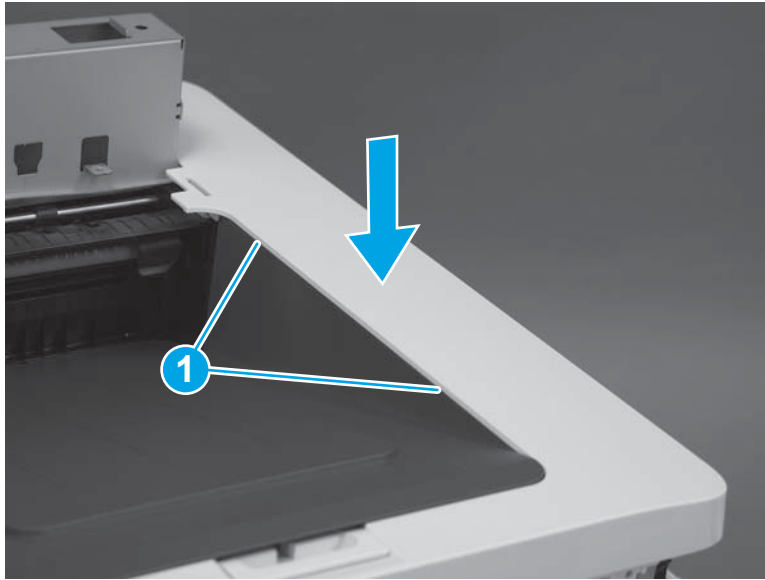

3. At the front of the printer, install one screw (callout 1).

 **Reinstallation tip:** This screw is longer and a different type of screw than the screw installed in the next step. Make sure that this screw is installed in the correct position.

Figure 1-1133 Install one screw



4. At the left side of the printer, install one screw (callout 1).

Figure 1-1134 Install one screw

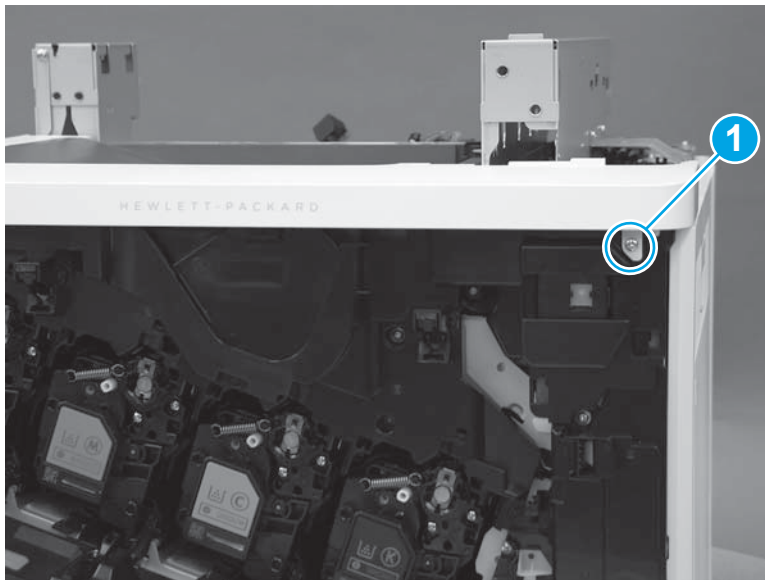
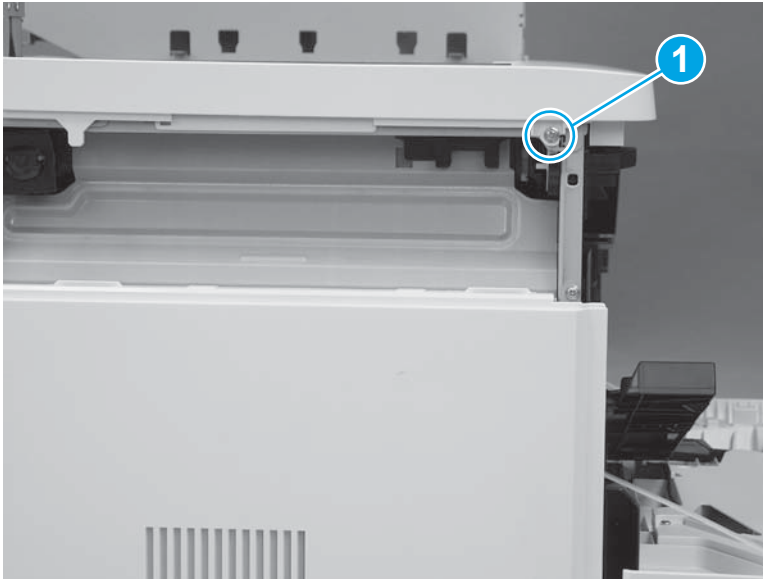

Step 24: Install the paper feed cover (M577)



NOTE: This step is for the M577 models. For the M552 and M553 models, skip this step and go to [Step 33: Install the upper cover \(M553\) on page 676](#).

1. Position the locator tabs (callout 1) on the cover in the slots (callout 2) in the printer. Press down until the cover snaps into place.

Figure 1-1135 Install the cover

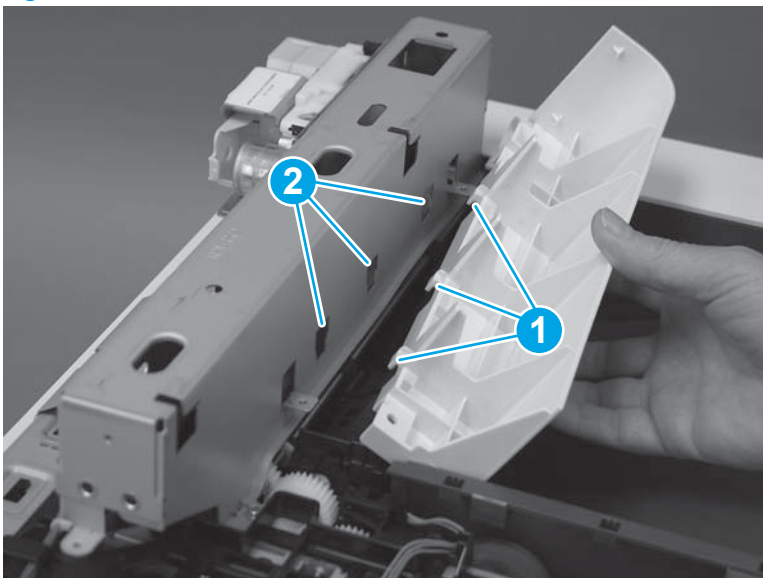

2. Install one screw (callout 1).

Figure 1-1136 Install one screw

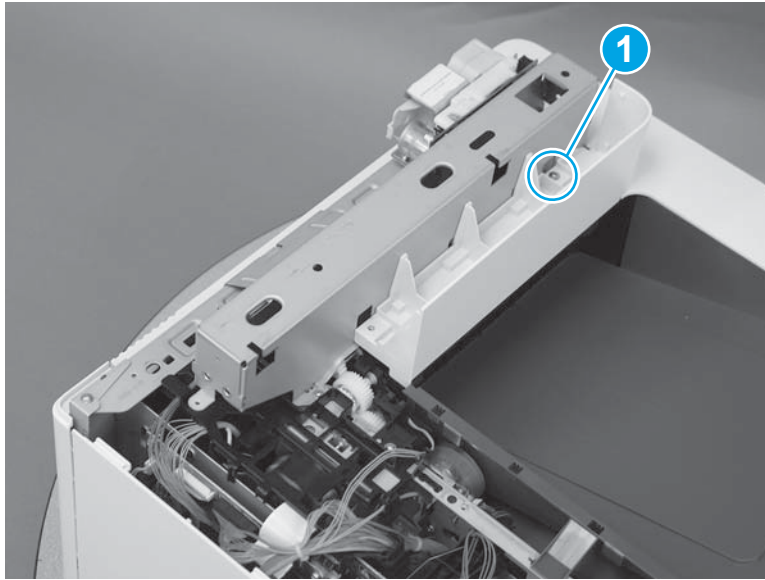

Step 25: Install the top rear cover (M577)

 **NOTE:** This step is for the M577 models. For the M552 and M553 models, skip this step and go to [Step 33: Install the upper cover \(M553\)](#) on page 676.

1. Align the locator tabs (callout 1) on the cover with the slots (callout 2) in the printer.

Figure 1-1137 Align the locator tabs

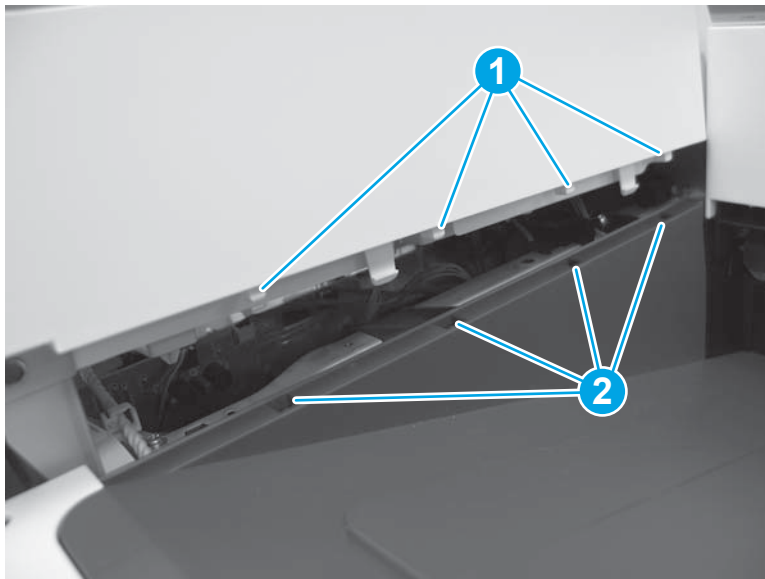

2. Press down to install the cover. Make sure that the tabs snap into place.

Figure 1-1138 Install the cover

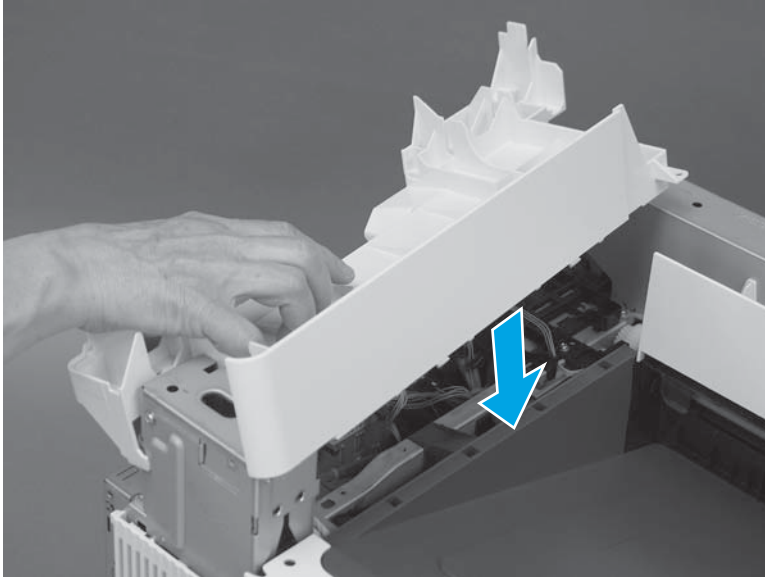

3. At the top of the printer, install five screws (callout 1).

Figure 1-1139 Install five screws

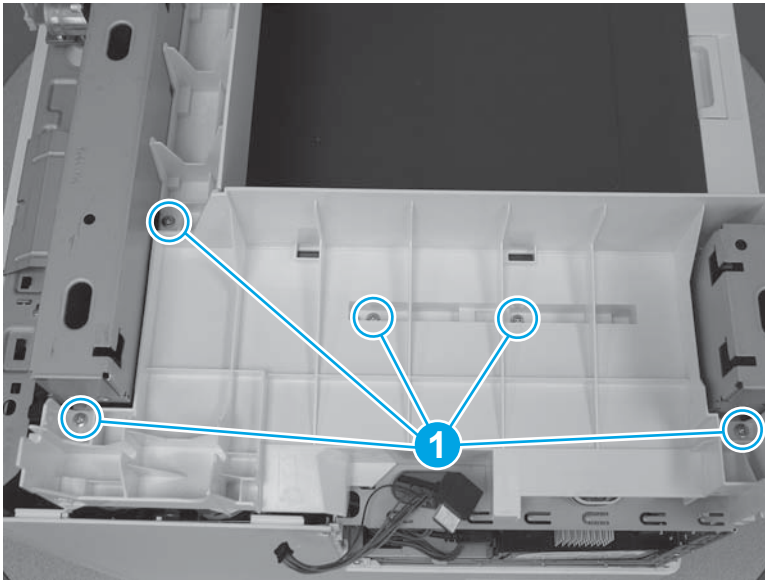

Step 26: Install the right upper cover (M577)



NOTE: This step is for the M577 models. For the M552 and M553 models, skip this step and go to [Step 33: Install the upper cover \(M553\) on page 676](#).



NOTE: The figures below show the image scanner installed. The procedures for removing and installing the right upper cover are the same whether the image scanner is installed or removed."

1. **M577c/f/z only:** Install the cables (callout 1) through the slot (callout 2) in the printer.

Figure 1-1140 Install the cables

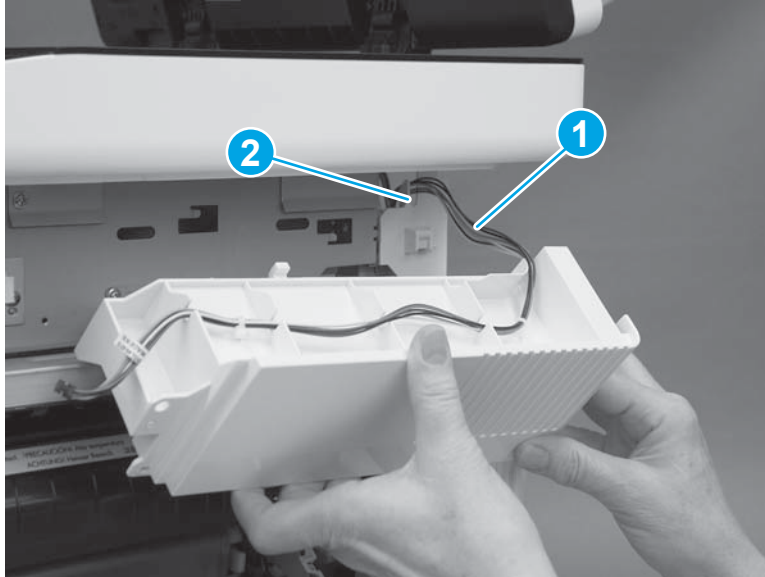

2. Position the hooks (callout 1) on the cover in the slots (callout 2) in the printer.

Figure 1-1141 Position the hooks

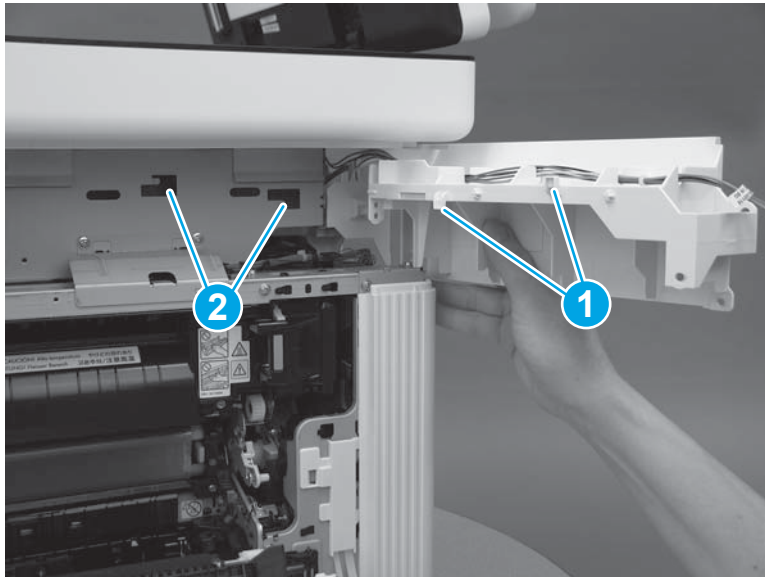

3. Slide the cover toward the front of the printer to install it.

Figure 1-1142 Install the cover

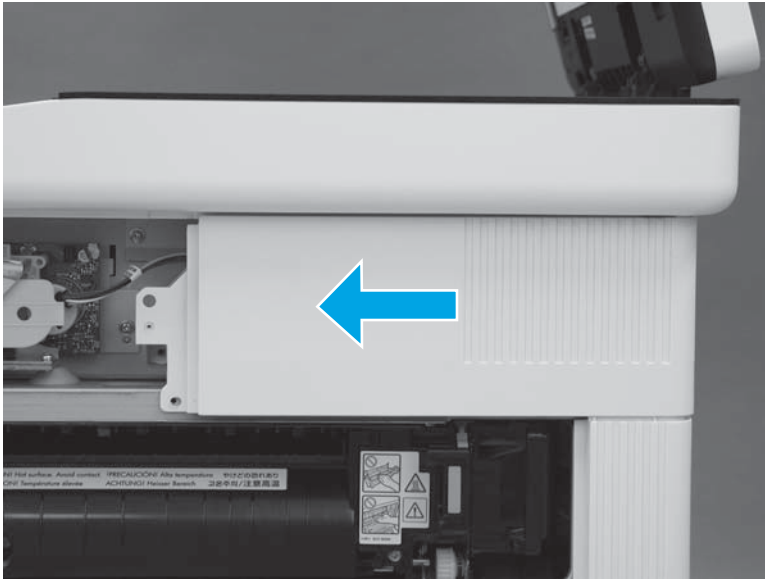

4. At the back of the printer, install one screw (callout 1).

M577c/f/z only: Connect one connector (callout 2), if the integrated scanner assembly is installed.

TIP: This screw is smaller than the screws installed in the next step. Make sure that this screw is installed in the correct position.

Figure 1-1143 Install one screw and connector

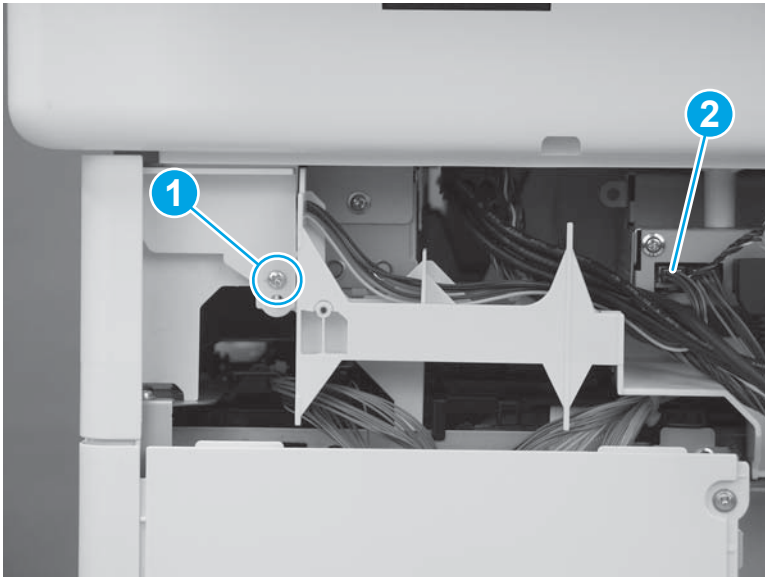

5. At the right side of the printer, install two screws (callout 1).

M577c/f/z only: Connect one connector (callout 2), if the stapler is installed.

Figure 1-1144 Install one screw and connector

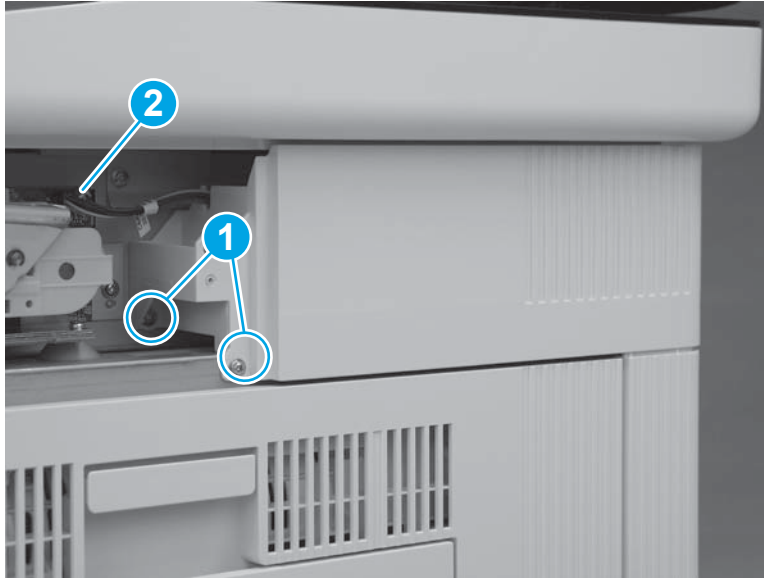

Step 27: Install the stapler unit (M577f and M577z)

 **NOTE:** This step is for the M577f and M577z models only. For the M577dn model, skip this step and go to [Step 28: Install the integrated scanner assembly \(M577\) on page 666](#).

For the M552 and M553 models, skip this step and go to [Step 33: Install the upper cover \(M553\) on page 676](#).

1. Position the hooks (callout 1) on the stapler unit in the slots (callout 2) in the printer.

Figure 1-1145 Position the hooks in the slots

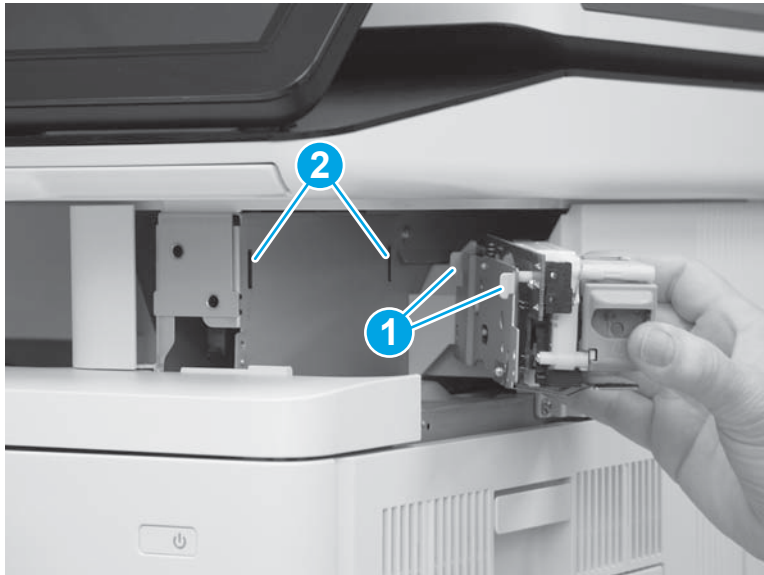

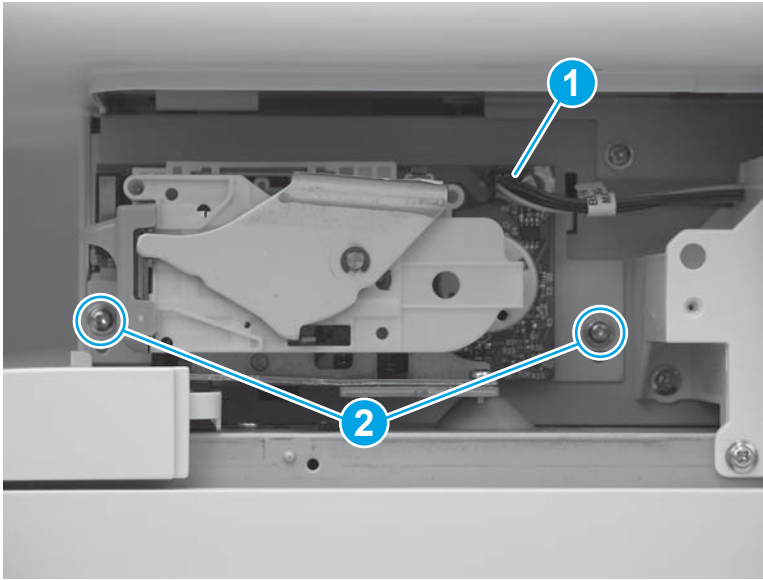

2. Connect one connector (callout 1), and then install two screws (callout 2).

Figure 1-1146 Connect connector and install screws



Step 28: Install the integrated scanner assembly (M577)

 **NOTE:** This step is for the M577 models. For the M552 and M553 models, skip this step and go to [Step 33: Install the upper cover \(M553\) on page 676](#).

 **NOTE:** The ISA includes the document feeder, image scanner, scanner control board (SCB), control panel, keyboard (M577c/z) and NFC PCA (M577z).

1. Before proceeding, locate the mounting pins (callout 1) on the bottom of the ISA and the slots (callout 2) on the printer base.

Figure 1-1147 Locate the ISA mounting pins and slots

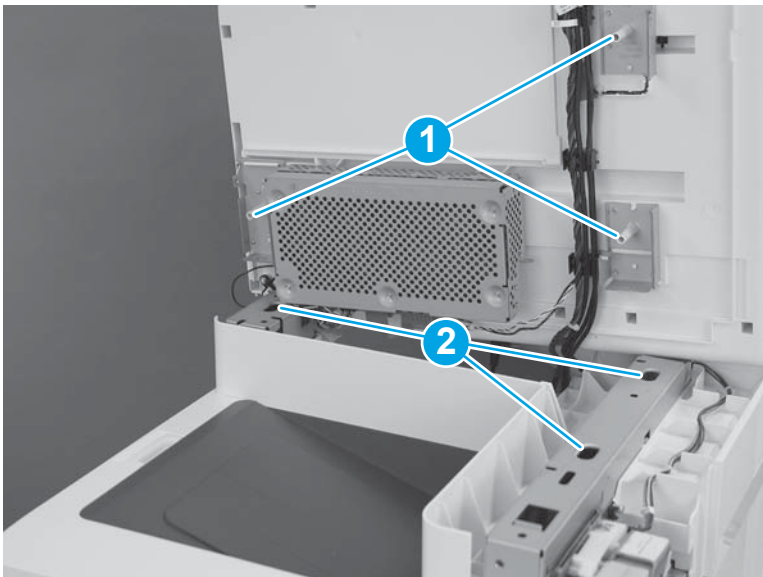

2. Position the ISA on the printer base with the pins in the slots.



NOTE: To locate the pins and slots, see [Figure 1-395 Locate the ISA mounting pins and slots on page 250](#).

Figure 1-1148 Install the ISA



3. Slightly slide the ISA towards the front of the printer to engage it.

Figure 1-1149 Slide the ISA towards the front of the printer

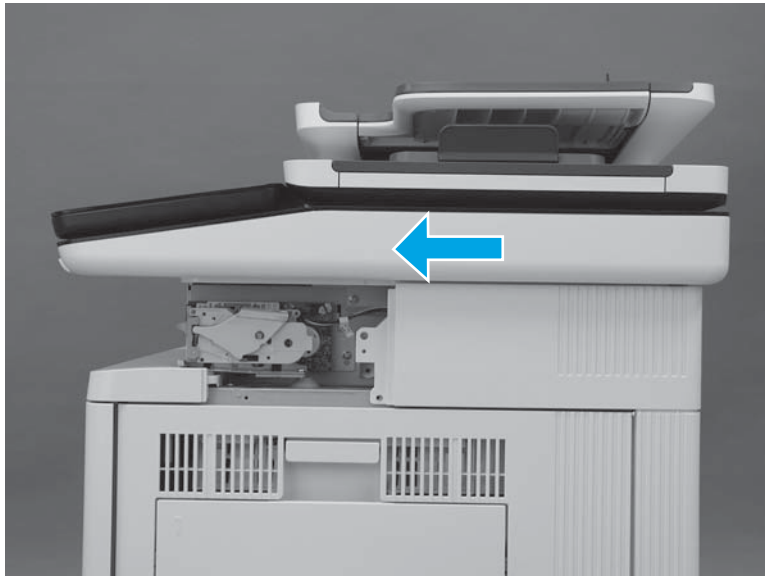

4. At the left side of the printer, install one screw (callout 1).

Figure 1-1150 Install one screw

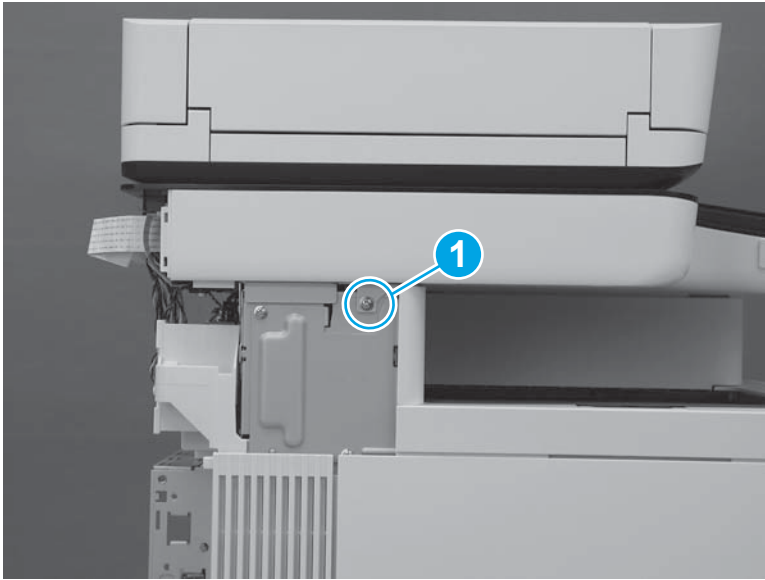

5. At the back of the printer, install two screws (callout 1).

Figure 1-1151 Install two screws

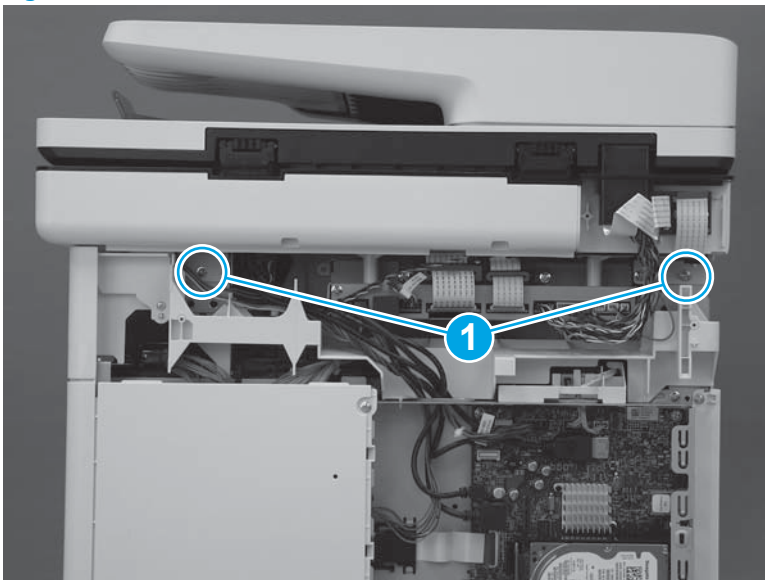

6. At the right side of the printer, install one screw (callout 1).

Figure 1-1152 Install one screw

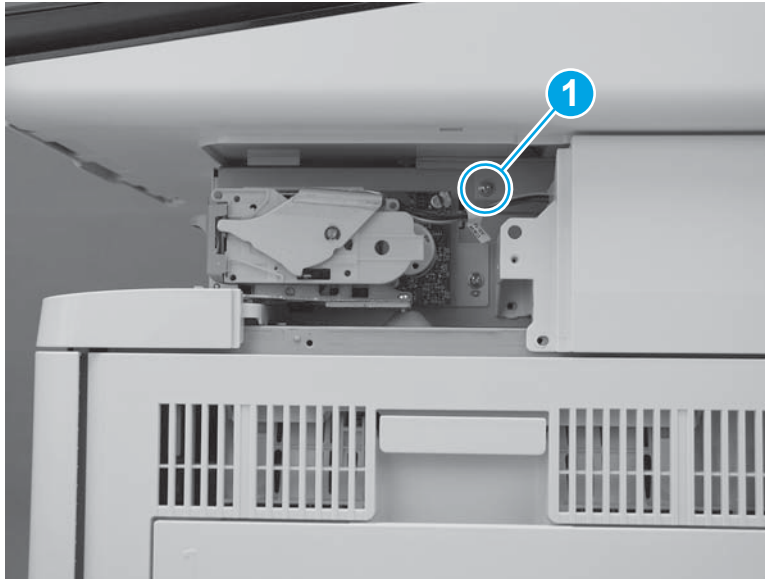

7. Connect two connectors on the scanner control board (callout 1).

M577c/f/z only: Connect one connector for the stapler on the scanner control board (callout 2).

Figure 1-1153 Connect connectors

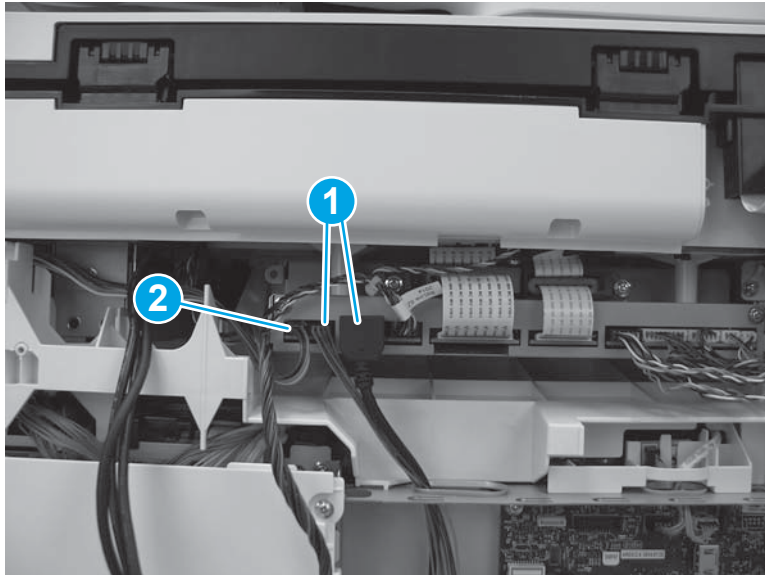

8. Install the wire harness and cables (callout 1) in the retainers (callout 2). Pass them through the opening in the top of the formatter cover (callout 3), and then connect four connectors (callout 4) on the formatter.

Figure 1-1154 Connect four connectors

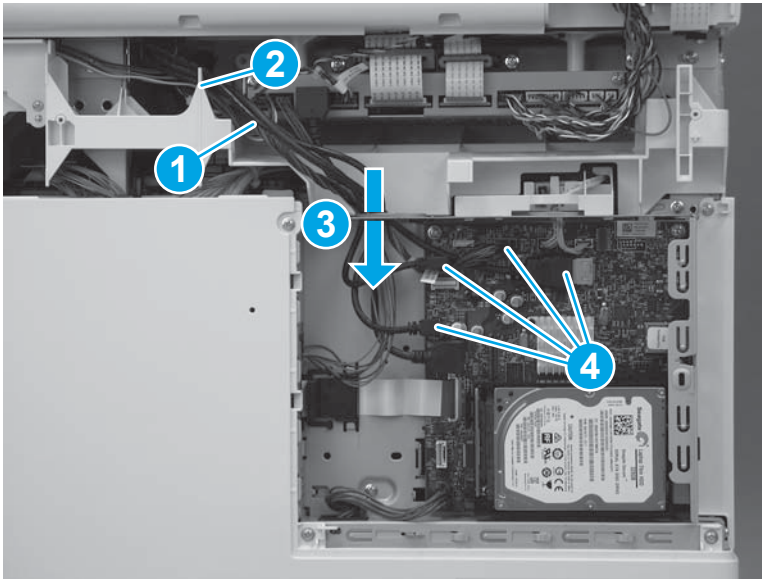

Step 29: Install the stapler cover assembly (M577c/f/z)

 **NOTE:** This step is for the M577c/f/z models only. For the M577dn model, skip this step and go to [Step 30: Install the right front upper cover \(M577dn\) on page 671](#).

For the M552 and M553 models, skip this step and go to [Step 33: Install the upper cover \(M553\) on page 676](#).

1. Install the tabs (callout 1) on the cover in the slots (callout 2) in the printer.

Figure 1-1155 Install two tabs



2. Press the cover toward the left side of the printer until it snaps into place.

Figure 1-1156 Install the cover assembly



3. Install one screw (callout 1).



 **IMPORTANT:** This is a self-tapping screw for plastic. Rotate it counterclockwise to align it with the existing thread pattern, and then carefully turn it clockwise to tighten. Do not overtighten. This will prevent stripping the threads inside the screw hole.

Figure 1-1157 Install one screw

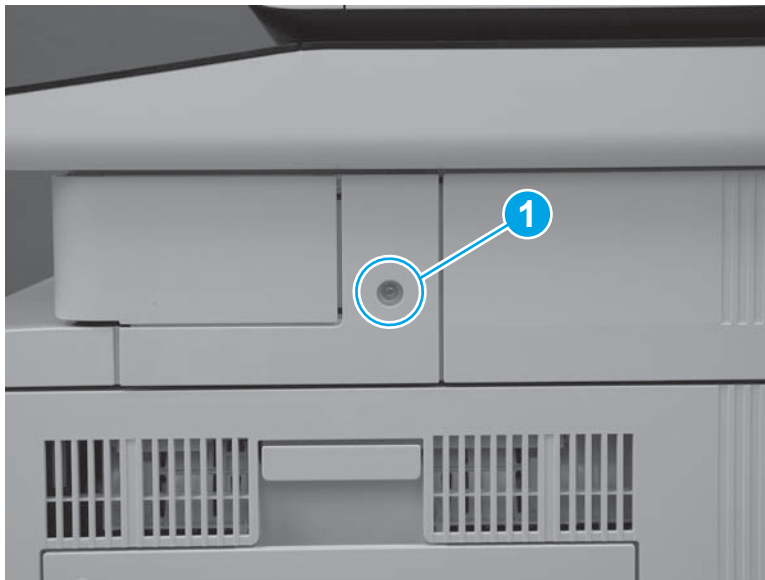

Step 30: Install the right front upper cover (M577dn)

 **NOTE:** This step is for the M577dn model only. For the M577c/f/z models, skip this step and go to [Step 31: Install the left upper cover \(M577\) on page 673](#).

For the M552 and M553 models, skip this step and go to [Step 33: Install the upper cover \(M553\) on page 676](#).

1. Slide the cover toward the left side of the printer to install it. Make sure that the slots (callout 1) in the cover fit over the tabs (callout 2) on the inside of the paper feeder cover.

Figure 1-1158 Install the cover



2. Press the right front upper cover (callout 1) and the paper feeder cover (callout 2) together until the tabs on the inside of the covers snap into place.

Figure 1-1159 Press the cover



3. Install one screw (callout 1).

Figure 1-1160 Install one screw

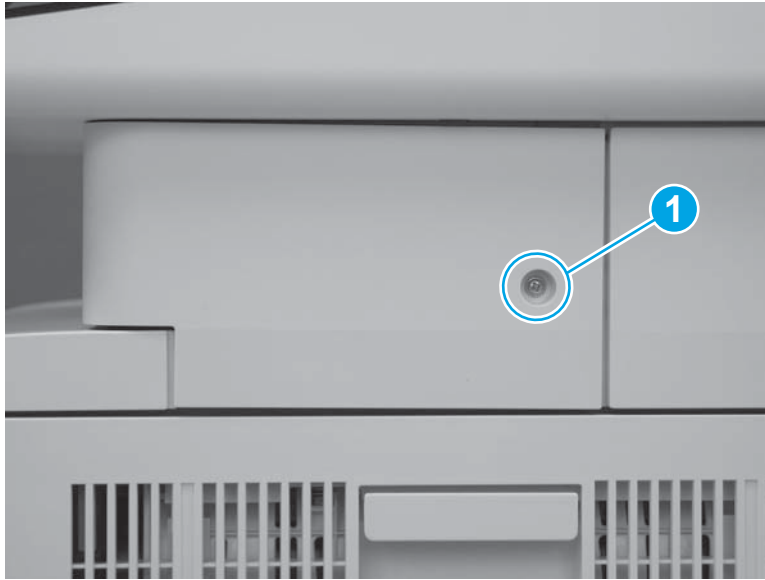

Step 31: Install the left upper cover (M577)

 **NOTE:** This step is for the M577 models. For the M552 and M553 models, skip this step and go to [Step 33: Install the upper cover \(M553\)](#) on page 676.

1. Position the tab (callout 1) on the lower edge of the cover behind the left cover (callout 2).

Figure 1-1161 Position the tab

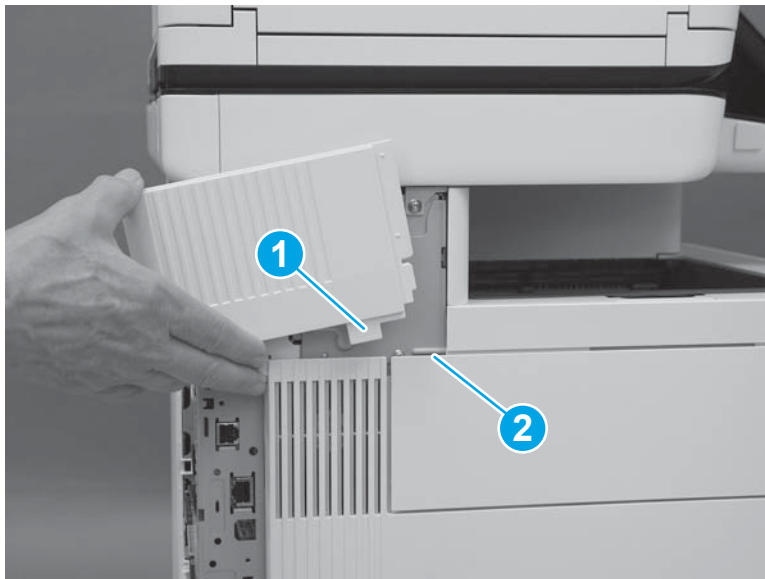

2. Slide the cover toward the front of the printer to install it. Make sure that the edge (callout 1) of the cover fits behind the edge (callout 2) of the top rear cover.

Figure 1-1162 Slide the cover

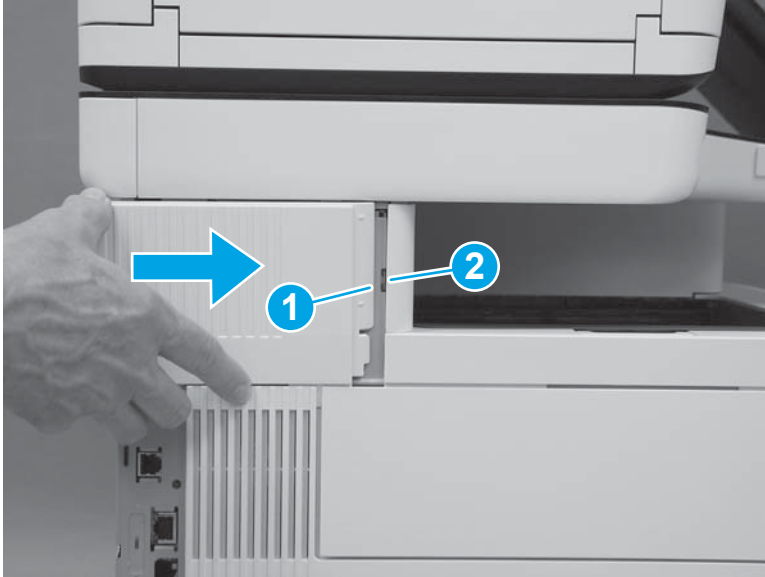

3. Make sure that the tab (callout 1) is fully installed.

Figure 1-1163 Check the tab

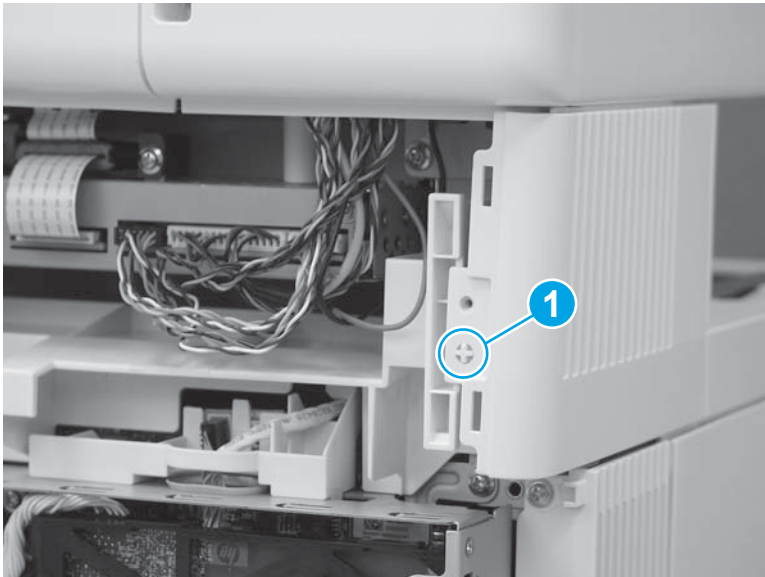

Step 32: Install the rear upper cover (M577)



NOTE: This step is for the M577 models. For the M552 and M553 models, skip this step and go to [Step 33: Install the upper cover \(M553\) on page 676](#).

1. Align the ridge (callout 1) on the lower edge of the rear upper cover in front of the tabs (callout 2) on the top edge of the rear cover.

Figure 1-1164 Align the cover

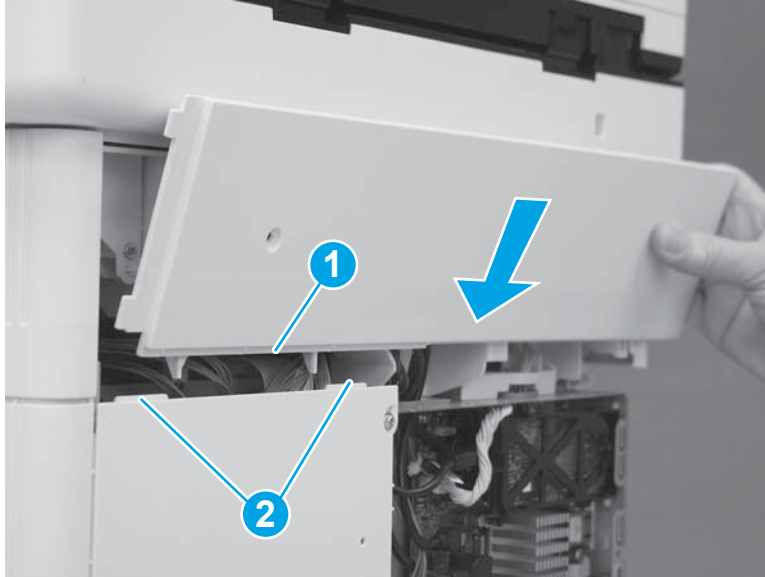

2. Rotate the top of the cover toward the printer.

Figure 1-1165 Rotate the top of the cover

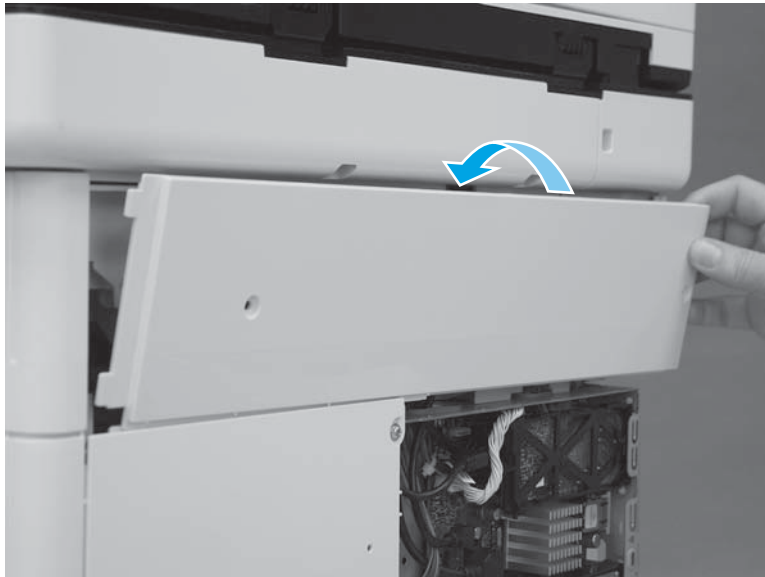

3. Slide the cover to the left (callout 1). Make sure that the tabs (callout 2) on the upper rear cover slide behind the edge (callout 3) of the right upper cover. Make sure that the cover is fully seated.

Figure 1-1166 Slide the cover

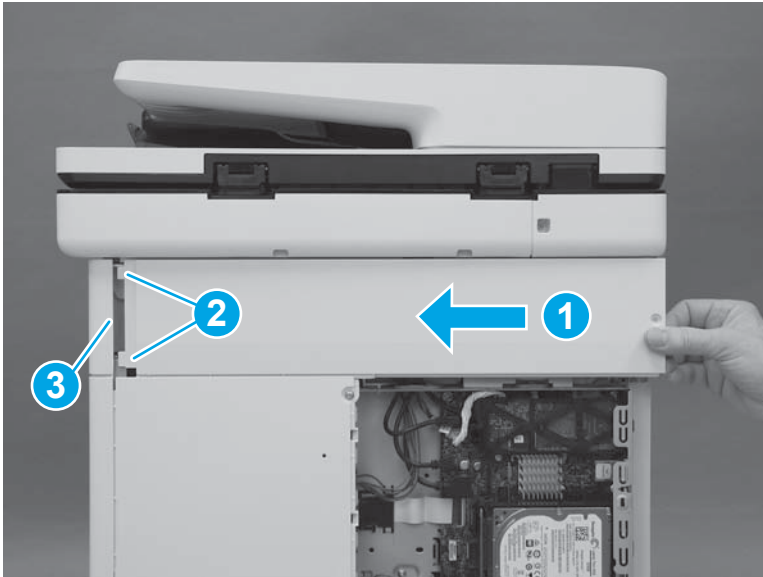

4. Install two screws (callout 1).

 **IMPORTANT:** These two screws are self-tapping screws for plastic. Rotate them counterclockwise to align them with the existing thread pattern, and then carefully turn them clockwise to tighten. Do not overtighten. This will prevent stripping the threads inside the screw holes.

Figure 1-1167 Install two screws



Step 33: Install the upper cover (M553)

 **NOTE:** This step is for the M552 and M553 models. For the M577 models, skip this step and go to [Step 38: Install the TCU on page 685](#).

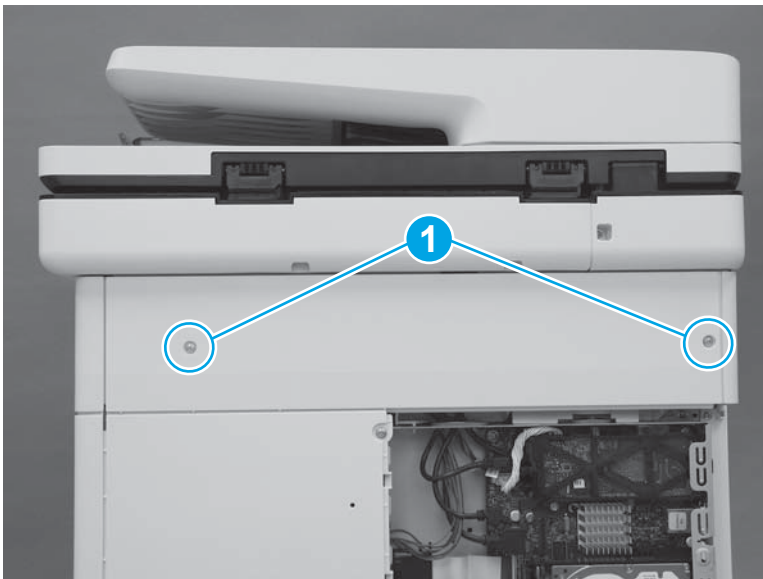
1. Position the cover on the printer.

 **NOTE:** For the M553x model, do not forget to pass the control-panel wire harness and USB cable through the opening in the cover.

Figure 1-1168 Install the cover



2. Push down on the rear corner of the cover to engage one tab (callout 1).

Figure 1-1169 Engage one tab

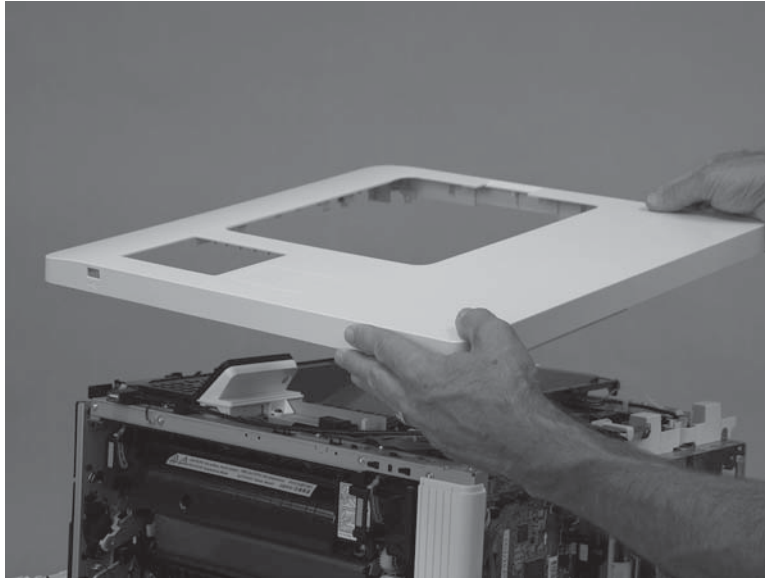
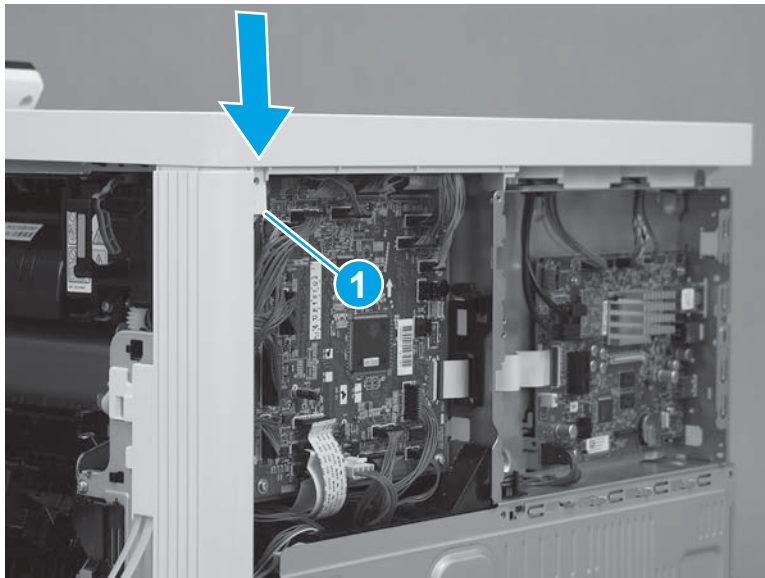

3. Push down on the front corner of the cover to engage one tab (callout 1), and then install one screw (callout 2).

 **NOTE:** This is a self-tapping plastic-thread screw. Make sure that this screw is used in this location when it is reinstalled.

Figure 1-1170 Engage one tab and install one screw



4. Install three screws (callout 1).

Figure 1-1171 Install three screws

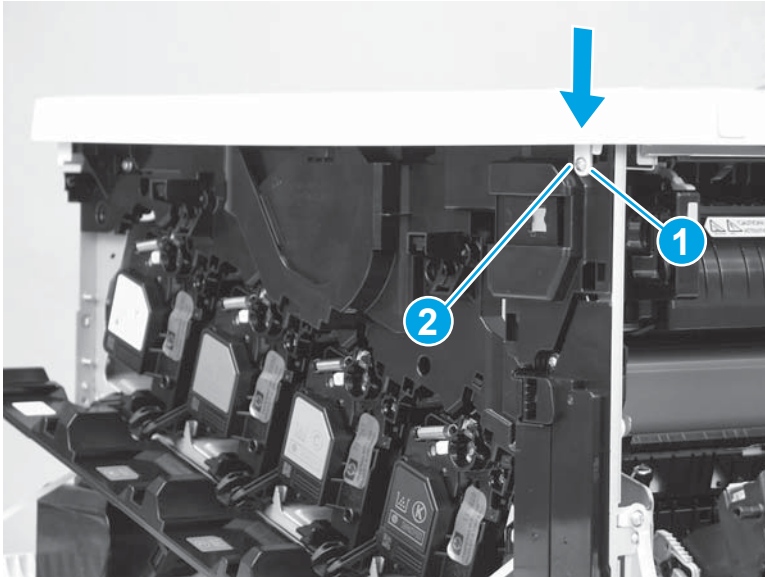
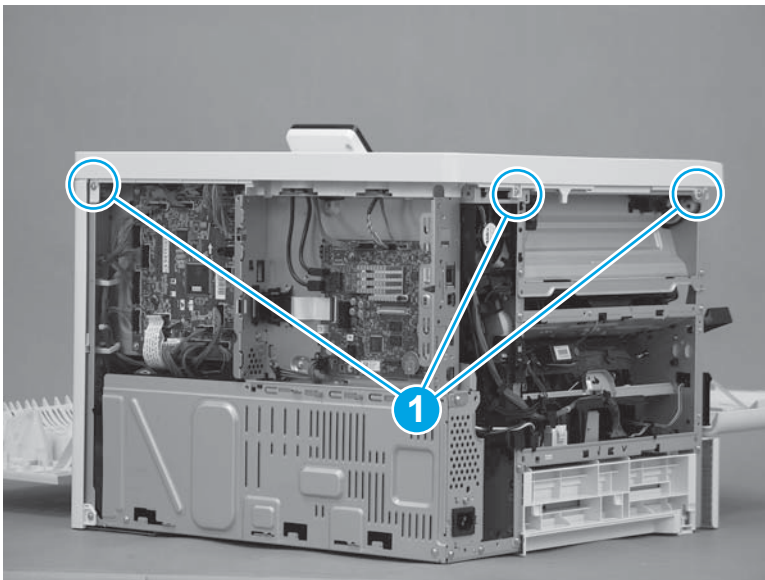

Step 34: Install the left cover (M553)

 **NOTE:** This step is for the M552 and M553 models. For the M577 models, skip this step and go to [Step 38: Install the TCU on page 685](#).

1. Position the cover on the printer.

 **NOTE:** Slightly offset the cover toward the rear of the printer.

Figure 1-1172 Install the cover

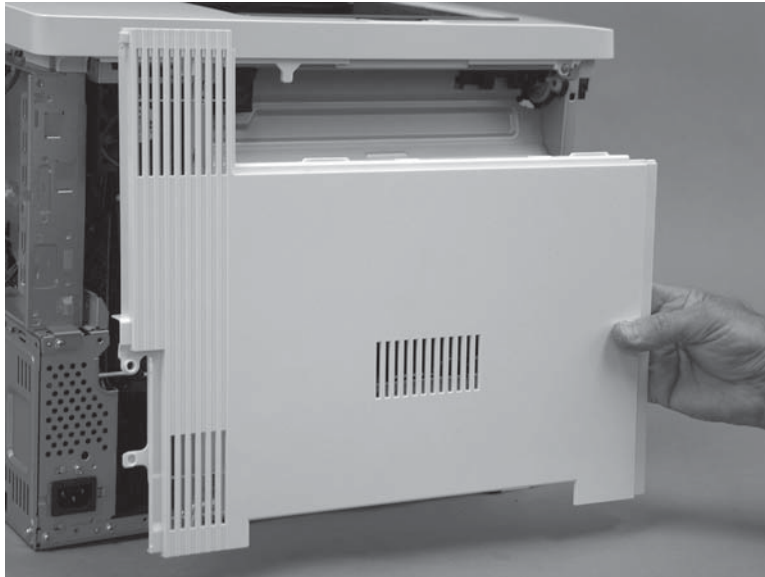

2. Slide the cover (callout 1) toward the front of the printer to engage it. Make sure that the tab (callout 2) snaps into place.

 **NOTE:** Locate the alignment pin (callout 3) on the cover from the front door side of the printer, and then make sure that it is fully engaged in the slot in the chassis.

 **TIP:** While sliding the cover into place, push in on the center of the cover (callout 1) to make sure that the hooks on the back of the cover engage with the slots in the chassis.

Figure 1-1173 Engage the cover



3. At the left side of the printer, install one screw (callout 1).

Figure 1-1174 Install one screw

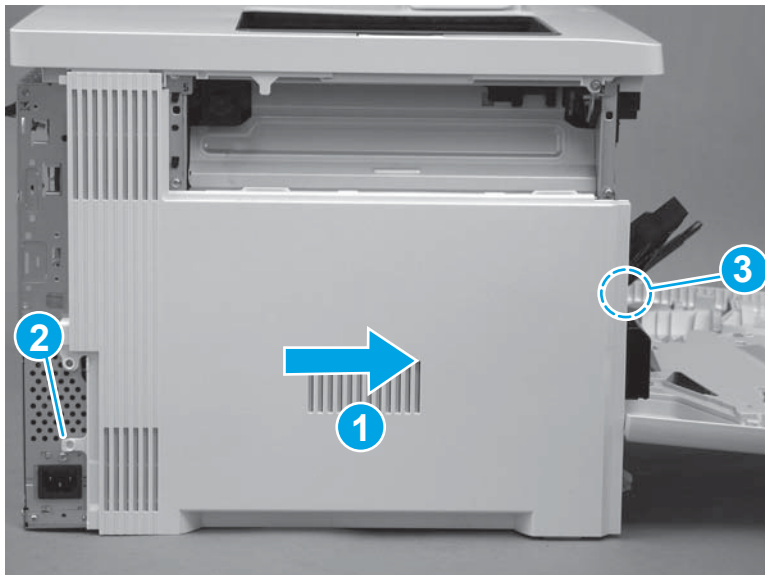

Step 35: Install the rear cover (M553)



NOTE: This step is for the M552 and M553 models. For the M577 models, skip this step and go to [Step 38: Install the TCU on page 685](#).

1. Position the top of the cover under the upper cover (callout 1), rotate the bottom of the cover onto the chassis (callout 2), and then slide the cover to the left (callout 3) to install it.

Figure 1-1175 Install the cover

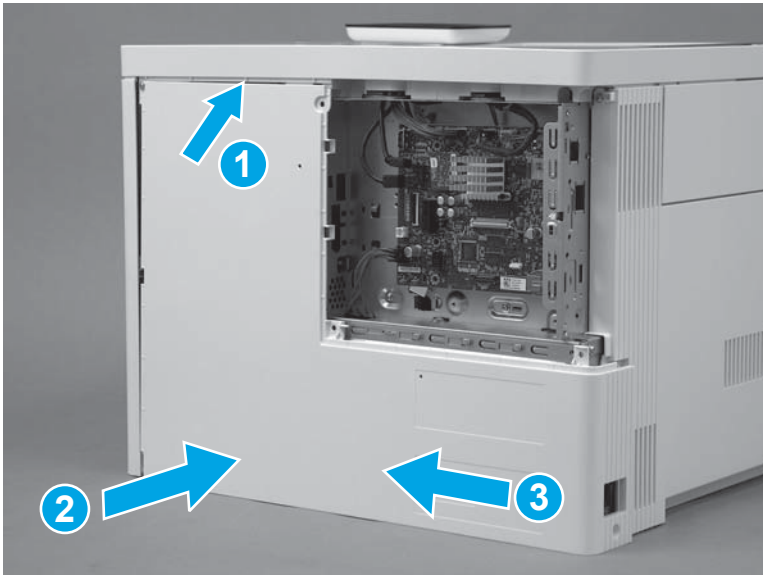

2. Install four screws (callout 1).

Figure 1-1176 Install four screws cover

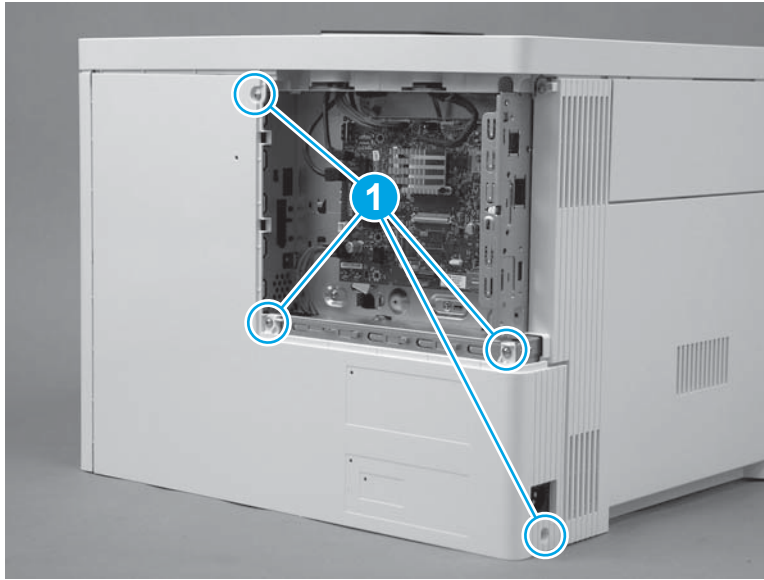

Step 36: Install the control-panel (M553x only)

 **NOTE:** For the M553n/dn and M552dn models, skip this step and go to [Step 37: Install the USB cover \(M553\)](#) on page 684.

For the M577 models, skip this step and go to [Step 38: Install the TCU](#) on page 685.

1. Place the control panel on the printer as shown.

Figure 1-1177 Place the control panel on the product

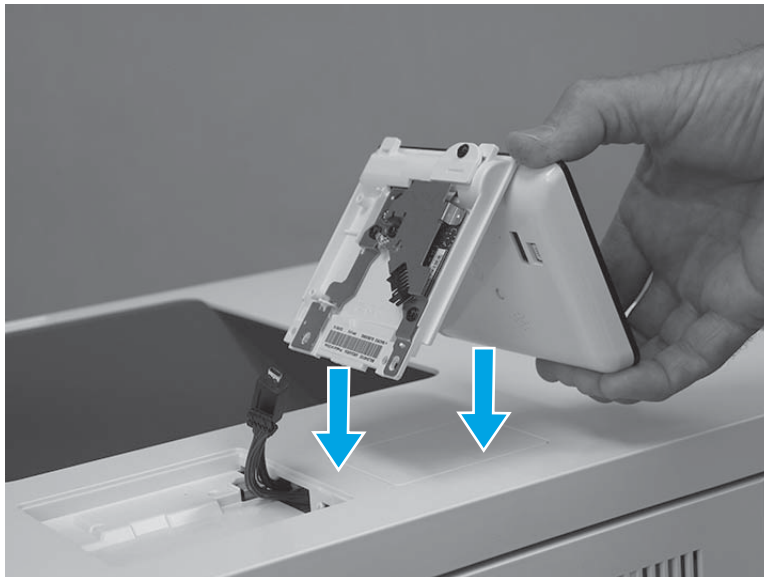

2. Connect one USB cable (callout 1), and one connector (callout 2).

 **IMPORTANT:** Take note of the location of the two mounting tabs (callout 3) on the control-panel assembly.

Figure 1-1178 Connect two connectors



3. Turn the control panel over, and then position the front edge tabs in the slots in the top cover.

Figure 1-1179 Turn the control panel over

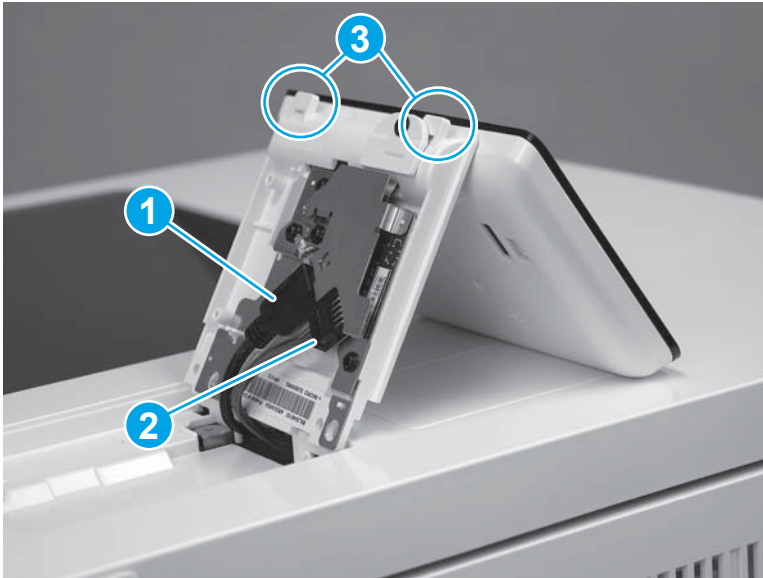
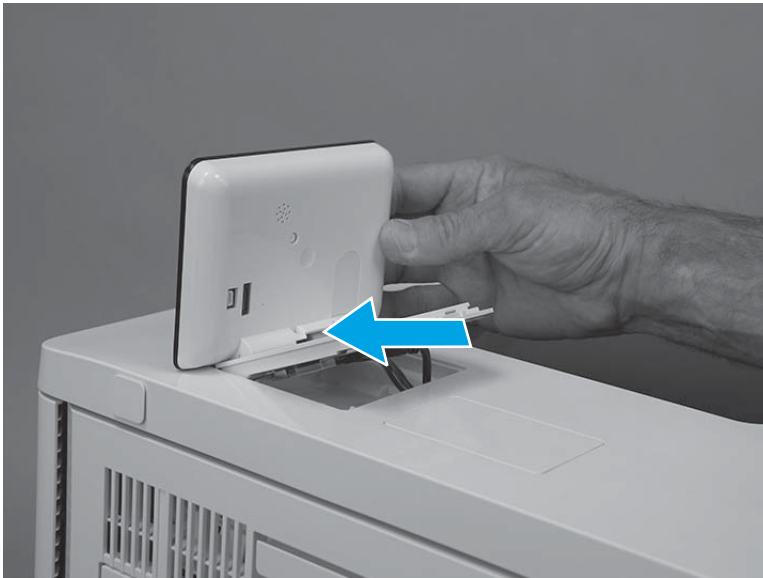

4. Rotate the control-panel base down onto the printer.

Figure 1-1180 Rotate the control-panel base down



5. Use a small Phillips screwdriver to install two screws (callout 1).

Figure 1-1181 Install two screws

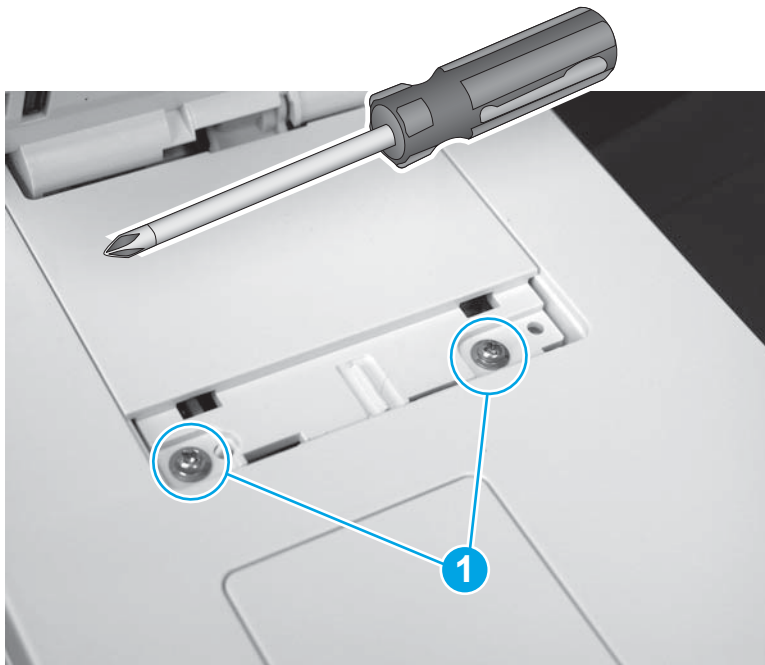

6. Position the screw cover mounting feet into the slots in the top cover (callout 1), and then rotate the cover down (callout 2) to install it.

 **NOTE:** Press down on the cover firmly to make sure that the tabs on the cover (callout 3) snap into place.

Figure 1-1182 Install the cover



Step 37: Install the USB cover (M553)

 **NOTE:** This step is for the M552 and M553 models. For the M577 models, skip this step and go to [Step 38: Install the TCU on page 685](#).

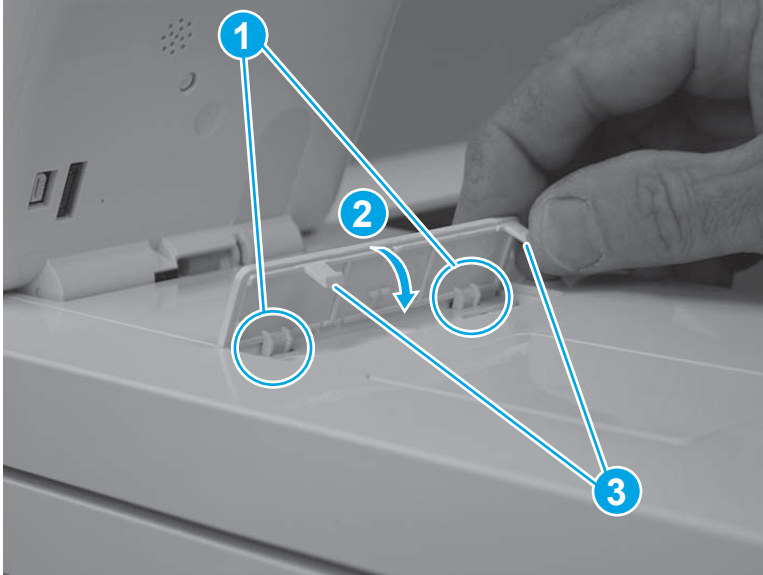
1. Push the cover into the USB port to install it.

Figure 1-1183 Install the cover



2. Make sure that the USB cover is fully seated after installing it.

Figure 1-1184 Check the installation

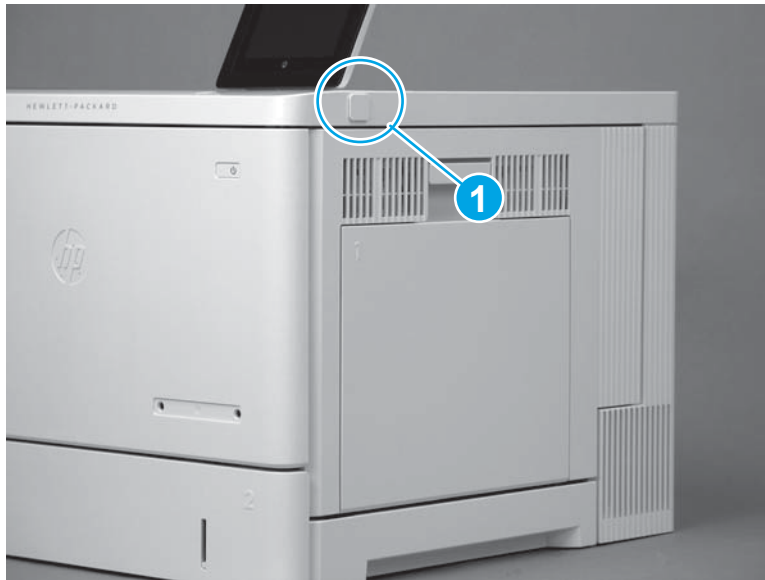

Step 38: Install the TCU

1. Verify that the toner collection hatch cover is in the closed position on the TCU.

Figure 1-1185 Verify that the toner collection hatch cover is closed

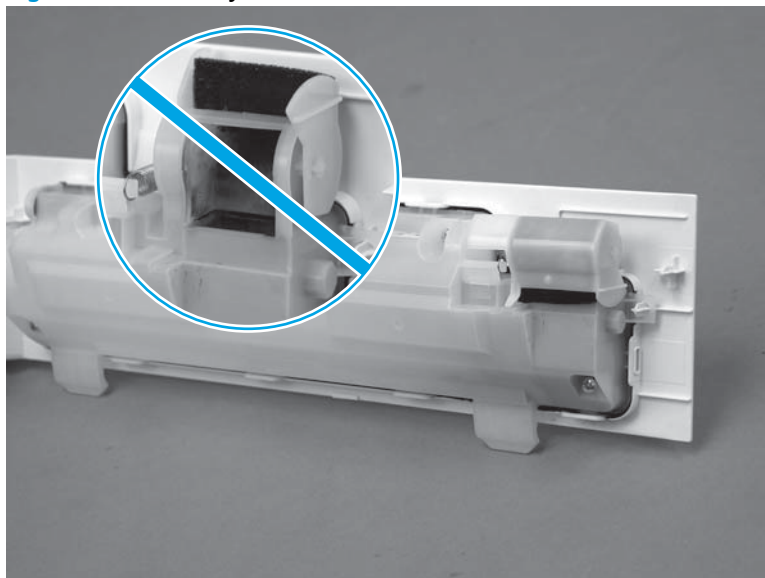

2. Position the TCU with the hinges in the slots provided in the printer (callout 1), and then rotate the TCU up and into the closed position.

 **NOTE:** The toner collection hatch cover automatically opens when the TCU is closed.

Figure 1-1186 Install the TCU



3. Close the front door.

Figure 1-1187 Close the front door

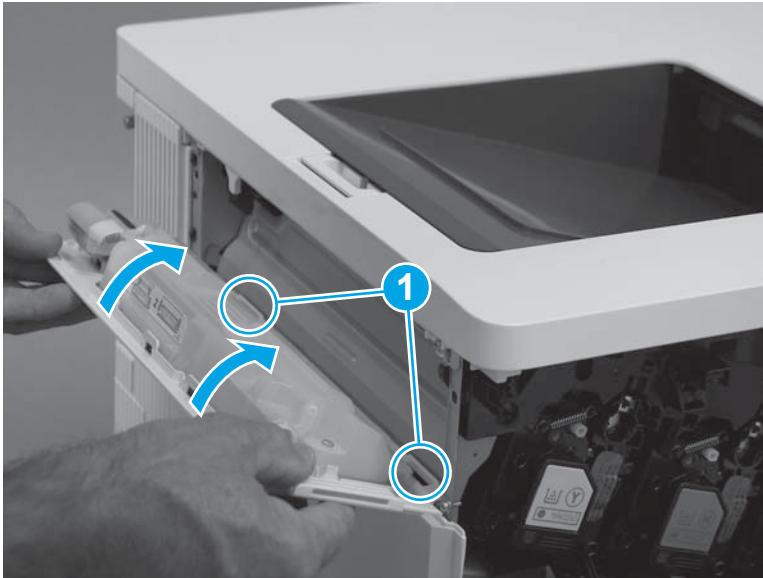

Step 39: Install the formatter cover

- ▲ Slide the cover onto the printer (callout 1) to install it.

 **NOTE:** Make sure that the tabs on the formatter cover align with the slots provided in the printer (callout 2). Tighten the two thumbscrews (callout 3).

 **TIP:** If needed, use the edge of a coin to turn the thumbscrews.

Figure 1-1188 Install the cover



Removal and replacement: Stapler unit (M577c/f/z)

- [Introduction](#)
- [Step 1: Remove the staple cartridge](#)
- [Step 2: Remove the stapler cover assembly](#)
- [Step 3: Remove the stapler unit](#)
- [Step 4: Unpack the replacement assembly](#)
- [Step 5: Install the stapler unit](#)
- [Step 6: Install the stapler cover assembly](#)
- [Step 7: Install the staple cartridge](#)

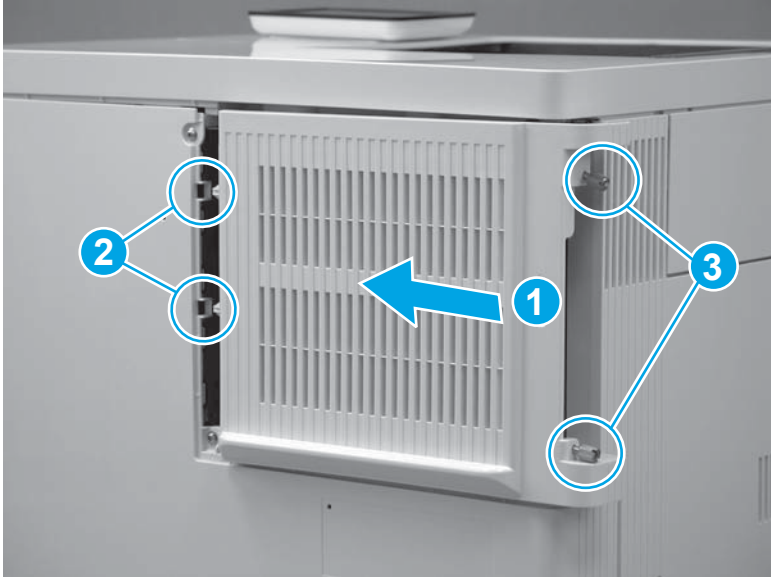
Introduction

This document provides the procedures to remove and replace the M577 stapler unit.

Before performing service

Turn the printer power off

- Disconnect the power cable.

 **WARNING!** To avoid damage to the printer, turn the printer off, wait 30 seconds, and then remove the power cord before attempting to service the printer.

Use the table below to identify the correct part number for your printer. To order the part, go to www.hp.com/buy/parts.

Stapler unit part number	
B5L46-60102	Stapler unit

Required tools

- #2 Phillips screwdriver with a magnetic tip

After performing service

Make sure that the rear upper cover is fully seated after replacing it.

Turn the printer power on

- Connect the power cable.
- Use the power switch to turn the power on.

Step 1: Remove the staple cartridge

1. Open the stapler door.

Figure 1-1189 Open the stapler door



2. Pull the staple cartridge straight out of the printer to remove it.

Figure 1-1190 Remove the staple cartridge



3. Close the stapler door.

Figure 1-1191 Close the stapler door



Step 2: Remove the stapler cover assembly

1. Remove one screw (callout 1).

 **Reinstallation tip:** This is a self-tapping screw for plastic. When reinstalling, rotate the screw counterclockwise to align it with the existing thread pattern, and then carefully turn it clockwise to tighten. Do not overtighten. This will prevent stripping the threads inside the screw hole.

Figure 1-1192 Remove one screw



2. Release two tabs at the front edge of the cover (callout 1).

Figure 1-1193 Release two tabs

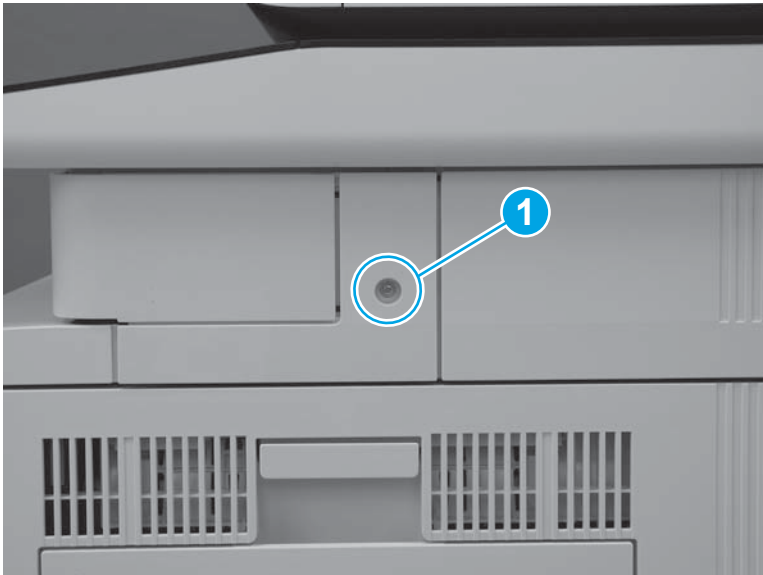

3. Release the back edge of the cover.

Figure 1-1194 Release the back edge of the cover

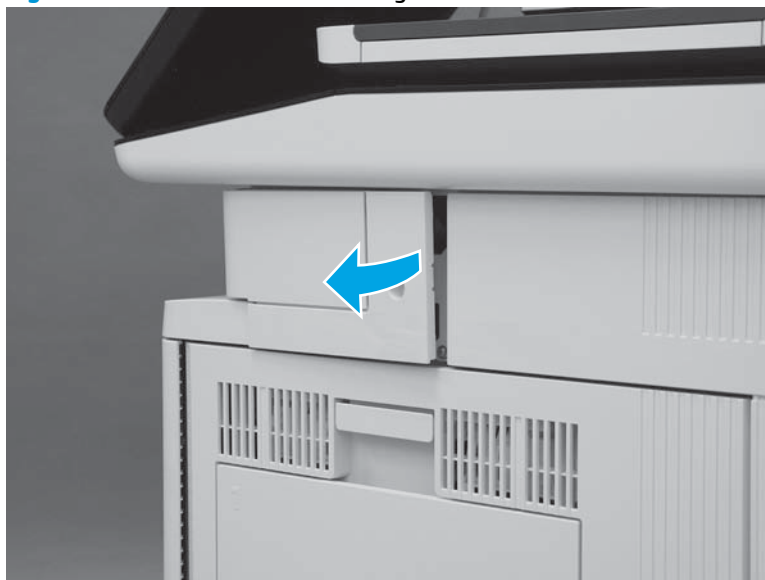

4. Rotate the cover away from the printer to remove it.

Figure 1-1195 Remove the cover



Step 3: Remove the stapler unit

1. Disconnect one connector (callout 1), and then remove two screws (callout 2).

Figure 1-1196 Disconnect connector and remove screws

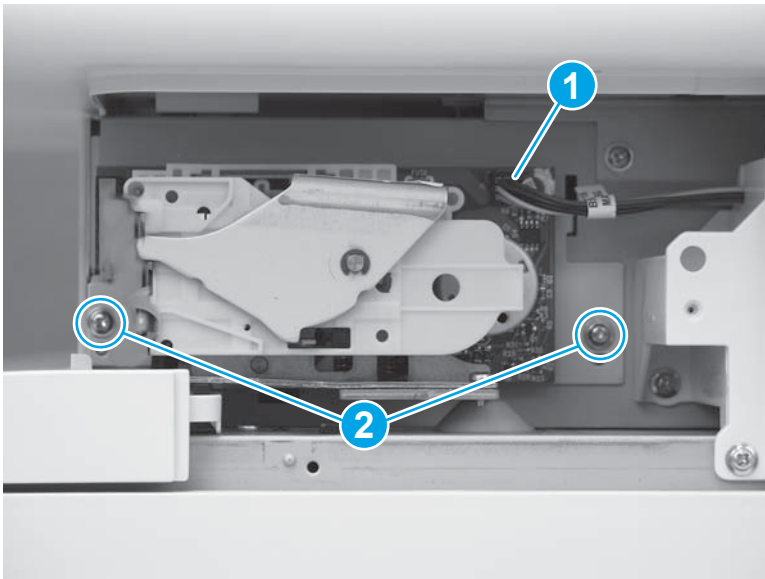

2. Slide the stapler unit up (callout 1), and then pull it away from the printer (callout 2) to remove it.

Figure 1-1197 Remove the stapler unit

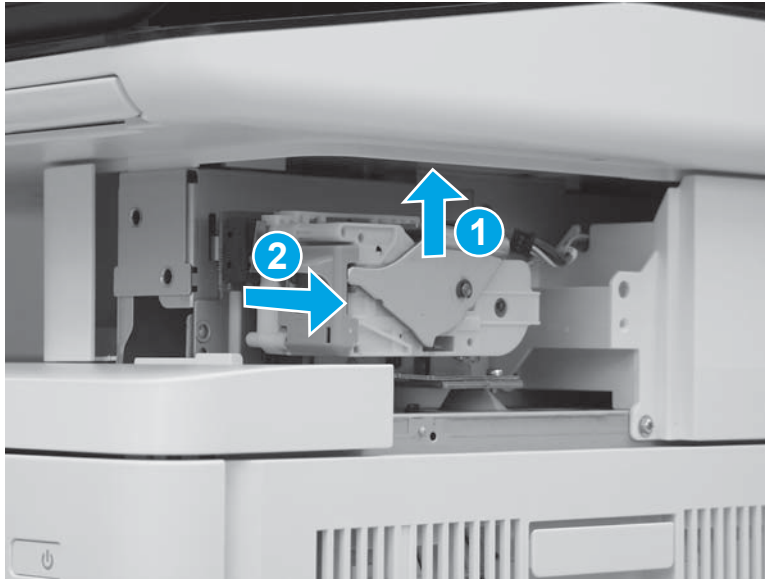

Step 4: Unpack the replacement assembly

Unpack the replacement assembly from the packaging.

For complete information on HP's recycling programs, go to [Product return and recycling](#).

 **NOTE:** HP recommends responsible disposal of the defective part.

Figure 1-1198 Recycle and unpack

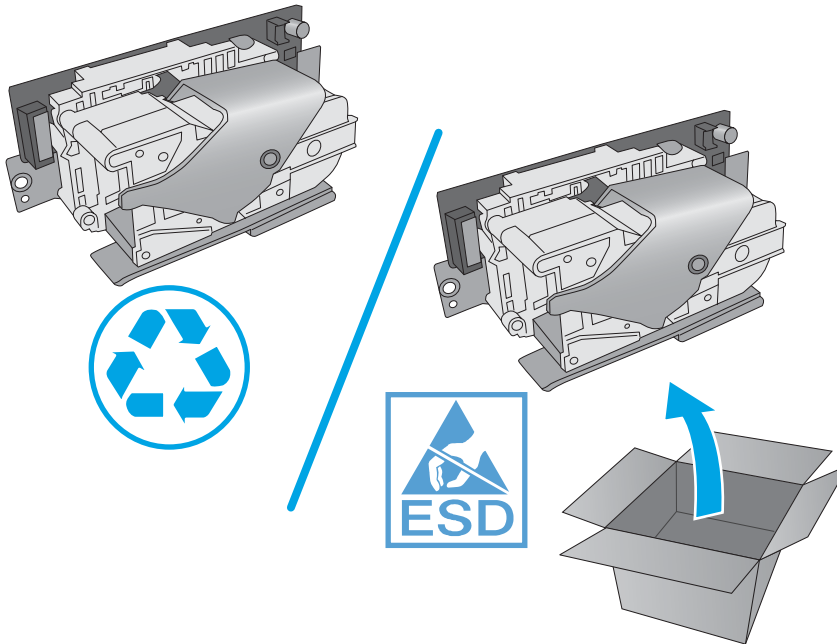

Step 5: Install the stapler unit

1. Position the hooks (callout 1) on the stapler unit in the slots (callout 2) in the printer.

Figure 1-1199 Position the hooks in the slots

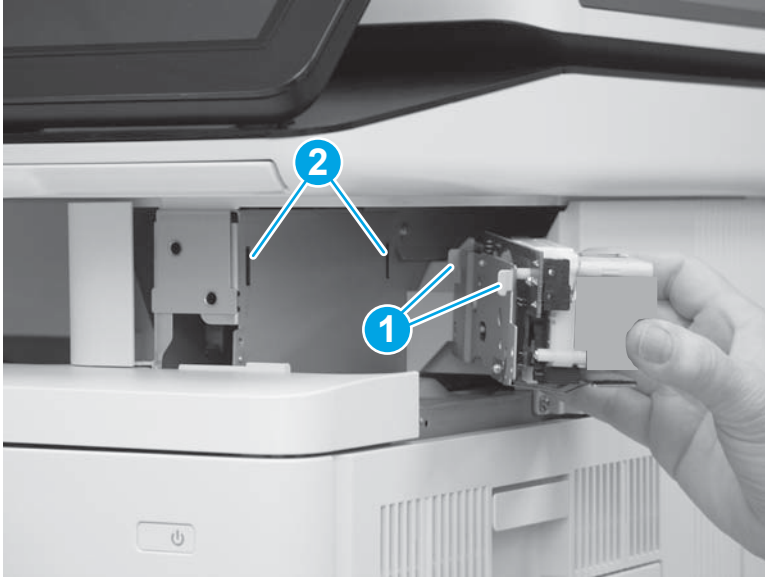

2. Connect one connector (callout 1), and then install two screws (callout 2).

Figure 1-1200 Connect connector and install screws

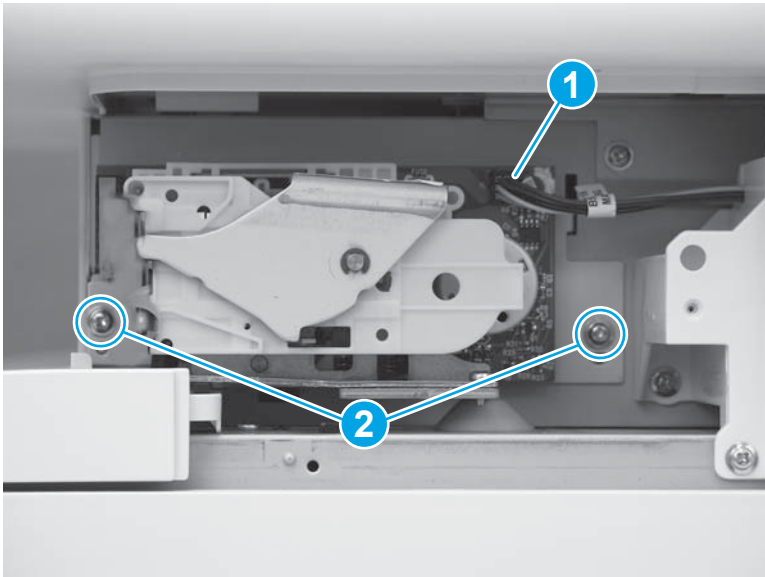

Step 6: Install the stapler cover assembly

1. Install the tabs (callout 1) on the cover in the slots (callout 2) in the printer.

Figure 1-1201 Install two tabs



2. Press the cover toward the left side of the printer until it snaps into place.

Figure 1-1202 Install the cover assembly



3. Install one screw (callout 1).

 **IMPORTANT:** This is a self-tapping screw for plastic. Rotate it counterclockwise to align it with the existing thread pattern, and then carefully turn it clockwise to tighten. Do not overtighten. This will prevent stripping the threads inside the screw hole.

Figure 1-1203 Install one screw



Step 7: Install the staple cartridge

1. Open the stapler door.

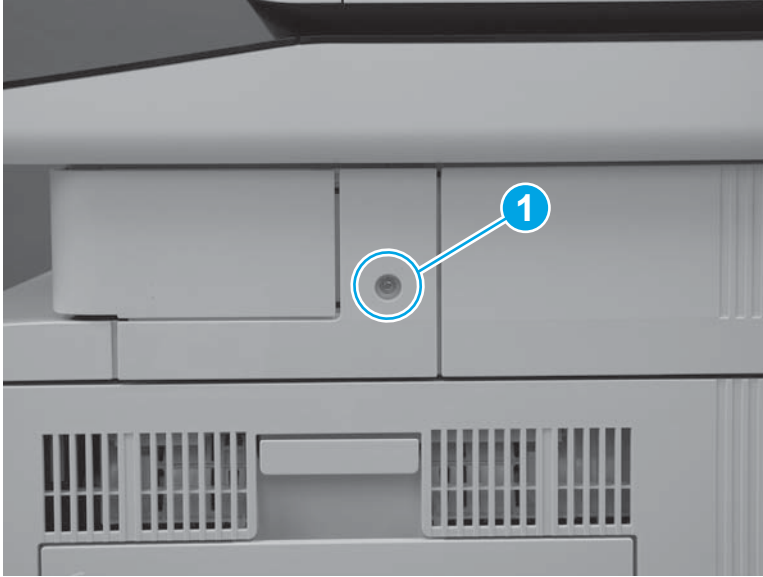
Figure 1-1204 Open the stapler door



2. Push the staple cartridge straight into the printer to install it.

Figure 1-1205 Install the staple cartridge



3. Close the stapler door.

Figure 1-1206 Close the stapler door



Removal and replacement: DC controller

- [Introduction](#)
- [Step 1: Remove the formatter cover](#)
- [Step 2: Remove the rear cover \(M552 and M553\)](#)
- [Step 3: Remove the rear upper cover \(M577\)](#)
- [Step 4: Remove the rear cover \(M577\)](#)
- [Step 5: Remove the DC controller](#)
- [Step 6: Unpack the replacement assembly](#)
- [Step 7: Install the DC controller](#)
- [Step 8: Install the rear cover \(M577\)](#)
- [Step 9: Install the rear upper cover \(M577\)](#)
- [Step 10: Install the rear cover \(M552 and M553\)](#)
- [Step 11: Install the formatter cover](#)

Introduction



This document provides the procedures to remove and replace the DC controller.

Before performing service

Turn the printer power off

- Disconnect the power cable.

 **WARNING!** To avoid damage to the printer, turn the printer off, wait 30 seconds, and then remove the power cord before attempting to service the printer.

 **CAUTION:**  This part contains components that are electrostatic discharge (ESD) sensitive. To reduce the possibility of ESD damage, always touch the sheet-metal chassis to ground yourself before touching an ESD sensitive part.

 **IMPORTANT:** Do not replace the formatter, DC controller, and eMMC PCA or hard-disk drive simultaneously during a single printer servicing. Doing so might cause the printer to become unstable or inoperable.

Use the table below to identify the correct part number for your printer, and then go to <http://h20141.www2.hp.com/hpparts> to order the part.

DC controller part number

RM2-7186-000CN	DC controller (M552, M553)
RM2-7187-000CN	DC controller (M577)

Required tools

- #2 Phillips screwdriver with a magnetic tip

After performing service

Make sure that all of the connectors on the DC controller are fully seated.

Make sure that the formatter cover is fully seated, and that the thumbscrews are finger tight after replacing it.

Turn the printer power on

- Connect the power cable.
- Use the power switch to turn the power on.

Post service test

Print a configuration page to make sure that the printer is functioning correctly.

Step 1: Remove the formatter cover

1. Locate the formatter cover.

Figure 1-1207 Locate the formatter cover

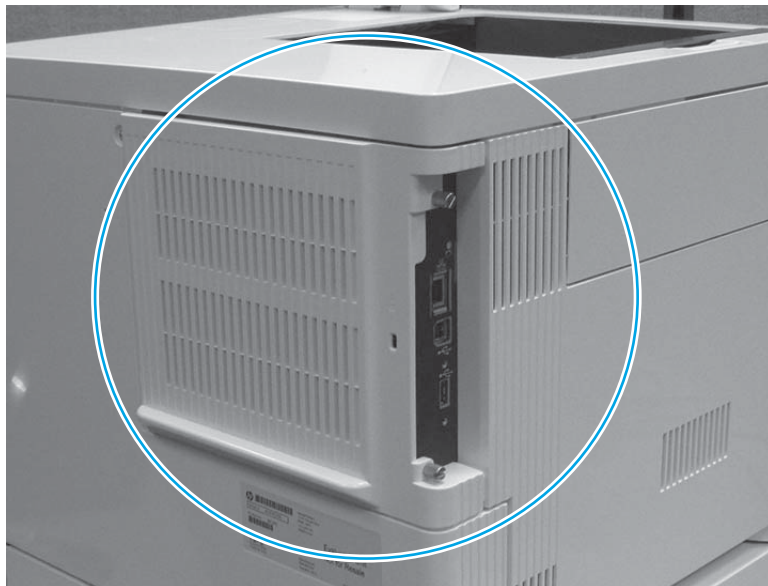

2. Loosen the two thumbscrews (callout 1). Grasp the two thumbscrews, and then slide the cover away from the printer (callout 2) to remove it.



 **TIP:** If needed, use the edge of a coin to turn the thumbscrews.

Figure 1-1208 Loosen the thumbscrews

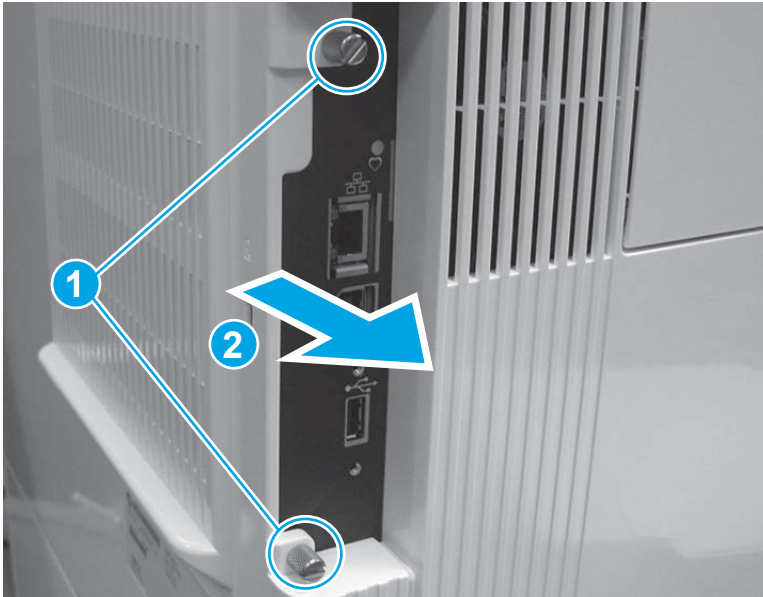

Step 2: Remove the rear cover (M552 and M553)

 **NOTE:** This step is for the M552 and M553 models. For the M577 models, skip this step and go to [Step 3: Remove the rear upper cover \(M577\) on page 701](#).

1. Remove four screws (callout 1).

Figure 1-1209 Remove four screws

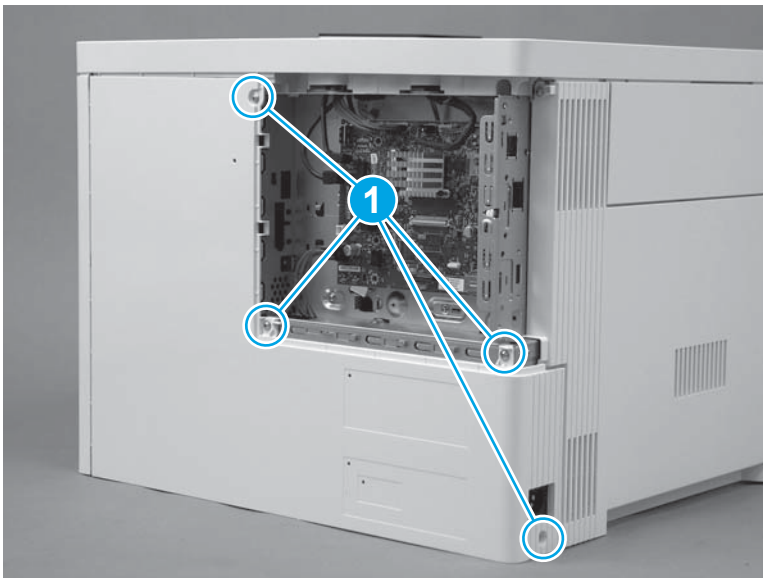

2. Slightly slide the cover to the right (callout 1), rotate the bottom of the cover away from the printer (callout 2), and then pull the top of the cover away from the printer (callout 3) to remove the cover.

Figure 1-1210 Remove the cover

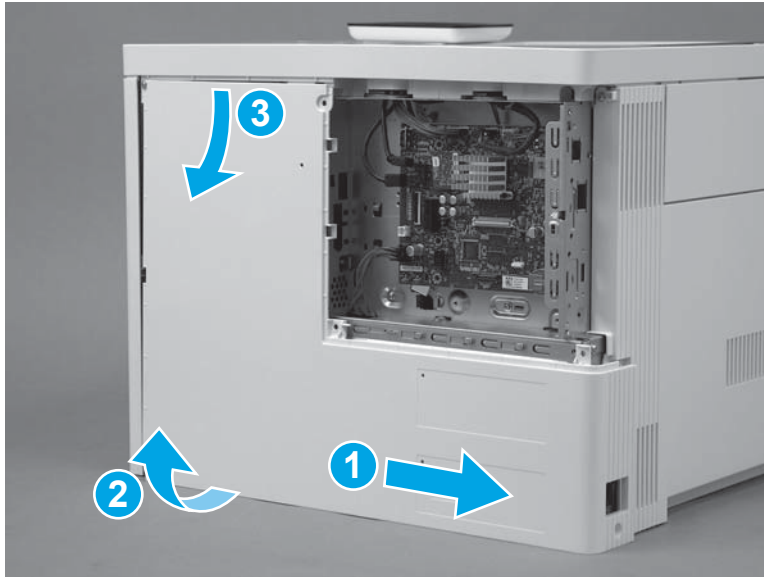

Step 3: Remove the rear upper cover (M577)

 **NOTE:** This step is for the M577 models. For the M552 and M553 models, skip this step and go to [Step 5: Remove the DC controller on page 704](#).

1. Remove two screws (callout 1).

 **Reinstallation tip:** These two screws are self-tapping screws for plastic. When reinstalling them, rotate the screws counterclockwise to align them with the existing thread pattern, and then carefully turn them clockwise to tighten. Do not overtighten. This will prevent stripping the threads inside the screw holes.

Figure 1-1211 Remove two screws



2. Use a small, flat blade screwdriver to release the right edge of the cover.

Figure 1-1212 Release the right edge

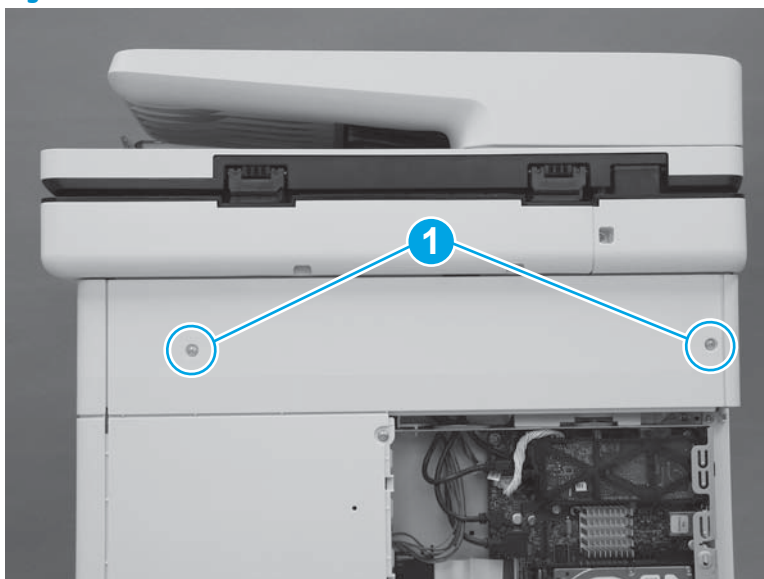
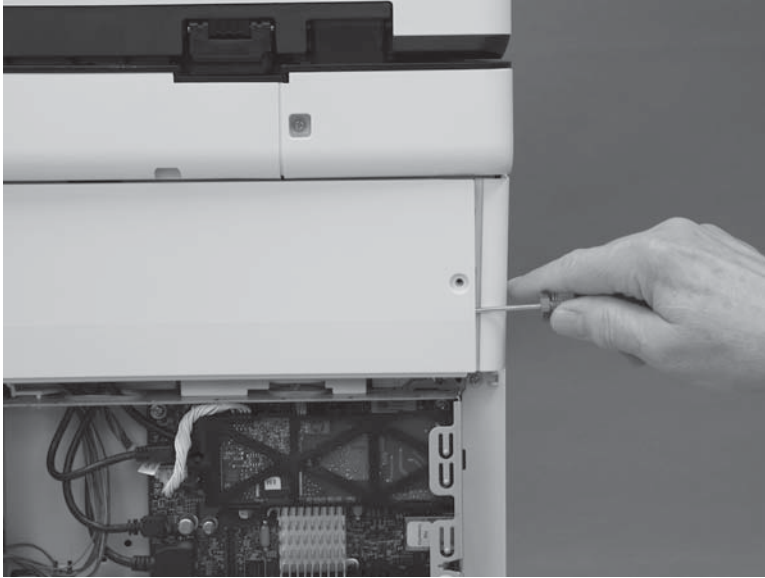

3. Pull the right edge of the cover (callout 1) away from the printer, and then slide the cover to the right (callout 2).

Figure 1-1213 Slide the cover right

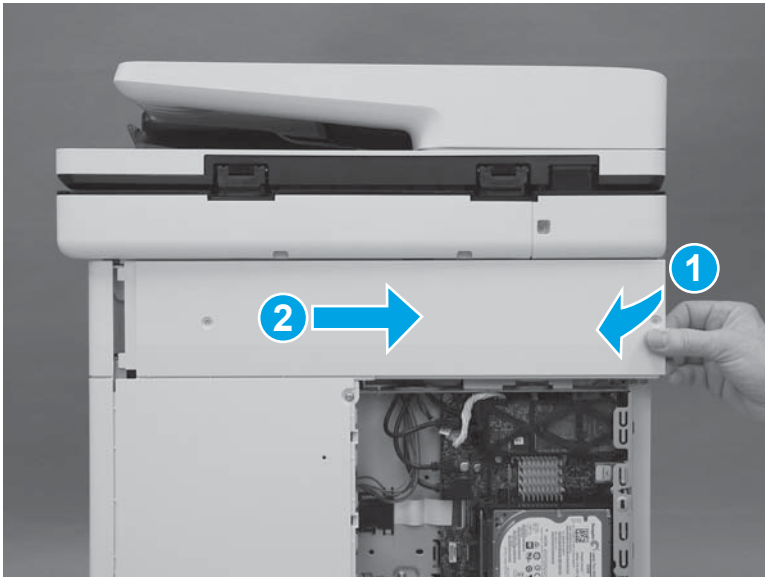

4. Remove the cover.

Figure 1-1214 Remove the cover

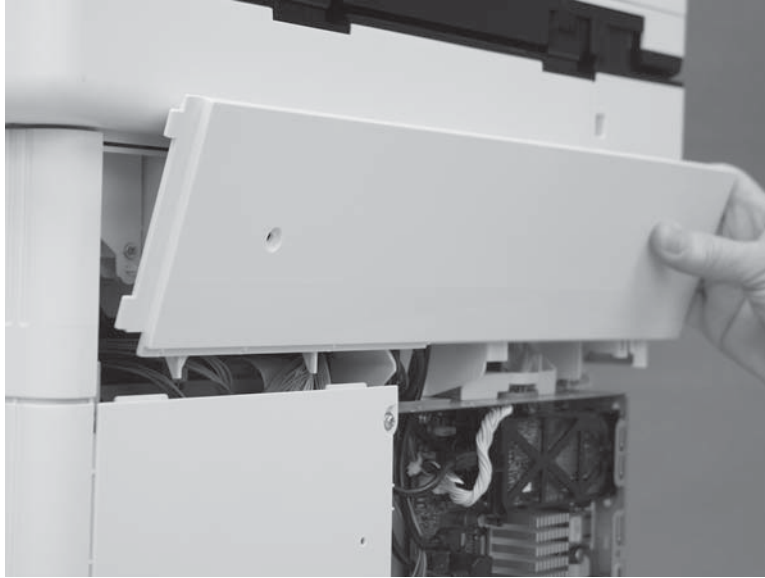

Step 4: Remove the rear cover (M577)



NOTE: This step is for the M577 models. For the M552 and M553 models, skip this step and go to [Step 5: Remove the DC controller on page 704](#).

1. Remove four screws (callout 1).

Figure 1-1215 Remove four screws

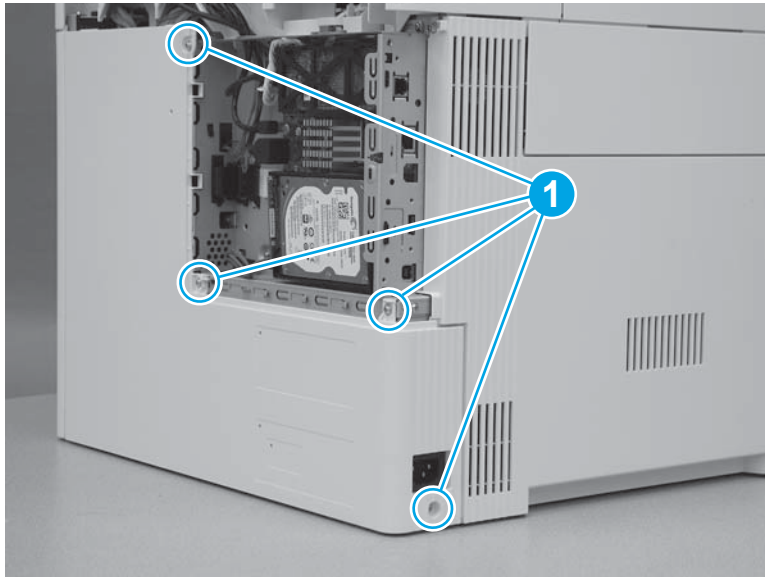

2. Slide the cover to the right to remove it.

Figure 1-1216 Remove the cover

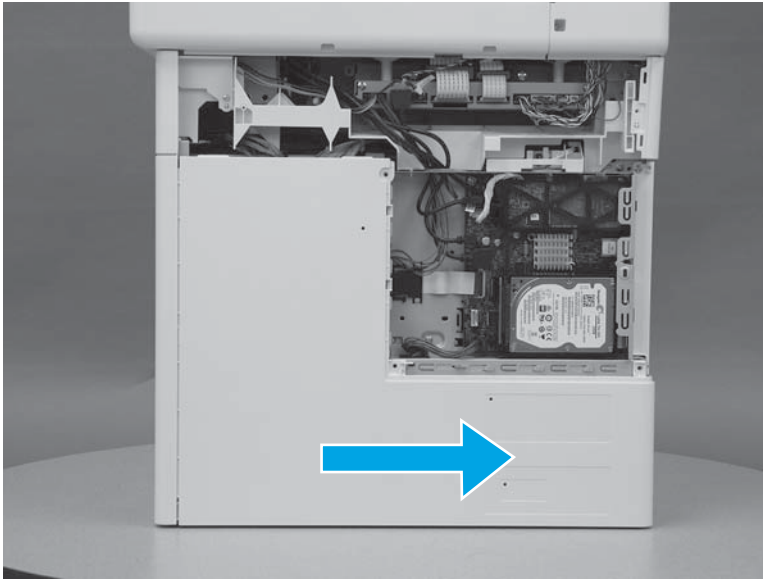

Step 5: Remove the DC controller

CAUTION:  ESD-sensitive part.

1. Disconnect 18 connectors on the DC controller. The flat cables will be disconnected in the next step.
The following connectors are empty:

- J140, J141, and J143

Figure 1-1217 Disconnect 18 connectors

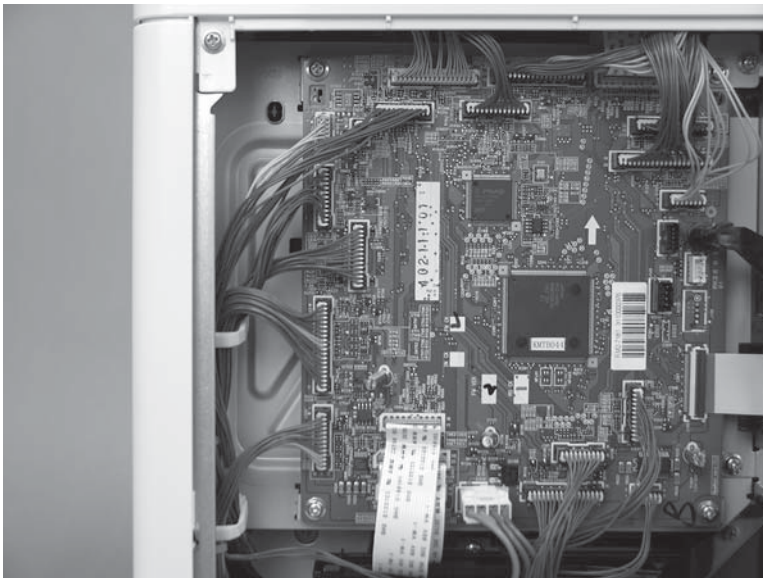

2. Disconnect five flat cables.

 **IMPORTANT:** One of the flat-cable connectors (callout 1) is a Zero Insertion Force (ZIF) connector that uses a hinged retainer to secure the flat cable. The hinged retainer must be opened to release the flat cable.

Figure 1-1218 Disconnect the flat cables



3. Remove four screws (callout 1), and then remove the DC controller (callout 2).

Figure 1-1219 Remove the DC controller

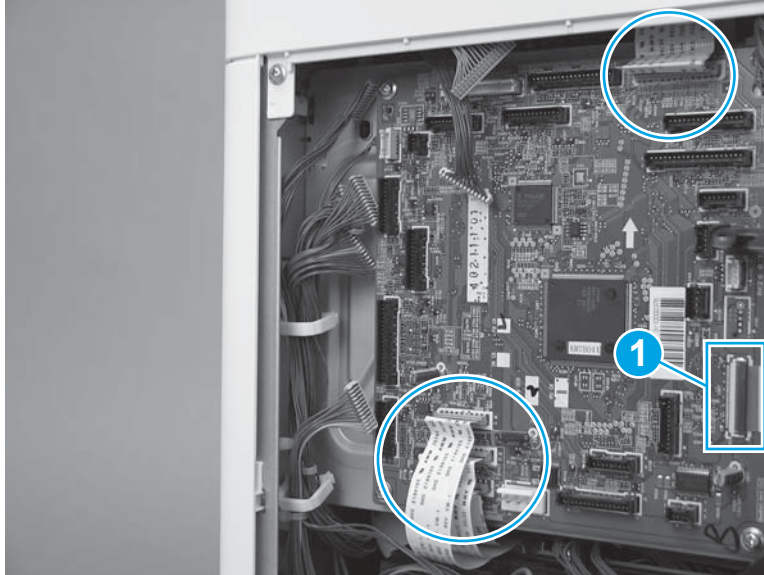
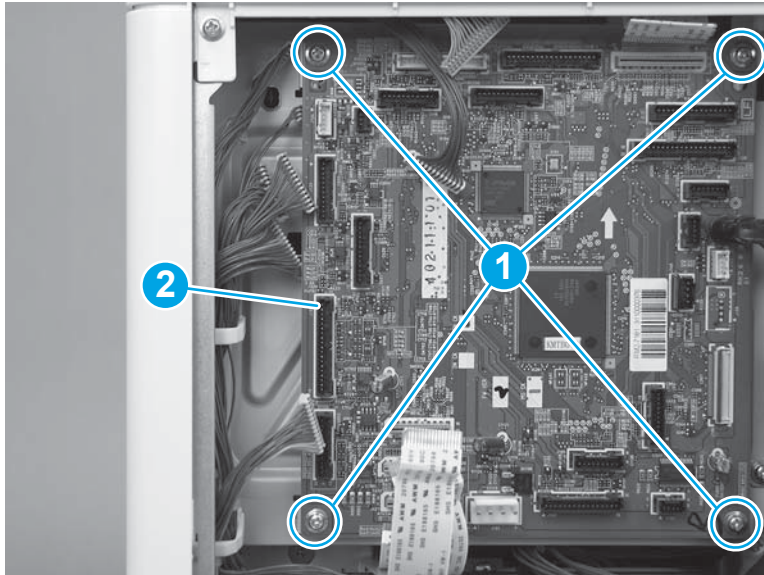

Step 6: Unpack the replacement assembly

Unpack the replacement assembly from the packaging.

 **CAUTION:**  ESD-sensitive part.

For complete information on HP's recycling programs, go to [Product return and recycling](#).

 **NOTE:** HP recommends responsible disposal of the defective assembly.

Figure 1-1220 Recycle and unpack

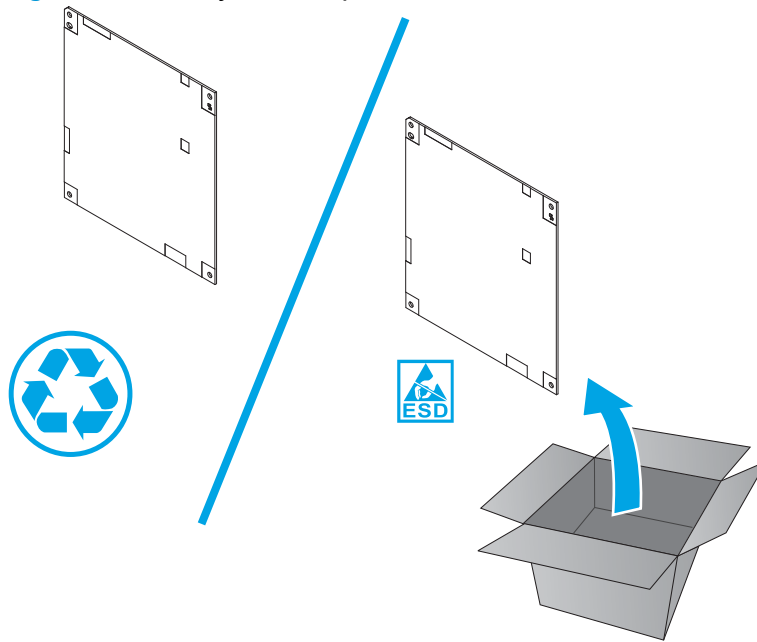

Step 7: Install the DC controller

 **CAUTION:**  ESD-sensitive part.

1. Position the DC controller (callout 1) on the printer, and then install four screws (callout 2).

Figure 1-1221 Install the DC controller

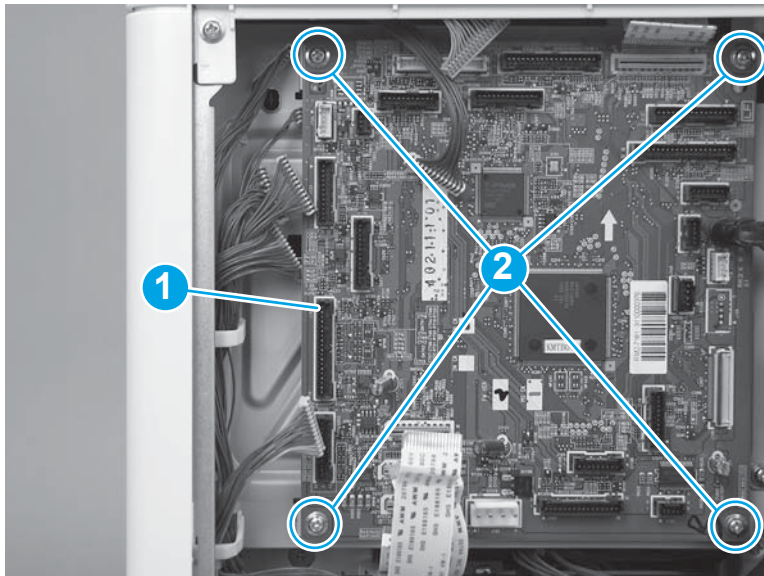

2. Connect five flat cables.

 **IMPORTANT:** One of the flat-cable connectors (callout 1) is a Zero Insertion Force (ZIF) connector that uses a hinged retainer to secure the flat cable. The hinged retainer must be opened to install the flat cable, and then closed to secure the cable.

Figure 1-1222 Connect the flat cables



3. Connect 18 connectors on the DC controller.

When the DC controller is fully reinstalled, the following connectors are empty:

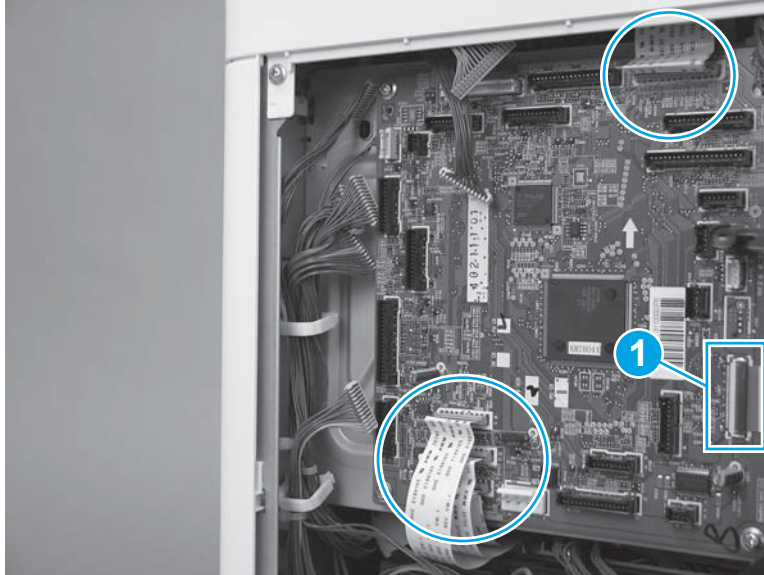
- J140, J141, and J143

Figure 1-1223 Connect all of the connectors

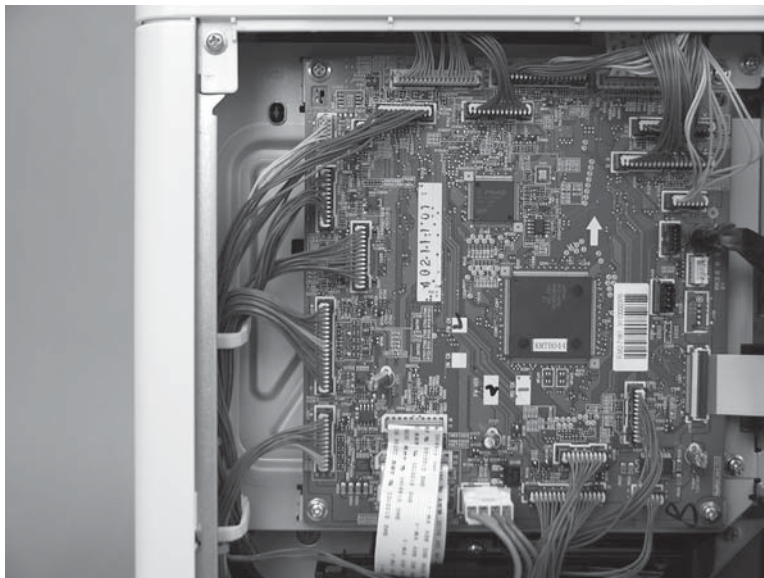

Step 8: Install the rear cover (M577)

 **NOTE:** This step is for the M577 models. For the M552 and M553 models, skip this step and go to [Step 10: Install the rear cover \(M552 and M553\) on page 711](#).

1. Position the hooks (callout 1) on the cover in the slots (callout 2) in the printer.

Figure 1-1224 Position the hooks

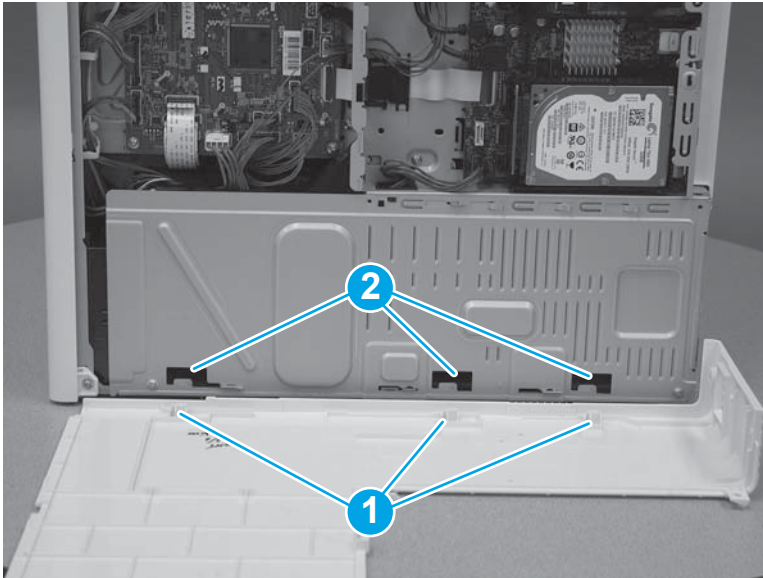

2. Position the back edge (callout 1) of the rear cover behind the edge (callout 2) of the right rear cover. Slide the cover to the left to install it.

Figure 1-1225 Install the cover

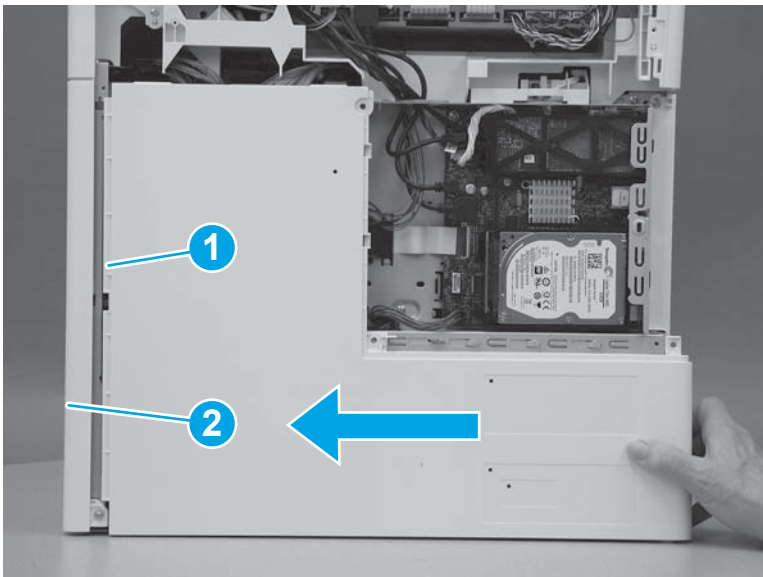

3. Install four screws (callout 1).

Figure 1-1226 Install four screws cover

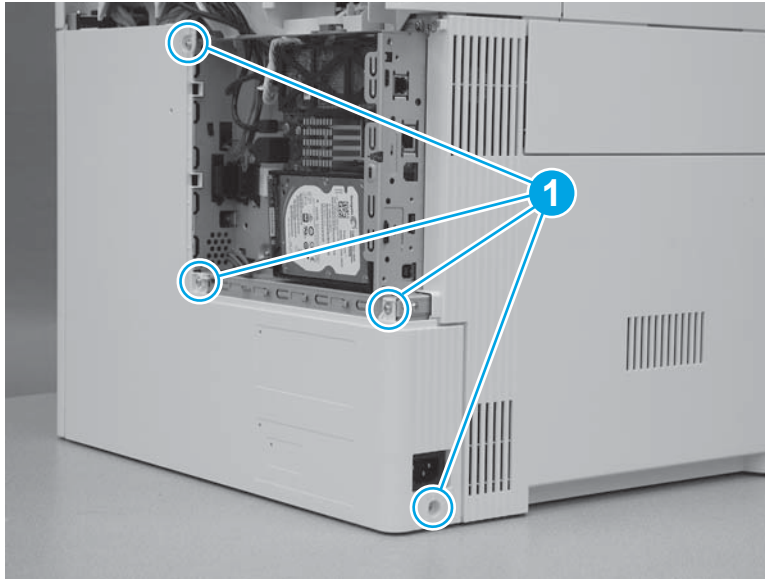

Step 9: Install the rear upper cover (M577)

 **NOTE:** This step is for the M577 models. For the M552 and M553 models, skip this step and go to [Step 10: Install the rear cover \(M552 and M553\) on page 711](#).

1. Align the ridge (callout 1) on the lower edge of the rear upper cover in front of the tabs (callout 2) on the top edge of the rear cover.

Figure 1-1227 Align the cover

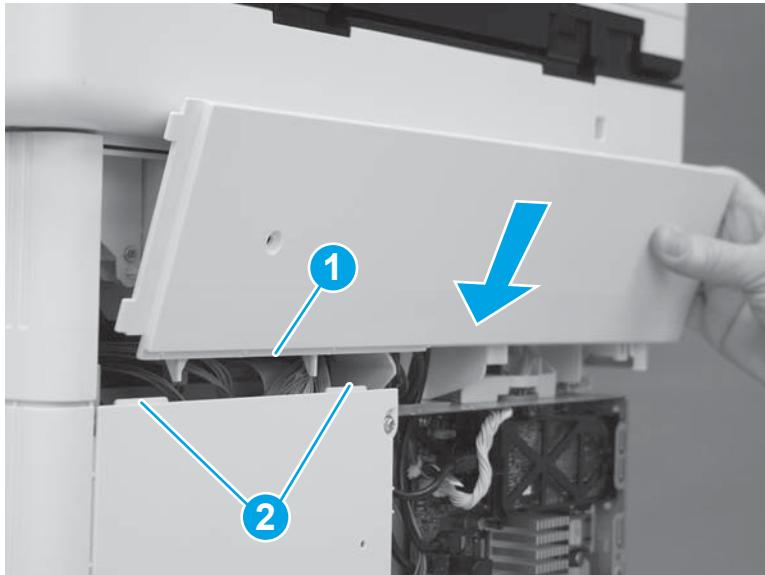

2. Rotate the top of the cover toward the printer.

Figure 1-1228 Rotate the top of the cover

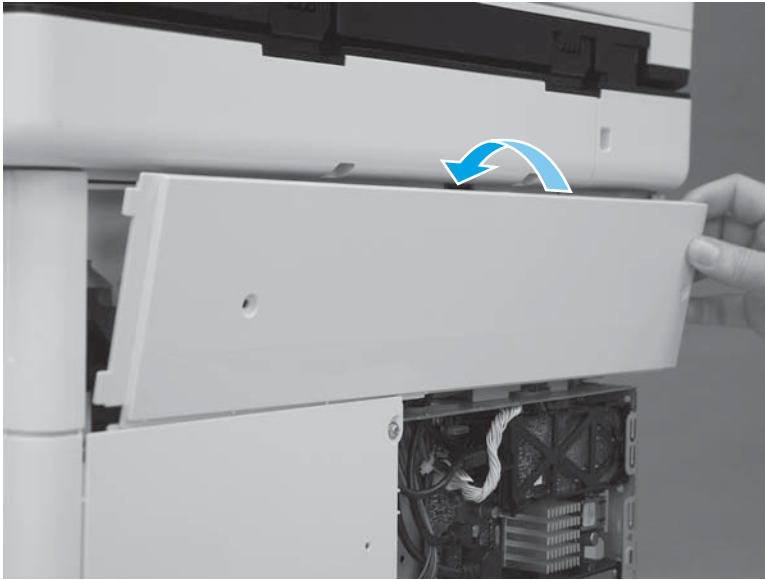

3. Slide the cover to the left (callout 1). Make sure that the tabs (callout 2) on the upper rear cover slide behind the edge (callout 3) of the right upper cover. Make sure that the cover is fully seated.

Figure 1-1229 Slide the cover

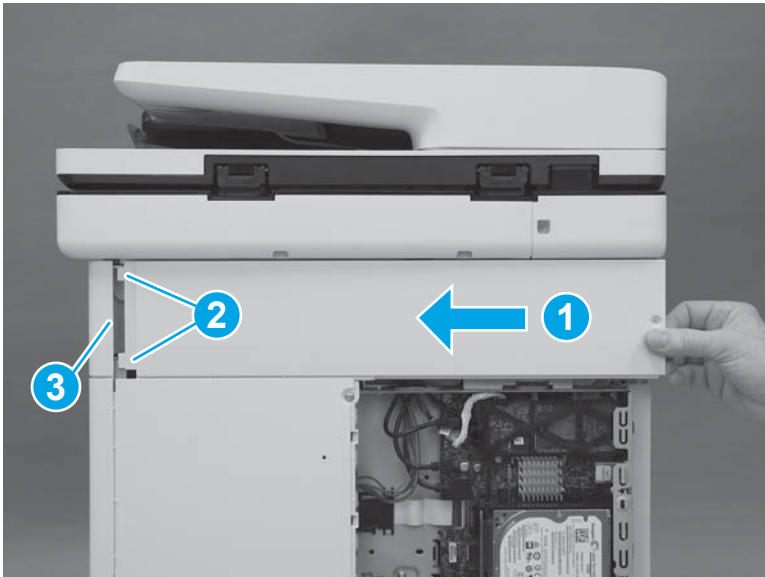

4. Install two screws (callout 1).

 **IMPORTANT:** These two screws are self-tapping screws for plastic. Rotate them counterclockwise to align them with the existing thread pattern, and then carefully turn them clockwise to tighten. Do not overtighten. This will prevent stripping the threads inside the screw holes.

Figure 1-1230 Install two screws



Step 10: Install the rear cover (M552 and M553)

 **NOTE:** This step is for the M552 and M553 models. For the M577 models, skip this step and go to [Step 11: Install the formatter cover on page 712](#).

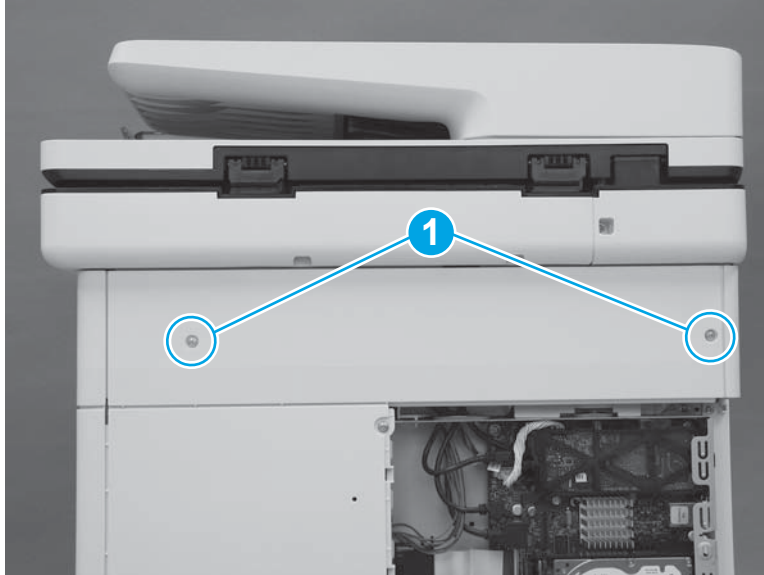
1. Position the top of the cover under the upper cover (callout 1), rotate the bottom of the cover onto the chassis (callout 2), and then slide the cover to the left (callout 3) to install it.

Figure 1-1231 Install the cover

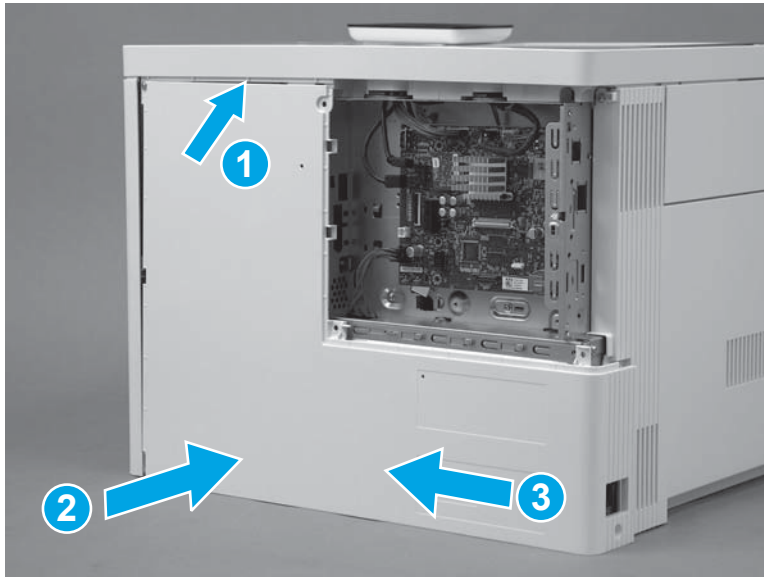

2. Install four screws (callout 1).

Figure 1-1232 Install four screws cover

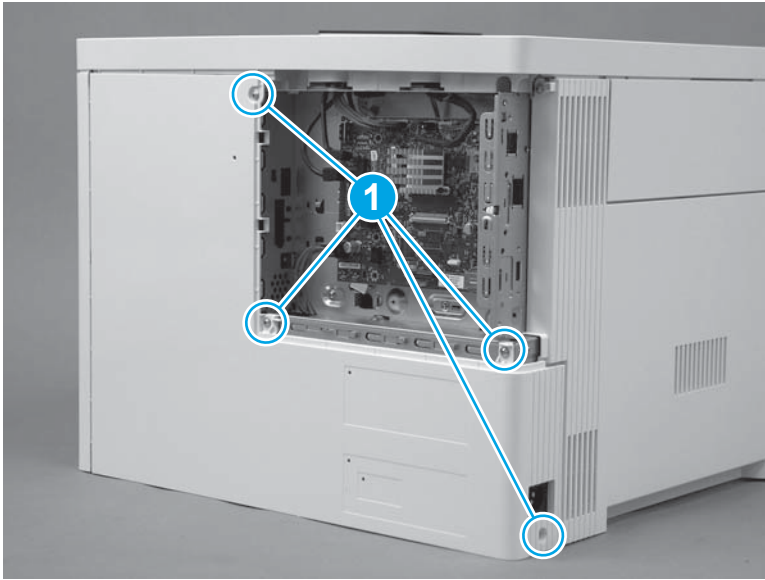

Step 11: Install the formatter cover

- ▲ Slide the cover onto the printer (callout 1) to install it.

 **NOTE:** Make sure that the tabs on the formatter cover align with the slots provided in the printer (callout 2). Tighten the two thumbscrews (callout 3).

 **TIP:** If needed, use the edge of a coin to turn the thumbscrews.

Figure 1-1233 Install the cover



Removal and replacement: Delivery assembly

- [Introduction](#)
- [Step 1: Remove the formatter cover](#)
- [Step 2: Remove the toner collection unit \(TCU\)](#)
- [Step 3: Remove the USB cover \(M552 and M553\)](#)
- [Step 4: Remove the fuser](#)
- [Step 5: Remove the ITB](#)
- [Step 6: Remove the control panel \(M553x only\)](#)
- [Step 7: Remove the rear cover \(M552 and M553\)](#)
- [Step 8: Remove the left cover](#)
- [Step 9: Remove the upper cover \(M552 and M553\)](#)
- [Step 10: Remove the control panel \(M553n/dn and M552dn only\)](#)
- [Step 11: Remove the rear upper cover \(M577\)](#)
- [Step 12: Remove the left upper cover \(M577\)](#)
- [Step 13: Remove the right front upper cover \(M577dn\)](#)
- [Step 14: Remove the stapler cover assembly \(M577c/f/z\)](#)
- [Step 15: Remove the integrated scanner assembly](#)
- [Step 16: Remove the stapler unit \(M577c/f/z\)](#)
- [Step 17: Remove the right upper cover \(M577\)](#)
- [Step 18: Remove the top rear cover \(M577\)](#)
- [Step 19: Remove the paper feed cover \(M577\)](#)
- [Step 20: Remove the top cover \(M577\)](#)
- [Step 21: Remove the top bracket \(M577\)](#)
- [Step 22: Remove the output bin](#)
- [Step 23: Remove the delivery assembly](#)
- [Step 24: Unpack the replacement assembly](#)
- [Step 25: Install the delivery assembly](#)
- [Step 26: Install the output bin](#)
- [Step 27: Install the top bracket \(M577\)](#)
- [Step 28: Install the top cover \(M577\)](#)
- [Step 29: Install the paper feed cover \(M577\)](#)

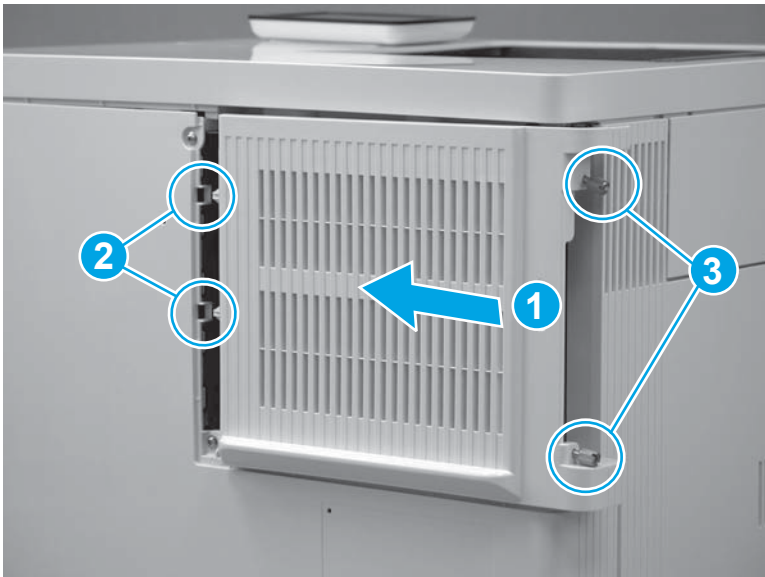
- [Step 30: Install the top rear cover \(M577\)](#)
- [Step 31: Install the right upper cover \(M577\)](#)
- [Step 32: Install the stapler unit \(M577c/f/z\)](#)
- [Step 33: Install the integrated scanner assembly \(M577\)](#)
- [Step 34: Install the stapler cover assembly \(M577c/f/z\)](#)
- [Step 35: Install the right front upper cover \(M577dn\)](#)
- [Step 36: Install the left upper cover \(M577\)](#)
- [Step 37: Install the rear upper cover \(M577\)](#)
- [Step 38: Install the control panel \(M553n/dn and M552dn only\)](#)
- [Step 30: Install the upper cover \(M552 and M553\)](#)
- [Step 40: Install the left cover](#)
- [Step 41: Install the rear cover \(M552 and M553\)](#)
- [Step 42: Install the control-panel assembly \(M553x only\)](#)
- [Step 43: Install the ITB](#)
- [Step 44: Install the fuser](#)
- [Step 45: Install the USB cover \(M552 and M553\)](#)
- [Step 46: Install the TCU](#)
- [Step 47: Install the formatter cover](#)

Introduction

This document provides the procedures to remove and replace the delivery assembly.

Before performing service

-
- 💡 **TIP:** Some figures might show assemblies removed or installed that have not yet been removed or installed at that specific step. However, the procedures are correct for this printer and the target assembly. Always thoroughly read the instructions that accompany each figure.
-

Turn the printer power off

- Disconnect the power cable.

⚠️ **WARNING!** To avoid damage to the printer, turn the printer off, wait 30 seconds, and then remove the power cord before attempting to service the printer.

- Open the right door.

Use the table below to identify the correct part number for your printer, and then go to <http://h20141.www2.hp.com/hpparts> to order the part.

Delivery assembly part number	
RM2-0092-000CN	Paper delivery assembly (M553n)
RM2-0016-000CN	Paper delivery assembly (M552dn, M553dn, M553x, M577)

Required tools

- #2 Phillips screwdriver with a magnetic tip

After performing service

Make sure that the USB cover is fully seated after replacing it.

Make sure that the TCU is fully closed after replacing it.

Make sure that the formatter cover is fully seated, and that the thumbscrews are finger tight after replacing it.

Make sure that the output bin is flat against the chassis after replacing it.

Turn the printer power on

- Connect the power cable.
- Use the power switch to turn the power on.

Post service test

Print a configuration page to make sure that the printer is functioning correctly.

Step 1: Remove the formatter cover

1. Locate the formatter cover.

Figure 1-1234 Locate the formatter cover

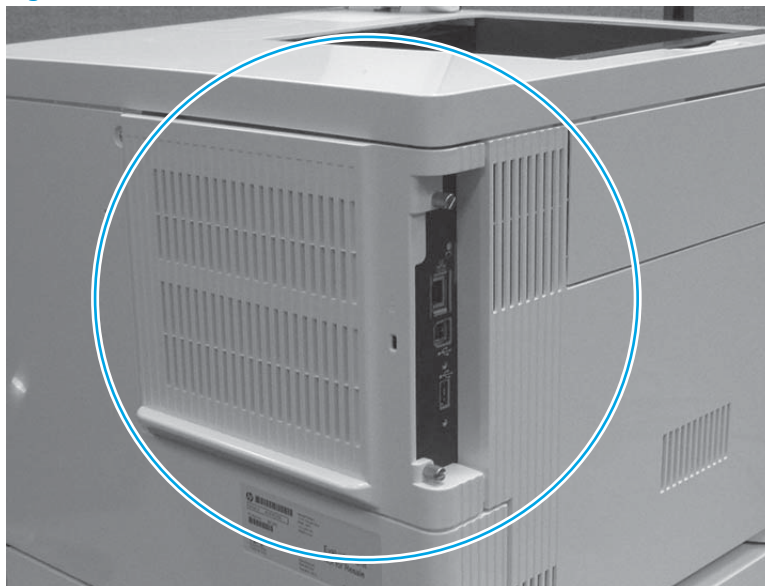

2. Loosen the two thumbscrews (callout 1). Grasp the two thumbscrews, and then slide the cover away from the printer (callout 2) to remove it.

 **TIP:** If needed, use the edge of a coin to turn the thumbscrews.

Figure 1-1235 Loosen the thumbscrews



Step 2: Remove the toner collection unit (TCU)

1. Open the front door.

Figure 1-1236 Open the front door



2. Open the TCU.



NOTE: The toner collection hatch cover automatically closes when the TCU is opened.

Figure 1-1237 Open the TCU



3. Pull the TCU away from the printer at an angle to remove it.

⚠ CAUTION: Do not open the toner collection hatch cover when handling the TCU. If toner gets on clothing, wipe it off by using a dry cloth and wash the clothes in cold water. Hot water sets toner into fabric.

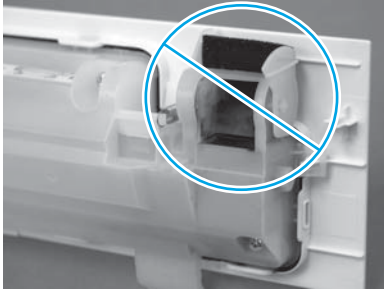
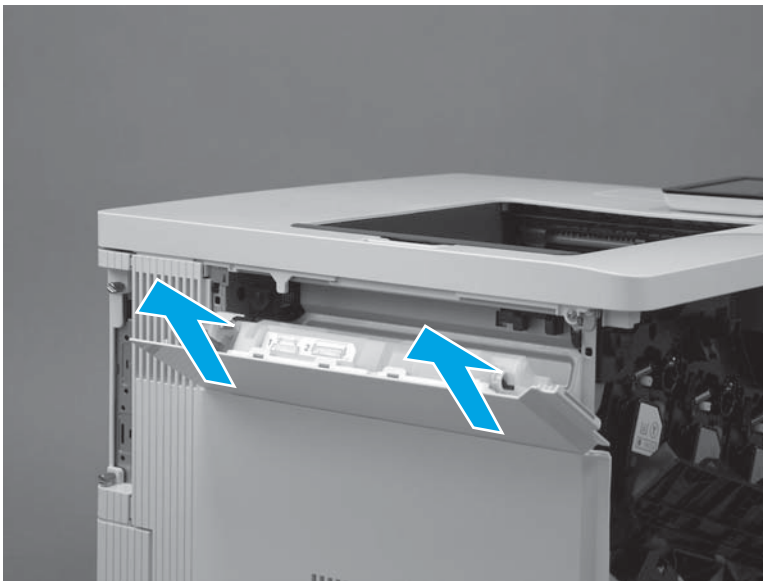

Figure 1-1238 Remove the TCU



Step 3: Remove the USB cover (M552 and M553)

📝 NOTE: This step is for the M552 and M553 models. For the M577 models, skip this step and go to [Step 11: Remove the rear upper cover \(M577\) on page 736](#).

1. Locate the USB cover.

Figure 1-1239 Locate the USB cover



2. Pull the cover off of the printer to remove it.

Figure 1-1240 Remove the cover



Step 4: Remove the fuser

1. Open the right door.

⚠ CAUTION: The fuser is very hot. After turning the printer power off, allow the fuser to cool for at least 30 minutes before removing it.

Figure 1-1241 Open the right door



2. Grasp the two fuser handles, and then squeeze the two blue triggers on the handles to release the fuser.

Figure 1-1242 Release the fuser

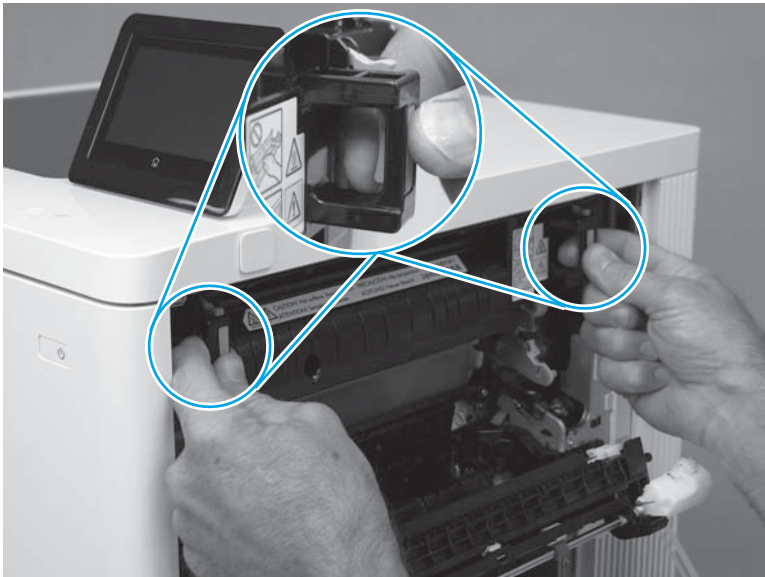

3. Slide the fuser straight out of the printer to remove it.

Figure 1-1243 Remove the fuser



Step 5: Remove the ITB

CAUTION: Do not touch the grey-plastic belt. Skin oils and fingerprints on the belt can cause print-quality problems.

1. Pull the blue lever to release the ITB drive coupling.

Figure 1-1244 Release the ITB drive coupling

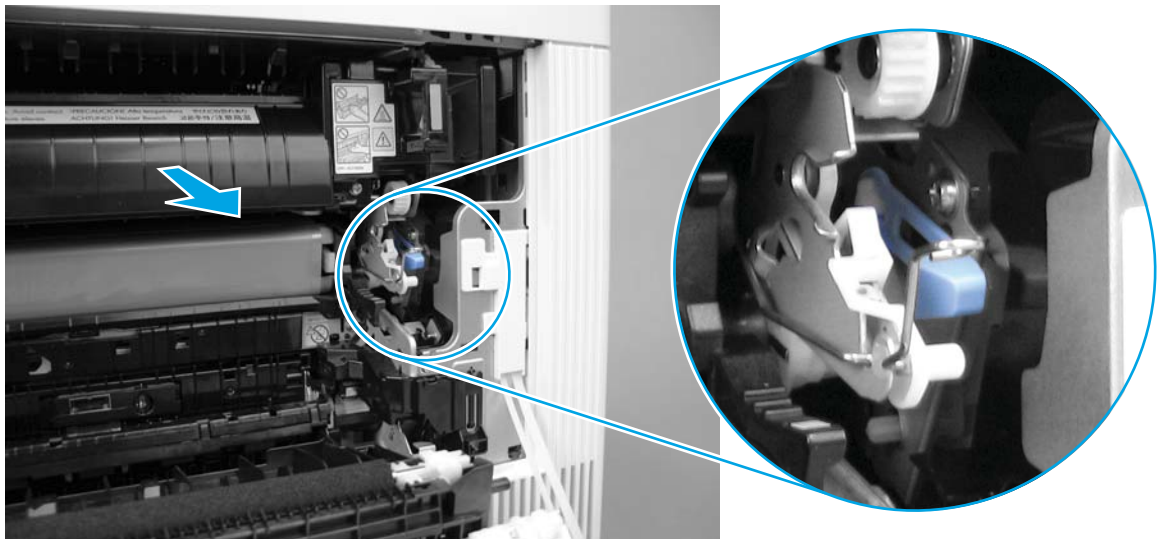

2. Push in on the blue arm to release the secondary transfer roller assembly, and then completely lower the assembly.

 **NOTE:** Press the blue arm on the secondary transfer roller assembly a second time to release the roller assembly when it stops at the halfway open position.

Figure 1-1245 Lower the secondary transfer roller assembly



3. Release the left-side ITB spring (callout 1) from the tab (callout 2).

Figure 1-1246 Release the front-side ITB spring

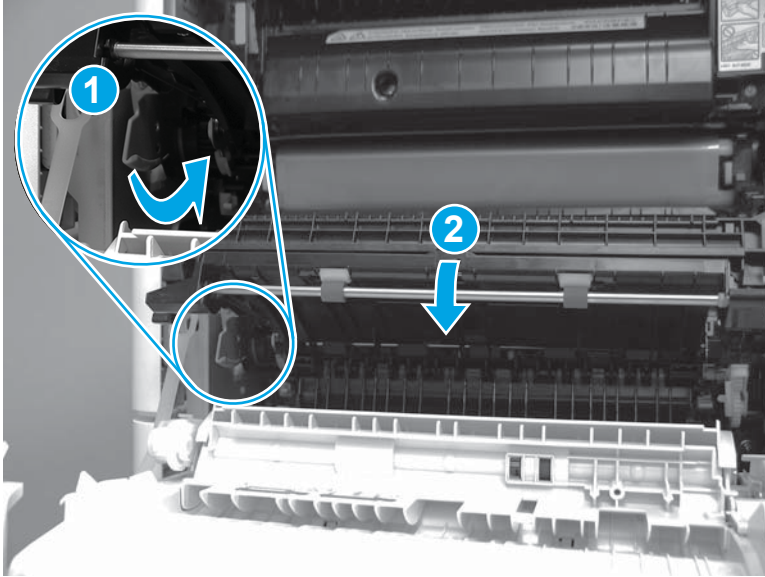
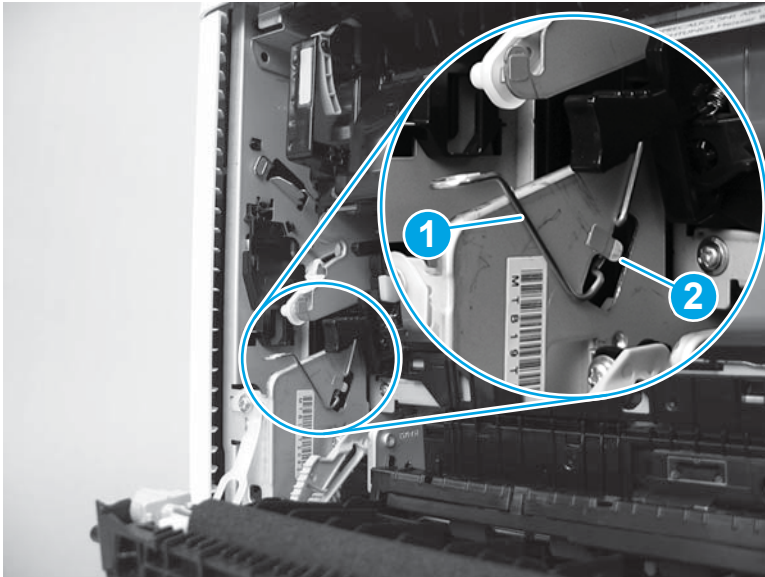

4. Place the left-side ITB spring on the holder to keep it out of the way.

 **TIP:** The holder is colored blue to help locate it.

Figure 1-1247 Place the spring on the holder

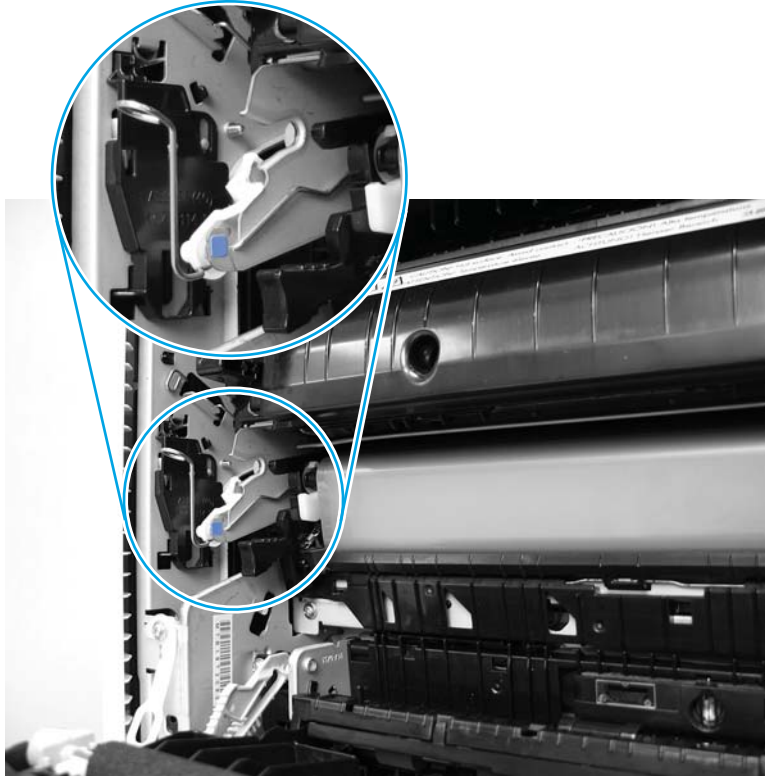

5. Release the right-side ITB spring (callout 1) from the tab (callout 2).

Figure 1-1248 Release the rear-side ITB spring

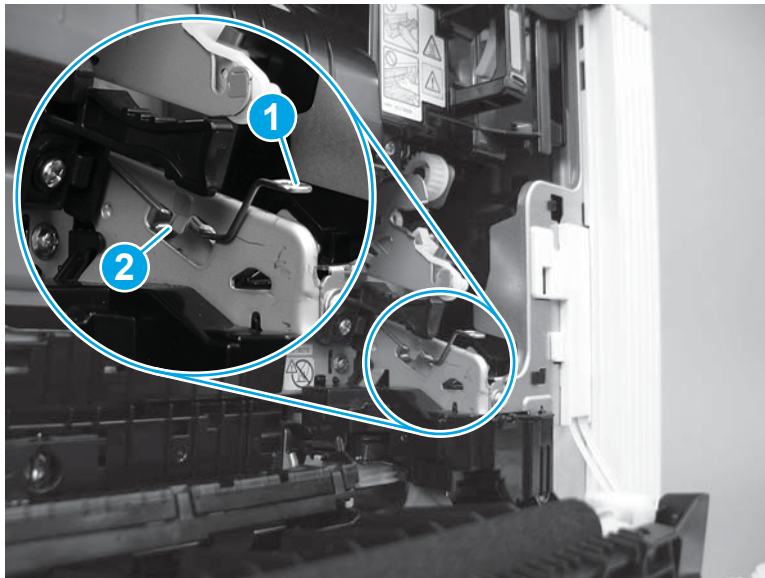

6. Place the right-side ITB spring on the holder to keep it out of the way.

 **TIP:** The holder is colored blue to help locate it.

Figure 1-1249 Place the spring on the holder

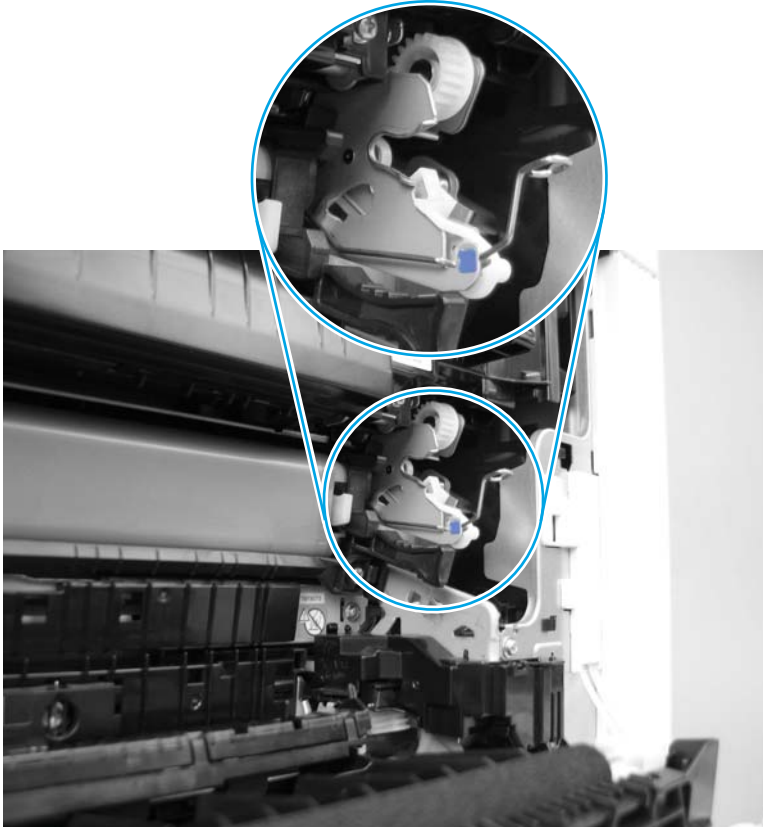

7. Grasp the two blue handles on the ITB.

⚠ CAUTION: If the ITB is removed to access other assemblies in the printer, use care. The ITB is a sensitive assembly. Be careful when handling the ITB so that it is not damaged. Always place the ITB in a safe and protected location.

Figure 1-1250 Grasp the ITB handles

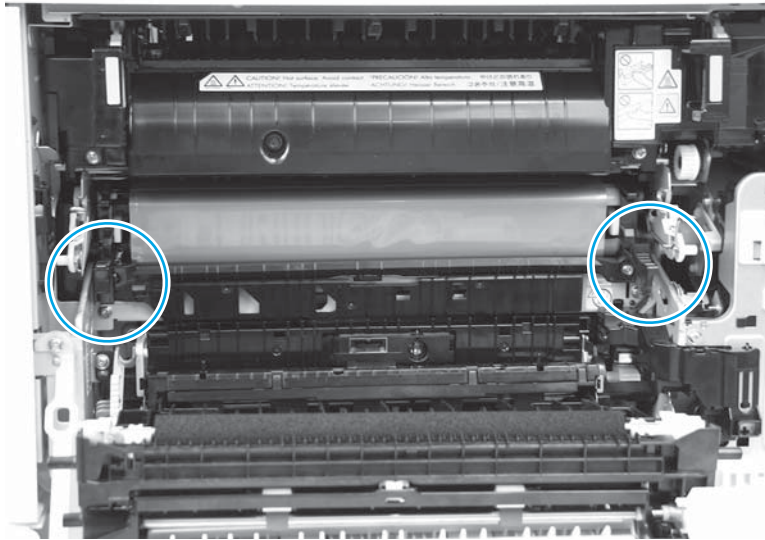

8. Pull the ITB out of the printer to remove it.

⚠ CAUTION: Do not touch the grey-plastic belt. Skin oils and fingerprints on the belt can cause print-quality problems.

Figure 1-1251 Remove the ITB



Step 6: Remove the control panel (M553x only)

 **NOTE:** For the M553n/dn and M552dn models, skip this step and go to [Step 7: Remove the rear cover \(M552 and M553\)](#) on page 729.

For the M577, skip this step and go to [Step 11: Remove the rear upper cover \(M577\)](#) on page 736.

1. Tilt the control panel up.

Figure 1-1252 Tilt the control panel up



2. Use a small flat-blade screwdriver to release the control-panel screws cover tabs.

Figure 1-1253 Release the control-panel screws cover tabs



3. Rotate the cover up to remove it.

Figure 1-1254 Remove the cover



4. Use a small Phillips screwdriver to remove two screws (callout 1).

 **IMPORTANT:** Store the screws in a secure place where they cannot fall down into the printer.

Figure 1-1255 Remove two screws

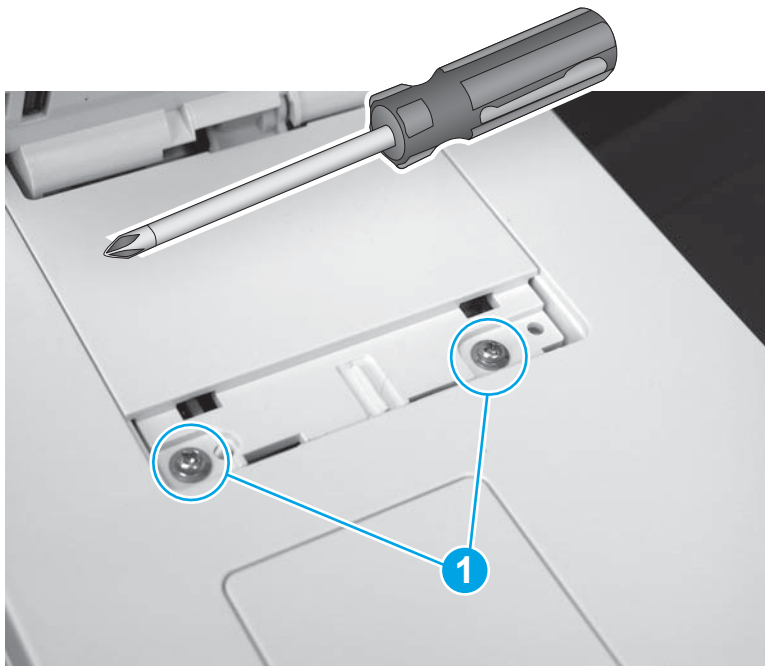

5. Rotate the control-panel base toward the front of the printer.

Figure 1-1256 Rotate the control-panel base up



6. Slightly slide the control-panel base toward the rear of the printer (callout 1) to release it, and then turn the control panel over (callout 2) to access the bottom side.

CAUTION: The control panel is still attached to the printer. Do not attempt to completely remove the control panel.

Figure 1-1257 Turn the control panel over

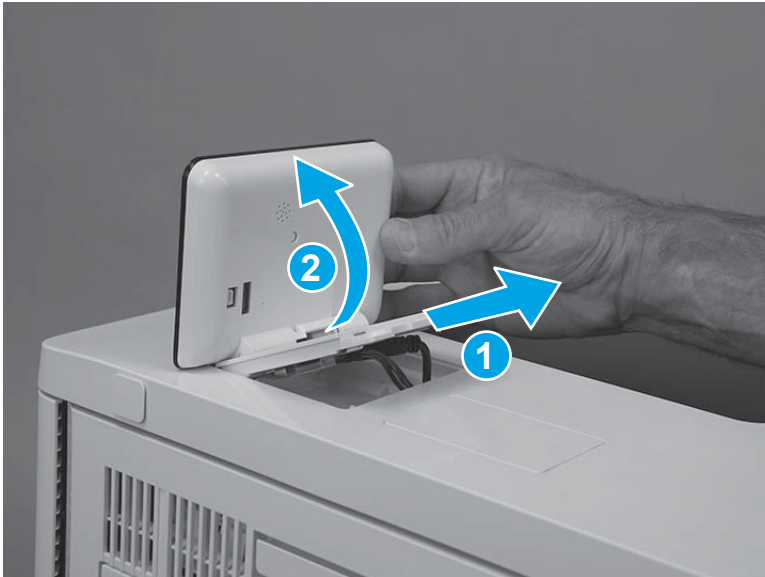

7. Disconnect one USB cable (callout 1), one connector (callout 2), and then remove the control panel.

Figure 1-1258 Disconnect two connectors

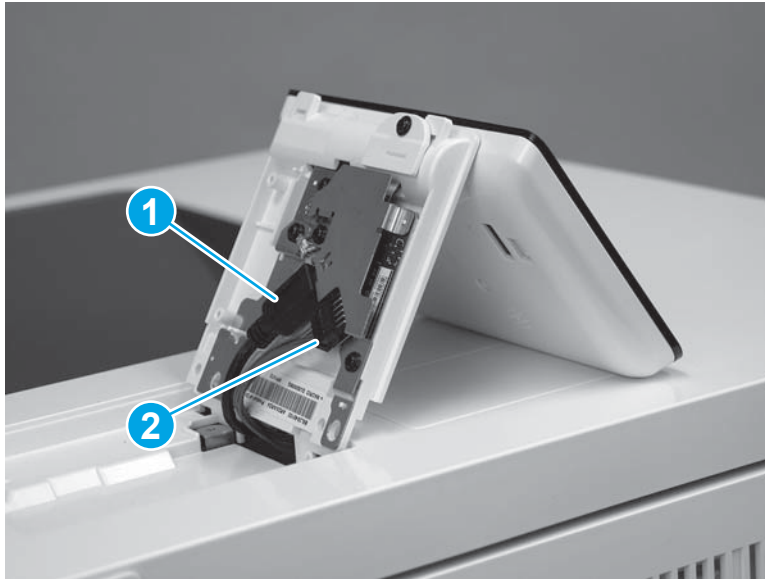

Step 7: Remove the rear cover (M552 and M553)

 **NOTE:** This step is for the M552 and M553 models. For the M577 models, skip this step and go to [Step 11: Remove the rear upper cover \(M577\) on page 736](#).

1. Remove four screws (callout 1).

Figure 1-1259 Remove four screws

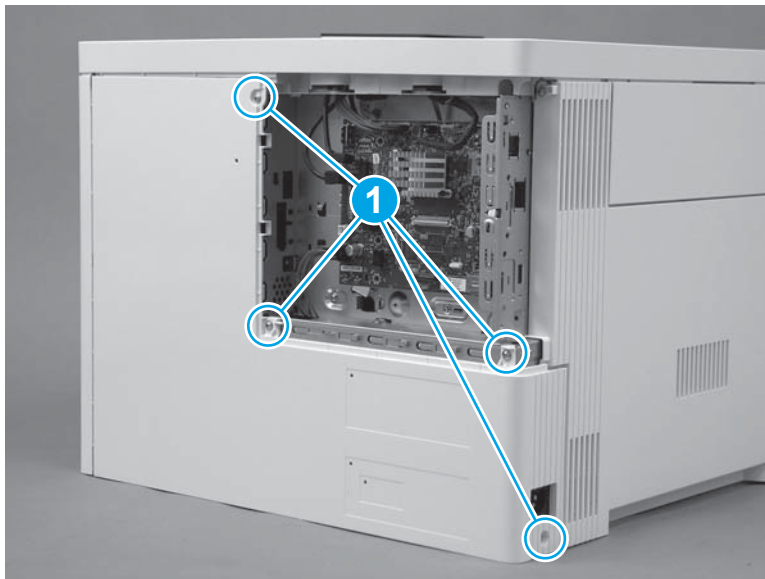

2. Slightly slide the cover to the right (callout 1), rotate the bottom of the cover away from the printer (callout 2), and then pull the top of the cover away from the printer (callout 3) to remove the cover.

Figure 1-1260 Remove the cover

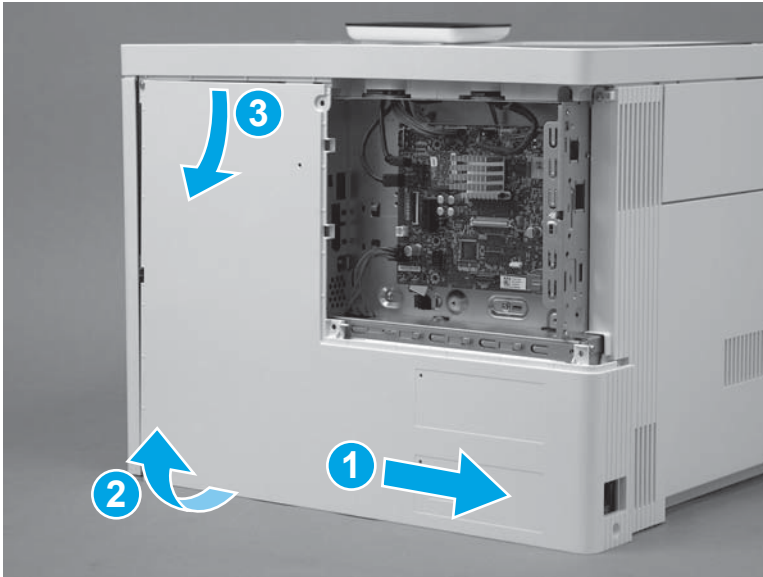

Step 8: Remove the left cover



NOTE: This step is for the M552 and M553 models. For the M577 models, skip this step and go to [Step 11: Remove the rear upper cover \(M577\) on page 736](#).

1. At the left side of the printer, remove one screw (callout 1).

Figure 1-1261 Remove one screw



2. Release one tab (callout 1), rotate the front edge of the cover away from the printer (callout 2), and then slide the cover (callout 3) toward the rear of the printer to release it.

Figure 1-1262 Release the cover

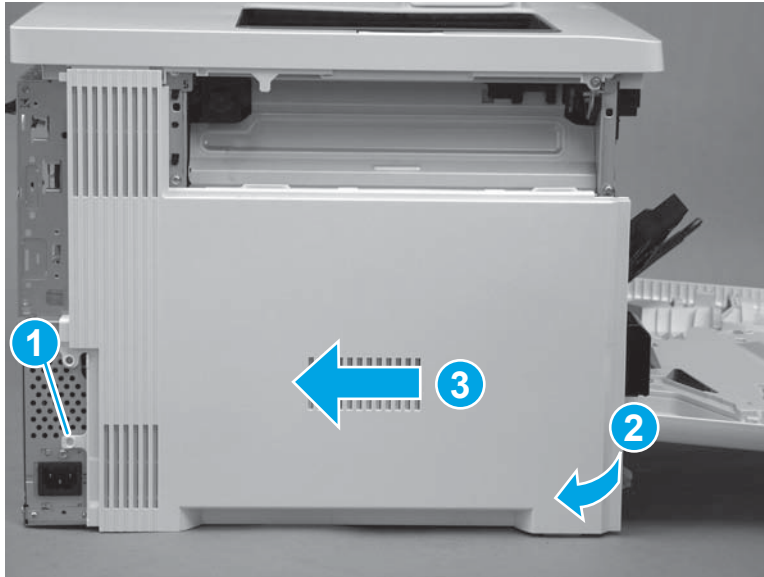

3. Remove the cover.

Figure 1-1263 Remove the cover

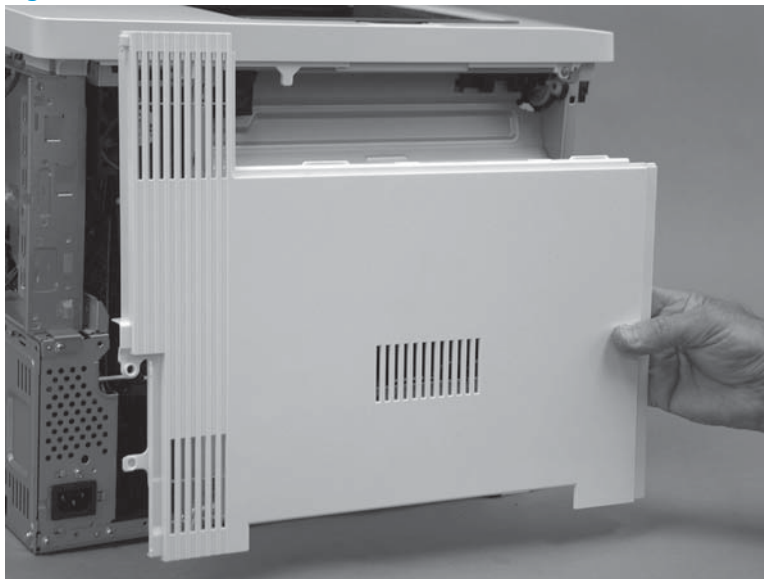

Step 9: Remove the upper cover (M552 and M553)

 **NOTE:** This step is for the M552 and M553 models. For the M577 models, skip this step and go to [Step 11: Remove the rear upper cover \(M577\) on page 736.](#)

1. Remove three screws (callout 1).

Figure 1-1264 Remove three screws

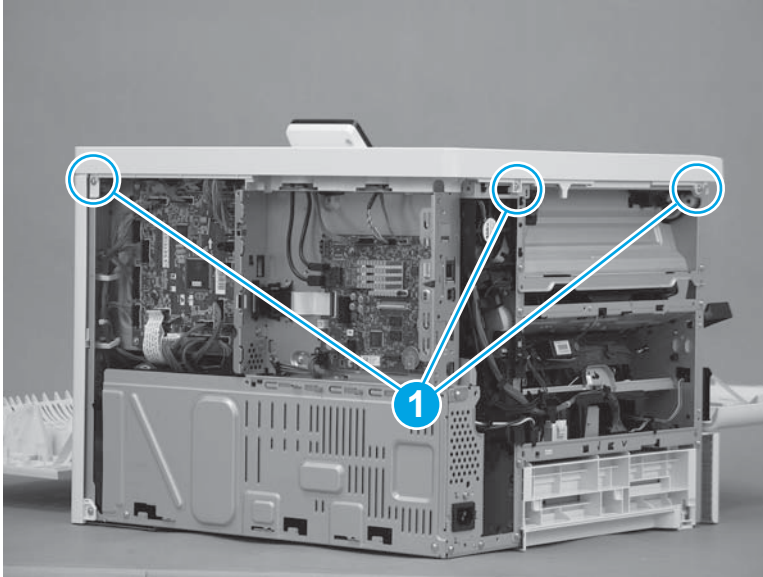

2. Remove one screw (callout 1), release one tab (callout 2), and then slightly separate the corner of the cover from the chassis.

 **NOTE:** This is a self-tapping plastic-thread screw. Make sure that this screw is used in this location when it is reinstalled.

Figure 1-1265 Remove one screw and release one tab



3. Release one tab (callout 1), and then lift up on the cover to release it.

 **NOTE:** If the cover does not release, check for addition tabs by locating the triangles embossed in the cover at tab locations.

Figure 1-1266 Release the cover



4. Remove the cover.

Figure 1-1267 Remove the cover

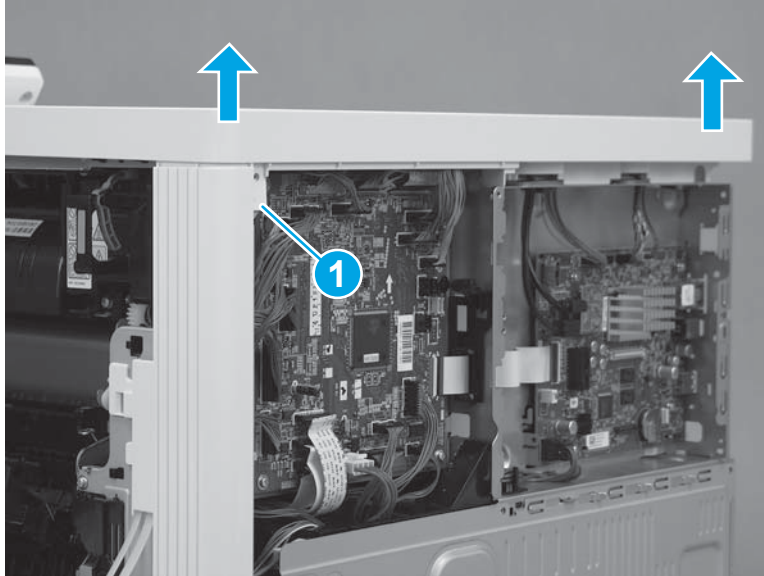
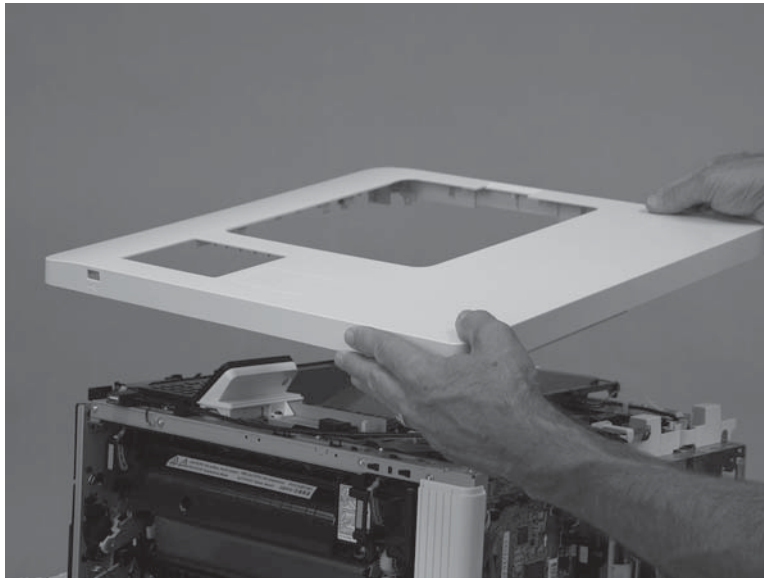

Step 10: Remove the control panel (M553n/dn and M552dn only)

 **NOTE:** For the M553x model, skip this step and go to [Step 22: Remove the output bin on page 755.](#)

For the M577 models, skip this step and go to [Step 11: Remove the rear upper cover \(M577\) on page 736.](#)

1. Remove one screw (callout 1).

Figure 1-1268 Remove one screw

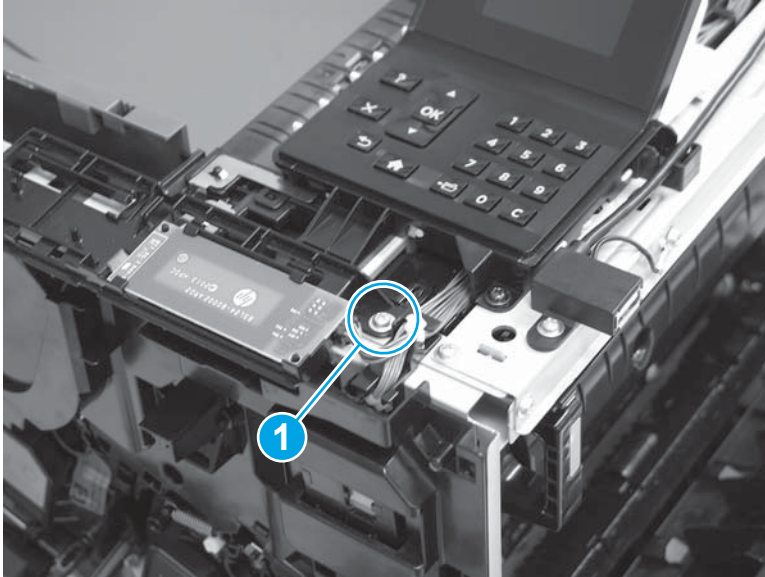

2. Disconnect one connector (callout 1). Rotate the near field communication (NFC) PCA holder up (callout 2), and then slide it to the right (callout 3) to remove it.

Figure 1-1269 Remove the PCA holder

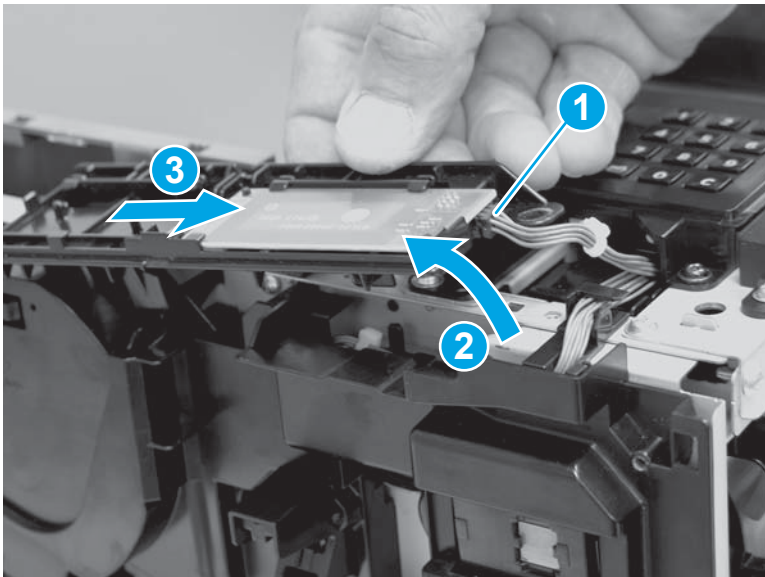

3. Remove one cable from the guide.

Figure 1-1270 Remove one cable



4. Remove four screws (callout 1), and then turn the control panel over (callout 2) to access the bottom side.

⚠ CAUTION: The control panel is still attached to the printer. Do not attempt to completely remove the control panel.

Figure 1-1271 Remove four screws

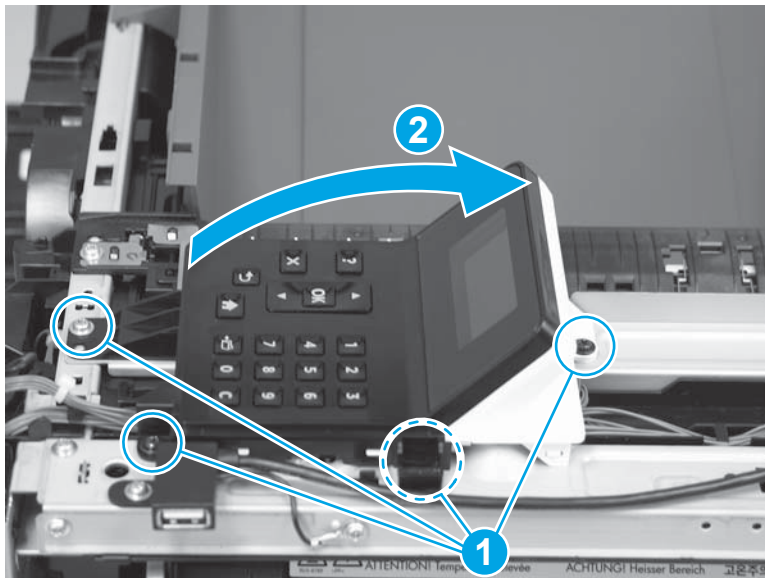

5. Disconnect one connector (callout 1), and then remove the control panel.

Figure 1-1272 Remove the control panel

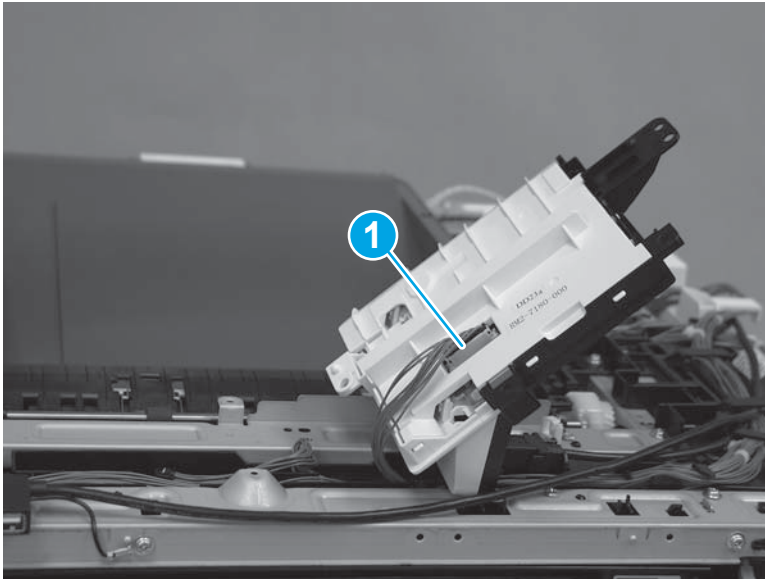

Step 11: Remove the rear upper cover (M577)



NOTE: This step is for the M577 models. For the M552 and M553 models, skip this step and go to [Step 22: Remove the output bin on page 755](#).

1. Remove two screws (callout 1).



Reinstallation tip: These two screws are self-tapping screws for plastic. When reinstalling them, rotate the screws counterclockwise to align them with the existing thread pattern, and then carefully turn them clockwise to tighten. Do not overtighten. This will prevent stripping the threads inside the screw holes.

Figure 1-1273 Remove two screws

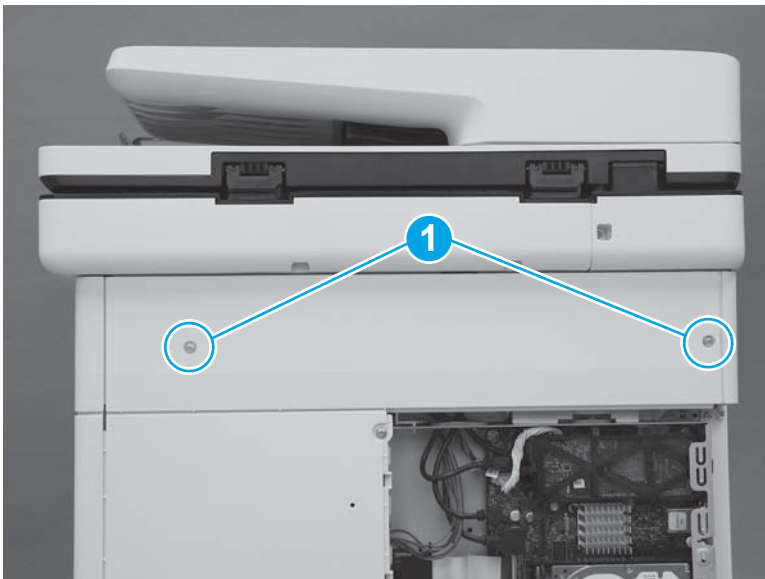

2. Use a small, flat blade screwdriver to release the right edge of the cover.

Figure 1-1274 Release the right edge

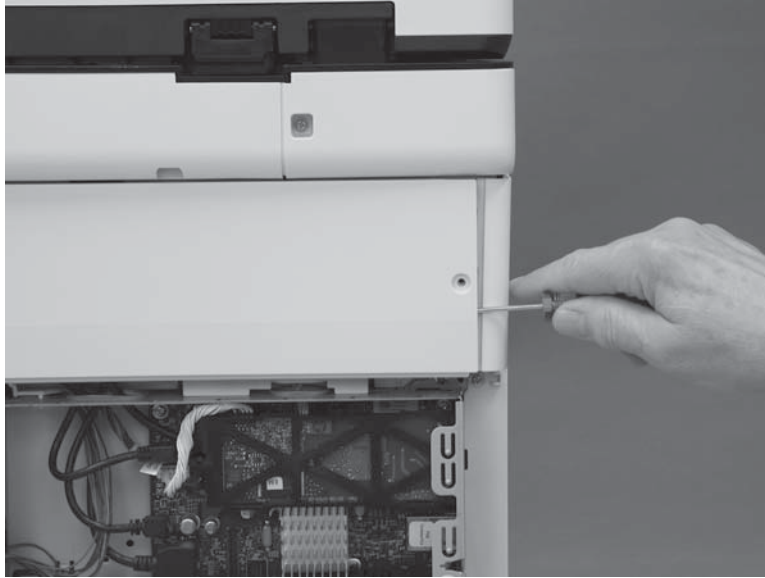

3. Pull the right edge of the cover (callout 1) away from the printer, and then slide the cover to the right (callout 2).

Figure 1-1275 Slide the cover right

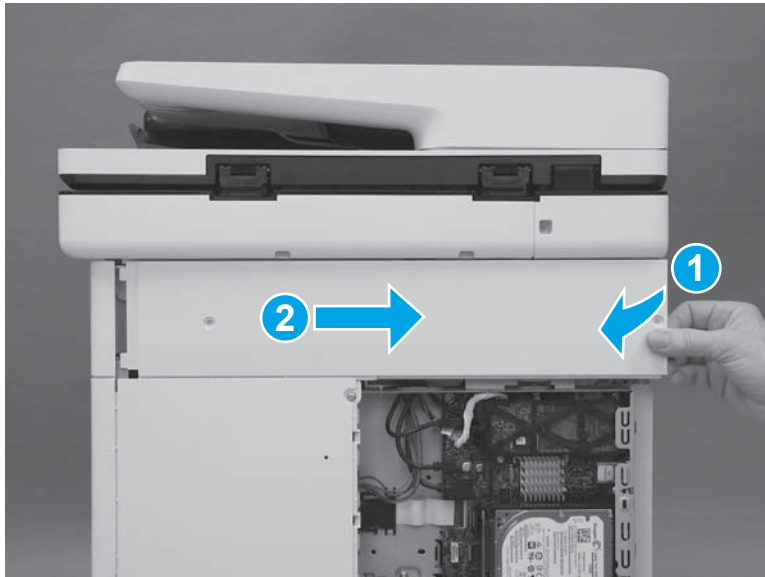

4. Remove the cover.

Figure 1-1276 Remove the cover

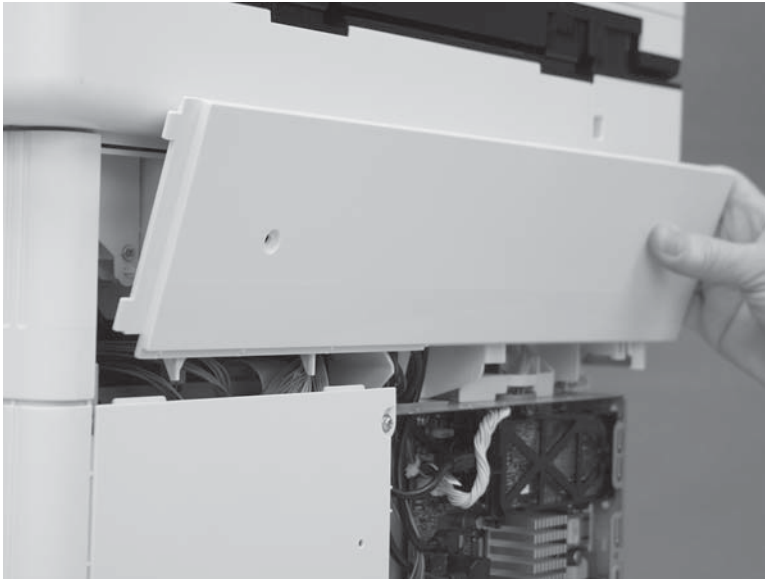

Step 12: Remove the left upper cover (M577)



NOTE: This step is for the M577 models. For the M552 and M553 models, skip this step and go to [Step 22: Remove the output bin on page 755](#).

1. At the left side of the printer, release one tab (callout 1).

Figure 1-1277 Release one tab

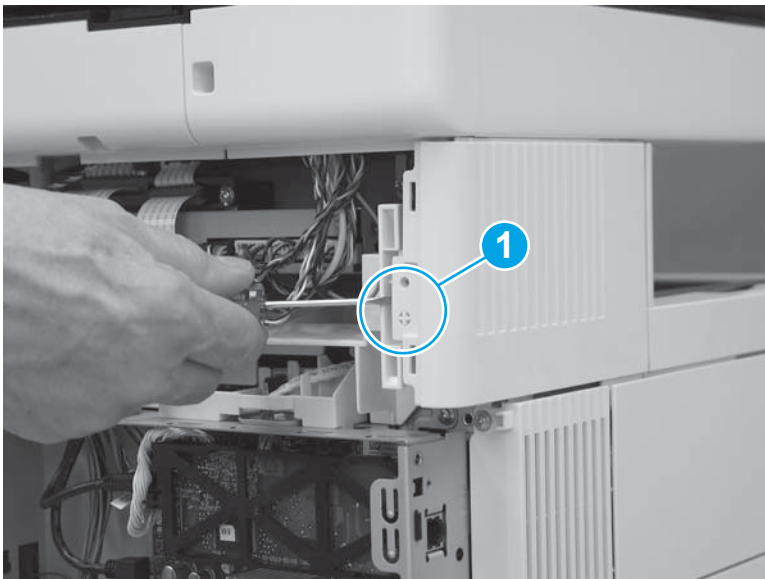

2. Slide the left upper cover toward the back of the printer.

Figure 1-1278 Slide the cover back

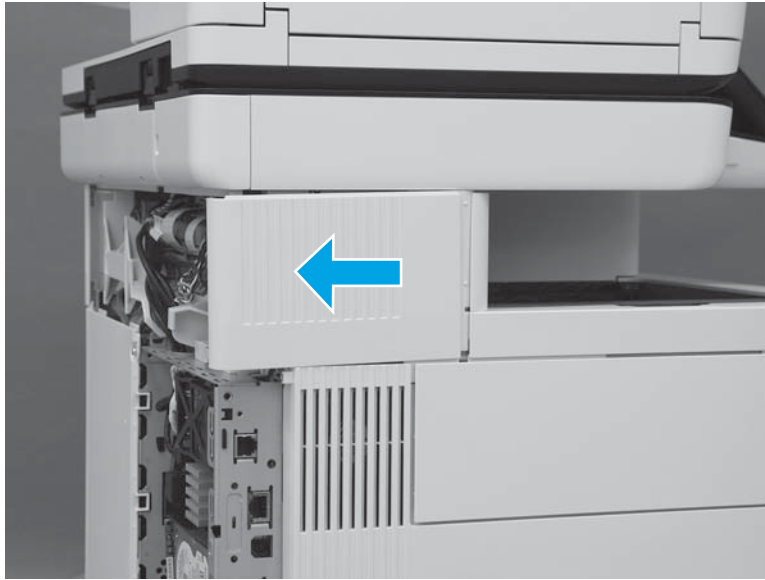

3. Rotate the cover up to remove it.

Figure 1-1279 Remove the left upper cover



Step 13: Remove the right front upper cover (M577dn)

 **NOTE:** This step is for the M577dn model. For the M577c/f/z models, skip this step and to go [Step 14: Remove the stapler cover assembly \(M577c/f/z\) on page 741.](#)

For the M552 and M553 models, skip this step and go to [Step 22: Remove the output bin on page 755.](#)

1. Remove one screw (callout 1).

Figure 1-1280 Remove one screw

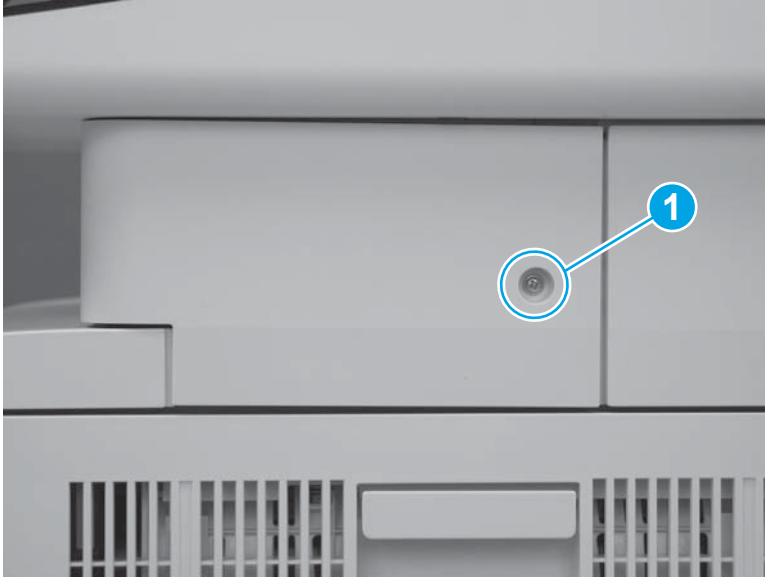

2. Release two tabs at the front edge of the cover (callout 1).

Figure 1-1281 Release two tabs



3. Rotate the front of the cover to the right to remove it.

Figure 1-1282 Rotate the cover



Step 14: Remove the stapler cover assembly (M577c/f/z)

 **NOTE:** This step is for the M577c/f/z models. For the M577dn model, skip this step and go to [Step 15: Remove the integrated scanner assembly on page 743](#).

For the M552 and M553 models, skip this step and go to [Step 22: Remove the output bin on page 755](#).

1. Remove one screw (callout 1).

 **Reinstallation tip:** This is a self-tapping screw for plastic. When reinstalling, rotate the screw counterclockwise to align it with the existing thread pattern, and then carefully turn it clockwise to tighten. Do not overtighten. This will prevent stripping the threads inside the screw hole.

Figure 1-1283 Remove one screw



2. Release two tabs at the front edge of the cover (callout 1).

Figure 1-1284 Release two tabs

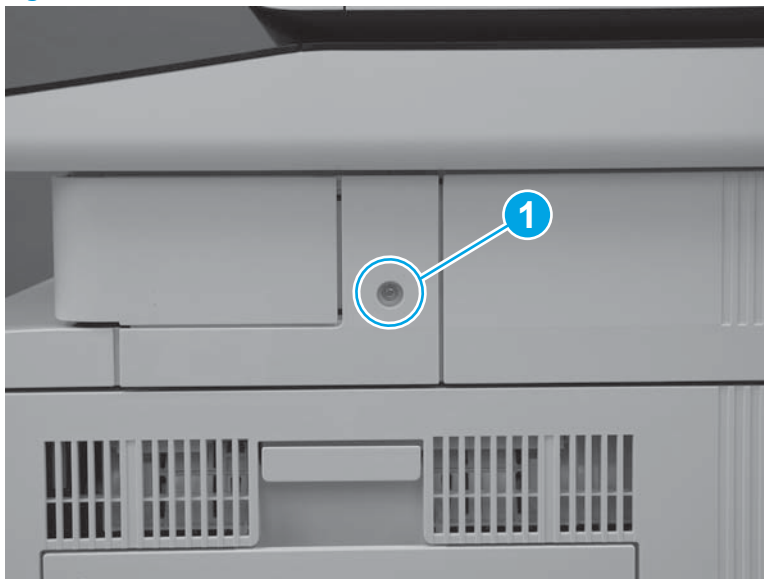

3. Release the back edge of the cover.

Figure 1-1285 Release the back edge of the cover

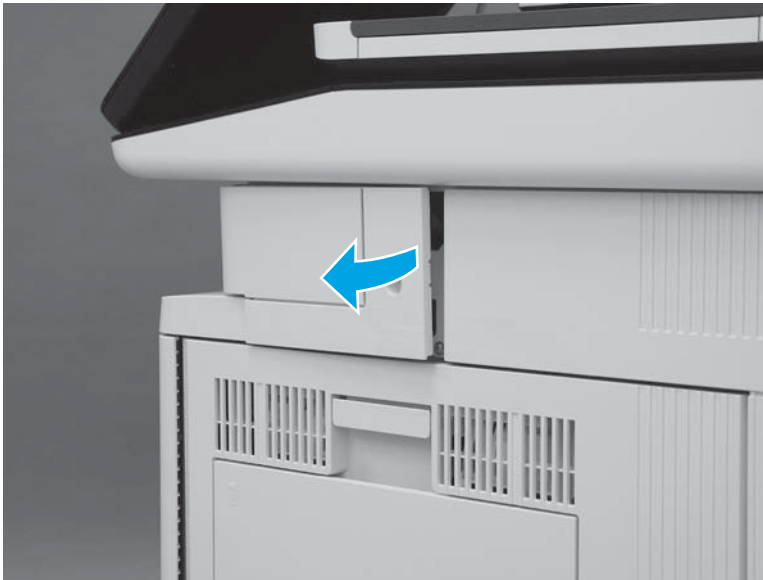



4. Rotate the cover away from the printer to remove it.

Figure 1-1286 Remove the cover



Step 15: Remove the integrated scanner assembly

 **NOTE:** This step is for the M577 models. For the M552 and M553 models, skip this step and go to [Step 22: Remove the output bin on page 755](#).

 **NOTE:** The ISA includes the document feeder, image scanner, scanner control board (SCB), control panel, keyboard (M577c/z) and NFC PCA (M577z).

1. At the left side of the printer, remove one screw (callout 1).

Figure 1-1287 Remove one screw

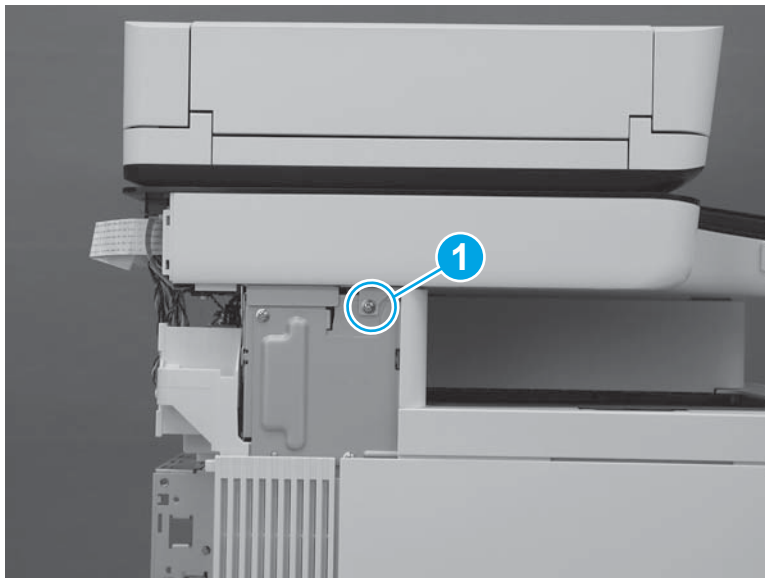

2. At the back side of the printer, remove two screws (callout 1).

Figure 1-1288 Remove two screws

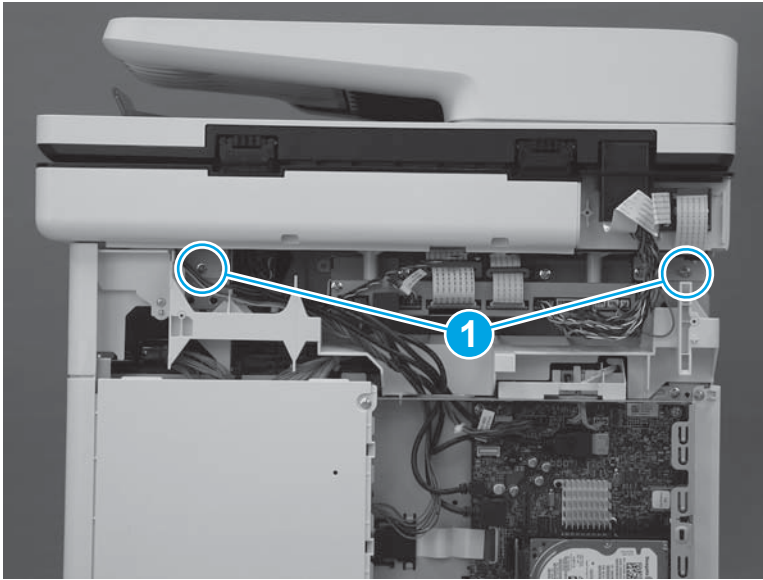

3. At the right side of the printer, remove one screw (callout 1).

Figure 1-1289 Remove one screw

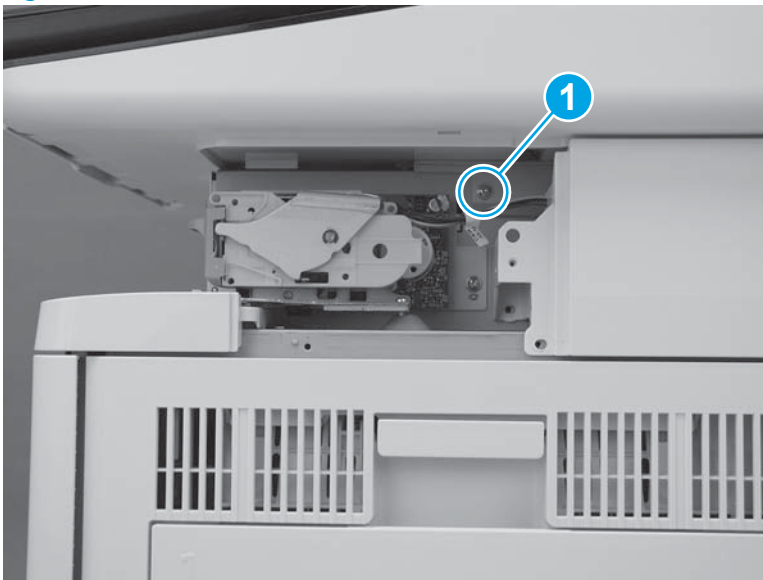

4. Disconnect four connectors on the formatter (callout 1), and then pass the wire harness and cables through the opening in the formatter case (callout 2).

Figure 1-1290 Disconnect four connectors

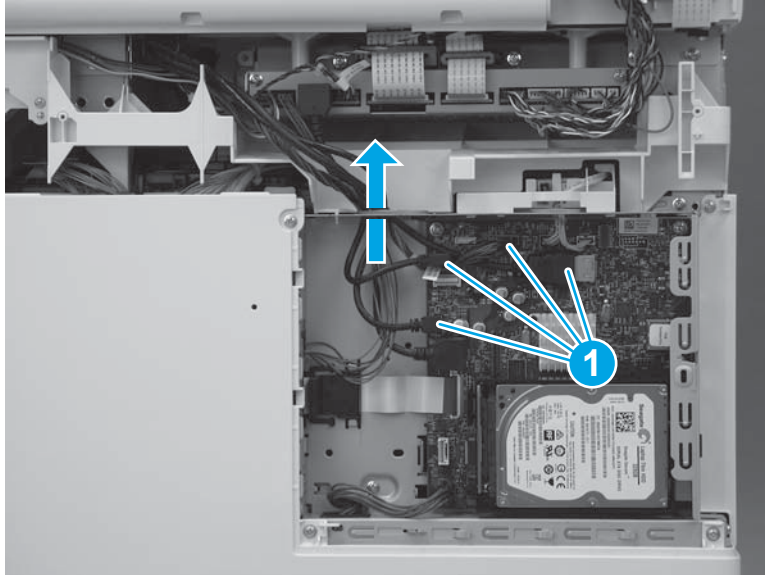

5. Disconnect two connectors on the scanner control board (callout 1).

M577c/f/z only: Disconnect one connector for the stapler on the scanner control board (callout 2).

Figure 1-1291 Disconnect connectors

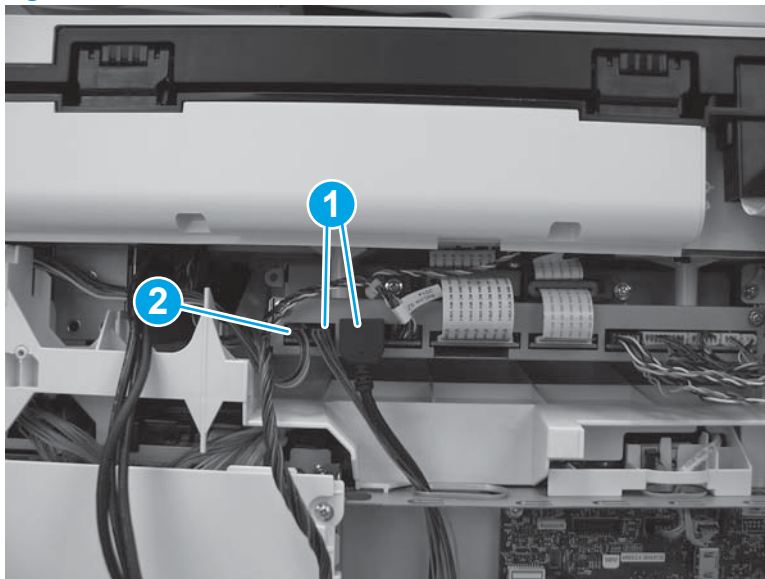

6. Slightly slide the ISA towards the back of the printer to release it.

Figure 1-1292 Slide the ISA towards the back of the printer

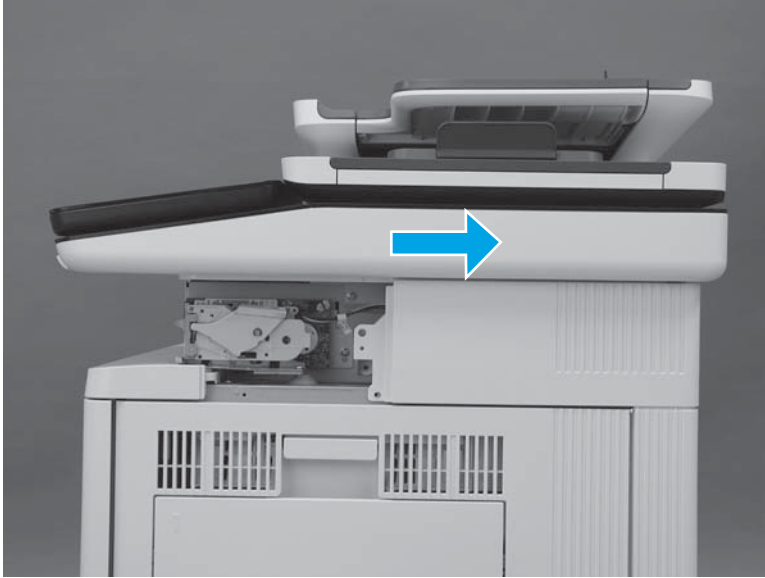

7. Lift the ISA up to remove it.

Figure 1-1293 Remove the ISA

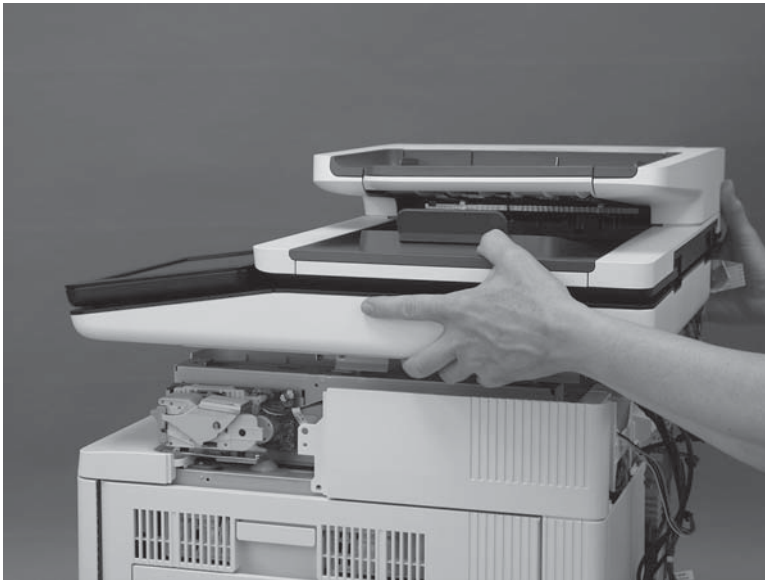

Step 16: Remove the stapler unit (M577c/f/z)



NOTE: This step is for the M577c/f/z models. For the M577dn model, skip this step and go to [Step 17: Remove the right upper cover \(M577\) on page 747](#).

For the M552 and M553 models, skip this step and go to [Step 22: Remove the output bin on page 755](#).

1. Disconnect one connector (callout 1), and then remove two screws (callout 2).

Figure 1-1294 Disconnect connector and remove screws

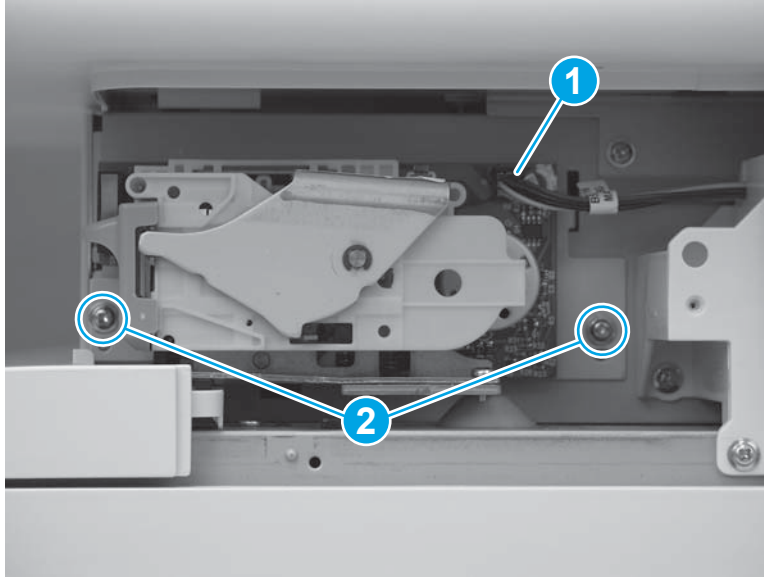

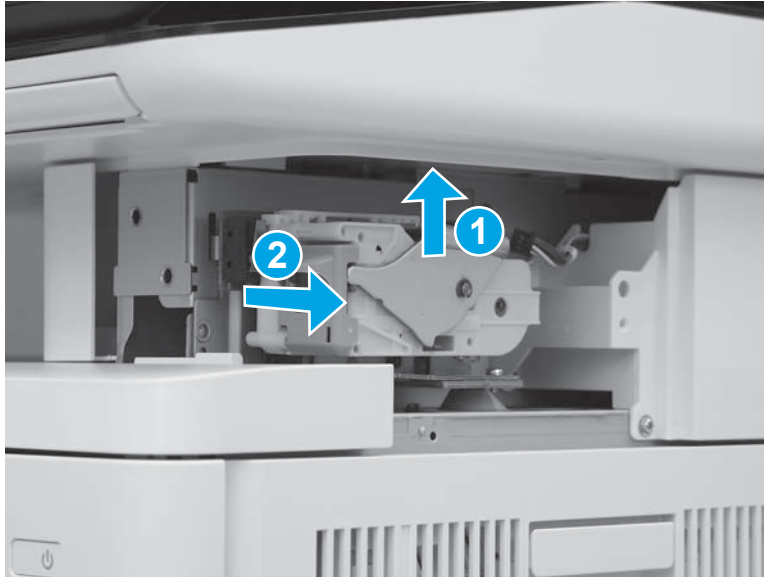

2. Slide the stapler unit up (callout 1), and then pull it away from the printer (callout 2) to remove it.

Figure 1-1295 Remove the stapler unit



Step 17: Remove the right upper cover (M577)

 **NOTE:** This step is for the M577 models. For the M552 and M553 models, skip this step and go to [Step 22: Remove the output bin on page 755](#).

 **NOTE:** The figures below show the image scanner installed. The procedures for removing and installing the right upper cover are the same whether the image scanner is installed or removed."

1. At the right side of the printer, remove two screws (callout 1).

M577c/f/z only: Disconnect one connector (callout 2), if it was not already disconnected in a previous step.

Figure 1-1296 Remove two screws and one connector

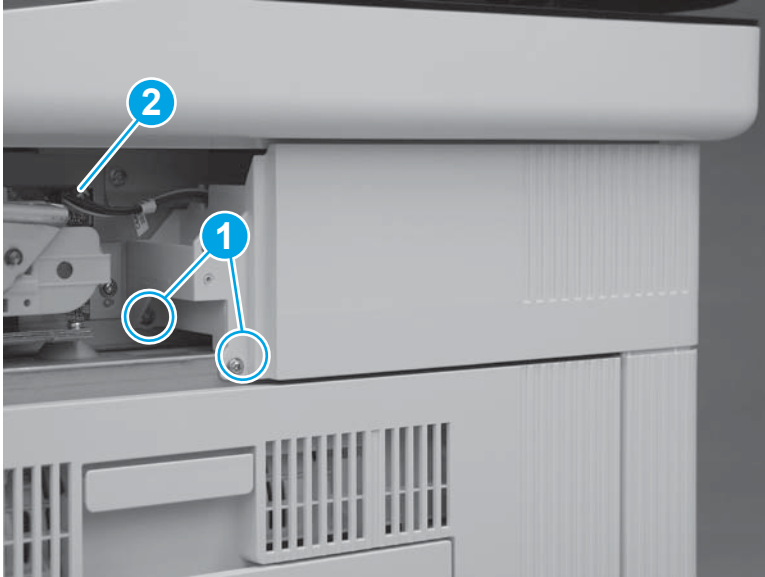

2. At the back of the printer, remove one screw (callout 1).

M577c/f/z only: Disconnect one connector (callout 2), if it was not already disconnected in a previous step.

 **Reinstallation tip:** This screw is smaller than the screws removed in the previous step. When reinstalling the right upper cover, make sure that this screw is installed in the correct position.

Figure 1-1297 Remove one screw and connector



3. Slide the cover toward the back of the printer.

Figure 1-1298 Slide the cover

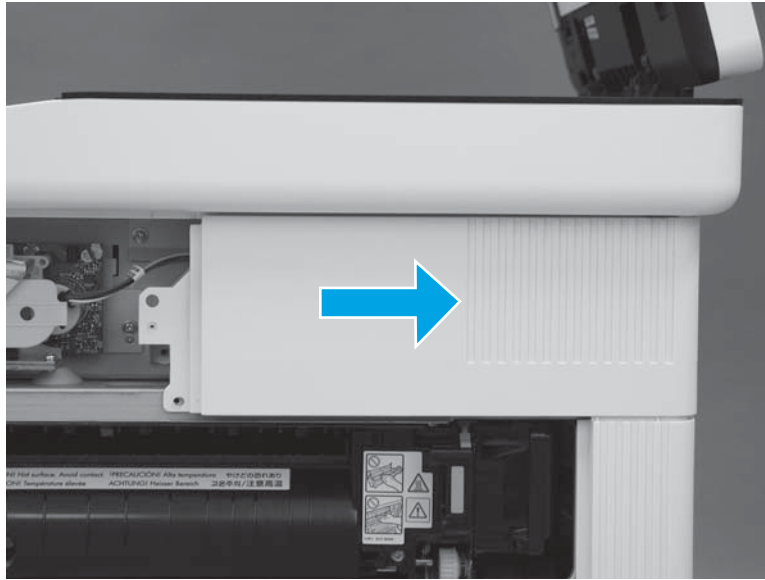

4. Lift the cover away from the printer to remove it.

M577c/f/z only: Release the cables (callout 1) through the slot (callout 2) in the printer.

Figure 1-1299 Remove the cover

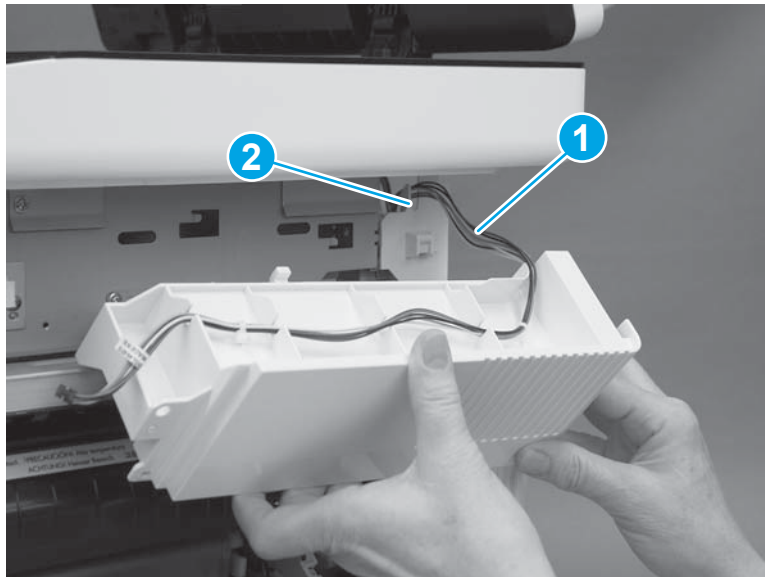

Step 18: Remove the top rear cover (M577)

 **NOTE:** This step is for the M577 models. For the M552 and M553 models, skip this step and go to [Step 22: Remove the output bin on page 755](#).

1. At the top of the printer, remove five screws (callout 1).

Figure 1-1300 Remove five screws

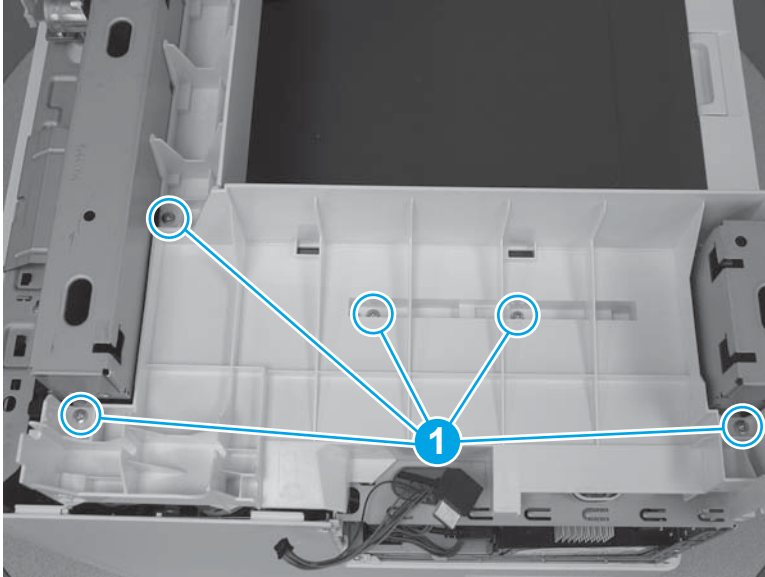

2. Release two tabs (callout 1) on the front edge of the cover.

Figure 1-1301 Release two tabs

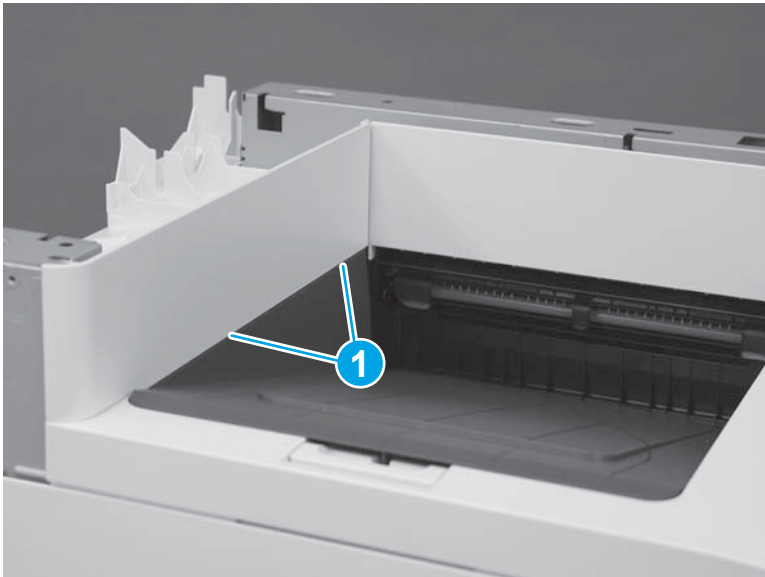

3. Remove the top rear cover.

Figure 1-1302 Remove the top rear cover

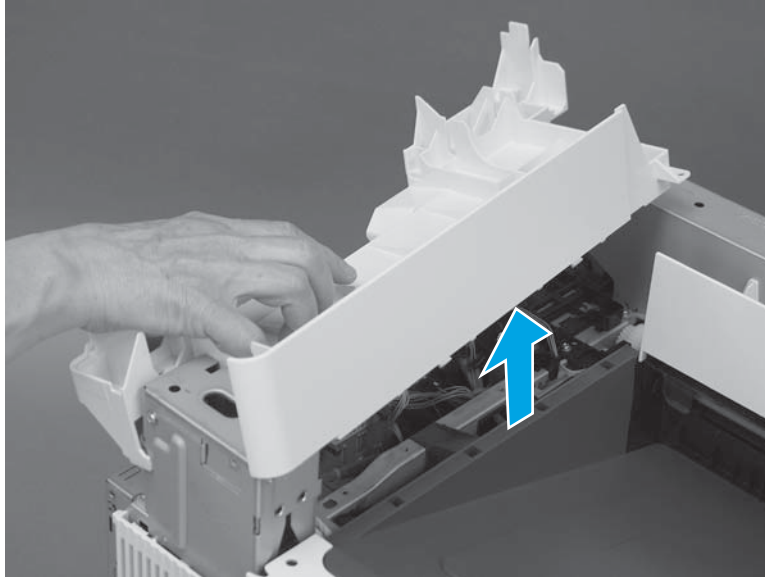

Step 19: Remove the paper feed cover (M577)



NOTE: This step is for the M577 models. For the M552 and M553 models, skip this step and go to [Step 22: Remove the output bin on page 755](#).

1. Remove one screw (callout 1).

Figure 1-1303 Remove one screw

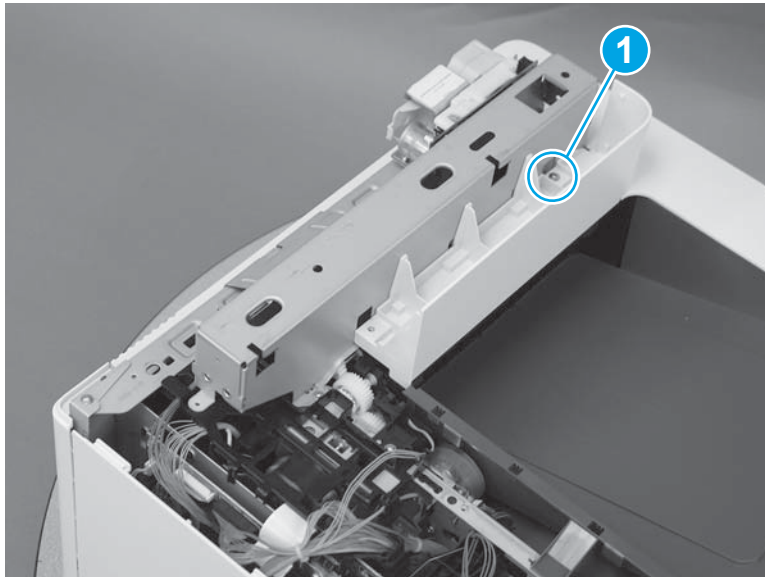

2. Lift the cover up to remove it.

Figure 1-1304 Remove the cover

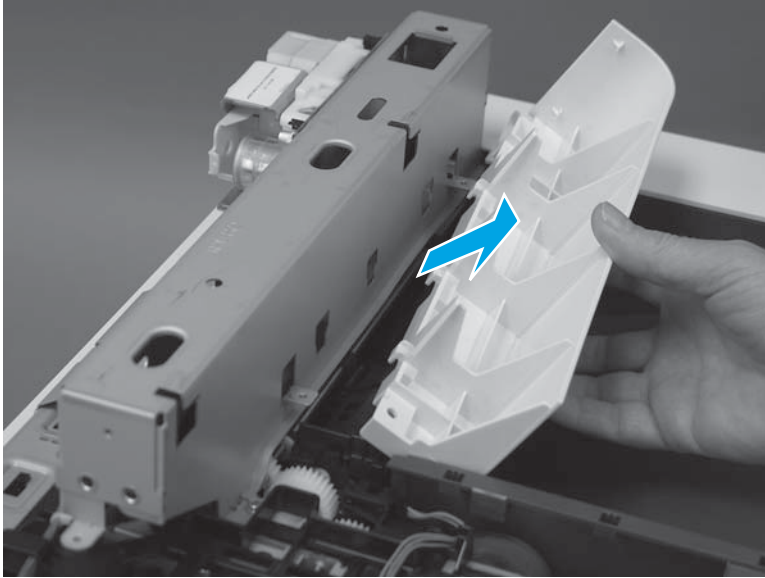

Step 20: Remove the top cover (M577)



NOTE: This step is for the M577 models. For the M552 and M553 models, skip this step and go to [Step 22: Remove the output bin on page 755](#).

1. At the front of the printer, remove one screw (callout 1).



Reinstallation tip: This screw is longer and a different type of screw than the screw removed in the next step. When reinstalling the top cover, make sure that this screw is installed in the correct position.

Figure 1-1305 Remove one screw

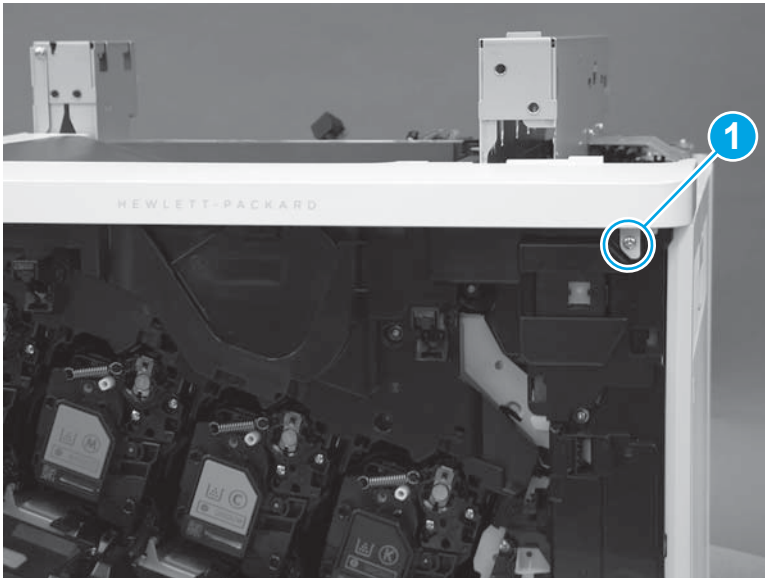

2. At the left side of the printer, remove one screw (callout 1).

Figure 1-1306 Remove one screw

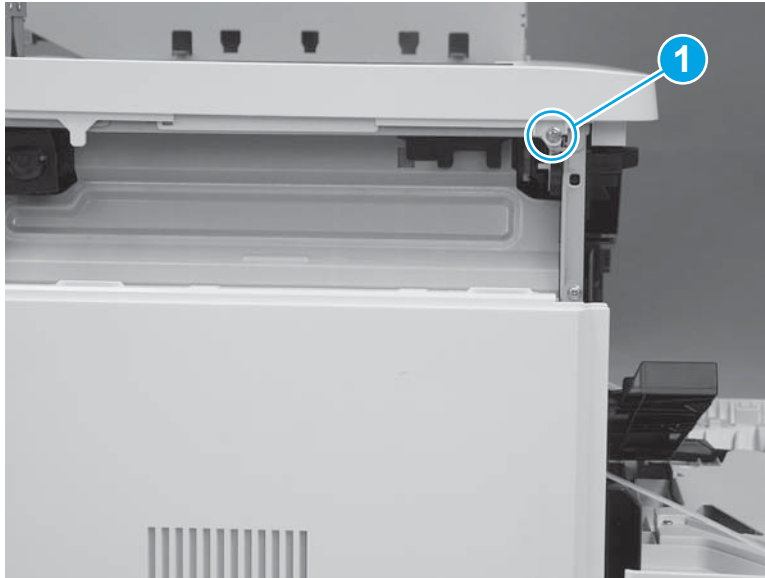

3. At the front of the printer, release one tab (callout 1).

Figure 1-1307 Release one tab



4. At the top of the printer, release two tabs (callout 1) next to the output bin, and then remove the top cover.

Figure 1-1308 Release two tabs

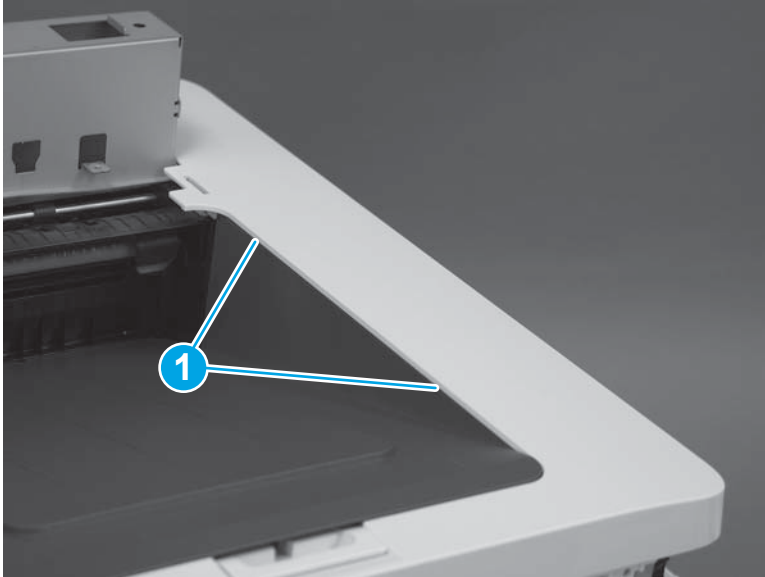

Step 21: Remove the top bracket (M577)



NOTE: This step is for the M577 models. For the M552 and M553 models, skip this step and go to [Step 22: Remove the output bin on page 755](#).

1. At the top of the printer, remove three screws (callout 1).

Figure 1-1309 Remove three screws

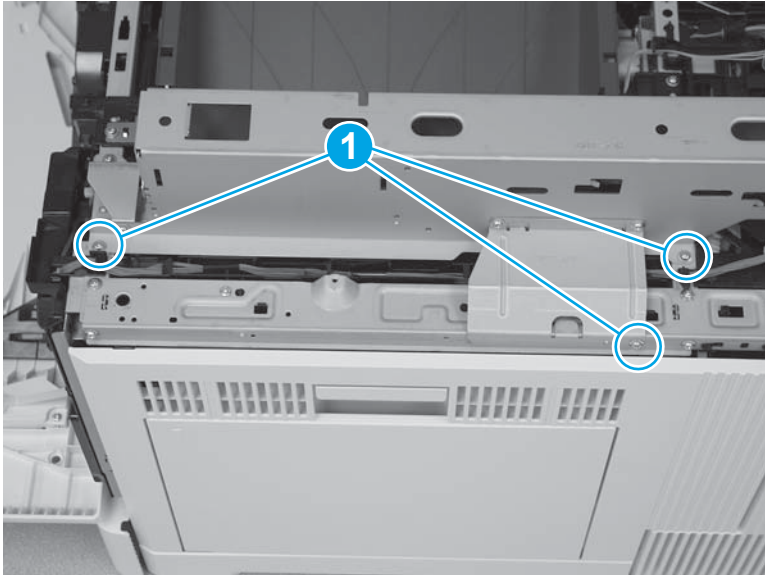

2. At the top of the printer, remove two screws (callout 1).

Figure 1-1310 Remove two screws

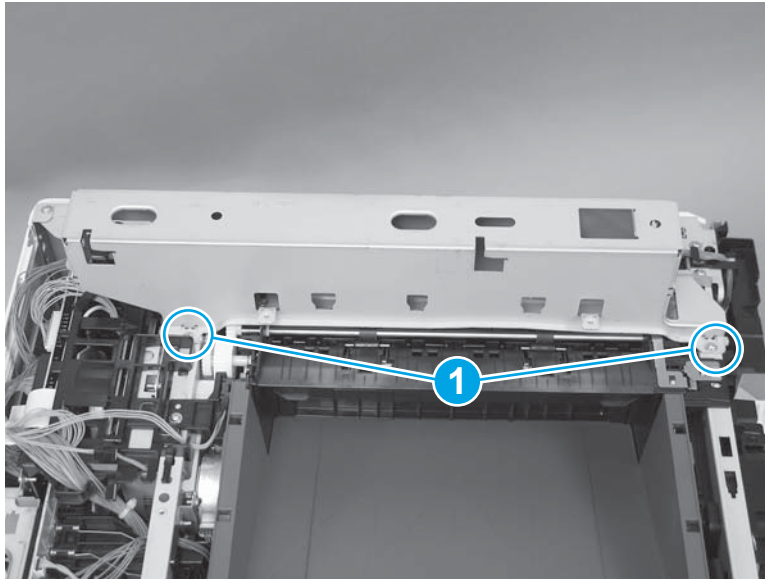

3. Lift the top bracket up to remove it.

Figure 1-1311 Remove the bracket

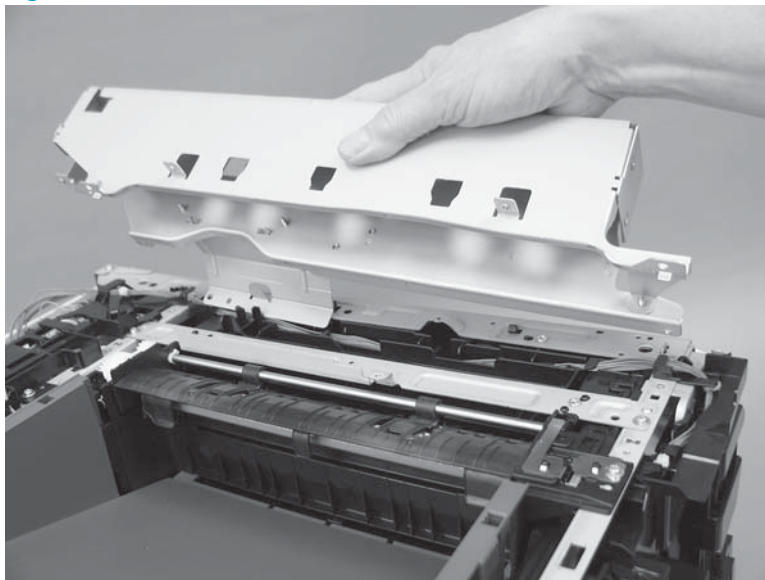

Step 22: Remove the output bin

1. Slightly slide and lift the cover to release it.

Figure 1-1312 Release the cover

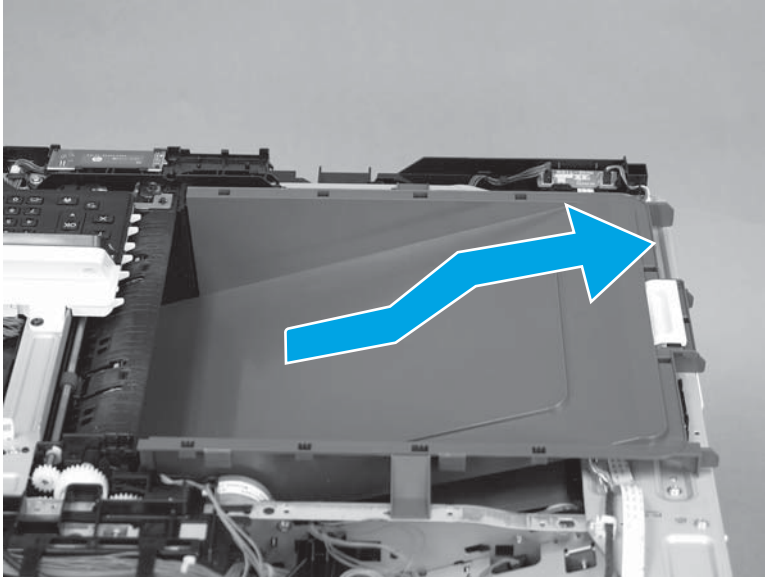

2. Remove the cover.

Figure 1-1313 Remove the cover

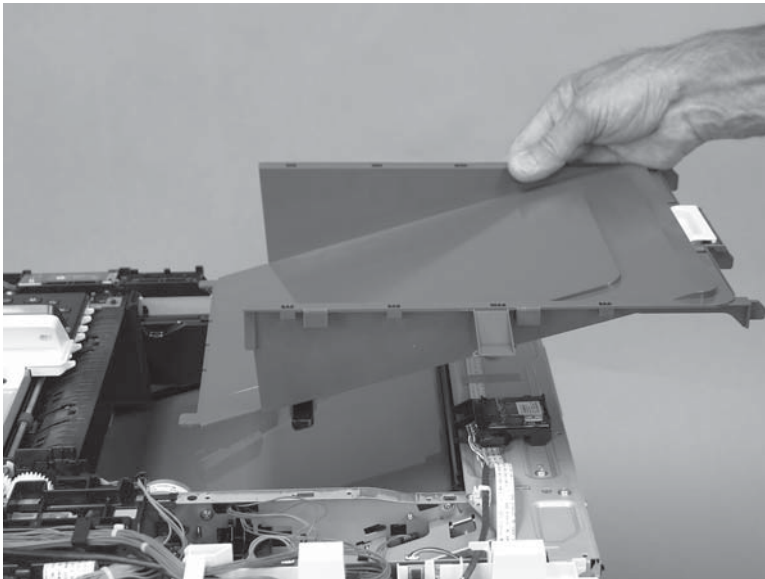

Step 23: Remove the delivery assembly

1. At the right side of the printer, remove two screws (callout 1).

 **NOTE:** These two screws are the self-tapping type.

Figure 1-1314 Remove two screws

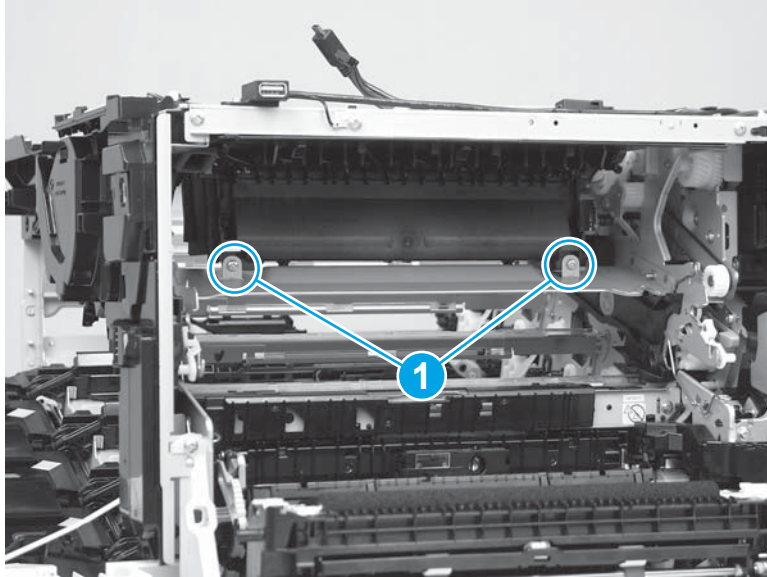

- 2. M553x only:** At the top-front-right corner of the printer, disconnect one connector (callout 1), remove one screw (callout 2), and then remove the near field communication (NFC) PCA and holder by sliding them to the right (callout 3).

Figure 1-1315 Remove the PCA

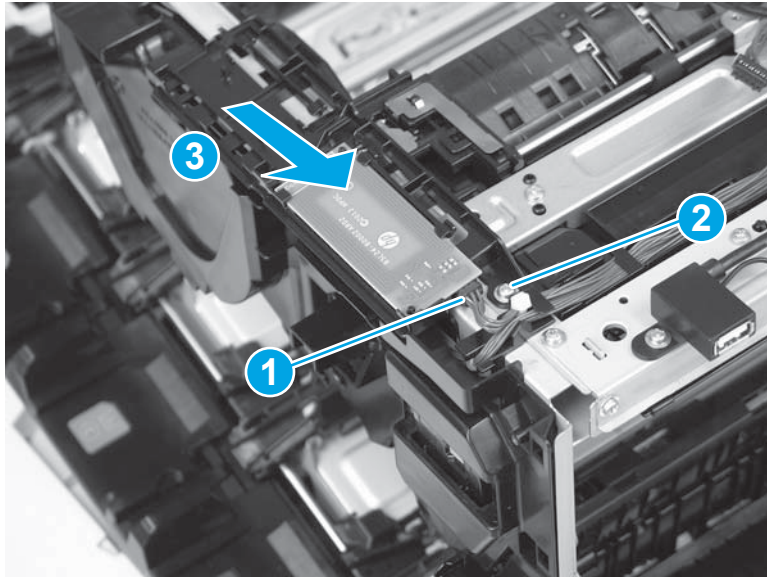

3. Release two retainers (callout 1), remove the USB cable (callout 2) from the retainers, and then disconnect one connector (callout 3).

Figure 1-1316 Release two retainers and disconnect one connector

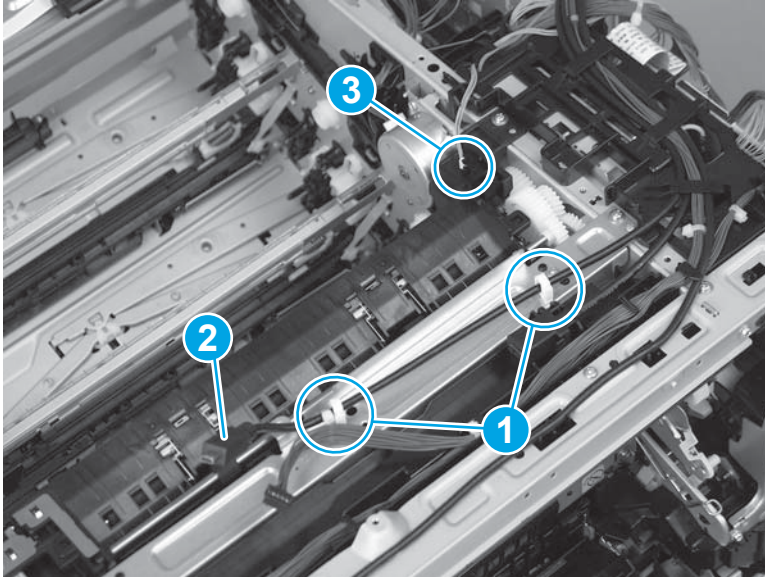

4. Remove four screws (callout 1).

Figure 1-1317 Remove four screws

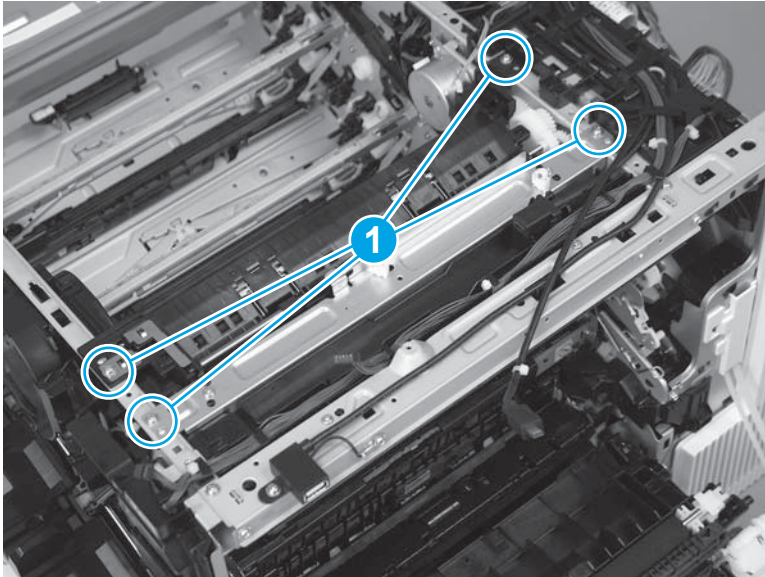

5. Remove the delivery assembly.

 **NOTE:** The solenoid plunger and arm (callout 1) located on the right side of the assembly are not captive. Do not lose the plunger and arm when handling the assembly.

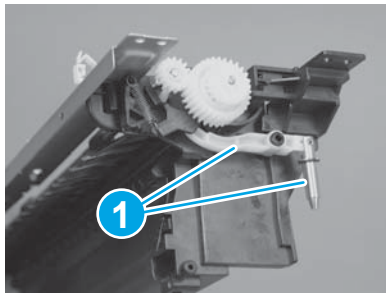
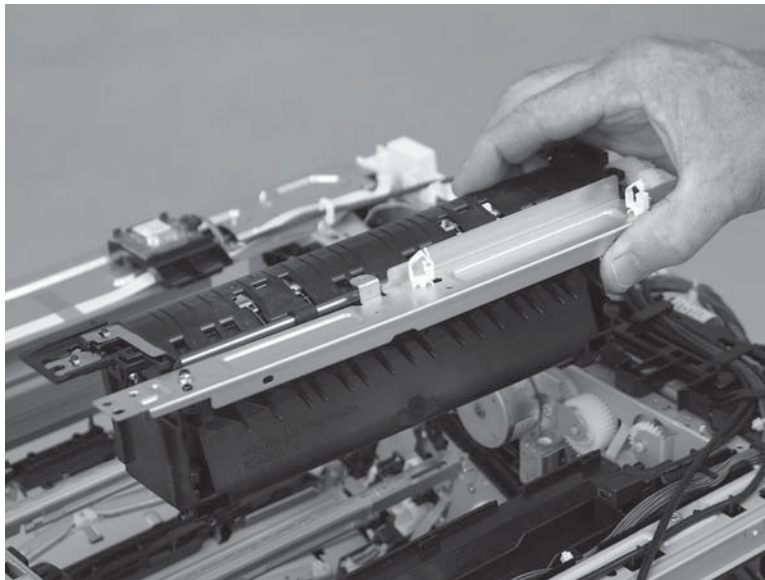

Figure 1-1318 Remove the assembly



Step 24: Unpack the replacement assembly

Unpack the replacement assembly from the packaging.

For complete information on HP's recycling programs, go to [Product return and recycling](#).

 **NOTE:** HP recommends responsible disposal of the defective assembly.

Figure 1-1319 Recycle and unpack

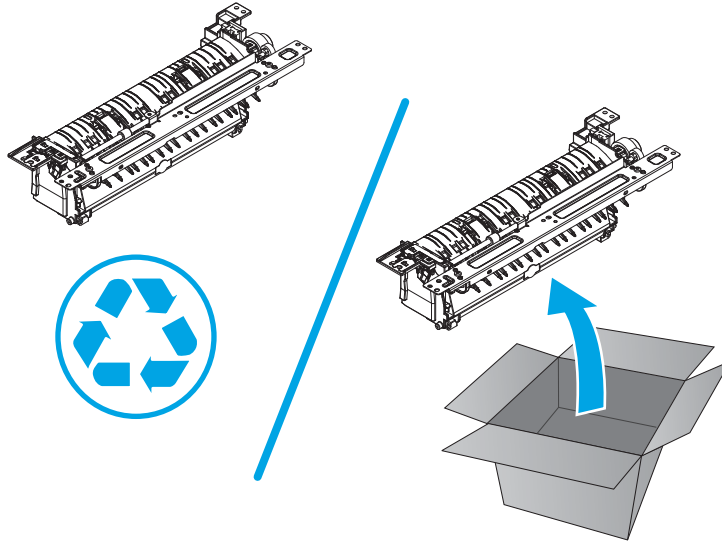

Step 25: Install the delivery assembly

1. Locate the solenoid plunger and arm (callout 1) on the right side of the removed delivery assembly.

Figure 1-1320 Locate the solenoid plunger

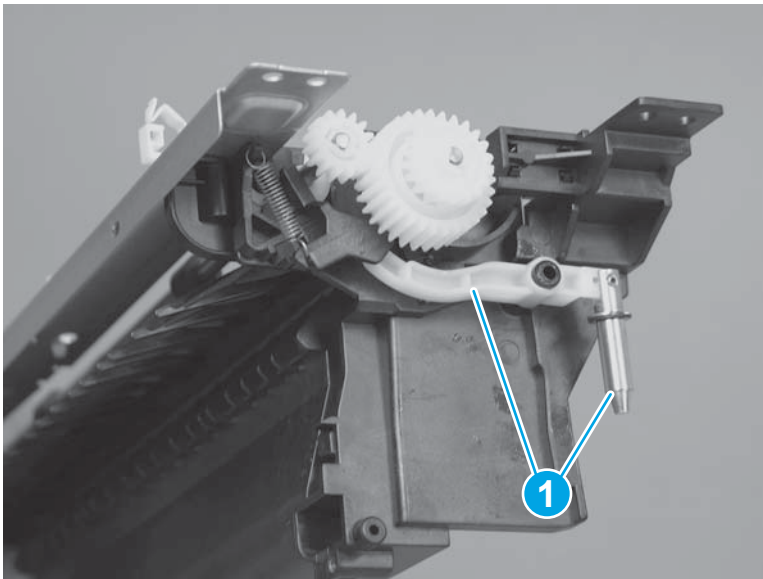

2. Remove the arm from the assembly.

Figure 1-1321 Remove the arm

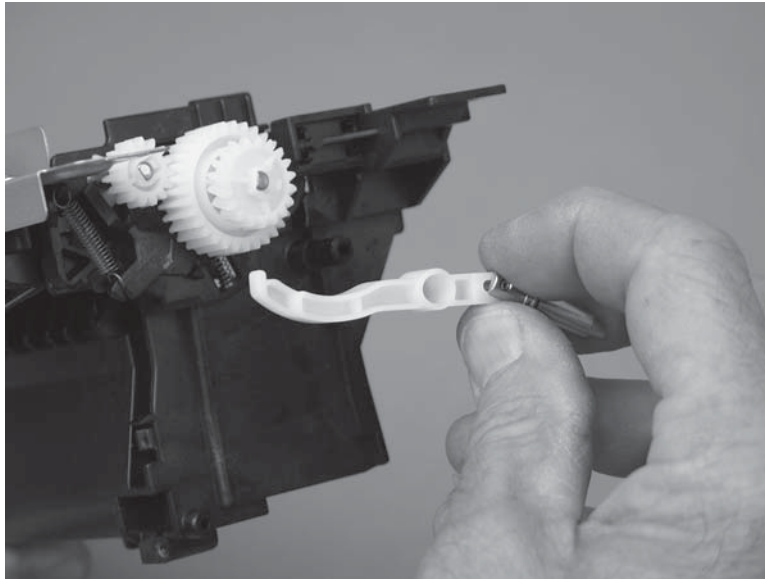

3. Pull the solenoid plunger off of the arm to separate them.

Figure 1-1322 Separate the solenoid plunger from the arm

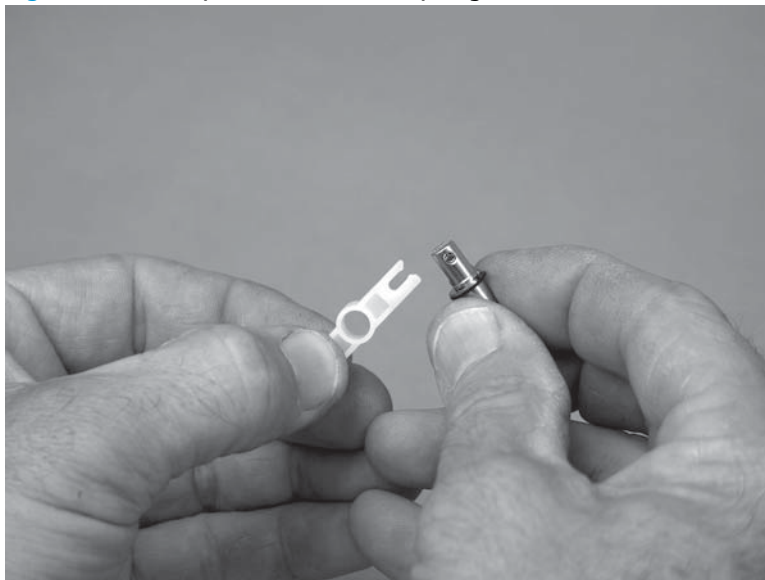

4. Install the solenoid plunger on the arm of the replacement delivery assembly.

Figure 1-1323 Install the solenoid plunger

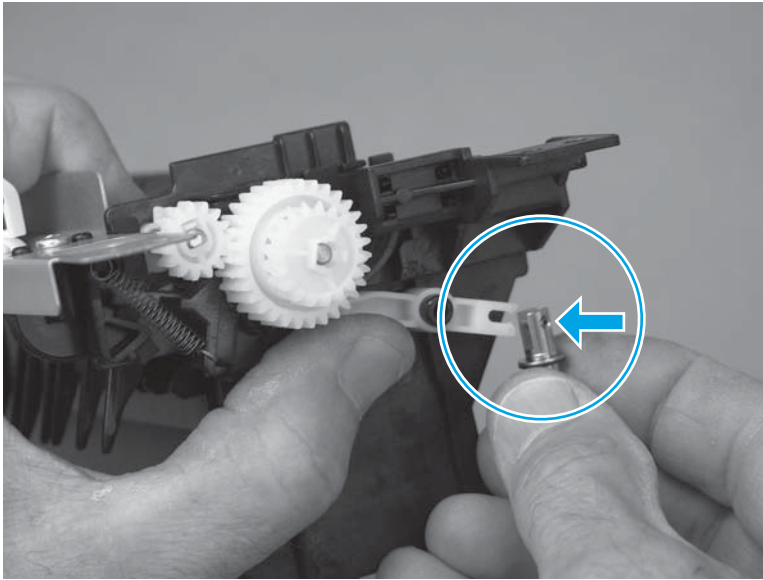

5. Position the delivery assembly on the printer—make sure that the solenoid plunger is placed into the solenoid when the assembly is installed.

Figure 1-1324 Install the assembly

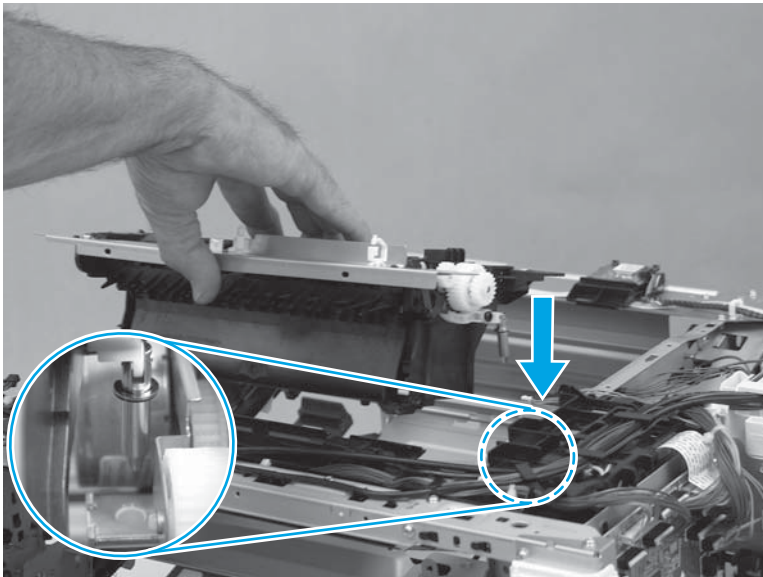

6. Install four screws (callout 1).

Figure 1-1325 Install four screws

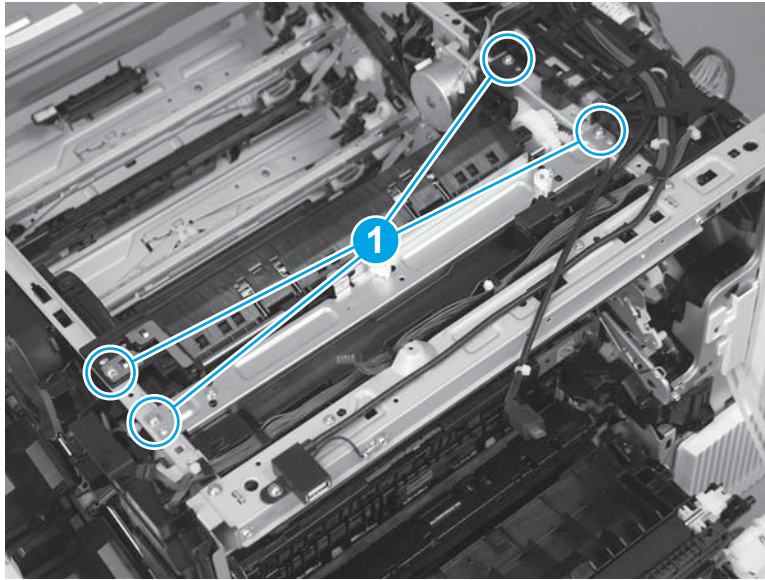

7. Connect one connector (callout 1), and then place the USB cable (callout 2) in the retainers (callout 3).

Figure 1-1326 Connect one connector

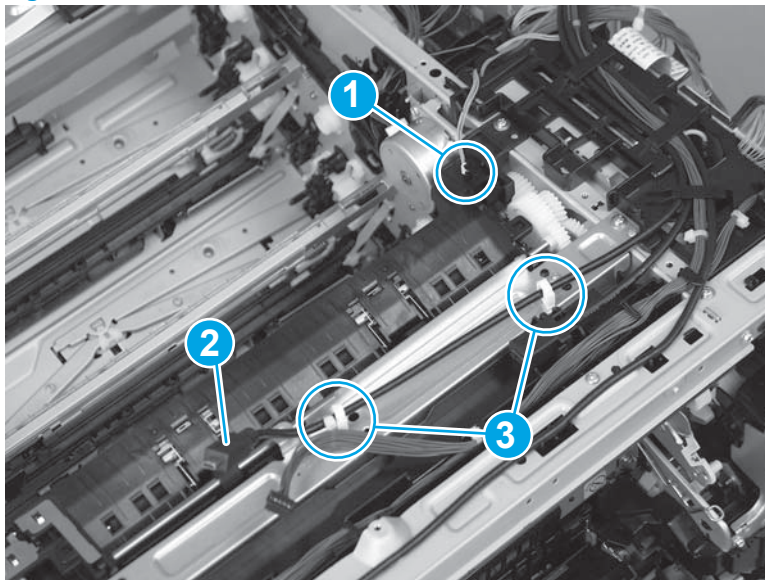

- 8. M553x only:** At the top-front-right corner of the printer, install the tab on the NFC PCA holder (callout 1) in the slot (callout 2) in the chassis.

Figure 1-1327 Install the PCA holder

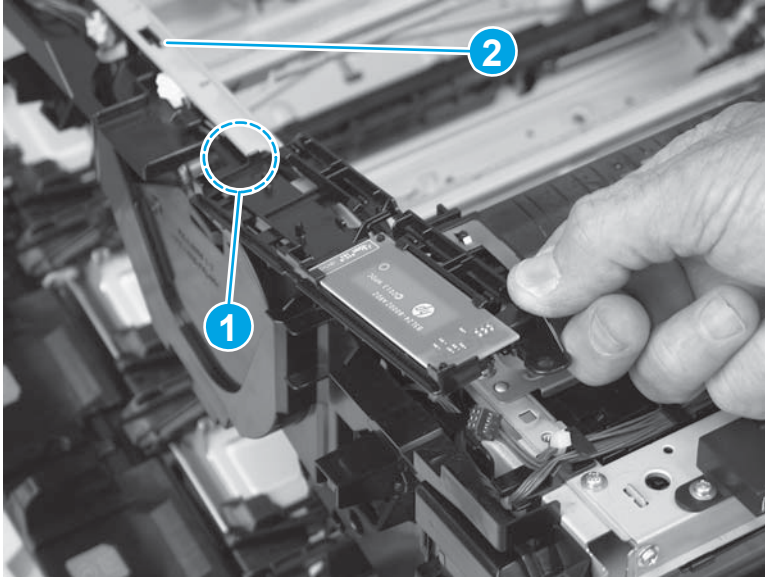

- 9. M553x only:** Rotate the NFC PCA holder down (callout 1) to install it, and then install one screw (callout 2).

Figure 1-1328 Install one screw

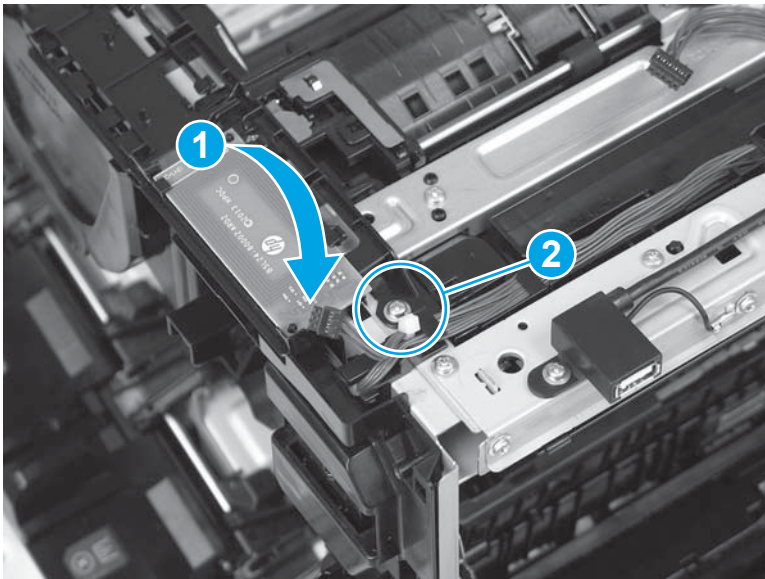

10. **M553x only:** Connect one connector (callout 1) on the NFC PCA.

Figure 1-1329 Connect one connector

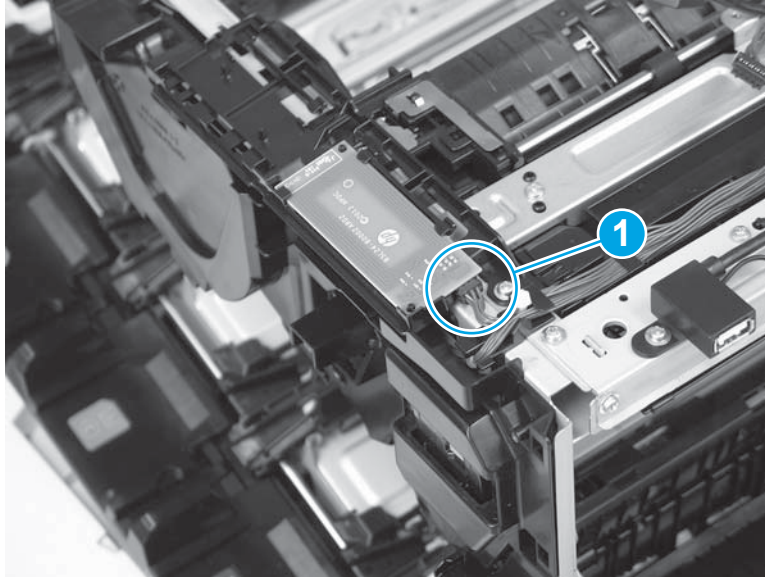

11. At the right side of the printer, install two screws (callout 1).

 **NOTE:** These two screws are the self-tapping type.

Figure 1-1330 Install two screws

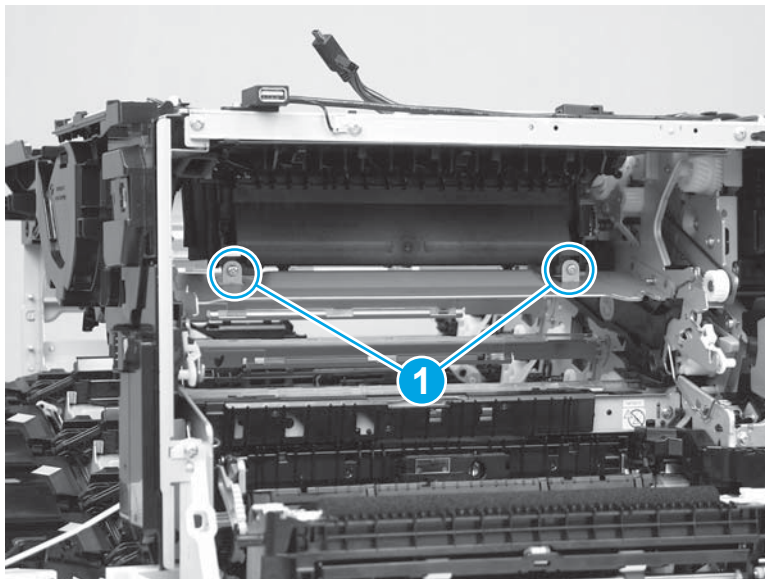

Step 26: Install the output bin

1. Position the cover near the printer.

Figure 1-1331 Install the cover

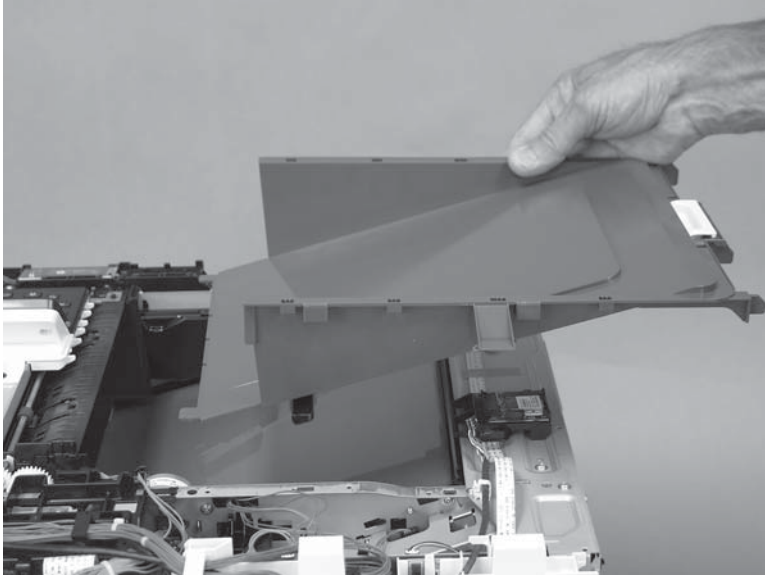

2. Align the tabs on the cover with the slots in the printer.

Figure 1-1332 Align the tabs

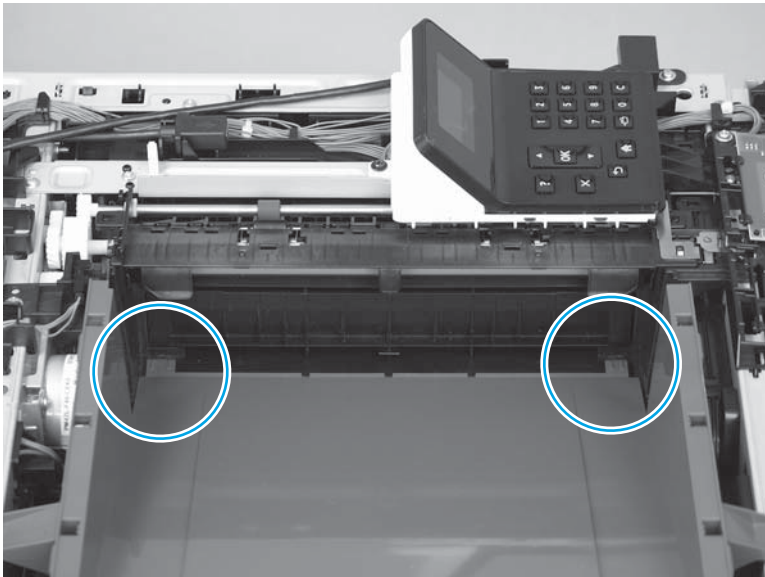

3. Slide and lower the cover onto the printer to install it.

Figure 1-1333 Release the cover

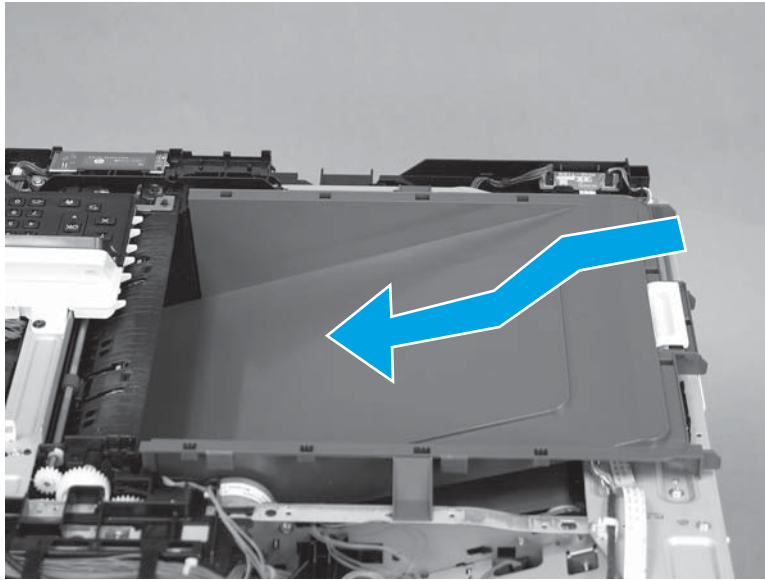

4. Verify that the tabs on the front- and rear-side of the cover are correctly installed in the slots in the chassis.

Figure 1-1334 Verify the installation

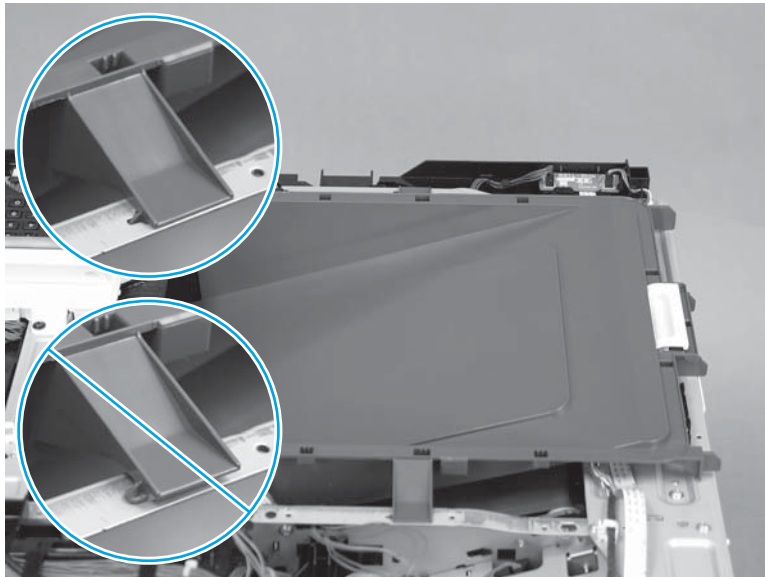

Step 27: Install the top bracket (M577)

 **NOTE:** This step is for the M577 models. For the M552 and M553 models, skip this step and go to [Step 38: Install the control panel \(M553n/dn and M552dn only\) on page 787.](#)

1. Position the tabs (callout 1) on the bracket in the slots (callout 2) in the printer.

Figure 1-1335 Position the tabs in the slots

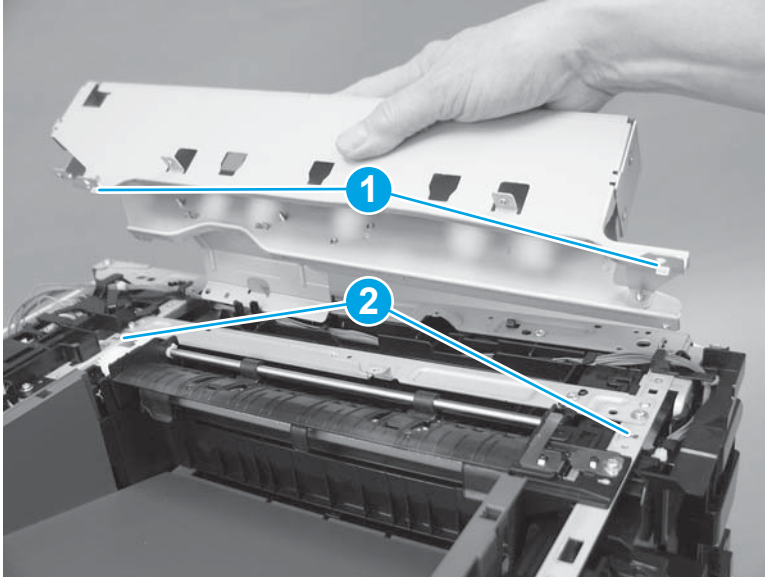

2. At the top of the printer, install two screws (callout 1).

Figure 1-1336 Install two screws

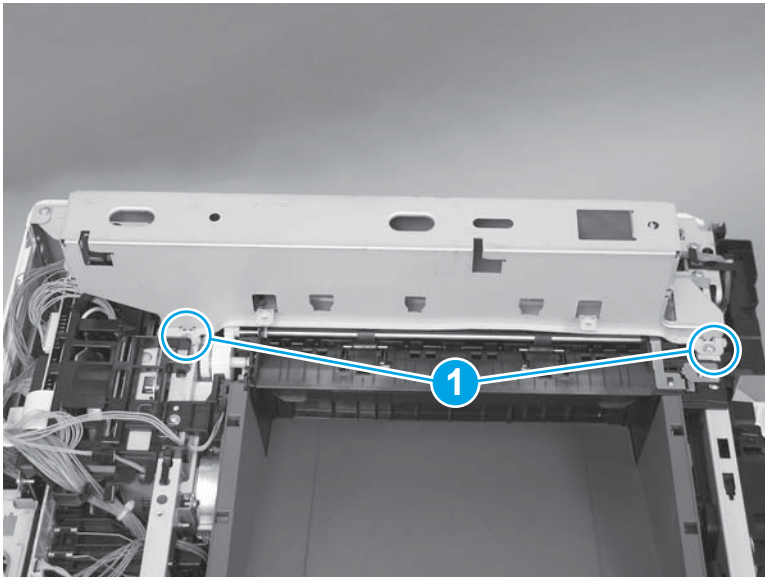

3. At the top of the printer, install three screws (callout 1).

Figure 1-1337 Install three screws

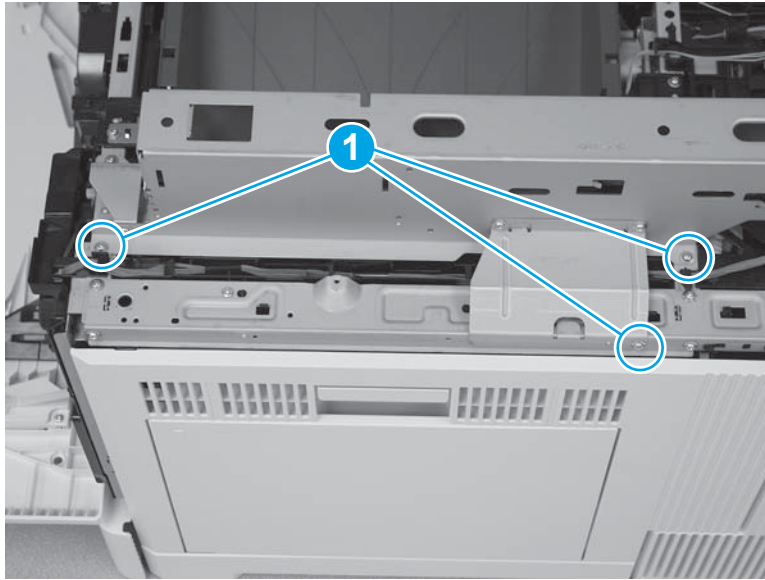

Step 28: Install the top cover (M577)

 **NOTE:** This step is for the M577 models. For the M552 and M553 models, skip this step and go to [Step 38: Install the control panel \(M553n/dn and M552dn only\) on page 787](#).

1. Position the locator pins (callout 1) on the cover in the slots (callout 2) in the printer.

Figure 1-1338 Position the locator pins

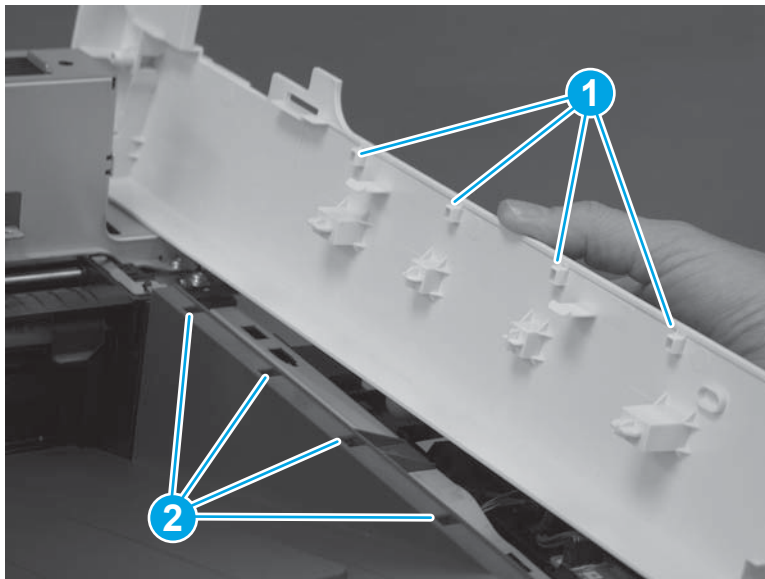

2. Press down on the cover to install it. Make sure that the tabs (callout 1) snap into place.

Figure 1-1339 Press down on the cover

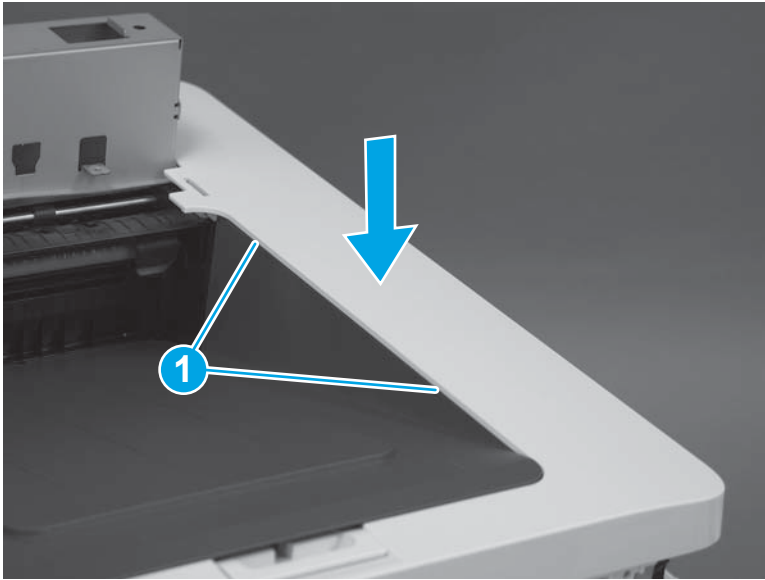

3. At the front of the printer, install one screw (callout 1).

 **Reinstallation tip:** This screw is longer and a different type of screw than the screw installed in the next step. Make sure that this screw is installed in the correct position.

Figure 1-1340 Install one screw



4. At the left side of the printer, install one screw (callout 1).

Figure 1-1341 Install one screw

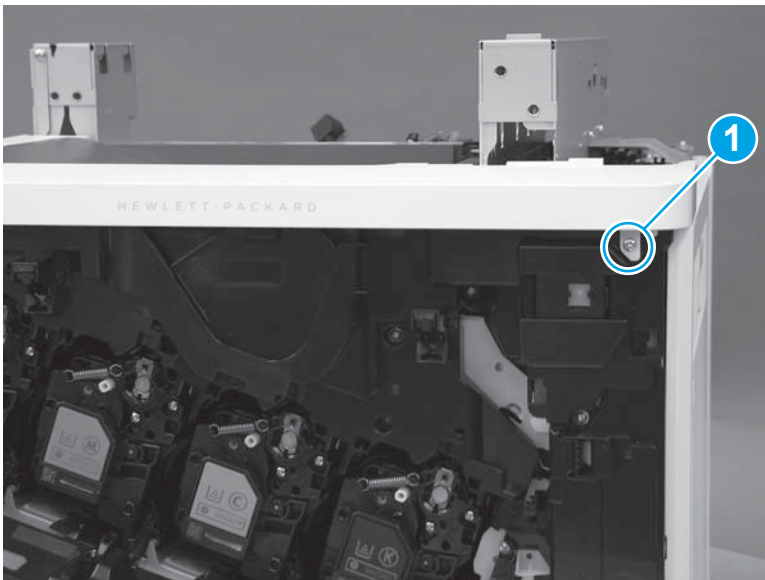
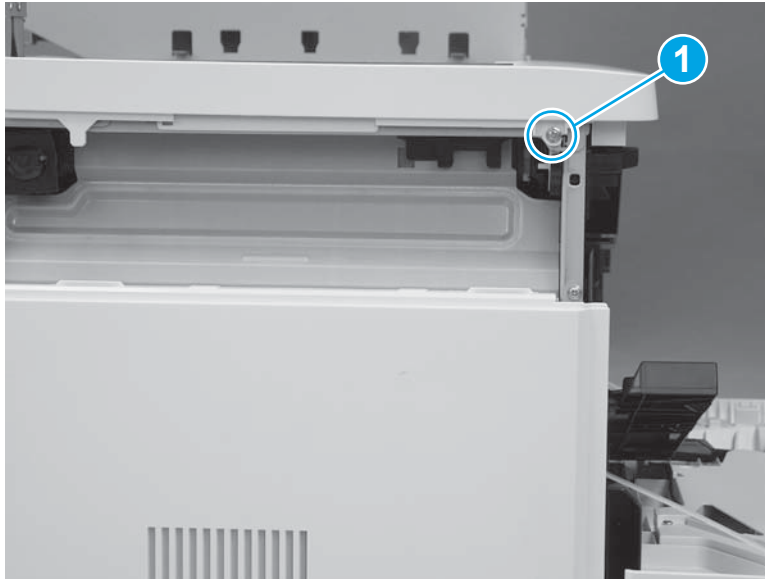

Step 29: Install the paper feed cover (M577)

 **NOTE:** This step is for the M577 models. For the M552 and M553 models, skip this step and go to [Step 38: Install the control panel \(M553n/dn and M552dn only\) on page 787.](#)

1. Position the locator tabs (callout 1) on the cover in the slots (callout 2) in the printer. Press down until the cover snaps into place.

Figure 1-1342 Install the cover

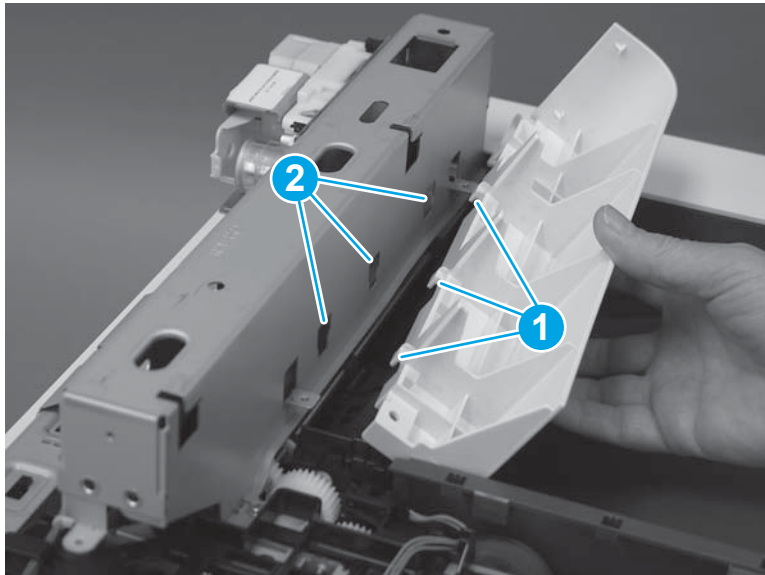

2. Install one screw (callout 1).

Figure 1-1343 Install one screw

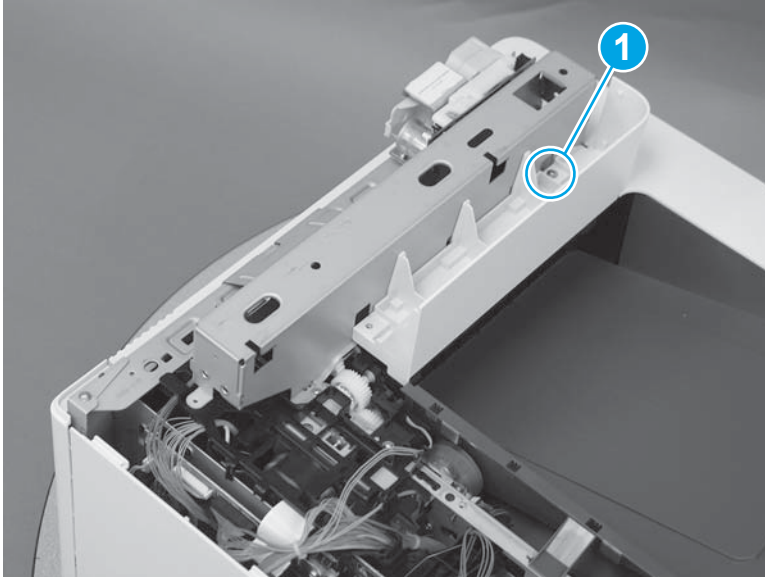

Step 30: Install the top rear cover (M577)



NOTE: This step is for the M577 models. For the M552 and M553 models, skip this step and go to [Step 38: Install the control panel \(M553n/dn and M552dn only\) on page 787.](#)

1. Align the locator tabs (callout 1) on the cover with the slots (callout 2) in the printer.

Figure 1-1344 Align the locator tabs

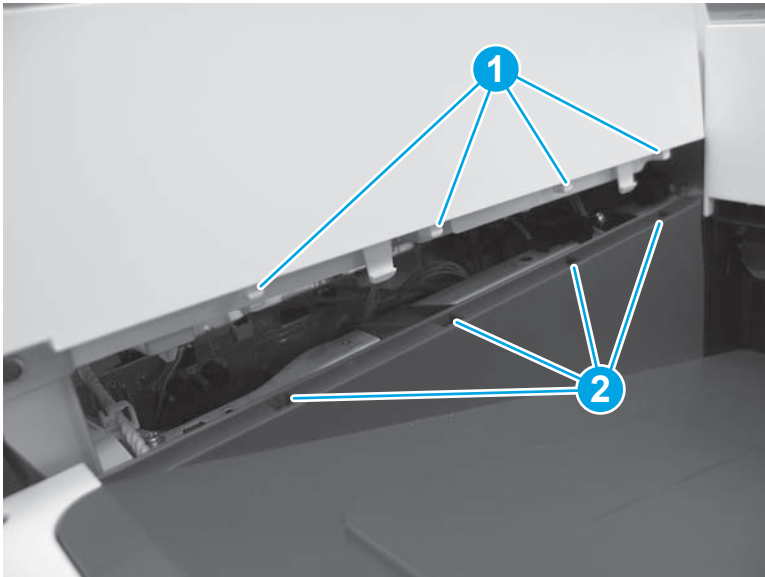

2. Press down to install the cover. Make sure that the tabs snap into place.

Figure 1-1345 Install the cover

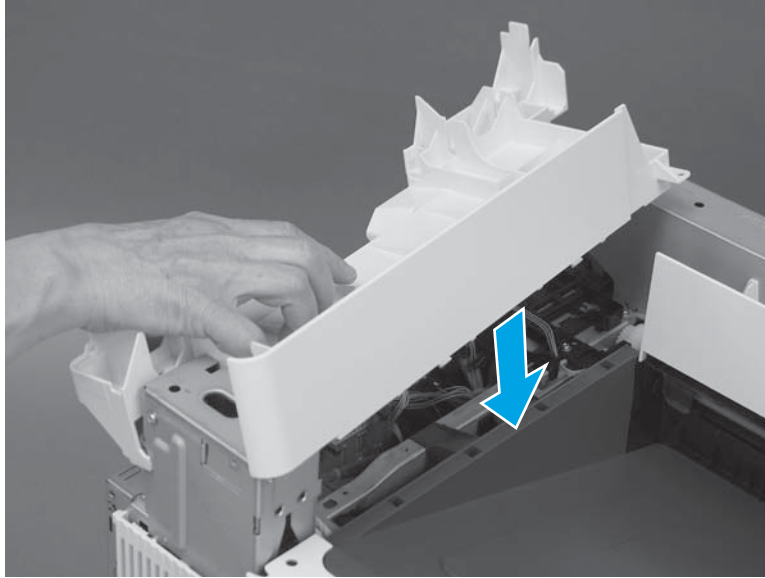

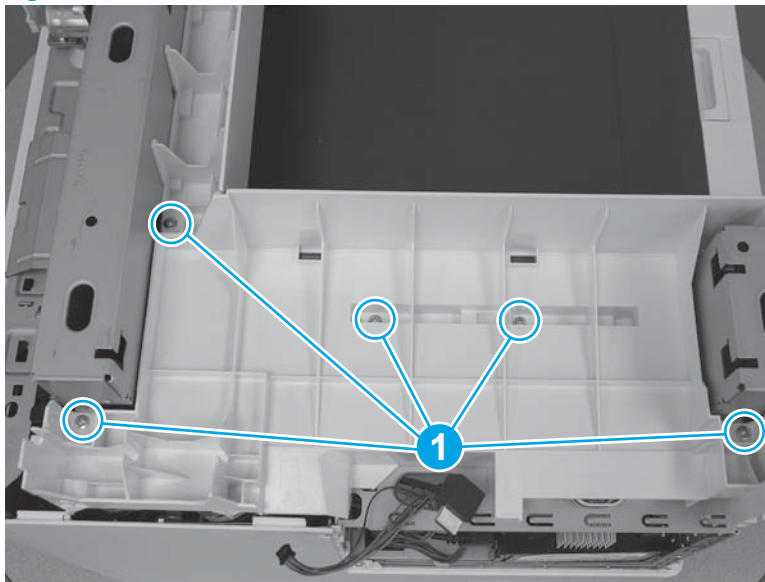

3. At the top of the printer, install five screws (callout 1).

Figure 1-1346 Install five screws



Step 31: Install the right upper cover (M577)

 **NOTE:** This step is for the M577 models. For the M552 and M553 models, skip this step and go to [Step 38: Install the control panel \(M553n/dn and M552dn only\) on page 787.](#)

 **NOTE:** The figures below show the image scanner installed. The procedures for removing and installing the right upper cover are the same whether the image scanner is installed or removed."

1. **M577c/f/z only:** Install the cables (callout 1) through the slot (callout 2) in the printer.

Figure 1-1347 Install the cables

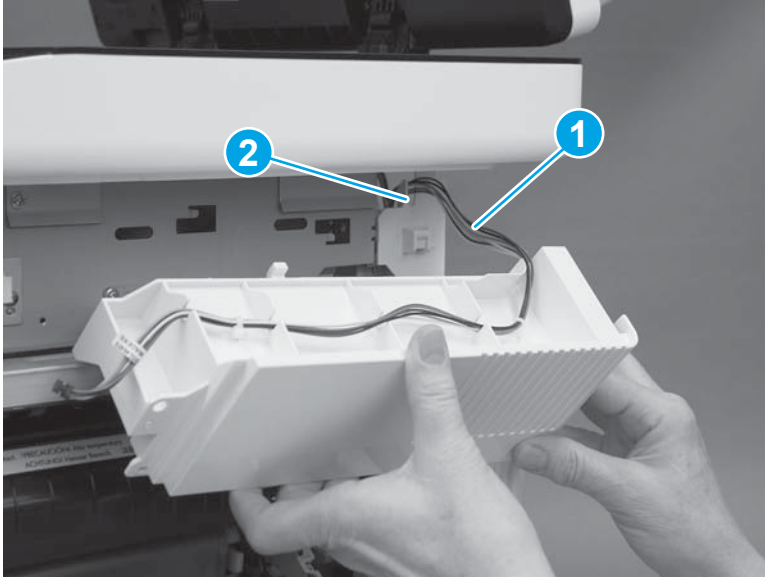

2. Position the hooks (callout 1) on the cover in the slots (callout 2) in the printer.

Figure 1-1348 Position the hooks

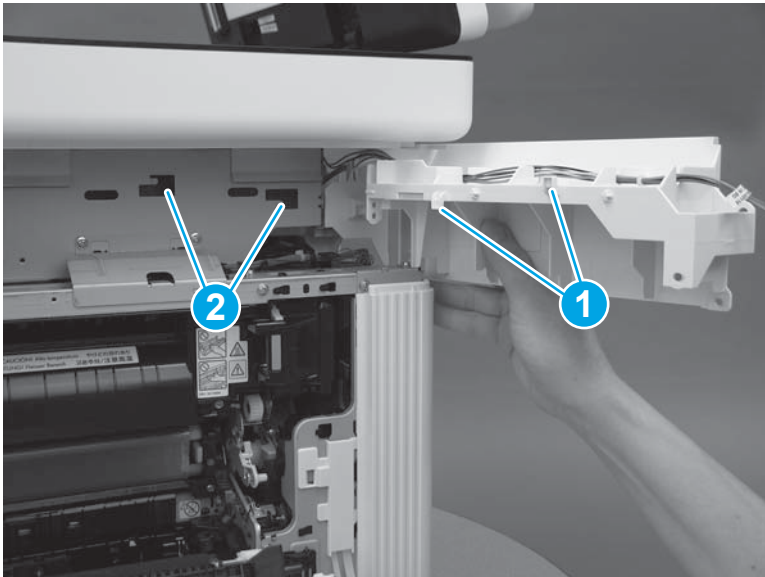

3. Slide the cover toward the front of the printer to install it.

Figure 1-1349 Install the cover

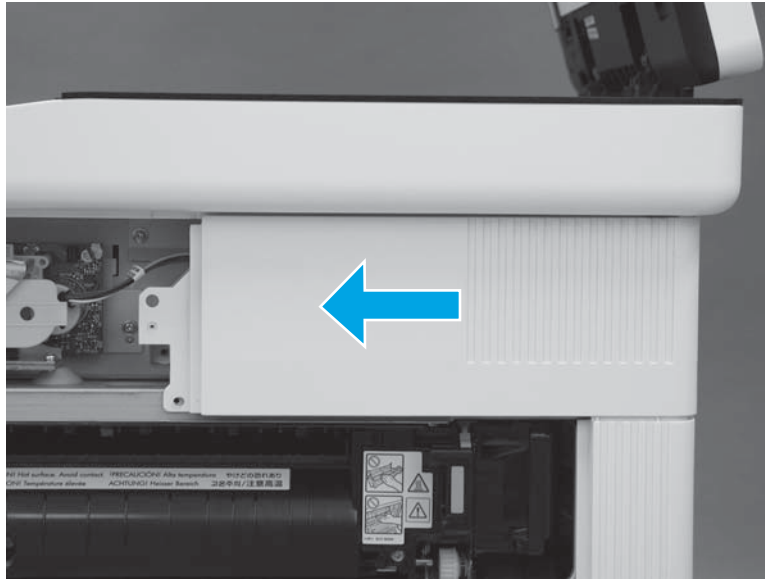

4. At the back of the printer, install one screw (callout 1).

M577c/f/z only: Connect one connector (callout 2), if the integrated scanner assembly is installed.

 **TIP:** This screw is smaller than the screws installed in the next step. Make sure that this screw is installed in the correct position.

Figure 1-1350 Install one screw and connector



5. At the right side of the printer, install two screws (callout 1).

M577c/f/z only: Connect one connector (callout 2), if the stapler is installed.

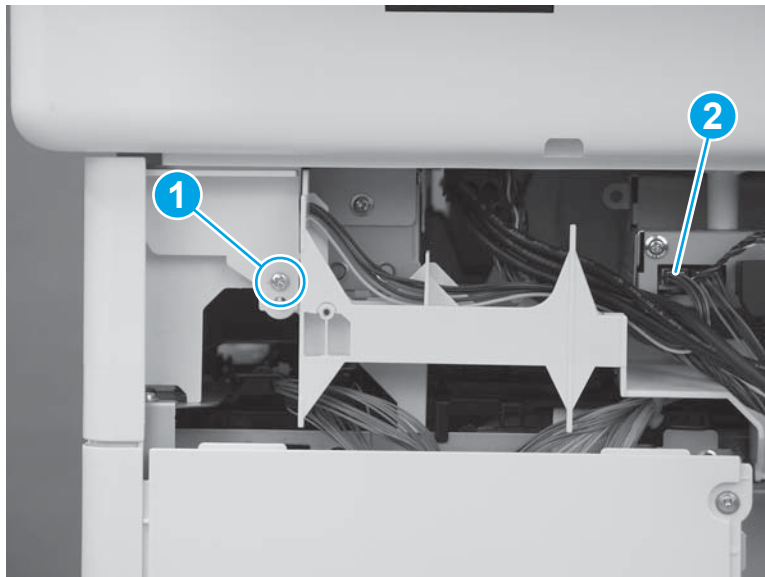
Figure 1-1351 Install one screw and connector

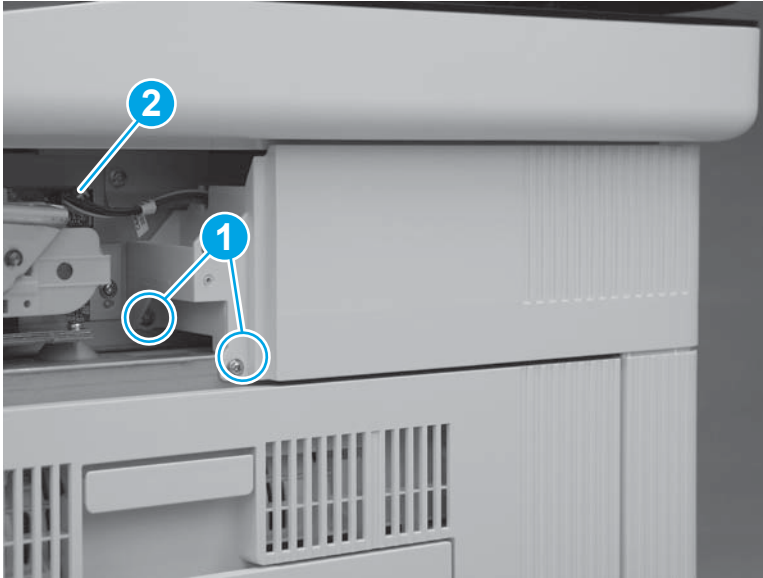

Step 32: Install the stapler unit (M577c/f/z)

 **NOTE:** This step is for the M577c/f/z models only. For the M577dn model, skip this step and go to [Step 33: Install the integrated scanner assembly \(M577\) on page 777](#).

For the M552 and M553 models, skip this step and go to [Step 38: Install the control panel \(M553n/dn and M552dn only\) on page 787](#).

1. Position the hooks (callout 1) on the stapler unit in the slots (callout 2) in the printer.

Figure 1-1352 Position the hooks in the slots

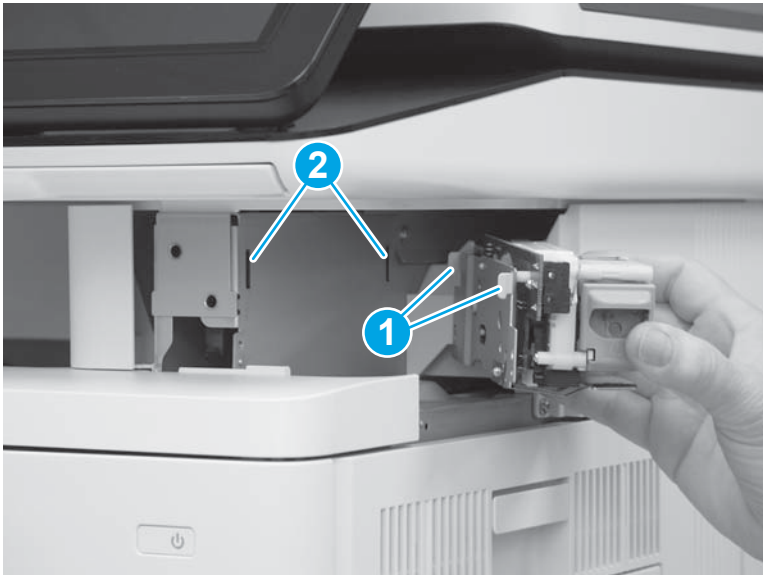

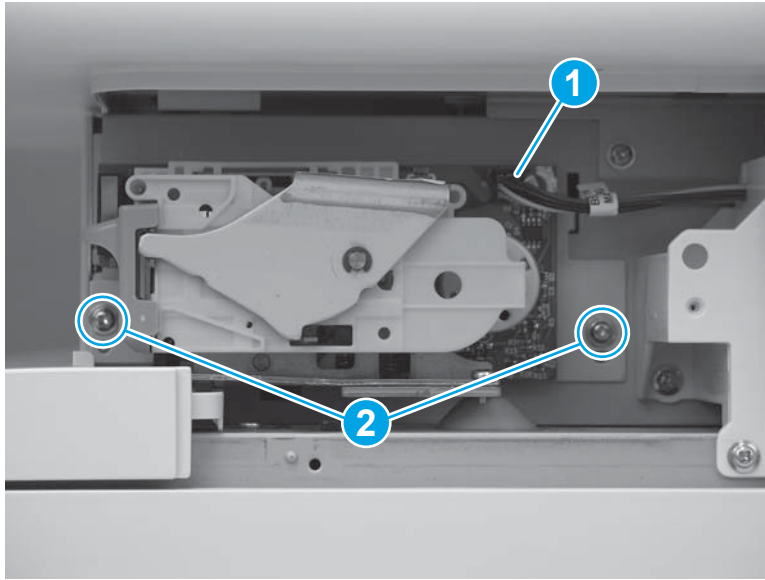

2. Connect one connector (callout 1), and then install two screws (callout 2).

Figure 1-1353 Connect connector and install screws



Step 33: Install the integrated scanner assembly (M577)

 **NOTE:** This step is for the M577 models. For the M552 and M553 models, skip this step and go to [Step 38: Install the control panel \(M553n/dn and M552dn only\) on page 787](#).

 **NOTE:** The ISA includes the document feeder, image scanner, scanner control board (SCB), control panel, keyboard (M577c/z) and NFC PCA (M577z).

1. Before proceeding, locate the mounting pins (callout 1) on the bottom of the ISA and the slots (callout 2) on the printer base.

Figure 1-1354 Locate the ISA mounting pins and slots

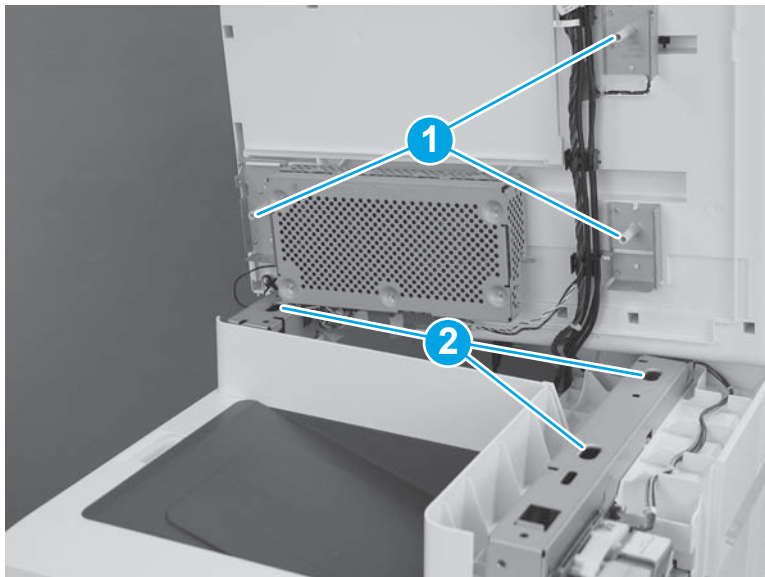

2. Position the ISA on the printer base with the pins in the slots.

 **NOTE:** To locate the pins and slots, see [Figure 1-395 Locate the ISA mounting pins and slots on page 250](#).

Figure 1-1355 Install the ISA



3. Slightly slide the ISA towards the front of the printer to engage it.

Figure 1-1356 Slide the ISA towards the front of the printer

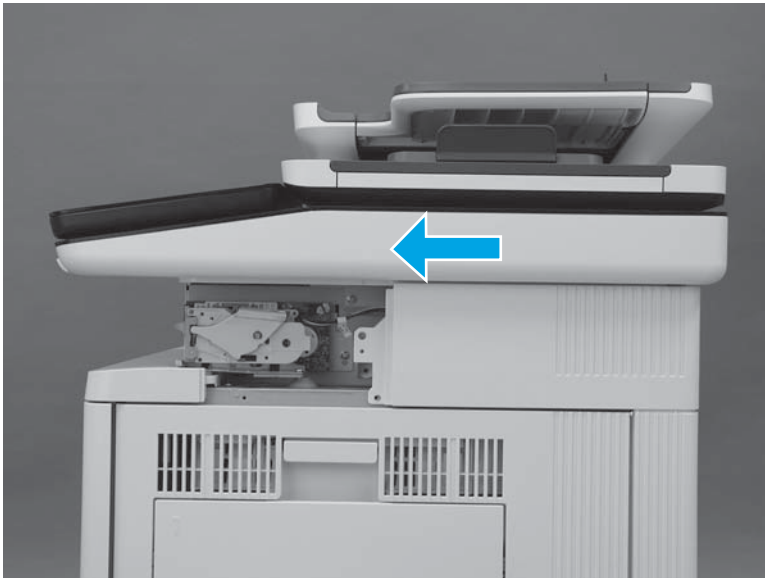

4. At the left side of the printer, install one screw (callout 1).

Figure 1-1357 Install one screw

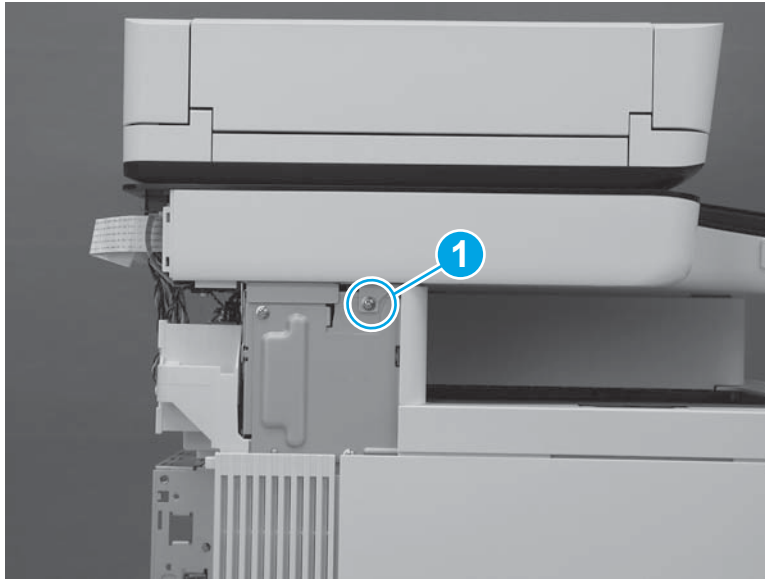

5. At the back of the printer, install two screws (callout 1).

Figure 1-1358 Install two screws

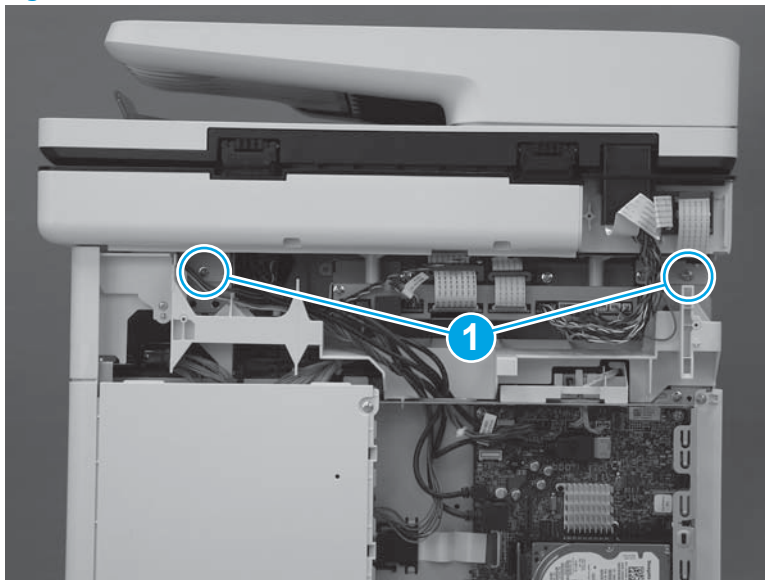

6. At the right side of the printer, install one screw (callout 1).

Figure 1-1359 Install one screw

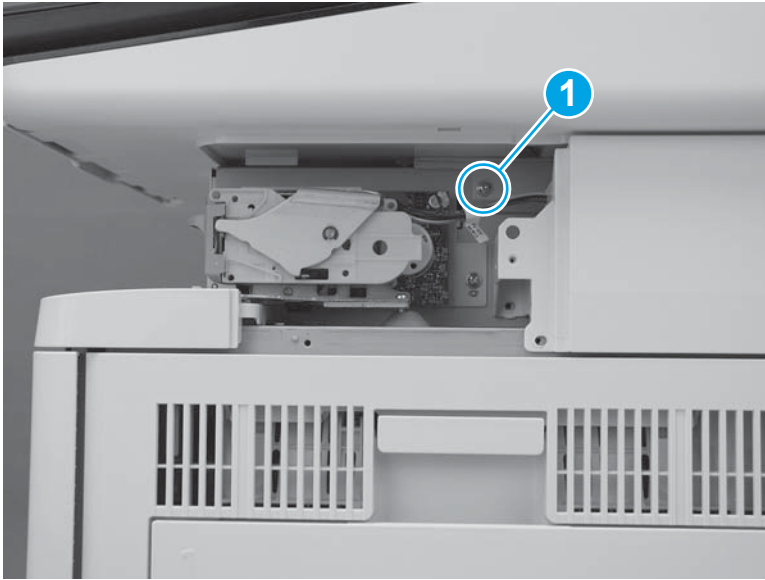

7. Connect two connectors on the scanner control board (callout 1).

M577c/f/z only: Connect one connector for the stapler on the scanner control board (callout 2).

Figure 1-1360 Connect connectors

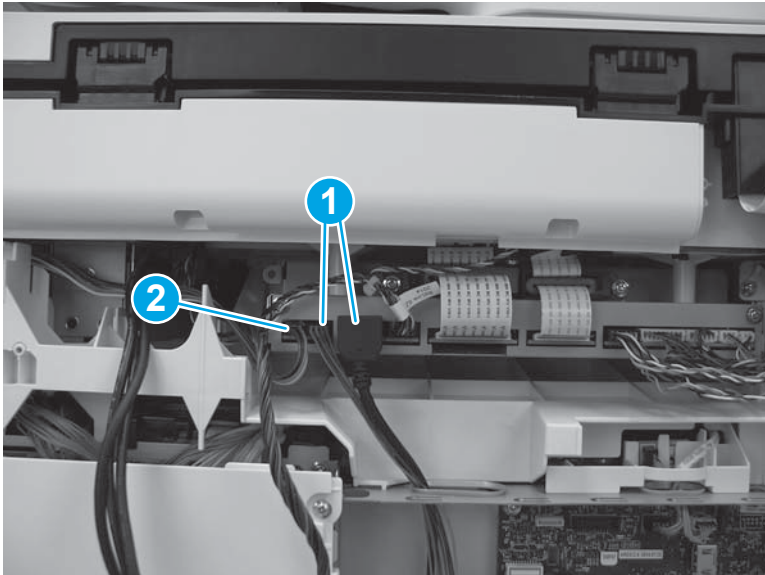

8. Install the wire harness and cables (callout 1) in the retainers (callout 2). Pass them through the opening in the top of the formatter cover (callout 3), and then connect four connectors (callout 4) on the formatter.

Figure 1-1361 Connect four connectors

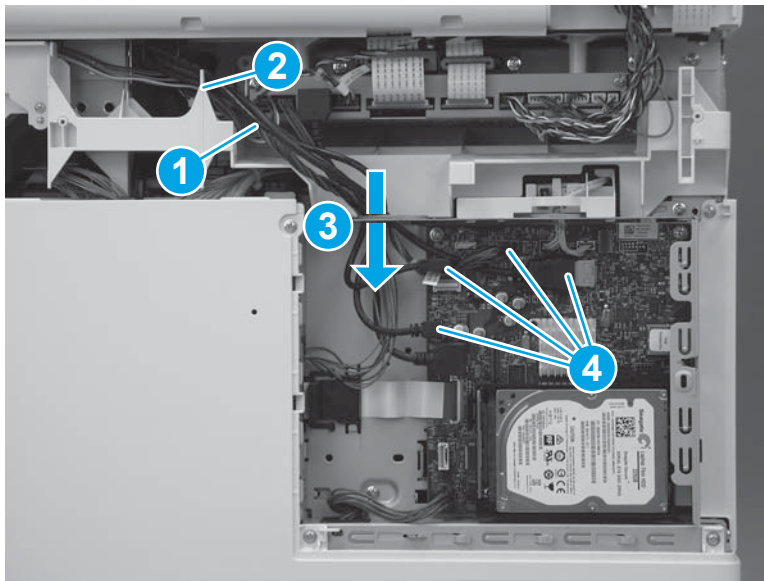

Step 34: Install the stapler cover assembly (M577c/f/z)

 **NOTE:** This step is for the M577c/f/z models only. For the M577dn model, skip this step and go to [Step 35: Install the right front upper cover \(M577dn\) on page 782](#).

For the M552 and M553 models, skip this step and go to [Step 38: Install the control panel \(M553n/dn and M552dn only\) on page 787](#).

1. Install the tabs (callout 1) on the cover in the slots (callout 2) in the printer.

Figure 1-1362 Install two tabs



2. Press the cover toward the left side of the printer until it snaps into place.

Figure 1-1363 Install the cover assembly



3. Install one screw (callout 1).



 **IMPORTANT:** This is a self-tapping screw for plastic. Rotate it counterclockwise to align it with the existing thread pattern, and then carefully turn it clockwise to tighten. Do not overtighten. This will prevent stripping the threads inside the screw hole.

Figure 1-1364 Install one screw

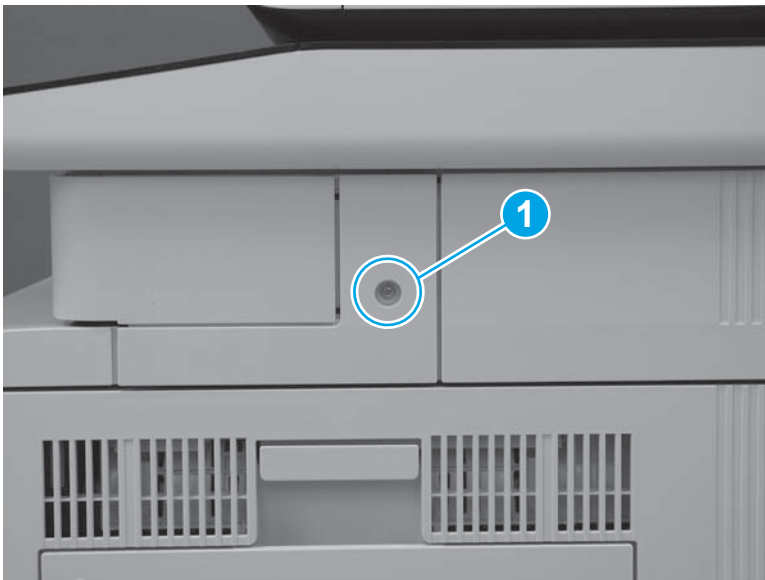

Step 35: Install the right front upper cover (M577dn)

 **NOTE:** This step is for the M577dn model only. For the M577c/f/z models, skip this step and go to [Step 36: Install the left upper cover \(M577\) on page 784](#).

For the M552 and M553 models, skip this step and go to [Step 38: Install the control panel \(M553n/dn and M552dn only\) on page 787](#).

1. Slide the cover toward the left side of the printer to install it. Make sure that the slots (callout 1) in the cover fit over the tabs (callout 2) on the inside of the paper feeder cover.

Figure 1-1365 Install the cover

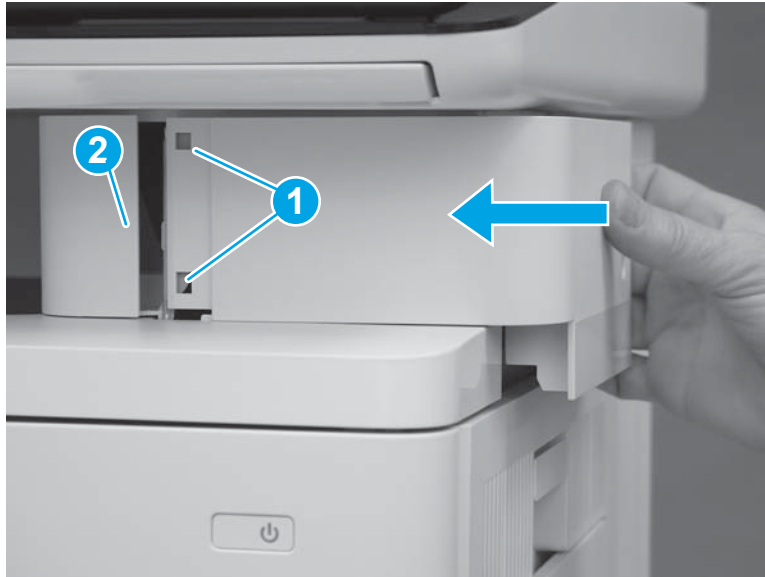

2. Press the right front upper cover (callout 1) and the paper feeder cover (callout 2) together until the tabs on the inside of the covers snap into place.

Figure 1-1366 Press the cover



3. Install one screw (callout 1).

Figure 1-1367 Install one screw

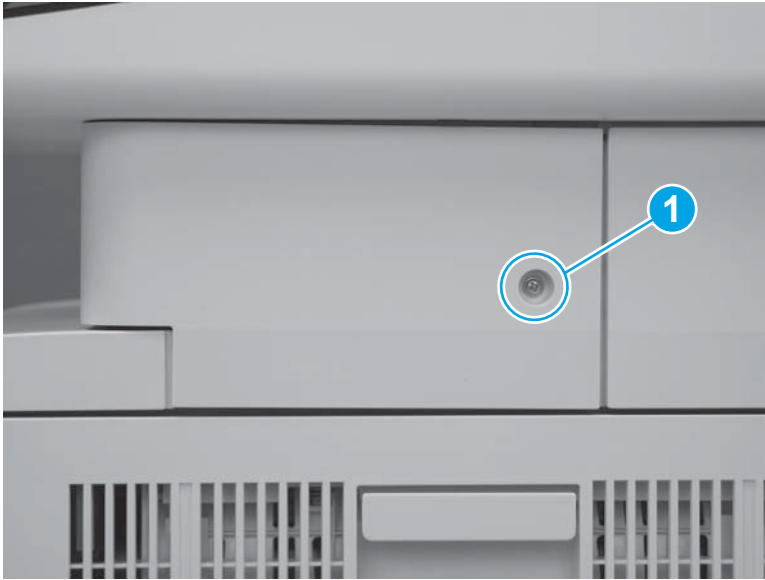

Step 36: Install the left upper cover (M577)



NOTE: This step is for the M577 models. For the M552 and M553 models, skip this step and go to [Step 38: Install the control panel \(M553n/dn and M552dn only\) on page 787.](#)

1. Position the tab (callout 1) on the lower edge of the cover behind the left cover (callout 2).

Figure 1-1368 Position the tab

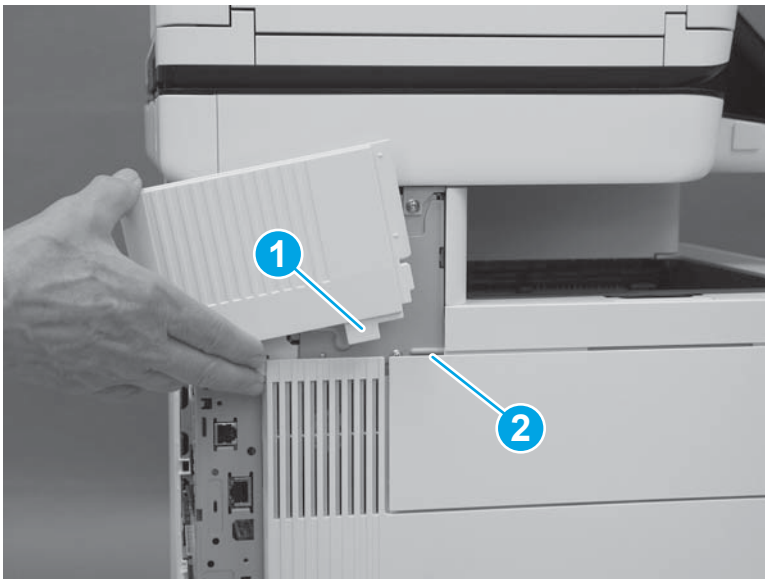

2. Slide the cover toward the front of the printer to install it. Make sure that the edge (callout 1) of the cover fits behind the edge (callout 2) of the top rear cover.

Figure 1-1369 Slide the cover

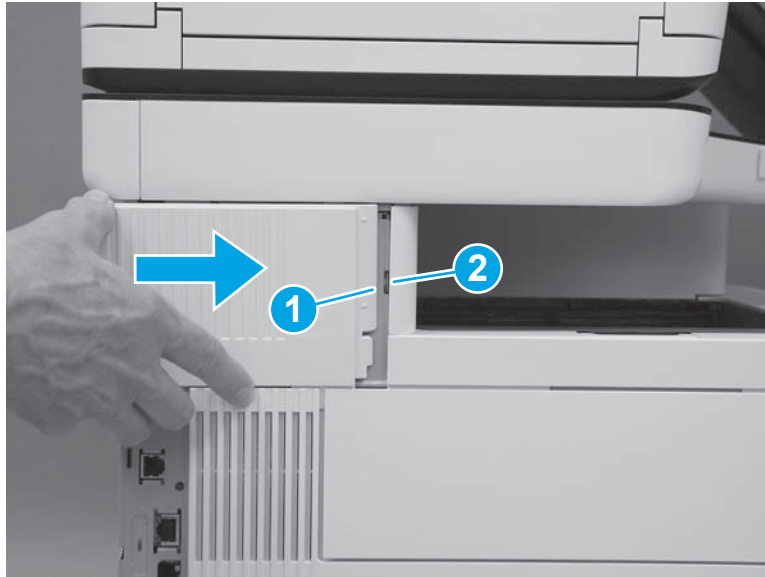

3. Make sure that the tab (callout 1) is fully installed.

Figure 1-1370 Check the tab

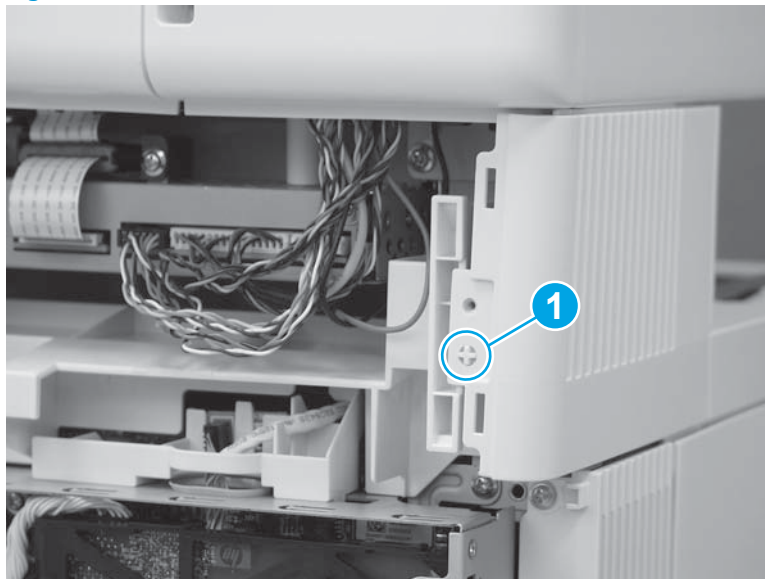

Step 37: Install the rear upper cover (M577)

 **NOTE:** This step is for the M577 models. For the M552 and M553 models, skip this step and go to [Step 38: Install the control panel \(M553n/dn and M552dn only\) on page 787.](#)

1. Align the ridge (callout 1) on the lower edge of the rear upper cover in front of the tabs (callout 2) on the top edge of the rear cover.

Figure 1-1371 Align the cover

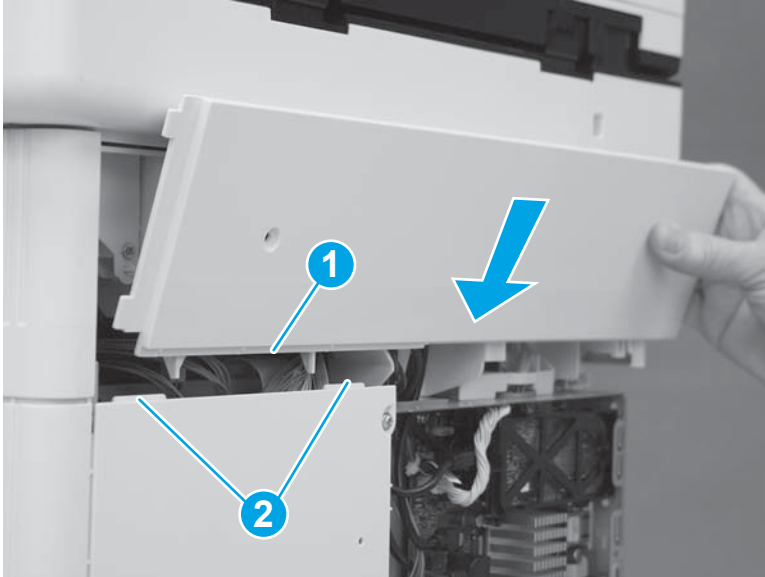

2. Rotate the top of the cover toward the printer.

Figure 1-1372 Rotate the top of the cover

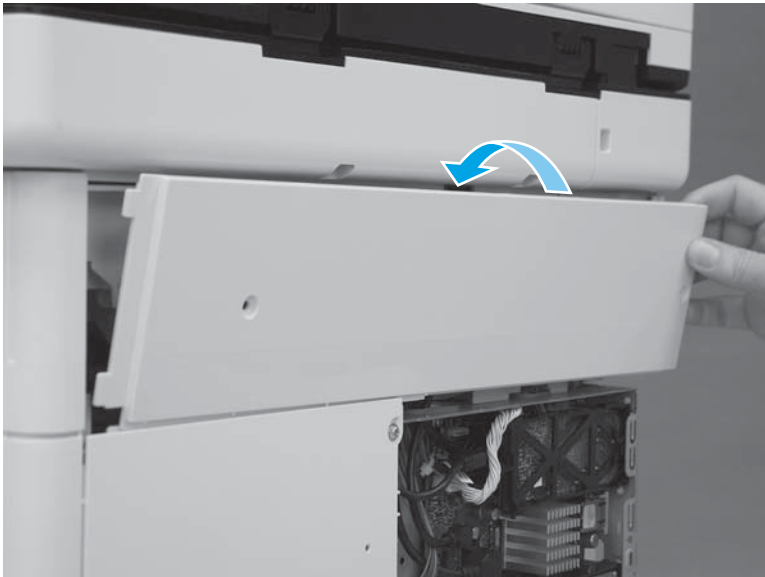

3. Slide the cover to the left (callout 1). Make sure that the tabs (callout 2) on the upper rear cover slide behind the edge (callout 3) of the right upper cover. Make sure that the cover is fully seated.

Figure 1-1373 Slide the cover

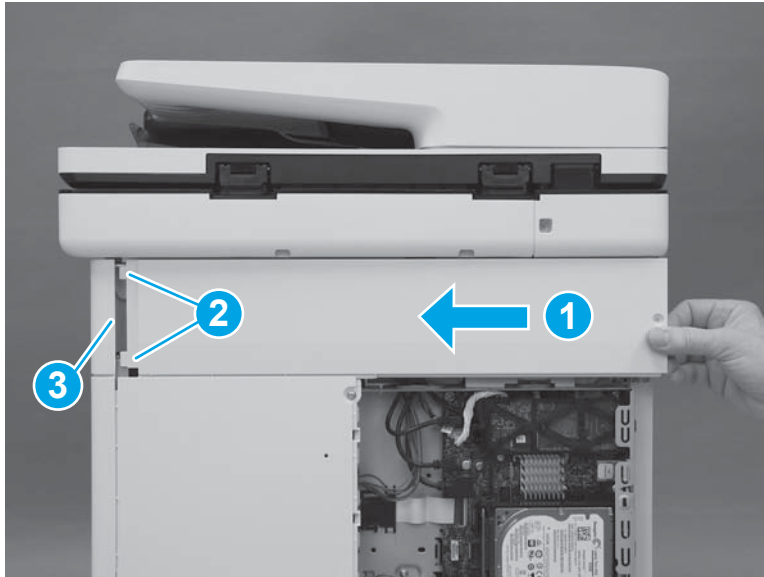

4. Install two screws (callout 1).



 **IMPORTANT:** These two screws are self-tapping screws for plastic. Rotate them counterclockwise to align them with the existing thread pattern, and then carefully turn them clockwise to tighten. Do not overtighten. This will prevent stripping the threads inside the screw holes.

Figure 1-1374 Install two screws

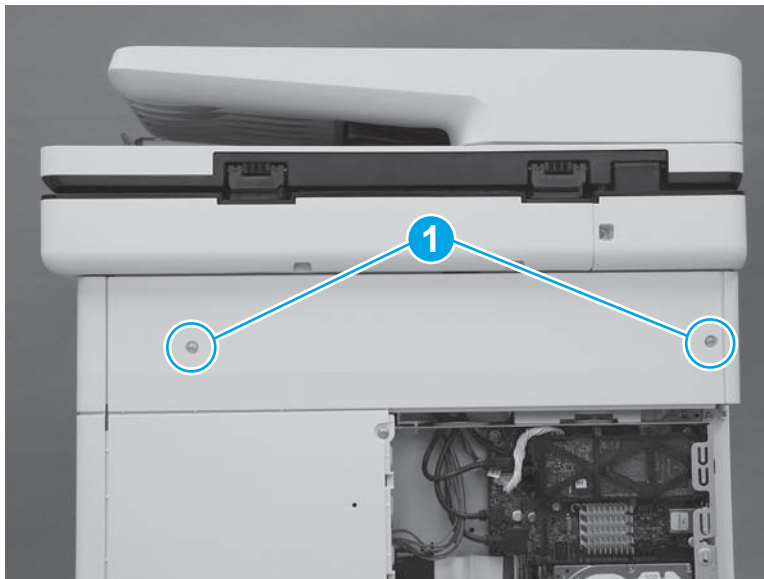

Step 38: Install the control panel (M553n/dn and M552dn only)

 **NOTE:** This step is for the M553n/dn and M552dn models. For the M553x model, skip this step and go to [Step 30: Install the upper cover \(M552 and M553\) on page 790](#).

1. Position the control panel on the printer, and then connect one connector (callout 1).

Figure 1-1375 Connect one connector

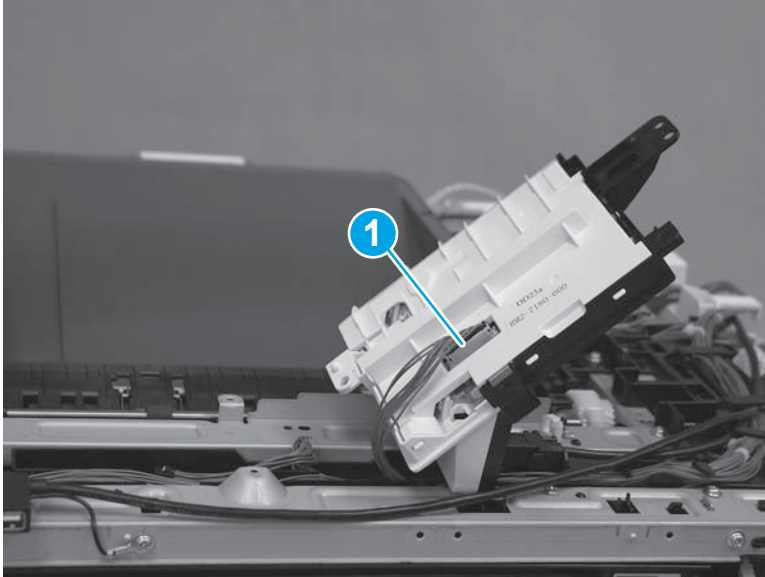

2. Turn the control panel over (callout 1), and then install four screws (callout 2).

Figure 1-1376 Install four screws

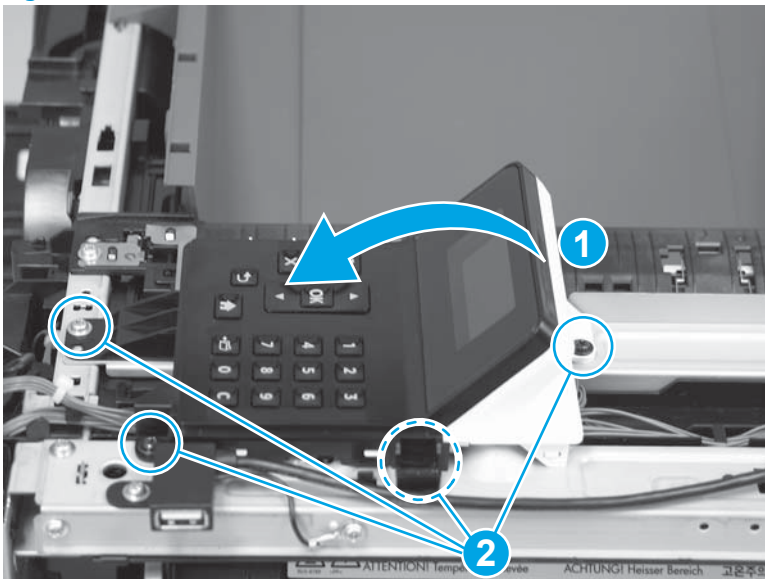

3. Place one cable in the guide.

Figure 1-1377 Place one cable in the guide



4. Install the tab on the NFC PCA holder (callout 1) in the slot (callout 2) in the chassis.

Figure 1-1378 Install the tab

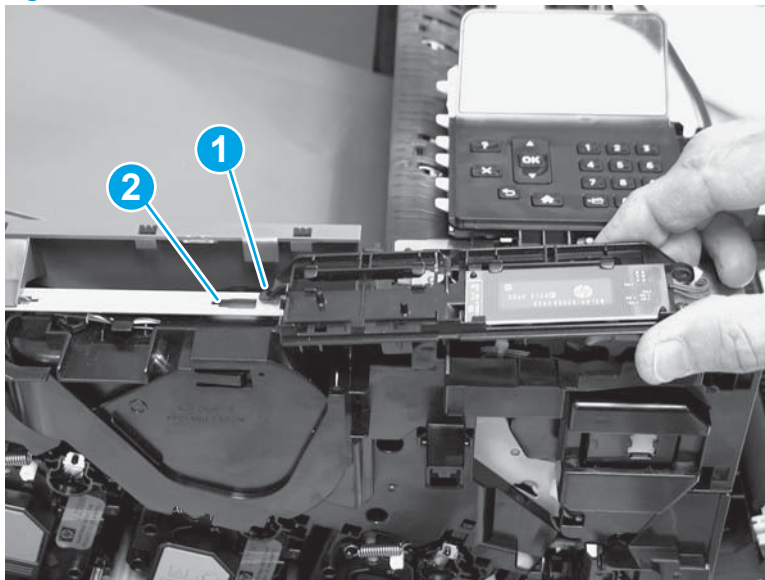

5. Rotate the NFC PCA holder down (callout 1) to install it, connect one connector (callout 2), and then install one screw (callout 3).

Figure 1-1379 Install one screw

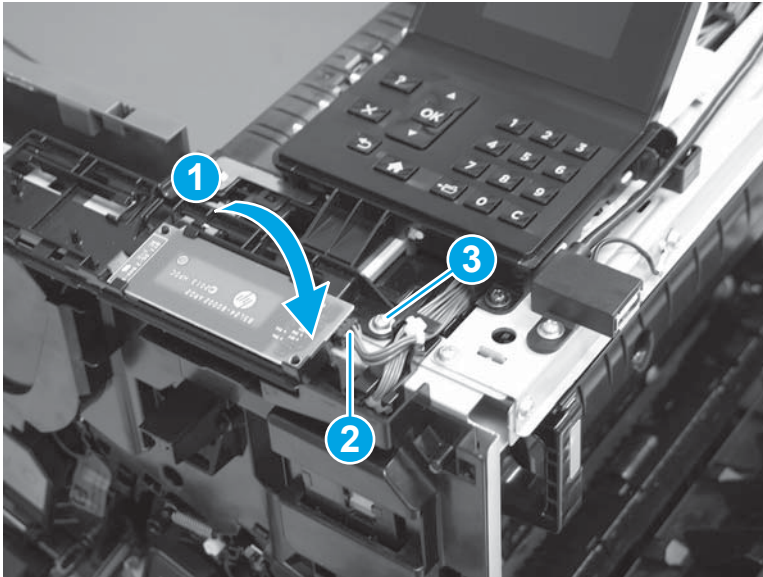

Step 30: Install the upper cover (M552 and M553)

 **NOTE:** This step is for the M552 and M553 models. For the M577 models, skip this step and go to [Step 46: Install the TCU on page 804](#).

1. Position the cover on the printer.

 **NOTE:** For the M553x model, do not forget to pass the control-panel wire harness and USB cable through the opening in the cover.

Figure 1-1380 Install the cover



2. Push down on the rear corner of the cover to engage one tab (callout 1).

Figure 1-1381 Engage one tab

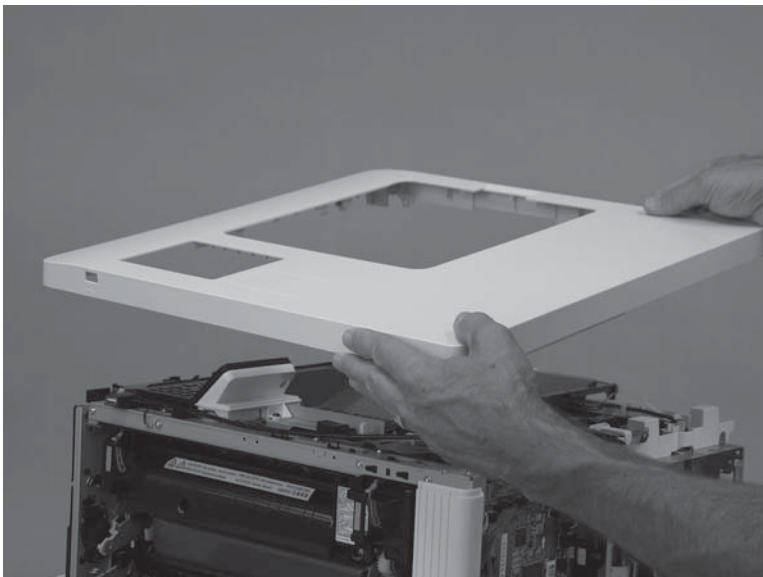
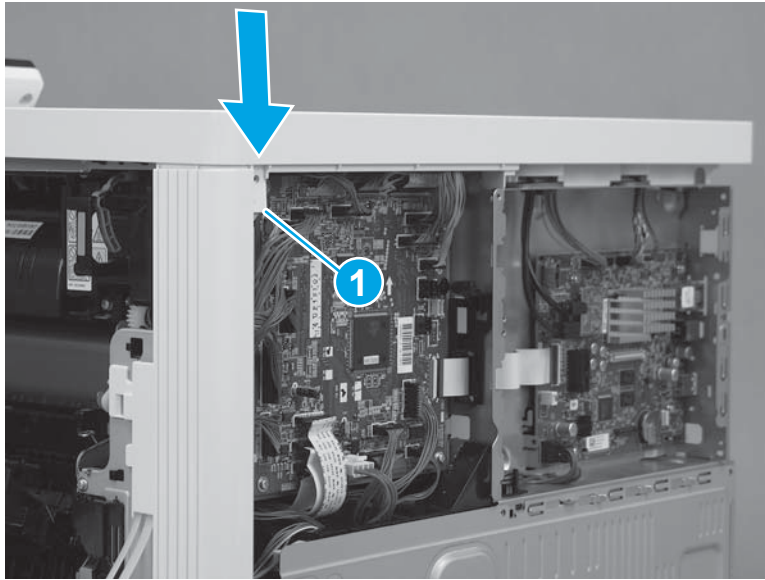

3. Push down on the front corner of the cover to engage one tab (callout 1), and then install one screw (callout 2).



NOTE: This is a self-tapping plastic-thread screw. Make sure that this screw is used in this location when it is reinstalled.

Figure 1-1382 Engage one tab and install one screw



4. Install three screws (callout 1).

Figure 1-1383 Install three screws

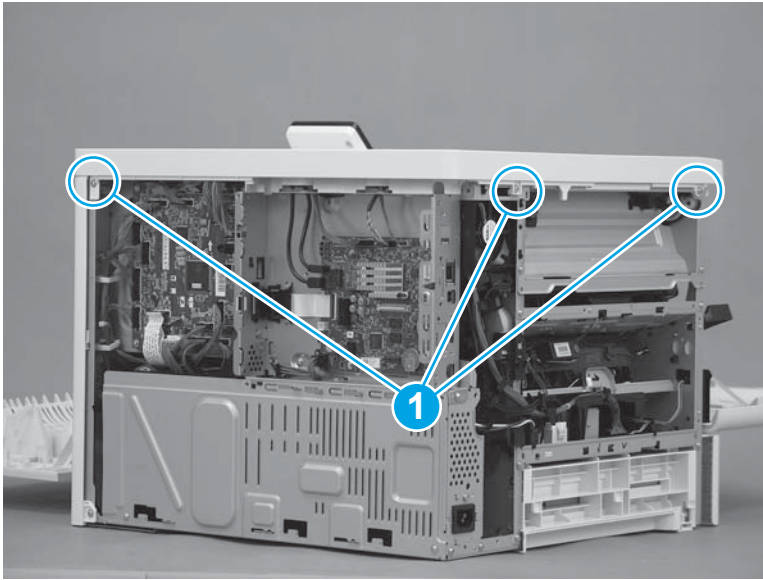

Step 40: Install the left cover



NOTE: This step is for the M552 and M553 models. For the M577 models, skip this step and go to [Step 46: Install the TCU on page 804](#).

1. Position the cover on the printer.



NOTE: Slightly offset the cover toward the rear of the printer.

Figure 1-1384 Install the cover

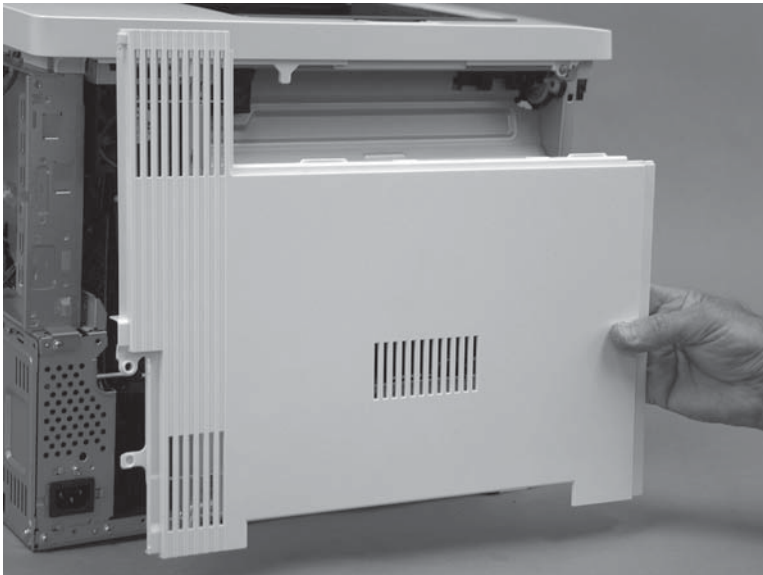

- Slide the cover (callout 1) toward the front of the printer to engage it. Make sure that the tab (callout 2) snaps into place.

 **NOTE:** Locate the alignment pin (callout 3) on the cover from the front door side of the printer, and then make sure that it is fully engaged in the slot in the chassis.

 **TIP:** While sliding the cover into place, push in on the center of the cover (callout 1) to make sure that the hooks on the back of the cover engage with the slots in the chassis.

Figure 1-1385 Engage the cover



- At the left side of the printer, install one screw (callout 1).

Figure 1-1386 Install one screw

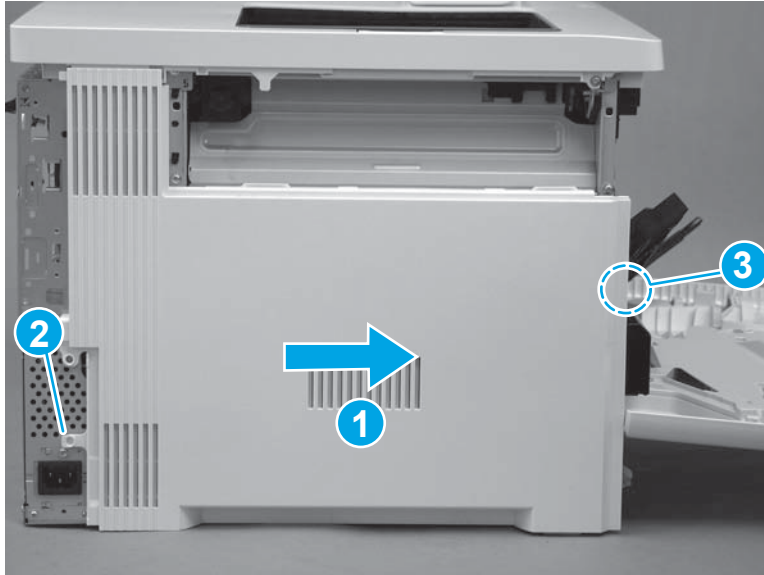

Step 41: Install the rear cover (M552 and M553)

 **NOTE:** This step is for the M552 and M553 models. For the M577 models, skip this step and go to [Step 46: Install the TCU on page 804.](#)

1. Position the top of the cover under the upper cover (callout 1), rotate the bottom of the cover onto the chassis (callout 2), and then slide the cover to the left (callout 3) to install it.

Figure 1-1387 Install the cover

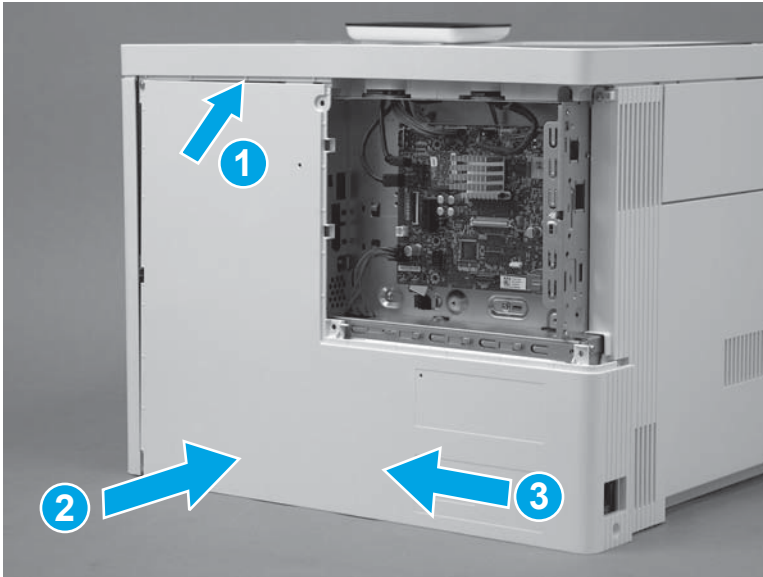

2. Install four screws (callout 1).

Figure 1-1388 Install four screws cover

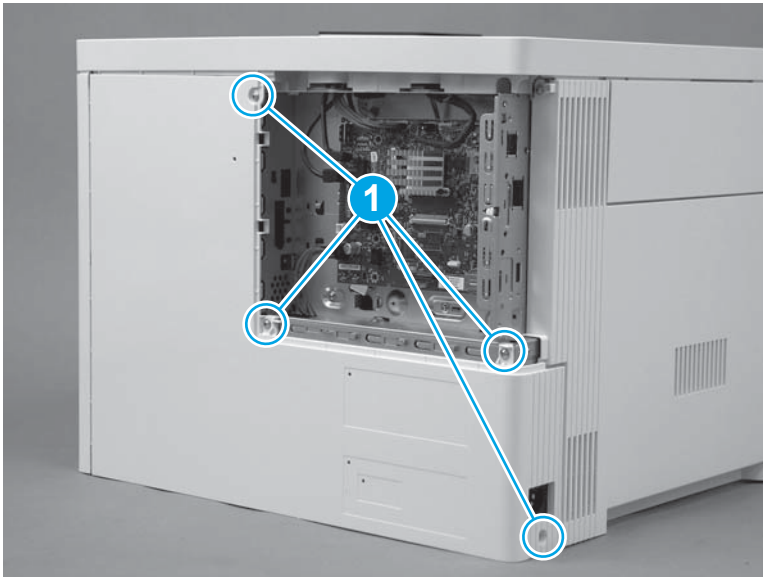

Step 42: Install the control-panel assembly (M553x only)

 **NOTE:** For the M553n/dn and M552dn models, skip this step and go to [Step 37: Install the USB cover \(M553\) on page 684](#).

For the M577 models, skip this step and go to [Step 46: Install the TCU on page 804](#).

1. Place the control panel on the printer as shown.

Figure 1-1389 Place the control panel on the product

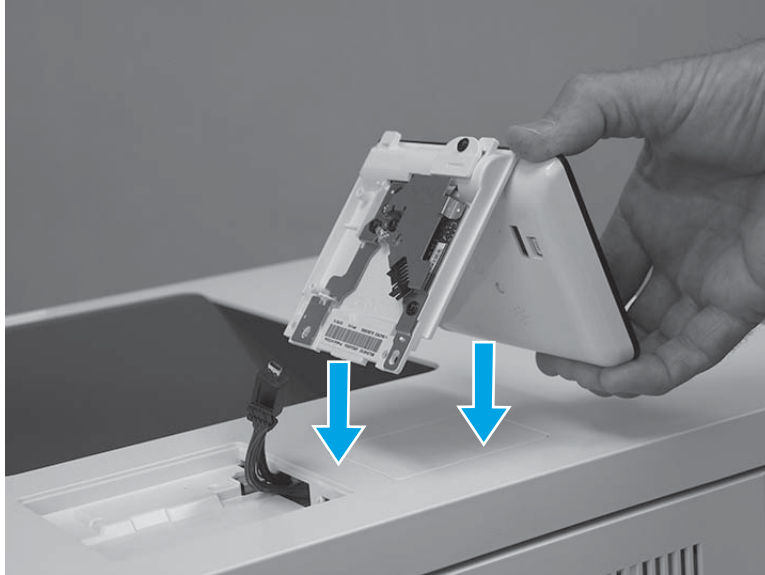

2. Connect one USB cable (callout 1), and one connector (callout 2).

 **IMPORTANT:** Take note of the location of the two mounting tabs (callout 3) on the control-panel assembly.

Figure 1-1390 Connect two connectors



3. Turn the control panel over, and then position the front edge tabs in the slots in the top cover.

Figure 1-1391 Turn the control panel over

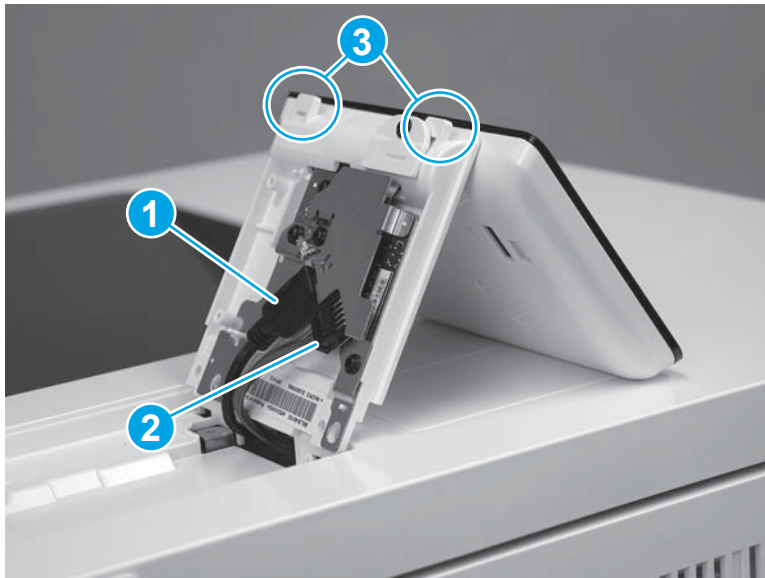
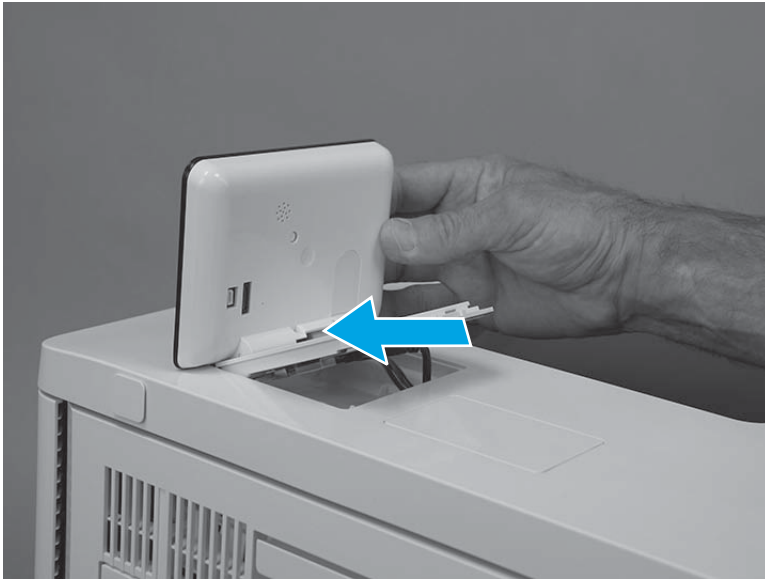

4. Rotate the control-panel base down onto the printer.

Figure 1-1392 Rotate the control-panel base down



5. Use a small Phillips screwdriver to install two screws (callout 1).

Figure 1-1393 Install two screws

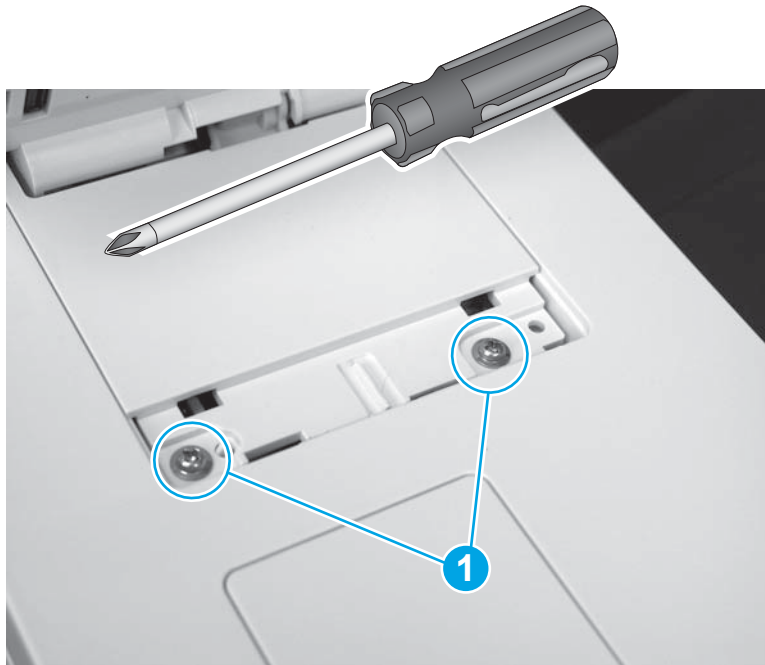

6. Position the screw cover mounting feet into the slots in the top cover (callout 1), and then rotate the cover down (callout 2) to install it.

 **NOTE:** Press down on the cover firmly to make sure that the tabs on the cover (callout 3) snap into place.

Figure 1-1394 Install the cover



Step 43: Install the ITB

CAUTION: Do not touch the grey-plastic belt. Skin oils and fingerprints on the belt can cause print-quality problems.

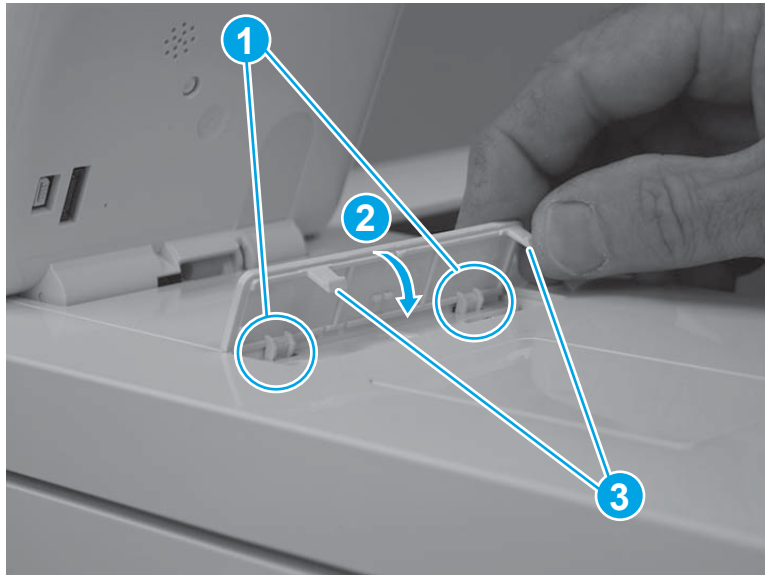
1. Handle the replacement ITB by the edges. Do not touch the grey-plastic belt. Skin oils and fingerprints on the belt can cause print-quality problems.

Figure 1-1395 Handle the ITB by the edges

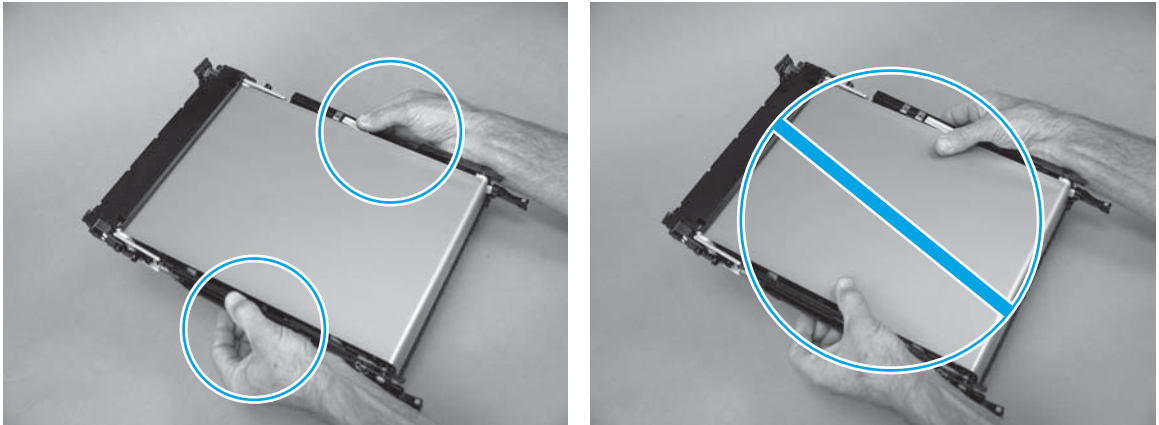

2. Align the ITB with the slots in the printer, and then carefully push it into the printer.

NOTE: Be careful. Do not dislodge the ITB retainer springs from the holders on the chassis. The springs can interfere with installing the ITB.

Figure 1-1396 Align the ITB with the slots in the product

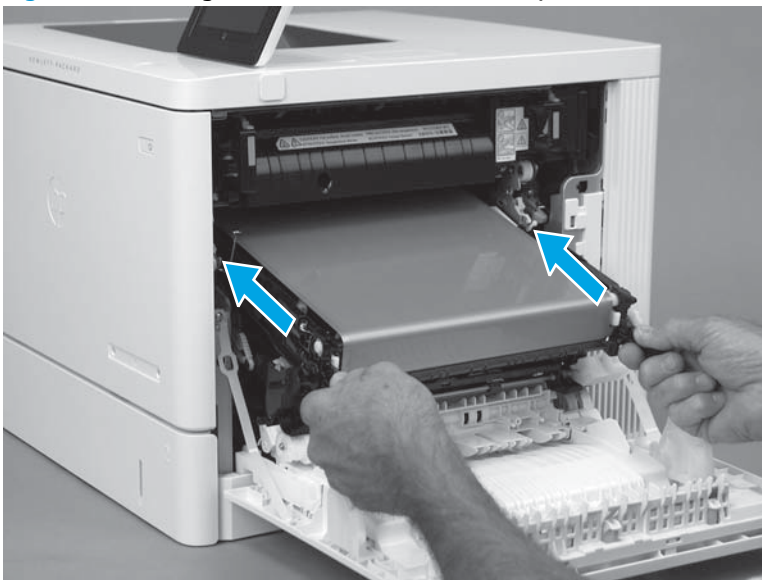

3. Continue to carefully push the ITB into the printer until it is fully installed.

Figure 1-1397 Install the ITB

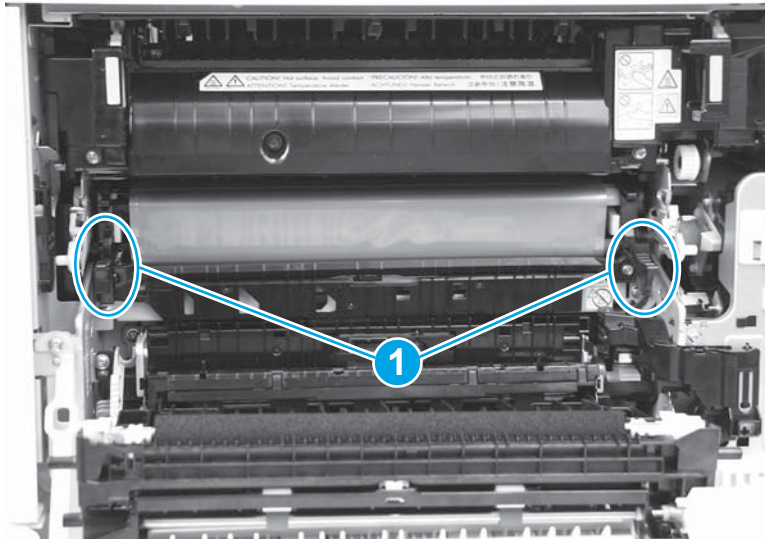

4. Remove the right-side ITB spring from the holder.

Figure 1-1398 Remove the spring from the holder



5. Fasten the right-side ITB spring (callout 1) under the tab (callout 2).

Figure 1-1399 Fasten the rear-side ITB spring

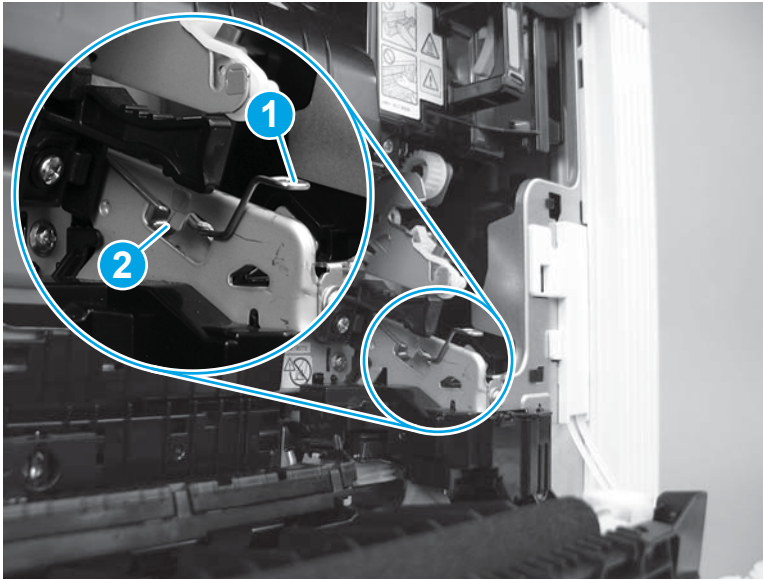

6. Remove the left-side ITB spring from the holder.

Figure 1-1400 Remove the spring from the holder

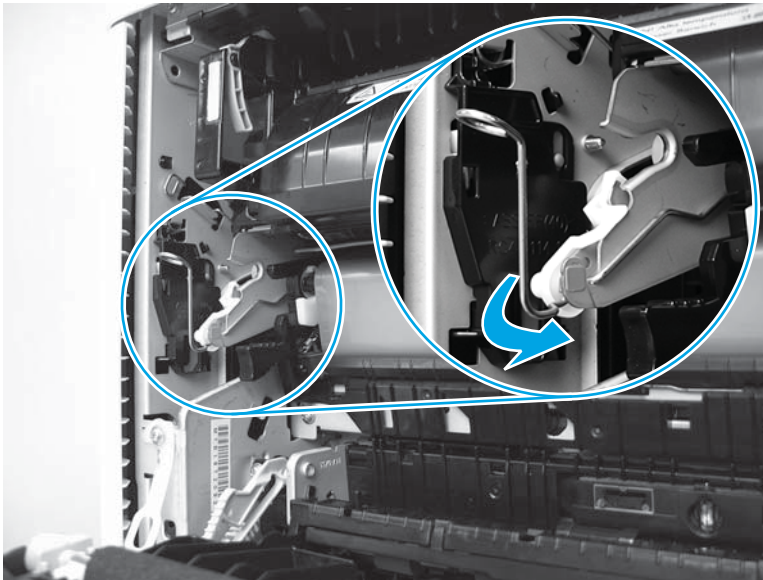

7. Fasten the left-side ITB spring (callout 1) under the tab (callout 2).

Figure 1-1401 Fasten the front-side ITB spring

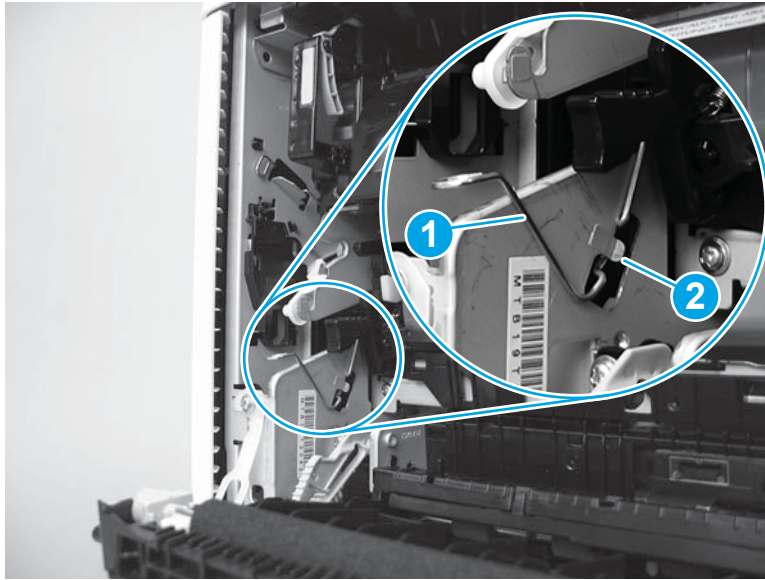

8. Push in the blue lever to engage the ITB drive coupling.

Figure 1-1402 Engage the ITB drive coupling

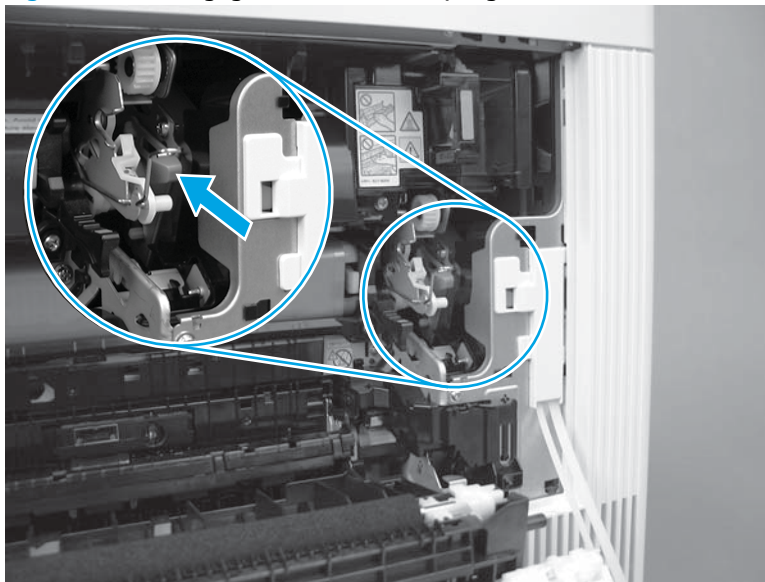

Step 44: Install the fuser

1. Align the fuser with the opening in the printer.

Figure 1-1403 Align the fuser with the opening

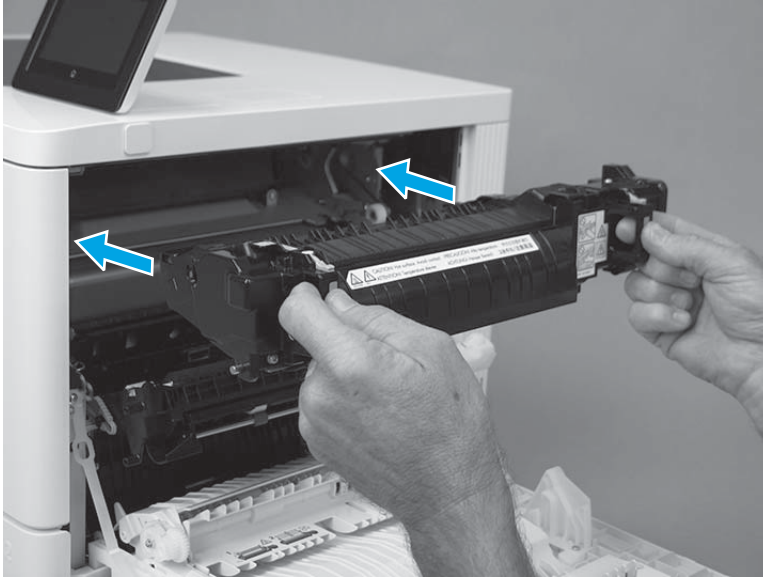

2. Slide the fuser into the printer, push in to install it, and then make sure that it is fully seated.

 **TIP:** When the fuser is fully seated, the two blue triggers on the handles make an audible click.

Figure 1-1404 Install the fuser

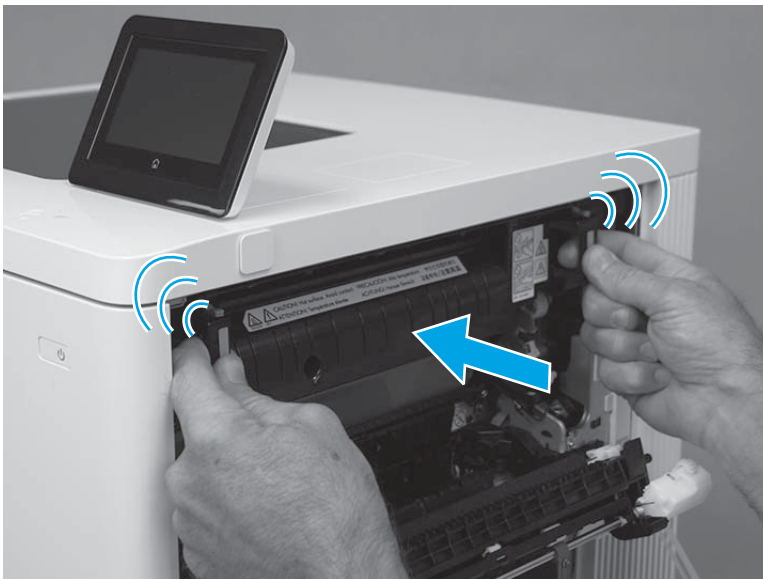

3. Close the right door.

Figure 1-1405 Close the right door



Step 45: Install the USB cover (M552 and M553)

 **NOTE:** This step is for the M552 and M553 models. For the M577 models, skip this step and go to [Step 46: Install the TCU on page 804](#).

1. Push the cover into the USB port to install it.

Figure 1-1406 Install the cover



2. Make sure that the USB cover is fully seated after installing it.

Figure 1-1407 Check the installation

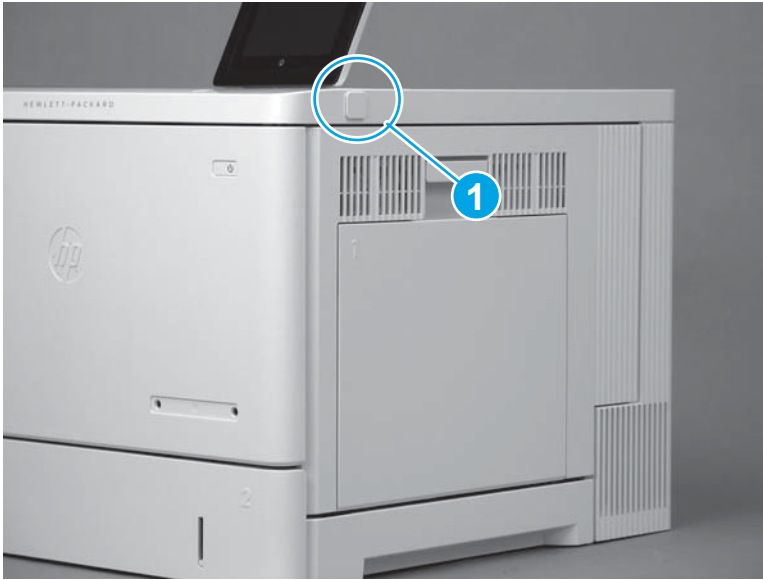

Step 46: Install the TCU

1. Verify that the toner collection hatch cover is in the closed position on the TCU.

Figure 1-1408 Verify that the toner collection hatch cover is closed

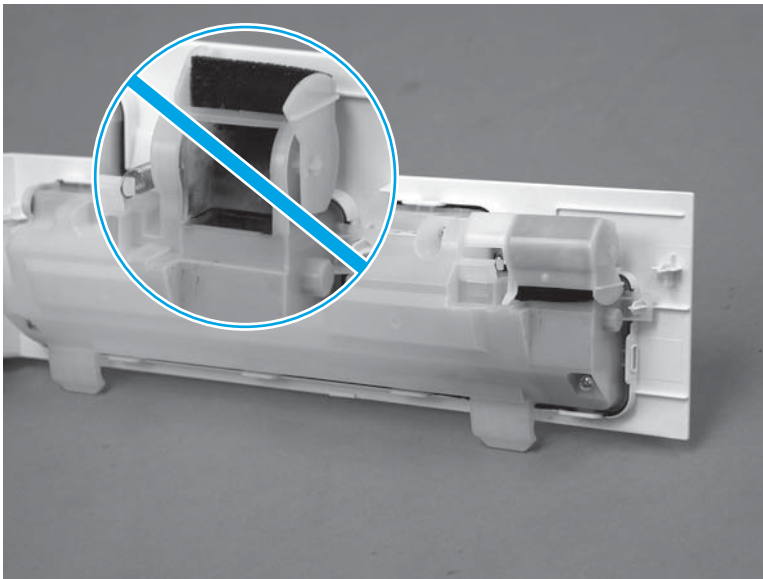

2. Position the TCU with the hinges in the slots provided in the printer (callout 1), and then rotate the TCU up and into the closed position.

 **NOTE:** The toner collection hatch cover automatically opens when the TCU is closed.

Figure 1-1409 Install the TCU



3. Close the front door.

Figure 1-1410 Close the front door

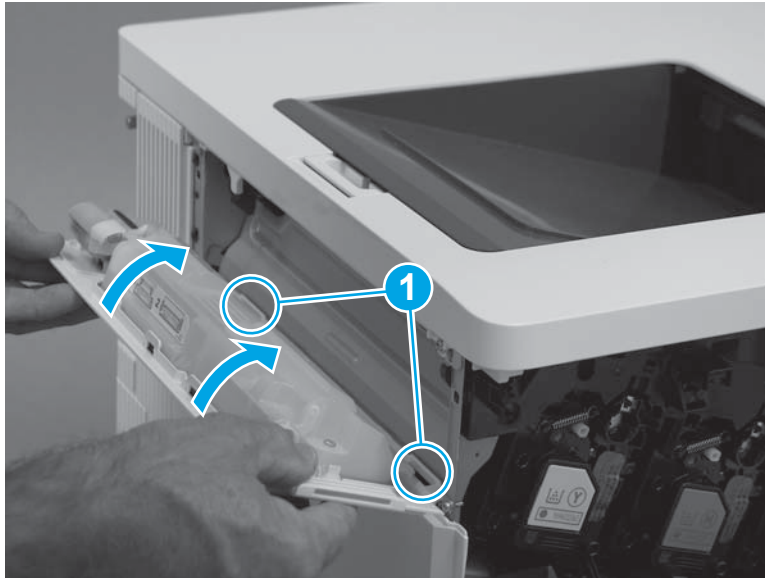

Step 47: Install the formatter cover

- ▲ Slide the cover onto the printer (callout 1) to install it.

 **NOTE:** Make sure that the tabs on the formatter cover align with the slots provided in the printer (callout 2). Tighten the two thumbscrews (callout 3).

 **TIP:** If needed, use the edge of a coin to turn the thumbscrews.

Figure 1-1411 Install the cover



Removal and replacement: Formatter (M552 and M553)

- [Introduction](#)
- [Step 1: Remove the formatter cover](#)
- [Step 2: Remove the hard-disk drive \(HDD\)](#)
- [Step 3: Remove the embedded MultiMedia Card \(eMMC\)](#)
- [Step 4: Remove the dual inline memory module \(DIMM\)](#)
- [Step 5: Remove the trusted platform module \(TPM\)](#)
- [Step 6: Remove the formatter](#)
- [Step 7: Unpack the replacement assembly](#)
- [Step 8: Install the formatter](#)
- [Step 9: Install the DIMM](#)
- [Step 10: Install the eMMC](#)
- [Step 11: Install the TPM](#)
- [Step 12: Install the HDD](#)
- [Step 13: Install the formatter cover](#)

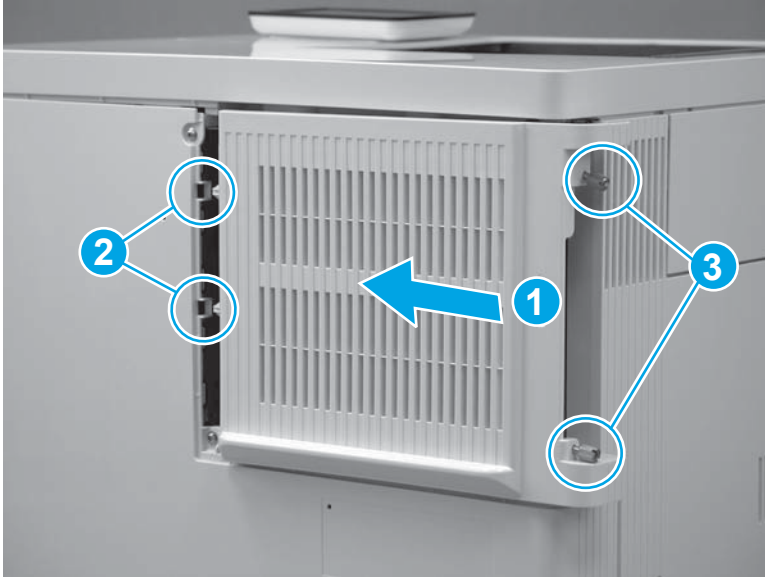
Introduction



This document provides the procedures to remove and replace the formatter.

Before performing service

Turn the printer power off

- Disconnect the power cable.

 **WARNING!** To avoid damage to the printer, turn the printer off, wait 30 seconds, and then remove the power cord before attempting to service the printer.

 **CAUTION:**  This part contains components that are electrostatic discharge (ESD) sensitive. To reduce the possibility of ESD damage, always touch the sheet-metal chassis to ground yourself before touching an ESD sensitive part.

 **IMPORTANT:** Do not replace the formatter, DC controller, and eMMC PCA or hard-disk drive simultaneously during a single printer servicing. Doing so might cause the printer to become unstable or inoperable.

Use the table below to identify the correct part number for your printer, and then go to <http://h20141.www2.hp.com/hpparts> to order the part.

Formatter kit number	
B5L23-67903	Formatter (M552)
B5L23-67904	Formatter (M552; India and China only)
B5L24-67909	Formatter (M553n, M553dn, M553dh)
B5L24-67908	Formatter (M553n, M553dn, M553dh; India and China only)
B5L26-67901	Formatter (M553x)
B5L26-67902	Formatter (M553x; India and China only)

Required tools

- #2 Phillips screwdriver with a magnetic tip

After performing service

Make sure that all of the connectors on the formatter are fully seated.

Make sure that the formatter cover is fully seated, and that the thumbscrews are finger tight after replacing it.

Turn the printer power on

- Connect the power cable.
- Use the power switch to turn the power on.

Post service test

Print a configuration page to make sure that the printer is functioning correctly.

Step 1: Remove the formatter cover

1. Locate the formatter cover.

Figure 1-1412 Locate the formatter cover

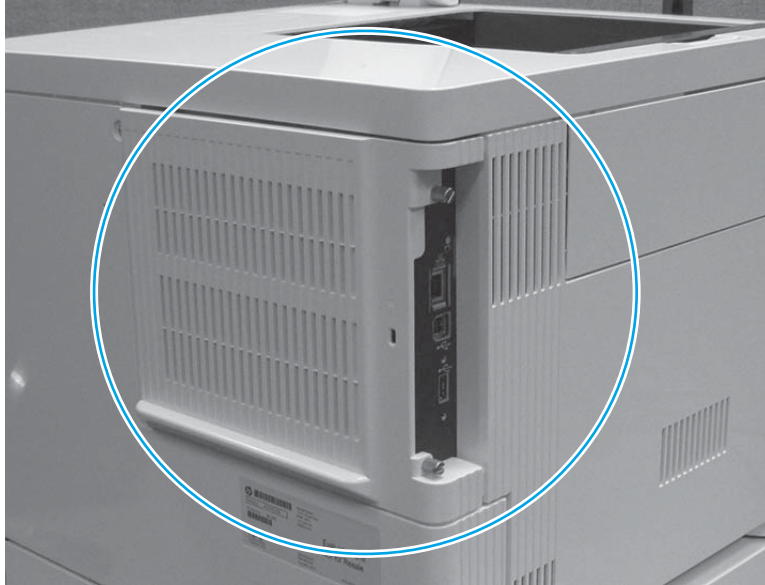

2. Loosen the two thumbscrews (callout 1). Grasp the two thumbscrews, and then slide the cover away from the printer (callout 2) to remove it.



 **TIP:** If needed, use the edge of a coin to turn the thumbscrews.

Figure 1-1413 Loosen the thumbscrews

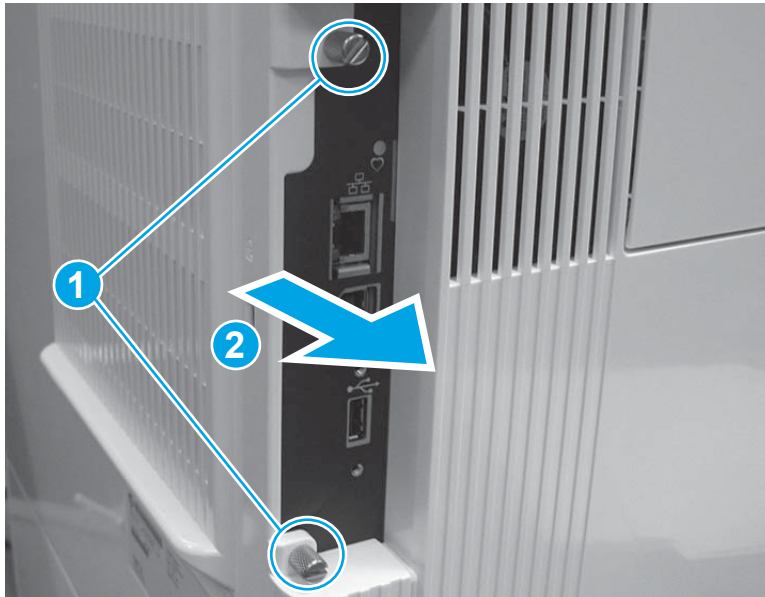

Step 2: Remove the hard-disk drive (HDD)

 **NOTE:** If the optional HDD is not installed, skip this step and go to [Step 3: Remove the embedded MultiMedia Card \(eMMC\) on page 810](#).

 **CAUTION:**  ESD-sensitive part.

1. Release one tab (callout 1), grasp the HDD mounting bracket, and then rotate the connector end of the bracket up (callout 2) and away from the formatter to release it.

Figure 1-1414 Release the HDD

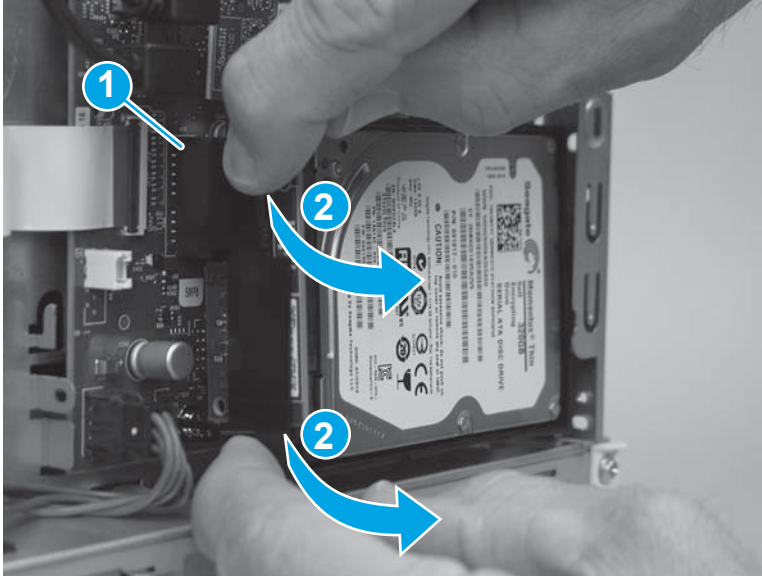

2. Slide the HDD away from the printer to remove it.

Figure 1-1415 Remove the HDD

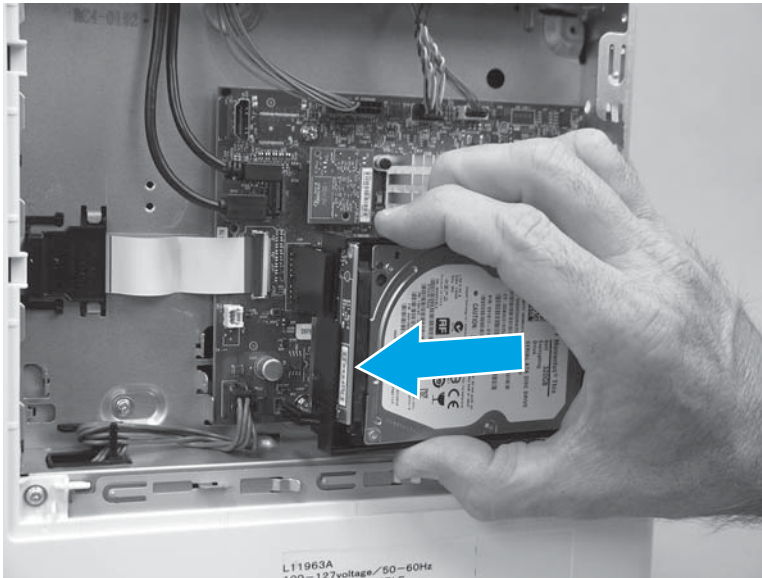

Step 3: Remove the embedded MultiMedia Card (eMMC)

 **NOTE:** If the formatter is being removed to gain access to other assemblies, skip this step and go to [Step 6: Remove the formatter on page 813](#).

CAUTION:  ESD-sensitive part.

- ▲ Locate the eMMC component on the formatter, and then pull it straight off of the formatter to remove it.

Figure 1-1416 Remove the eMMC

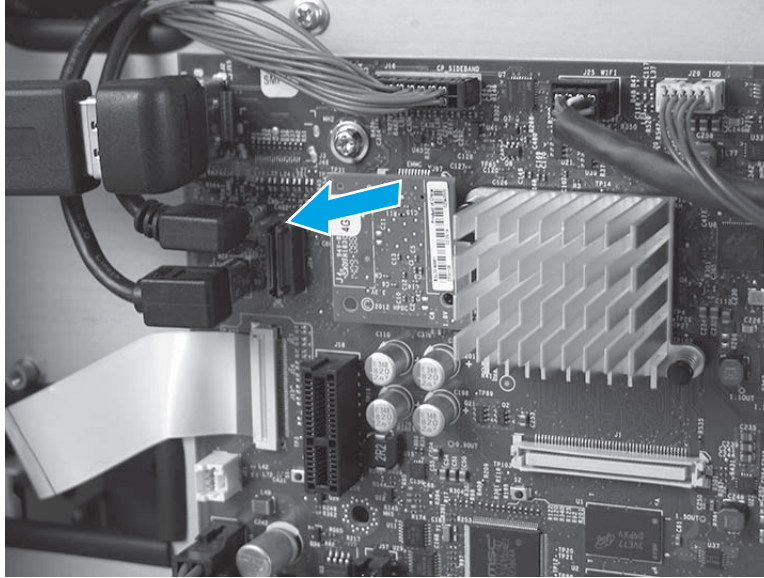

Step 4: Remove the dual inline memory module (DIMM)

 **NOTE:** If the formatter is being removed to gain access to other assemblies (or the optional DIMM is not installed), skip this step and go to [Step 6: Remove the formatter on page 813](#).

CAUTION:  ESD-sensitive part.

1. Locate the DIMM component on the formatter.

Figure 1-1417 Locate the DIMM

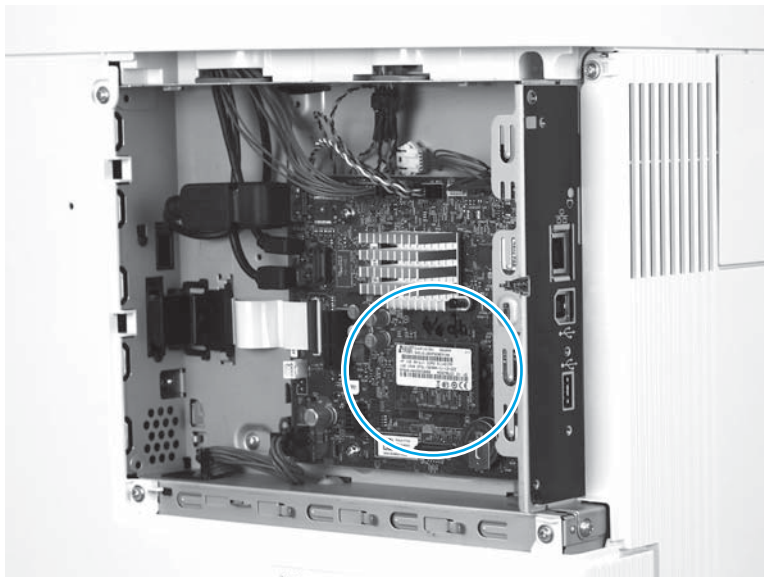

2. Pull the DIMM straight off of the formatter to remove it.

Figure 1-1418 Remove the DIMM

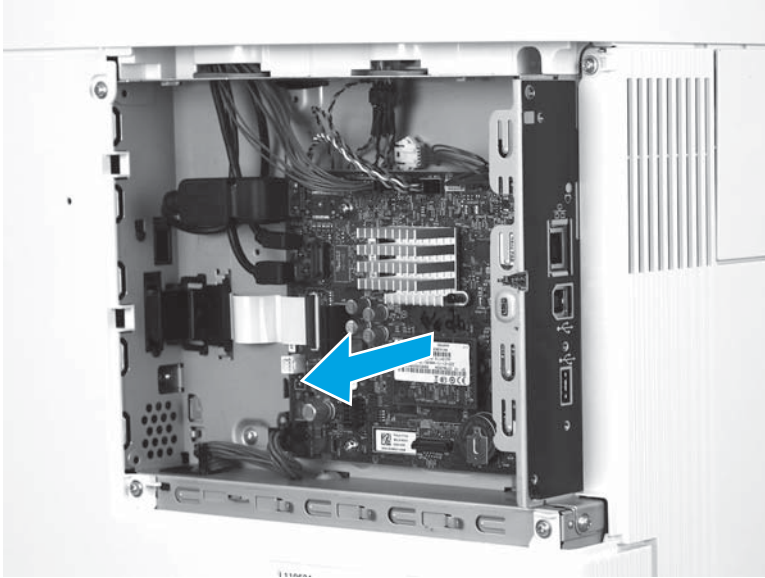

Step 5: Remove the trusted platform module (TPM)



NOTE: If the formatter is being removed to gain access to other assemblies (or the optional TPM is not installed), skip this step and go to [Step 6: Remove the formatter on page 813](#).



CAUTION:  ESD-sensitive part.

1. Locate the TPM component on the formatter.

Figure 1-1419 Locate the TPM

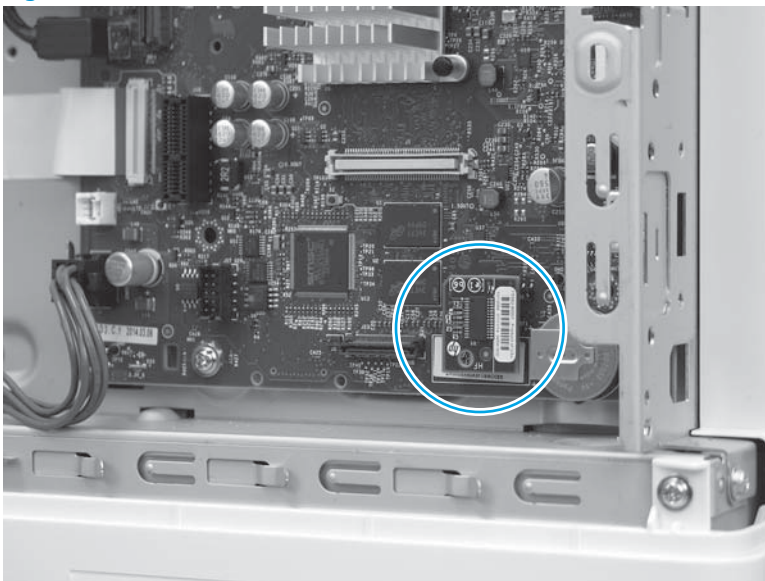

2. Pull the TPM straight off of the formatter to remove it.

Figure 1-1420 Remove the TPM

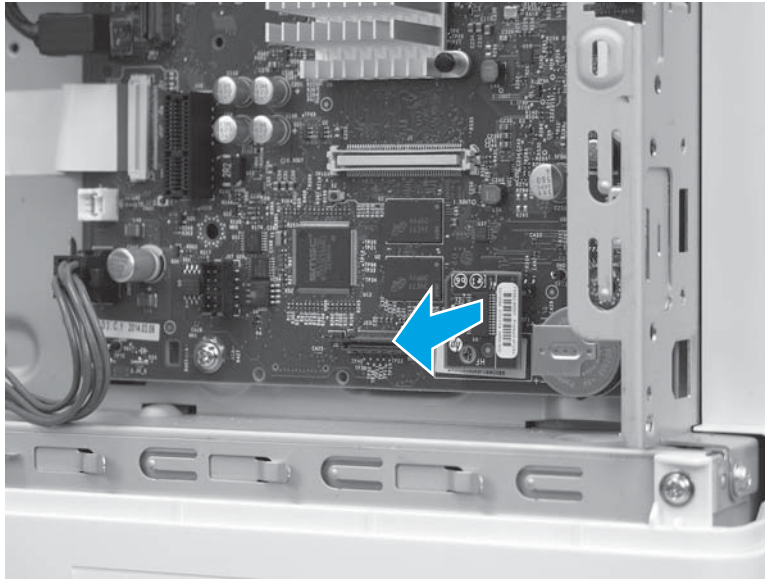

Step 6: Remove the formatter

CAUTION:  ESD-sensitive part.

1. Disconnect all of the connectors on the formatter.

The following connectors are empty:

- All models: J1 (this connector is empty unless the optional DIMM is installed)
- M553n/dn and M552dn: J2 (callout 1; this is the touchscreen connector for the M553x model)
- All models: J9 (this connector is empty unless the optional internal USB ports component is installed)
- All models: J18 (this connector is empty unless the optional hard-disk-drive (HDD) is installed)
- All models: J23
- All models: J24
- M553n/dn and M552dn: J25 (this is the wireless connector for the M553x model)
- All models: J57
- All models: J98 (this connector is empty unless the optional trusted platform module (TPM) is installed)

IMPORTANT:  The flat-cable connector (callout 2) is a Zero Insertion Force (ZIF) connector that uses a hinged retainer to secure the flat cable. The hinged retainer must be opened to release the flat cable.

Figure 1-1421 Disconnect all connectors



2. Remove four screws (callout 1), and then remove the formatter.

Figure 1-1422 Remove the formatter

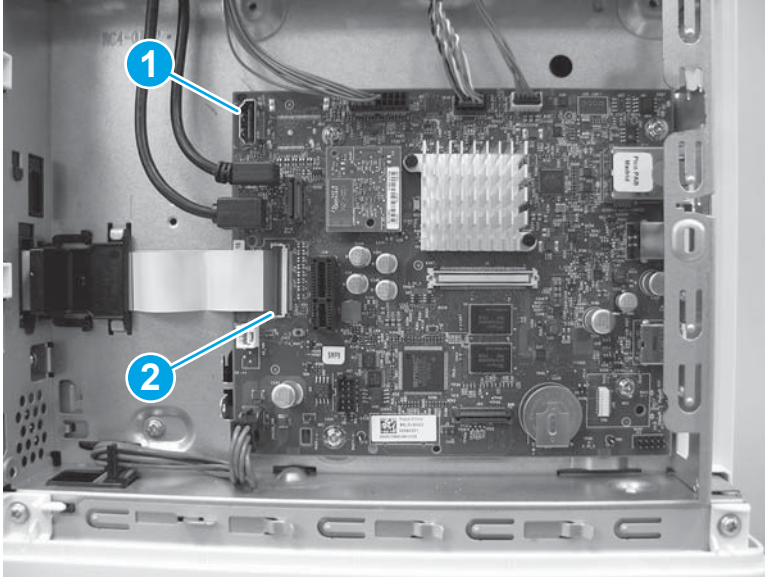
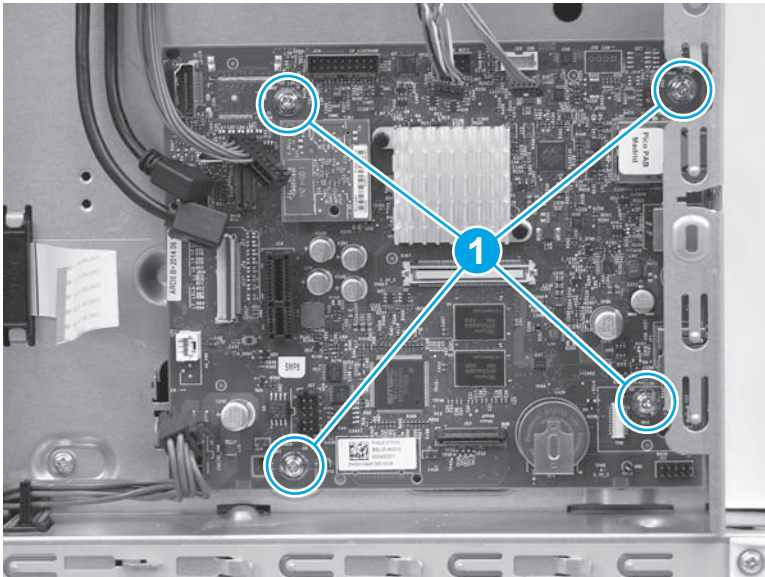

Step 7: Unpack the replacement assembly

Unpack the replacement assembly from the packaging.

CAUTION:  ESD-sensitive part.

For complete information on HP's recycling programs, go to [Product return and recycling](#).

NOTE:  HP recommends responsible disposal of the defective assembly.

Figure 1-1423 Recycle and unpack

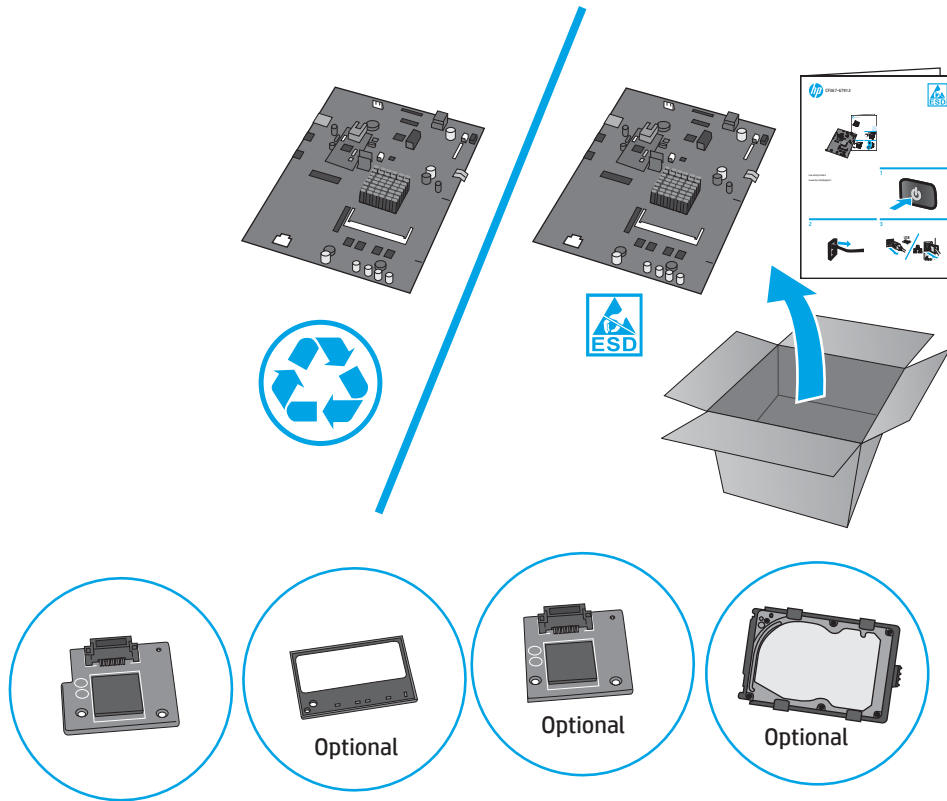

Step 8: Install the formatter

CAUTION:  ESD-sensitive part.

1. Position the formatter in the printer, and then install four screws (callout 1).

Figure 1-1424 Install the formatter

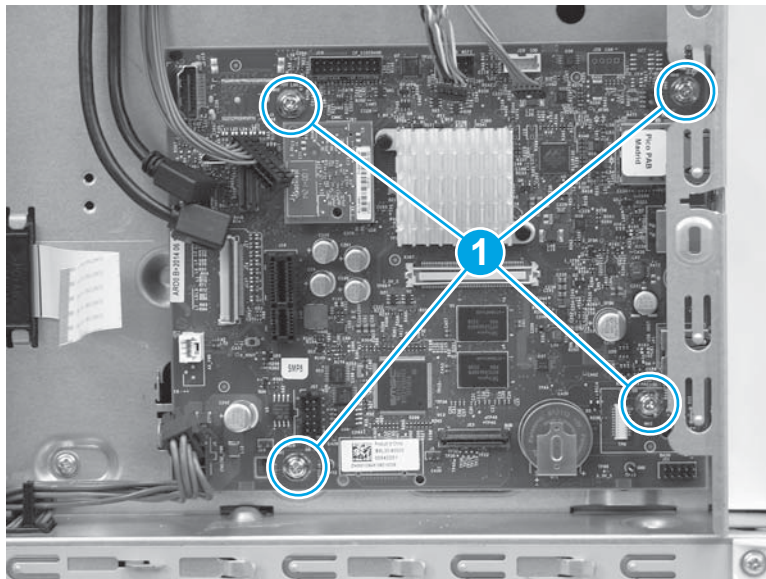

2. Connect all of the connectors on the formatter.

The following connectors are empty:

- All models: J1 (this connector is empty unless the optional DIMM is installed)
- M553n/dn and M552dn: J2 (callout 1; this is the touchscreen connector for the M553x model)
- All models: J9 (this connector is empty unless the optional internal USB ports component is installed)
- All models: J18 (this connector is empty unless the optional hard-disk-drive (HDD) is installed)
- All models: J23
- All models: J24
- M553n/dn and M552dn: J25 (this is the wireless connector for the M553x model)
- All models: J57
- All models: J98 (this connector is empty unless the optional trusted platform module (TPM) is installed)

 **IMPORTANT:** The flat-cable connector (callout 2) is a Zero Insertion Force (ZIF) connector that uses a hinged retainer to secure the flat cable. The hinged retainer must be opened to install the flat cable.

Figure 1-1425 Connect all connectors



Step 9: Install the DIMM

 **NOTE:** If the formatter was removed to gain access to other assemblies (or the optional DIMM is not installed), skip this step and go to [Step 10: Install the eMMC on page 818](#).

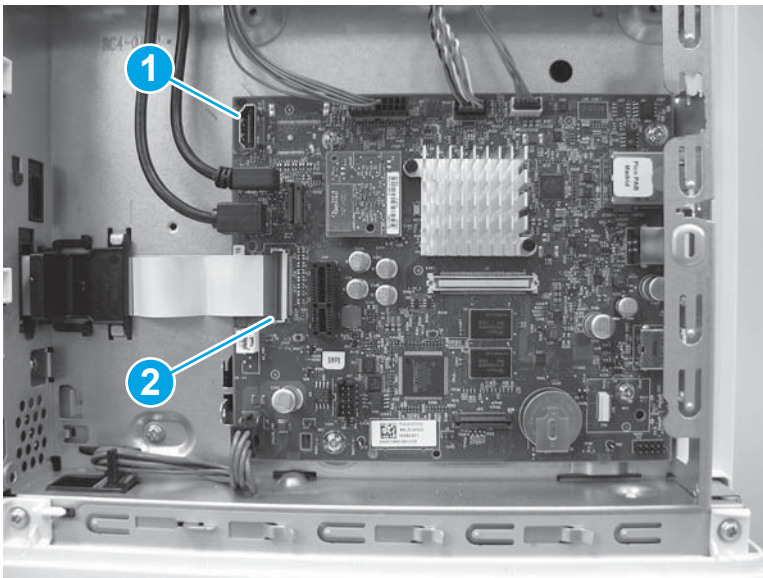
 **CAUTION:**  ESD-sensitive part.

1. The DIMM connector (callout 1) is keyed, and can only be installed in one direction in the formatter connector (callout 2).

Figure 1-1426 The DIMM connector

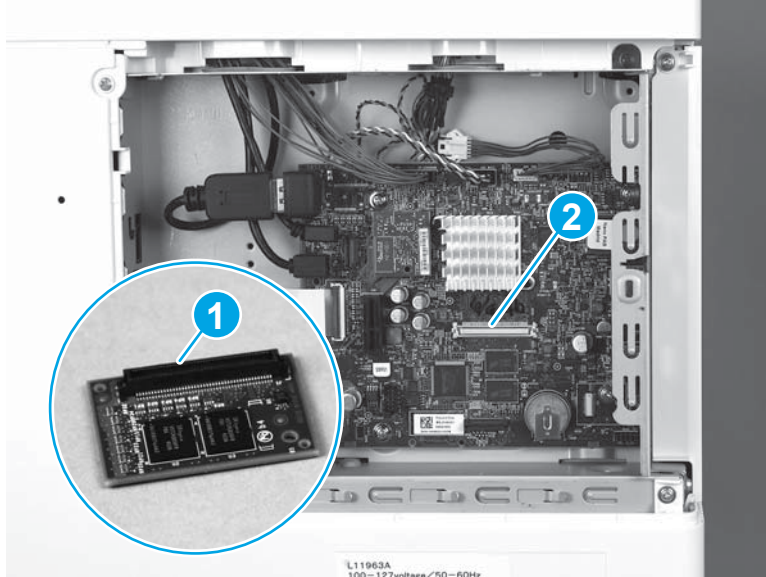

2. Align the connector on the DIMM with the connector on the formatter, and then push the DIMM onto the formatter to install it.

Figure 1-1427 Install the DIMM

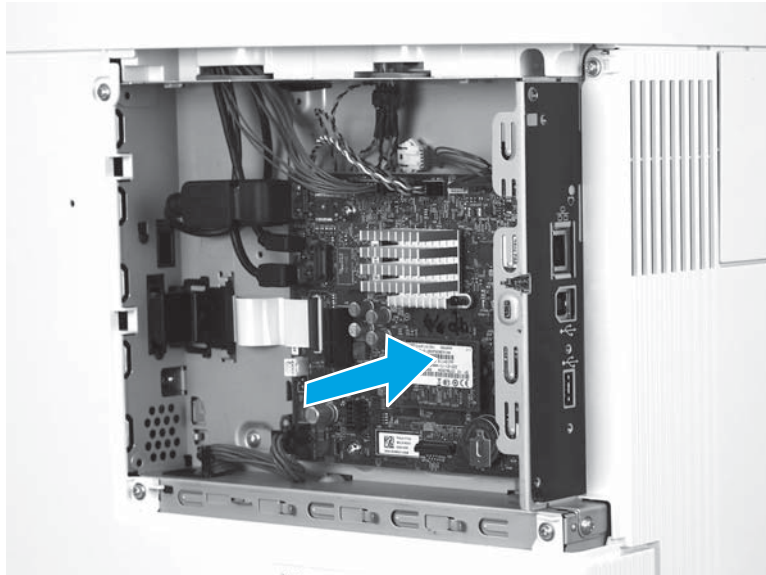

3. Verify that the DIMM is fully seated in the connector.

Figure 1-1428 Verify the installation

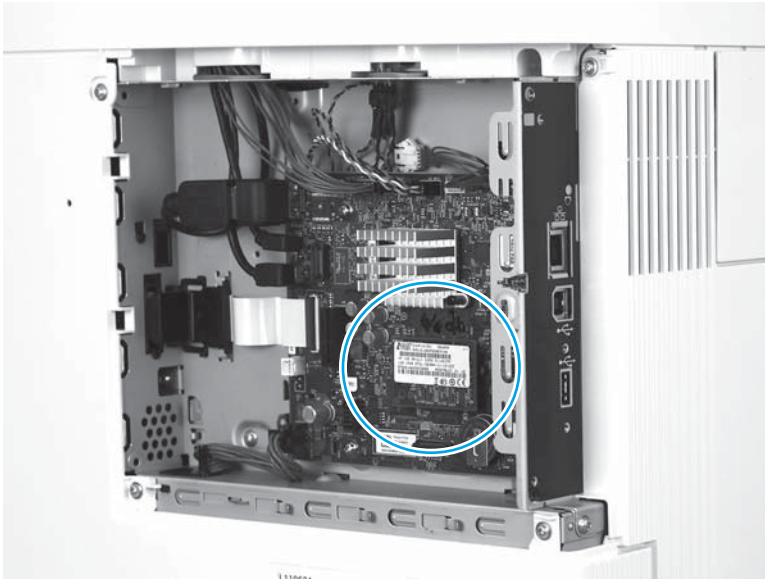

Step 10: Install the eMMC



NOTE: If the formatter was removed to gain access to other assemblies, skip this step and go to [Step 12: Install the HDD on page 820](#).



CAUTION:  ESD-sensitive part.

1. Align the connector on the replacement eMMC (callout 1) with the connector on the formatter (callout 2), and then push the eMMC onto the formatter to install it.



NOTE: The eMMC can only be installed in one direction on the formatter.

Figure 1-1429 Install the eMMC

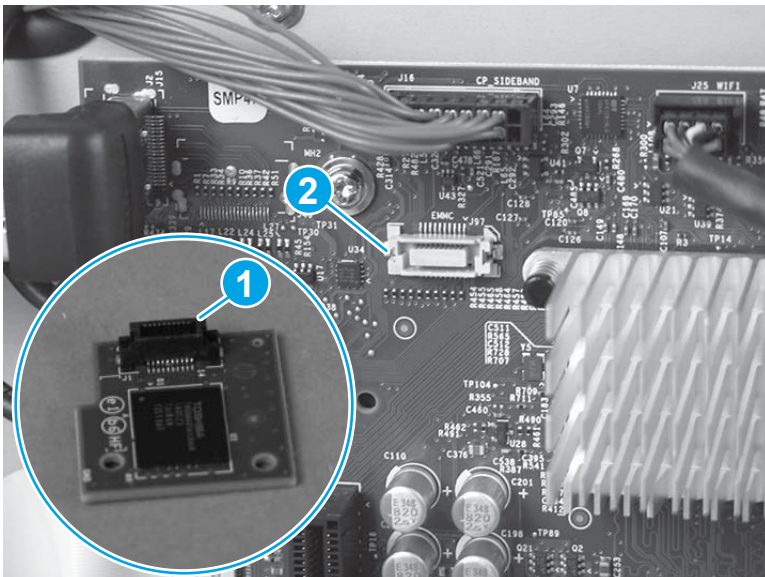

2. Push down on the eMMC to make sure that it is fully seated in the connector.

Figure 1-1430 Verify the installation

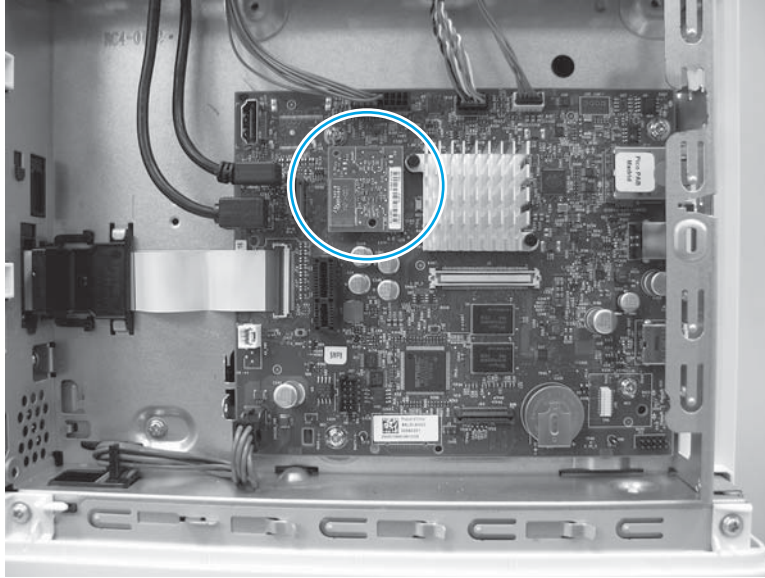

Step 11: Install the TPM

 **NOTE:** If the formatter was removed to gain access to other assemblies (or the optional TPM is not installed), skip this step and go to [Step 12: Install the HDD on page 820](#).

 **CAUTION:**  ESD-sensitive part.

1. Align the connector on the TPM (callout 1) with the connector on the formatter (callout 2), and then push the TPM onto the formatter to install it.

 **NOTE:** The TPM can only be install in one direction on the formatter.

Figure 1-1431 Install the TPM

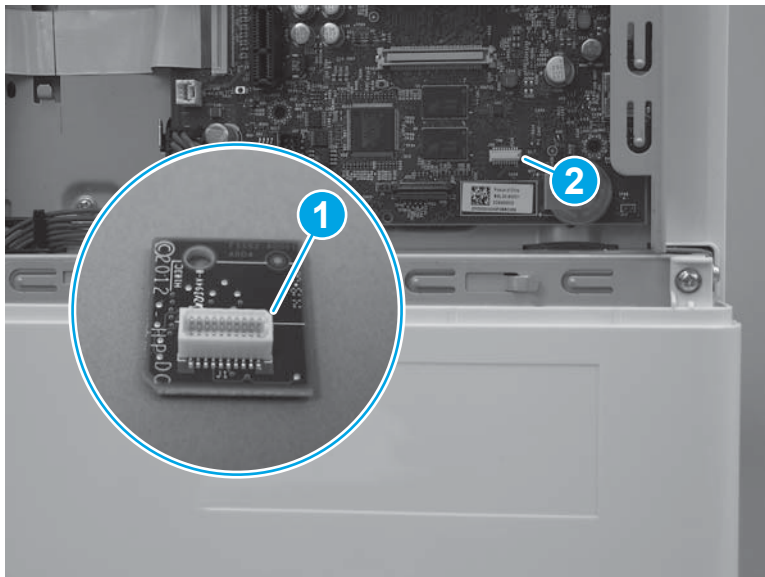

2. Verify that the TPM is fully seated in the connector.

Figure 1-1432 Verify that the TPM is fully seated

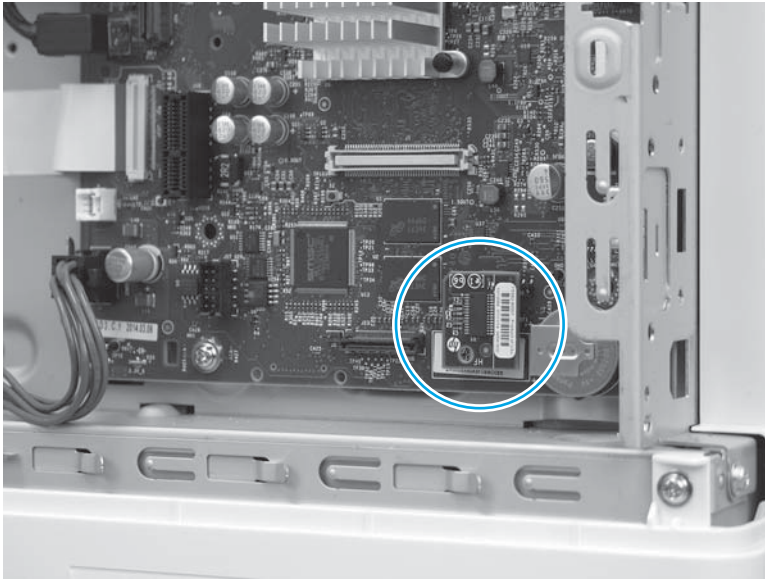

Step 12: Install the HDD



NOTE: If the optional HDD is not installed, skip this step and go to [Step 13: Install the formatter cover on page 821](#).



CAUTION:  ESD-sensitive part.

1. Align the end of the holder (callout 1) with the slot in the chassis (callout 2), and then slide the HDD into the printer (callout 3) to engage the holder with the chassis.

Figure 1-1433 Install the holder

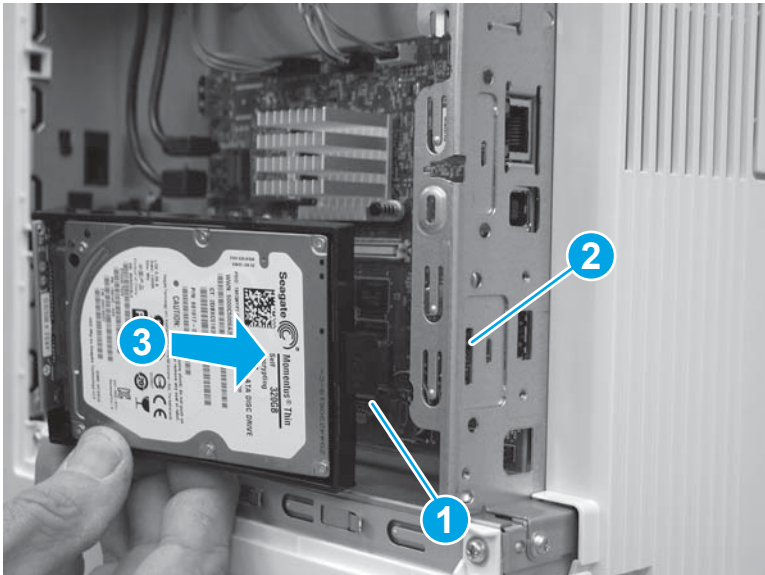

2. Rotate the HDD connector (callout 1) down and into the connector on the formatter to install it.



 **NOTE:** Make sure that the tabs (callout 2) snap into place, and that the HDD is securely installed.

Figure 1-1434 Release the HDD

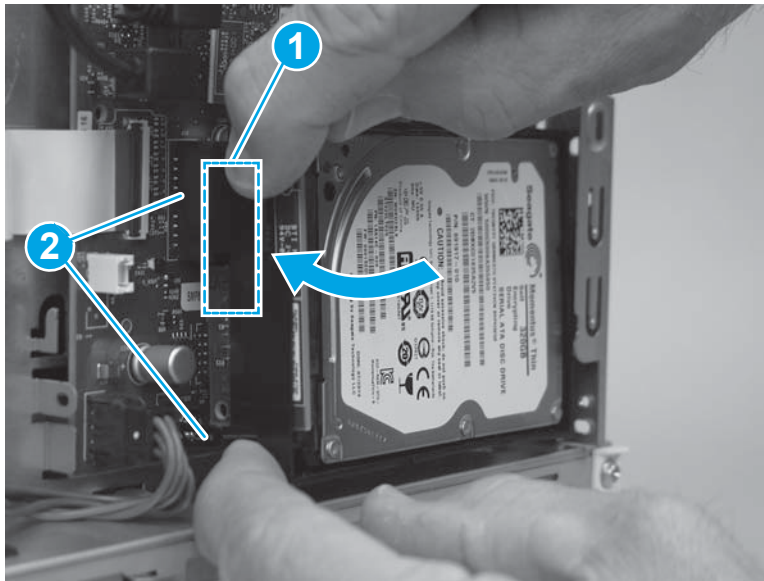

Step 13: Install the formatter cover

- ▲ Slide the cover onto the printer (callout 1) to install it.

 **NOTE:** Make sure that the tabs on the formatter cover align with the slots provided in the printer (callout 2). Tighten the two thumbscrews (callout 3).

 **TIP:** If needed, use the edge of a coin to turn the thumbscrews.

Figure 1-1435 Install the cover



Removal and replacement: Formatter (M577)

- [Introduction](#)
- [Step 1: Remove the formatter cover](#)
- [Step 2: Remove the hard-disk drive \(HDD\) \(M577\)](#)
- [Step 3: Remove the fax PCA \(M577c/f/z\)](#)
- [Step 4: Remove the dual inline memory module \(DIMM\) \(M577\)](#)
- [Step 5: Remove the formatter](#)
- [Step 6: Unpack the replacement assembly](#)
- [Step 7: Install the formatter](#)
- [Step 8: Install the DIMM \(M577\)](#)
- [Step 9: Install the fax PCA \(M577c/f/z\)](#)
- [Step 10: Install the HDD \(M577\)](#)
- [Step 11: Install the formatter cover](#)

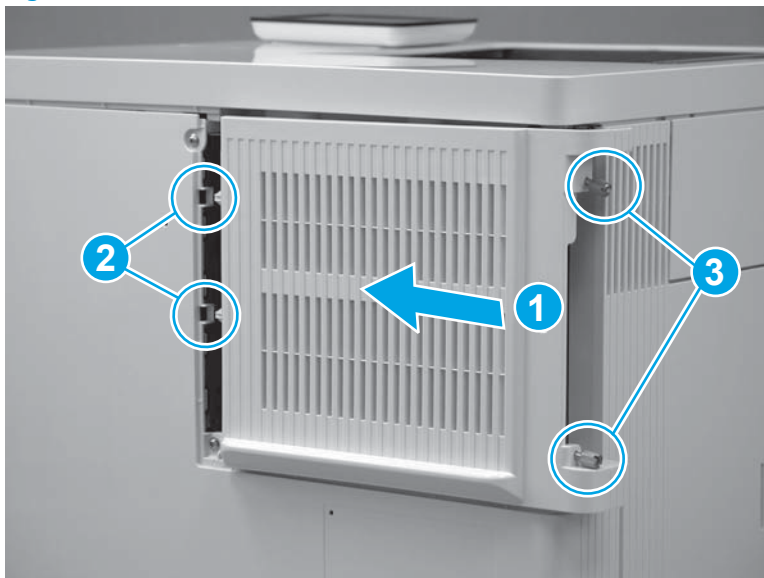
Introduction



This document provides the procedures to remove and replace the M577 formatter.

Before performing service

Turn the printer power off

- Disconnect the power cable.

 **WARNING!** To avoid damage to the printer, turn the printer off, wait 30 seconds, and then remove the power cord before attempting to service the printer.

 **CAUTION:**  This part contains components that are electrostatic discharge (ESD) sensitive. To reduce the possibility of ESD damage, always touch the sheet-metal chassis to ground yourself before touching an ESD sensitive part.

 **IMPORTANT:** Do not replace the formatter, DC controller, and hard-disk drive simultaneously during a single printer servicing. Doing so might cause the printer to become unstable or inoperable.

Use the table below to identify the correct part number for your printer, and then go to <http://h20141.www2.hp.com/hpparts> to order the part.

Formatter (M577) kit number	
85L46-67909	Formatter (M577)
85L46-67911	Formatter (M577; India and China only)

Required tools

- #2 Phillips screwdriver with a magnetic tip

After performing service

Make sure that all of the connectors on the formatter are fully seated.

Make sure that the formatter cover is fully seated, and that the thumbscrews are finger tight after replacing it.

Turn the printer power on

- Connect the power cable.
- Use the power switch to turn the power on.

Post service test

Print a configuration page to make sure that the printer is functioning correctly.

Step 1: Remove the formatter cover

1. Locate the formatter cover.

Figure 1-1436 Locate the formatter cover

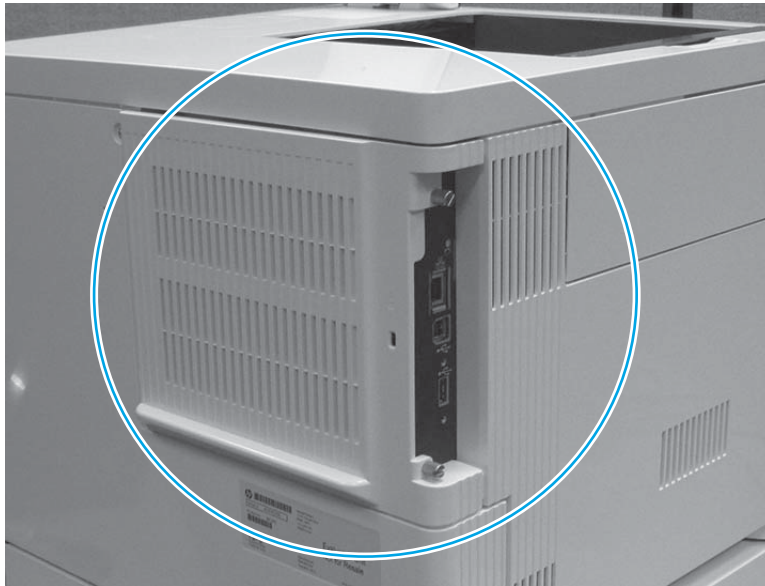

2. Loosen the two thumbscrews (callout 1). Grasp the two thumbscrews, and then slide the cover away from the printer (callout 2) to remove it.

 **TIP:** If needed, use the edge of a coin to turn the thumbscrews.

Figure 1-1437 Loosen the thumbscrews



Step 2: Remove the hard-disk drive (HDD) (M577)

 **CAUTION:**  ESD-sensitive part.

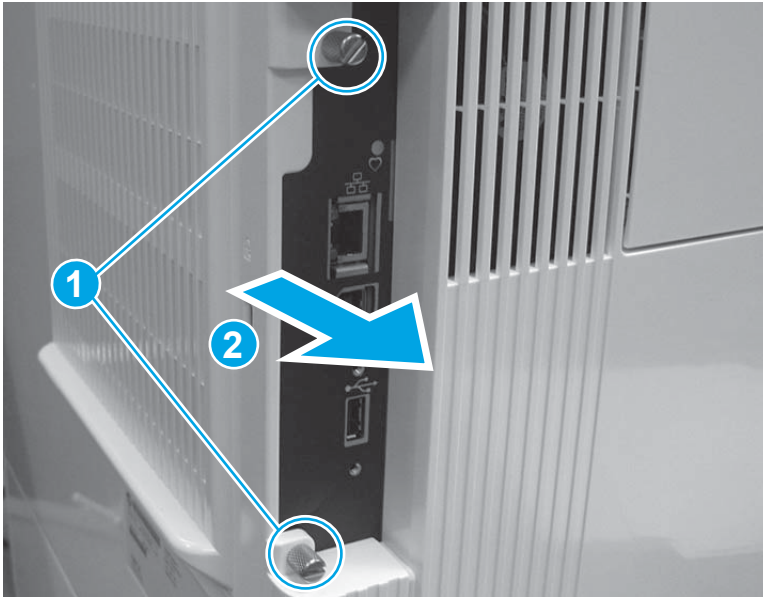
1. Release two tabs (callout 1). Hold the tabs in the released position, and then rotate the hard disk drive (HDD) up (callout 2) to release the connector from the formatter.

Figure 1-1438 Release the HDD

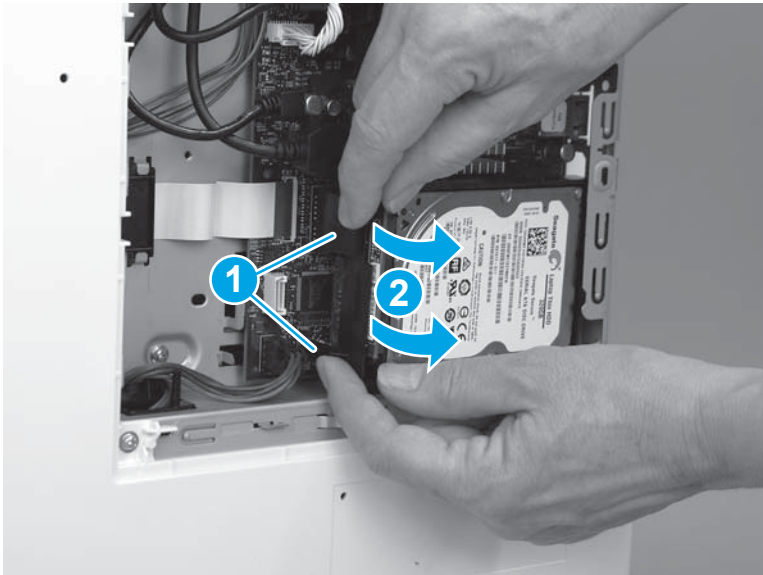

2. Slide the HDD away from the printer to remove it.

Figure 1-1439 Remove the HDD

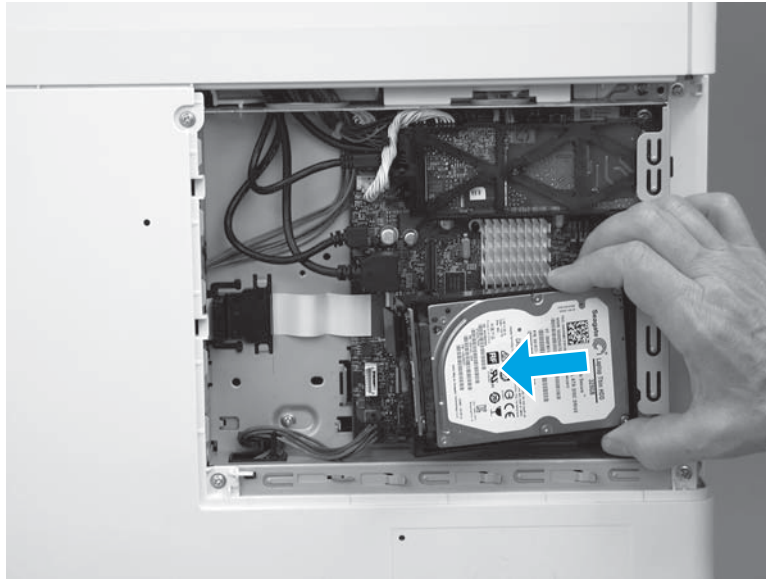

Step 3: Remove the fax PCA (M577c/f/z)

 **NOTE:** If the fax PCA is not installed, skip this step and go to [Step 4: Remove the dual inline memory module \(DIMM\) \(M577\) on page 827](#).

 **CAUTION:**  ESD-sensitive part.

1. Locate the fax PCA component on the formatter.

Figure 1-1440 Locate the fax PCA

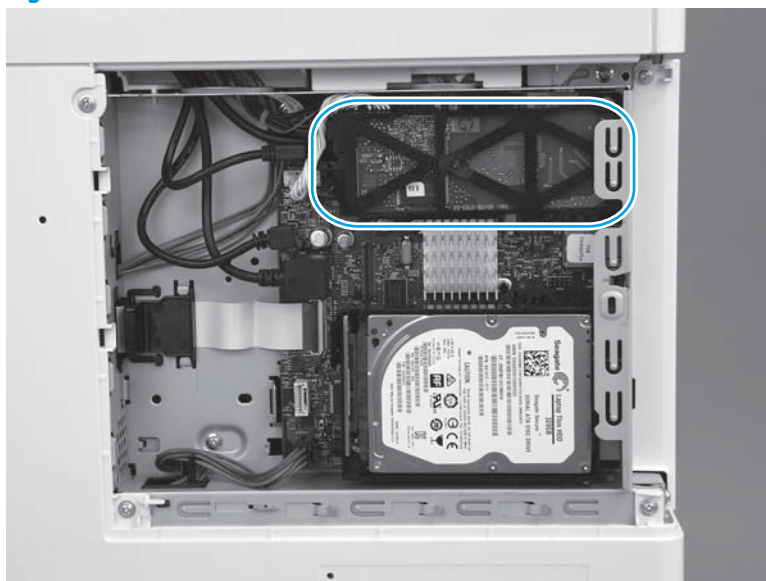

2. Release the connector latch (callout 1), and then pull the connector away from the formatter (callout 2) to disconnect it.

Figure 1-1441 Disconnect one connector

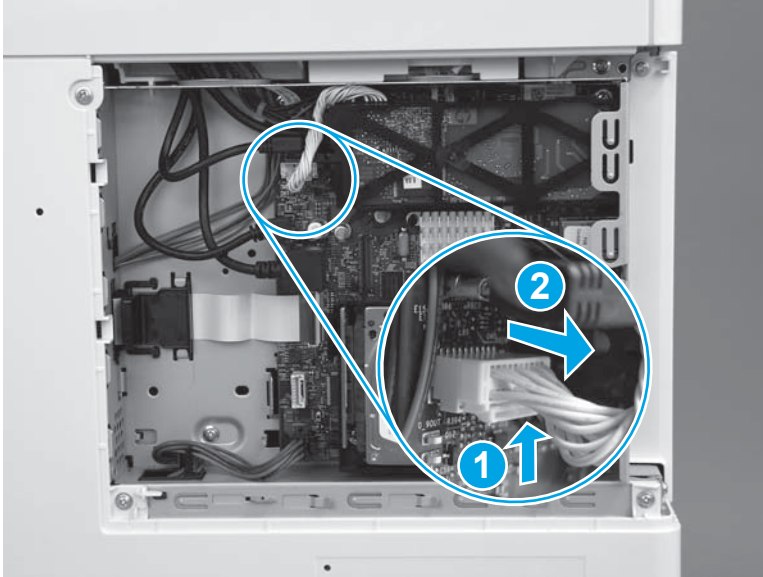

3. Release one retainer (callout 1) by pressing the bracket arms together.

Figure 1-1442 Release one latch

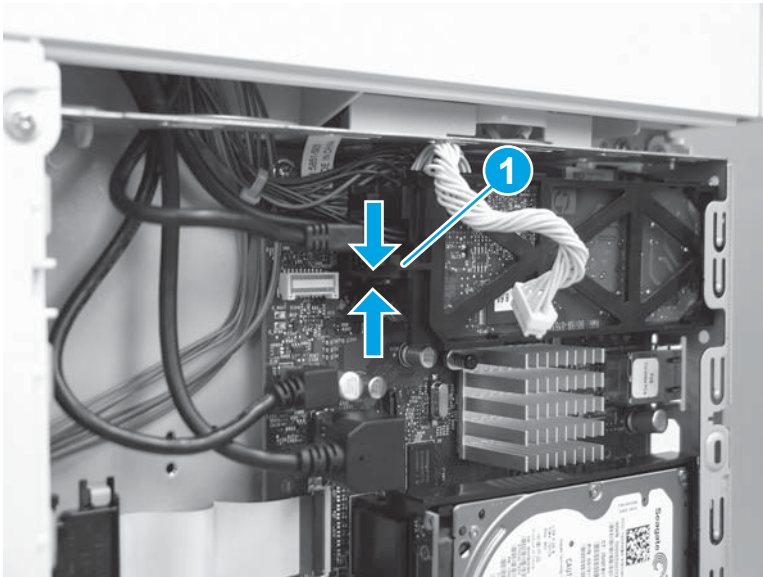

4. Rotate the end of the fax PCA (callout 1) away from the formatter, and then slide the PCA left (callout 2) to remove it.

Figure 1-1443 Remove the fax PCA

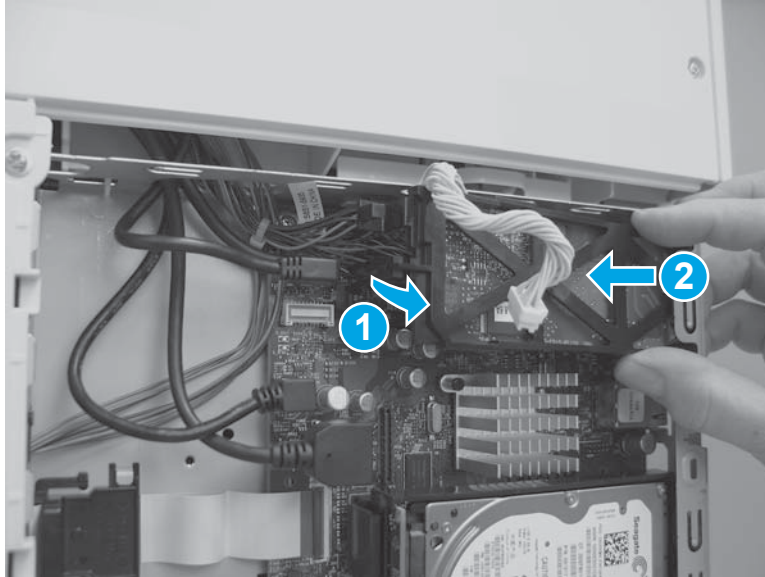

Step 4: Remove the dual inline memory module (DIMM) (M577)

 **NOTE:** If the DIMM is not installed, skip this step and go to [Step 5: Remove the formatter on page 828](#).

 **CAUTION:**  ESD-sensitive part.

1. Locate the DIMM component on the formatter.

Figure 1-1444 Locate the DIMM

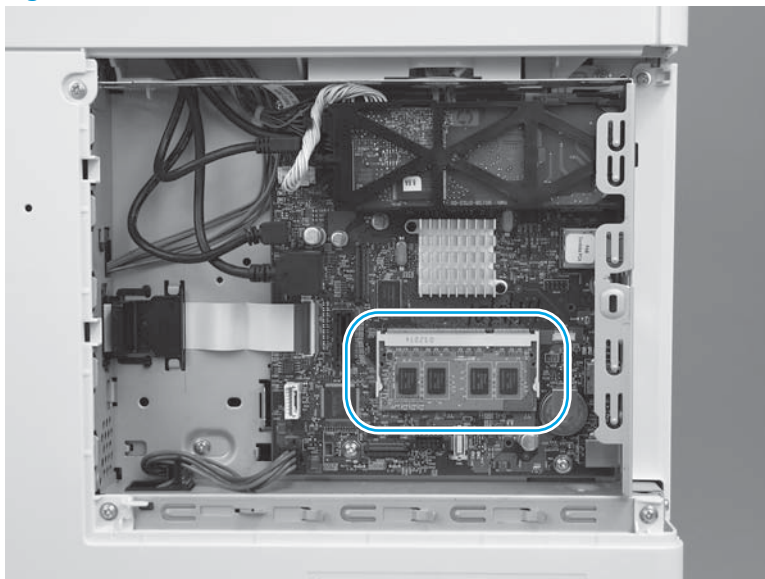

2. Do the following:
 - a. Release two locking arms (callout 1).

Figure 1-1445 Release the DIMM

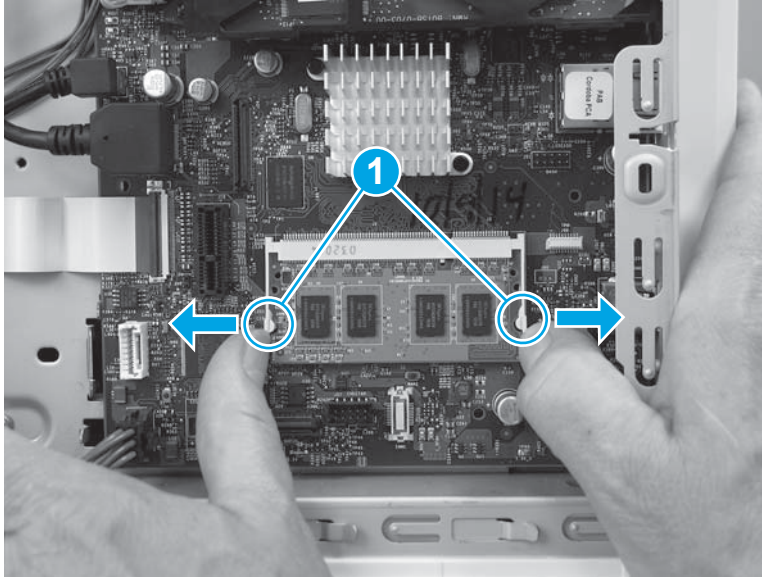

- b. Pull the DIMM down and away from the holder to remove it.

Figure 1-1446 Remove the DIMM (M527)

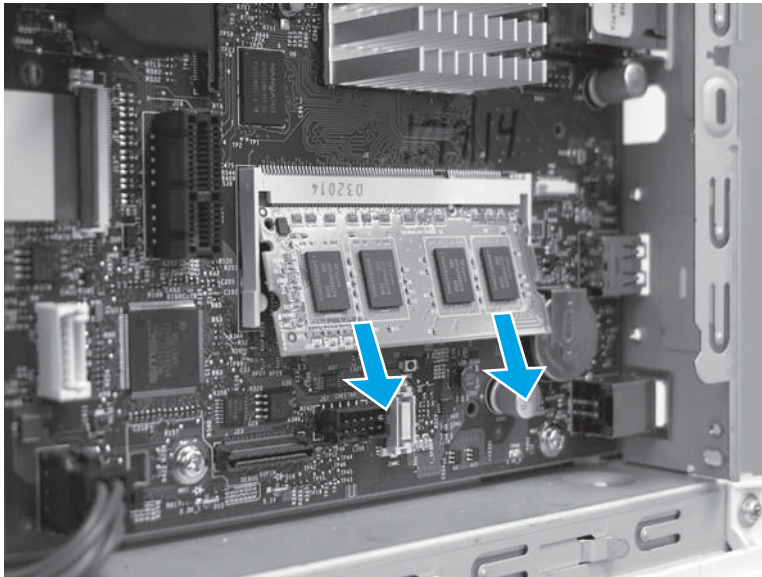

Step 5: Remove the formatter

 **CAUTION:**  ESD-sensitive part.

1. Disconnect all of the connectors on the formatter.

The following connectors are empty:

- All models: J1 (this connector is empty unless the optional DIMM is installed)
- All models: J3
- M577dn: J15 (this is the fax connector for the M577f/z/c models)

- All models: J21 (this connector is empty unless the optional internal USB ports component is installed)
- All models: J23
- All models: J24
- All models: J51
- All models: J57
- All models: J97
- All models: J98 (this connector is empty unless the optional trusted platform module (TPM) is installed)

 **IMPORTANT:** The flat-cable connector (callout 1) is a Zero Insertion Force (ZIF) connector that uses a hinged retainer to secure the flat cable. The hinged retainer must be opened to release the flat cable.

Figure 1-1447 Disconnect all connectors



2. Remove four screws (callout 1).

Figure 1-1448 Remove four screws

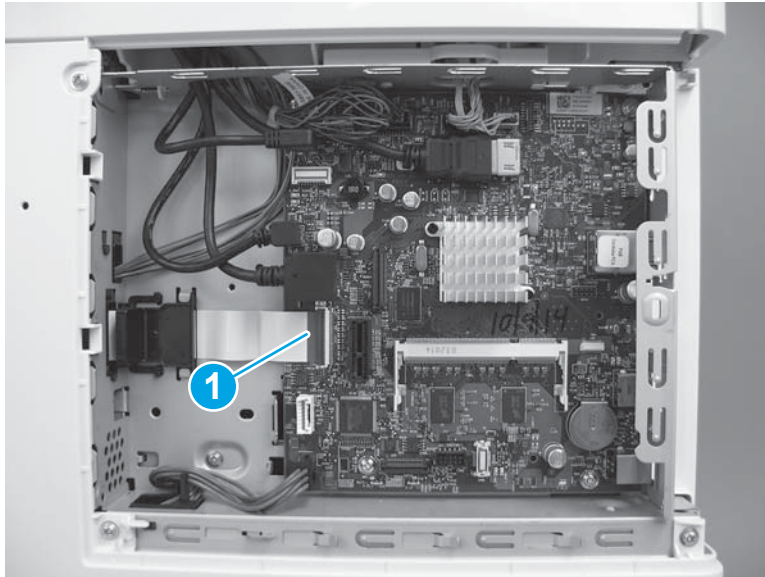
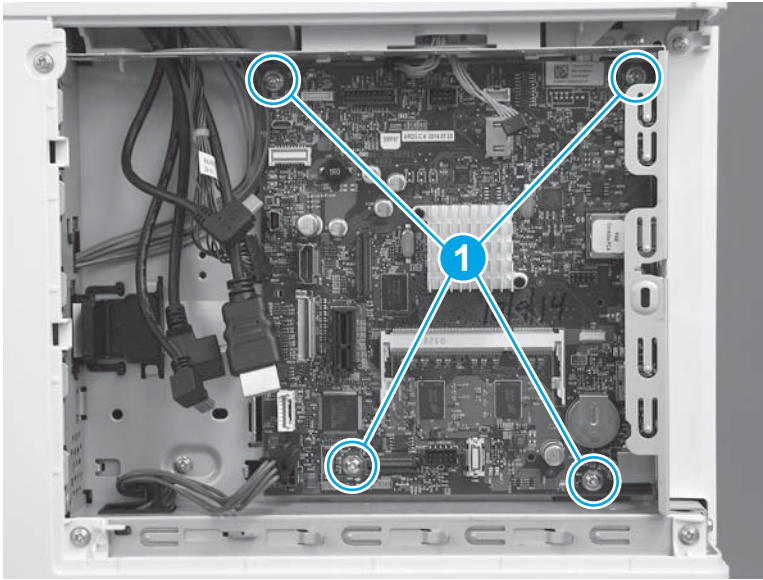

3. Remove the formatter.

Figure 1-1449 Remove the formatter

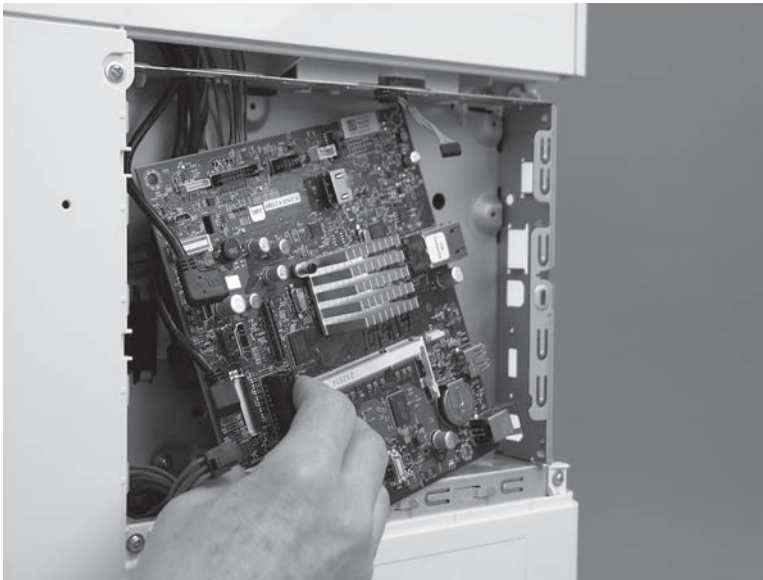

Step 6: Unpack the replacement assembly

Unpack the replacement assembly from the packaging.

 **CAUTION:**  ESD-sensitive part.

For complete information on HP's recycling programs, go to [Product return and recycling](#).

 **NOTE:** HP recommends responsible disposal of the defective assembly.

Figure 1-1450 Recycle and unpack

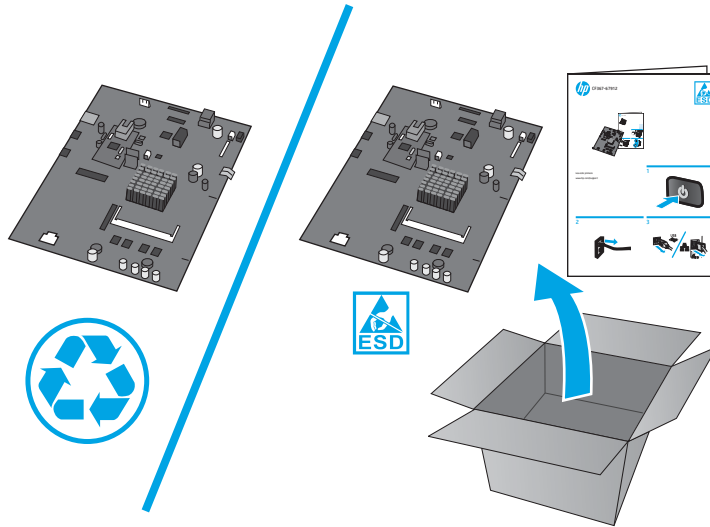

Step 7: Install the formatter

CAUTION:  ESD-sensitive part.

1. Position the formatter in the printer. Make sure that the network port (callout 1) fits through the opening (callout 2) in the formatter case.

Figure 1-1451 Install the formatter

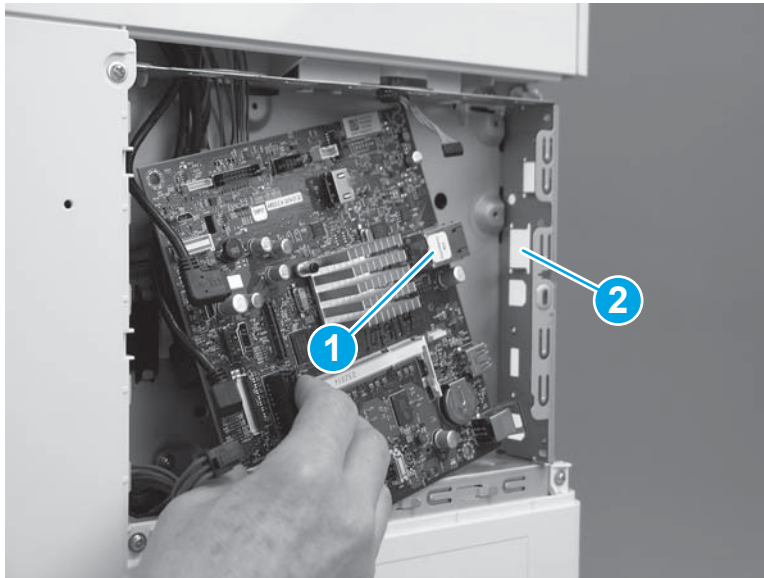

2. Install four screws (callout 1).

Figure 1-1452 Install four screws

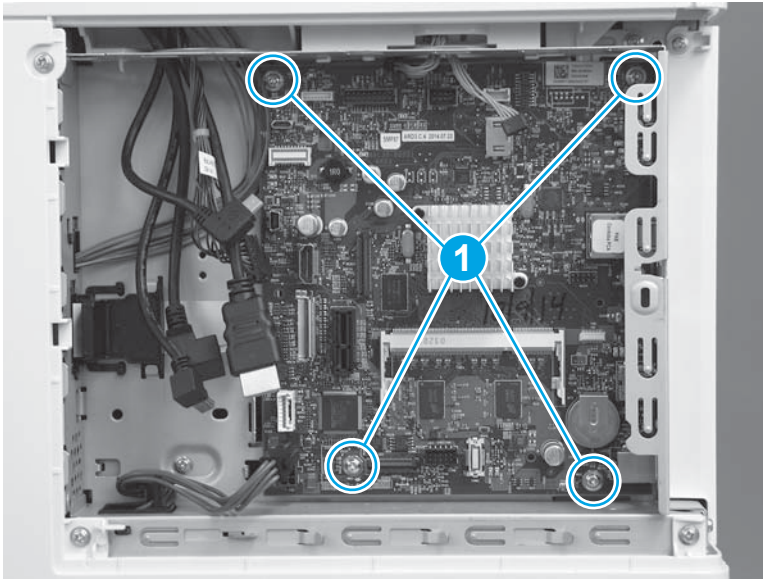

3. Connect all of the connectors on the formatter.

The following connectors are empty:

- All models: J1 (this connector is empty unless the optional DIMM is installed)
- All models: J3
- M577dn: J15 (this is the fax connector for the M577f/z/c models)
- All models: J21 (this connector is empty unless the optional internal USB ports component is installed)
- All models: J23
- All models: J24
- All models: J51
- All models: J57
- All models: J97
- All models: J98 (this connector is empty unless the optional trusted platform module (TPM) is installed)

IMPORTANT: The flat-cable connector (callout 1) is a Zero Insertion Force (ZIF) connector that uses a hinged retainer to secure the flat cable. The hinged retainer must be opened to install the flat cable, and then closed after the cable is installed.

Figure 1-1453 Connect all connectors

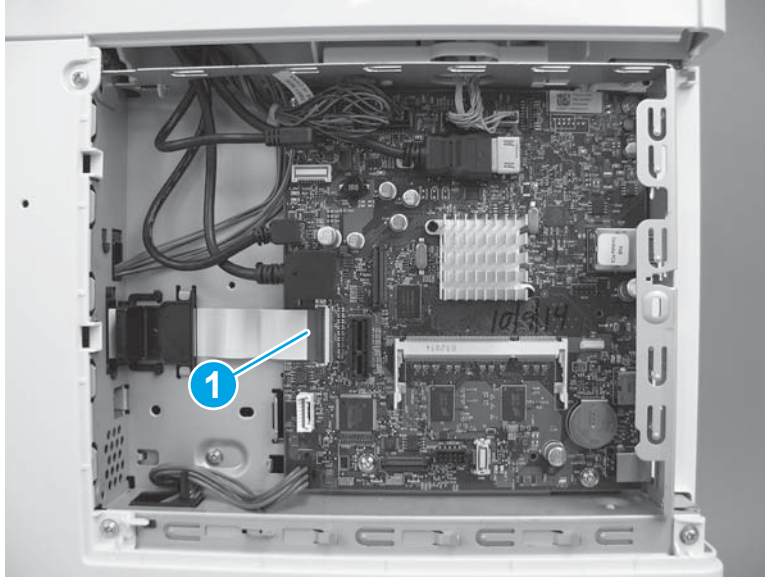

Step 8: Install the DIMM (M577)

 **NOTE:** If the DIMM is not installed, skip this step and go to [Step 9: Install the fax PCA \(M577c/f/z\)](#) on page 834.

 **CAUTION:**  ESD-sensitive part.

1. Insert the top edge of the DIMM (callout 1) in the holder (callout 2).

 **Reinstallation tip:** The DIMM is keyed and can only be inserted in the holder one way.

Figure 1-1454 Insert the DIMM



2. Make sure that the DIMM is fully installed in the holder (callout 1), and then rotate the bottom edge of the DIMM toward the holder (callout 2).

Figure 1-1455 Install the DIMM

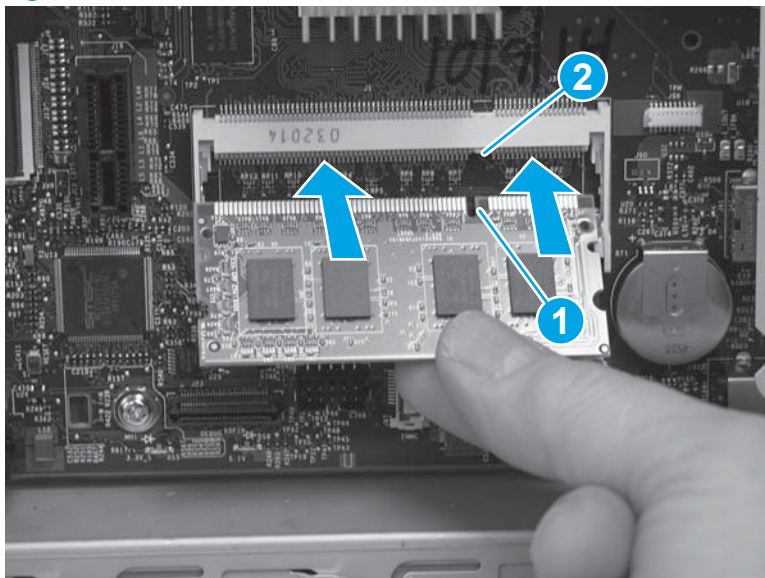
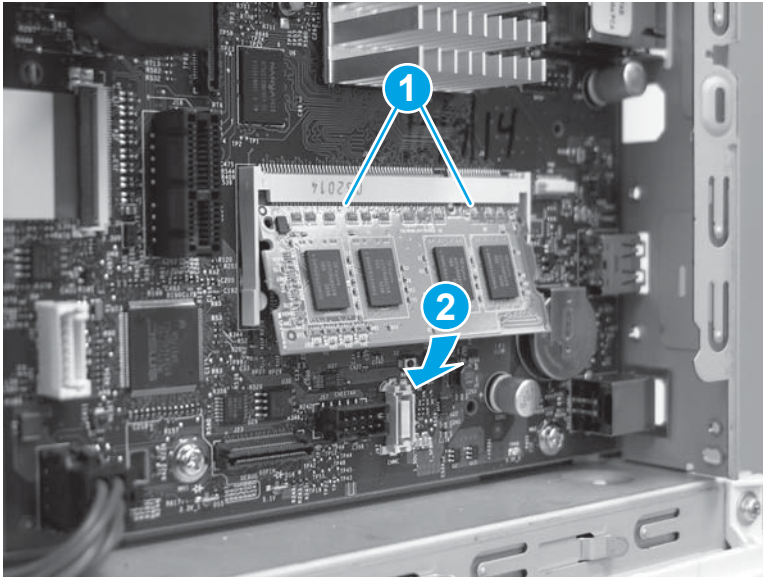

3. Make sure that the DIMM snaps into the locking arms (callout 1).

Figure 1-1456 Snap the DIMM into place

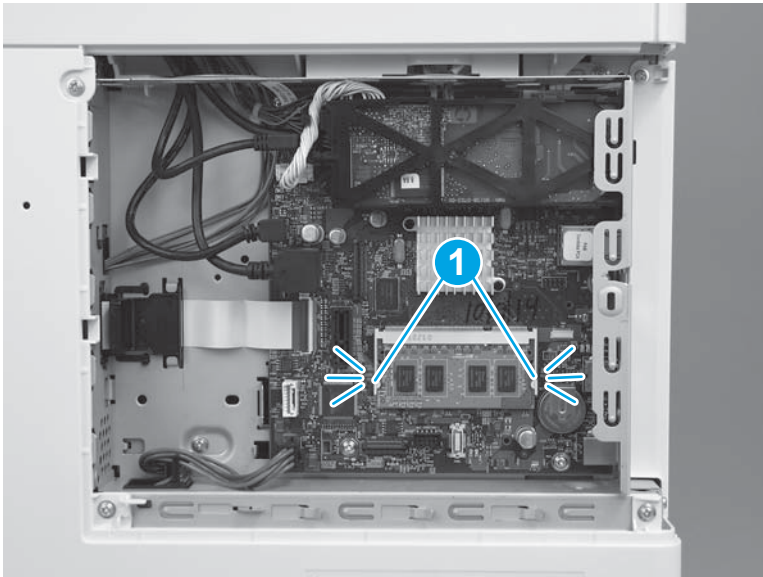

Step 9: Install the fax PCA (M577c/f/z)



NOTE: If the fax PCA is not installed, skip this step and go to [Step 10: Install the HDD \(M577\) on page 836](#).



CAUTION:  ESD-sensitive part.

1. Position the tab and telephone port (callout 1) on the fax PCA in the slots (callout 2) in the formatter case.

Figure 1-1457 Position the fax PCA

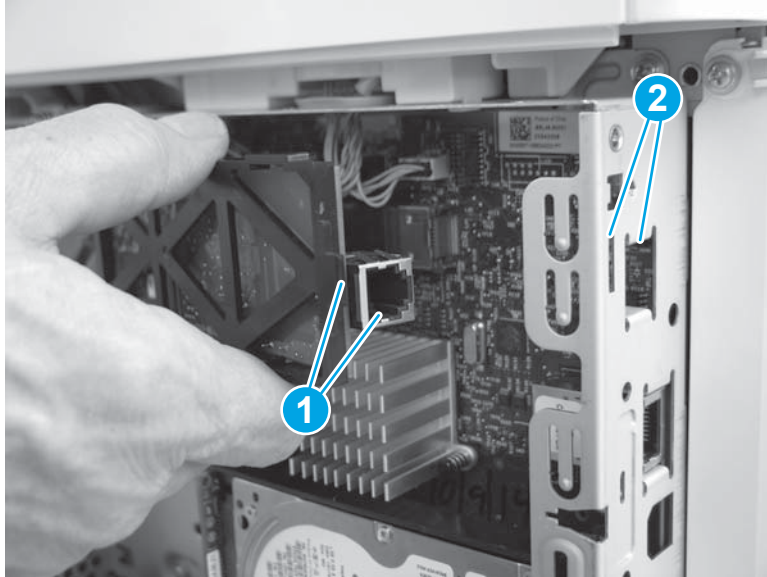

2. Slide the fax PCA to the right (callout 1) until the tab and telephone port described in the previous step and seated in the formatter case. Position the retainer (callout 2) in the slot (callout 3) in the formatter. Rotate the end of the fax PCA toward the formatter (callout 4) until the retainer snaps into place.

Figure 1-1458 Install the fax PCA

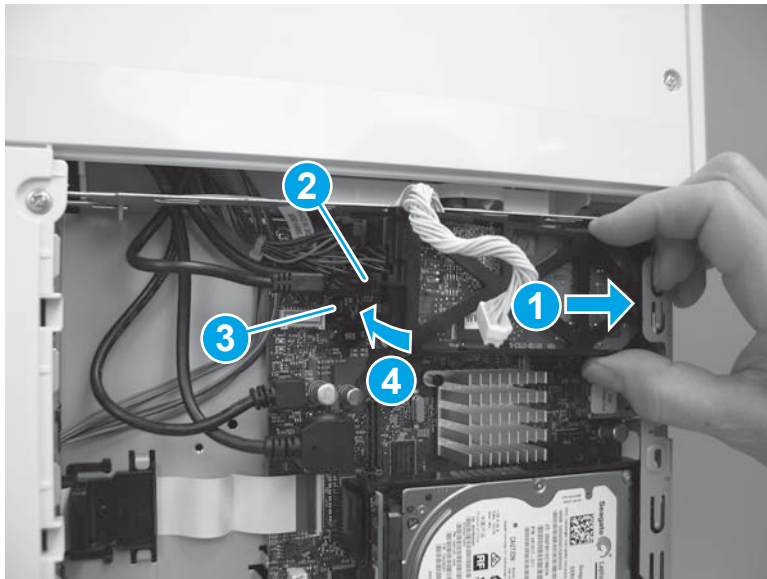

3. Position the cable (callout 1) in the guide (callout 2), and then connect one connector (callout 3).

Figure 1-1459 Connect the connector

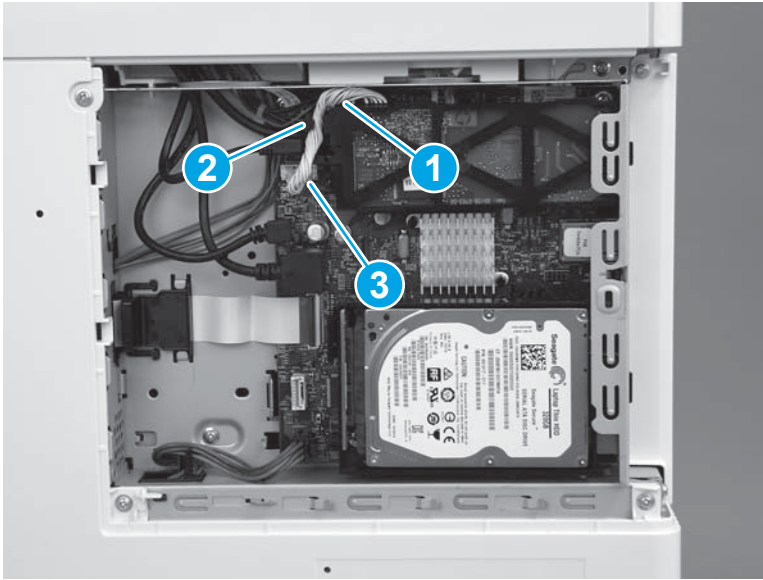

Step 10: Install the HDD (M577)

 **CAUTION:**  ESD-sensitive part.

1. Align the end of the bracket (callout 1) with the slot in the chassis (callout 2), and then slide the HDD into the printer (callout 3) to engage the bracket with the chassis.

Figure 1-1460 Install the holder

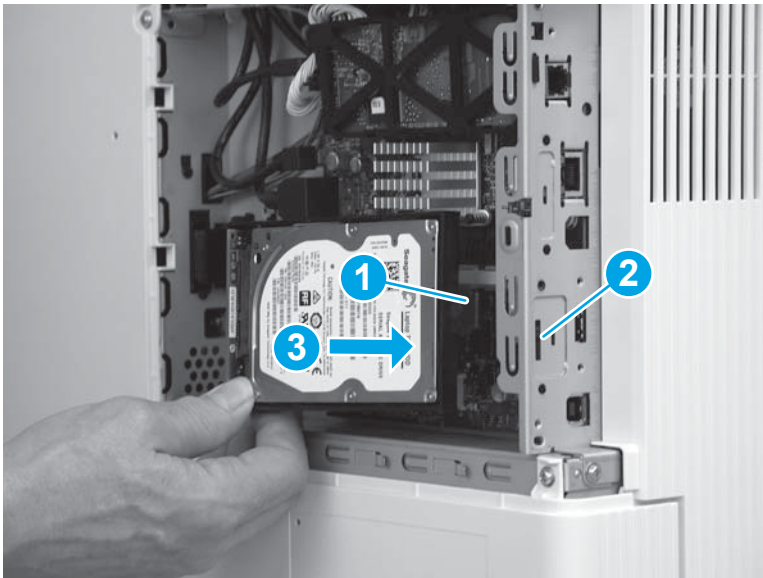

2. Hold the HDD connector latch (callout 1) in the released position, and then rotate the HDD down and into the connector on the formatter to install it.

 **NOTE:** Make sure that the tab (callout 2) snaps into place, and that the HDD is securely installed.

Figure 1-1461 Release the HDD

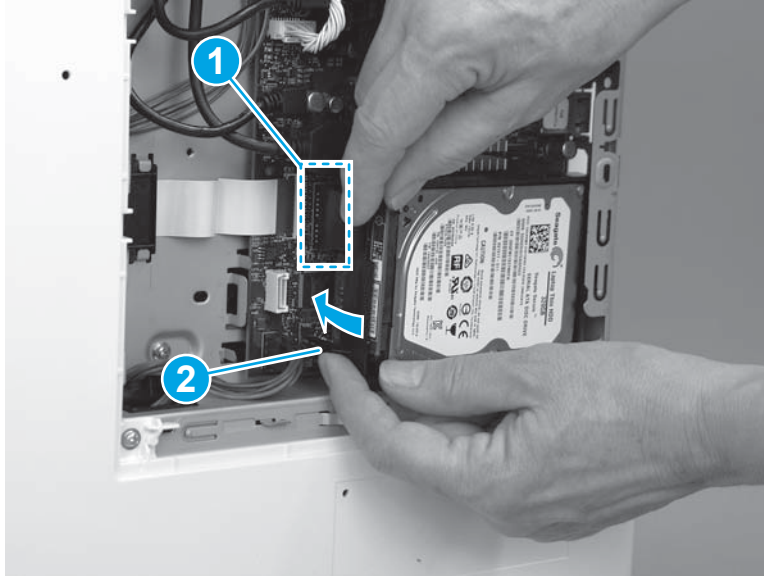

Step 11: Install the formatter cover

- ▲ Slide the cover onto the printer (callout 1) to install it.

 **NOTE:** Make sure that the tabs on the formatter cover align with the slots provided in the printer (callout 2). Tighten the two thumbscrews (callout 3).

 **TIP:** If needed, use the edge of a coin to turn the thumbscrews.

Figure 1-1462 Install the cover



Removal and replacement: Formatter case assembly

- [Introduction](#)
- [Step 1: Remove the toner collection unit \(TCU\)](#)
- [Step 2: Remove the formatter cover](#)
- [Step 3: Remove the formatter \(M552 and M553\)](#)
- [Step 4: Remove the hard-disk drive \(HDD\) \(M577\)](#)
- [Step 5: Remove the fax PCA \(M577c/f/z\)](#)
- [Step 6: Remove the formatter \(M577\)](#)
- [Step 7: Remove the rear cover \(M552 and M553\)](#)
- [Step 8: Remove the rear upper cover \(M577\)](#)
- [Step 9: Remove the rear cover \(M577\)](#)
- [Step 10: Remove the left cover](#)
- [Step 11: Remove the formatter case](#)
- [Step 12: Unpack the replacement assembly](#)
- [Step 13: Install the formatter case](#)
- [Step 14: Install the left cover](#)
- [Step 15: Install the rear cover \(M577\)](#)
- [Step 16: Install the rear upper cover \(M577\)](#)
- [Step 17: Install the rear cover \(M552 and M553\)](#)
- [Step 18: Install the formatter \(M577\)](#)
- [Step 19: Install the fax PCA \(M577c/f/z\)](#)
- [Step 20: Install the HDD \(M577\)](#)
- [Step 21: Install the formatter \(M552 and M553\)](#)
- [Step 22: Install the formatter cover](#)
- [Step 23: Install the TCU](#)

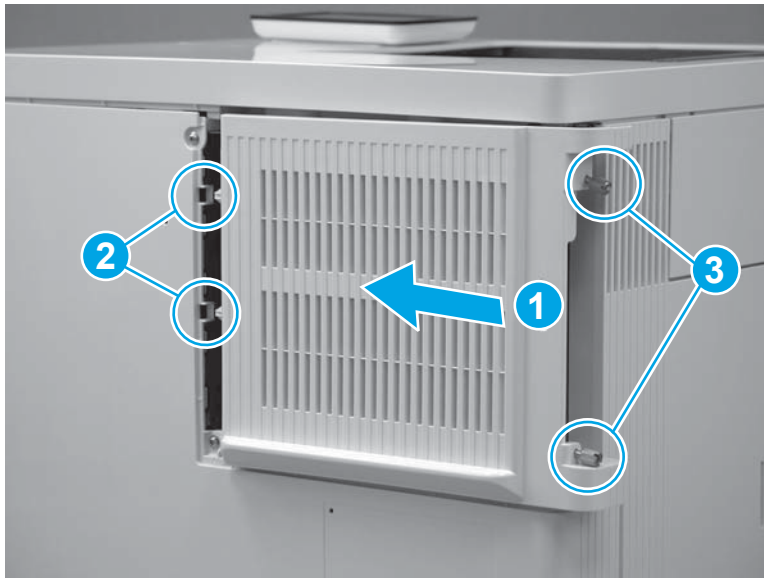
Introduction

This document provides the procedures to remove and replace the formatter case assembly.

Before performing service

Turn the printer power off

- Disconnect the power cable.

 **WARNING!** To avoid damage to the printer, turn the printer off, wait 30 seconds, and then remove the power cord before attempting to service the printer.

- Open the right door.

Use the table below to identify the correct part number for your printer, and then go to <http://h20141.www2.hp.com/hpparts> to order the part.

Formatter case assembly part number	
Not orderable	Formatter case assembly

Required tools

- #2 Phillips screwdriver with a magnetic tip

After performing service

Make sure that all of the connectors on the formatter are fully seated.

Make sure that the TCU is fully closed after replacing it.

Make sure that the formatter cover is fully seated, and that the thumbscrews are finger tight after replacing it.

Turn the printer power on

- Connect the power cable.
- Use the power switch to turn the power on.

Post service test

Print a configuration page to make sure that the printer is functioning correctly.

Step 1: Remove the toner collection unit (TCU)

 **NOTE:** The M553 model is shown in some of the figures below. The procedure is also correct for the M577 models.

1. Open the front door.

Figure 1-1463 Open the front door



2. Open the TCU.



NOTE: The toner collection hatch cover automatically closes when the TCU is opened.

Figure 1-1464 Open the TCU



3. Pull the TCU away from the printer at an angle to remove it.

⚠ CAUTION: Do not open the toner collection hatch cover when handling the TCU. If toner gets on clothing, wipe it off by using a dry cloth and wash the clothes in cold water. Hot water sets toner into fabric.

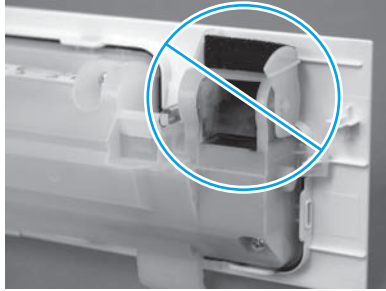
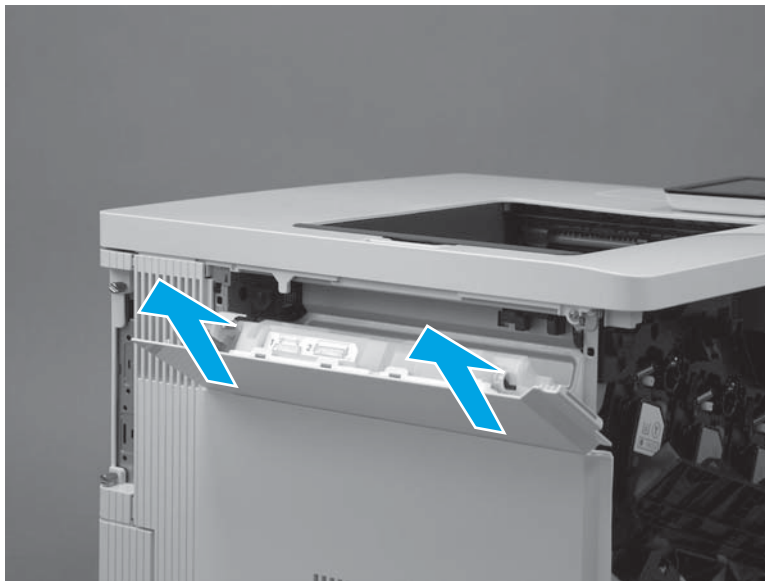

Figure 1-1465 Remove the TCU



Step 2: Remove the formatter cover

1. Locate the formatter cover.

Figure 1-1466 Locate the formatter cover

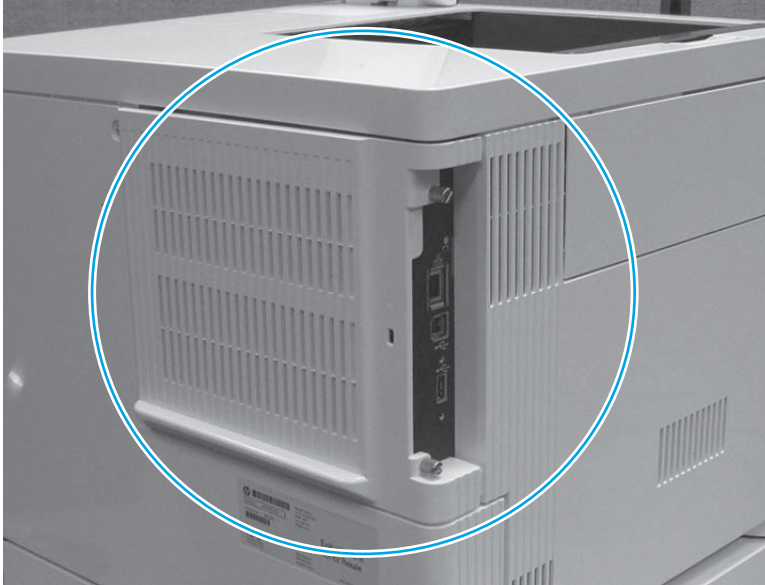

2. Loosen the two thumbscrews (callout 1). Grasp the two thumbscrews, and then slide the cover away from the printer (callout 2) to remove it.

 **TIP:** If needed, use the edge of a coin to turn the thumbscrews.

Figure 1-1467 Loosen the thumbscrews



Step 3: Remove the formatter (M552 and M553)

 **NOTE:** This step is for the M552 and M553 models. For the M577 models, skip this step and go to [Step 4: Remove the hard-disk drive \(HDD\) \(M577\) on page 844](#).

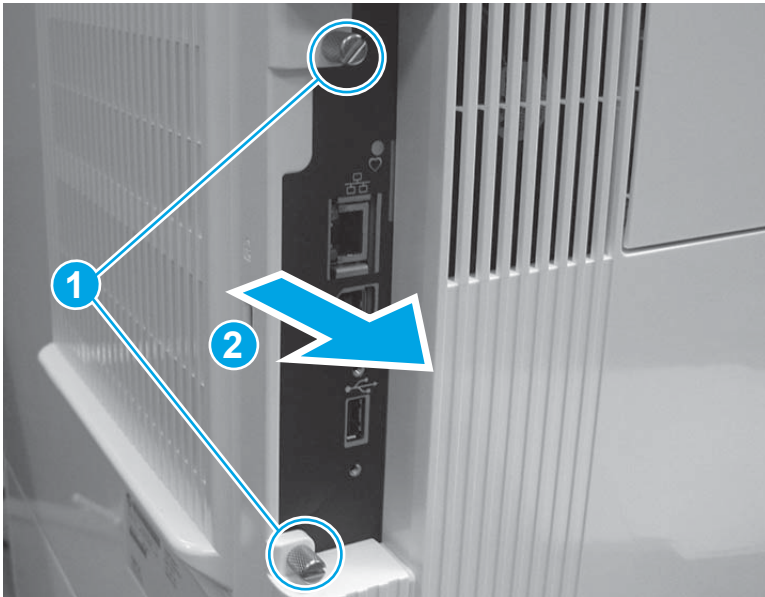
If the optional hard-disk drive (HDD) is installed, it must be removed to gain access to the formatter mounting screws.

Release two tabs along the left edge of the HDD, rotate the left edge away from the product, and then slide the HDD to the left to remove it.

 **CAUTION:**  ESD-sensitive part.

1. Disconnect all of the connectors on the formatter.

The following connectors are empty:

- All models: J1 (this connector is empty unless the optional DIMM is installed)
- M553n/dn and M552dn: J2 (callout 1; this is the touchscreen connector for the M553x model)
- All models: J9 (this connector is empty unless the optional internal USB ports component is installed)
- All models: J18 (this connector is empty unless the optional hard-disk-drive (HDD) is installed)
- All models: J23
- All models: J24
- M553n/dn and M552dn: J25 (this is the wireless connector for the M553x model)
- All models: J57
- All models: J98 (this connector is empty unless the optional trusted platform module (TPM) is installed)

 **IMPORTANT:** The flat-cable connector (callout 2) is a Zero Insertion Force (ZIF) connector that uses a hinged retainer to secure the flat cable. The hinged retainer must be opened to release the flat cable.

Figure 1-1468 Disconnect all connectors



2. Remove four screws (callout 1), and then remove the formatter.

Figure 1-1469 Remove the formatter

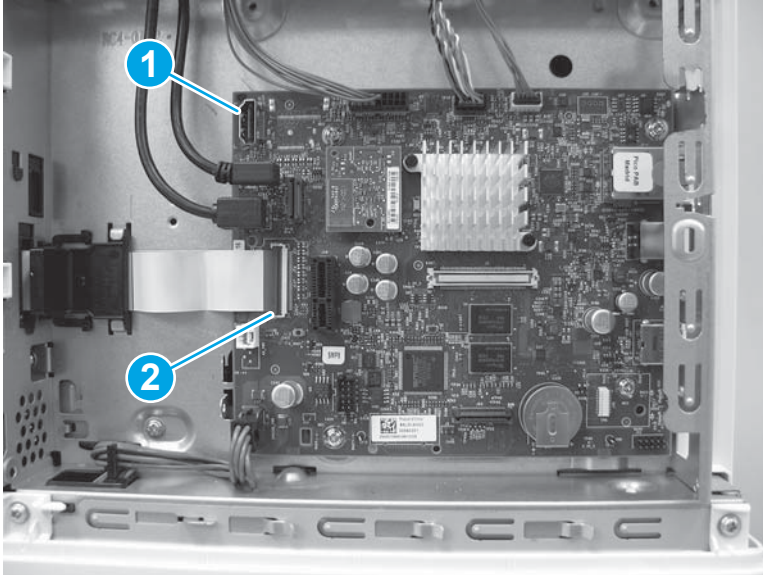
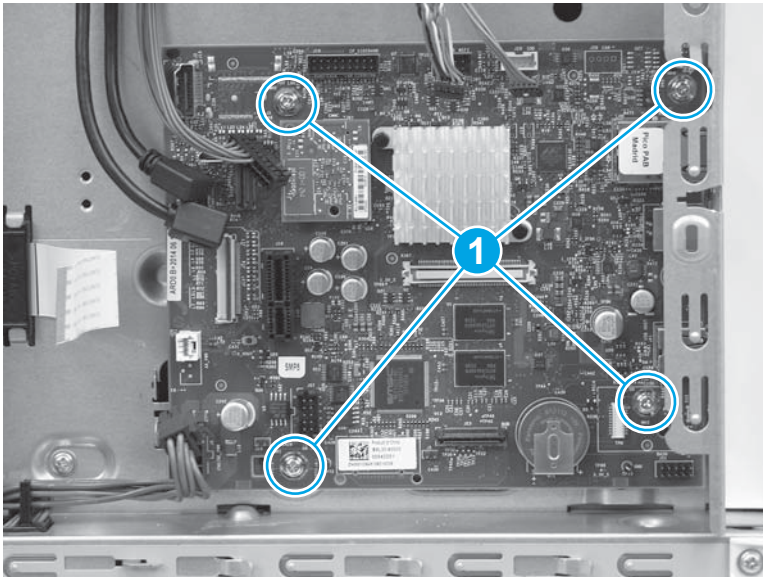

Step 4: Remove the hard-disk drive (HDD) (M577)

 **NOTE:** This step is for the M577 models. For the M552 and M553 models, skip this step and go to [Step 7: Remove the rear cover \(M552 and M553\) on page 849.](#)

 **CAUTION:**  ESD-sensitive part.

1. Release two tabs (callout 1). Hold the tabs in the released position, and then rotate the hard disk drive (HDD) up (callout 2) to release the connector from the formatter.

Figure 1-1470 Release the HDD

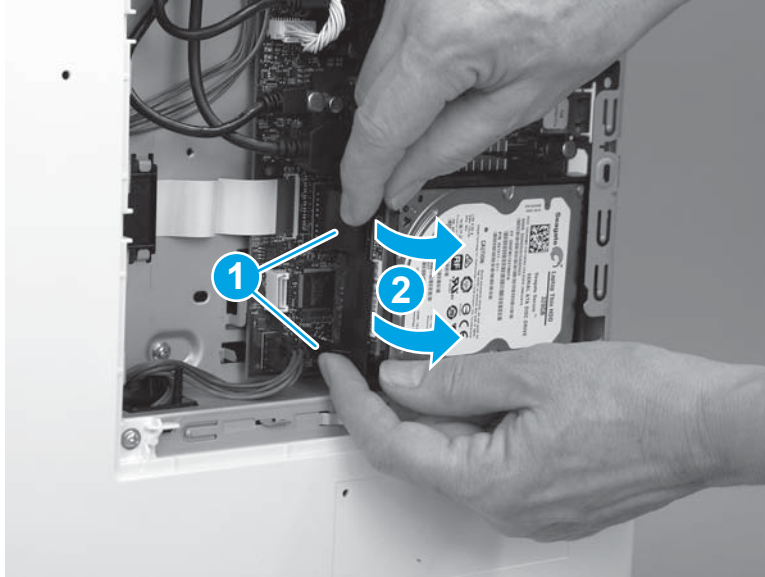

2. Slide the HDD away from the printer to remove it.

Figure 1-1471 Remove the HDD

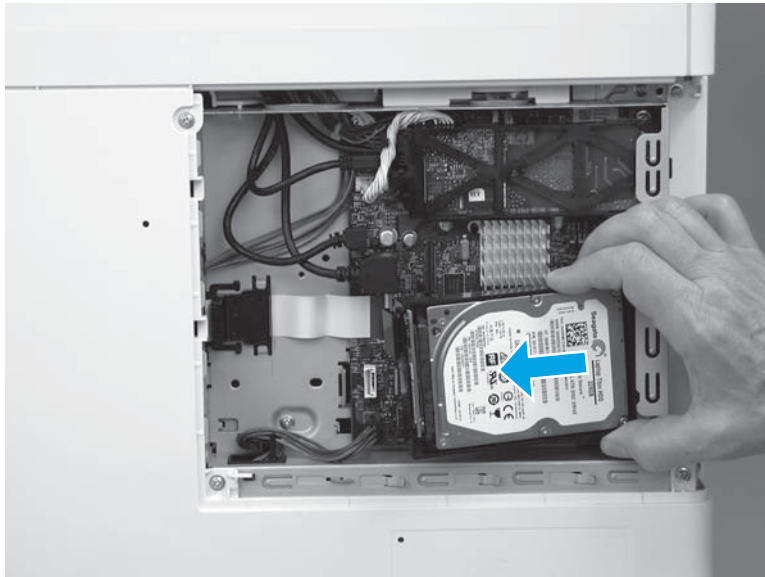

Step 5: Remove the fax PCA (M577c/f/z)

 **NOTE:** This step is for the M577c/f/z models. For the M577n model, skip this step and go to [Step 6: Remove the formatter \(M577\) on page 847](#).

For the M552 and M553 models, skip this step and go to [Step 7: Remove the rear cover \(M552 and M553\) on page 849](#).

 **CAUTION:**  ESD-sensitive part.

1. Locate the fax PCA component on the formatter.

Figure 1-1472 Locate the fax PCA

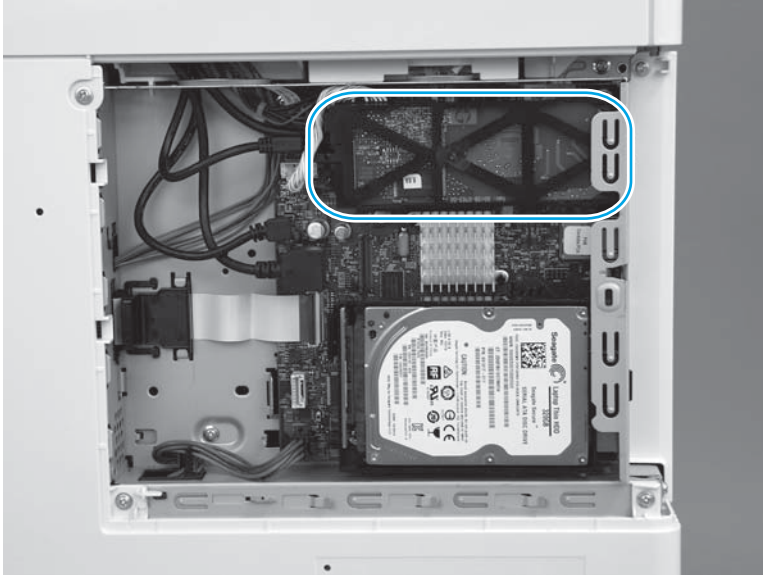

2. Release the connector latch (callout 1), and then pull the connector away from the formatter (callout 2) to disconnect it.

Figure 1-1473 Disconnect one connector

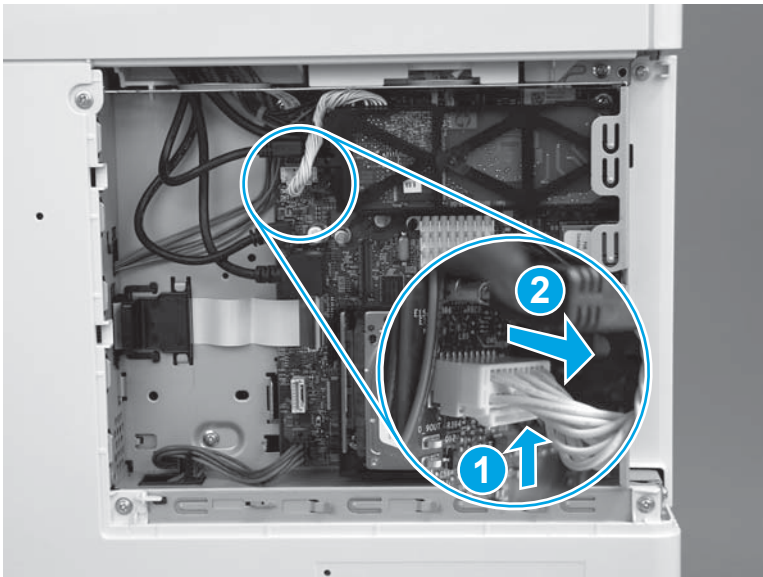

3. Release one retainer (callout 1) by pressing the bracket arms together.

Figure 1-1474 Release one latch

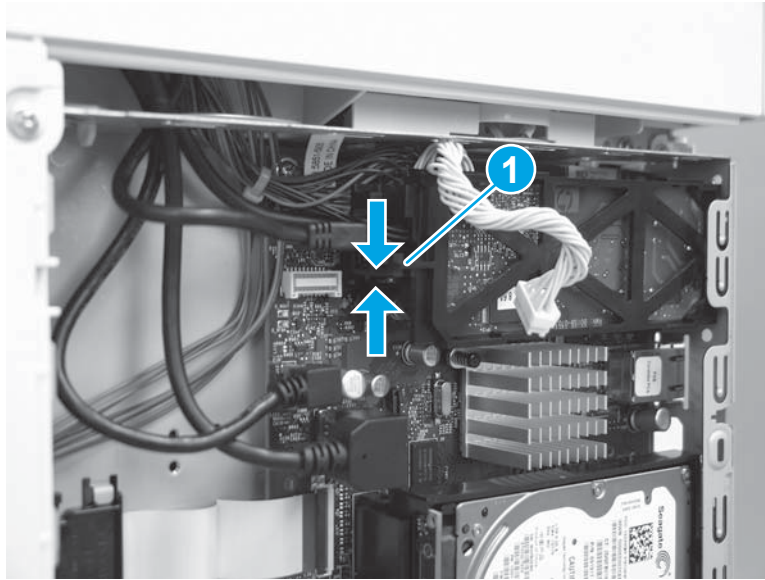

4. Rotate the end of the fax PCA (callout 1) away from the formatter, and then slide the PCA left (callout 2) to remove it.

Figure 1-1475 Remove the fax PCA

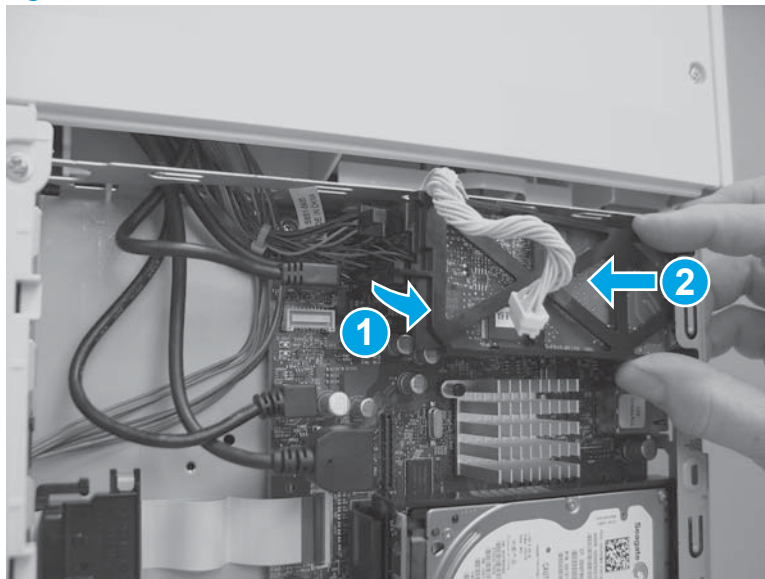

Step 6: Remove the formatter (M577)

 **NOTE:** This step is for the M577 models. For the M552 and M553 models, skip this step and go to [Step 7: Remove the rear cover \(M552 and M553\) on page 849.](#)

 **CAUTION:**  ESD-sensitive part.

1. Disconnect all of the connectors on the formatter.

The following connectors are empty:

- All models: J1 (this connector is empty unless the optional DIMM is installed)
- All models: J3
- M577dn: J15 (this is the fax connector for the M577f/z/c models)
- All models: J21 (this connector is empty unless the optional internal USB ports component is installed)
- All models: J23
- All models: J24
- All models: J51
- All models: J57
- All models: J97
- All models: J98 (this connector is empty unless the optional trusted platform module (TPM) is installed)

 **IMPORTANT:** The flat-cable connector (callout 1) is a Zero Insertion Force (ZIF) connector that uses a hinged retainer to secure the flat cable. The hinged retainer must be opened to release the flat cable.

Figure 1-1476 Disconnect all connectors



2. Remove four screws (callout 1).

Figure 1-1477 Remove four screws

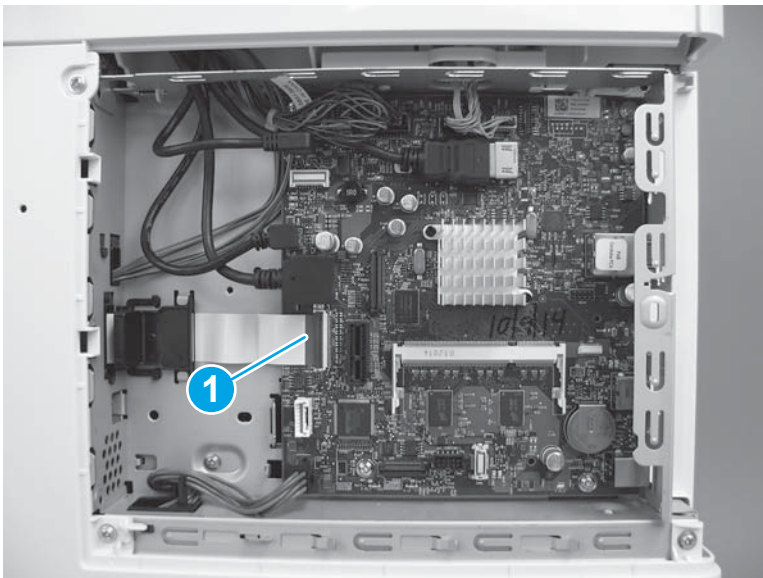
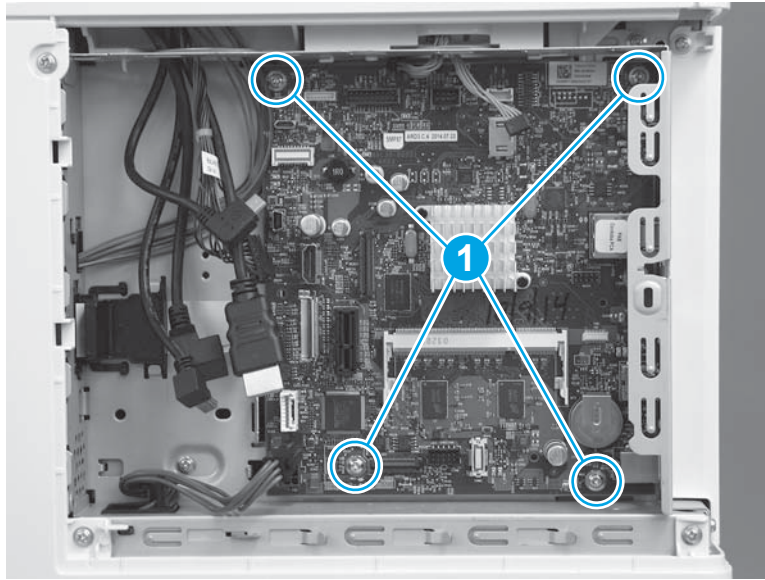

3. Remove the formatter.

Figure 1-1478 Remove the formatter

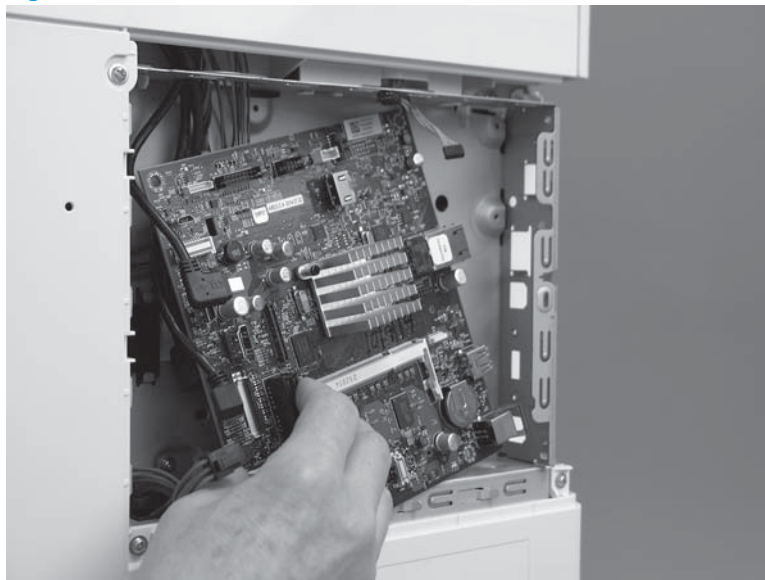

Step 7: Remove the rear cover (M552 and M553)

 **NOTE:** This step is for the M552 and M553 models. For the M577 models, skip this step and go to [Step 8: Remove the rear upper cover \(M577\) on page 850.](#)

1. Remove four screws (callout 1).

Figure 1-1479 Remove four screws

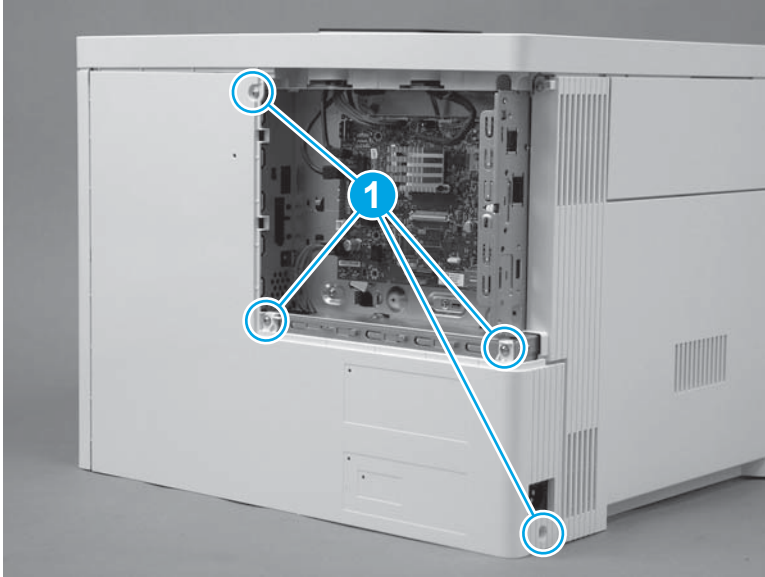

2. Slightly slide the cover to the right (callout 1), rotate the bottom of the cover away from the printer (callout 2), and then pull the top of the cover away from the printer (callout 3) to remove the cover.

Figure 1-1480 Remove the cover

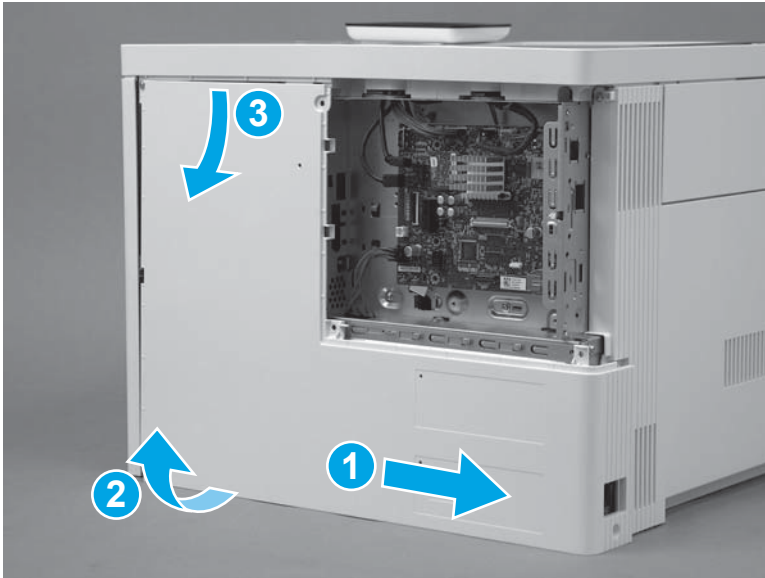

Step 8: Remove the rear upper cover (M577)



NOTE: This step is for the M577 models. For the M552 and M553 models, skip this step and go to [Step 10: Remove the left cover on page 853](#).

1. Remove two screws (callout 1).



Reinstallation tip: These two screws are self-tapping screws for plastic. When reinstalling them, rotate the screws counterclockwise to align them with the existing thread pattern, and then carefully turn them clockwise to tighten. Do not overtighten. This will prevent stripping the threads inside the screw holes.

Figure 1-1481 Remove two screws

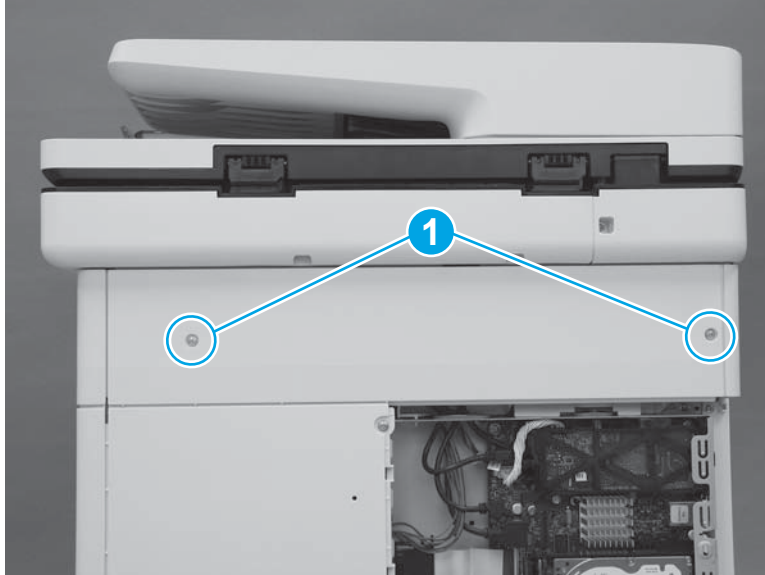

2. Use a small, flat blade screwdriver to release the right edge of the cover.

Figure 1-1482 Release the right edge

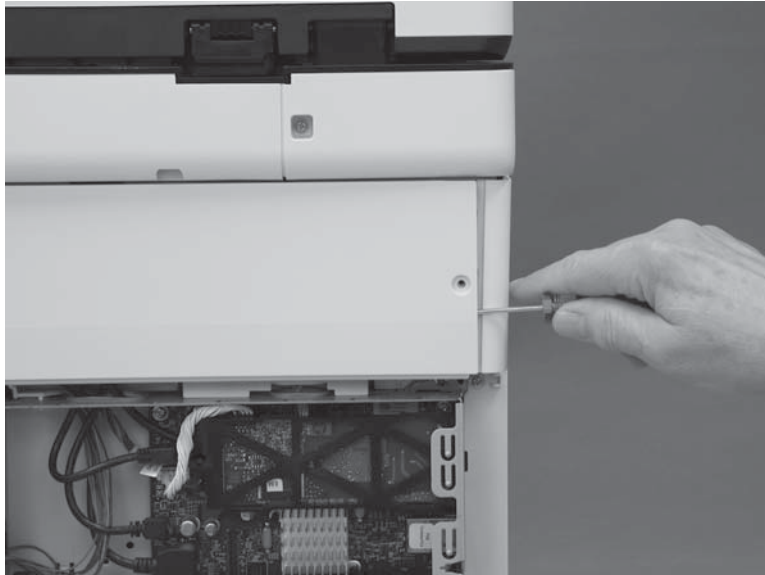

3. Pull the right edge of the cover (callout 1) away from the printer, and then slide the cover to the right (callout 2).

Figure 1-1483 Slide the cover right

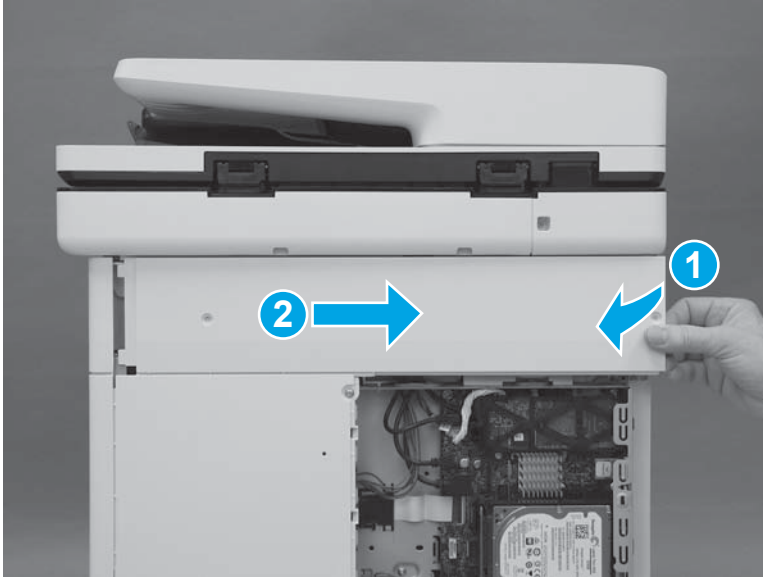

4. Remove the cover.

Figure 1-1484 Remove the cover

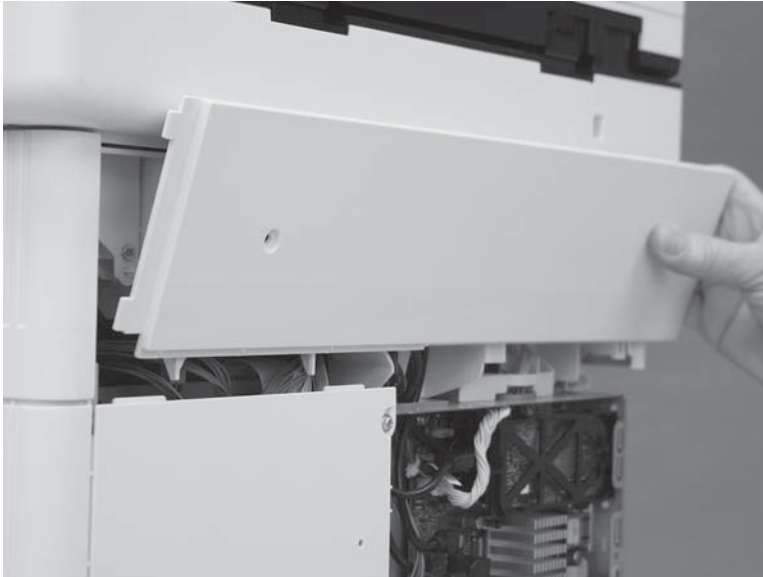

Step 9: Remove the rear cover (M577)



NOTE: This step is for the M577 models. For the M552 and M553 models, skip this step and go to [Step 10: Remove the left cover on page 853](#).

1. Remove four screws (callout 1).

Figure 1-1485 Remove four screws

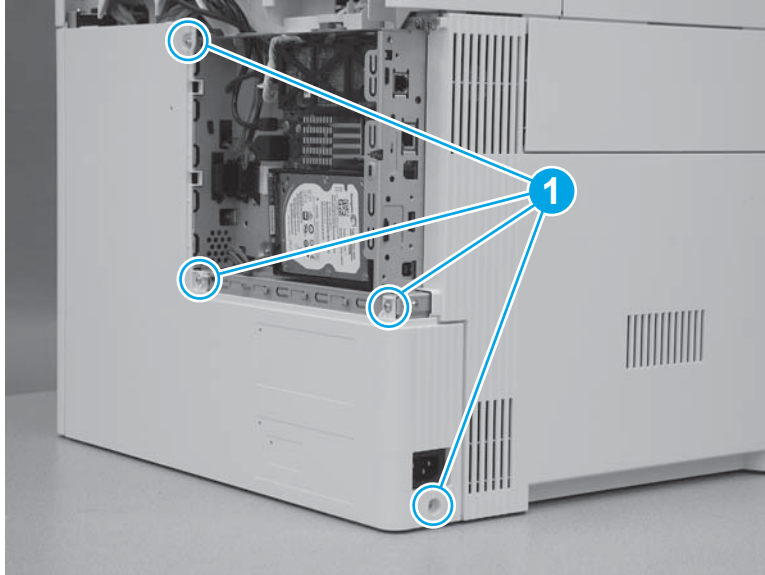

2. Slide the cover to the right to remove it.

Figure 1-1486 Remove the cover

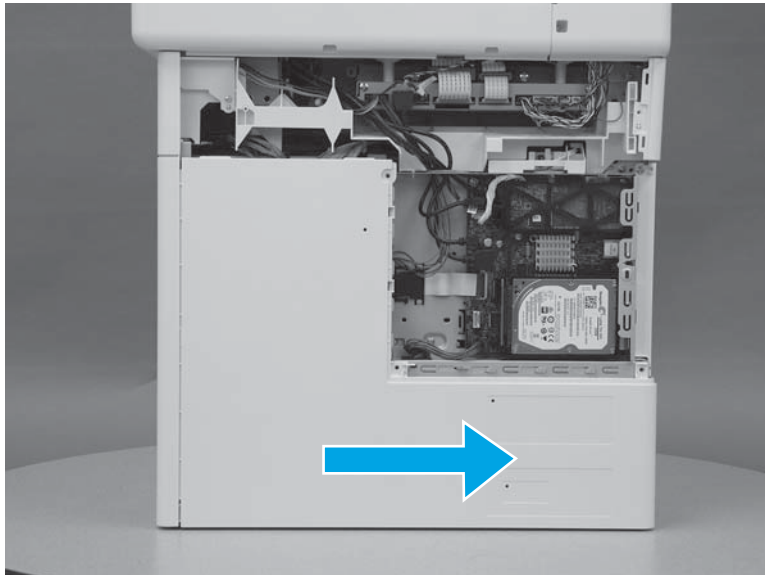

Step 10: Remove the left cover

1. At the left side of the printer, remove one screw (callout 1).

Figure 1-1487 Remove one screw



2. Release one tab (callout 1), rotate the front edge of the cover away from the printer (callout 2), and then slide the cover (callout 3) toward the rear of the printer to release it.

Figure 1-1488 Release the cover

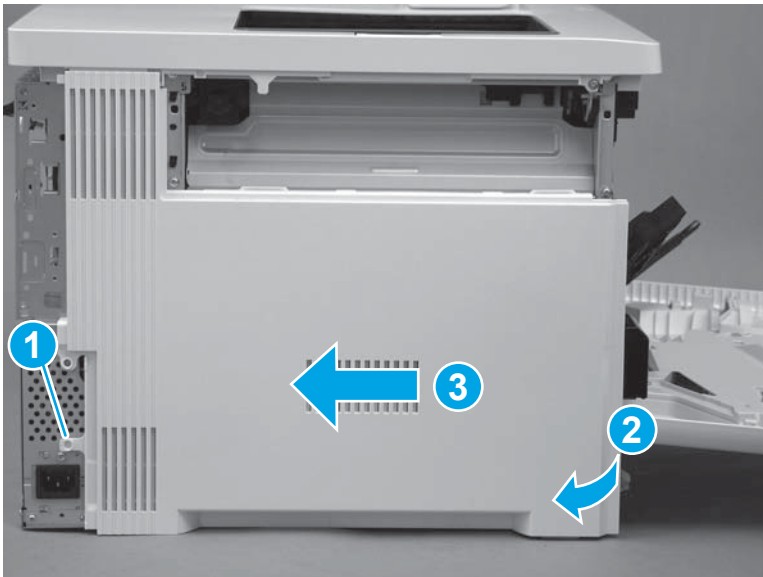

3. Remove the cover.

Figure 1-1489 Remove the cover

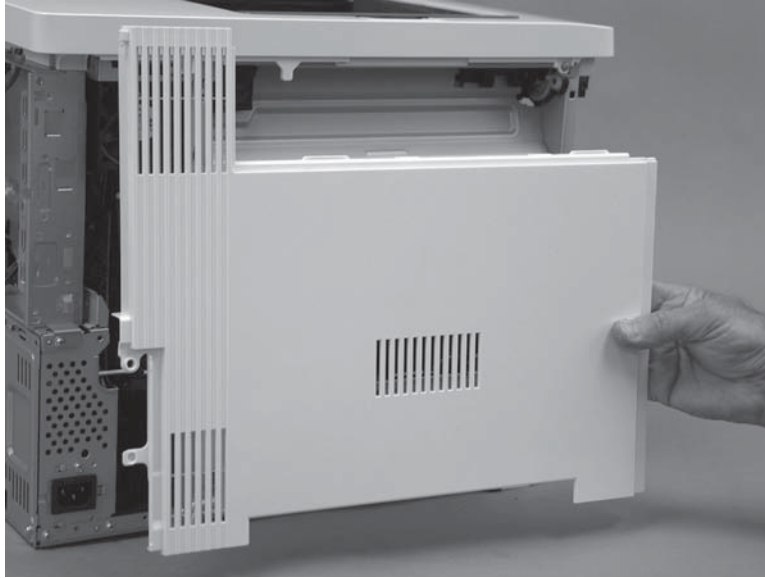

Step 11: Remove the formatter case

1. **M577 only:** Disconnect one connector (callout 1), and then pass the wire harness (callout 2) through two openings in the formatter case (callout 3).

Figure 1-1490 Disconnect one connector

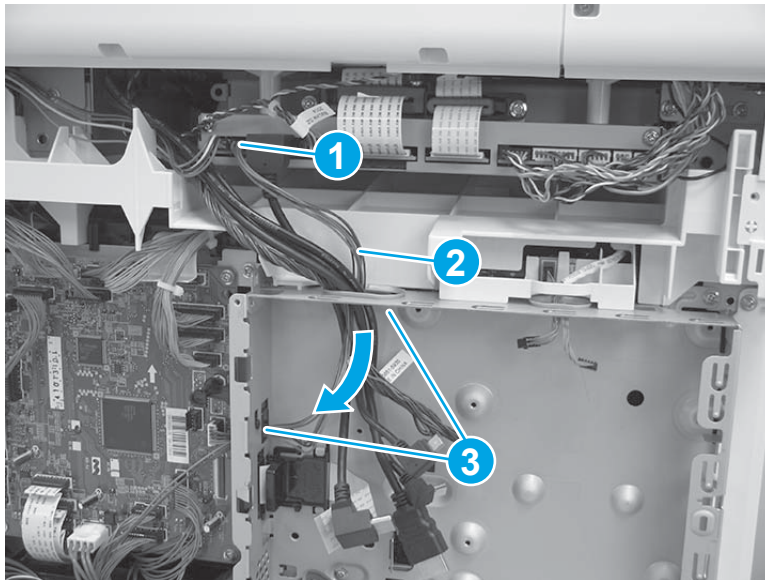

2. Release two tabs (callout 1) on the black plastic bracket. Hold the tabs in the released position, and then slide the bracket (callout 2) to the right to remove it from the formatter case.

Figure 1-1491 Remove the bracket

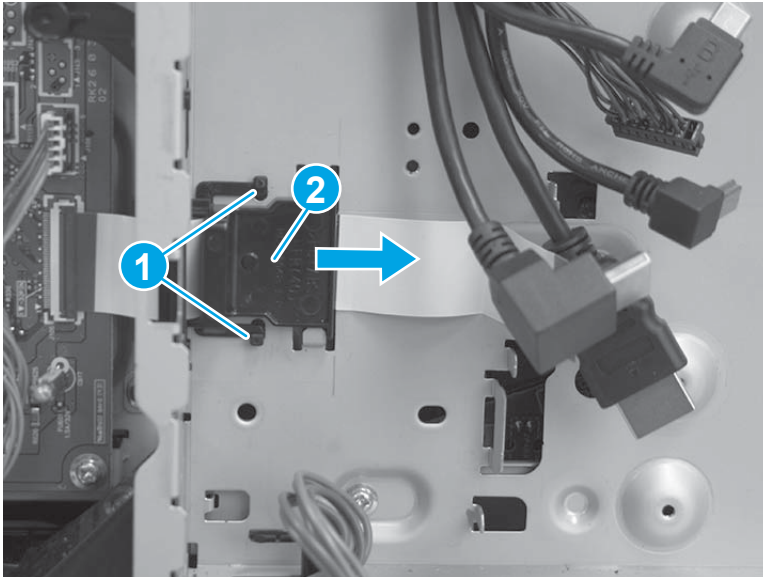

3. Remove two screws (callout 1), and then slide the low-voltage power supply (LVPS) cover to the right to remove it.

Figure 1-1492 Remove the LVPS cover

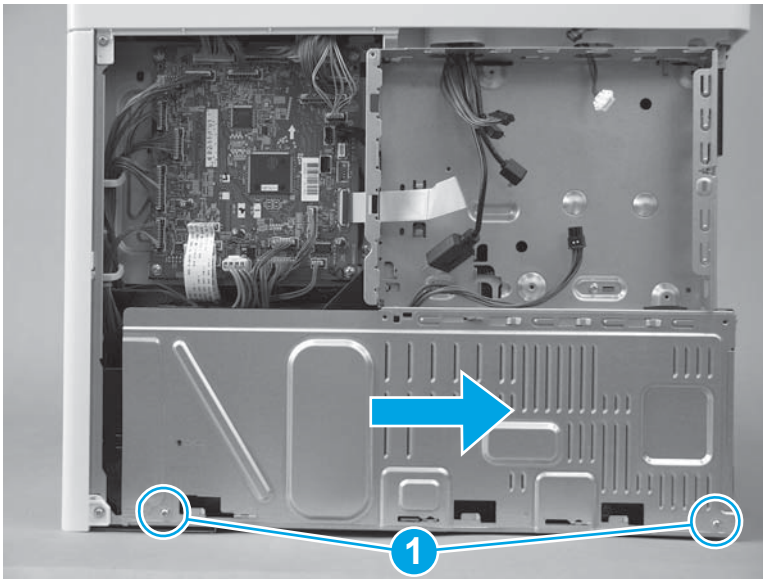

4. Pass two wire harnesses and one flat cable (callout 1) through the opening in the formatter case, and then release one wire harness from the retainer (callout 2).

CAUTION: The flat cable might be attached to the formatter case with double-sided tape. Make sure that this tape is released, so that the flat cable is not damaged when the formatter case is removed.

Figure 1-1493 Release wire harnesses and flat cable

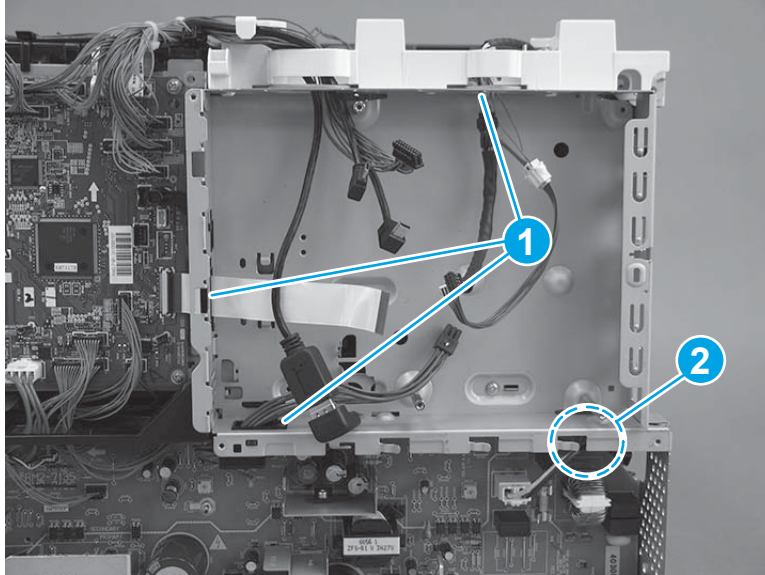

5. Remove six screws (callout 1).

Figure 1-1494 Remove six screws

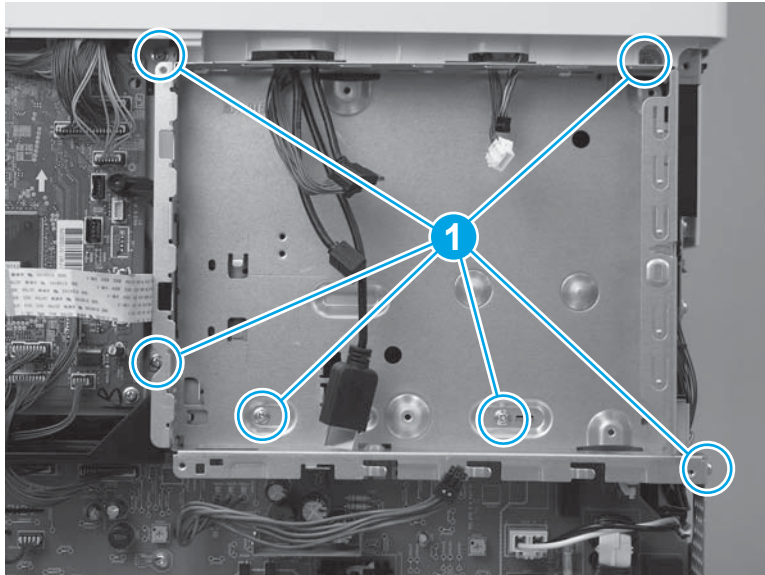

6. Rotate the bottom of the formatter case away from the printer (callout 1), and then pull it down (callout 2) to release it.

Figure 1-1495 Release the formatter case

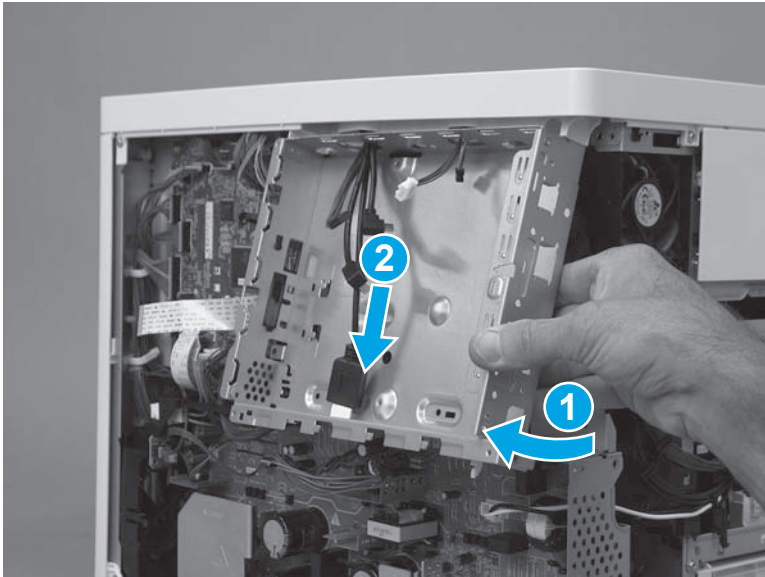

7. Pass the wire harnesses through the opening in the formatter case to remove it.

 **IMPORTANT:** If the formatter case is removed so that it can be replaced, make sure to transfer the memory PCA (island of data) and plastic bracket (callout 1) to the replacement case.

Figure 1-1496 Remove the formatter case



Step 12: Unpack the replacement assembly

Unpack the replacement assembly from the packaging.

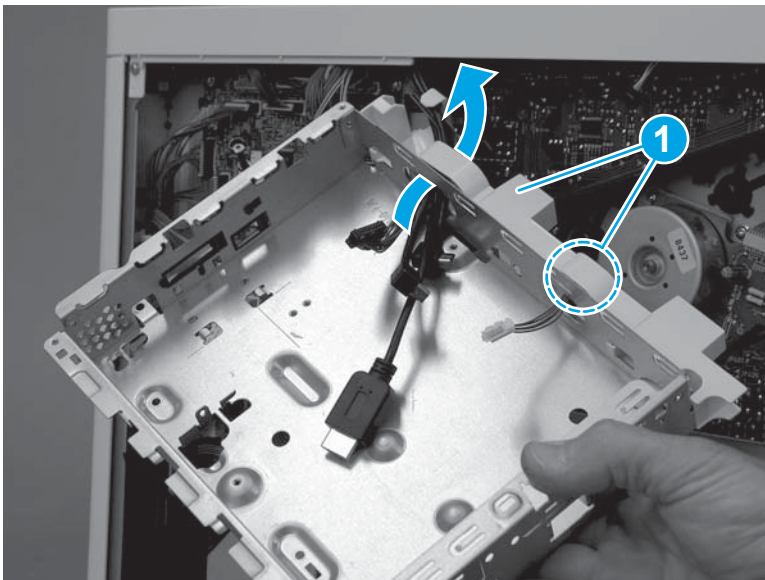
For complete information on HP's recycling programs, go to [Product return and recycling](#).

 **NOTE:** HP recommends responsible disposal of the defective part.

Figure 1-1497 Recycle and unpack

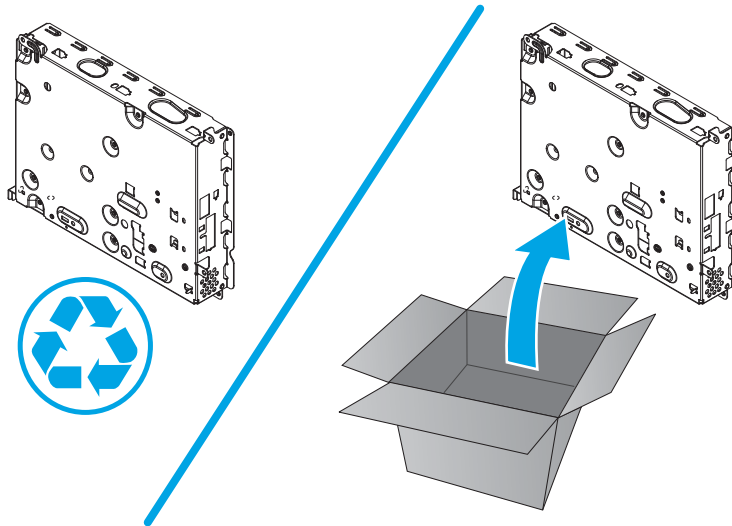

Step 13: Install the formatter case

1. Pass the wire harnesses through the opening in the formatter case.

Figure 1-1498 Pass the wire harnesses through the opening

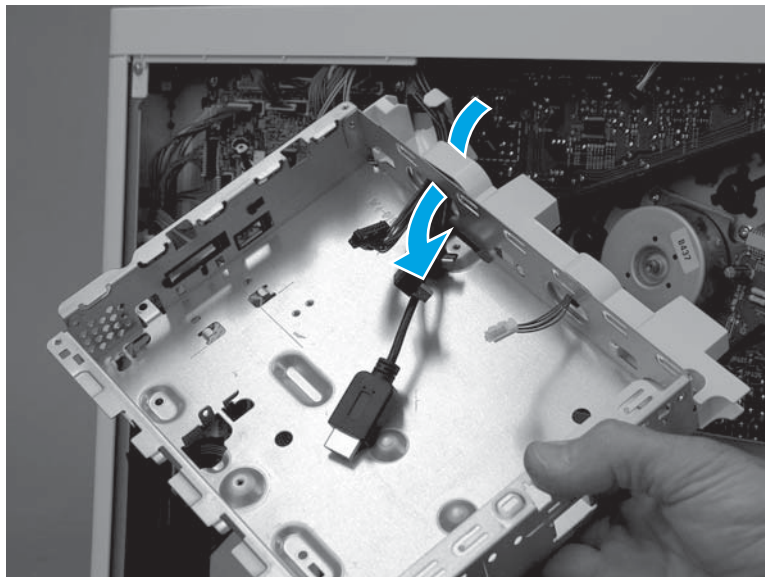

2. Position the top of the formatter case on the printer (callout 1), and then rotate the bottom of the case (callout 2) into the printer.

Figure 1-1499 Install the formatter case

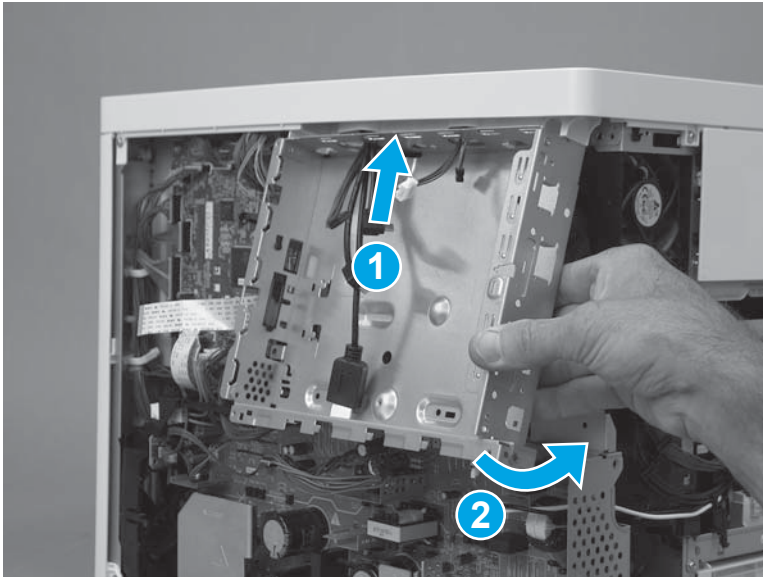

3. Install six screws (callout 1).

Figure 1-1500 Install six screws

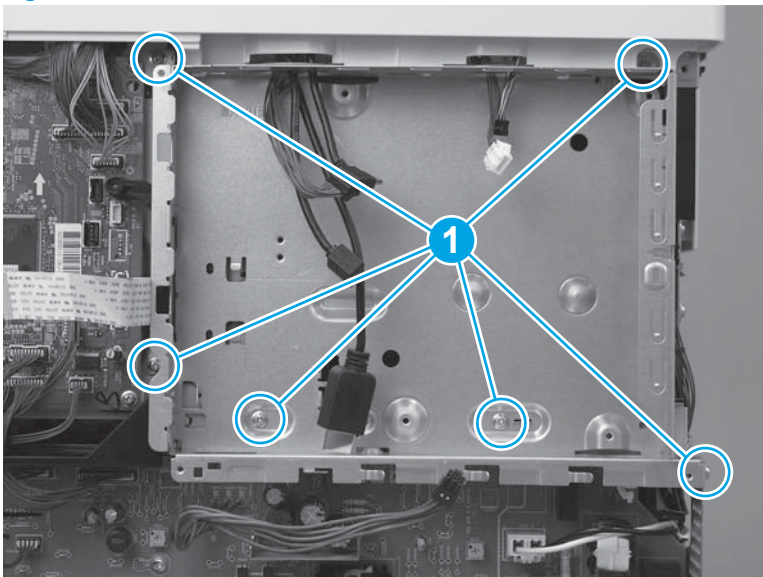

4. Pass two wire harnesses and one flat cable (callout 1) through the opening in the formatter case, and then install one wire harness in the retainer (callout 2).

 **IMPORTANT:** Make sure that the flat cable is securely fastened to the DC controller, and was not dislodged when the formatter case was removed.

Figure 1-1501 Install wire harnesses and flat cable



5. Position the LVPS cover on the printer, slide the cover to the left to install it, and then install two screws (callout 1).

Figure 1-1502 Install the LVPS cover

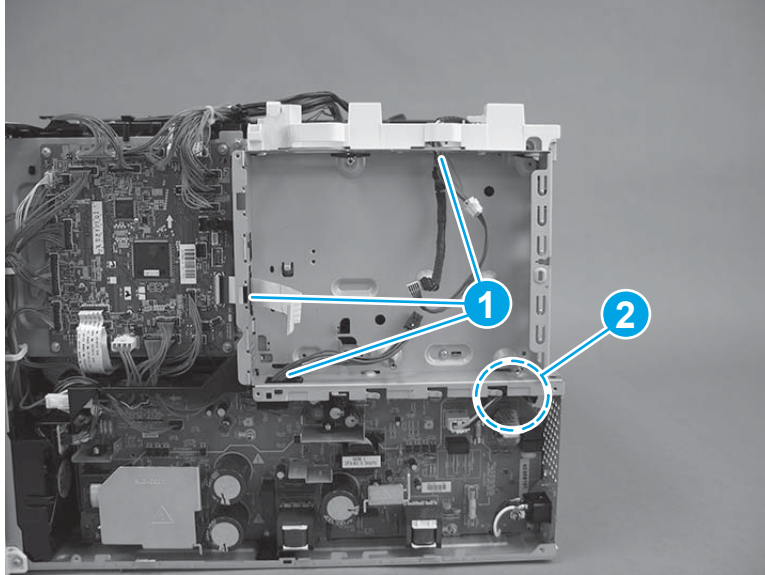
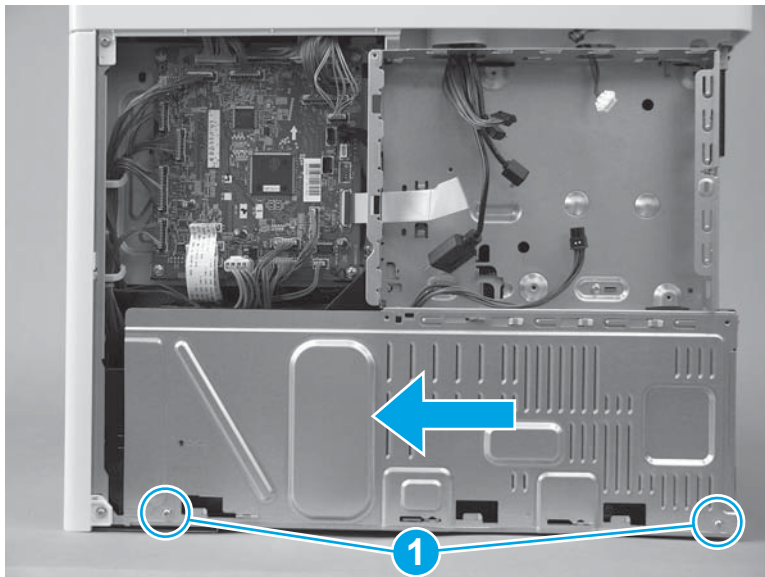

6. If no tape is affixed to the back of the flat cable, skip this step. If double-sided tape is affixed to the back of the flat cable, align the line (callout 1) on the cable with the edge (callout 2) of the opening in the sheet metal. Press to attach the flat cable to the formatter case.

Figure 1-1503 Attach the flat cable

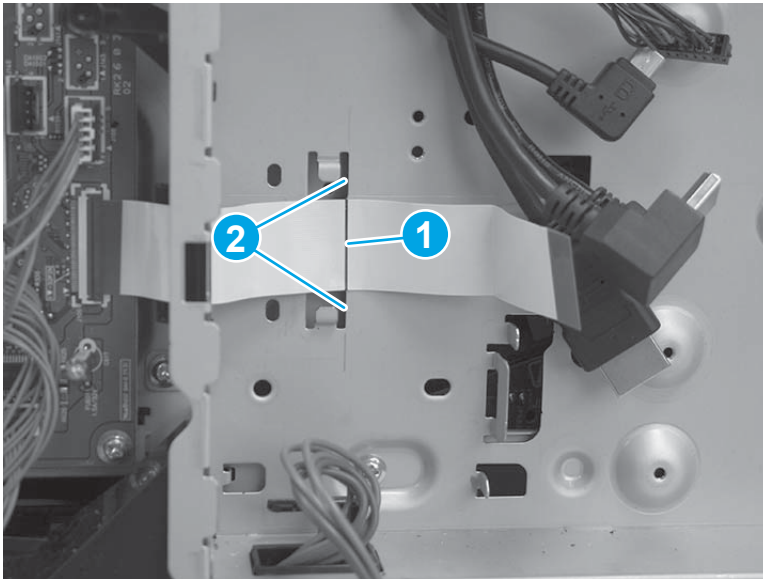

7. Position the bracket over the flat cable, and then slide the bracket to the left to install it. Make sure that the edges of the bracket fit under the sheet metal tabs (callout 1) on the formatter case and that the tabs (callout 2) snap into place.

Figure 1-1504 Position the bracket

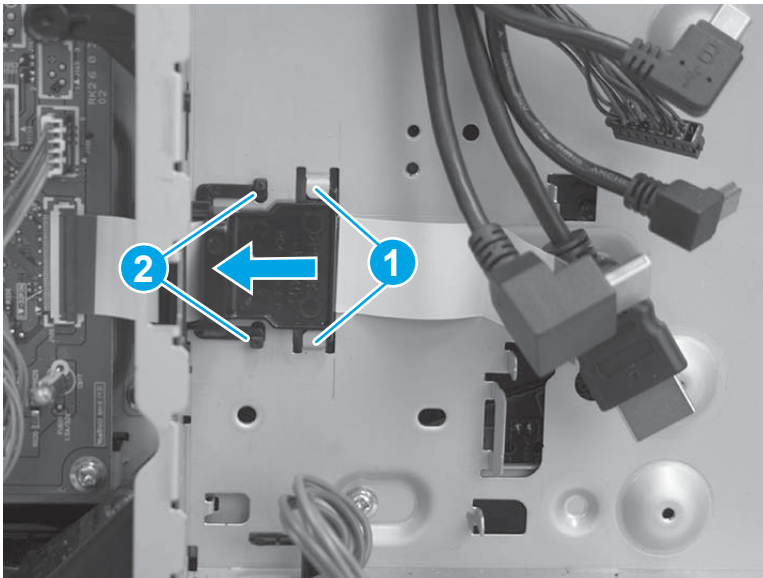

- 8. M577 only:** Pass the wire harness (callout 1) through the openings in the formatter case (callout 2), and then connect one connector (callout 3).

Figure 1-1505 Connect one connector

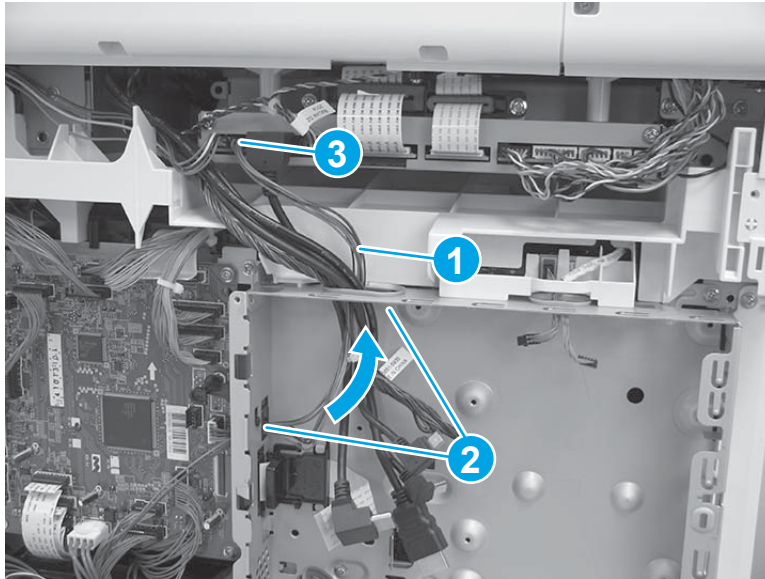

Step 14: Install the left cover

1. Position the cover on the printer.

 **NOTE:** Slightly offset the cover toward the rear of the printer.

Figure 1-1506 Install the cover

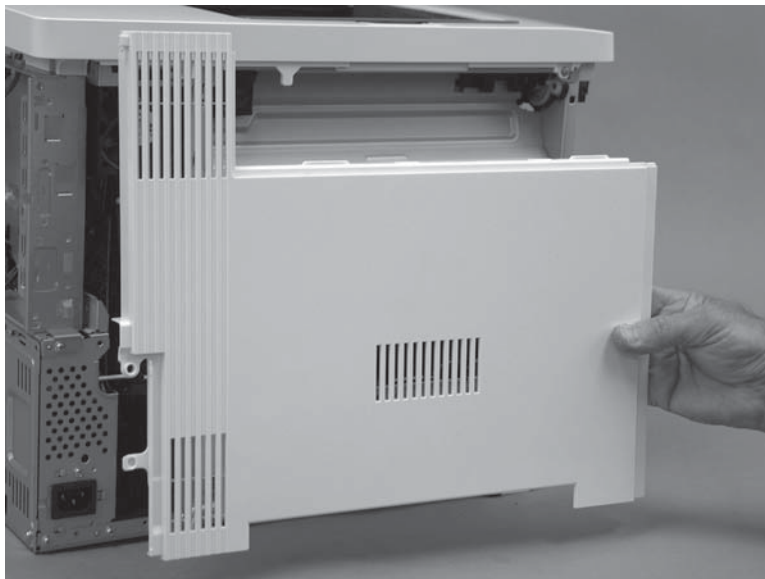

- Slide the cover (callout 1) toward the front of the printer to engage it. Make sure that the tab (callout 2) snaps into place.

 **NOTE:** Locate the alignment pin (callout 3) on the cover from the front door side of the printer, and then make sure that it is fully engaged in the slot in the chassis.

 **TIP:** While sliding the cover into place, push in on the center of the cover (callout 1) to make sure that the hooks on the back of the cover engage with the slots in the chassis.

Figure 1-1507 Engage the cover



- At the left side of the printer, install one screw (callout 1).

Figure 1-1508 Install one screw

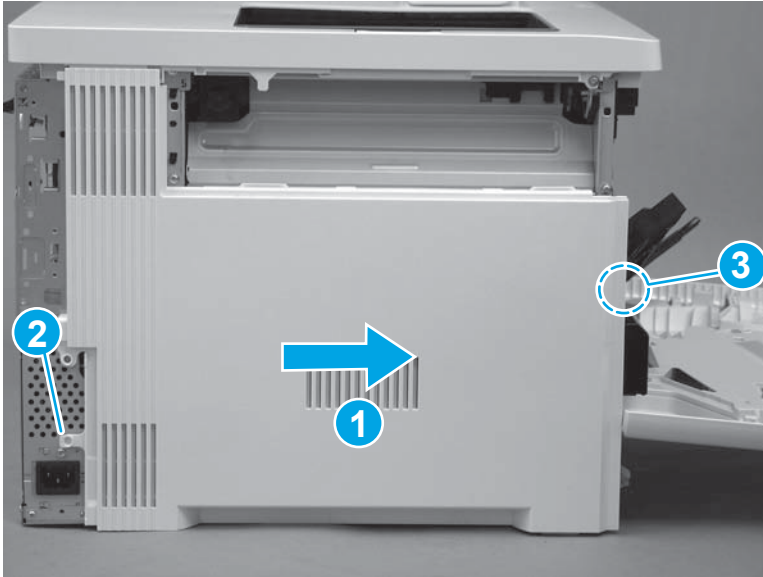

Step 15: Install the rear cover (M577)

 **NOTE:** This step is for the M577 models. For the M552 and M553 models, skip this step and go to [Step 17: Install the rear cover \(M552 and M553\) on page 868](#).

1. Position the hooks (callout 1) on the cover in the slots (callout 2) in the printer.

Figure 1-1509 Position the hooks

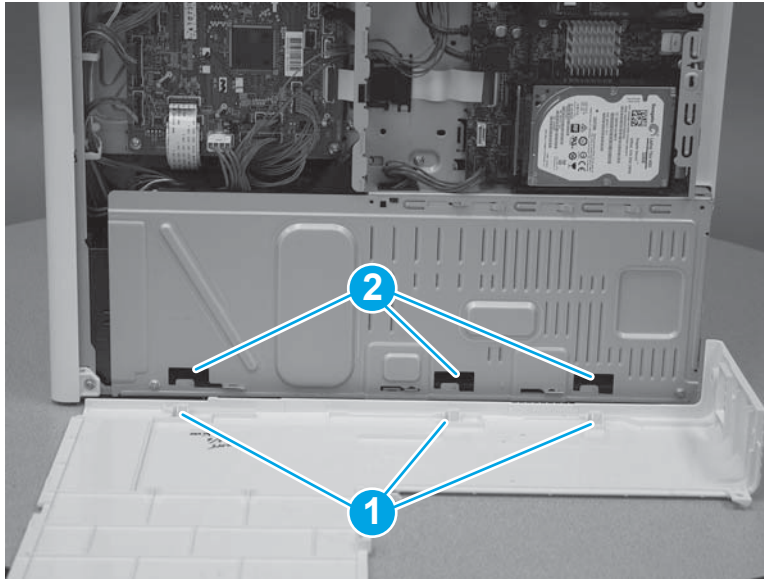

2. Position the back edge (callout 1) of the rear cover behind the edge (callout 2) of the right rear cover. Slide the cover to the left to install it.

Figure 1-1510 Install the cover

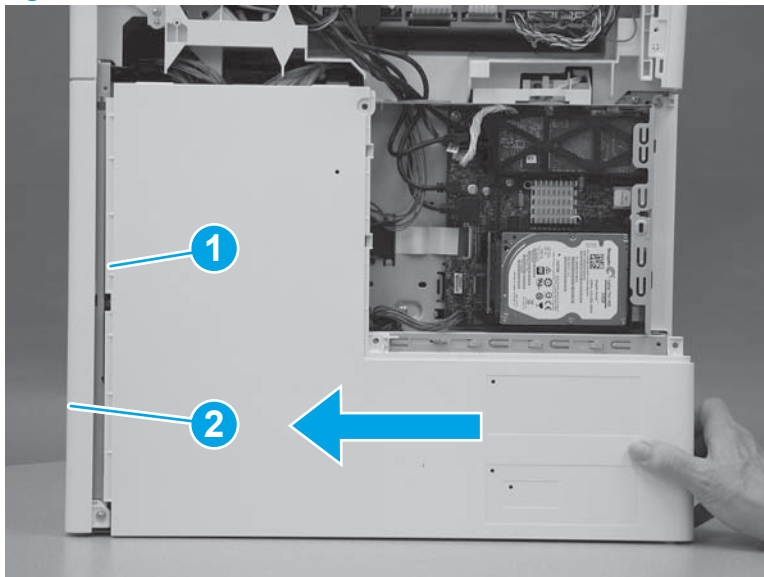

3. Install four screws (callout 1).

Figure 1-1511 Install four screws cover

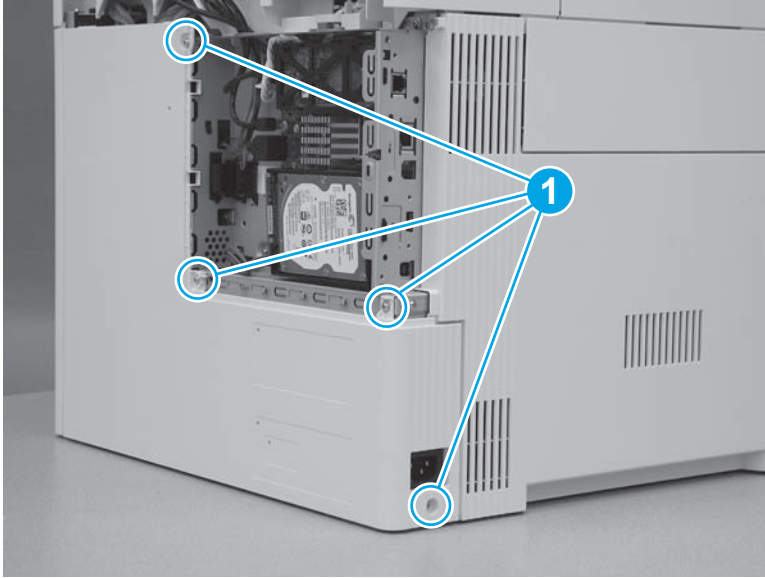

Step 16: Install the rear upper cover (M577)



NOTE: This step is for the M577 models. For the M552 and M553 models, skip this step and go to [Step 17: Install the rear cover \(M552 and M553\) on page 868](#).

1. Align the ridge (callout 1) on the lower edge of the rear upper cover in front of the tabs (callout 2) on the top edge of the rear cover.

Figure 1-1512 Align the cover

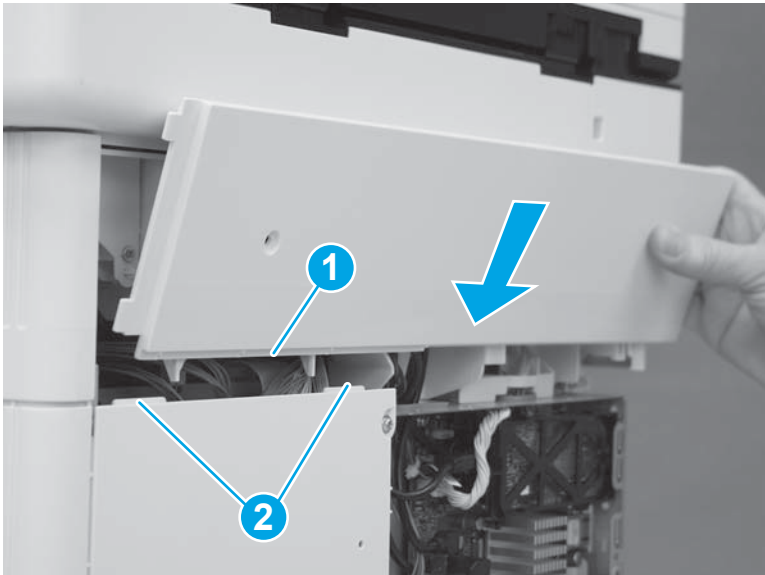

2. Rotate the top of the cover toward the printer.

Figure 1-1513 Rotate the top of the cover

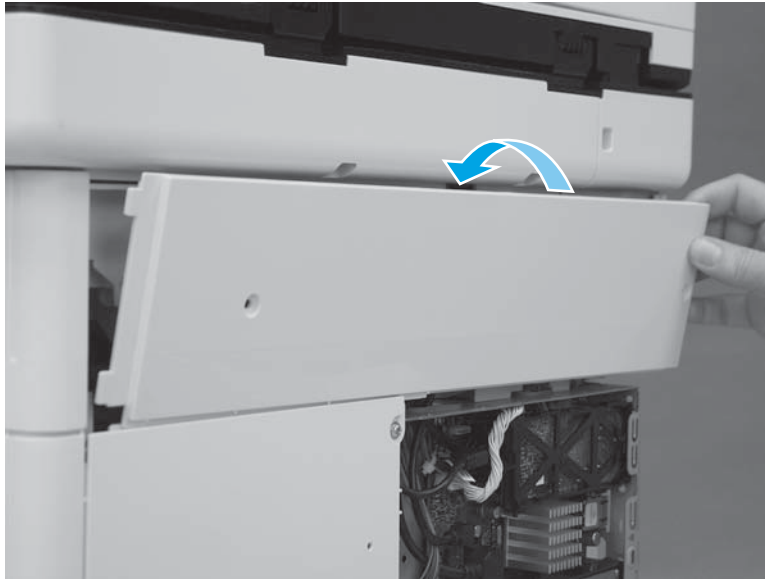

3. Slide the cover to the left (callout 1). Make sure that the tabs (callout 2) on the upper rear cover slide behind the edge (callout 3) of the right upper cover. Make sure that the cover is fully seated.

Figure 1-1514 Slide the cover

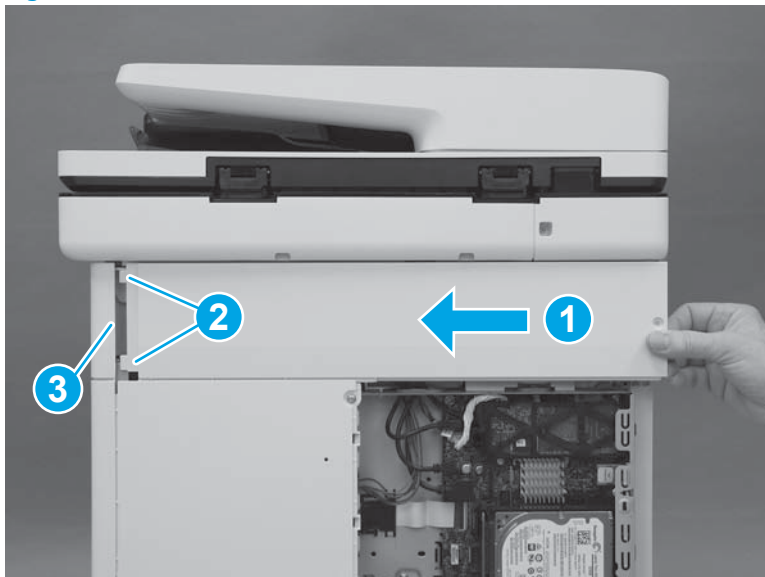

4. Install two screws (callout 1).

 **IMPORTANT:** These two screws are self-tapping screws for plastic. Rotate them counterclockwise to align them with the existing thread pattern, and then carefully turn them clockwise to tighten. Do not overtighten. This will prevent stripping the threads inside the screw holes.

Figure 1-1515 Install two screws



Step 17: Install the rear cover (M552 and M553)

 **NOTE:** This step is for the M552 and M553 models. For the M577 models, skip this step and go to [Step 18: Install the formatter \(M577\) on page 869](#).

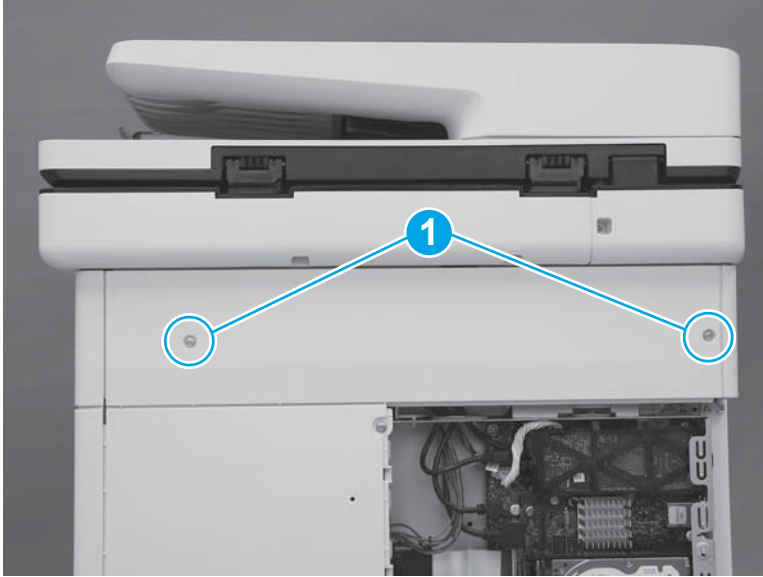
1. Position the top of the cover under the upper cover (callout 1), rotate the bottom of the cover onto the chassis (callout 2), and then slide the cover to the left (callout 3) to install it.

Figure 1-1516 Install the cover

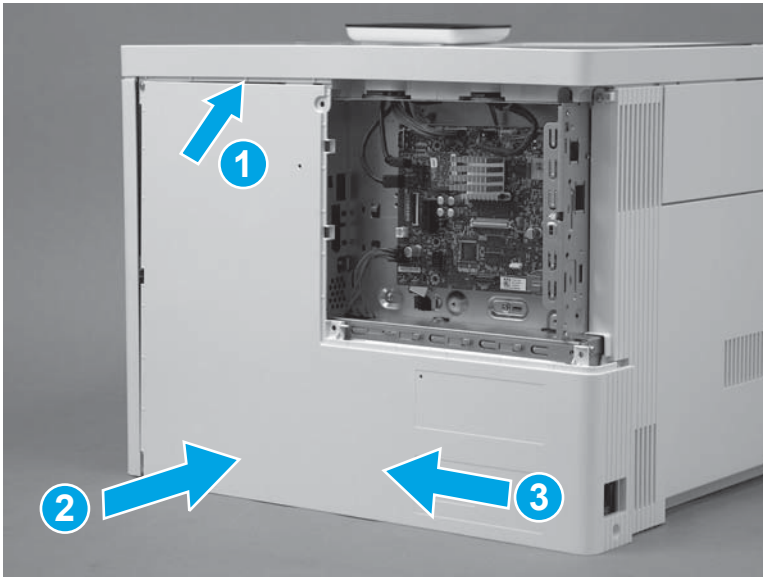

2. Install four screws (callout 1).

Figure 1-1517 Install four screws cover

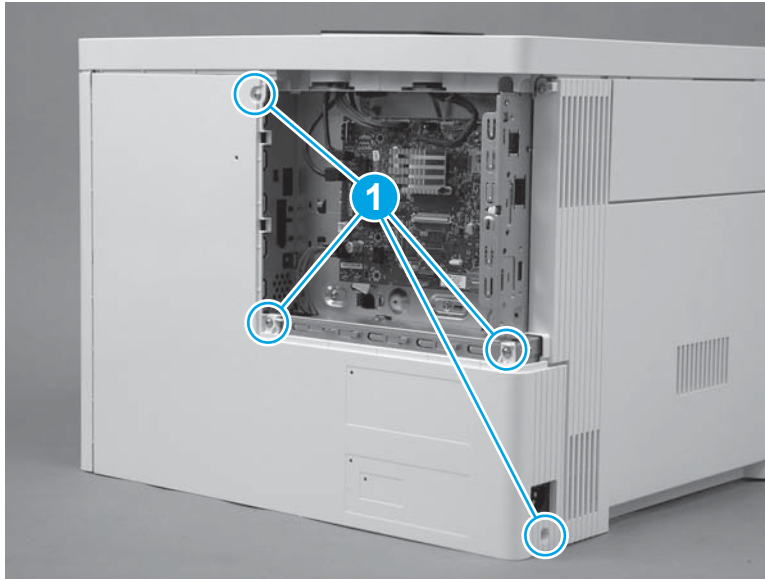

Step 18: Install the formatter (M577)

 **NOTE:** This step is for the M577 models. For the M552 and M553 models, skip this step and to go [Step 21: Install the formatter \(M552 and M553\)](#) on page 874.

 **CAUTION:**  ESD-sensitive part.

1. Position the formatter in the printer. Make sure that the network port (callout 1) fits through the opening (callout 2) in the formatter case.

Figure 1-1518 Install the formatter

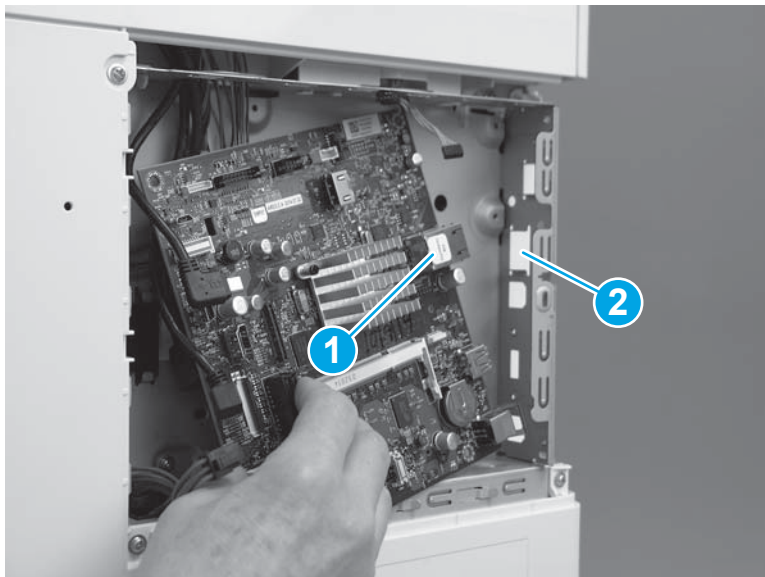

2. Install four screws (callout 1).

Figure 1-1519 Install four screws

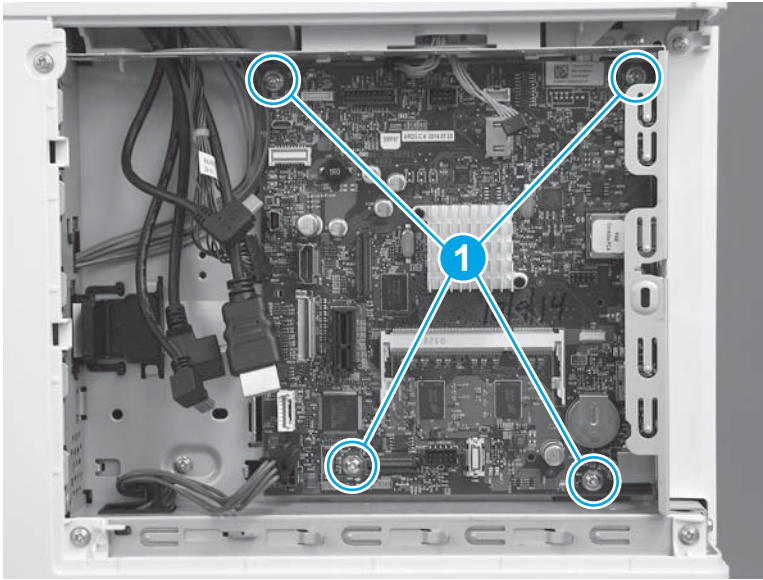

3. Connect all of the connectors on the formatter.

The following connectors are empty:

- All models: J1 (this connector is empty unless the optional DIMM is installed)
- All models: J3
- M577dn: J15 (this is the fax connector for the M577f/z/c models)
- All models: J21 (this connector is empty unless the optional internal USB ports component is installed)
- All models: J23
- All models: J24
- All models: J51
- All models: J57
- All models: J97
- All models: J98 (this connector is empty unless the optional trusted platform module (TPM) is installed)

 **IMPORTANT:** The flat-cable connector (callout 1) is a Zero Insertion Force (ZIF) connector that uses a hinged retainer to secure the flat cable. The hinged retainer must be opened to install the flat cable, and then closed after the cable is installed.

Figure 1-1520 Connect all connectors



Step 19: Install the fax PCA (M577c/f/z)

 **NOTE:** This step is for the M577c/f/z models. For the M577n model, skip this step and go to [Step 20: Install the HDD \(M577\) on page 872](#).

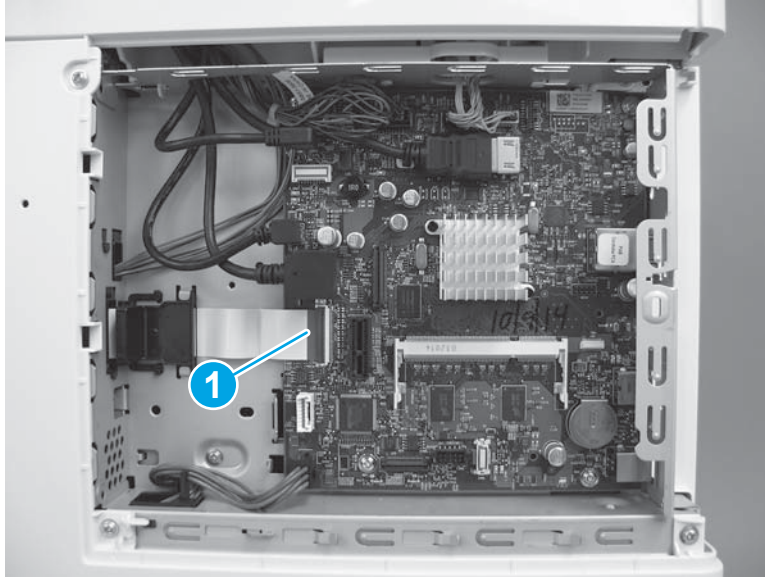
For the M552 and M553 models, skip this step and go to [Step 21: Install the formatter \(M552 and M553\) on page 874](#).

 **CAUTION:**  ESD-sensitive part.

1. Position the tab and telephone port (callout 1) on the fax PCA in the slots (callout 2) in the formatter case.

Figure 1-1521 Position the fax PCA

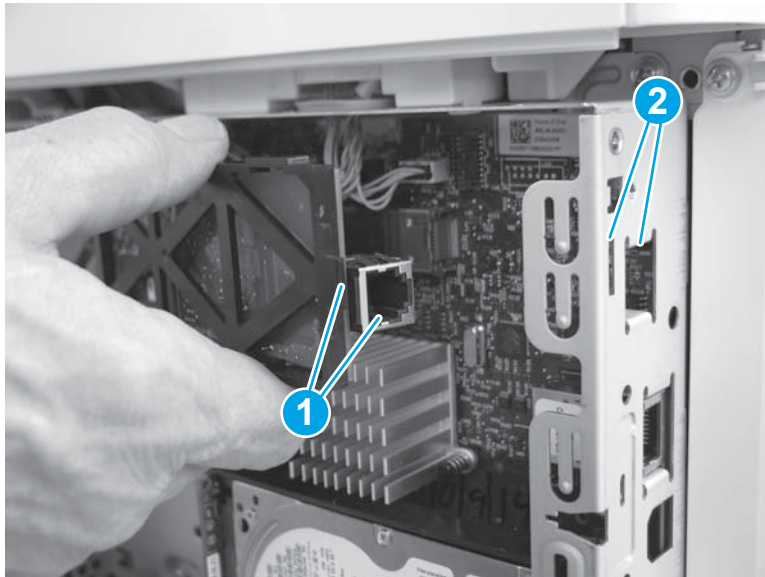

2. Slide the fax PCA to the right (callout 1) until the tab and telephone port described in the previous step and seated in the formatter case. Position the retainer (callout 2) in the slot (callout 3) in the formatter. Rotate the end of the fax PCA toward the formatter (callout 4) until the retainer snaps into place.

Figure 1-1522 Install the fax PCA

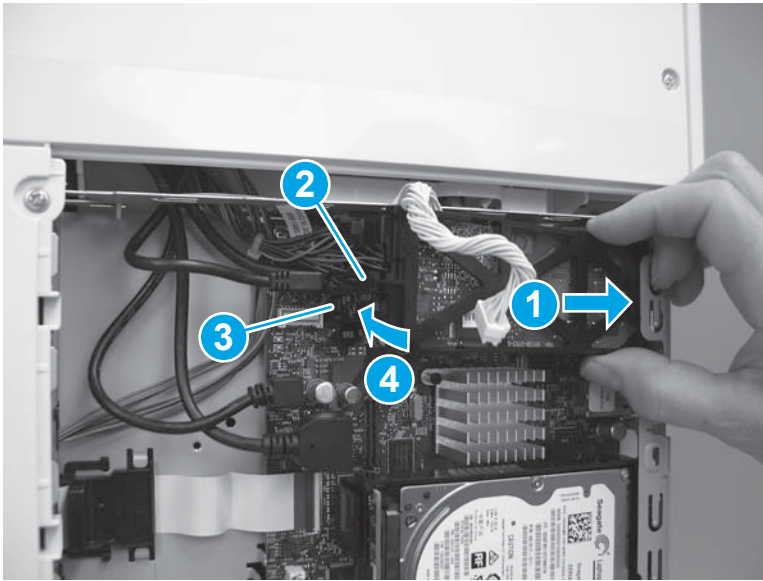

3. Position the cable (callout 1) in the guide (callout 2), and then connect one connector (callout 3).

Figure 1-1523 Connect the connector

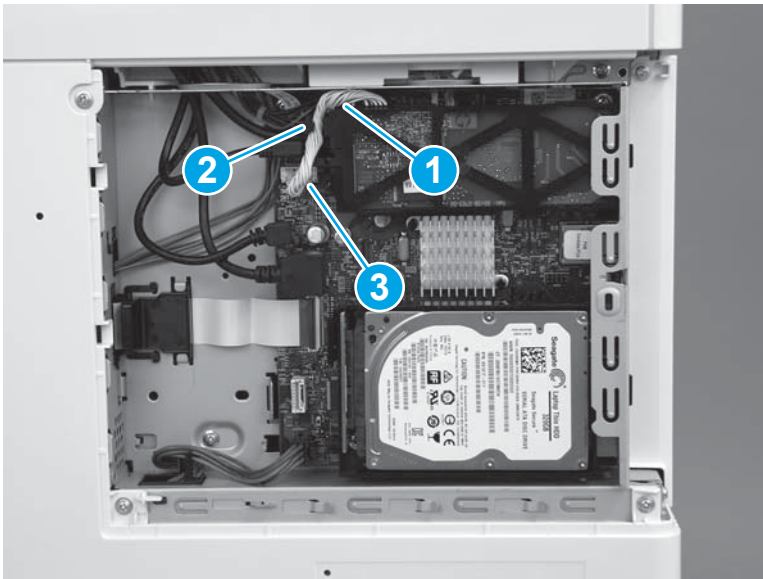

Step 20: Install the HDD (M577)



NOTE: This step is for the M577 models. For the M552 and M553 models, skip this step and go to [Step 21: Install the formatter \(M552 and M553\) on page 874.](#)

 **CAUTION:**  ESD-sensitive part.

1. Align the end of the bracket (callout 1) with the slot in the chassis (callout 2), and then slide the HDD into the printer (callout 3) to engage the bracket with the chassis.

Figure 1-1524 Install the holder

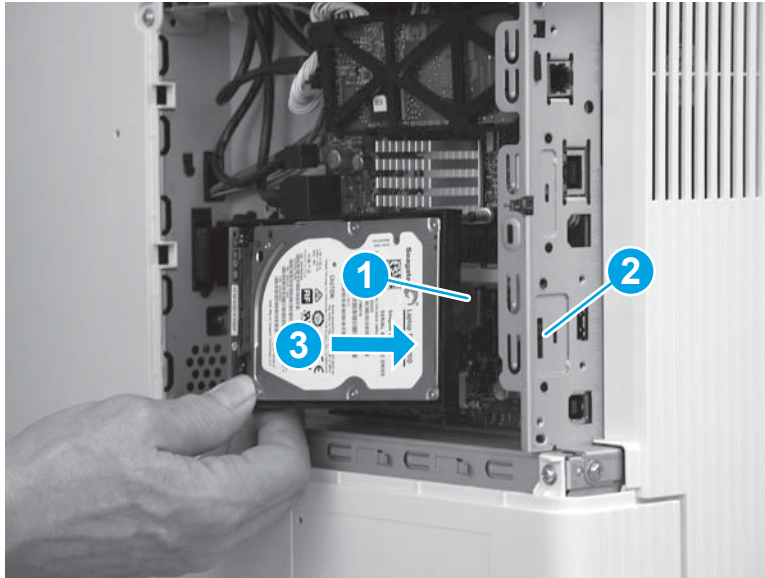

2. Hold the HDD connector latch (callout 1) in the released position, and then rotate the HDD down and into the connector on the formatter to install it.

 **NOTE:** Make sure that the tab (callout 2) snaps into place, and that the HDD is securely installed.

Figure 1-1525 Release the HDD

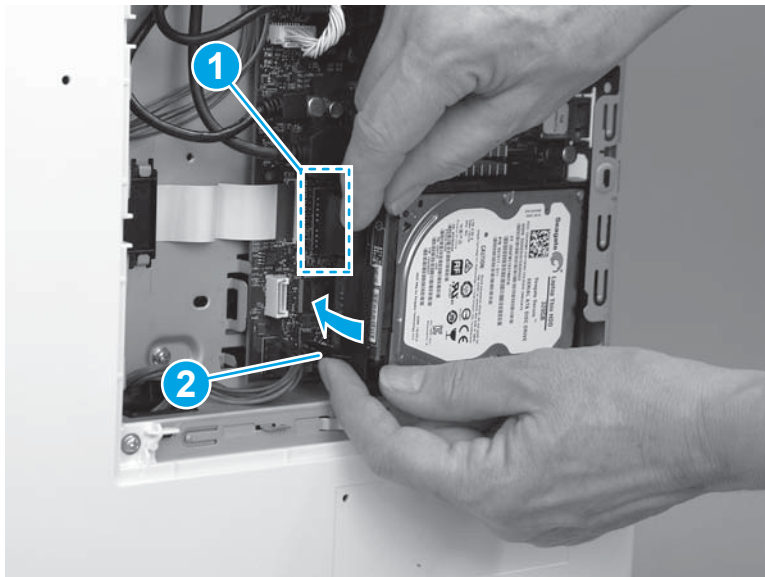

Step 21: Install the formatter (M552 and M553)

 **NOTE:** This step is for the M552 and M553 models. For the M577 models, skip this step and go to [Step 22: Install the formatter cover on page 875](#).

If the optional hard-disk drive (HDD) was removed, do not forget to reinstall it after the formatter is reinstalled.

Engage the HDD holder with the chassis, rotate the HDD connector down and into the connector on the formatter. Make sure that the tabs snap into place.

 **CAUTION:**  ESD-sensitive part.

1. Position the formatter in the printer, and then install four screws (callout 1).

Figure 1-1526 Install the formatter

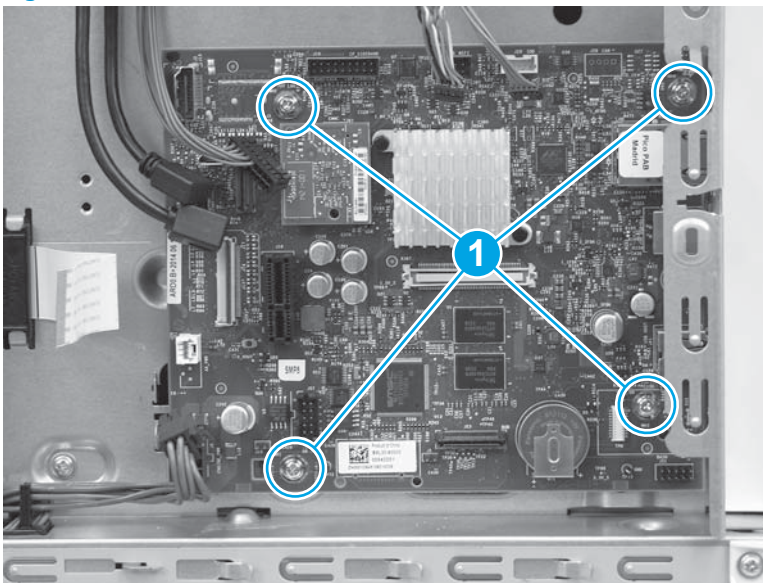

2. Connect all of the connectors on the formatter.

The following connectors are empty:

- All models: J1 (this connector is empty unless the optional DIMM is installed)
- M553n/dn and M552dn: J2 (callout 1; this is the touchscreen connector for the M553x model)
- All models: J9 (this connector is empty unless the optional internal USB ports component is installed)
- All models: J18 (this connector is empty unless the optional hard-disk-drive (HDD) is installed)
- All models: J23
- All models: J24
- M553n/dn and M552dn: J25 (this is the wireless connector for the M553x model)

- All models: J57
- All models: J98 (this connector is empty unless the optional trusted platform module (TPM) is installed)



 **IMPORTANT:** The flat-cable connector (callout 2) is a Zero Insertion Force (ZIF) connector that uses a hinged retainer to secure the flat cable. The hinged retainer must be opened to install the flat cable.

Figure 1-1527 Connect all connectors

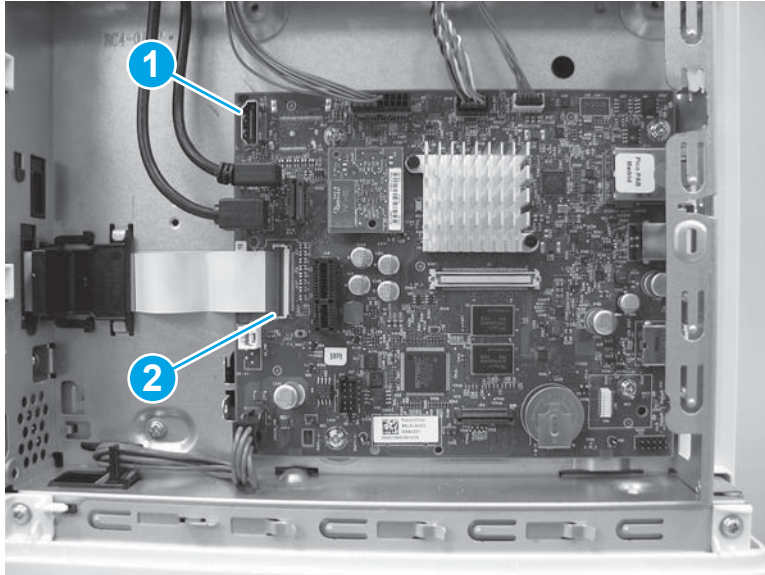

Step 22: Install the formatter cover

- ▲ Slide the cover onto the printer (callout 1) to install it.

 **NOTE:** Make sure that the tabs on the formatter cover align with the slots provided in the printer (callout 2). Tighten the two thumbscrews (callout 3).

 **TIP:** If needed, use the edge of a coin to turn the thumbscrews.

Figure 1-1528 Install the cover



Step 23: Install the TCU

1. Verify that the toner collection hatch cover is in the closed position on the TCU.

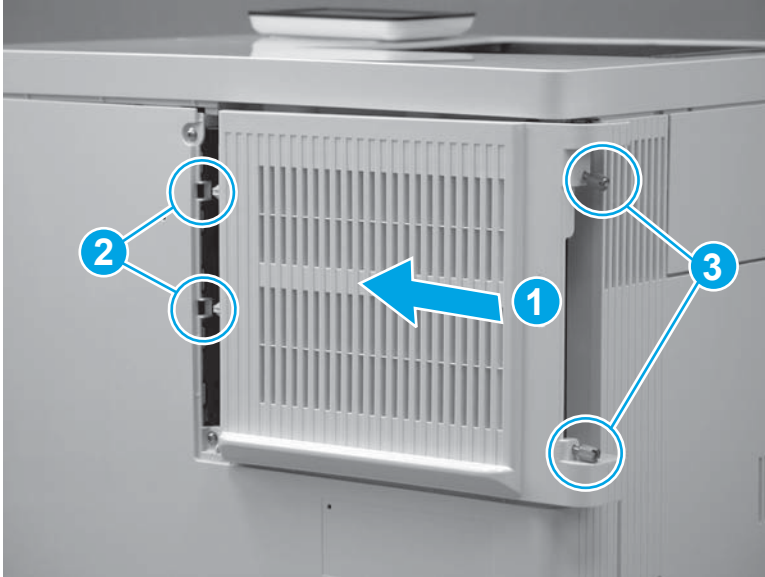
Figure 1-1529 Verify that the toner collection hatch cover is closed

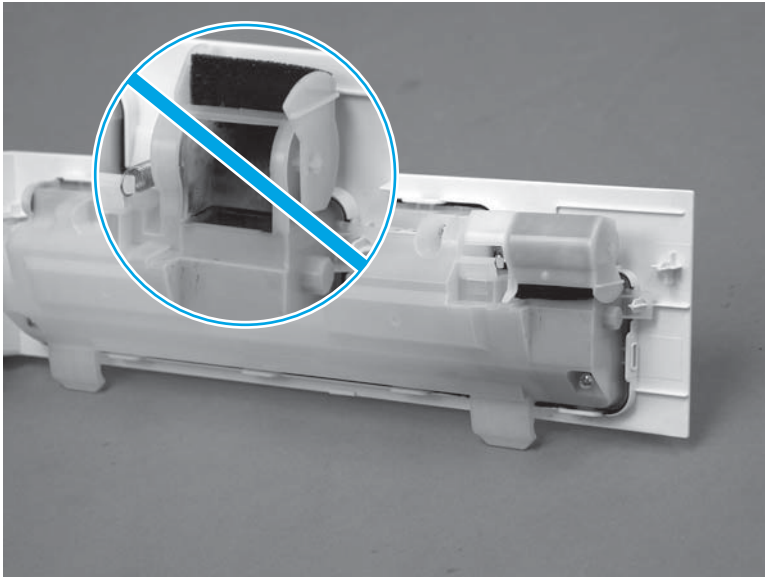

2. Position the TCU with the hinges in the slots provided in the printer (callout 1), and then rotate the TCU up and into the closed position.

 **NOTE:** The toner collection hatch cover automatically opens when the TCU is closed.

Figure 1-1530 Install the TCU



3. Close the front door.

Figure 1-1531 Close the front door

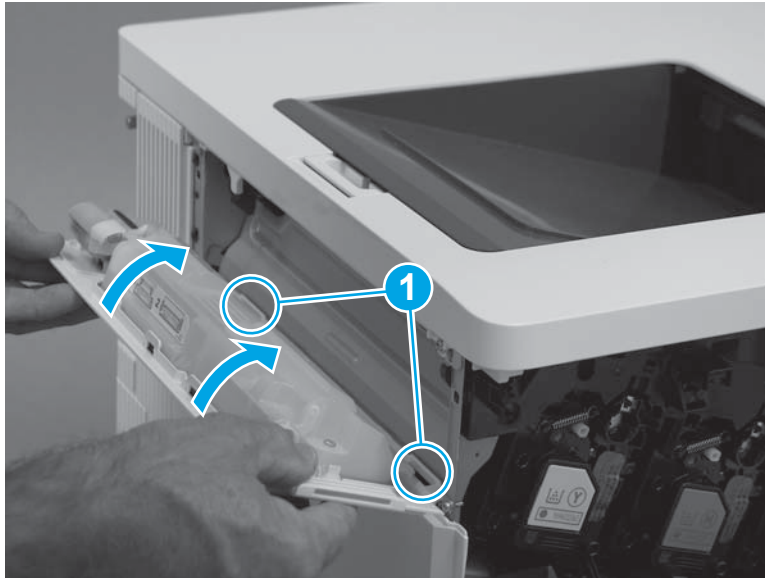

Removal and replacement: Fuser power supply

- [Introduction](#)
- [Step 1: Remove the toner collection unit \(TCU\)](#)
- [Step 2: Remove the formatter cover](#)
- [Step 3: Remove the rear cover \(M552 and M553\)](#)
- [Step 4: Remove the rear upper cover \(M577\)](#)
- [Step 5: Remove the rear cover \(M577\)](#)
- [Step 6: Remove the left cover](#)
- [Step 7: Remove the fuser power supply](#)
- [Step 8: Unpack the replacement assembly](#)
- [Step 9: Install the fuser power supply](#)
- [Step 10: Install the left cover](#)
- [Step 11: Install the rear cover \(M577\)](#)
- [Step 12: Install the rear upper cover \(M577\)](#)
- [Step 13: Install the rear cover \(M552 and M553\)](#)
- [Step 14: Install the formatter cover](#)
- [Step 15: Install the TCU](#)

Introduction

This document provides the procedures to remove and replace the fuser power supply.



Before performing service

Turn the printer power off

- Disconnect the power cable.

 **WARNING!** To avoid damage to the printer, turn the printer off, wait 30 seconds, and then remove the power cord before attempting to service the printer.

- Open the right door.

 **CAUTION:**  This part contains components that are electrostatic discharge (ESD) sensitive. To reduce the possibility of ESD damage, always touch the sheet-metal chassis to ground yourself before touching an ESD sensitive part.

Use the table below to identify the correct part number for your printer, and then go to <http://h20141.www2.hp.com/hpparts> to order the part.

Fuser power supply part number

RM2-7125-000CNFuser power supply

Required tools

- #2 Phillips screwdriver with a magnetic tip

After performing service

Make sure that the TCU is fully closed after replacing it.

Make sure that the formatter cover is fully seated, and that the thumbscrews are finger tight after replacing it.

Turn the printer power on

- Connect the power cable.
- Use the power switch to turn the power on.

Post service test

Print a configuration page to make sure that the printer is functioning correctly.

Step 1: Remove the toner collection unit (TCU)

1. Open the front door.

Figure 1-1532 Open the front door



2. Open the TCU.

 **NOTE:** The toner collection hatch cover automatically closes when the TCU is opened.

Figure 1-1533 Open the TCU



3. Pull the TCU away from the printer at an angle to remove it.

⚠ CAUTION: Do not open the toner collection hatch cover when handling the TCU. If toner gets on clothing, wipe it off by using a dry cloth and wash the clothes in cold water. Hot water sets toner into fabric.

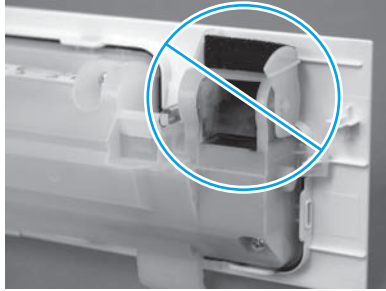
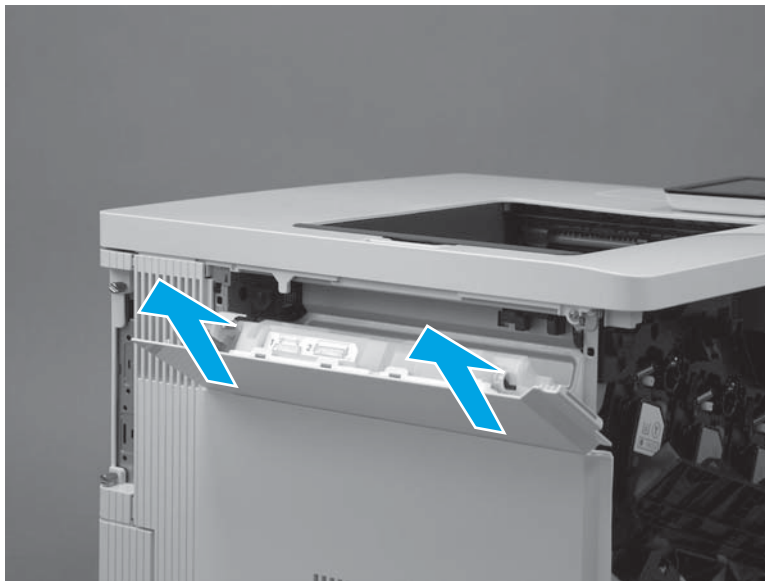

Figure 1-1534 Remove the TCU



Step 2: Remove the formatter cover

1. Locate the formatter cover.

Figure 1-1535 Locate the formatter cover

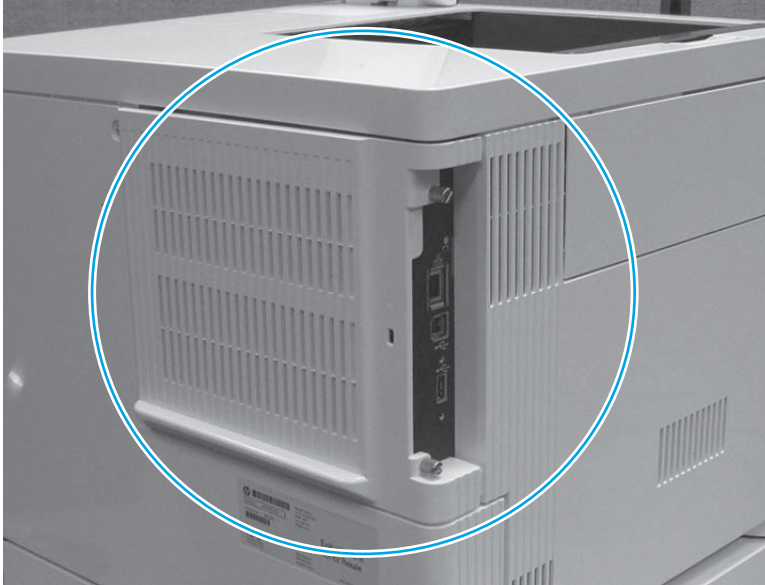

2. Loosen the two thumbscrews (callout 1). Grasp the two thumbscrews, and then slide the cover away from the printer (callout 2) to remove it.



 **TIP:** If needed, use the edge of a coin to turn the thumbscrews.

Figure 1-1536 Loosen the thumbscrews

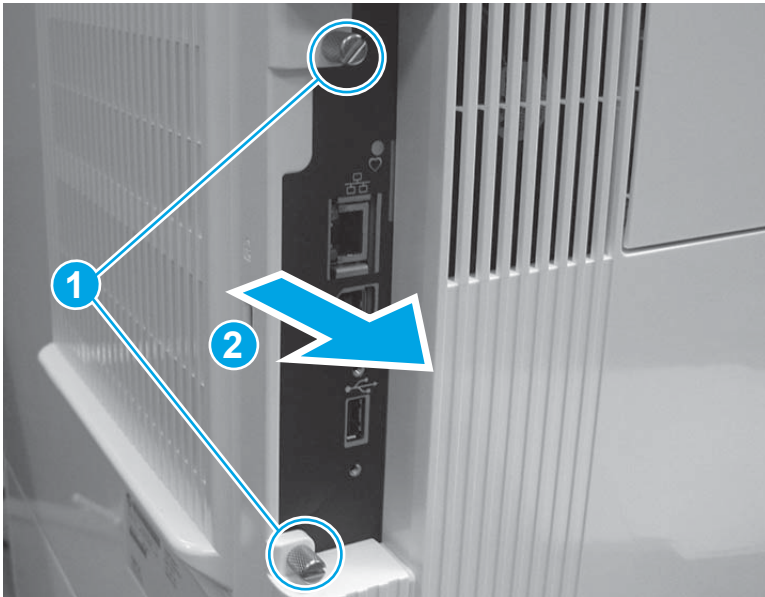

Step 3: Remove the rear cover (M552 and M553)

 **NOTE:** This step is for the M552 and M553 models. For the M577 models, skip this step and go to [Step 4: Remove the rear upper cover \(M577\) on page 883](#).

1. Remove four screws (callout 1).

Figure 1-1537 Remove four screws

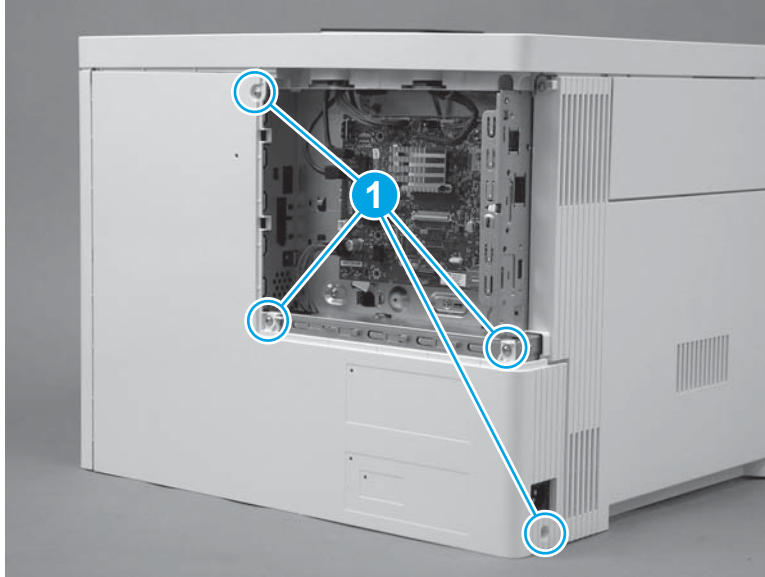

2. Slightly slide the cover to the right (callout 1), rotate the bottom of the cover away from the printer (callout 2), and then pull the top of the cover away from the printer (callout 3) to remove the cover.

Figure 1-1538 Remove the cover

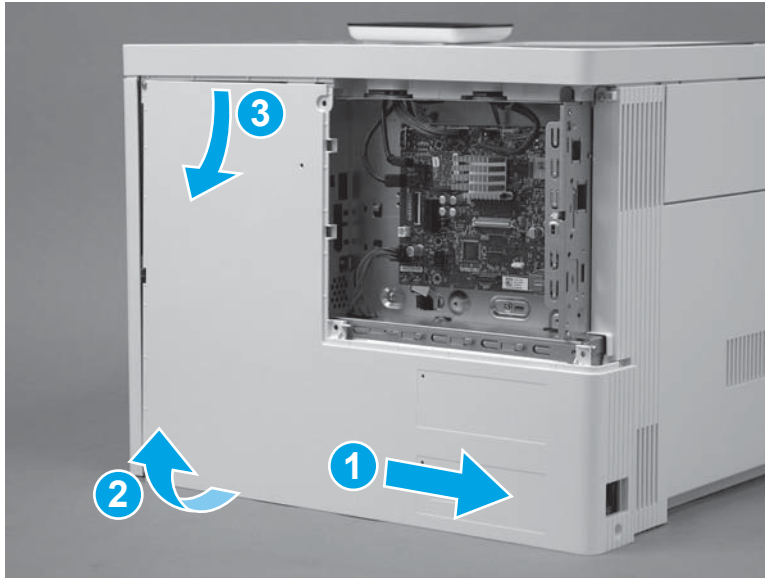

Step 4: Remove the rear upper cover (M577)



NOTE: This step is for the M577 models. For the M552 and M553 models, skip this step and go to [Step 6: Remove the left cover on page 886](#).

1. Remove two screws (callout 1).



Reinstallation tip: These two screws are self-tapping screws for plastic. When reinstalling them, rotate the screws counterclockwise to align them with the existing thread pattern, and then carefully turn them clockwise to tighten. Do not overtighten. This will prevent stripping the threads inside the screw holes.

Figure 1-1539 Remove two screws

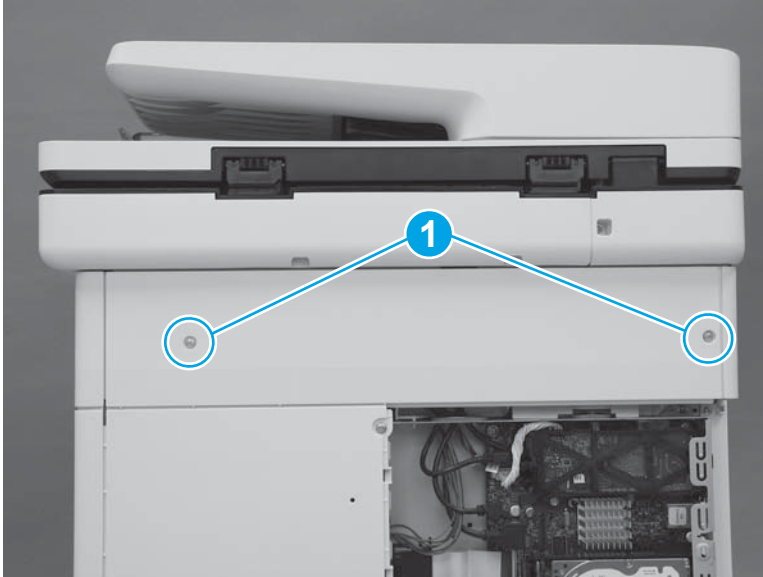

2. Use a small, flat blade screwdriver to release the right edge of the cover.

Figure 1-1540 Release the right edge

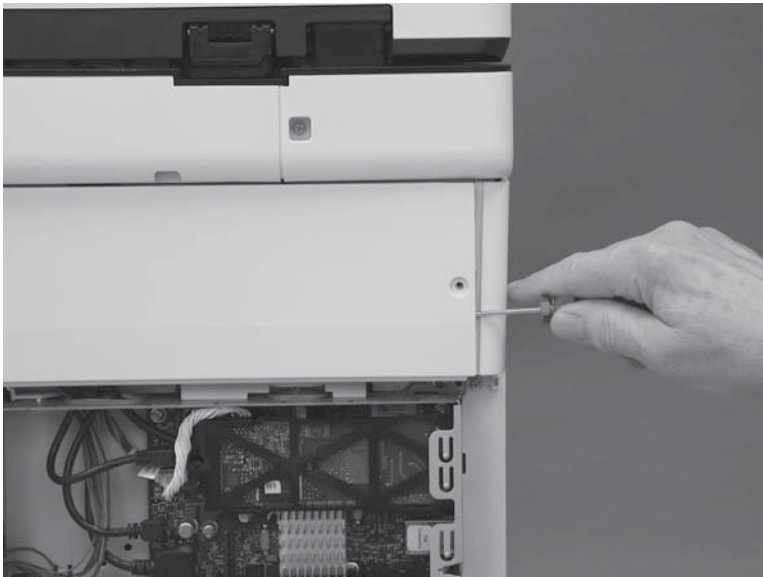

3. Pull the right edge of the cover (callout 1) away from the printer, and then slide the cover to the right (callout 2).

Figure 1-1541 Slide the cover right

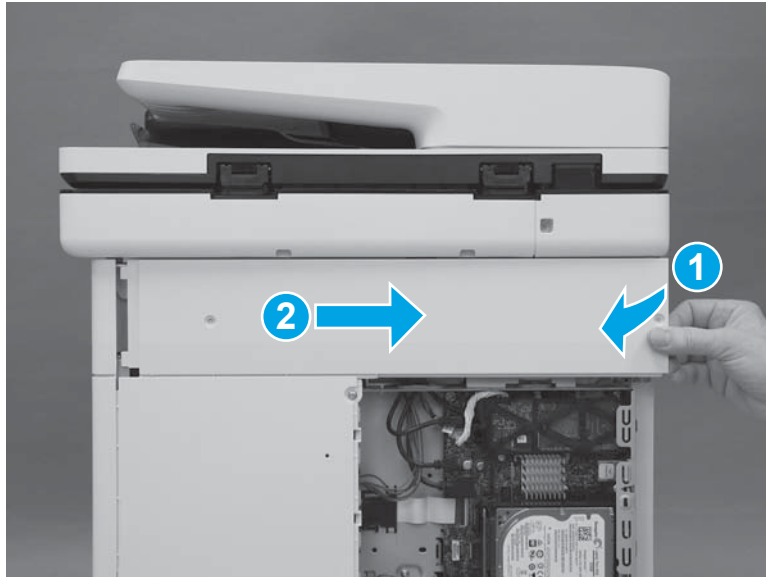

4. Remove the cover.

Figure 1-1542 Remove the cover

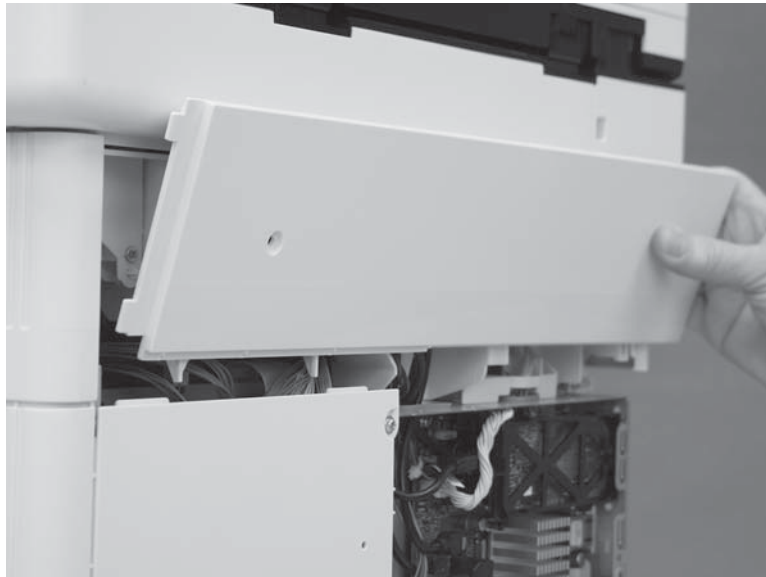

Step 5: Remove the rear cover (M577)

 **NOTE:** This step is for the M577 models. For the M552 and M553 models, skip this step and go to [Step 6: Remove the left cover on page 886](#).

1. Remove four screws (callout 1).

Figure 1-1543 Remove four screws

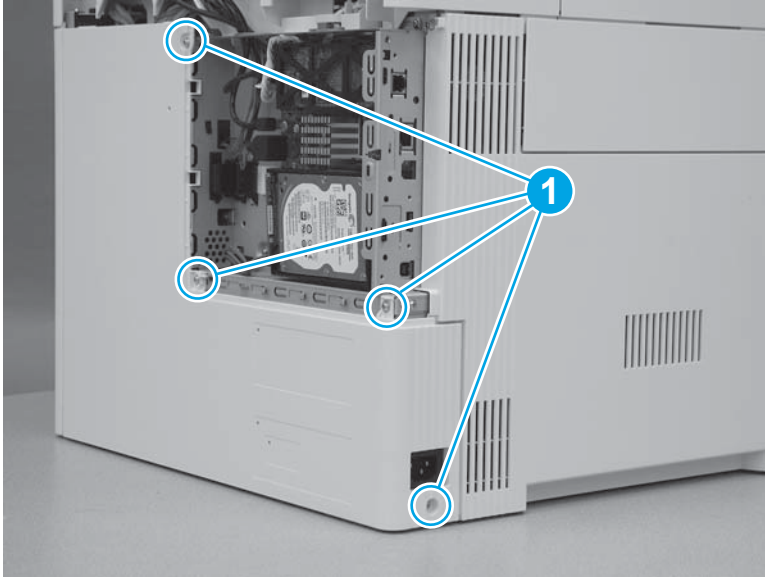

2. Slide the cover to the right to remove it.

Figure 1-1544 Remove the cover

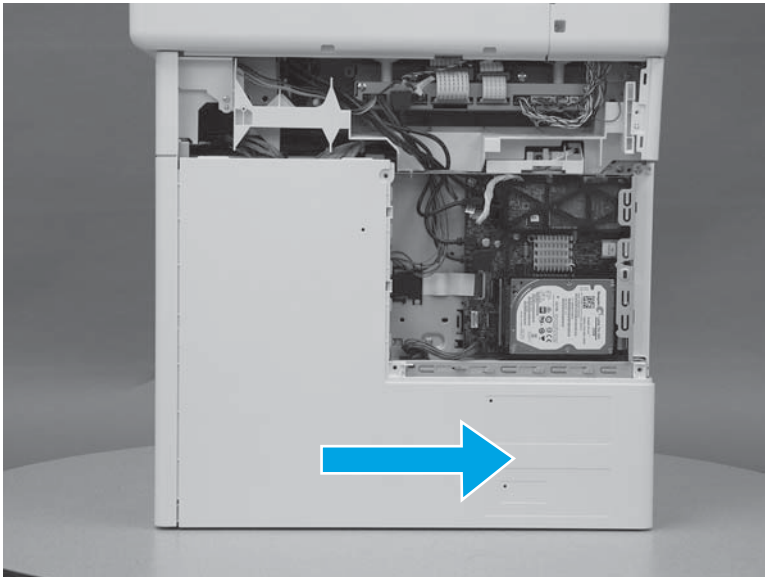

Step 6: Remove the left cover

1. At the left side of the printer, remove one screw (callout 1).

Figure 1-1545 Remove one screw



2. Release one tab (callout 1), rotate the front edge of the cover away from the printer (callout 2), and then slide the cover (callout 3) toward the rear of the printer to release it.

Figure 1-1546 Release the cover

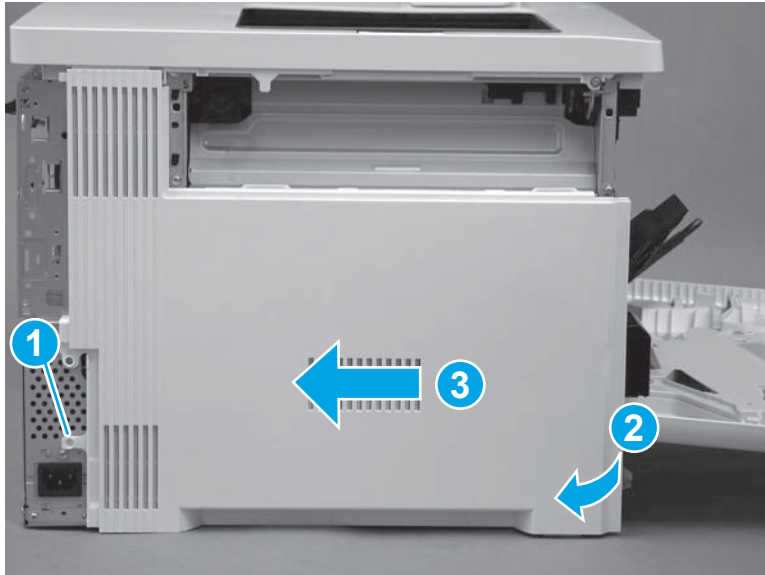

3. Remove the cover.

Figure 1-1547 Remove the cover

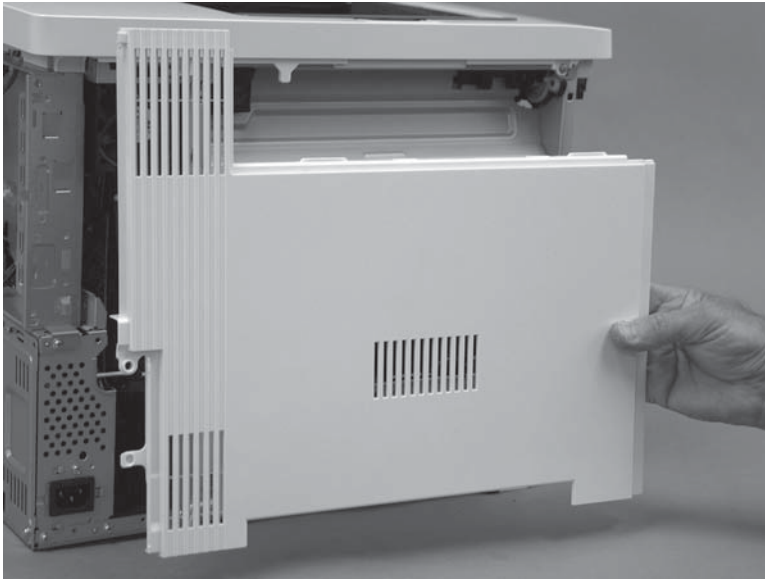

Step 7: Remove the fuser power supply

1. Remove two screws (callout 1), and then slide the low-voltage power supply (LVPS) cover to the right to remove it.

Figure 1-1548 Remove the LVPS cover

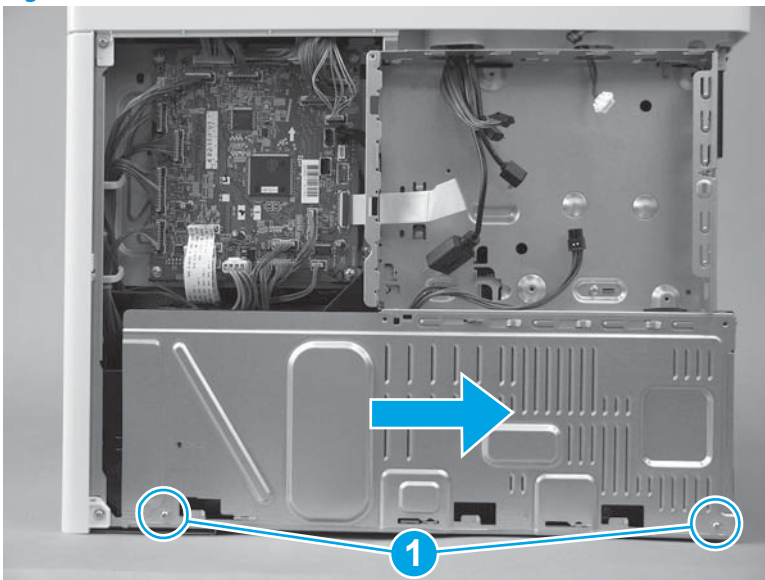

2. Disconnect one connector (callout 1).

Figure 1-1549 Disconnect one connector

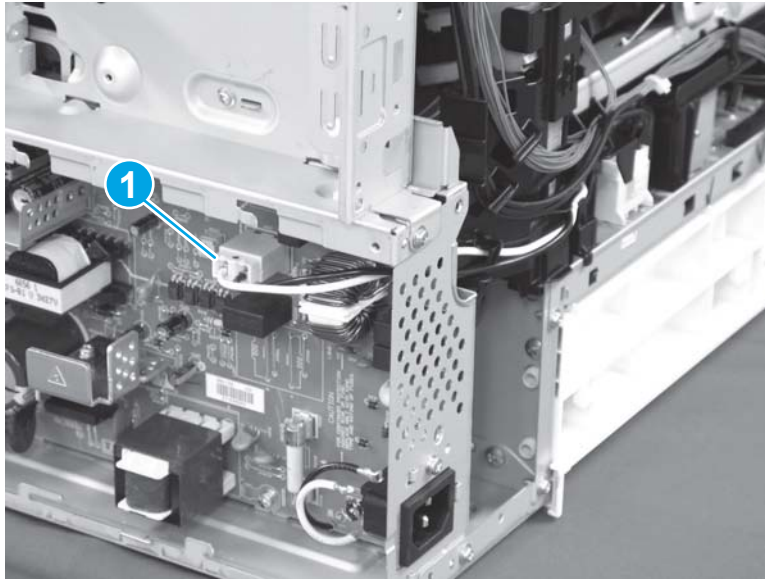

3. Pass the wire harness through the opening in the chassis.

Figure 1-1550 Pass the wire harness through the opening

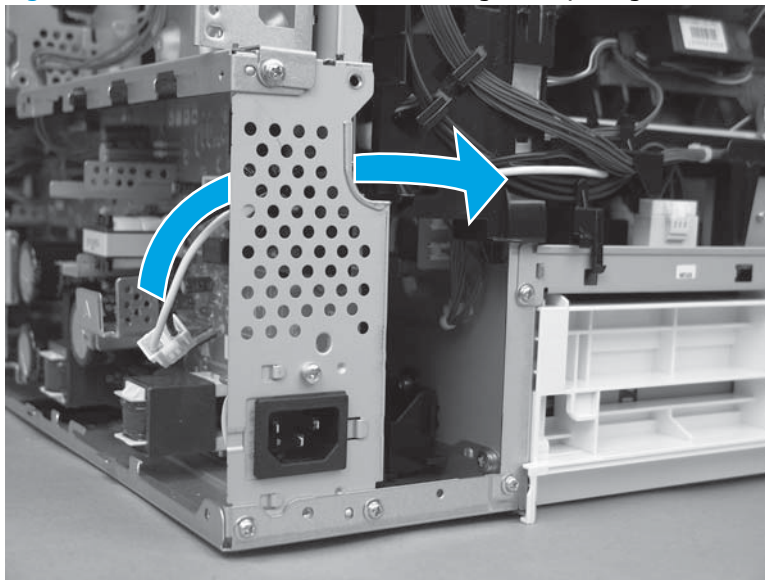

4. Disconnect three connectors (callout 1).

Figure 1-1551 Disconnect three connectors

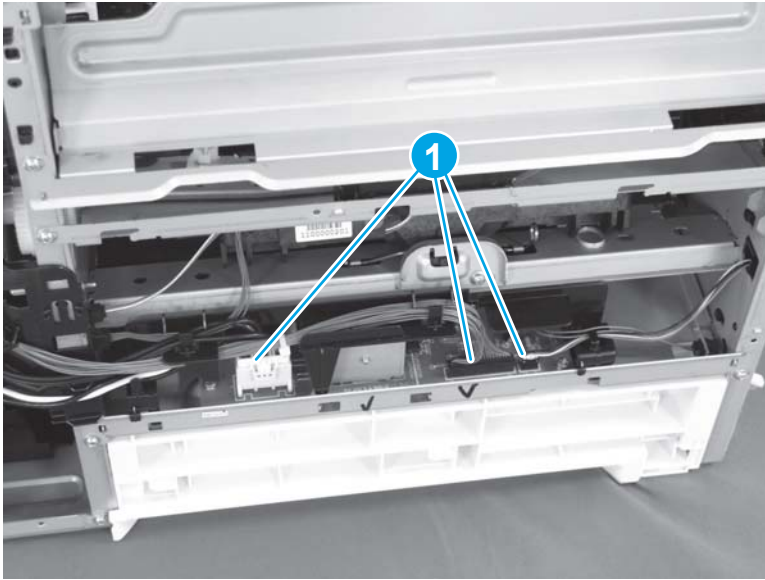

5. Remove two screws (callout 1), and then remove the fuser power supply (callout 2).

Figure 1-1552 Remove the fuser power supply

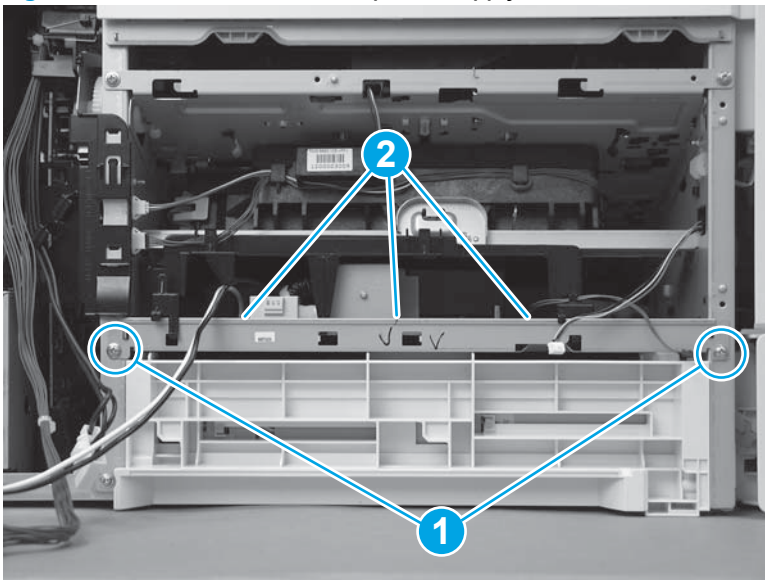

Step 8: Unpack the replacement assembly

Unpack the replacement assembly from the packaging.

 **CAUTION:**  ESD-sensitive part.

For complete information on HP's recycling programs, go to [Product return and recycling](#).

 **NOTE:** HP recommends responsible disposal of the defective assembly.

Figure 1-1553 Recycle and unpack



Step 9: Install the fuser power supply

1. Position the fuser power supply (callout 1) in the printer, and then install two screws (callout 2).

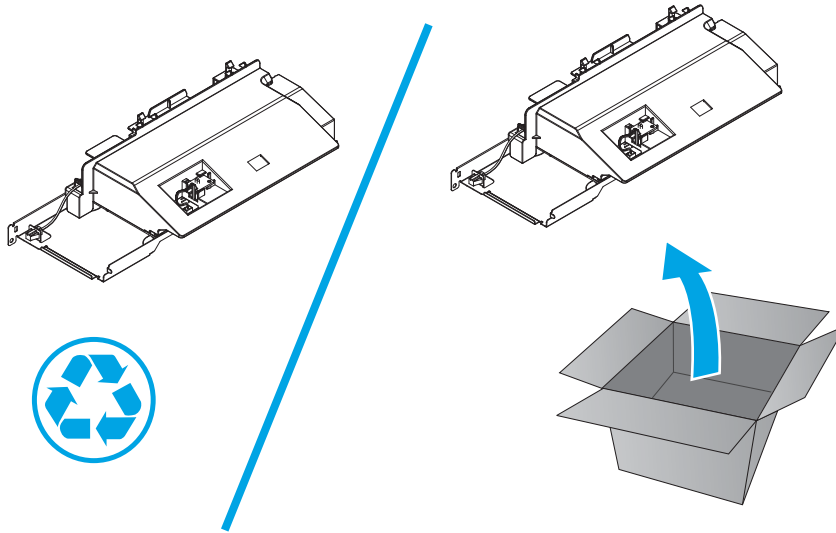
Figure 1-1554 Remove the fuser power supply

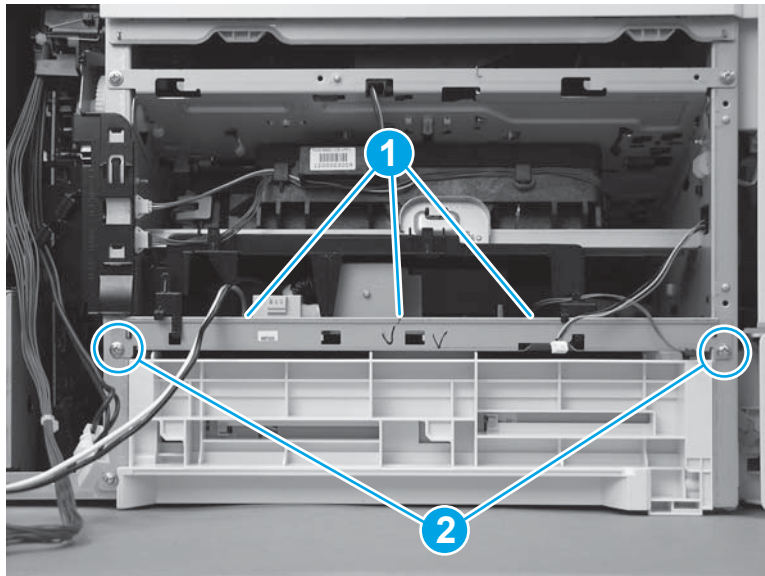

2. Connect three connectors (callout 1).

Figure 1-1555 Connect three connectors

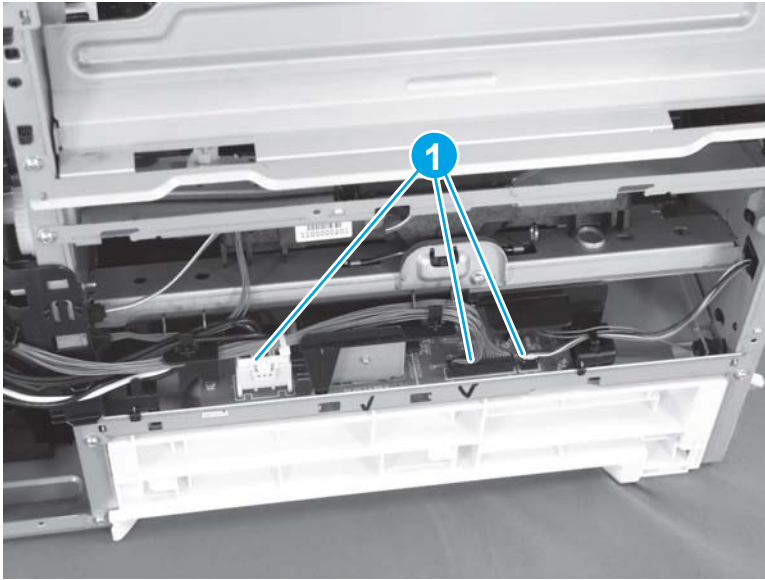

3. Pass the wire harness through the opening in the chassis.

Figure 1-1556 Pass the wire harness through the opening

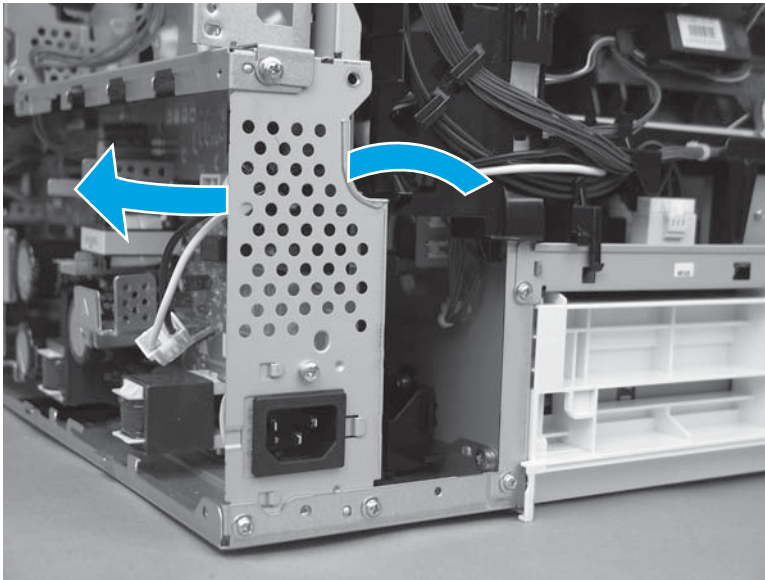

4. Connect one connector (callout 1).

Figure 1-1557 Connect one connector

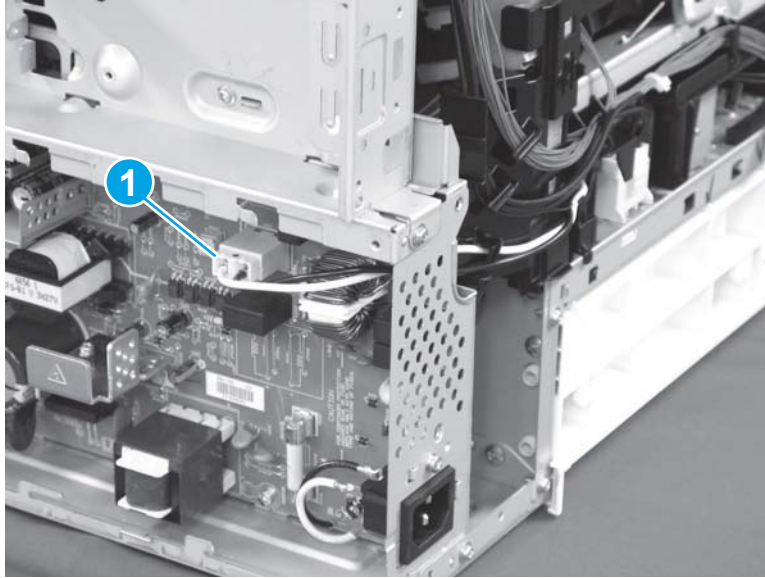

5. Position the LVPS cover on the printer, slide the cover to the left to install it, and then install two screws (callout 1).

Figure 1-1558 Install the LVPS cover

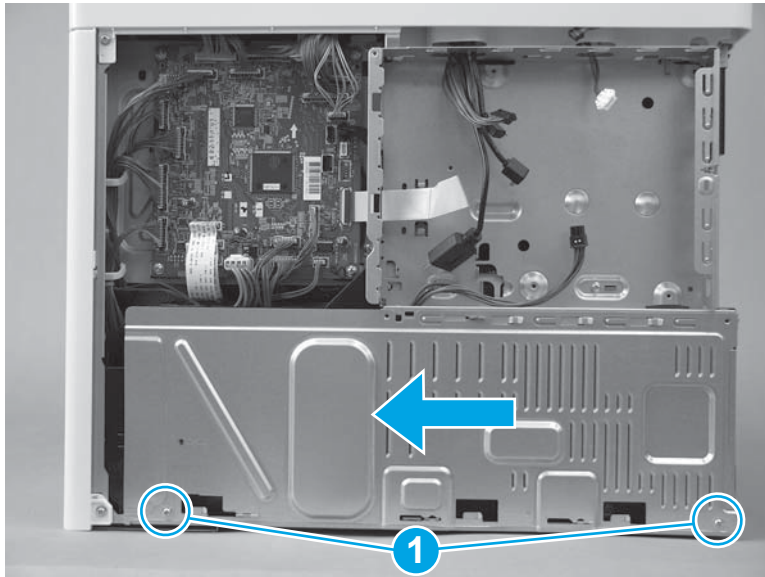

Step 10: Install the left cover

1. Position the cover on the printer.

 **NOTE:** Slightly offset the cover toward the rear of the printer.

Figure 1-1559 Install the cover

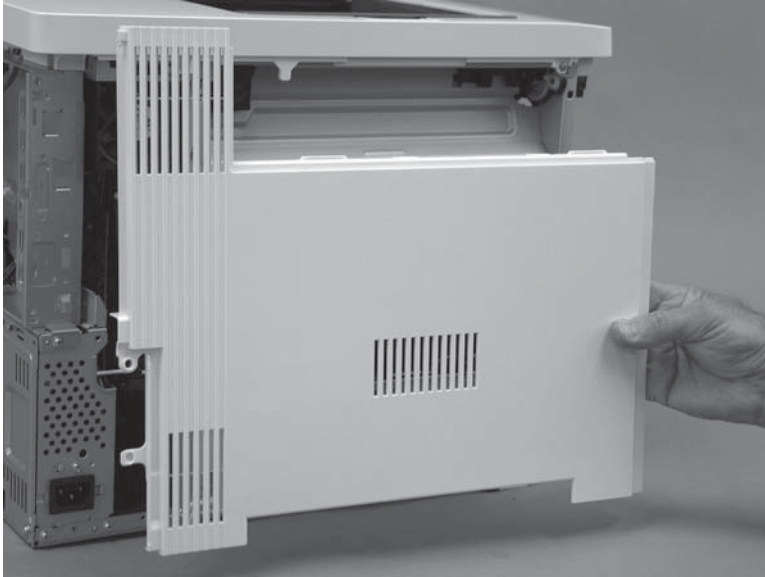

2. Slide the cover (callout 1) toward the front of the printer to engage it. Make sure that the tab (callout 2) snaps into place.

 **NOTE:** Locate the alignment pin (callout 3) on the cover from the front door side of the printer, and then make sure that it is fully engaged in the slot in the chassis.

 **TIP:** While sliding the cover into place, push in on the center of the cover (callout 1) to make sure that the hooks on the back of the cover engage with the slots in the chassis.

Figure 1-1560 Engage the cover



3. At the left side of the printer, install one screw (callout 1).

Figure 1-1561 Install one screw

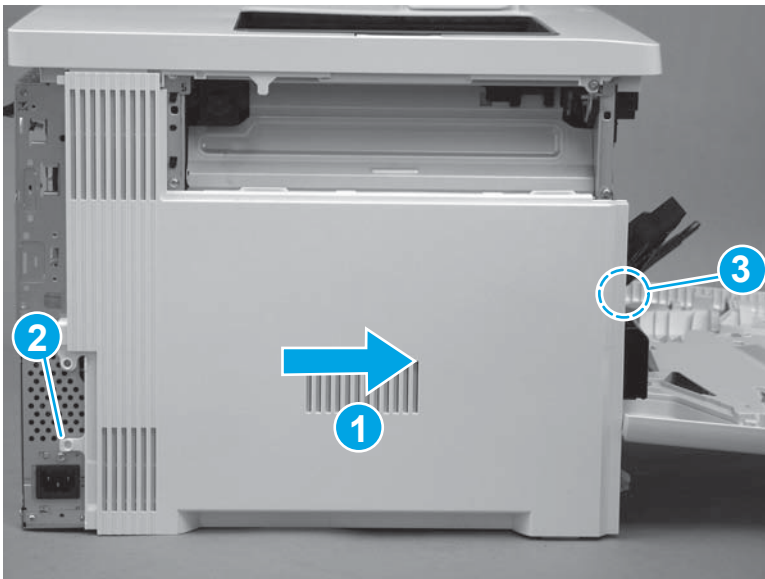

Step 11: Install the rear cover (M577)

 **NOTE:** This step is for the M577 models. For the M552 and M553 models, skip this step and go to [Step 13: Install the rear cover \(M552 and M553\) on page 898](#).

1. Position the hooks (callout 1) on the cover in the slots (callout 2) in the printer.

Figure 1-1562 Position the hooks

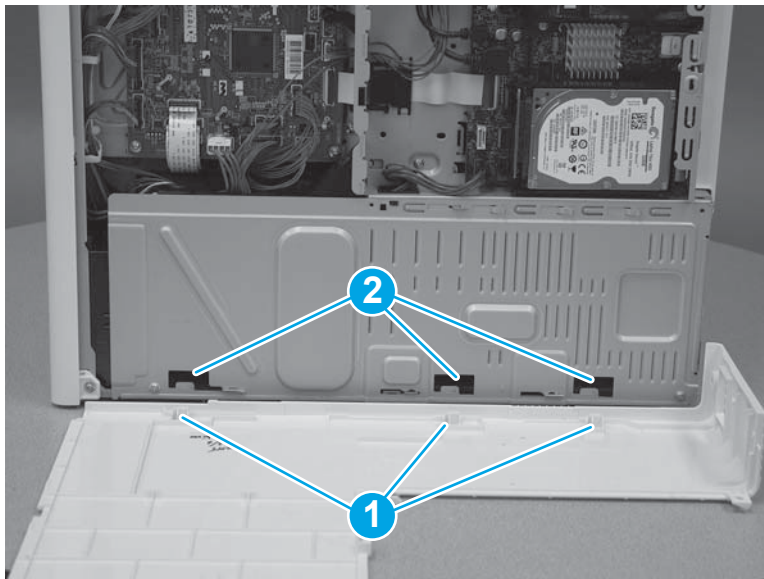

2. Position the back edge (callout 1) of the rear cover behind the edge (callout 2) of the right rear cover. Slide the cover to the left to install it.

Figure 1-1563 Install the cover

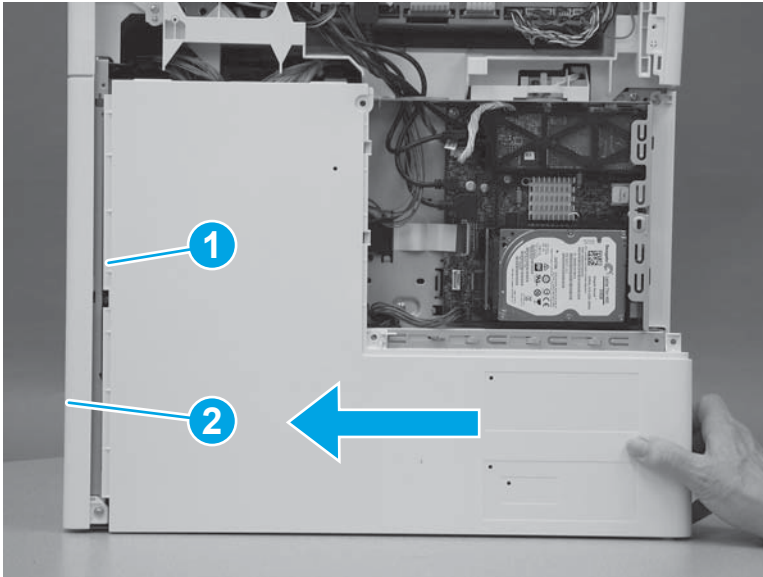

3. Install four screws (callout 1).

Figure 1-1564 Install four screws cover

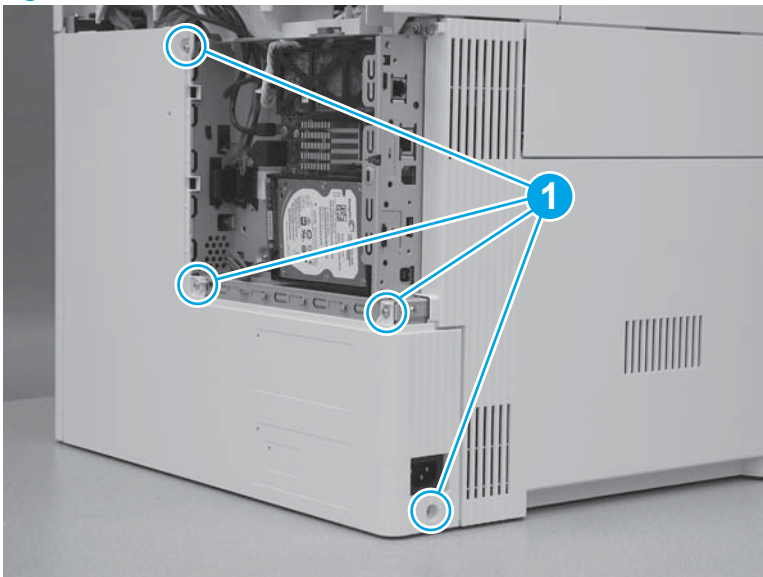

Step 12: Install the rear upper cover (M577)



NOTE: This step is for the M577 models. For the M552 and M553 models, skip this step and go to [Step 13: Install the rear cover \(M552 and M553\) on page 898](#).

1. Align the ridge (callout 1) on the lower edge of the rear upper cover in front of the tabs (callout 2) on the top edge of the rear cover.

Figure 1-1565 Align the cover

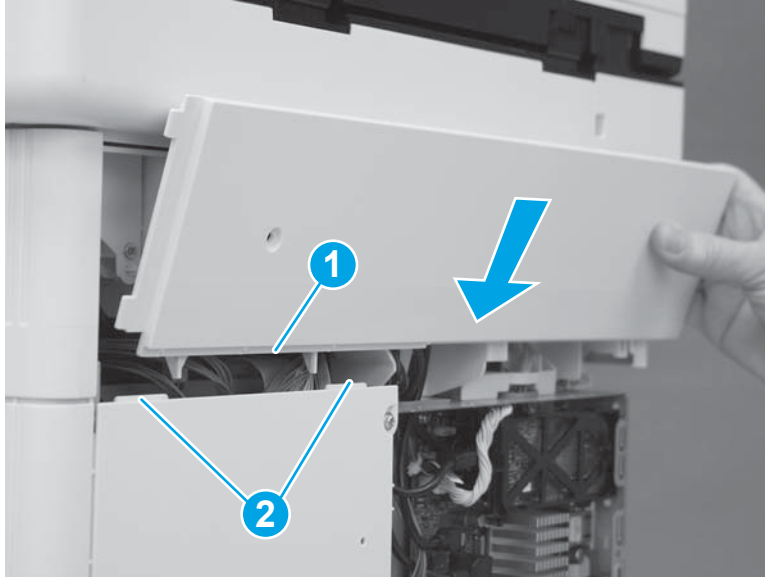

2. Rotate the top of the cover toward the printer.

Figure 1-1566 Rotate the top of the cover



3. Slide the cover to the left (callout 1). Make sure that the tabs (callout 2) on the upper rear cover slide behind the edge (callout 3) of the right upper cover. Make sure that the cover is fully seated.

Figure 1-1567 Slide the cover

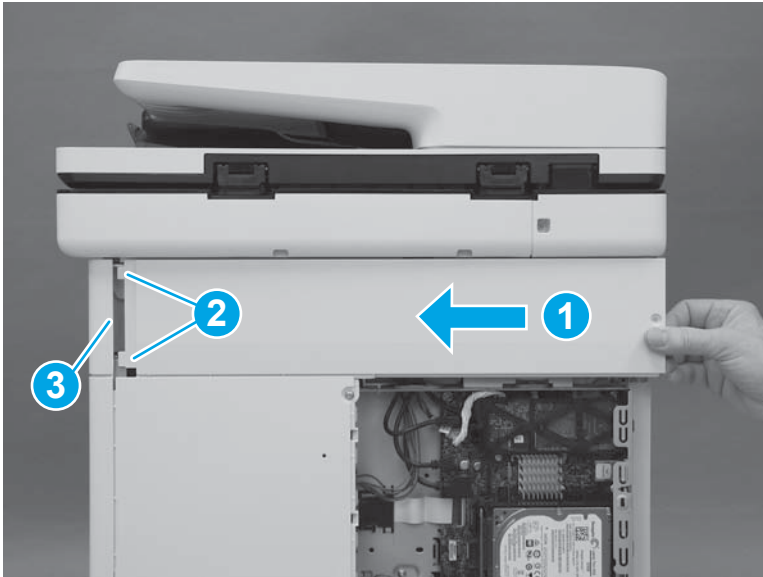

4. Install two screws (callout 1).

 **IMPORTANT:** These two screws are self-tapping screws for plastic. Rotate them counterclockwise to align them with the existing thread pattern, and then carefully turn them clockwise to tighten. Do not overtighten. This will prevent stripping the threads inside the screw holes.

Figure 1-1568 Install two screws



Step 13: Install the rear cover (M552 and M553)

 **NOTE:** This step is for the M552 and M553 models. For the M577 models, skip this step and go to [Step 14: Install the formatter cover on page 899](#).

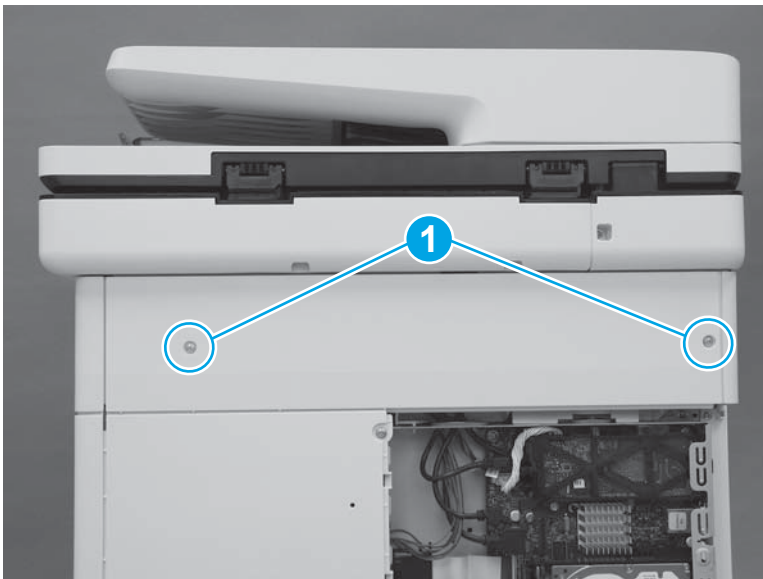
1. Position the top of the cover under the upper cover (callout 1), rotate the bottom of the cover onto the chassis (callout 2), and then slide the cover to the left (callout 3) to install it.

Figure 1-1569 Install the cover

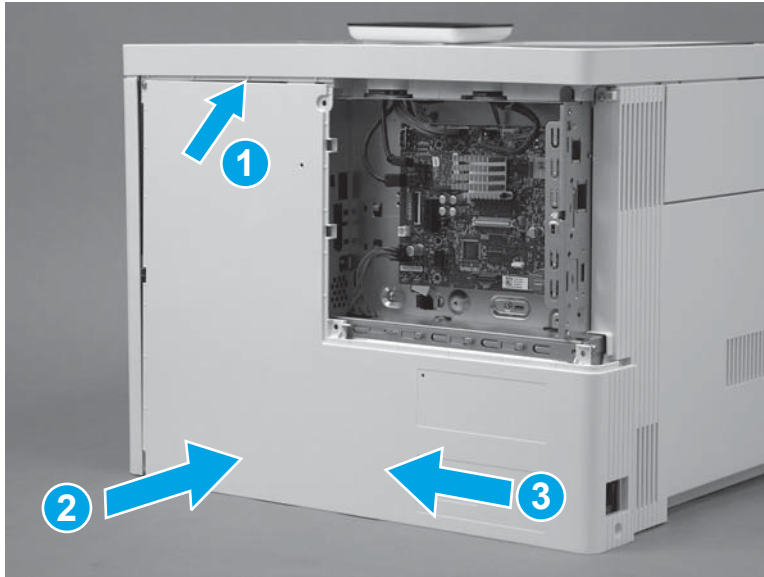

2. Install four screws (callout 1).

Figure 1-1570 Install four screws cover

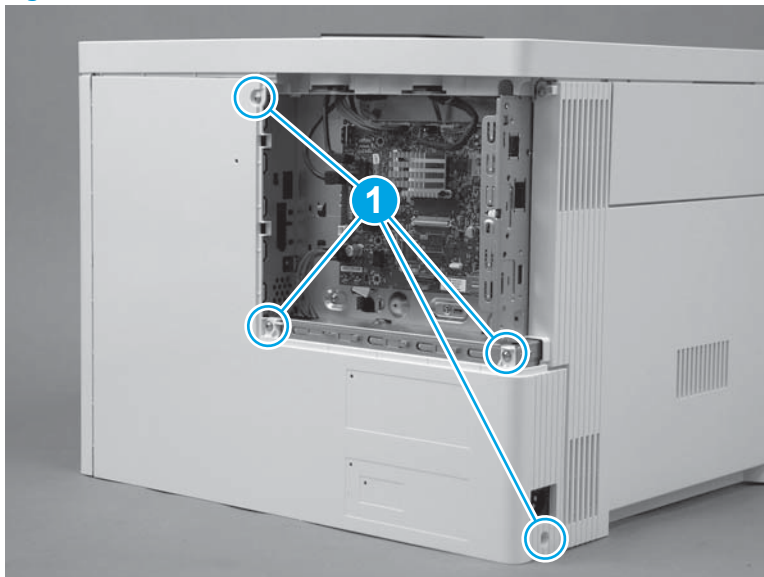

Step 14: Install the formatter cover

- ▲ Slide the cover onto the printer (callout 1) to install it.

 **NOTE:** Make sure that the tabs on the formatter cover align with the slots provided in the printer (callout 2). Tighten the two thumbscrews (callout 3).

 **TIP:** If needed, use the edge of a coin to turn the thumbscrews.

Figure 1-1571 Install the cover



Step 15: Install the TCU

1. Verify that the toner collection hatch cover is in the closed position on the TCU.

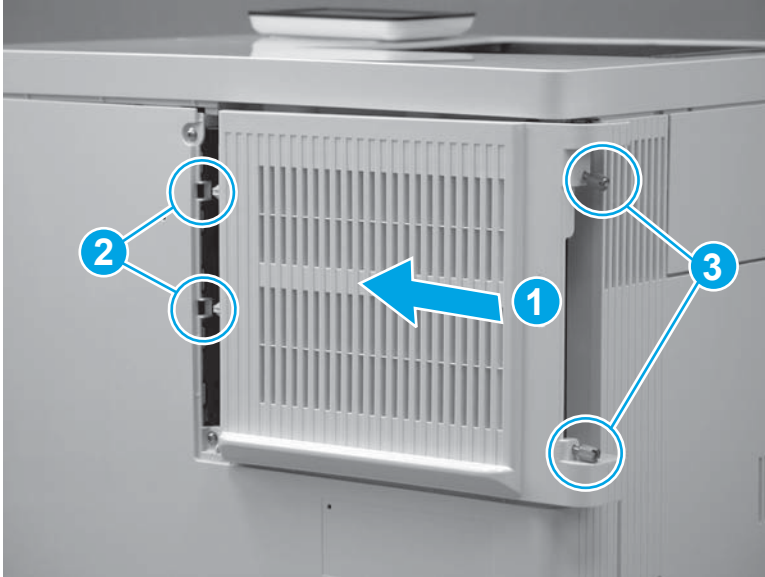
Figure 1-1572 Verify that the toner collection hatch cover is closed

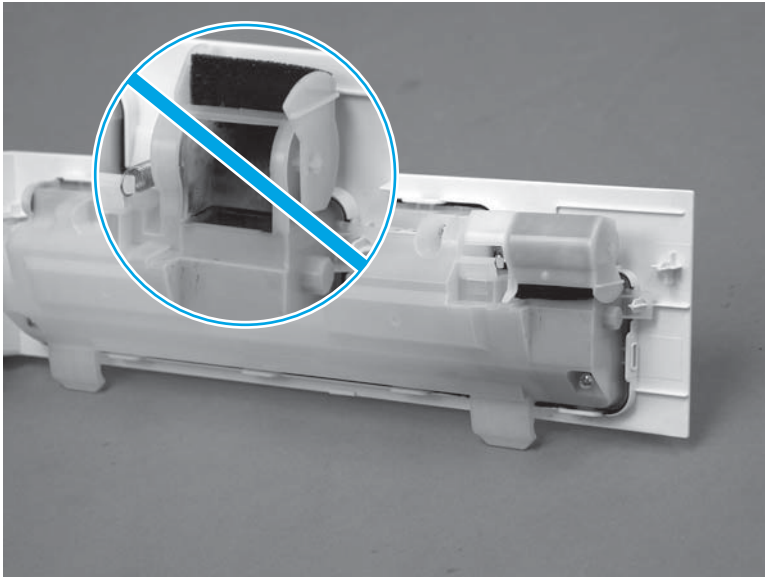

2. Position the TCU with the hinges in the slots provided in the printer (callout 1), and then rotate the TCU up and into the closed position.

 **NOTE:** The toner collection hatch cover automatically opens when the TCU is closed.

Figure 1-1573 Install the TCU



3. Close the front door.

Figure 1-1574 Close the front door

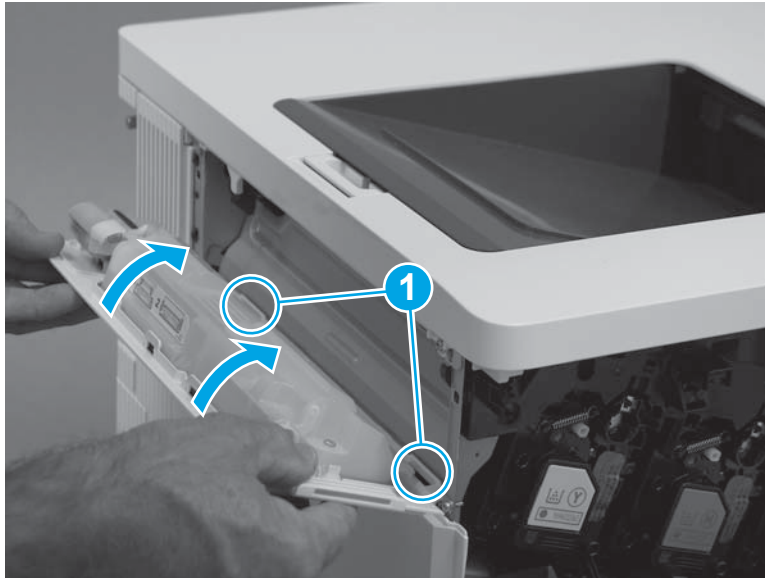

Removal and replacement: Low-voltage power supply (LVPS)

- [Introduction](#)
- [Step 1: Remove the toner collection unit \(TCU\)](#)
- [Step 2: Remove the formatter cover](#)
- [Step 3: Remove the formatter \(M552 and M553\)](#)
- [Step 4: Remove the hard-disk drive \(HDD\) \(M577\)](#)
- [Step 5: Remove the fax PCA \(M577c/f/z\)](#)
- [Step 6: Remove the formatter \(M577\)](#)
- [Step 7: Remove the rear cover \(M552 and M553\)](#)
- [Step 8: Remove the rear upper cover \(M577\)](#)
- [Step 9: Remove the rear cover \(M577\)](#)
- [Step 10: Remove the left cover](#)
- [Step 11: Remove the formatter case](#)
- [Step 12: Remove the low-voltage power supply \(LVPS\)](#)
- [Step 13: Unpack the replacement assembly](#)
- [Step 14: Install the LVPS](#)
- [Step 15: Install the formatter case](#)
- [Step 16: Install the left cover](#)
- [Step 17: Install the rear cover \(M577\)](#)
- [Step 18: Install the rear upper cover \(M577\)](#)
- [Step 19: Install the rear cover \(M552 and M553\)](#)
- [Step 20: Install the formatter \(M577\)](#)
- [Step 21: Install the fax PCA \(M577c/f/z\)](#)
- [Step 22: Install the HDD \(M577\)](#)
- [Step 23: Install the formatter \(M552 and M553\)](#)
- [Step 24: Install the formatter cover](#)
- [Step 25: Install the TCU](#)

Introduction



This document provides the procedures to remove and replace the low-voltage power supply (LVPS).

Before performing service

Turn the printer power off

- Disconnect the power cable.

 **WARNING!** To avoid damage to the printer, turn the printer off, wait 30 seconds, and then remove the power cord before attempting to service the printer.

 **CAUTION:**  This part contains components that are electrostatic discharge (ESD) sensitive. To reduce the possibility of ESD damage, always touch the sheet-metal chassis to ground yourself before touching an ESD sensitive part.

Use the table below to identify the correct part number for your printer, and then go to <http://h20141.www2.hp.com/hpparts> to order the part.

Low-voltage power supply (LVPS) part number	
RM2-7164-000CN	Low-voltage power supply (LVPS)

Required tools

- #2 Phillips screwdriver with a magnetic tip

After performing service

Make sure that all of the connectors on the LVPS are fully seated.

Make sure that all of the connectors on the formatter are fully seated.

Make sure that the formatter cover is fully seated, and that the thumbscrews are finger tight after replacing it.

Turn the printer power on

- Connect the power cable.
- Use the power switch to turn the power on.

Post service test

Print a configuration page to make sure that the printer is functioning correctly.

Step 1: Remove the toner collection unit (TCU)

1. Open the front door.

Figure 1-1575 Open the front door



2. Open the TCU.



NOTE: The toner collection hatch cover automatically closes when the TCU is opened.

Figure 1-1576 Open the TCU



3. Pull the TCU away from the printer at an angle to remove it.

⚠ CAUTION: Do not open the toner collection hatch cover when handling the TCU. If toner gets on clothing, wipe it off by using a dry cloth and wash the clothes in cold water. Hot water sets toner into fabric.

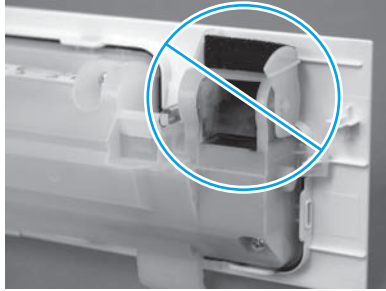
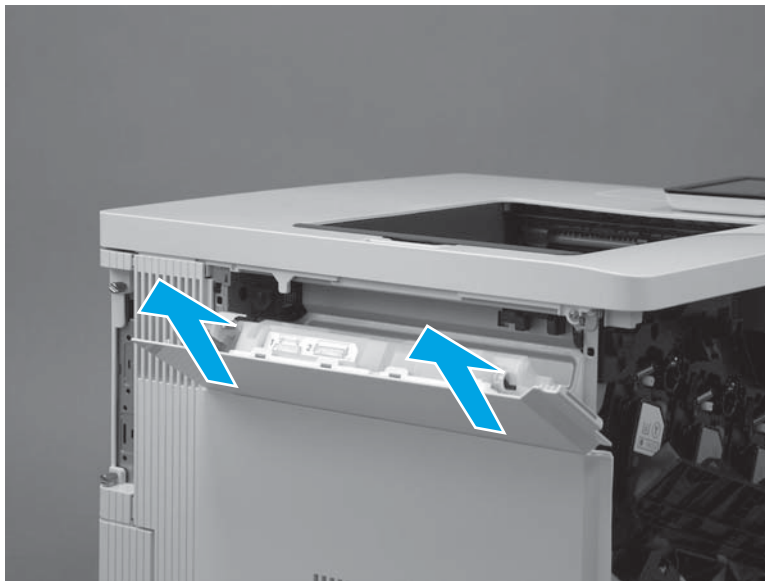

Figure 1-1577 Remove the TCU



Step 2: Remove the formatter cover

1. Locate the formatter cover.

Figure 1-1578 Locate the formatter cover

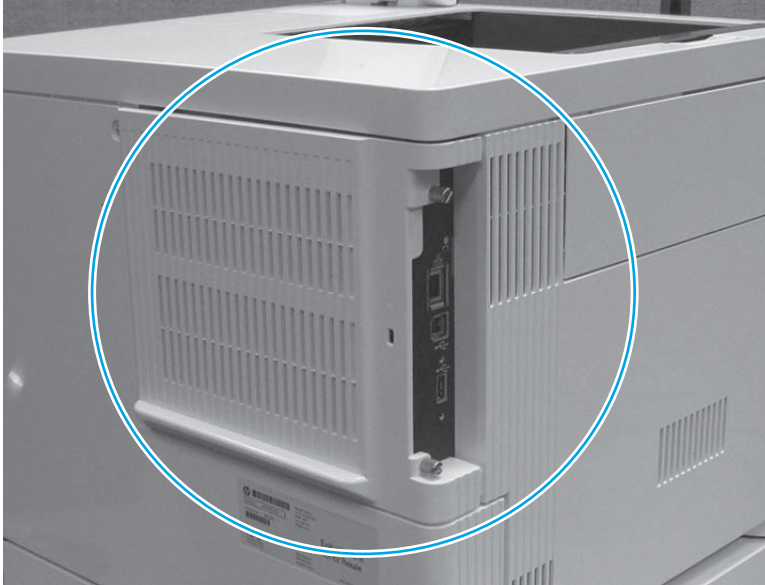

2. Loosen the two thumbscrews (callout 1). Grasp the two thumbscrews, and then slide the cover away from the printer (callout 2) to remove it.

 **TIP:** If needed, use the edge of a coin to turn the thumbscrews.

Figure 1-1579 Loosen the thumbscrews



Step 3: Remove the formatter (M552 and M553)

 **NOTE:** This step is for the M552 and M553 models. For the M577 models, skip this step and go to [Step 4: Remove the hard-disk drive \(HDD\) \(M577\) on page 908](#).

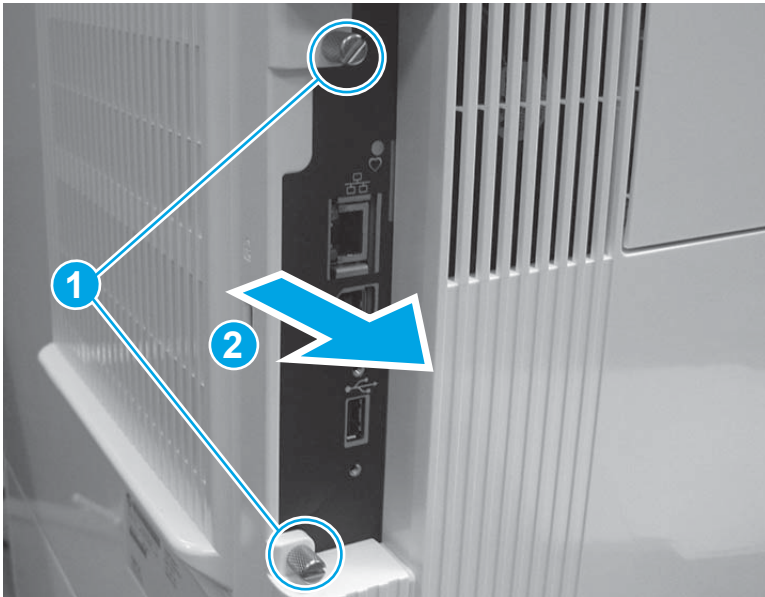
If the optional hard-disk drive (HDD) is installed, it must be removed to gain access to the formatter mounting screws.

Release two tabs along the left edge of the HDD, rotate the left edge away from the product, and then slide the HDD to the left to remove it.

 **CAUTION:**  ESD-sensitive part.

1. Disconnect all of the connectors on the formatter.

The following connectors are empty:

- All models: J1 (this connector is empty unless the optional DIMM is installed)
- M553n/dn and M552dn: J2 (callout 1; this is the touchscreen connector for the M553x model)
- All models: J9 (this connector is empty unless the optional internal USB ports component is installed)
- All models: J18 (this connector is empty unless the optional hard-disk-drive (HDD) is installed)
- All models: J23
- All models: J24
- M553n/dn and M552dn: J25 (this is the wireless connector for the M553x model)
- All models: J57
- All models: J98 (this connector is empty unless the optional trusted platform module (TPM) is installed)

 **IMPORTANT:** The flat-cable connector (callout 2) is a Zero Insertion Force (ZIF) connector that uses a hinged retainer to secure the flat cable. The hinged retainer must be opened to release the flat cable.

Figure 1-1580 Disconnect all connectors



2. Remove four screws (callout 1), and then remove the formatter.

Figure 1-1581 Remove the formatter

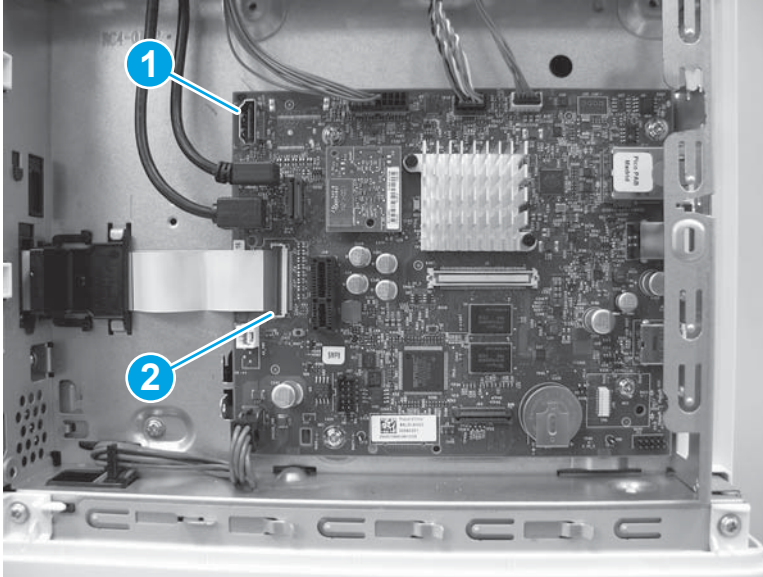
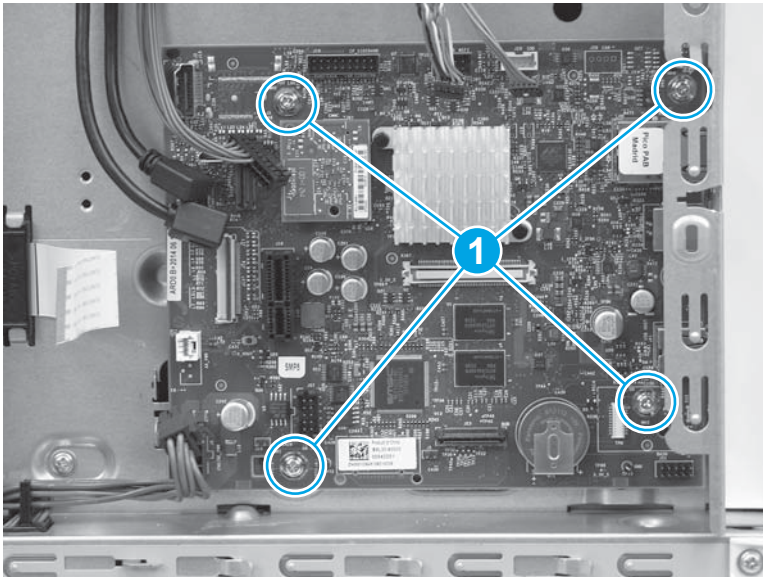

Step 4: Remove the hard-disk drive (HDD) (M577)

 **NOTE:** This step is for the M577 models. For the M552 and M553 models, skip this step and go to [Step 7: Remove the rear cover \(M552 and M553\) on page 913](#).

 **CAUTION:**  ESD-sensitive part.

1. Release two tabs (callout 1). Hold the tabs in the released position, and then rotate the hard disk drive (HDD) up (callout 2) to release the connector from the formatter.

Figure 1-1582 Release the HDD

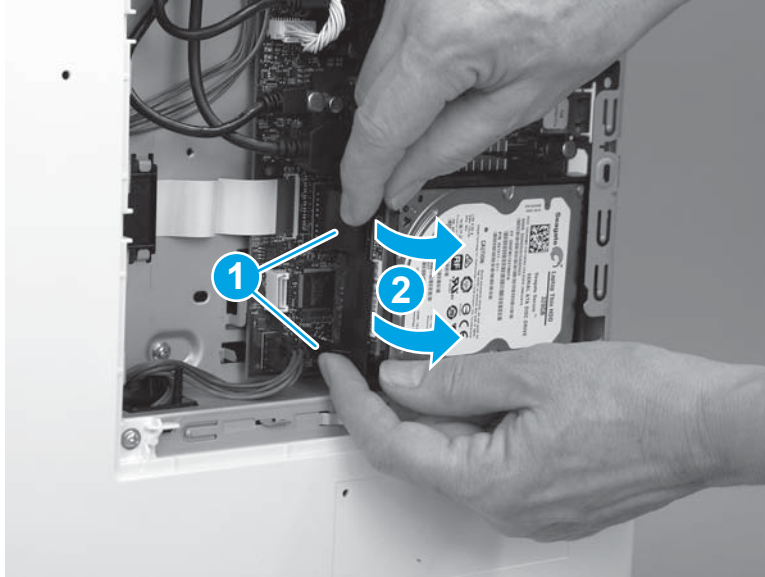

2. Slide the HDD away from the printer to remove it.

Figure 1-1583 Remove the HDD

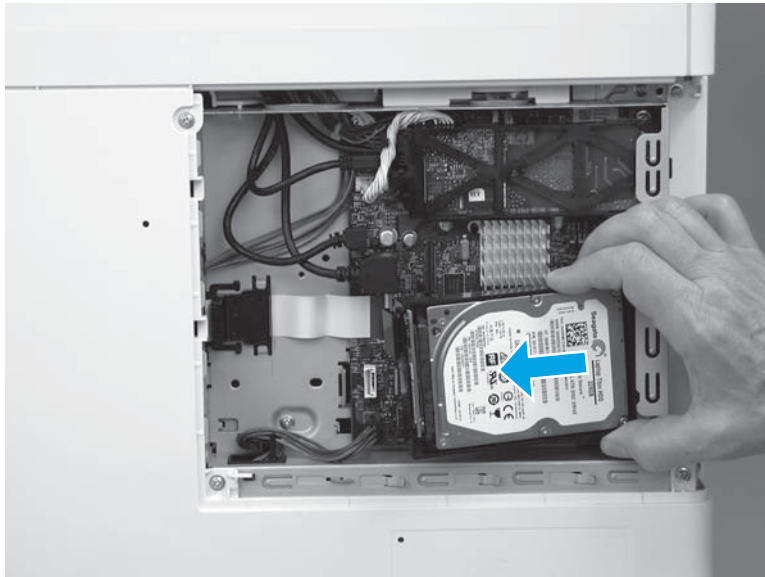

Step 5: Remove the fax PCA (M577c/f/z)

 **NOTE:** This step is for the M577c/f/z models. For the M577n model, skip this step and go to [Step 6: Remove the formatter \(M577\) on page 911](#).

For the M552 and M553 models, skip this step and go to [Step 7: Remove the rear cover \(M552 and M553\) on page 913](#).

 **CAUTION:**  ESD-sensitive part.

1. Locate the fax PCA component on the formatter.

Figure 1-1584 Locate the fax PCA

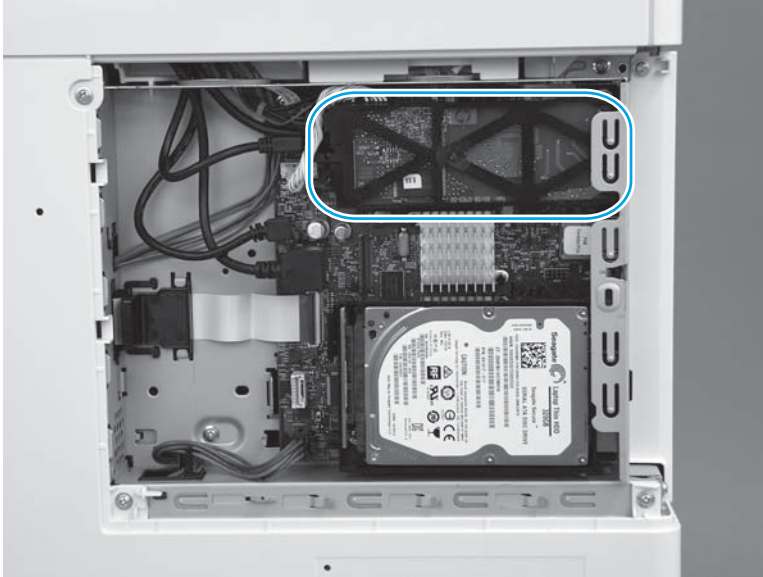

2. Release the connector latch (callout 1), and then pull the connector away from the formatter (callout 2) to disconnect it.

Figure 1-1585 Disconnect one connector

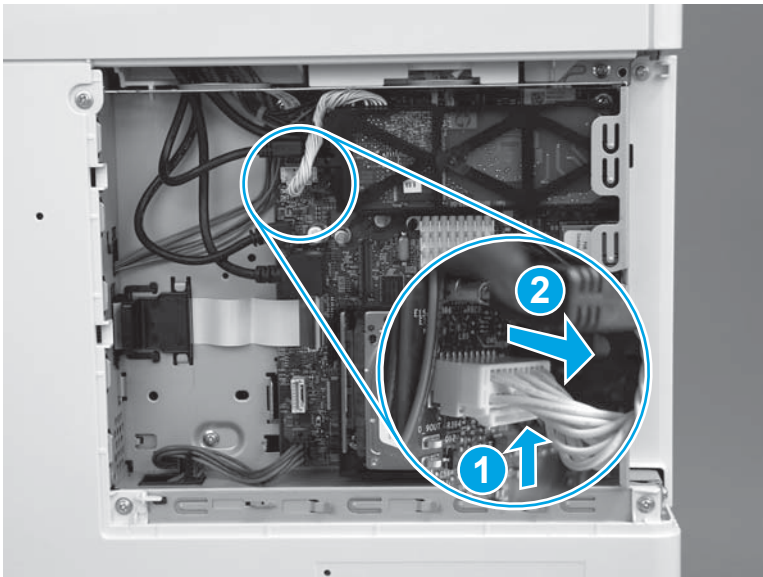

3. Release one retainer (callout 1) by pressing the bracket arms together.

Figure 1-1586 Release one latch

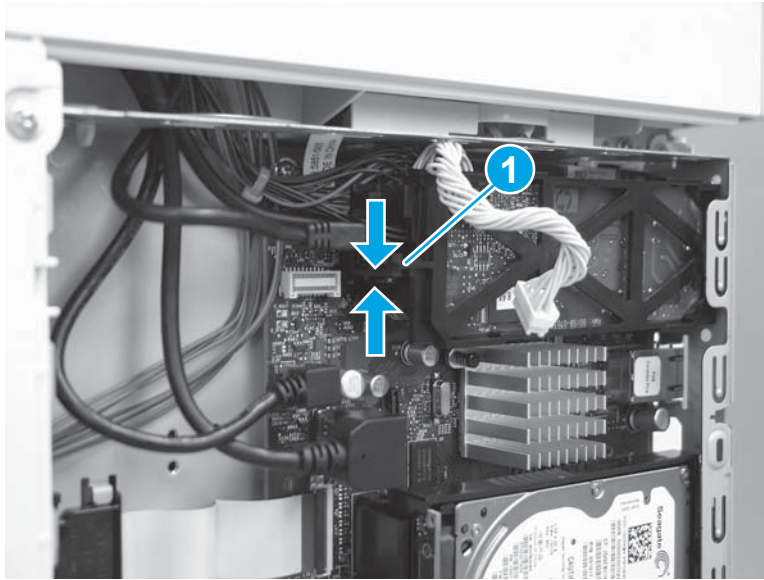

4. Rotate the end of the fax PCA (callout 1) away from the formatter, and then slide the PCA left (callout 2) to remove it.

Figure 1-1587 Remove the fax PCA

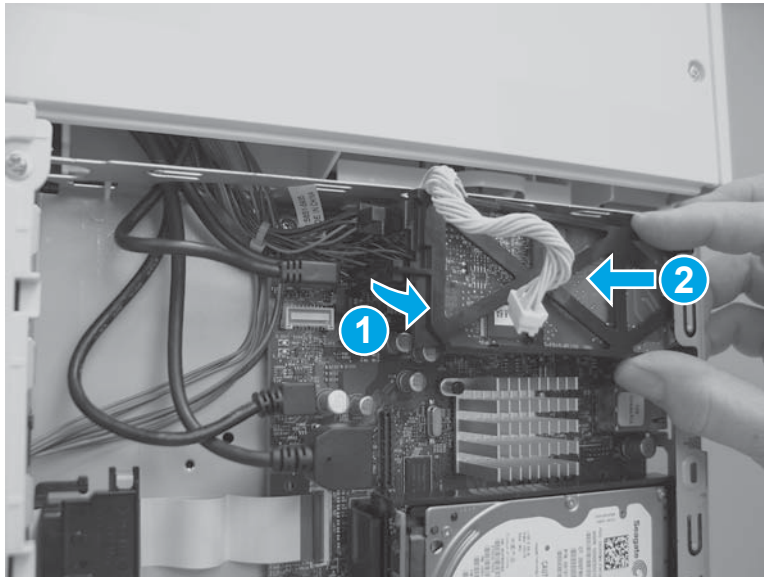

Step 6: Remove the formatter (M577)

 **NOTE:** This step is for the M577 models. For the M552 and M553 models, skip this step and go to [Step 7: Remove the rear cover \(M552 and M553\) on page 913.](#)

 **CAUTION:**  ESD-sensitive part.

1. Disconnect all of the connectors on the formatter.

The following connectors are empty:

- All models: J1 (this connector is empty unless the optional DIMM is installed)
- All models: J3
- M577dn: J15 (this is the fax connector for the M577f/z/c models)
- All models: J21 (this connector is empty unless the optional internal USB ports component is installed)
- All models: J23
- All models: J24
- All models: J51
- All models: J57
- All models: J97
- All models: J98 (this connector is empty unless the optional trusted platform module (TPM) is installed)

 **IMPORTANT:** The flat-cable connector (callout 1) is a Zero Insertion Force (ZIF) connector that uses a hinged retainer to secure the flat cable. The hinged retainer must be opened to release the flat cable.

Figure 1-1588 Disconnect all connectors



2. Remove four screws (callout 1).

Figure 1-1589 Remove four screws

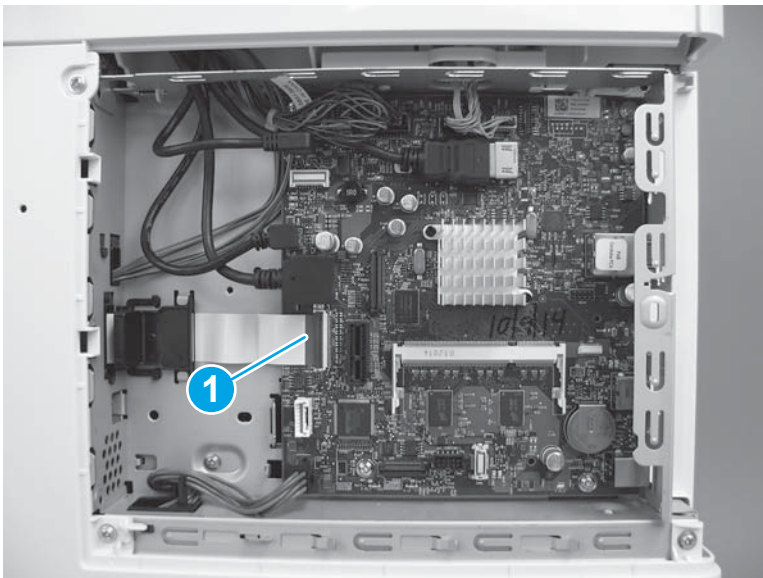
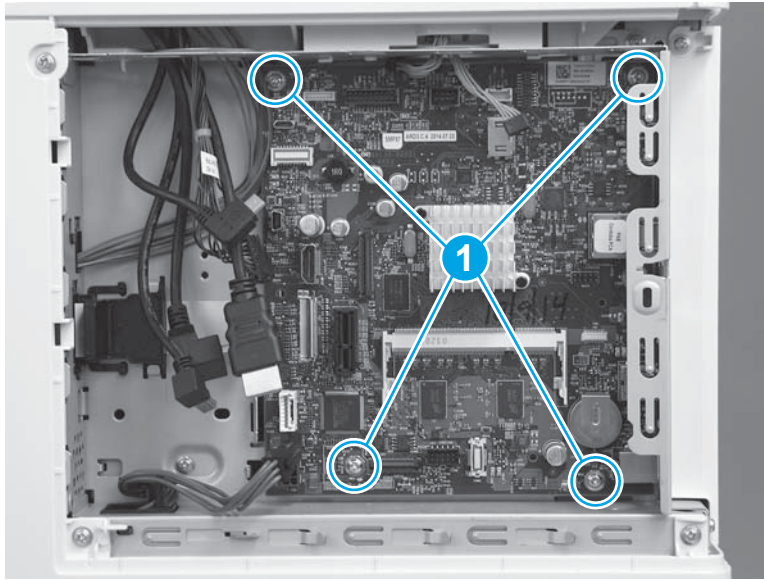

3. Remove the formatter.

Figure 1-1590 Remove the formatter

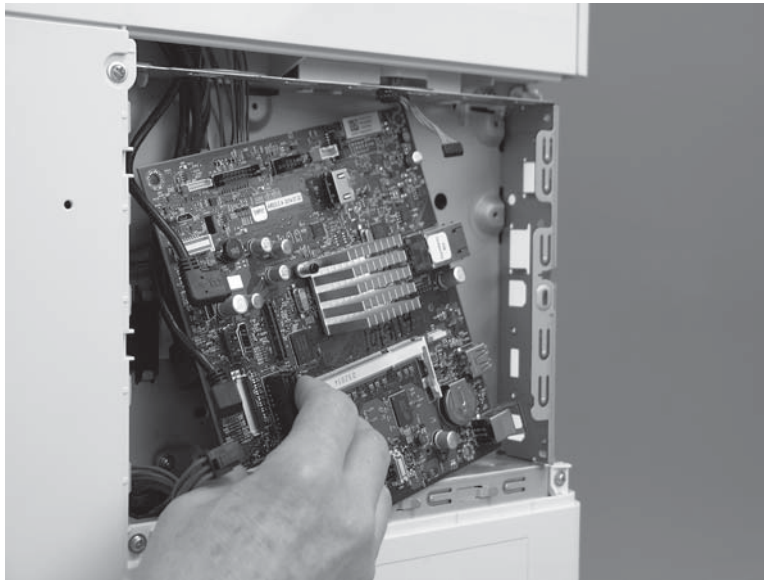

Step 7: Remove the rear cover (M552 and M553)

 **NOTE:** This step is for the M552 and M553 models. For the M577 models, skip this step and go to [Step 8: Remove the rear upper cover \(M577\) on page 914.](#)

1. Remove four screws (callout 1).

Figure 1-1591 Remove four screws

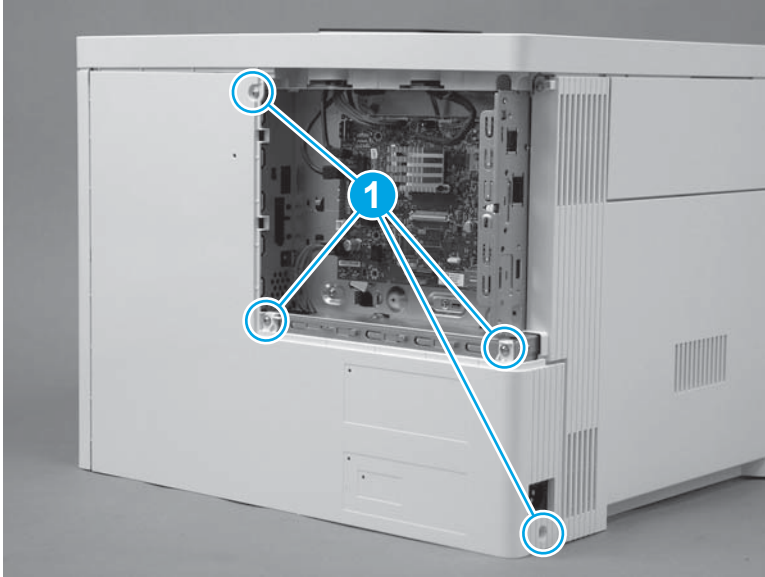

2. Slightly slide the cover to the right (callout 1), rotate the bottom of the cover away from the printer (callout 2), and then pull the top of the cover away from the printer (callout 3) to remove the cover.

Figure 1-1592 Remove the cover

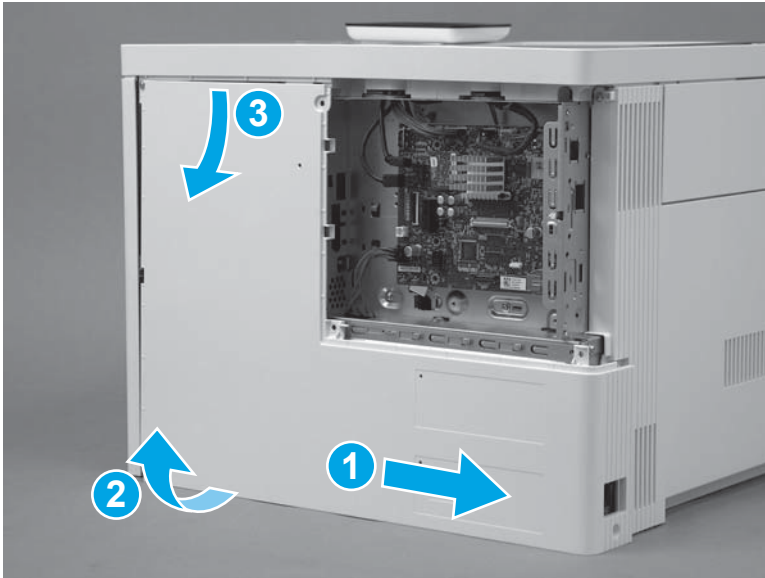

Step 8: Remove the rear upper cover (M577)



NOTE: This step is for the M577 models. For the M552 and M553 models, skip this step and go to [Step 10: Remove the left cover on page 917](#).

1. Remove two screws (callout 1).



Reinstallation tip: These two screws are self-tapping screws for plastic. When reinstalling them, rotate the screws counterclockwise to align them with the existing thread pattern, and then carefully turn them clockwise to tighten. Do not overtighten. This will prevent stripping the threads inside the screw holes.

Figure 1-1593 Remove two screws

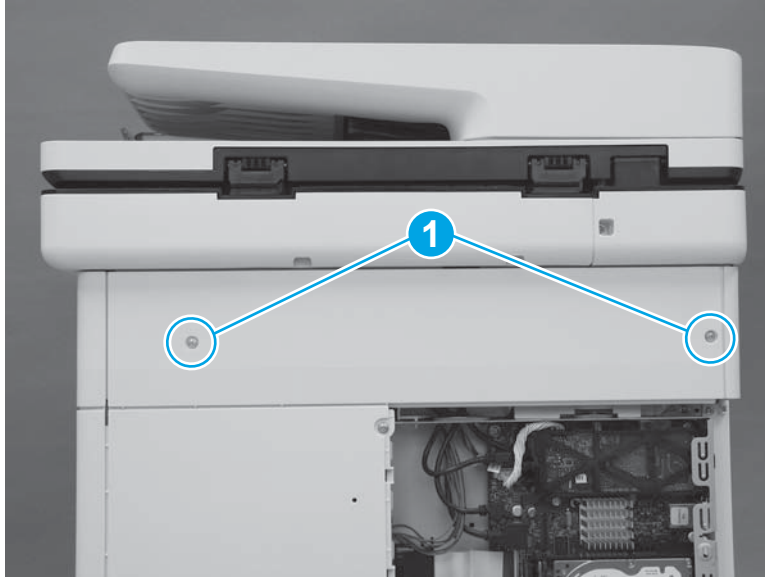

2. Use a small, flat blade screwdriver to release the right edge of the cover.

Figure 1-1594 Release the right edge

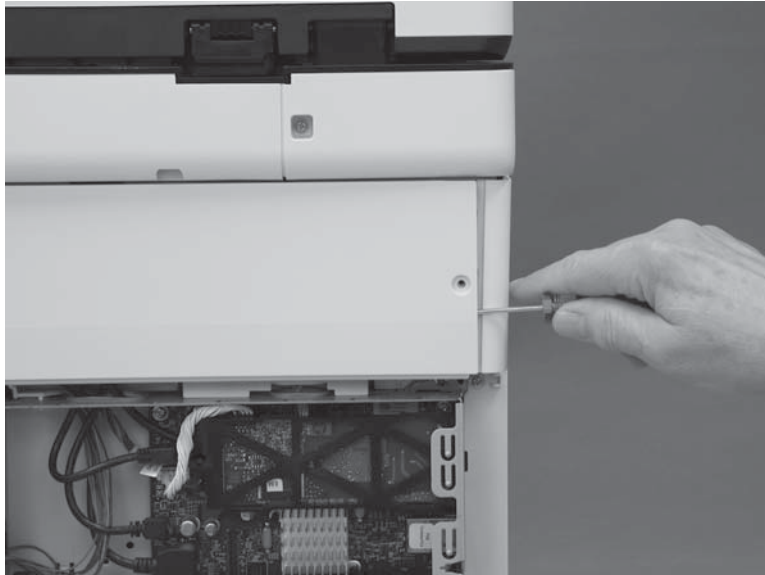

3. Pull the right edge of the cover (callout 1) away from the printer, and then slide the cover to the right (callout 2).

Figure 1-1595 Slide the cover right

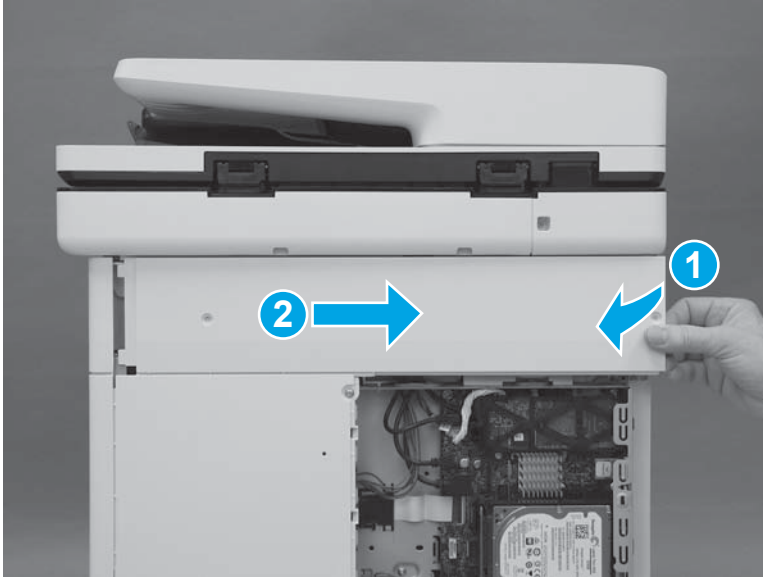

4. Remove the cover.

Figure 1-1596 Remove the cover

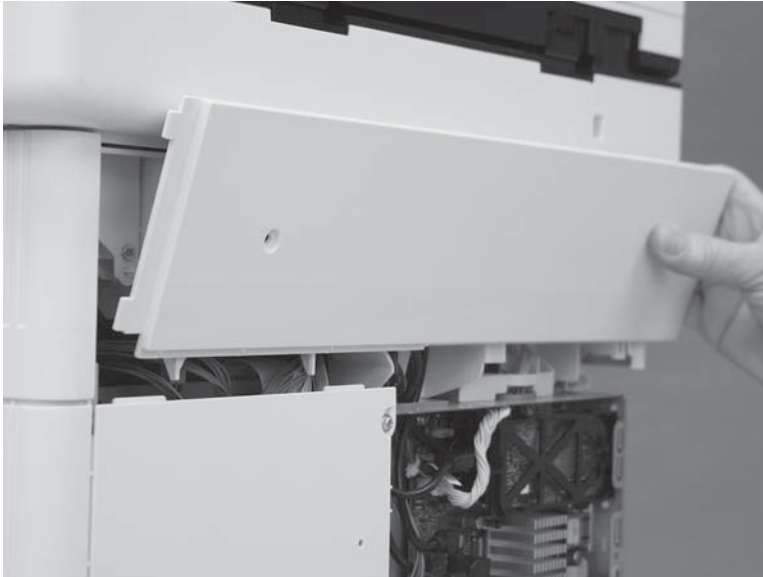

Step 9: Remove the rear cover (M577)



NOTE: This step is for the M577 models. For the M552 and M553 models, skip this step and go to [Step 10: Remove the left cover on page 917](#).

1. Remove four screws (callout 1).

Figure 1-1597 Remove four screws

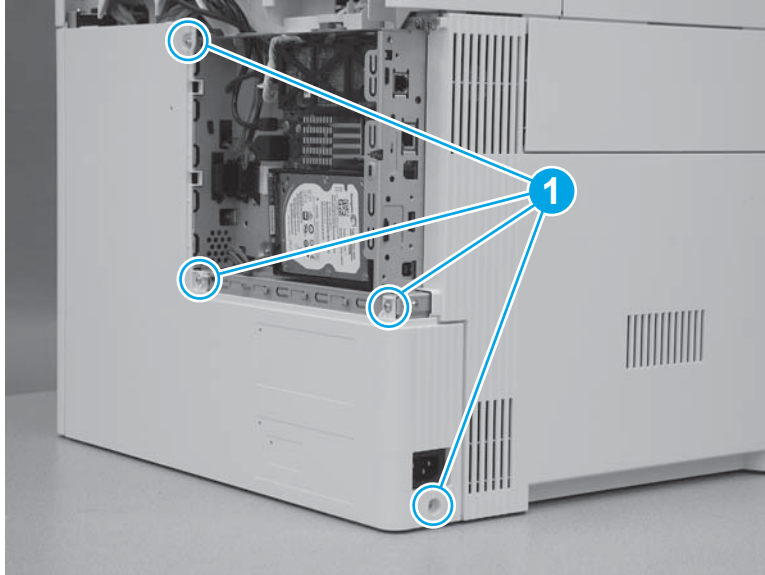

2. Slide the cover to the right to remove it.

Figure 1-1598 Remove the cover

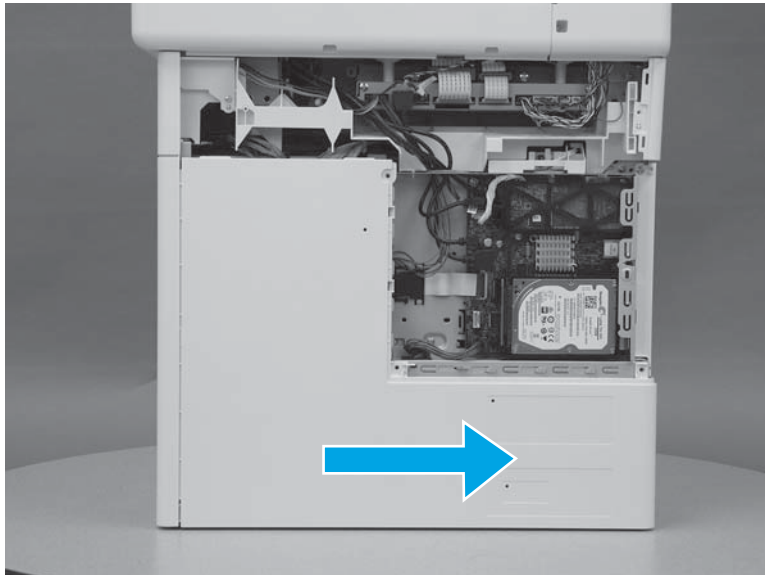

Step 10: Remove the left cover

1. At the left side of the printer, remove one screw (callout 1).

Figure 1-1599 Remove one screw



2. Release one tab (callout 1), rotate the front edge of the cover away from the printer (callout 2), and then slide the cover (callout 3) toward the rear of the printer to release it.

Figure 1-1600 Release the cover

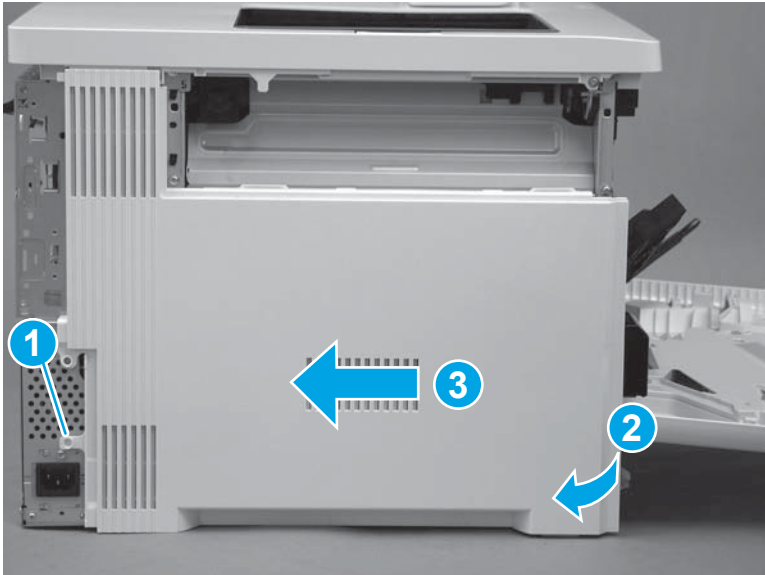

3. Remove the cover.

Figure 1-1601 Remove the cover

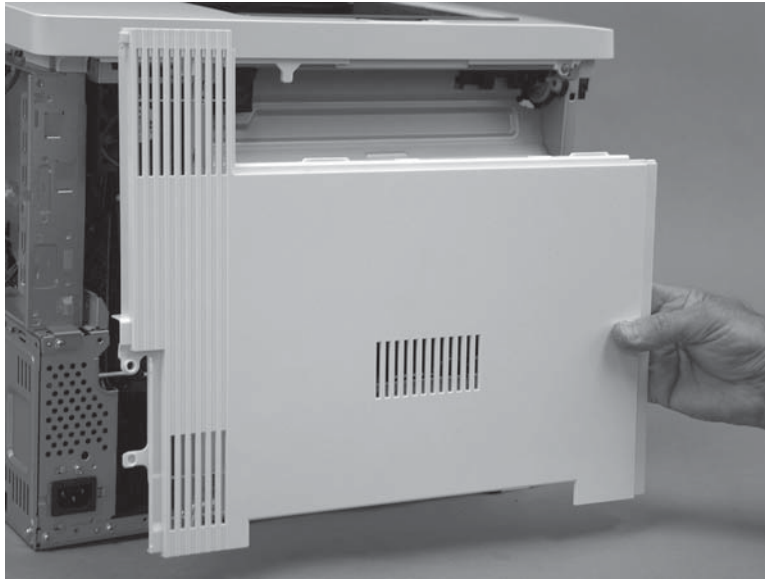

Step 11: Remove the formatter case

1. **M577 only:** Disconnect one connector (callout 1), and then pass the wire harness (callout 2) through two openings in the formatter case (callout 3).

Figure 1-1602 Disconnect one connector

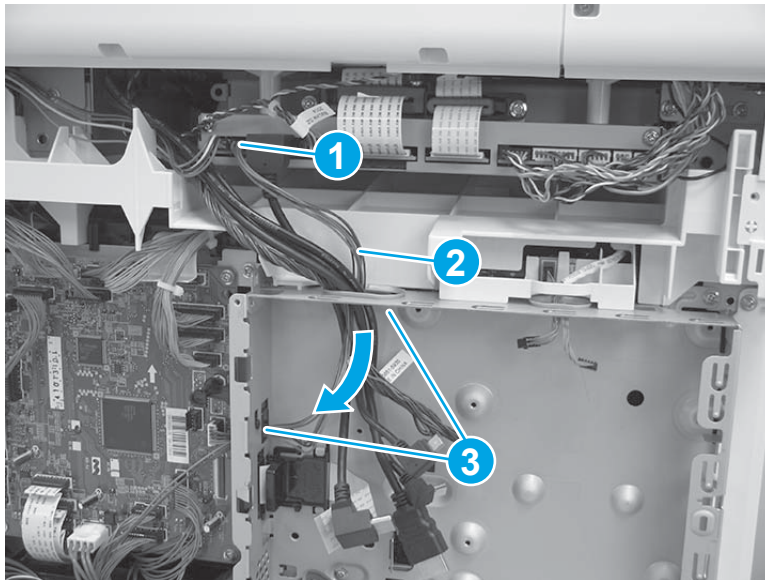

2. Release two tabs (callout 1) on the black plastic bracket. Hold the tabs in the released position, and then slide the bracket (callout 2) to the right to remove it from the formatter case.

Figure 1-1603 Remove the bracket

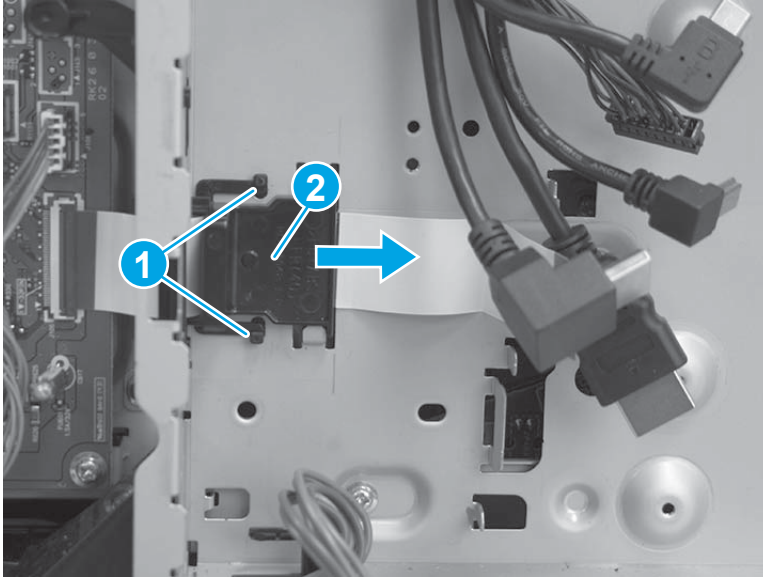

3. Remove two screws (callout 1), and then slide the low-voltage power supply (LVPS) cover to the right to remove it.

Figure 1-1604 Remove the LVPS cover

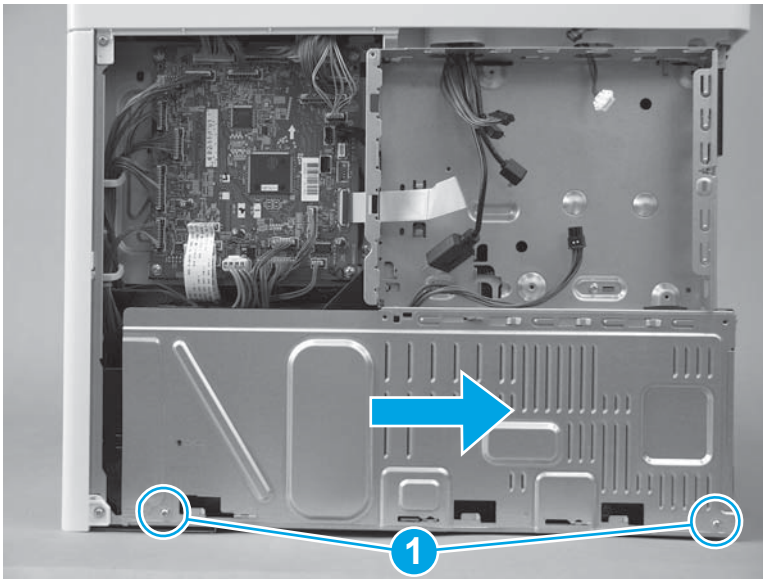

4. Pass two wire harnesses and one flat cable (callout 1) through the opening in the formatter case, and then release one wire harness from the retainer (callout 2).

CAUTION: The flat cable might be attached to the formatter case with double-sided tape. Make sure that this tape is released, so that the flat cable is not damaged when the formatter case is removed.

Figure 1-1605 Release wire harnesses and flat cable

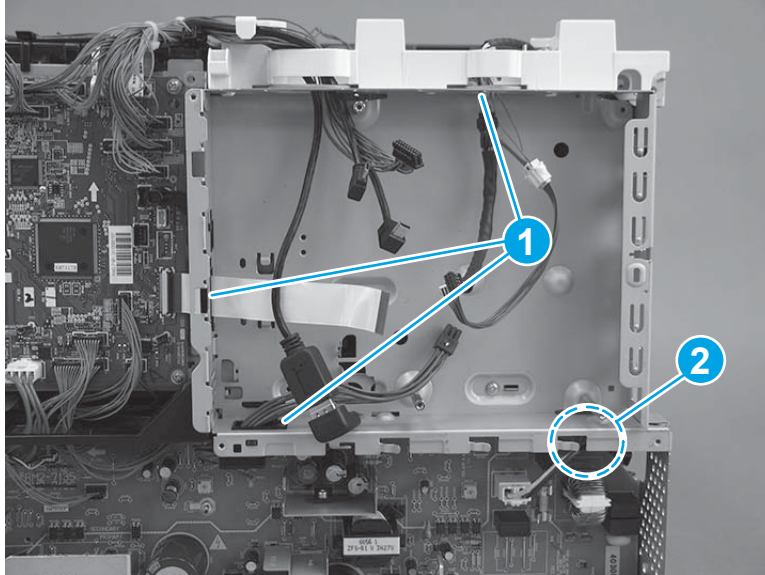

5. Remove six screws (callout 1).

Figure 1-1606 Remove six screws

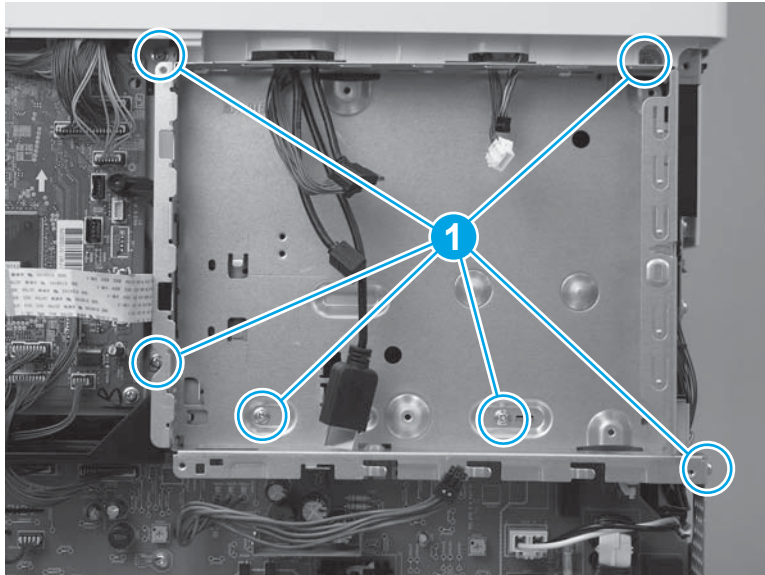

6. Rotate the bottom of the formatter case away from the printer (callout 1), and then pull it down (callout 2) to release it.

Figure 1-1607 Release the formatter case

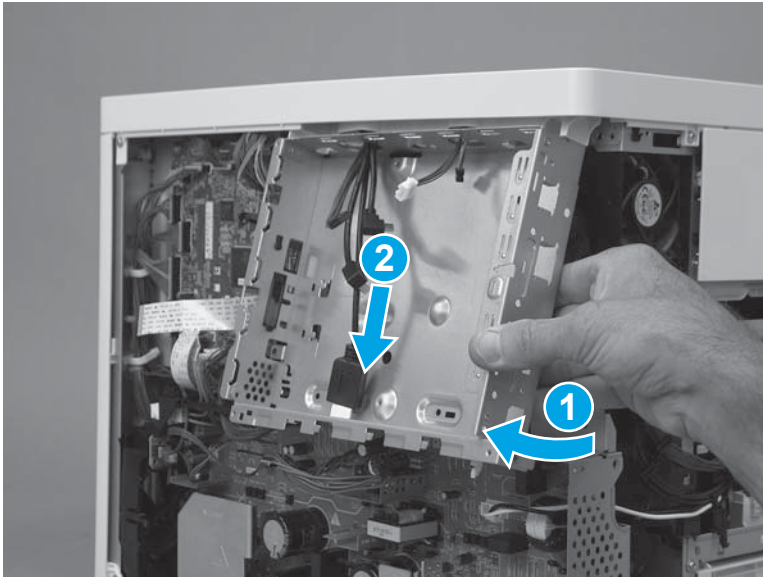

7. Pass the wire harnesses through the opening in the formatter case to remove it.

 **IMPORTANT:** If the formatter case is removed so that it can be replaced, make sure to transfer the memory PCA (island of data) and plastic bracket (callout 1) to the replacement case.

Figure 1-1608 Remove the formatter case



Step 12: Remove the low-voltage power supply (LVPS)

 **CAUTION:**  ESD-sensitive part.

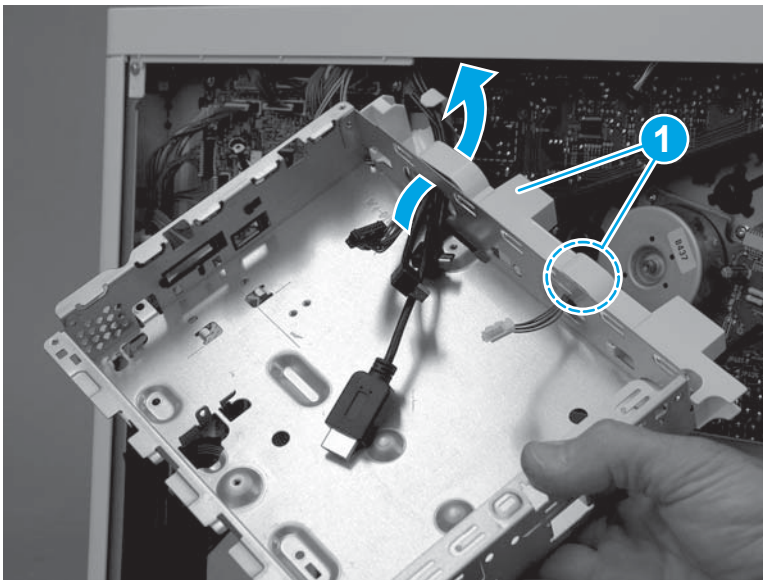
1. Disconnect one wire harness (callout 1), and then pass the wire harness through the opening (callout 2) in the chassis.

Figure 1-1609 Disconnect one wire harness

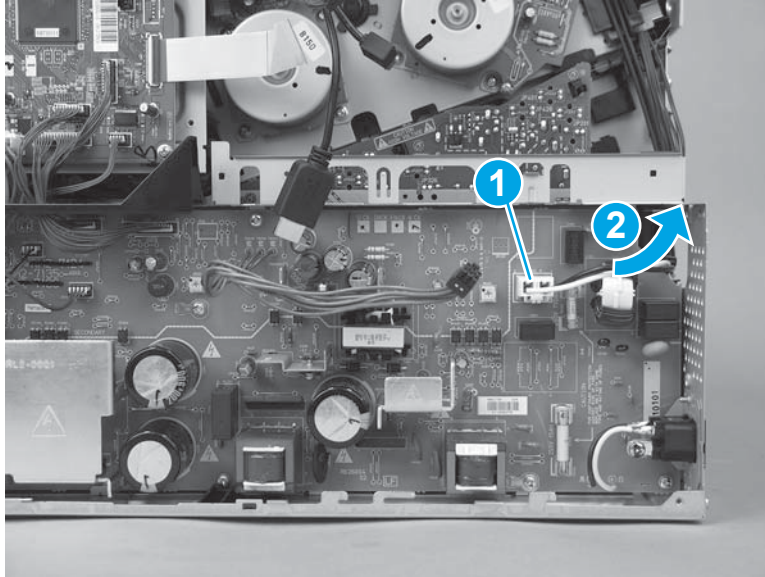

2. Disconnect three connectors on the DC controller (callout 1), and then disconnect four connectors (callout 2) on the LVPS.

Figure 1-1610 Disconnect seven connectors

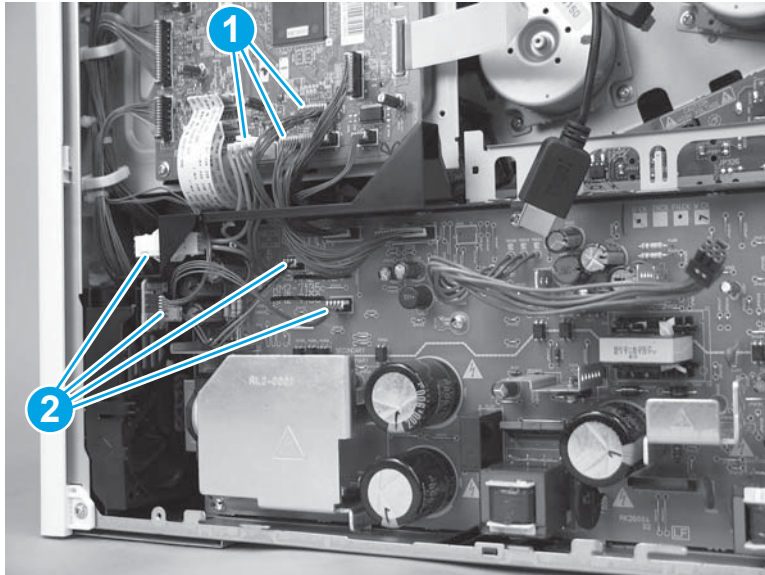

3. Pass the wire harnesses from the DC controller to the LVPS through the opening in the chassis (callout 1), and then release the wire harnesses from the retainer (callout 2).

Figure 1-1611 Pass the wire harnesses through the opening

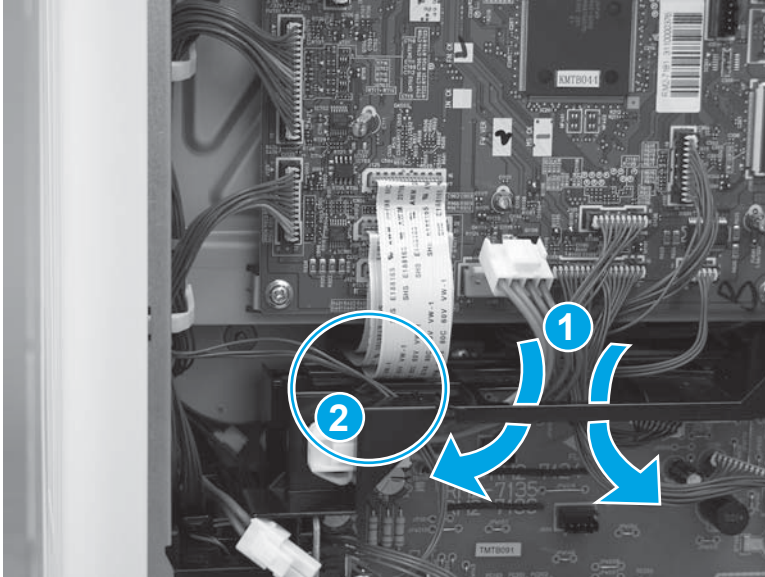

4. Remove three screws (callout 1).

Figure 1-1612 Remove three screws

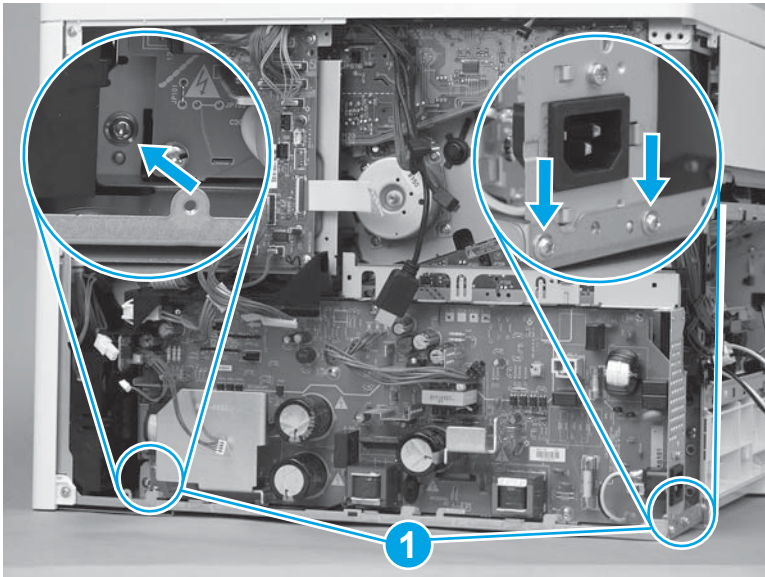

5. Rotate the top of the LVPS away from the printer (callout 1), and then slide it up and out (callout 2) of the printer to remove it.

Figure 1-1613 Remove the LVPS

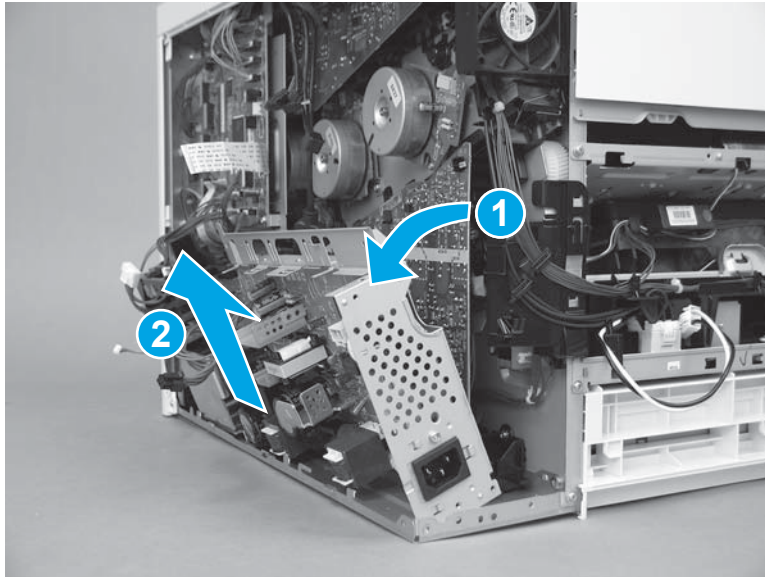

Step 13: Unpack the replacement assembly

Unpack the replacement assembly from the packaging.

 **CAUTION:**  ESD-sensitive part.

For complete information on HP's recycling programs, go to [Product return and recycling](#).

 **NOTE:** HP recommends responsible disposal of the defective assembly.

Figure 1-1614 Recycle and unpack



Step 14: Install the LVPS

 **CAUTION:**  ESD-sensitive part.

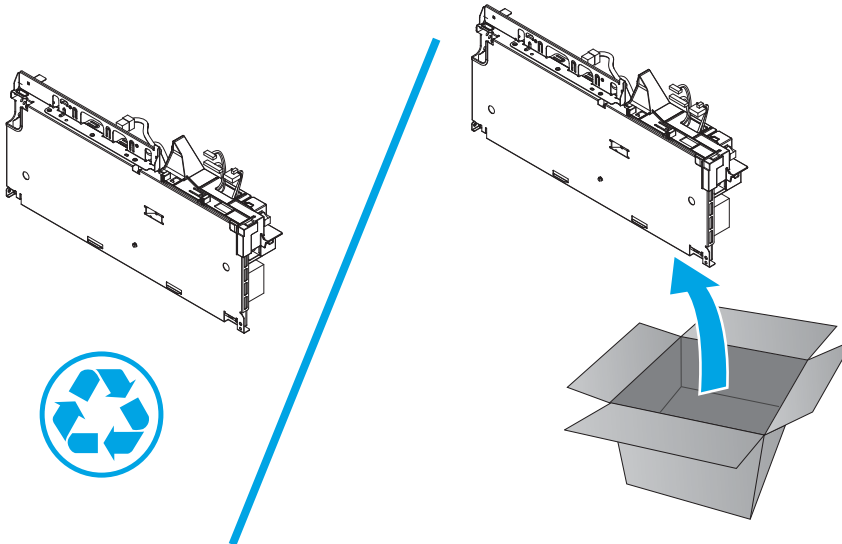
1. Position the bottom of the LVPS in the printer (callout 1) at a slight angle, and then rotate the top of it into the printer (callout 2) to install it.

Figure 1-1615 Install the LVPS

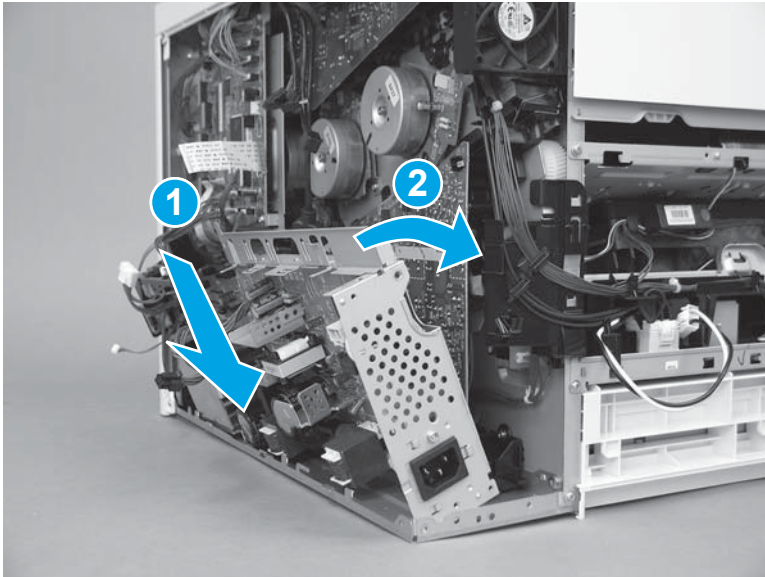

2. Install three screws (callout 1).

Figure 1-1616 Install three screws

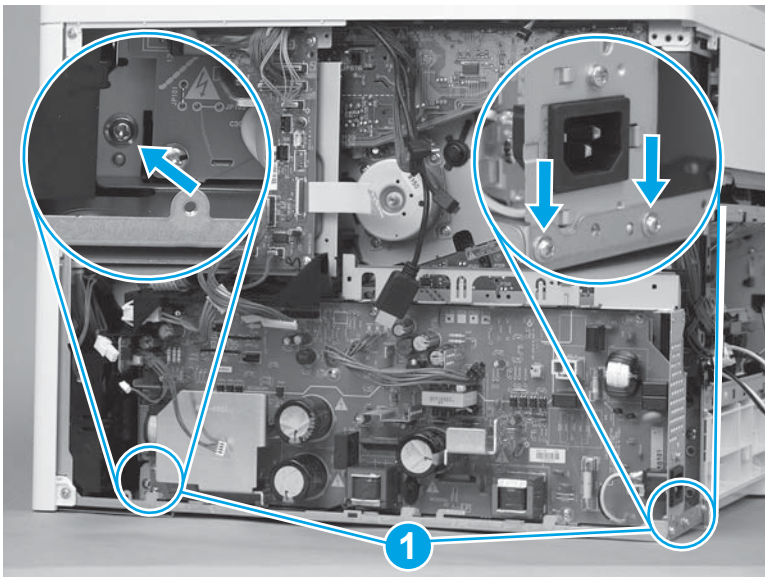

3. Pass the wire harnesses from the DC controller to the LVPS through the opening in the chassis (callout 1), and then install the wire harnesses in the retainer (callout 2).

Figure 1-1617 Pass the wire harnesses through the opening

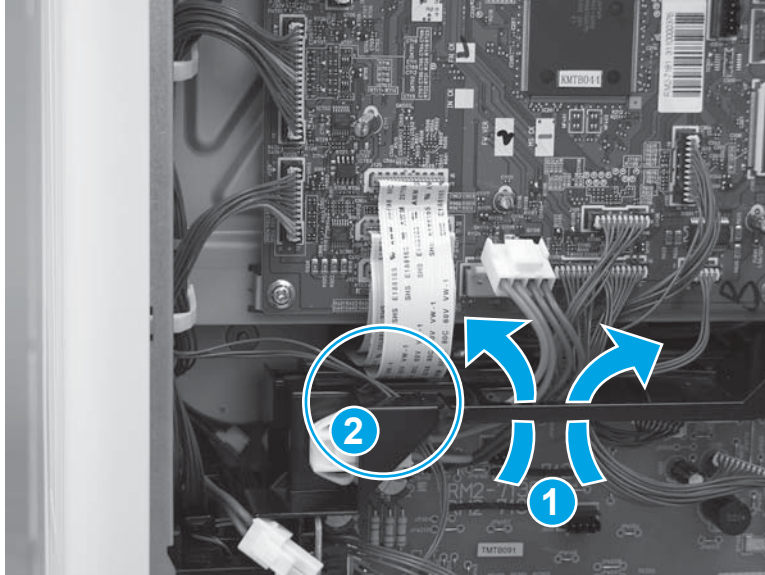

4. Connect three connectors on the DC controller (callout 1), and then connect four connectors (callout 2) on the LVPS.

Figure 1-1618 Connect seven connectors

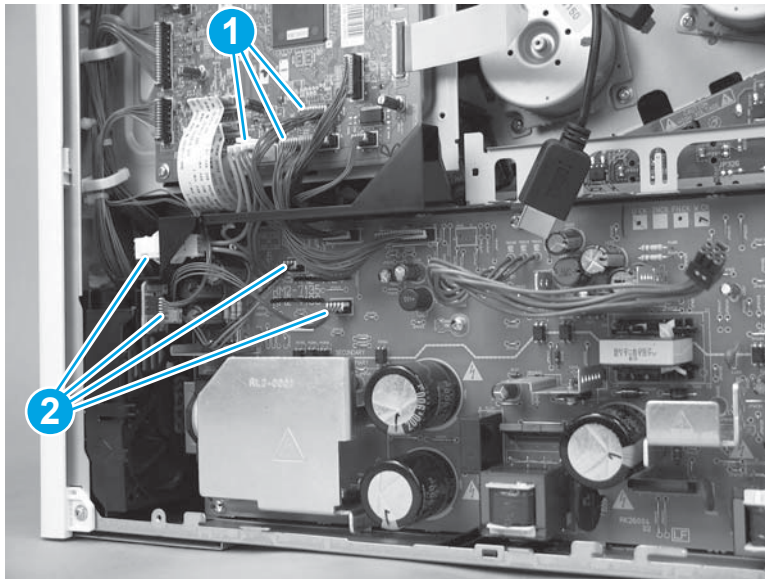

5. Pass the wire harness through the opening (callout 1) in the chassis, and then connect one wire harness (callout 2).

Figure 1-1619 Connect one wire harness

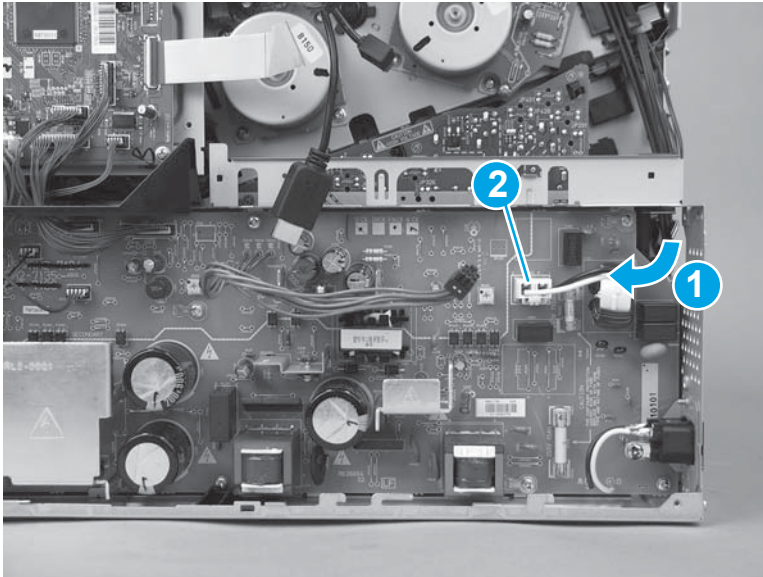

Step 15: Install the formatter case

1. Pass the wire harnesses through the opening in the formatter case.

Figure 1-1620 Pass the wire harnesses through the opening

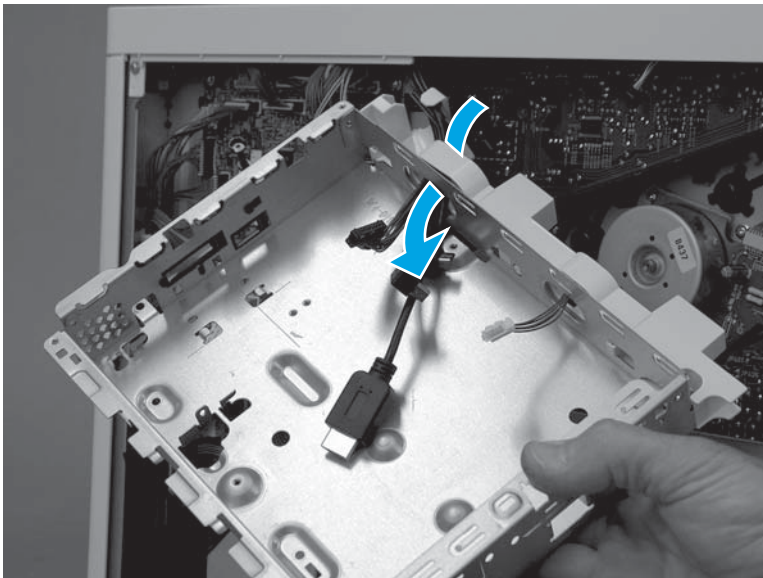

2. Position the top of the formatter case on the printer (callout 1), and then rotate the bottom of the case (callout 2) into the printer.

Figure 1-1621 Install the formatter case

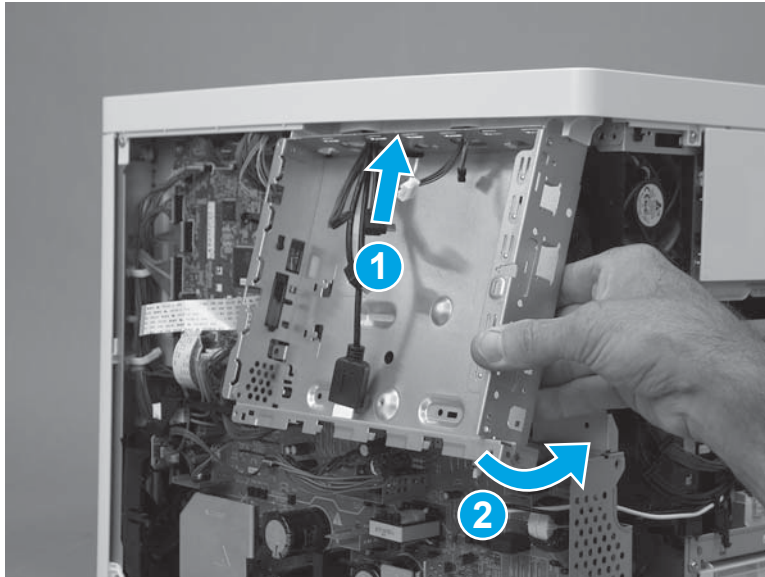

3. Install six screws (callout 1).

Figure 1-1622 Install six screws

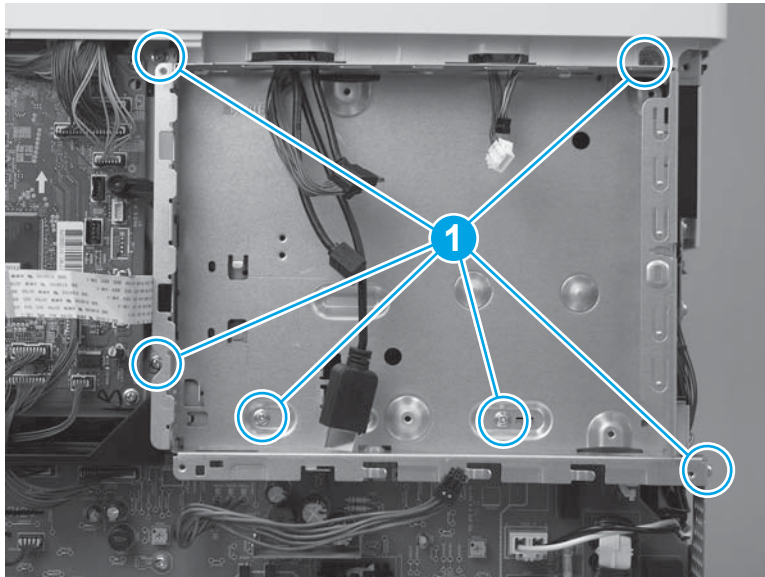

4. Pass two wire harnesses and one flat cable (callout 1) through the opening in the formatter case, and then install one wire harness in the retainer (callout 2).

 **IMPORTANT:** Make sure that the flat cable is securely fastened to the DC controller, and was not dislodged when the formatter case was removed.

Figure 1-1623 Install wire harnesses and flat cable



5. Position the LVPS cover on the printer, slide the cover to the left to install it, and then install two screws (callout 1).

Figure 1-1624 Install the LVPS cover

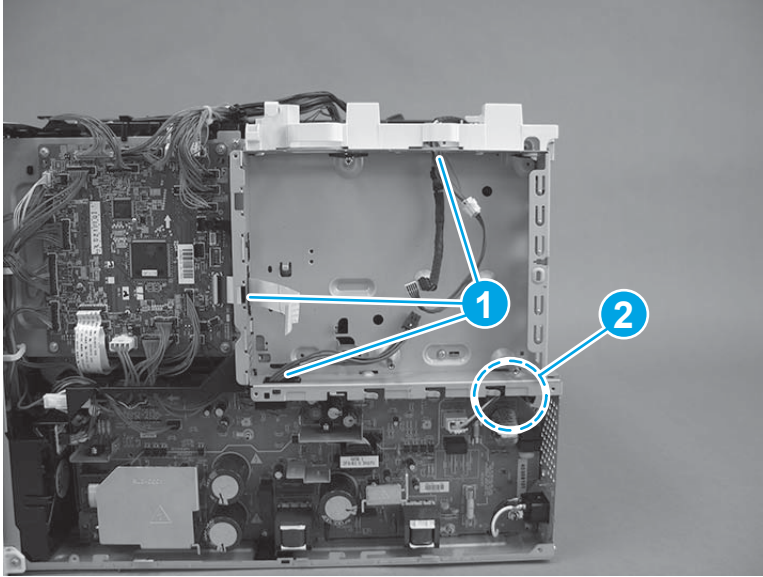
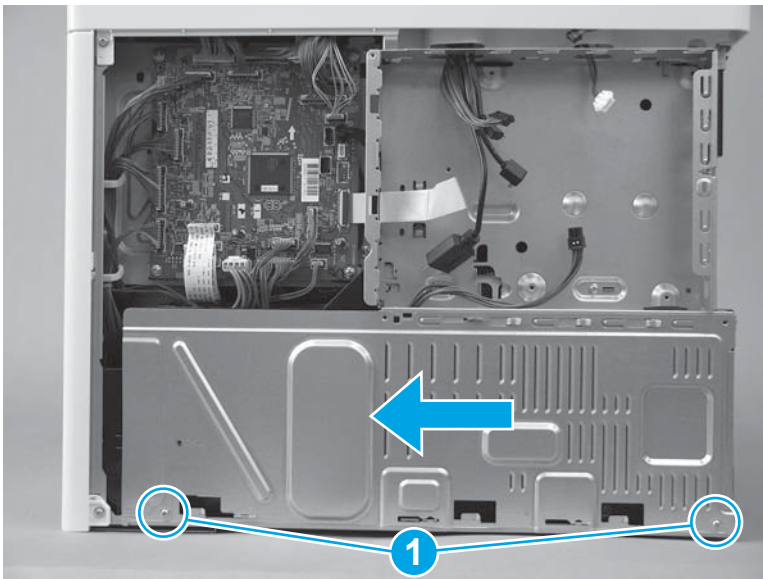

6. If no tape is affixed to the back of the flat cable, skip this step. If double-sided tape is affixed to the back of the flat cable, align the line (callout 1) on the cable with the edge (callout 2) of the opening in the sheet metal. Press to attach the flat cable to the formatter case.

Figure 1-1625 Attach the flat cable

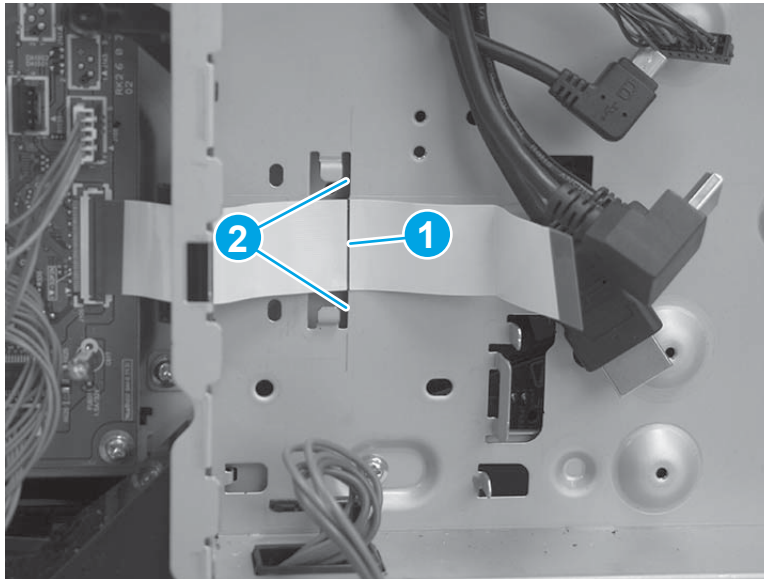

7. Position the bracket over the flat cable, and then slide the bracket to the left to install it. Make sure that the edges of the bracket fit under the sheet metal tabs (callout 1) on the formatter case and that the tabs (callout 2) snap into place.

Figure 1-1626 Position the bracket

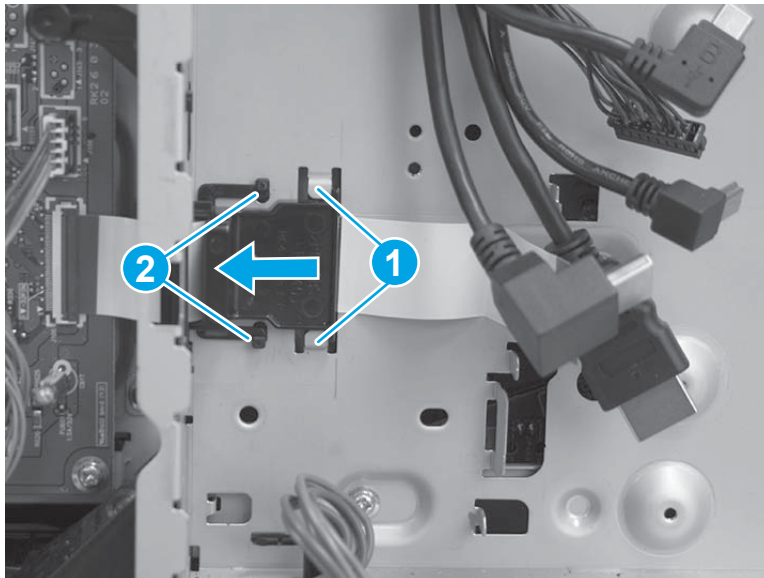

- 8. M577 only:** Pass the wire harness (callout 1) through the openings in the formatter case (callout 2), and then connect one connector (callout 3).

Figure 1-1627 Connect one connector

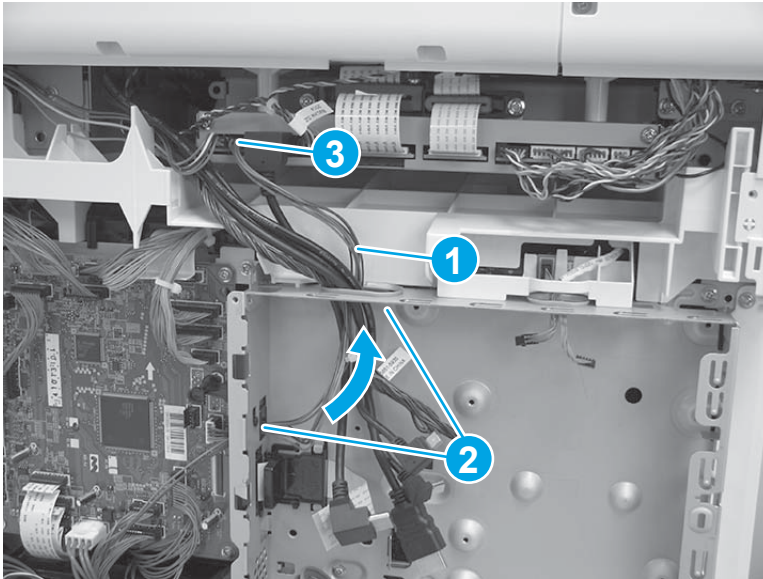

Step 16: Install the left cover

1. Position the cover on the printer.

 **NOTE:** Slightly offset the cover toward the rear of the printer.

Figure 1-1628 Install the cover

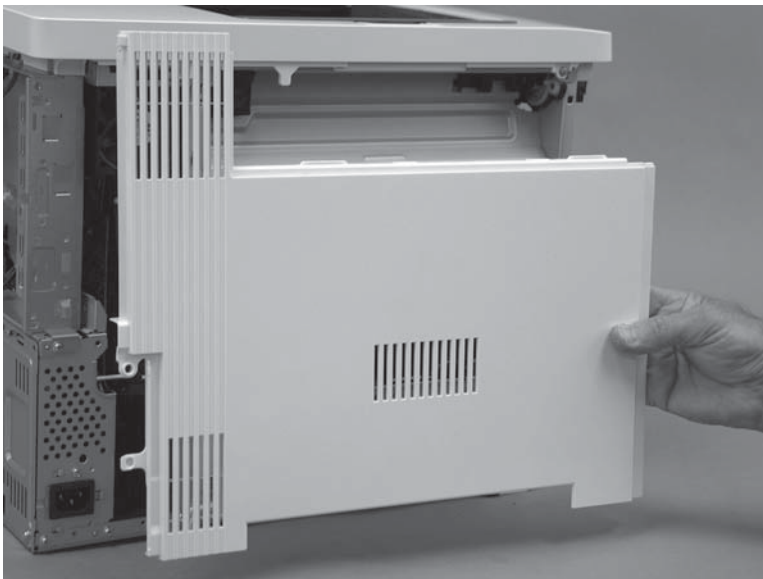

- Slide the cover (callout 1) toward the front of the printer to engage it. Make sure that the tab (callout 2) snaps into place.

 **NOTE:** Locate the alignment pin (callout 3) on the cover from the front door side of the printer, and then make sure that it is fully engaged in the slot in the chassis.

 **TIP:** While sliding the cover into place, push in on the center of the cover (callout 1) to make sure that the hooks on the back of the cover engage with the slots in the chassis.

Figure 1-1629 Engage the cover



- At the left side of the printer, install one screw (callout 1).

Figure 1-1630 Install one screw

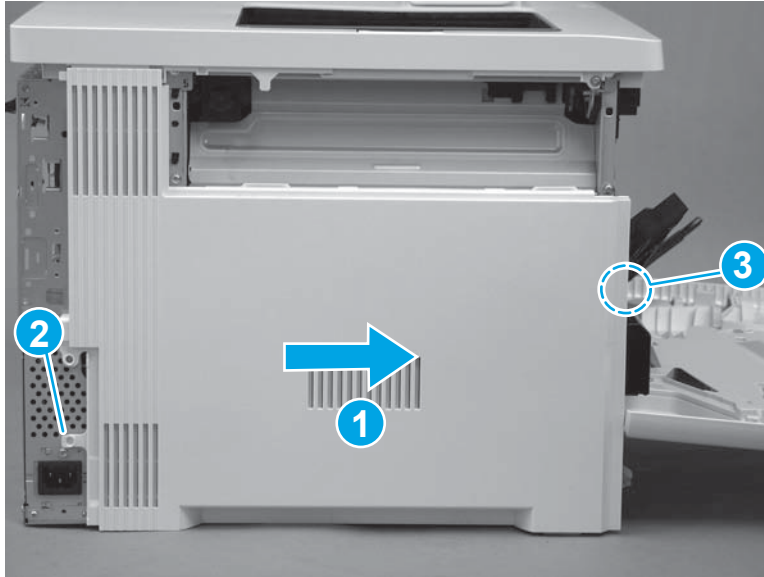

Step 17: Install the rear cover (M577)

 **NOTE:** This step is for the M577 models. For the M552 and M553 models, skip this step and go to [Step 19: Install the rear cover \(M552 and M553\) on page 937](#).

1. Position the hooks (callout 1) on the cover in the slots (callout 2) in the printer.

Figure 1-1631 Position the hooks

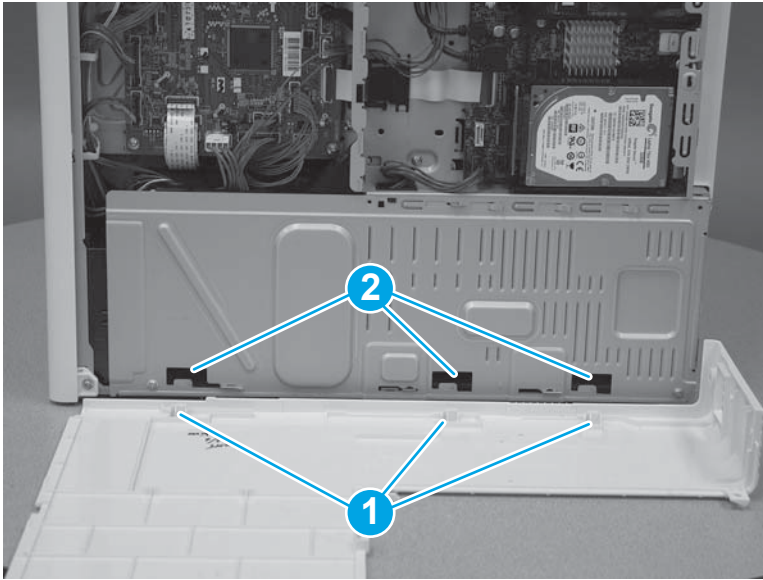

2. Position the back edge (callout 1) of the rear cover behind the edge (callout 2) of the right rear cover. Slide the cover to the left to install it.

Figure 1-1632 Install the cover

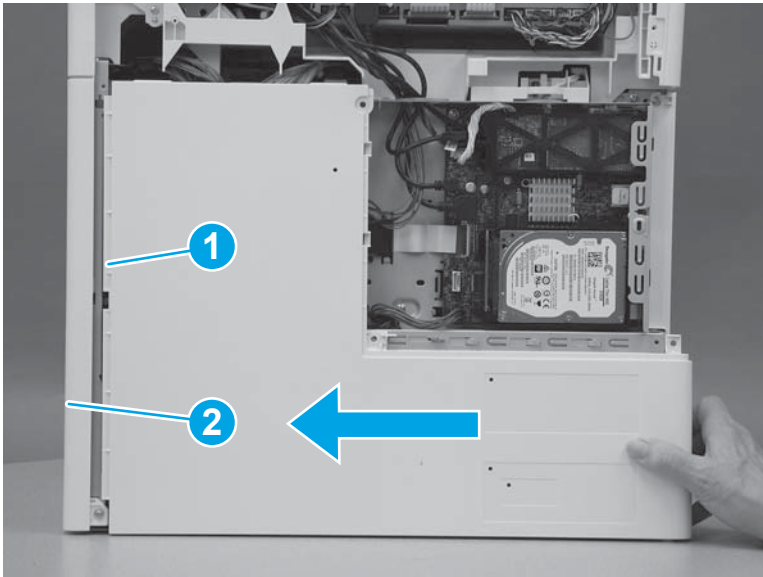

3. Install four screws (callout 1).

Figure 1-1633 Install four screws cover

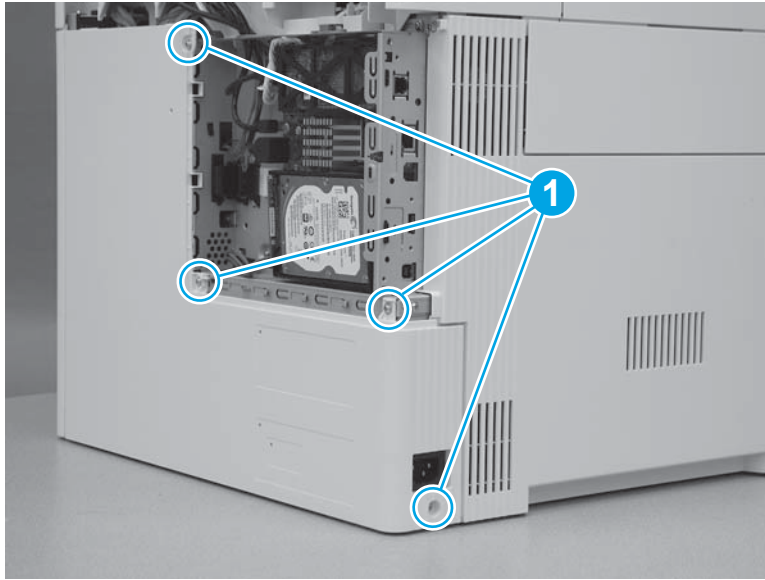

Step 18: Install the rear upper cover (M577)

 **NOTE:** This step is for the M577 models. For the M552 and M553 models, skip this step and go to [Step 19: Install the rear cover \(M552 and M553\) on page 937](#).

1. Align the ridge (callout 1) on the lower edge of the rear upper cover in front of the tabs (callout 2) on the top edge of the rear cover.

Figure 1-1634 Align the cover

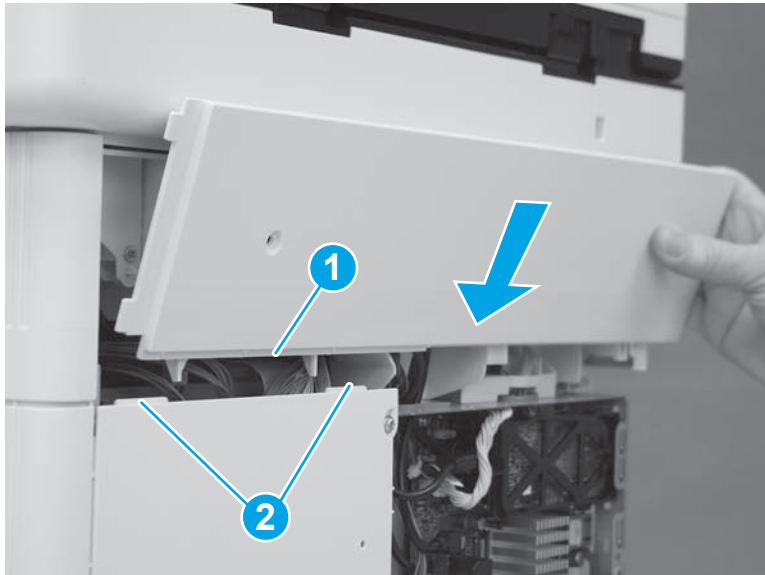

2. Rotate the top of the cover toward the printer.

Figure 1-1635 Rotate the top of the cover

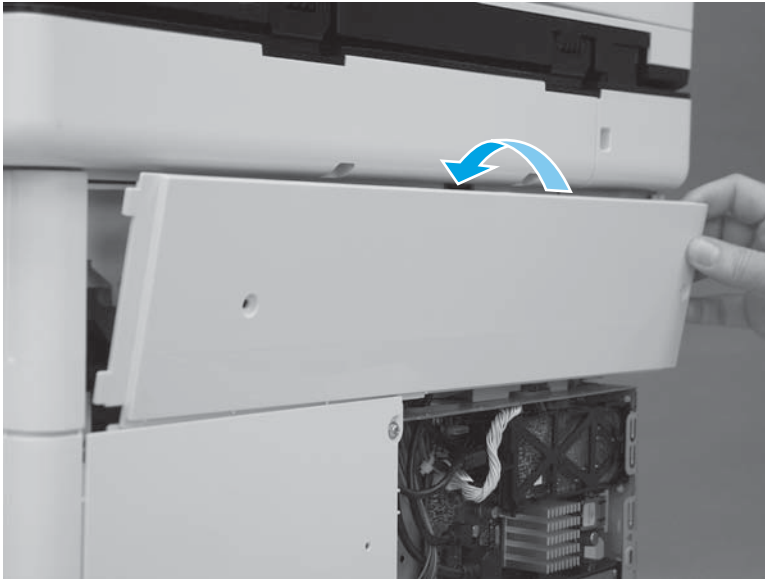

3. Slide the cover to the left (callout 1). Make sure that the tabs (callout 2) on the upper rear cover slide behind the edge (callout 3) of the right upper cover. Make sure that the cover is fully seated.

Figure 1-1636 Slide the cover

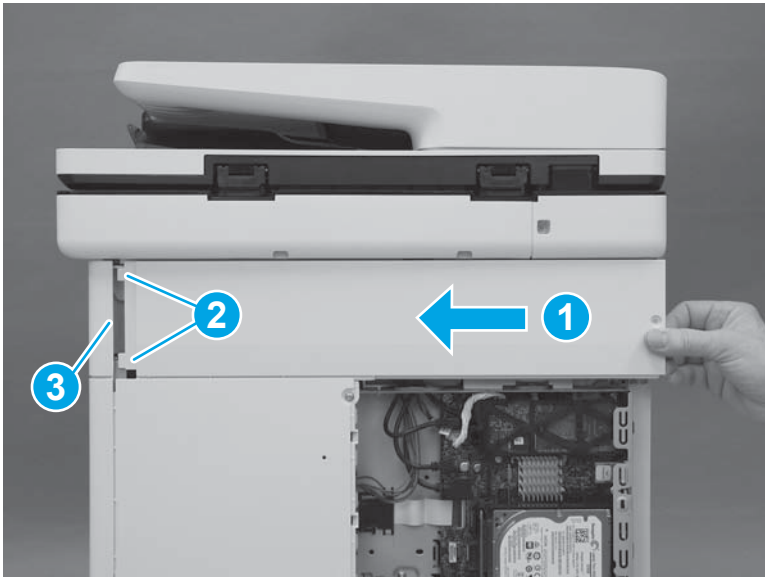

4. Install two screws (callout 1).

 **IMPORTANT:** These two screws are self-tapping screws for plastic. Rotate them counterclockwise to align them with the existing thread pattern, and then carefully turn them clockwise to tighten. Do not overtighten. This will prevent stripping the threads inside the screw holes.

Figure 1-1637 Install two screws



Step 19: Install the rear cover (M552 and M553)

 **NOTE:** This step is for the M552 and M553 models. For the M577 models, skip this step and go to [Step 20: Install the formatter \(M577\) on page 938](#).

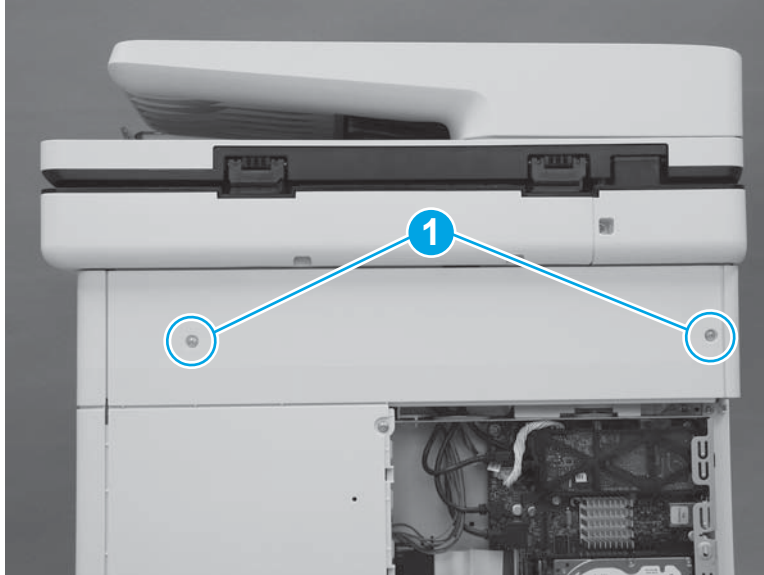
1. Position the top of the cover under the upper cover (callout 1), rotate the bottom of the cover onto the chassis (callout 2), and then slide the cover to the left (callout 3) to install it.

Figure 1-1638 Install the cover

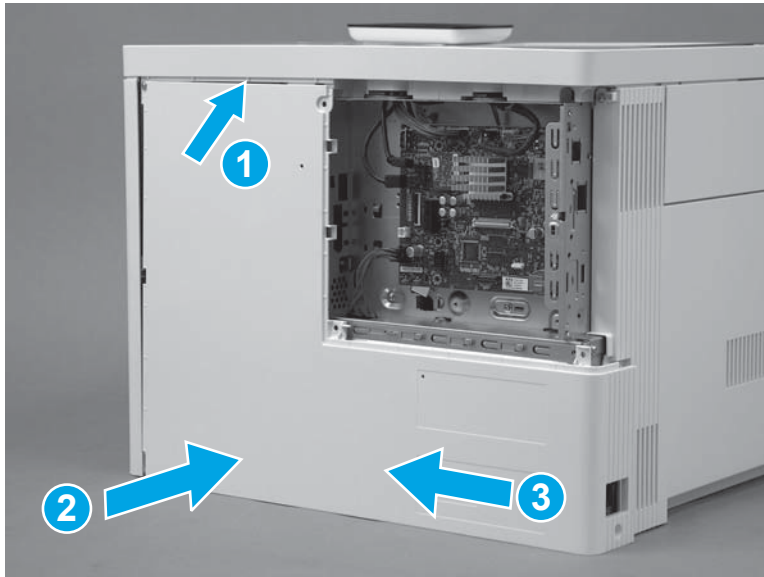

2. Install four screws (callout 1).

Figure 1-1639 Install four screws cover

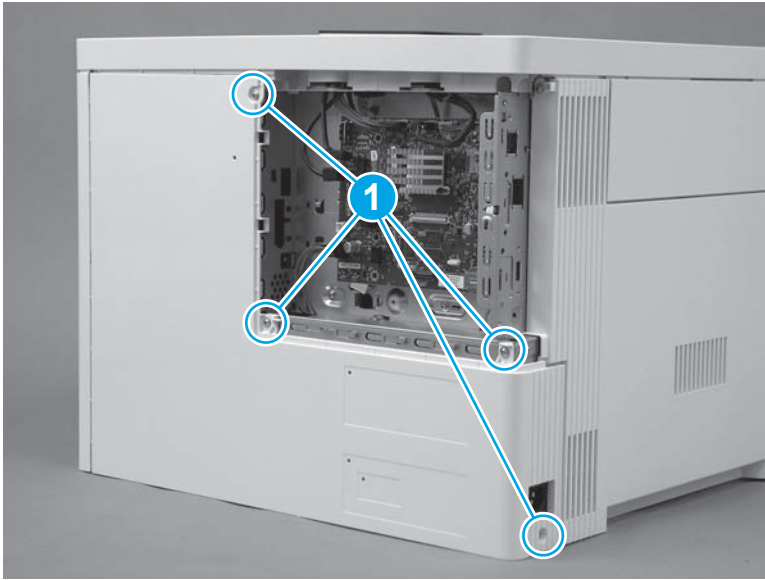

Step 20: Install the formatter (M577)



NOTE: This step is for the M577 models. For the M552 and M553 models, skip this step and to go [Step 23: Install the formatter \(M552 and M553\) on page 943](#).



CAUTION:  ESD-sensitive part.

1. Position the formatter in the printer. Make sure that the network port (callout 1) fits through the opening (callout 2) in the formatter case.

Figure 1-1640 Install the formatter

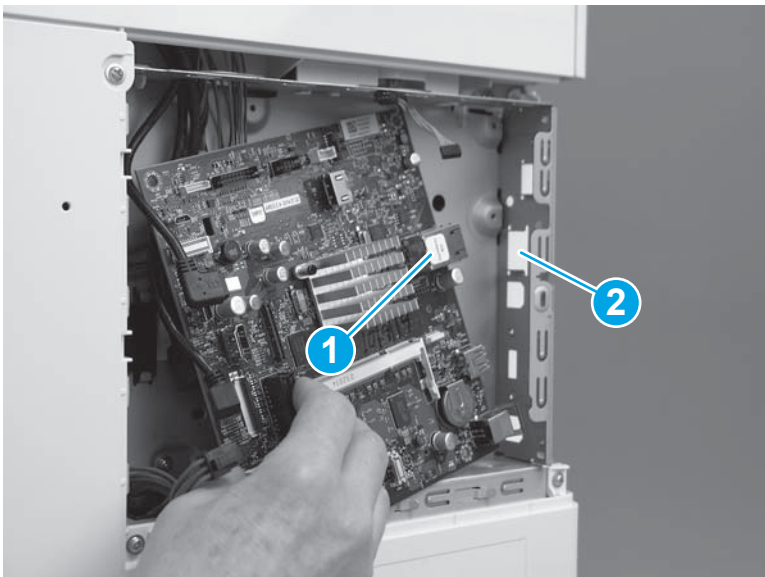

2. Install four screws (callout 1).

Figure 1-1641 Install four screws

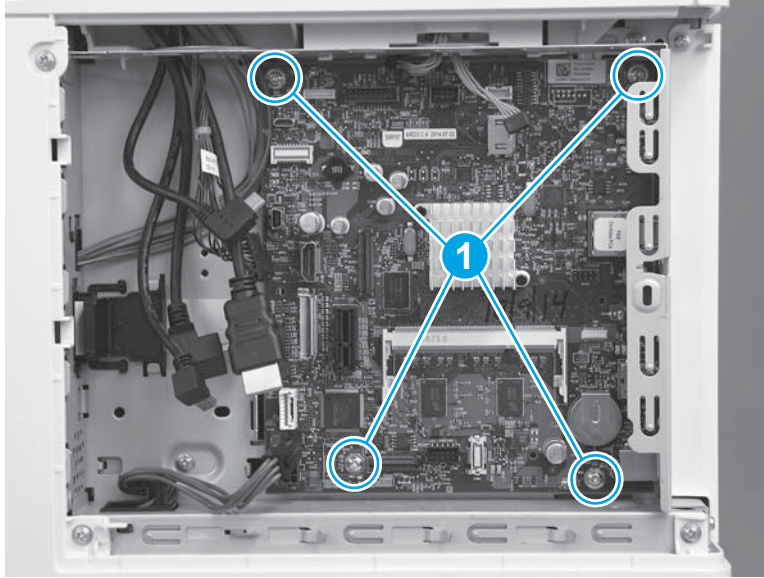

3. Connect all of the connectors on the formatter.

The following connectors are empty:

- All models: J1 (this connector is empty unless the optional DIMM is installed)
- All models: J3
- M577dn: J15 (this is the fax connector for the M577f/z/c models)
- All models: J21 (this connector is empty unless the optional internal USB ports component is installed)
- All models: J23
- All models: J24
- All models: J51
- All models: J57
- All models: J97
- All models: J98 (this connector is empty unless the optional trusted platform module (TPM) is installed)

 **IMPORTANT:** The flat-cable connector (callout 1) is a Zero Insertion Force (ZIF) connector that uses a hinged retainer to secure the flat cable. The hinged retainer must be opened to install the flat cable, and then closed after the cable is installed.

Figure 1-1642 Connect all connectors



Step 21: Install the fax PCA (M577c/f/z)

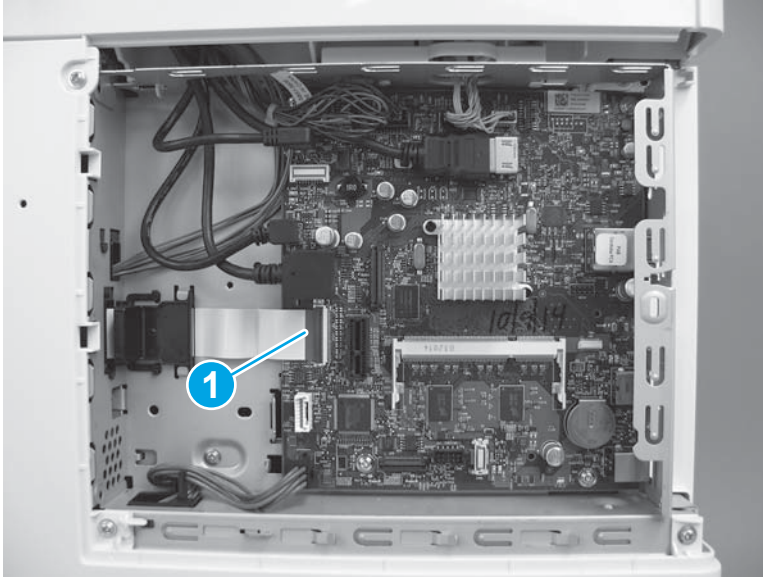

NOTE: This step is for the M577c/f/z models. For the M577n model, skip this step and go to [Step 22: Install the HDD \(M577\) on page 941](#).

For the M552 and M553 models, skip this step and go to [Step 23: Install the formatter \(M552 and M553\) on page 943](#).



CAUTION:  ESD-sensitive part.

1. Position the tab and telephone port (callout 1) on the fax PCA in the slots (callout 2) in the formatter case.

Figure 1-1643 Position the fax PCA

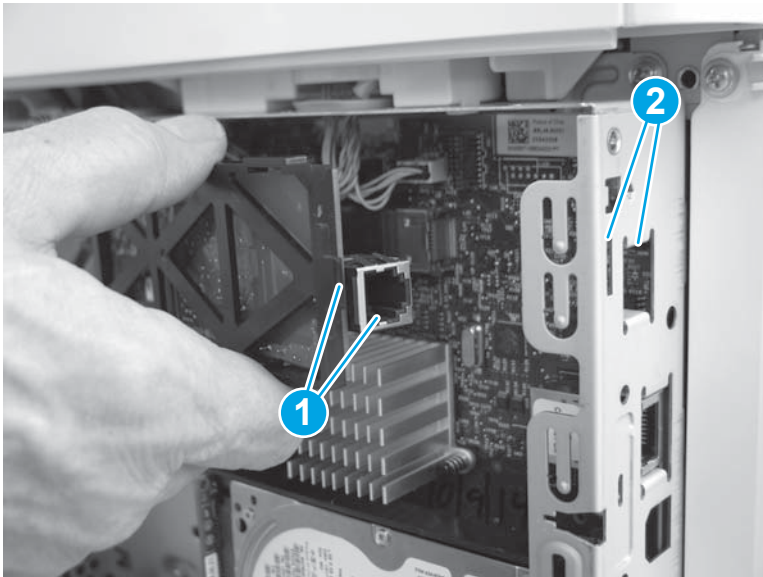

- Slide the fax PCA to the right (callout 1) until the tab and telephone port described in the previous step and seated in the formatter case. Position the retainer (callout 2) in the slot (callout 3) in the formatter. Rotate the end of the fax PCA toward the formatter (callout 4) until the retainer snaps into place.

Figure 1-1644 Install the fax PCA

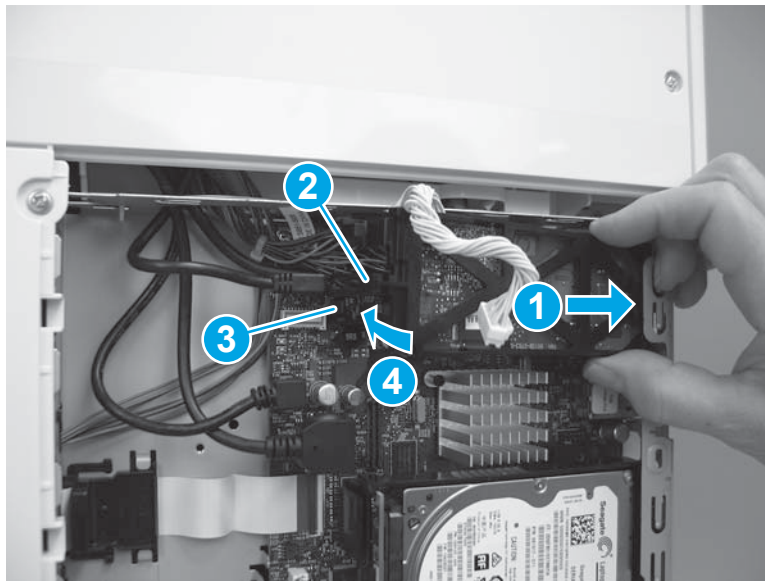

- Position the cable (callout 1) in the guide (callout 2), and then connect one connector (callout 3).

Figure 1-1645 Connect the connector

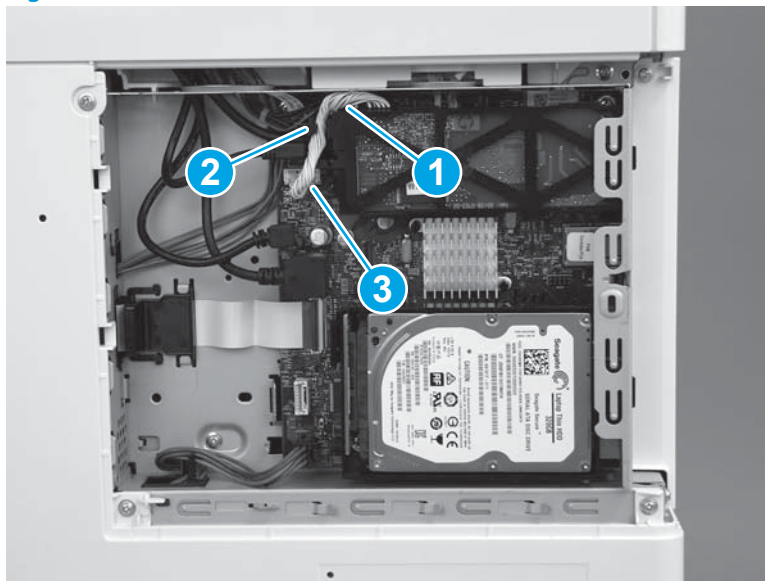

Step 22: Install the HDD (M577)

 **NOTE:** This step is for the M577 models. For the M552 and M553 models, skip this step and go to [Step 23: Install the formatter \(M552 and M553\) on page 943.](#)

 **CAUTION:**  ESD-sensitive part.

1. Align the end of the bracket (callout 1) with the slot in the chassis (callout 2), and then slide the HDD into the printer (callout 3) to engage the bracket with the chassis.

Figure 1-1646 Install the holder

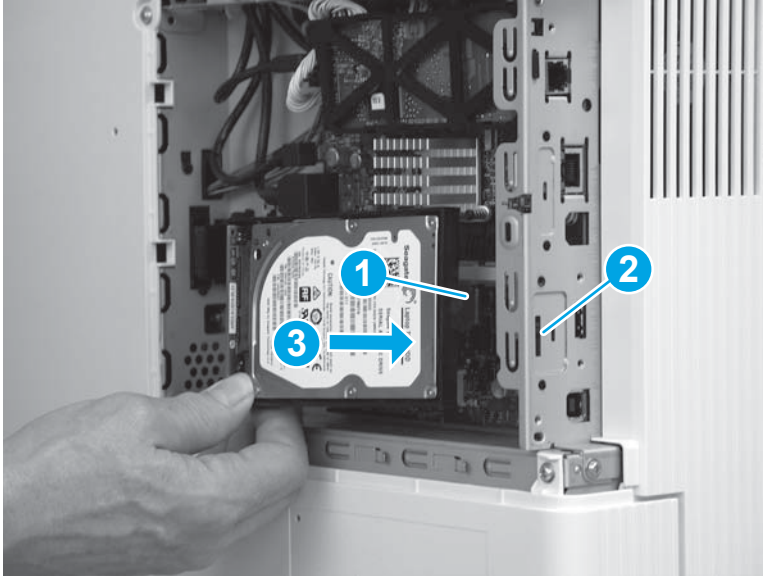

2. Hold the HDD connector latch (callout 1) in the released position, and then rotate the HDD down and into the connector on the formatter to install it.

 **NOTE:** Make sure that the tab (callout 2) snaps into place, and that the HDD is securely installed.

Figure 1-1647 Release the HDD

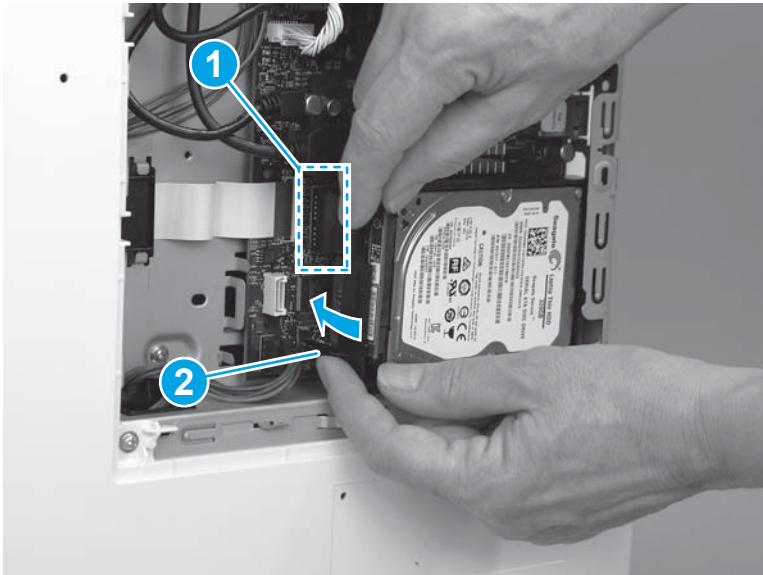

Step 23: Install the formatter (M552 and M553)

 **NOTE:** This step is for the M552 and M553 models. For the M577 models, skip this step and go to [Step 24: Install the formatter cover on page 944](#).

If the optional hard-disk drive (HDD) was removed, do not forget to reinstall it after the formatter is reinstalled.

Engage the HDD holder with the chassis, rotate the HDD connector down and into the connector on the formatter. Make sure that the tabs snap into place.

 **CAUTION:**  ESD-sensitive part.

1. Position the formatter in the printer, and then install four screws (callout 1).

Figure 1-1648 Install the formatter

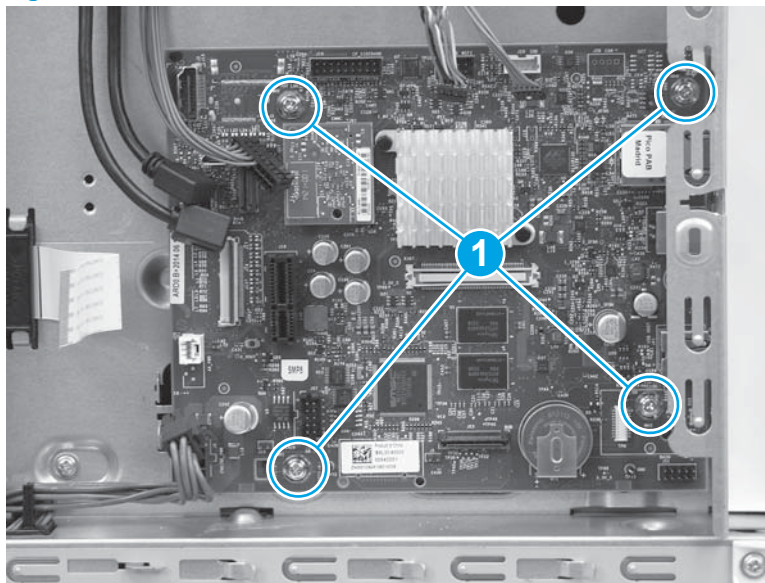

2. Connect all of the connectors on the formatter.

The following connectors are empty:

- All models: J1 (this connector is empty unless the optional DIMM is installed)
- M553n/dn and M552dn: J2 (callout 1; this is the touchscreen connector for the M553x model)
- All models: J9 (this connector is empty unless the optional internal USB ports component is installed)
- All models: J18 (this connector is empty unless the optional hard-disk-drive (HDD) is installed)
- All models: J23
- All models: J24
- M553n/dn and M552dn: J25 (this is the wireless connector for the M553x model)

- All models: J57
- All models: J98 (this connector is empty unless the optional trusted platform module (TPM) is installed)



 **IMPORTANT:** The flat-cable connector (callout 2) is a Zero Insertion Force (ZIF) connector that uses a hinged retainer to secure the flat cable. The hinged retainer must be opened to install the flat cable.

Figure 1-1649 Connect all connectors

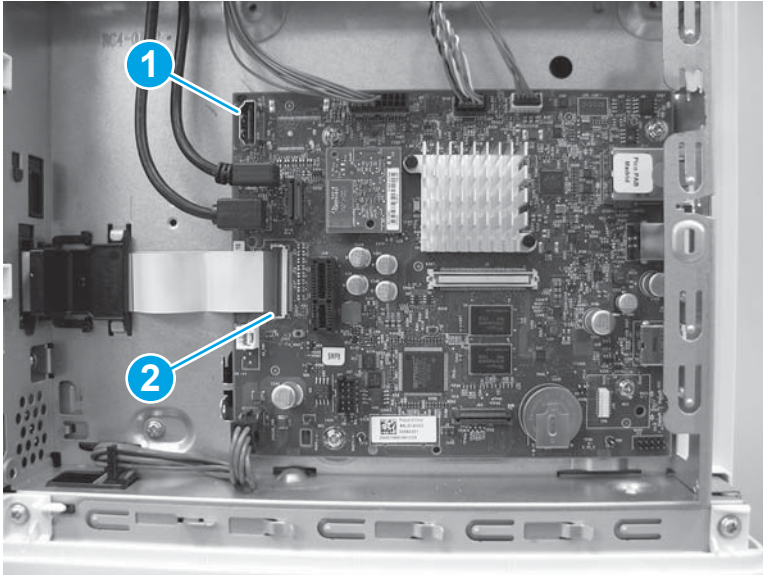

Step 24: Install the formatter cover

- ▲ Slide the cover onto the printer (callout 1) to install it.

 **NOTE:** Make sure that the tabs on the formatter cover align with the slots provided in the printer (callout 2). Tighten the two thumbscrews (callout 3).

 **TIP:** If needed, use the edge of a coin to turn the thumbscrews.

Figure 1-1650 Install the cover



Step 25: Install the TCU

1. Verify that the toner collection hatch cover is in the closed position on the TCU.

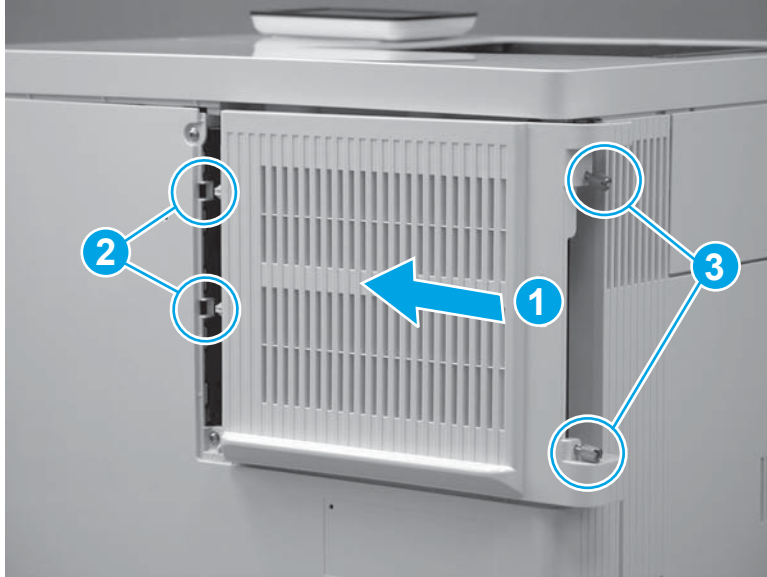
Figure 1-1651 Verify that the toner collection hatch cover is closed

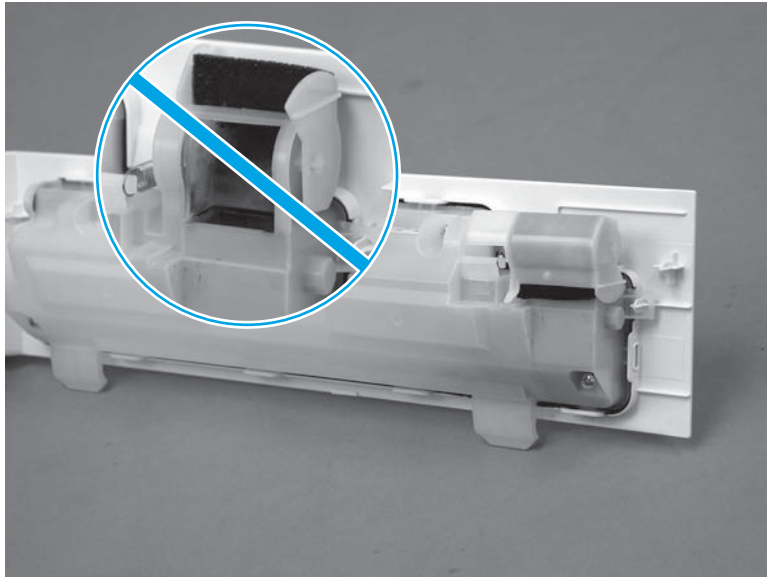

2. Position the TCU with the hinges in the slots provided in the printer (callout 1), and then rotate the TCU up and into the closed position.

 **NOTE:** The toner collection hatch cover automatically opens when the TCU is closed.

Figure 1-1652 Install the TCU



3. Close the front door.

Figure 1-1653 Close the front door

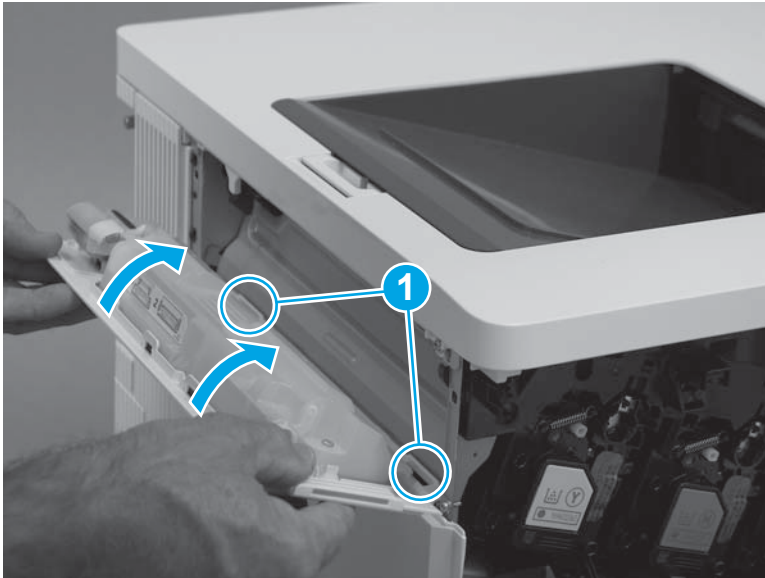

Removal and replacement: High-voltage power supply D (HVPSD)

- [Introduction](#)
- [Step 1: Remove the toner collection unit \(TCU\)](#)
- [Step 2: Remove the formatter cover](#)
- [Step 3: Remove the formatter \(M552 and M553\)](#)
- [Step 4: Remove the hard-disk drive \(HDD\) \(M577\)](#)
- [Step 5: Remove the fax PCA \(M577c/f/z\)](#)
- [Step 6: Remove the formatter \(M577\)](#)
- [Step 7: Remove the rear cover \(M552 and M553\)](#)
- [Step 8: Remove the rear upper cover \(M577\)](#)
- [Step 9: Remove the rear cover \(M577\)](#)
- [Step 10: Remove the left cover](#)
- [Step 11: Remove the formatter case](#)
- [Step 12: Remove the low-voltage power supply \(LVPS\)](#)
- [Step 13: Remove the high-voltage power supply D \(HVPSD\)](#)
- [Step 14: Unpack the replacement assembly](#)
- [Step 15: Install the HVPSD](#)
- [Step 16: Install the LVPS](#)
- [Step 17: Install the formatter case](#)
- [Step 18: Install the left cover](#)
- [Step 19: Install the rear cover \(M577\)](#)
- [Step 20: Install the rear upper cover \(M577\)](#)
- [Step 21: Install the rear cover \(M552 and M553\)](#)
- [Step 22: Install the formatter \(M577\)](#)
- [Step 23: Install the fax PCA \(M577c/f/z\)](#)
- [Step 24: Install the HDD \(M577\)](#)
- [Step 25: Install the formatter \(M552 and M553\)](#)
- [Step 26: Install the formatter cover](#)
- [Step 27: Install the TCU](#)

Introduction



This document provides the procedures to remove and replace the high-voltage power supply D (HVPSD).

Before performing service

Turn the printer power off

- Disconnect the power cable.

 **WARNING!** To avoid damage to the printer, turn the printer off, wait 30 seconds, and then remove the power cord before attempting to service the printer.

 **CAUTION:**  This part contains components that are electrostatic discharge (ESD) sensitive. To reduce the possibility of ESD damage, always touch the sheet-metal chassis to ground yourself before touching an ESD sensitive part.

Use the table below to identify the correct part number for your printer, and then go to <http://h20141.www2.hp.com/hpparts> to order the part.

High-voltage power supply D (HVPSD) part number

RM2-7122-000CN

High-voltage power supply D (HVPSD)

Required tools

- #2 Phillips screwdriver with a magnetic tip

After performing service

Make sure that all of the connectors on the HVPSD are fully seated.

Make sure that all of the connectors on the LVPS are fully seated.

Make sure that all of the connectors on the formatter are fully seated.

Make sure that the formatter cover is fully seated, and that the thumbscrews are finger tight after replacing it.

Turn the printer power on

- Connect the power cable.
- Use the power switch to turn the power on.

Post service test

Print a configuration page to make sure that the printer is functioning correctly.

Step 1: Remove the toner collection unit (TCU)

1. Open the front door.

Figure 1-1654 Open the front door



2. Open the TCU.

 **NOTE:** The toner collection hatch cover automatically closes when the TCU is opened.

Figure 1-1655 Open the TCU



3. Pull the TCU away from the printer at an angle to remove it.

⚠ CAUTION: Do not open the toner collection hatch cover when handling the TCU. If toner gets on clothing, wipe it off by using a dry cloth and wash the clothes in cold water. Hot water sets toner into fabric.

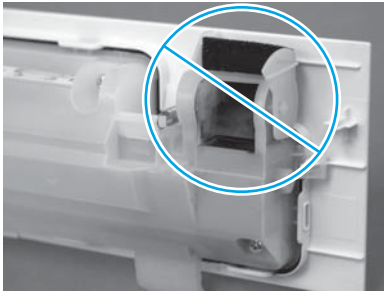
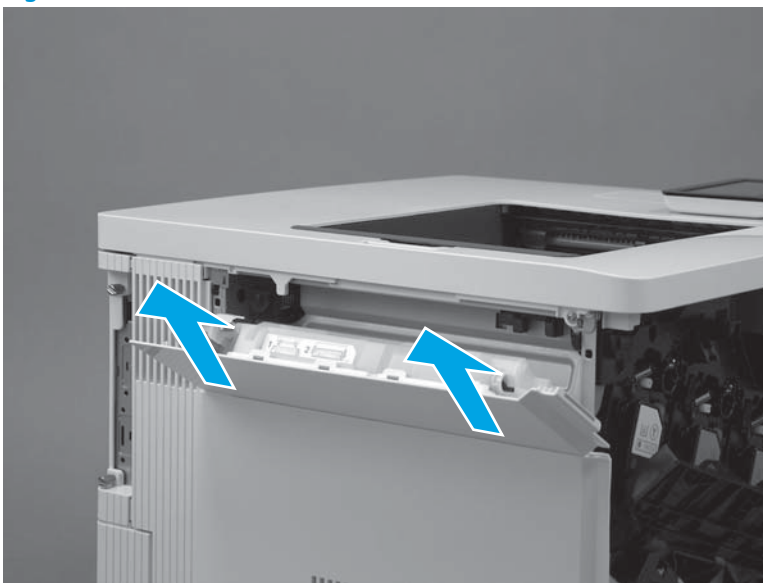

Figure 1-1656 Remove the TCU



Step 2: Remove the formatter cover

1. Locate the formatter cover.

Figure 1-1657 Locate the formatter cover

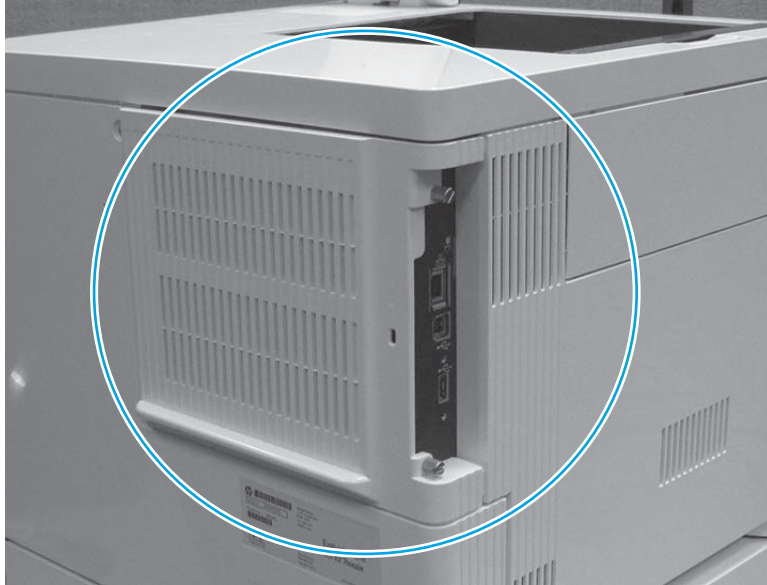

2. Loosen the two thumbscrews (callout 1). Grasp the two thumbscrews, and then slide the cover away from the printer (callout 2) to remove it.

 **TIP:** If needed, use the edge of a coin to turn the thumbscrews.

Figure 1-1658 Loosen the thumbscrews



Step 3: Remove the formatter (M552 and M553)

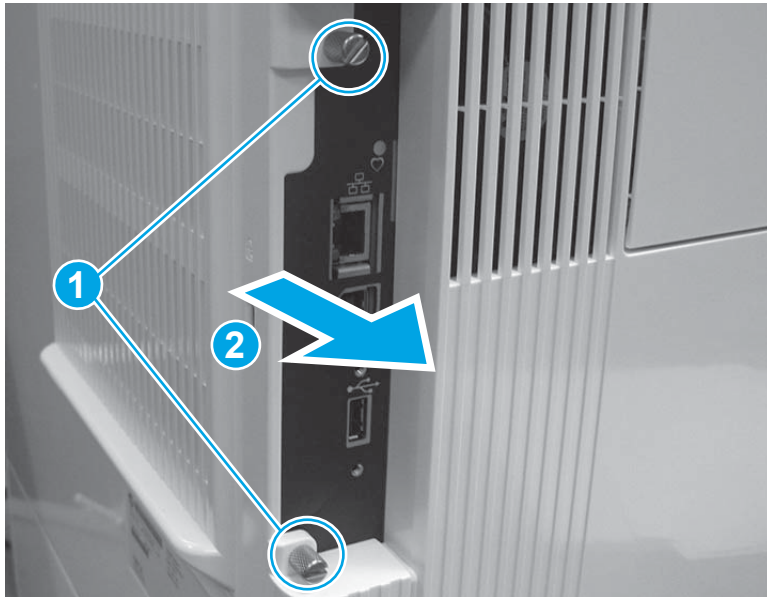

NOTE: This step is for the M552 and M553 models. For the M577 models, skip this step and go to [Step 4: Remove the hard-disk drive \(HDD\) \(M577\) on page 953](#).

If the optional hard-disk drive (HDD) is installed, it must be removed to gain access to the formatter mounting screws.

Release two tabs along the left edge of the HDD, rotate the left edge away from the product, and then slide the HDD to the left to remove it.



CAUTION:  ESD-sensitive part.

1. Disconnect all of the connectors on the formatter.

The following connectors are empty:

- All models: J1 (this connector is empty unless the optional DIMM is installed)
- M553n/dn and M552dn: J2 (callout 1; this is the touchscreen connector for the M553x model)
- All models: J9 (this connector is empty unless the optional internal USB ports component is installed)
- All models: J18 (this connector is empty unless the optional hard-disk-drive (HDD) is installed)
- All models: J23
- All models: J24
- M553n/dn and M552dn: J25 (this is the wireless connector for the M553x model)
- All models: J57
- All models: J98 (this connector is empty unless the optional trusted platform module (TPM) is installed)



IMPORTANT: The flat-cable connector (callout 2) is a Zero Insertion Force (ZIF) connector that uses a hinged retainer to secure the flat cable. The hinged retainer must be opened to release the flat cable.

Figure 1-1659 Disconnect all connectors

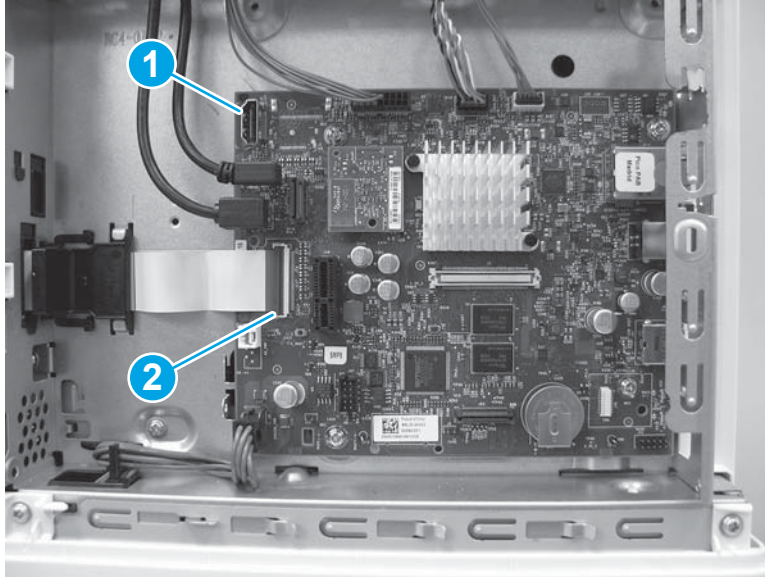

2. Remove four screws (callout 1), and then remove the formatter.

Figure 1-1660 Remove the formatter

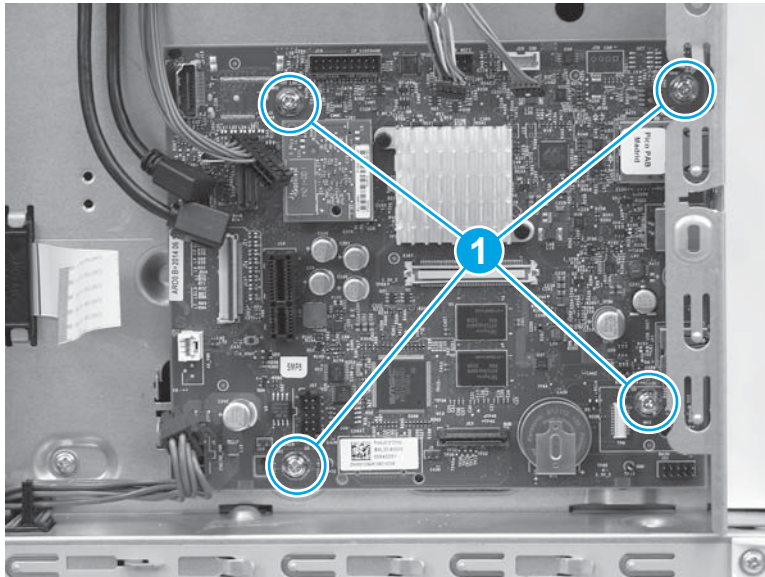

Step 4: Remove the hard-disk drive (HDD) (M577)



NOTE: This step is for the M577 models. For the M552 and M553 models, skip this step and go to [Step 7: Remove the rear cover \(M552 and M553\) on page 958](#).



CAUTION:  ESD-sensitive part.

1. Release two tabs (callout 1). Hold the tabs in the released position, and then rotate the hard disk drive (HDD) up (callout 2) to release the connector from the formatter.

Figure 1-1661 Release the HDD

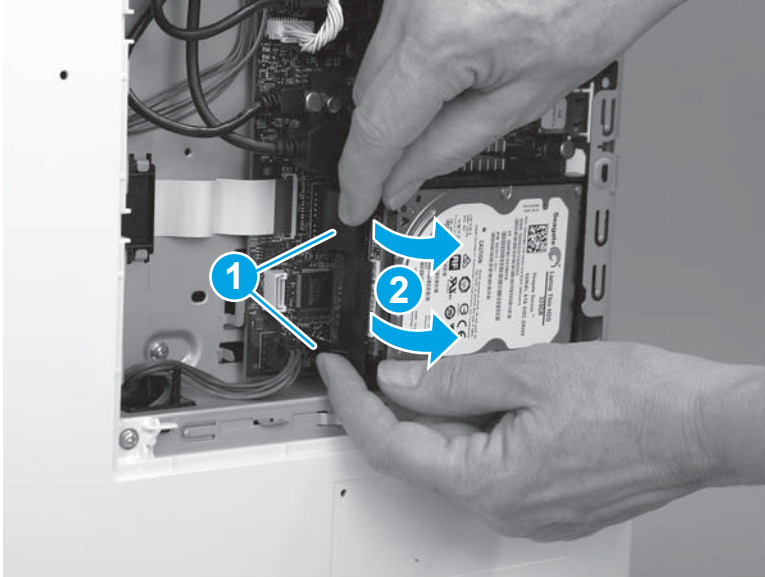

2. Slide the HDD away from the printer to remove it.

Figure 1-1662 Remove the HDD



Step 5: Remove the fax PCA (M577c/f/z)



NOTE: This step is for the M577c/f/z models. For the M577n model, skip this step and go to [Step 6: Remove the formatter \(M577\) on page 956](#).

For the M552 and M553 models, skip this step and go to [Step 7: Remove the rear cover \(M552 and M553\) on page 958](#).



CAUTION:  ESD-sensitive part.

1. Locate the fax PCA component on the formatter.

Figure 1-1663 Locate the fax PCA

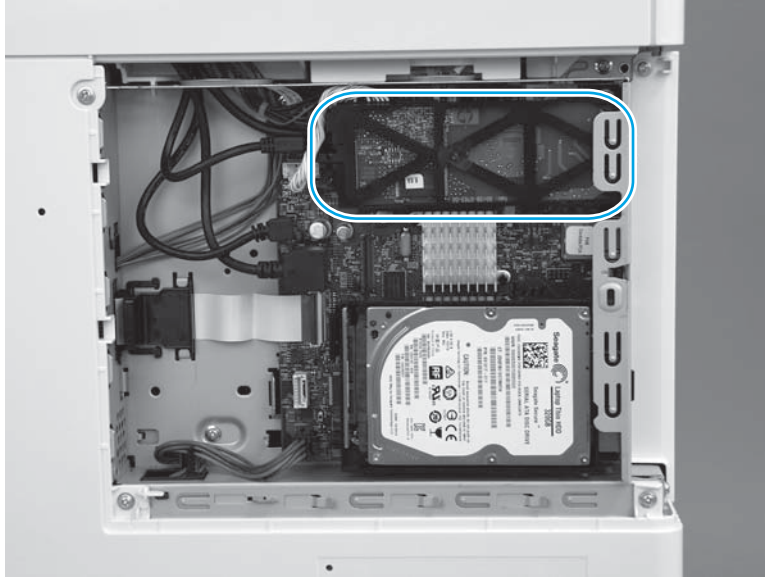

2. Release the connector latch (callout 1), and then pull the connector away from the formatter (callout 2) to disconnect it.

Figure 1-1664 Disconnect one connector

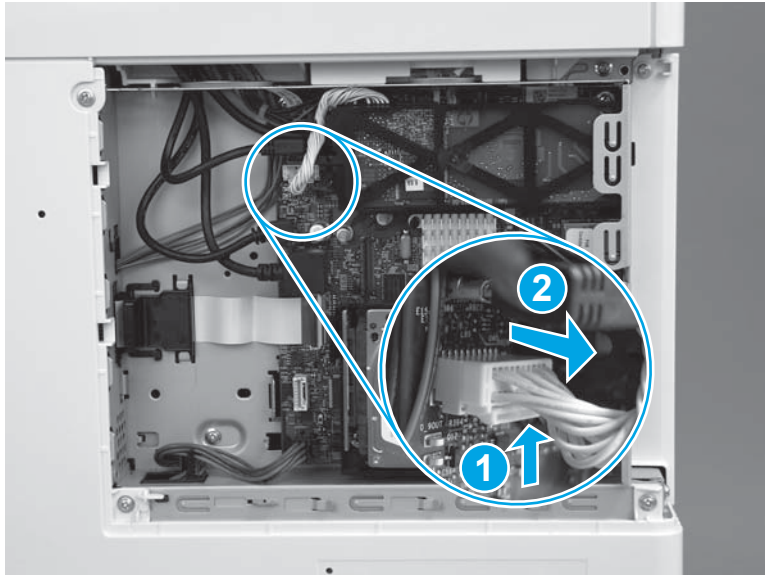

3. Release one retainer (callout 1) by pressing the bracket arms together.

Figure 1-1665 Release one latch

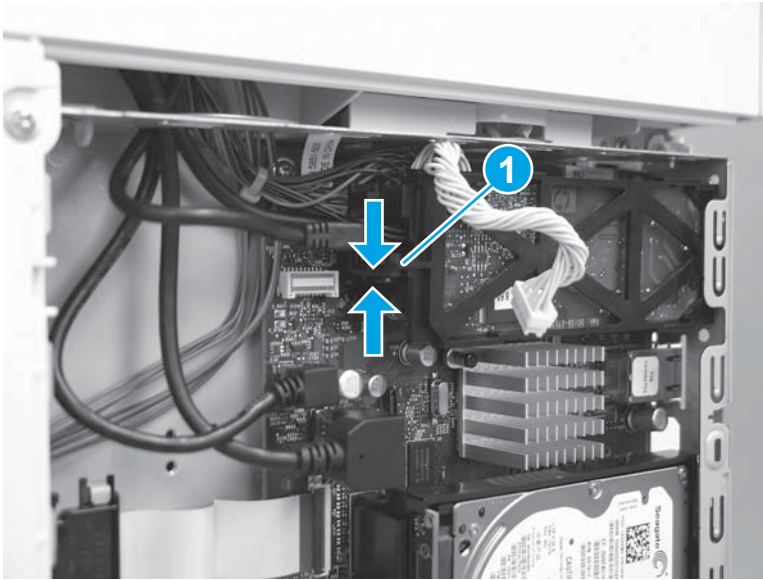

4. Rotate the end of the fax PCA (callout 1) away from the formatter, and then slide the PCA left (callout 2) to remove it.

Figure 1-1666 Remove the fax PCA

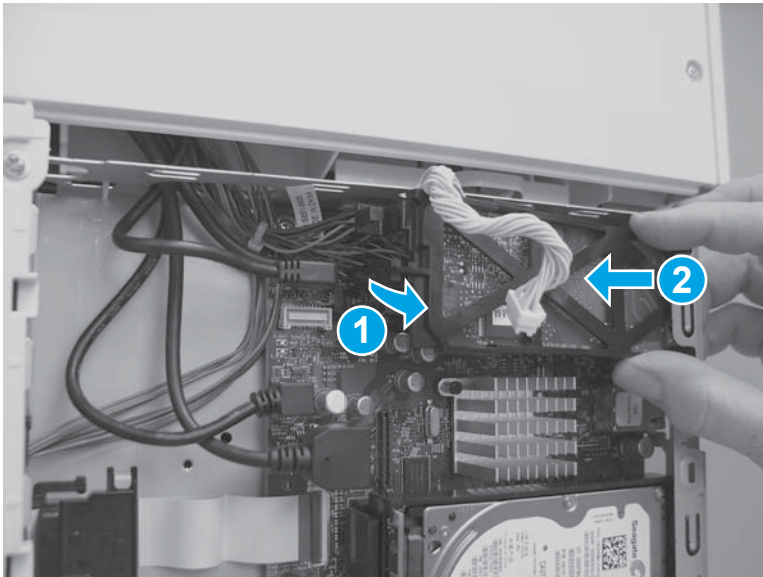

Step 6: Remove the formatter (M577)

 **NOTE:** This step is for the M577 models. For the M552 and M553 models, skip this step and go to [Step 7: Remove the rear cover \(M552 and M553\) on page 958.](#)

 **CAUTION:**  ESD-sensitive part.

1. Disconnect all of the connectors on the formatter.

The following connectors are empty:

- All models: J1 (this connector is empty unless the optional DIMM is installed)
- All models: J3
- M577dn: J15 (this is the fax connector for the M577f/z/c models)
- All models: J21 (this connector is empty unless the optional internal USB ports component is installed)
- All models: J23
- All models: J24
- All models: J51
- All models: J57
- All models: J97
- All models: J98 (this connector is empty unless the optional trusted platform module (TPM) is installed)

 **IMPORTANT:** The flat-cable connector (callout 1) is a Zero Insertion Force (ZIF) connector that uses a hinged retainer to secure the flat cable. The hinged retainer must be opened to release the flat cable.

Figure 1-1667 Disconnect all connectors



2. Remove four screws (callout 1).

Figure 1-1668 Remove four screws

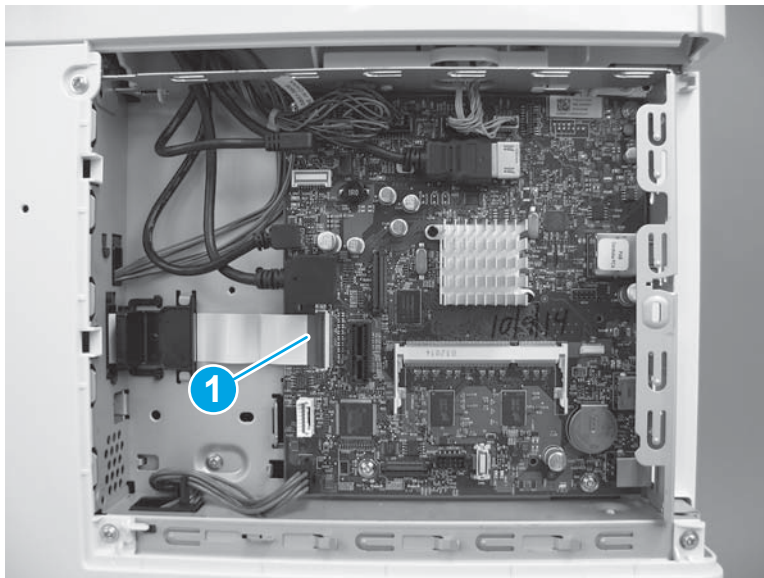
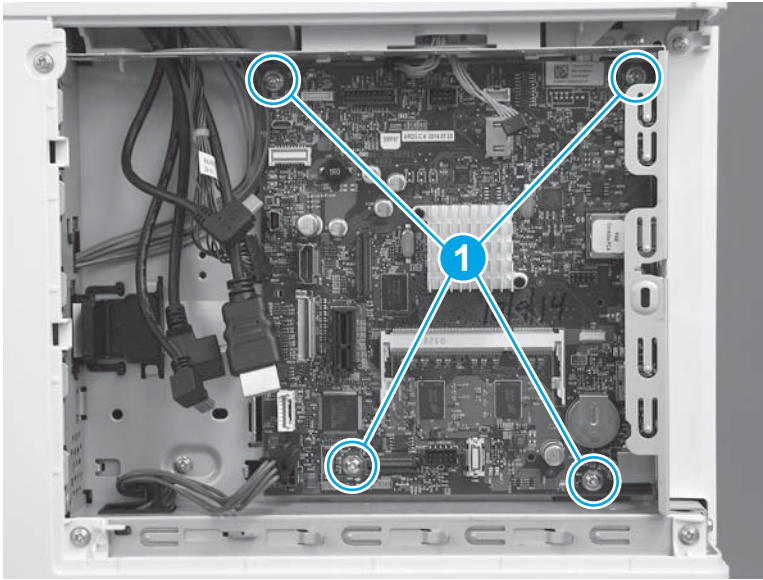

3. Remove the formatter.

Figure 1-1669 Remove the formatter

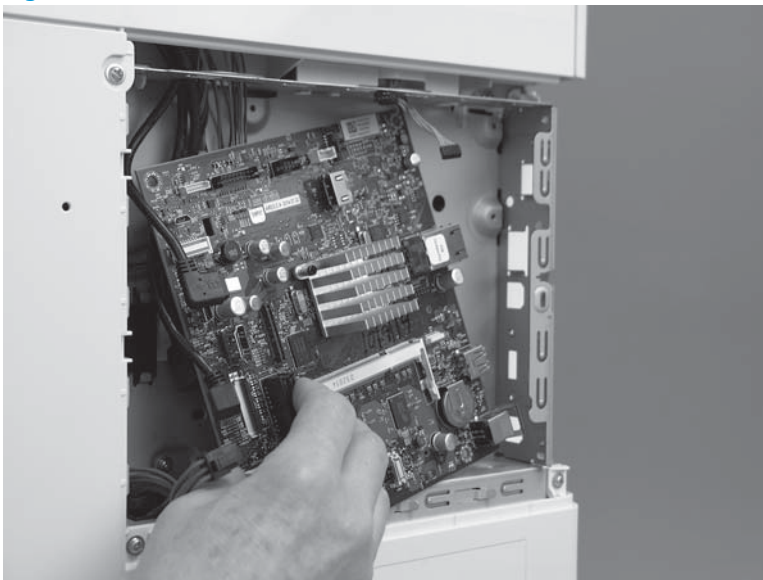

Step 7: Remove the rear cover (M552 and M553)

 **NOTE:** This step is for the M552 and M553 models. For the M577 models, skip this step and go to [Step 8: Remove the rear upper cover \(M577\) on page 959.](#)

1. Remove four screws (callout 1).

Figure 1-1670 Remove four screws

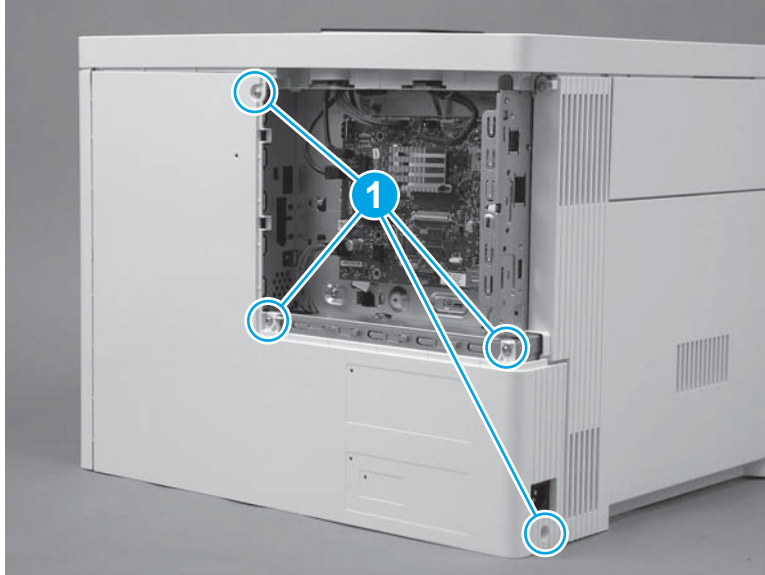

2. Slightly slide the cover to the right (callout 1), rotate the bottom of the cover away from the printer (callout 2), and then pull the top of the cover away from the printer (callout 3) to remove the cover.

Figure 1-1671 Remove the cover

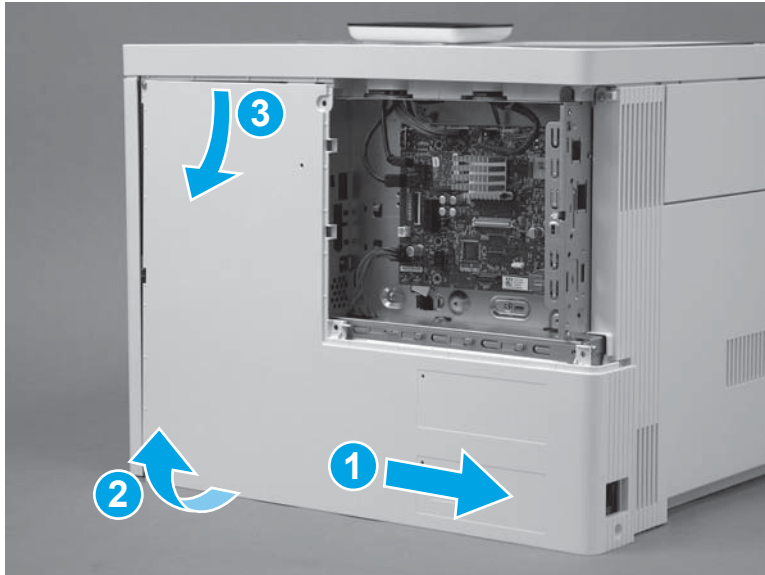

Step 8: Remove the rear upper cover (M577)



NOTE: This step is for the M577 models. For the M552 and M553 models, skip this step and go to [Step 10: Remove the left cover on page 962](#).

1. Remove two screws (callout 1).



Reinstallation tip: These two screws are self-tapping screws for plastic. When reinstalling them, rotate the screws counterclockwise to align them with the existing thread pattern, and then carefully turn them clockwise to tighten. Do not overtighten. This will prevent stripping the threads inside the screw holes.

Figure 1-1672 Remove two screws

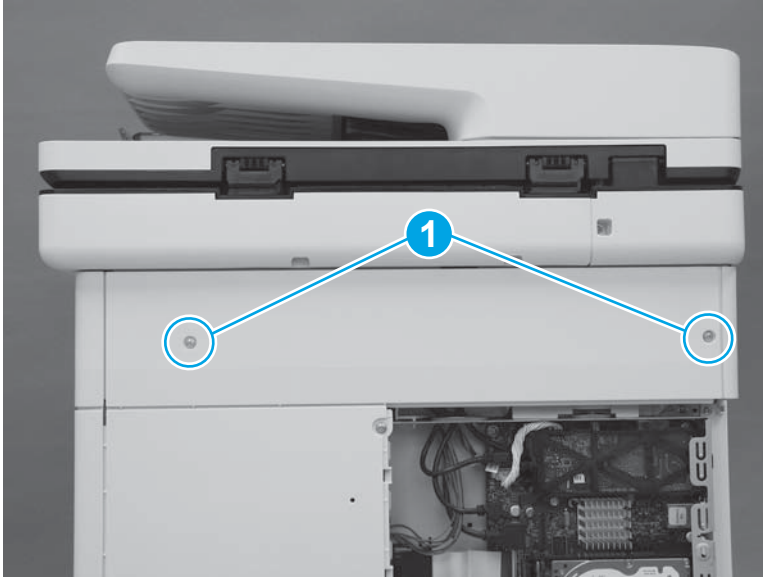

2. Use a small, flat blade screwdriver to release the right edge of the cover.

Figure 1-1673 Release the right edge

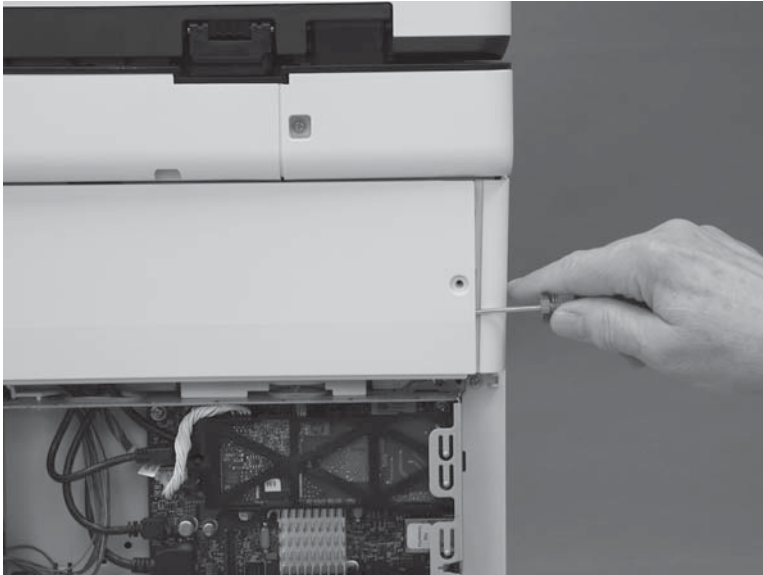

3. Pull the right edge of the cover (callout 1) away from the printer, and then slide the cover to the right (callout 2).

Figure 1-1674 Slide the cover right

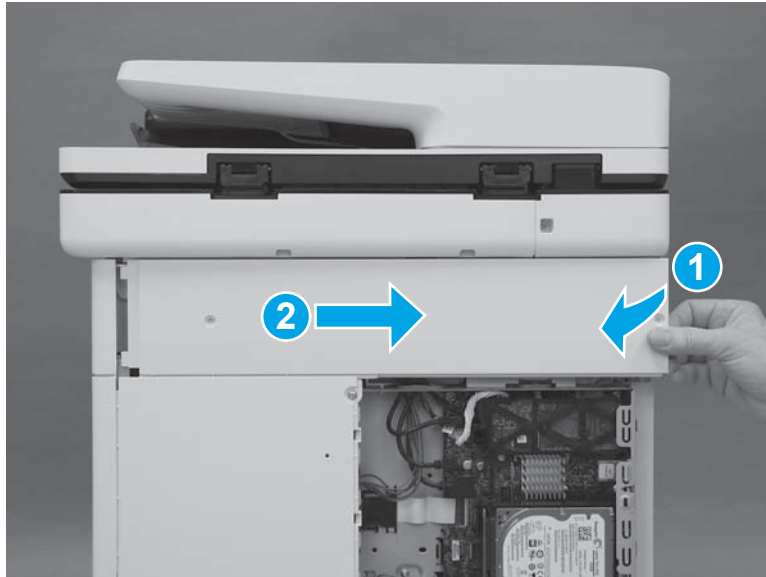

4. Remove the cover.

Figure 1-1675 Remove the cover

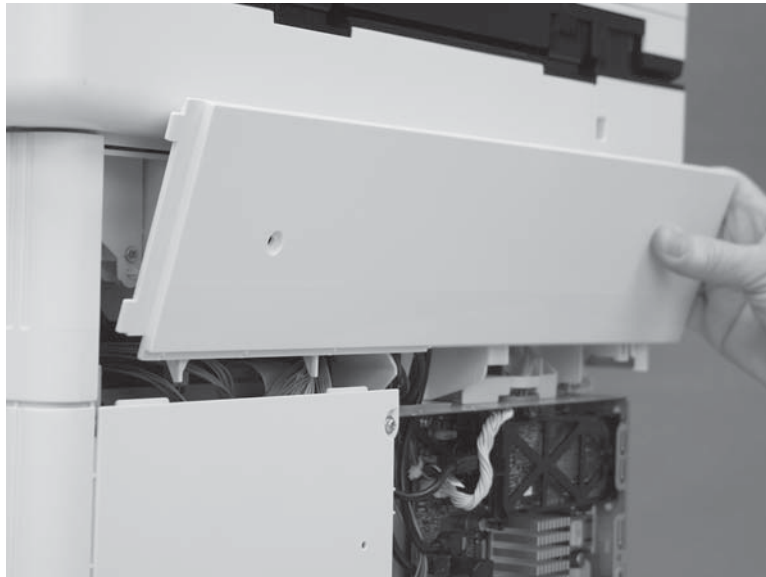

Step 9: Remove the rear cover (M577)

 **NOTE:** This step is for the M577 models. For the M552 and M553 models, skip this step and go to [Step 10: Remove the left cover on page 962](#).

1. Remove four screws (callout 1).

Figure 1-1676 Remove four screws

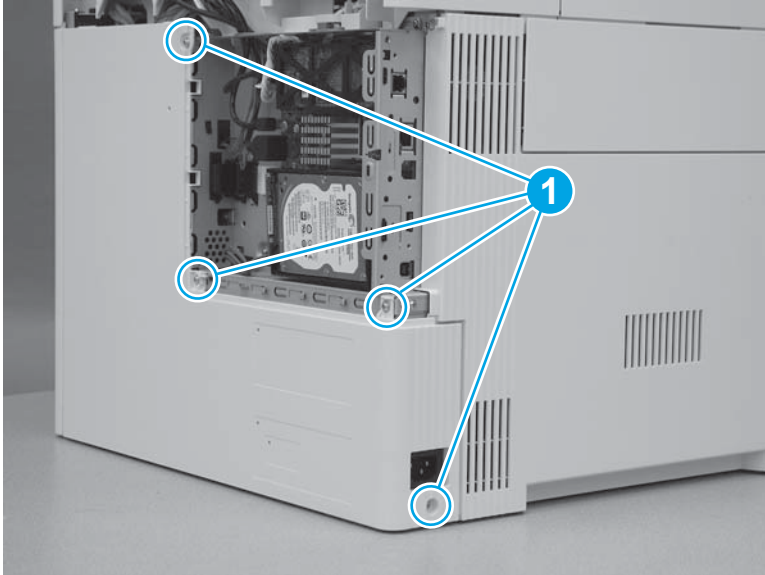

2. Slide the cover to the right to remove it.

Figure 1-1677 Remove the cover

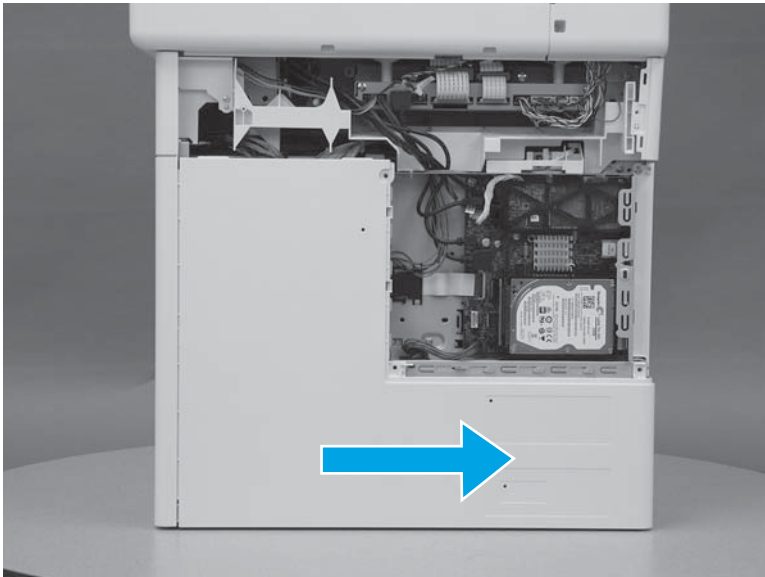

Step 10: Remove the left cover

1. At the left side of the printer, remove one screw (callout 1).

Figure 1-1678 Remove one screw



2. Release one tab (callout 1), rotate the front edge of the cover away from the printer (callout 2), and then slide the cover (callout 3) toward the rear of the printer to release it.

Figure 1-1679 Release the cover

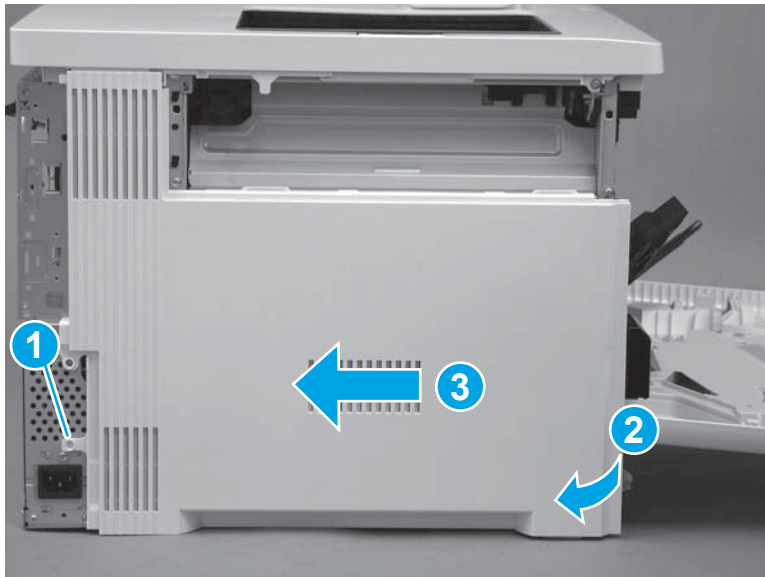

3. Remove the cover.

Figure 1-1680 Remove the cover

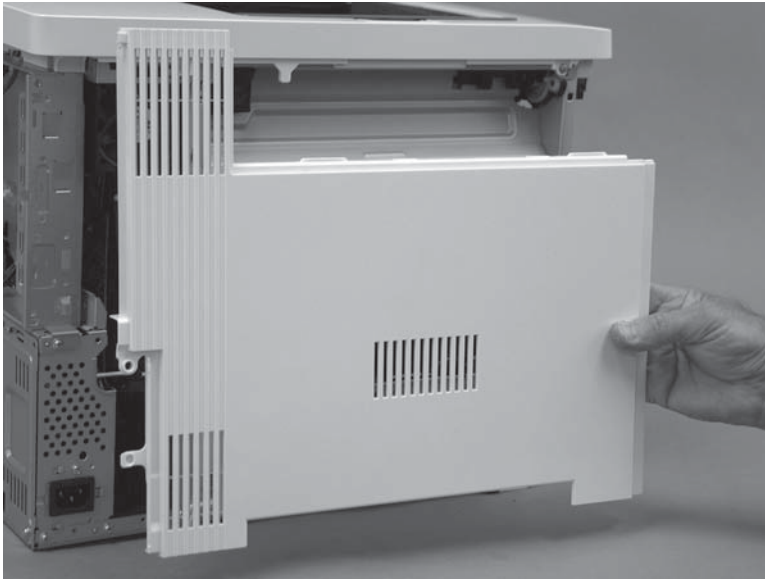

Step 11: Remove the formatter case

1. **M577 only:** Disconnect one connector (callout 1), and then pass the wire harness (callout 2) through two openings in the formatter case (callout 3).

Figure 1-1681 Disconnect one connector

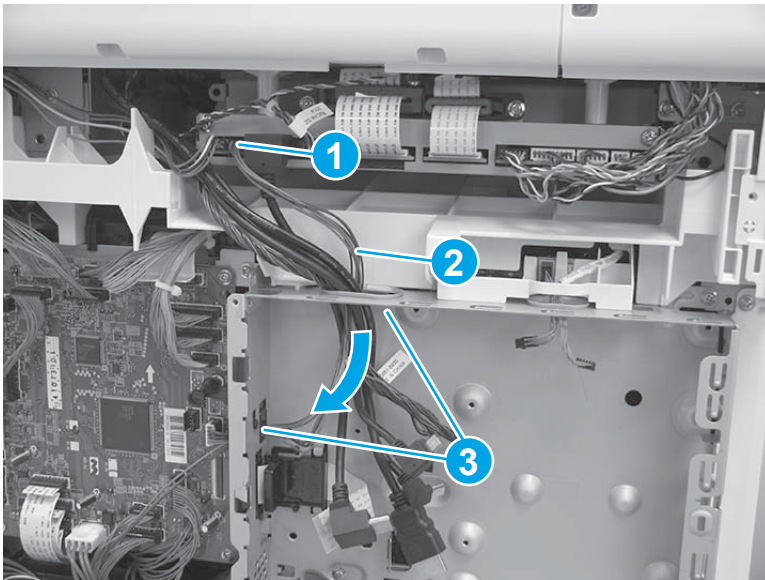

2. Release two tabs (callout 1) on the black plastic bracket. Hold the tabs in the released position, and then slide the bracket (callout 2) to the right to remove it from the formatter case.

Figure 1-1682 Remove the bracket

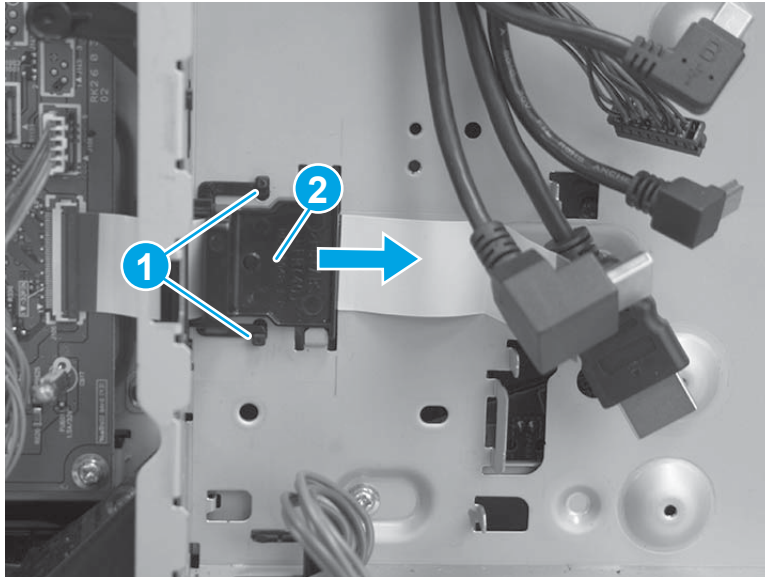

3. Remove two screws (callout 1), and then slide the low-voltage power supply (LVPS) cover to the right to remove it.

Figure 1-1683 Remove the LVPS cover

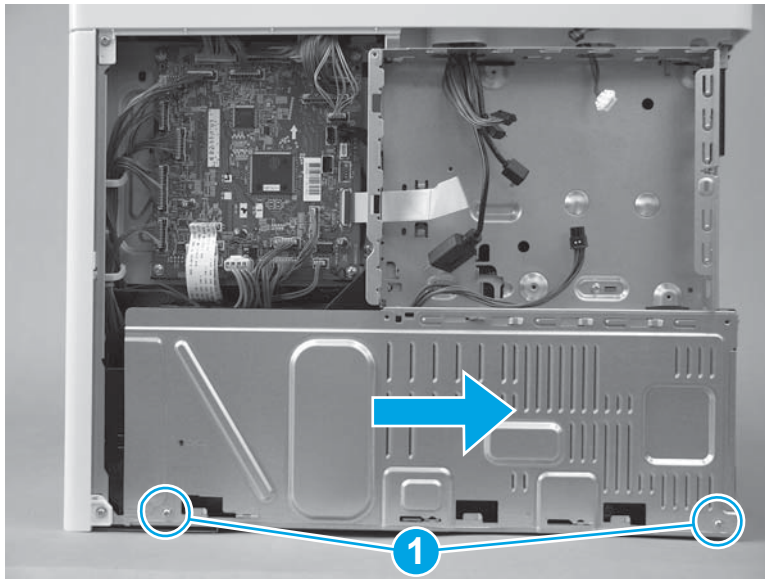

4. Pass two wire harnesses and one flat cable (callout 1) through the opening in the formatter case, and then release one wire harness from the retainer (callout 2).

⚠ CAUTION: The flat cable might be attached to the formatter case with double-sided tape. Make sure that this tape is released, so that the flat cable is not damaged when the formatter case is removed.

Figure 1-1684 Release wire harnesses and flat cable

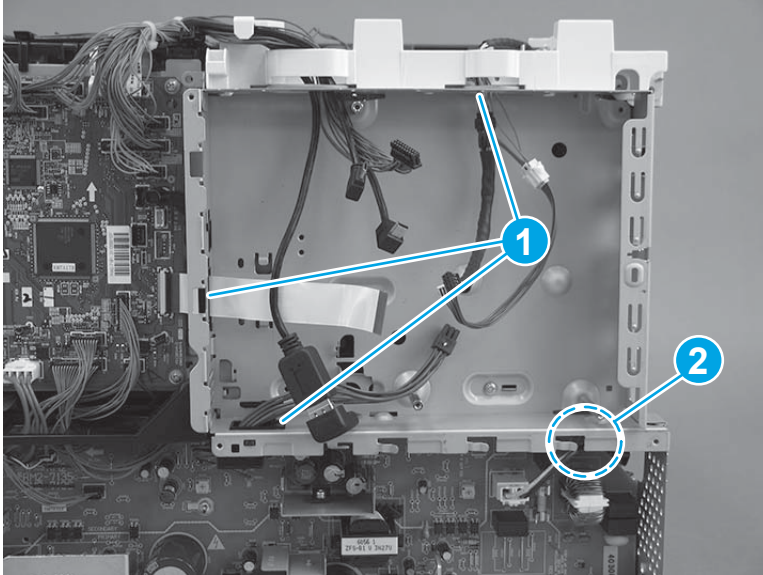

5. Remove six screws (callout 1).

Figure 1-1685 Remove six screws

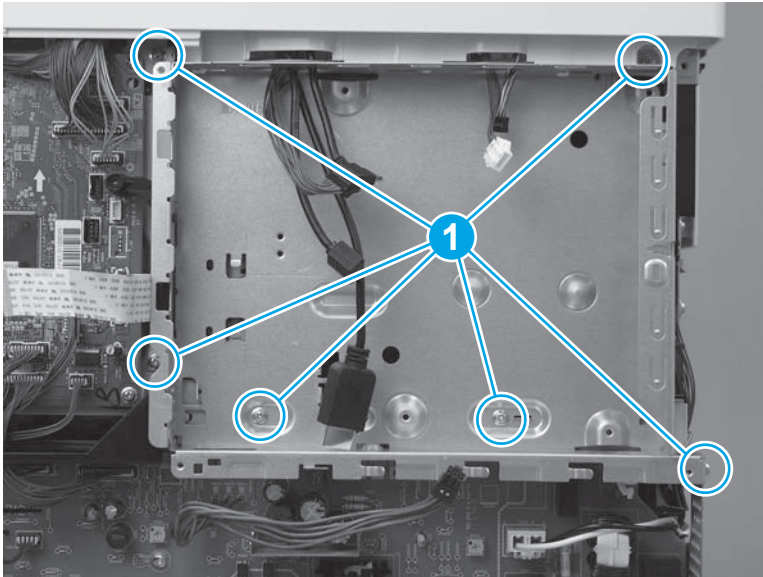

6. Rotate the bottom of the formatter case away from the printer (callout 1), and then pull it down (callout 2) to release it.

Figure 1-1686 Release the formatter case

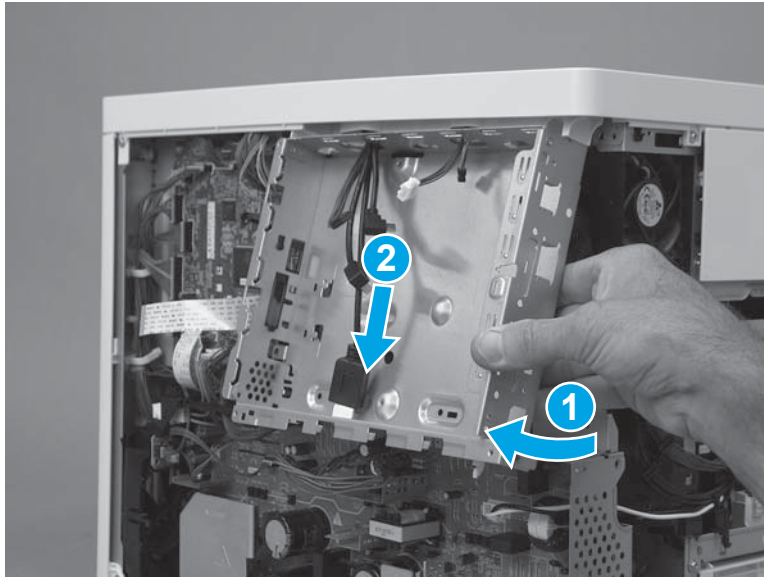

7. Pass the wire harnesses through the opening in the formatter case to remove it.

 **IMPORTANT:** If the formatter case is removed so that it can be replaced, make sure to transfer the memory PCA (island of data) and plastic bracket (callout 1) to the replacement case.

Figure 1-1687 Remove the formatter case



Step 12: Remove the low-voltage power supply (LVPS)

 **CAUTION:**  ESD-sensitive part.

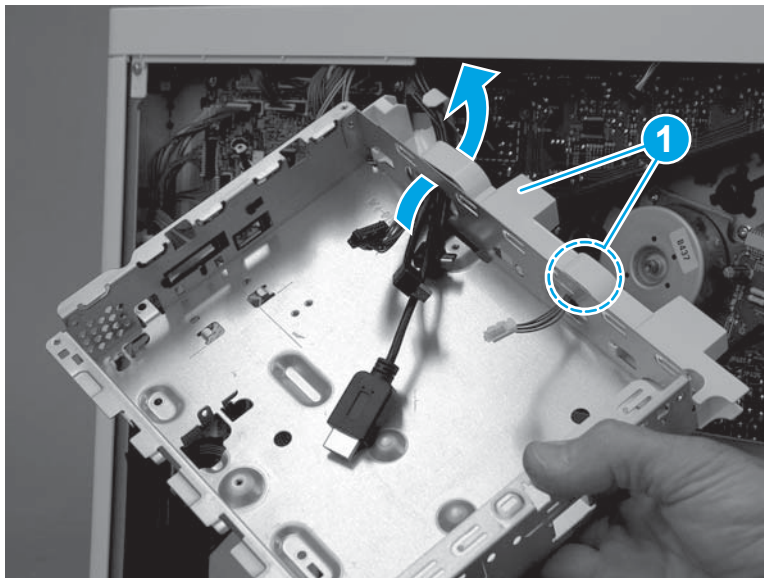
1. Disconnect one wire harness (callout 1), and then pass the wire harness through the opening (callout 2) in the chassis.

Figure 1-1688 Disconnect one wire harness

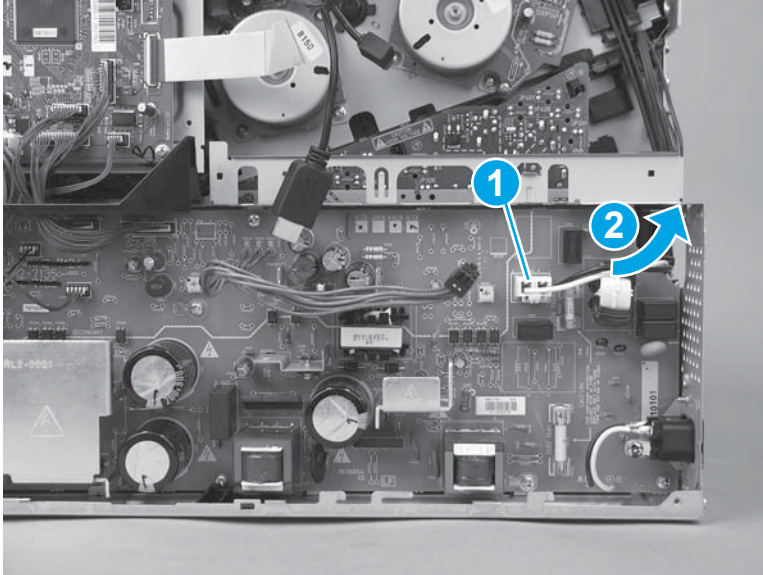

2. Disconnect three connectors on the DC controller (callout 1), and then disconnect four connectors (callout 2) on the LVPS.

Figure 1-1689 Disconnect seven connectors

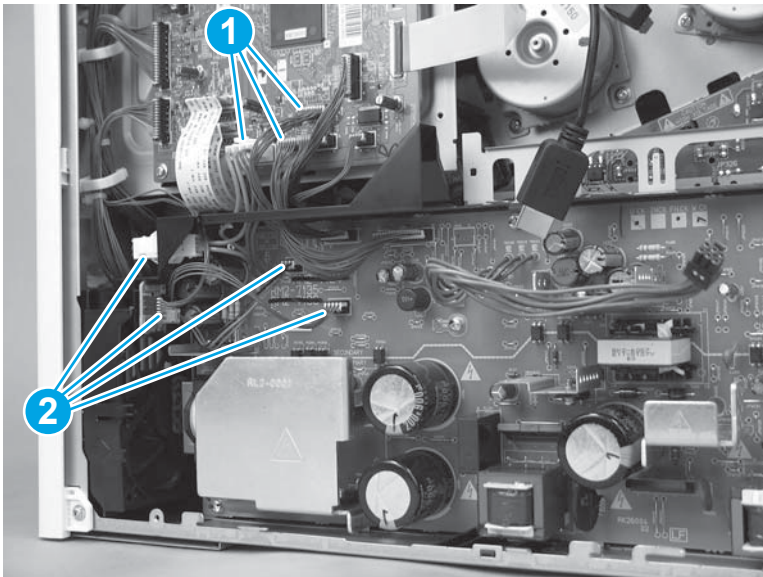

3. Pass the wire harnesses from the DC controller to the LVPS through the opening in the chassis (callout 1), and then release the wire harnesses from the retainer (callout 2).

Figure 1-1690 Pass the wire harnesses through the opening

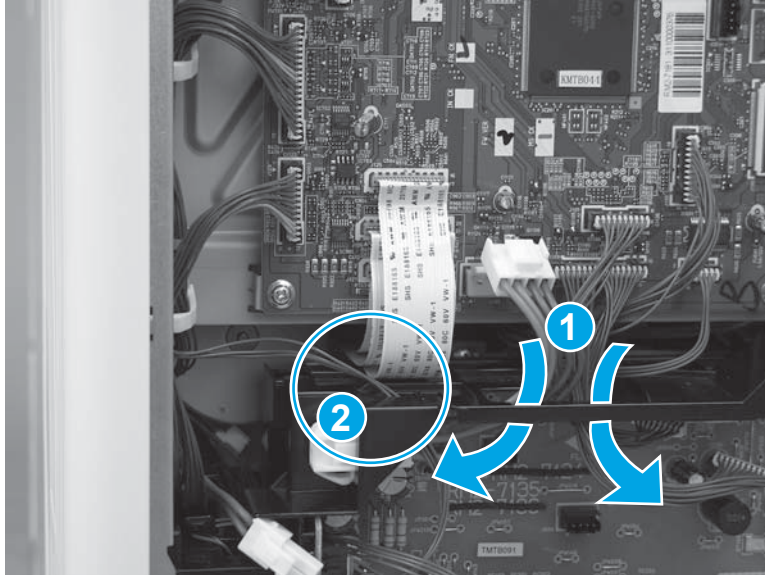

4. Remove three screws (callout 1).

Figure 1-1691 Remove three screws

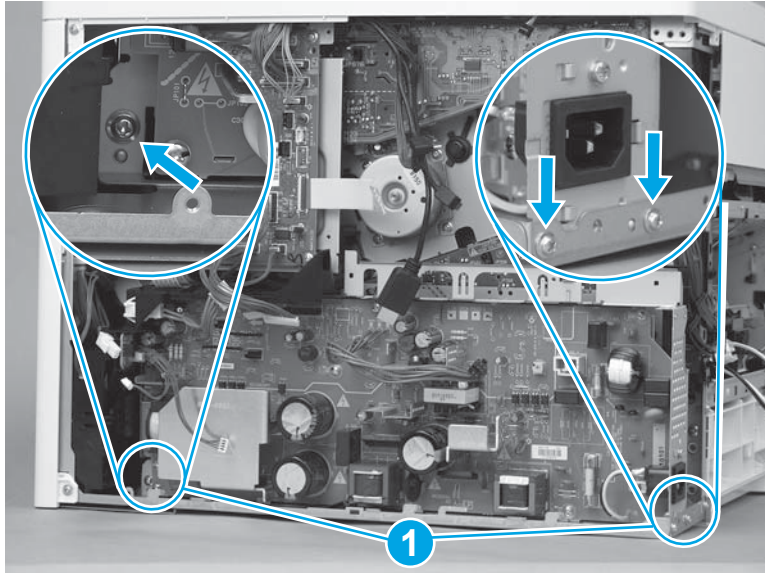

5. Rotate the top of the LVPS away from the printer (callout 1), and then slide it up and out (callout 2) of the printer to remove it.

Figure 1-1692 Remove the LVPS

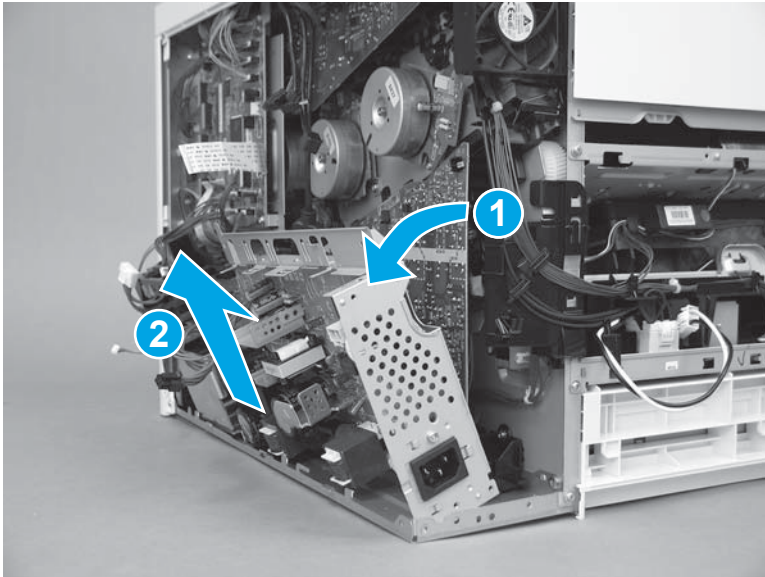

Step 13: Remove the high-voltage power supply D (HVPSD)

 **CAUTION:**  ESD-sensitive part.

1. Disconnect one flat cable (callout 1) on the DC controller.

Figure 1-1693 Disconnect one flat cable

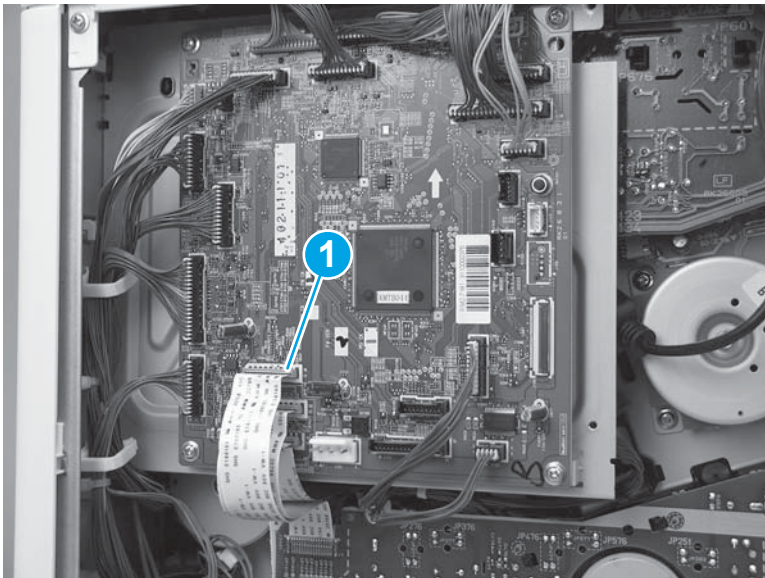

2. Remove two screws (callout 1), and then remove one self tapping screw (callout 2) on the HVPSD.

Figure 1-1694 Remove three screws

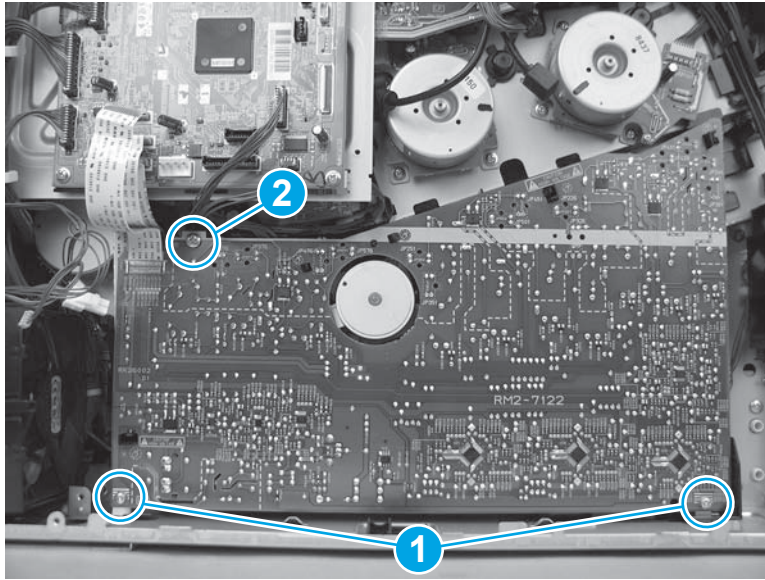

3. Release five tabs (callout 1), and then remove the HVPSD (callout 2).

Figure 1-1695 Remove the HVPSD

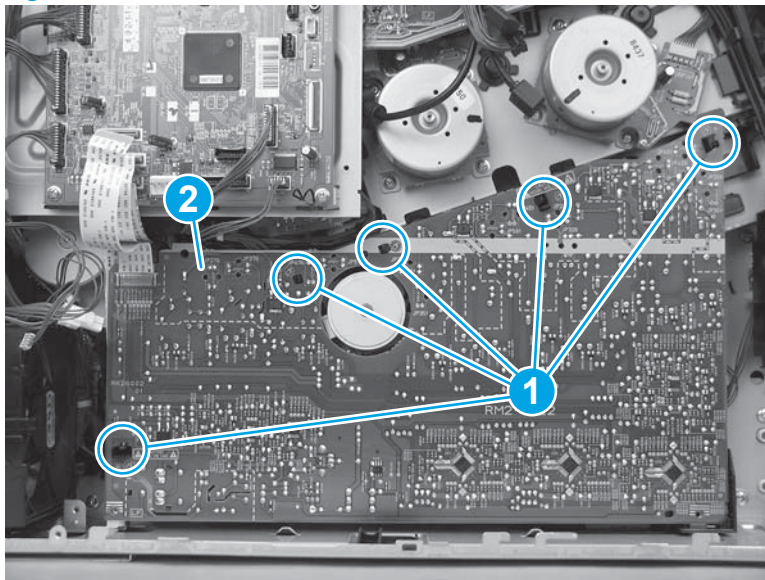

Step 14: Unpack the replacement assembly

Unpack the replacement assembly from the packaging.

CAUTION:  ESD-sensitive part.

For complete information on HP's recycling programs, go to [Product return and recycling](#).

NOTE:  HP recommends responsible disposal of the defective assembly.

Figure 1-1696 Recycle and unpack

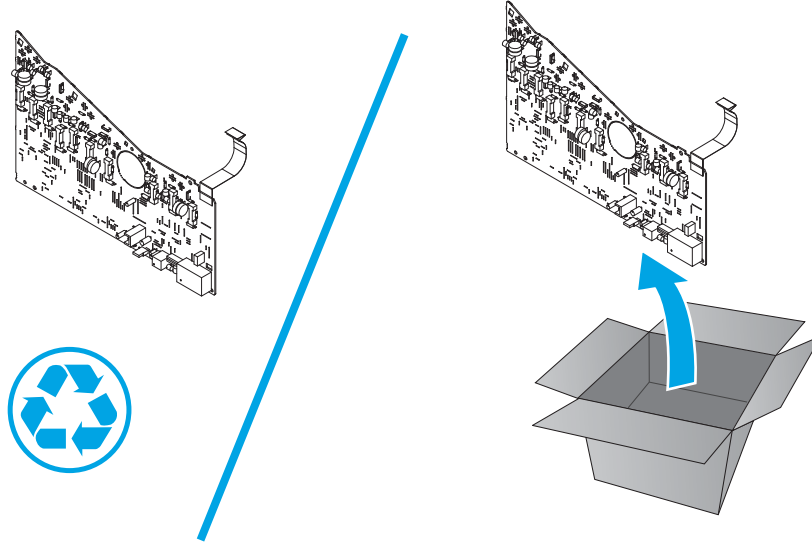

Step 15: Install the HVPSD

CAUTION:  ESD-sensitive part.

1. Position the bottom right corner of the HVPSD (callout 1) behind the black tab, and then rotate it up and onto the printer (callout 2).

Figure 1-1697 Install the HVPSD

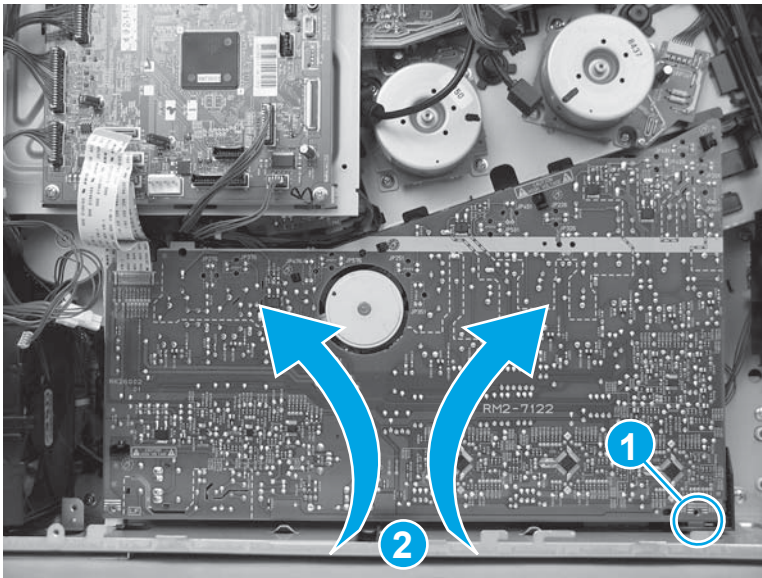

2. Press it onto five tabs (callout 2).

 **IMPORTANT:** Make sure that all five tabs snap into place.

Figure 1-1698 Press the tabs



3. Install two screws (callout 1), and then install one self tapping screw (callout 2) on the HVPSD.

Figure 1-1699 Install three screws

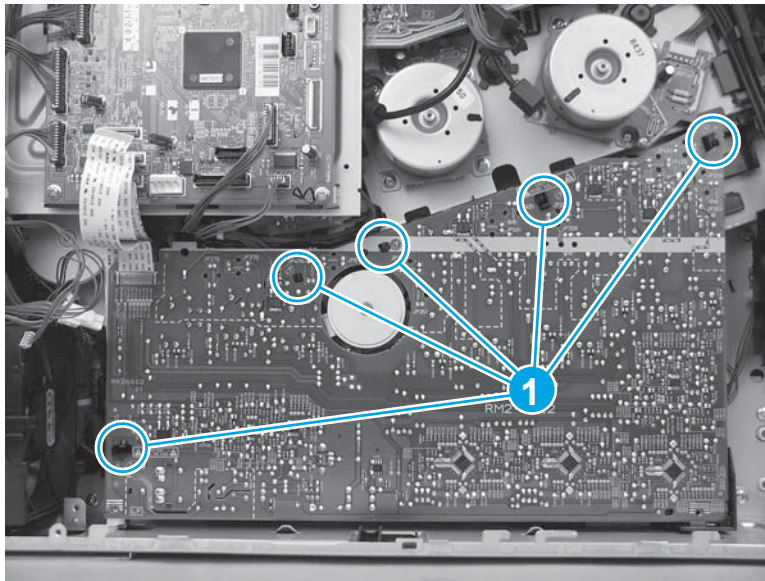
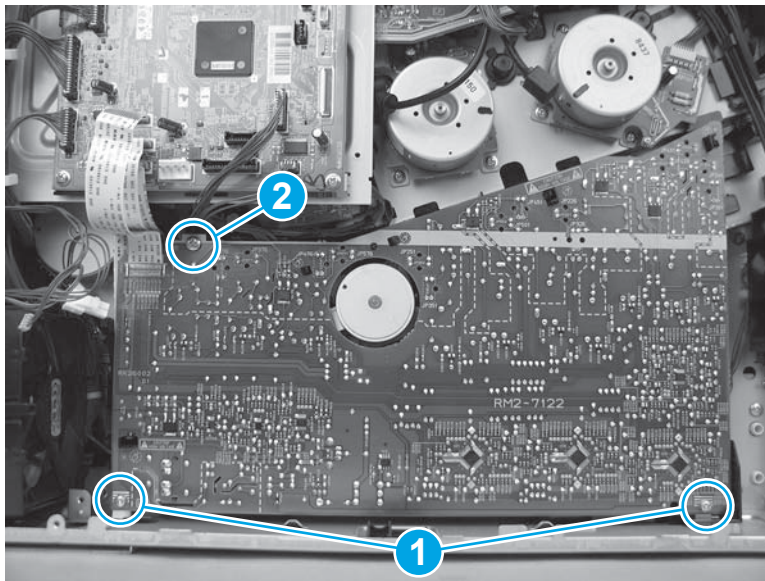

4. Connect one flat cable (callout 1) on the DC controller.

Figure 1-1700 Connect one flat cable

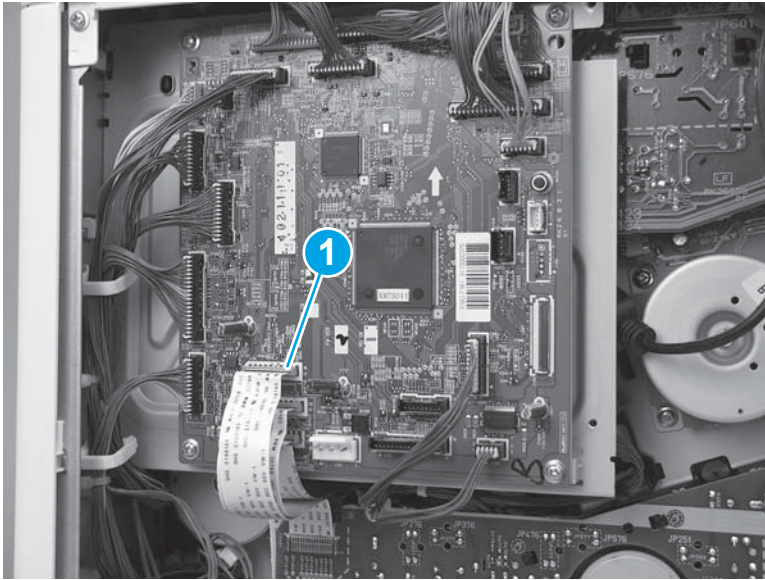

Step 16: Install the LVPS

 **CAUTION:**  ESD-sensitive part.

1. Position the bottom of the LVPS in the printer (callout 1) at a slight angle, and then rotate the top of it into the printer (callout 2) to install it.

Figure 1-1701 Install the LVPS

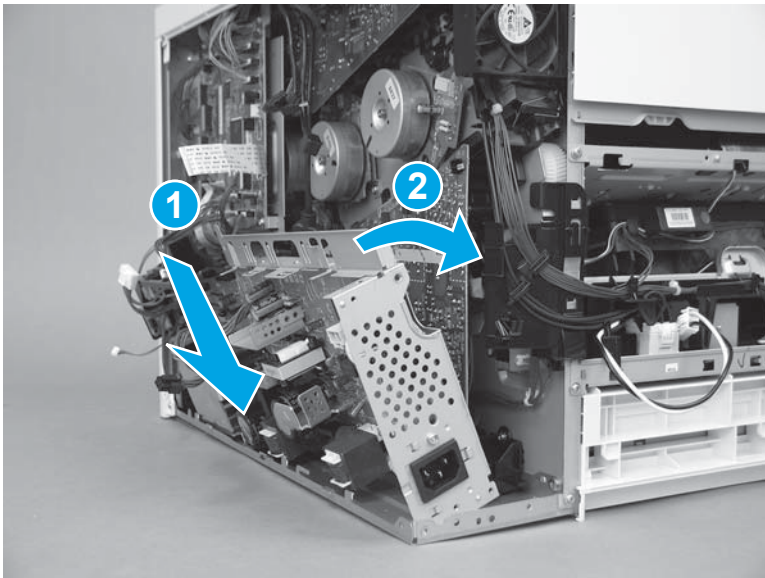

2. Install three screws (callout 1).

Figure 1-1702 Install three screws

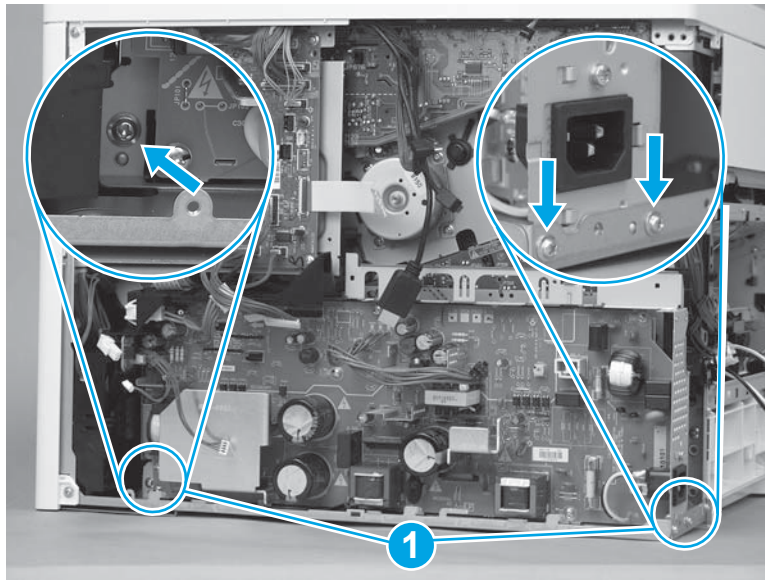

3. Pass the wire harnesses from the DC controller to the LVPS through the opening in the chassis (callout 1), and then install the wire harnesses in the retainer (callout 2).

Figure 1-1703 Pass the wire harnesses through the opening

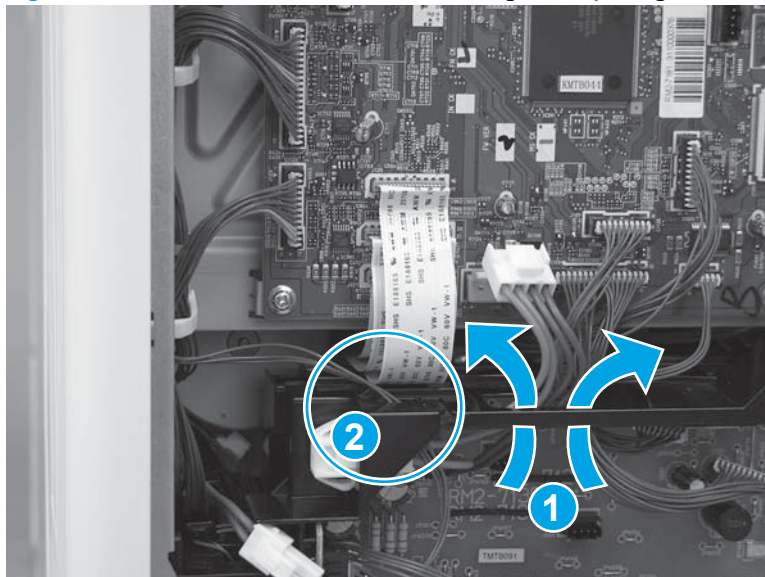

4. Connect three connectors on the DC controller (callout 1), and then connect four connectors (callout 2) on the LVPS.

Figure 1-1704 Connect seven connectors

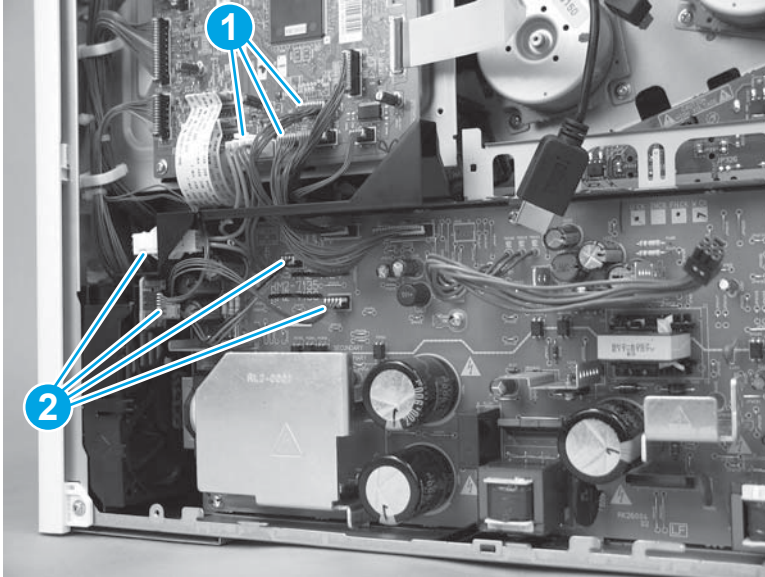

5. Pass the wire harness through the opening (callout 1) in the chassis, and then connect one wire harness (callout 2).

Figure 1-1705 Connect one wire harness

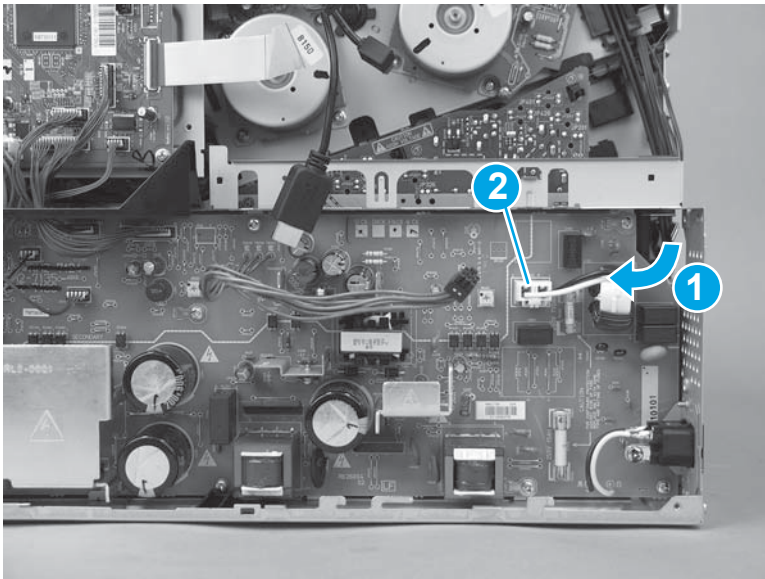

Step 17: Install the formatter case

1. Pass the wire harnesses through the opening in the formatter case.

Figure 1-1706 Pass the wire harnesses through the opening

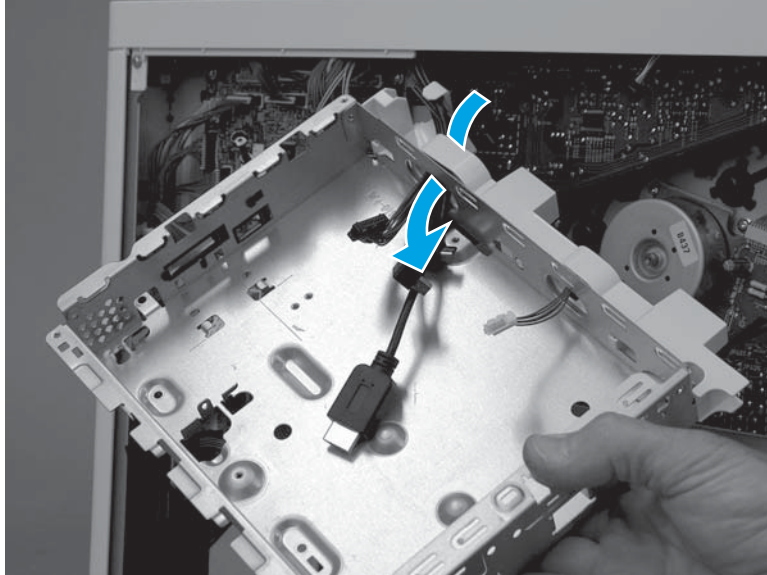

2. Position the top of the formatter case on the printer (callout 1), and then rotate the bottom of the case (callout 2) into the printer.

Figure 1-1707 Install the formatter case

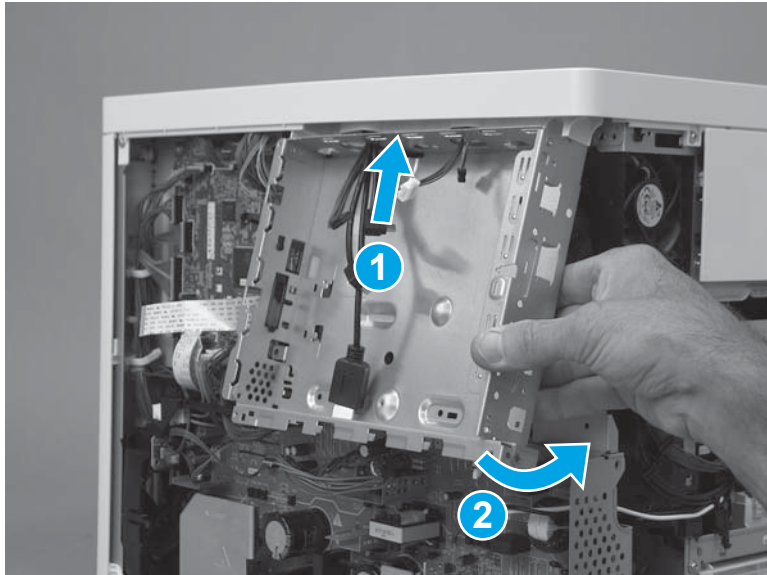

3. Install six screws (callout 1).

Figure 1-1708 Install six screws

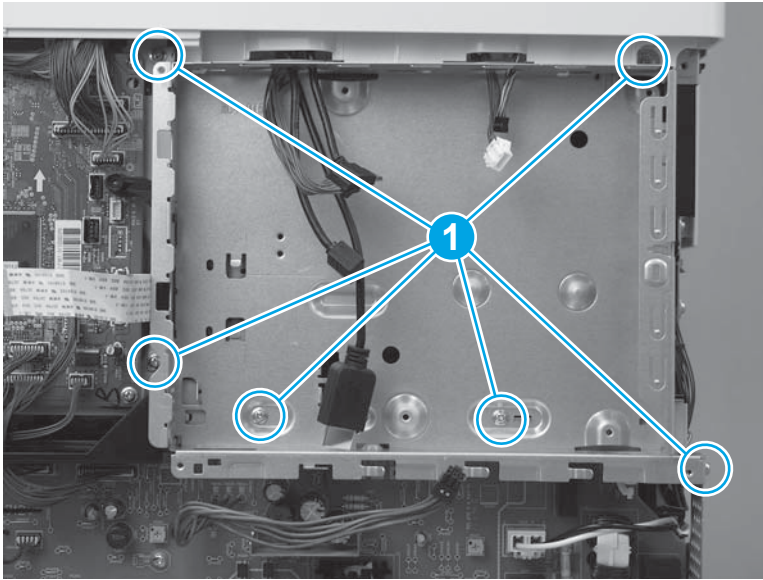

4. Pass two wire harnesses and one flat cable (callout 1) through the opening in the formatter case, and then install one wire harness in the retainer (callout 2).

 **IMPORTANT:** Make sure that the flat cable is securely fastened to the DC controller, and was not dislodged when the formatter case was removed.

Figure 1-1709 Install wire harnesses and flat cable



5. Position the LVPS cover on the printer, slide the cover to the left to install it, and then install two screws (callout 1).

Figure 1-1710 Install the LVPS cover

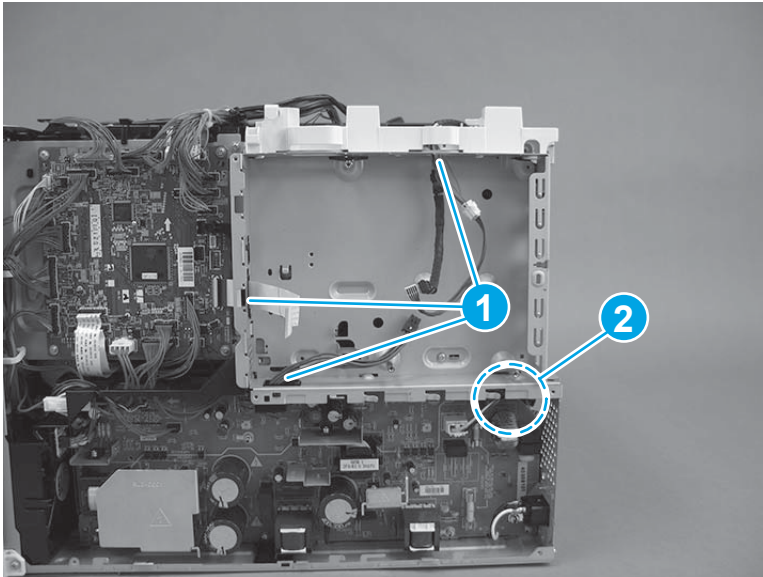
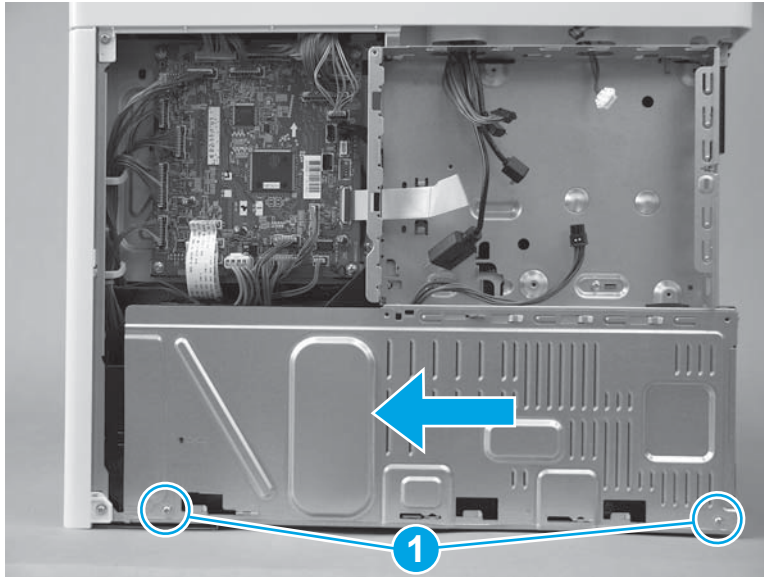

6. If no tape is affixed to the back of the flat cable, skip this step. If double-sided tape is affixed to the back of the flat cable, align the line (callout 1) on the cable with the edge (callout 2) of the opening in the sheet metal. Press to attach the flat cable to the formatter case.

Figure 1-1711 Attach the flat cable

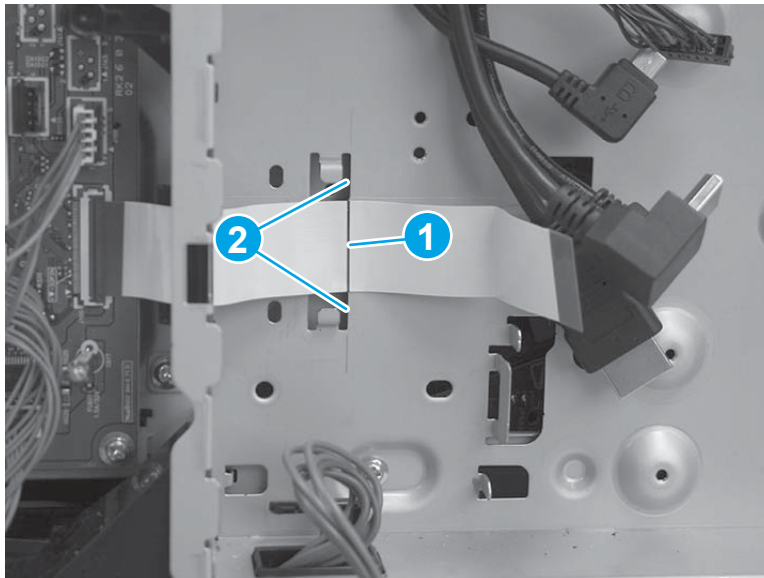

7. Position the bracket over the flat cable, and then slide the bracket to the left to install it. Make sure that the edges of the bracket fit under the sheet metal tabs (callout 1) on the formatter case and that the tabs (callout 2) snap into place.

Figure 1-1712 Position the bracket

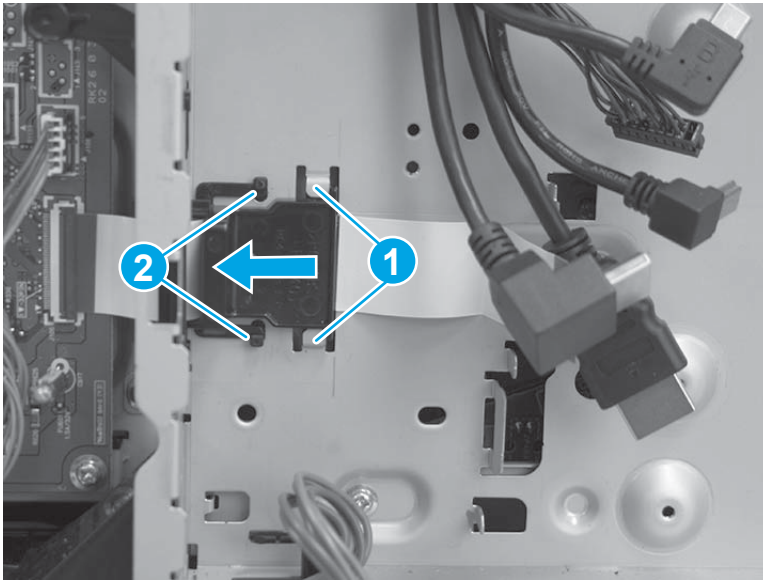

8. **M577 only:** Pass the wire harness (callout 1) through the openings in the formatter case (callout 2), and then connect one connector (callout 3).

Figure 1-1713 Connect one connector

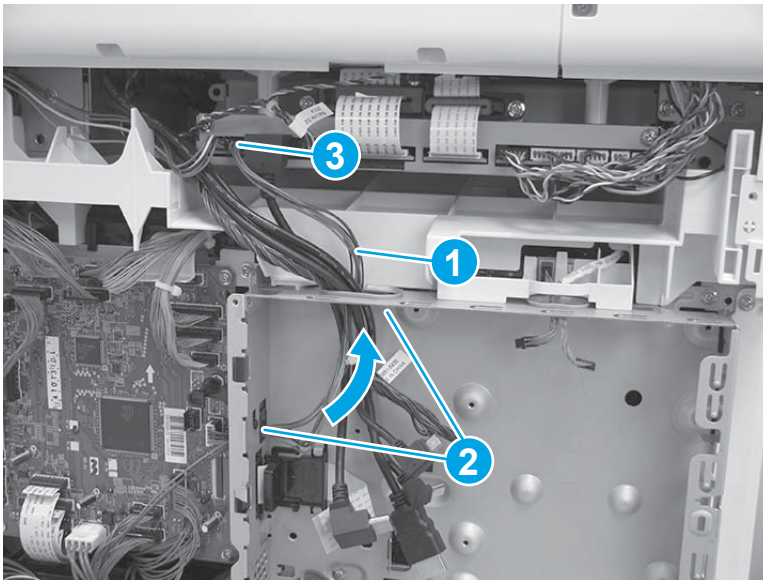

Step 18: Install the left cover

1. Position the cover on the printer.

 **NOTE:** Slightly offset the cover toward the rear of the printer.

Figure 1-1714 Install the cover

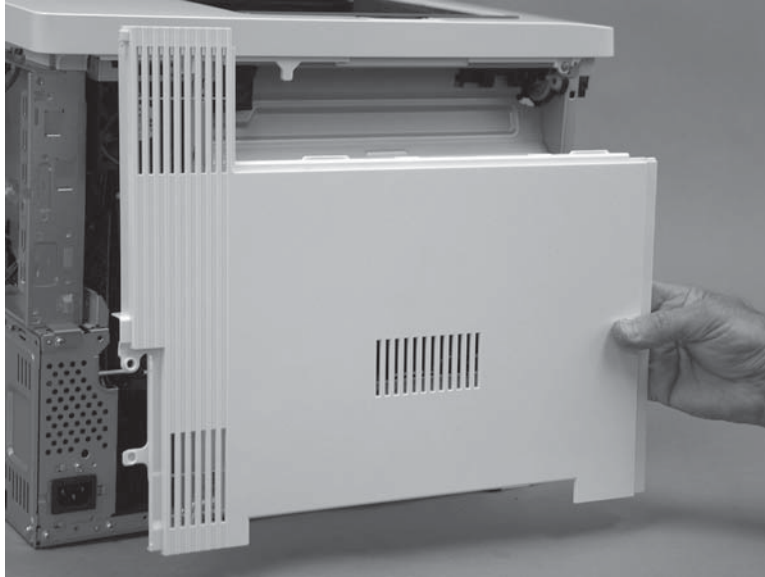

2. Slide the cover (callout 1) toward the front of the printer to engage it. Make sure that the tab (callout 2) snaps into place.

 **NOTE:** Locate the alignment pin (callout 3) on the cover from the front door side of the printer, and then make sure that it is fully engaged in the slot in the chassis.

 **TIP:** While sliding the cover into place, push in on the center of the cover (callout 1) to make sure that the hooks on the back of the cover engage with the slots in the chassis.

Figure 1-1715 Engage the cover



3. At the left side of the printer, install one screw (callout 1).

Figure 1-1716 Install one screw

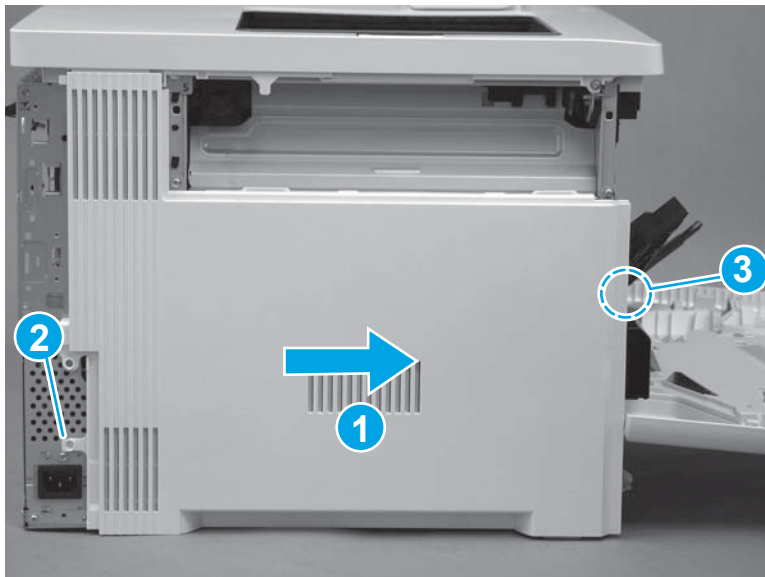

Step 19: Install the rear cover (M577)



NOTE: This step is for the M577 models. For the M552 and M553 models, skip this step and go to [Step 21: Install the rear cover \(M552 and M553\) on page 985](#).

1. Position the hooks (callout 1) on the cover in the slots (callout 2) in the printer.

Figure 1-1717 Position the hooks

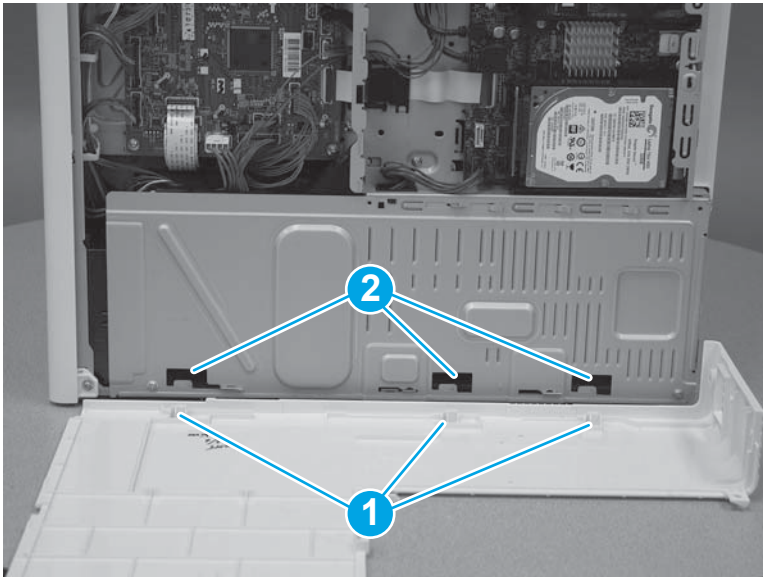

2. Position the back edge (callout 1) of the rear cover behind the edge (callout 2) of the right rear cover. Slide the cover to the left to install it.

Figure 1-1718 Install the cover

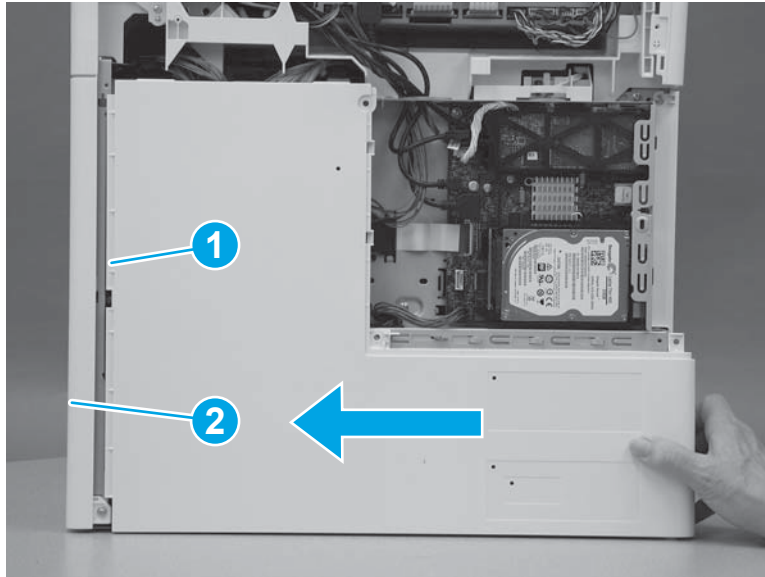

3. Install four screws (callout 1).

Figure 1-1719 Install four screws cover

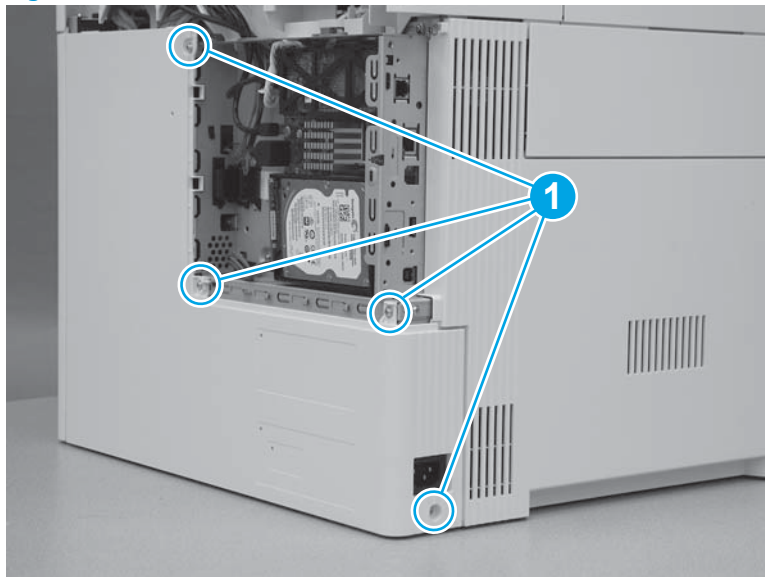

Step 20: Install the rear upper cover (M577)

 **NOTE:** This step is for the M577 models. For the M552 and M553 models, skip this step and go to [Step 21: Install the rear cover \(M552 and M553\) on page 985](#).

1. Align the ridge (callout 1) on the lower edge of the rear upper cover in front of the tabs (callout 2) on the top edge of the rear cover.

Figure 1-1720 Align the cover

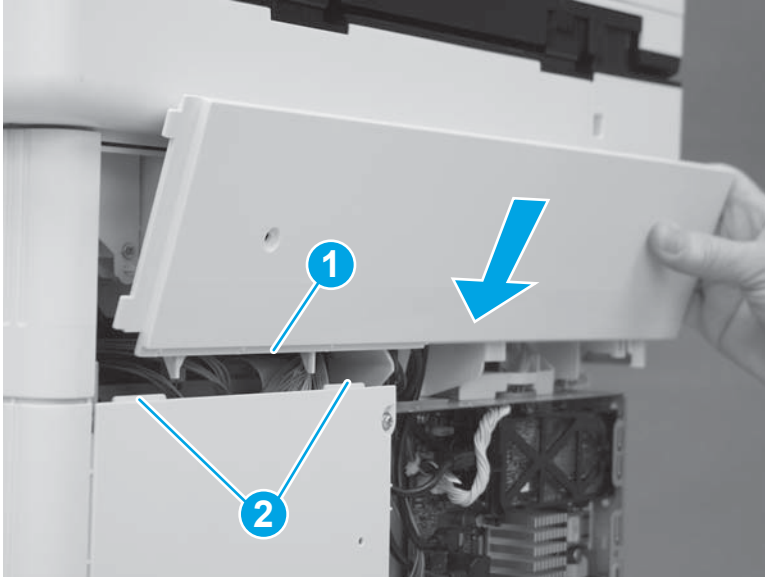

2. Rotate the top of the cover toward the printer.

Figure 1-1721 Rotate the top of the cover

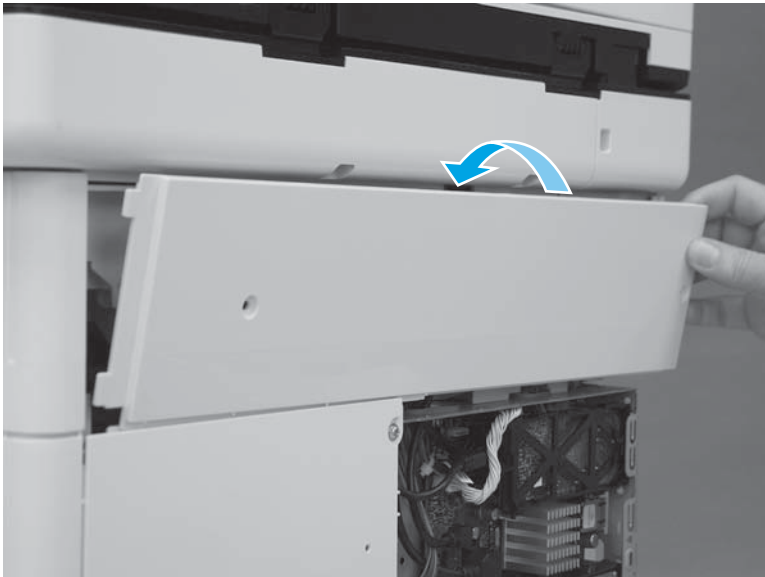

3. Slide the cover to the left (callout 1). Make sure that the tabs (callout 2) on the upper rear cover slide behind the edge (callout 3) of the right upper cover. Make sure that the cover is fully seated.

Figure 1-1722 Slide the cover

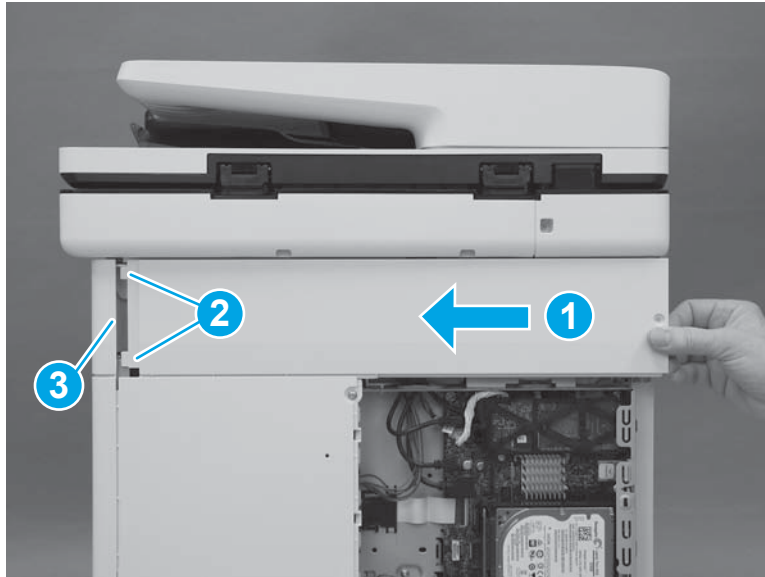

4. Install two screws (callout 1).

 **IMPORTANT:** These two screws are self-tapping screws for plastic. Rotate them counterclockwise to align them with the existing thread pattern, and then carefully turn them clockwise to tighten. Do not overtighten. This will prevent stripping the threads inside the screw holes.

Figure 1-1723 Install two screws



Step 21: Install the rear cover (M552 and M553)

 **NOTE:** This step is for the M552 and M553 models. For the M577 models, skip this step and go to [Step 22: Install the formatter \(M577\) on page 986](#).

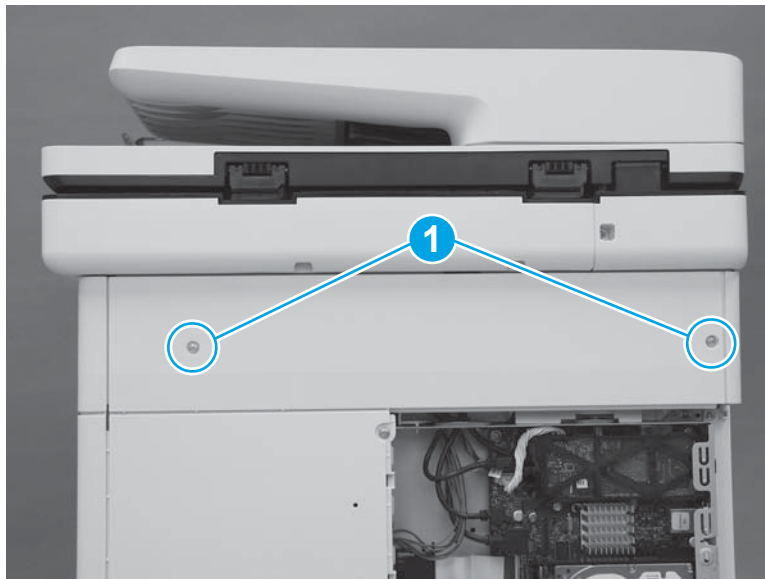
1. Position the top of the cover under the upper cover (callout 1), rotate the bottom of the cover onto the chassis (callout 2), and then slide the cover to the left (callout 3) to install it.

Figure 1-1724 Install the cover

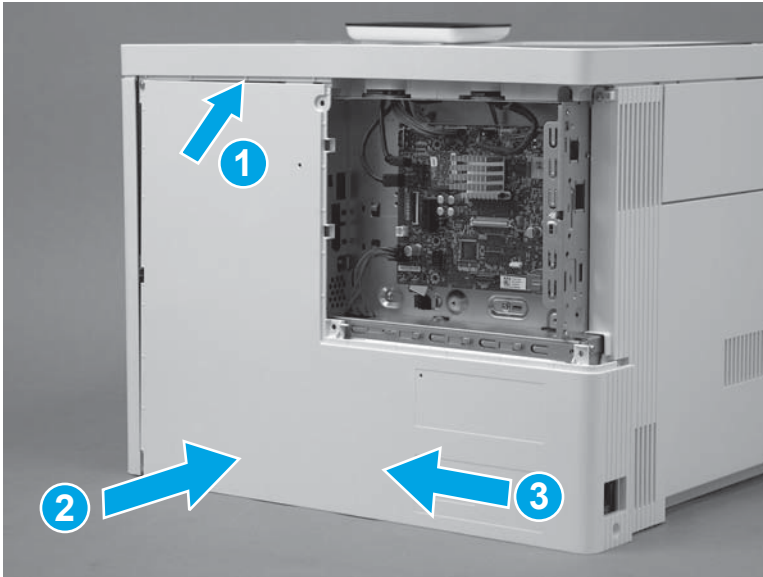

2. Install four screws (callout 1).

Figure 1-1725 Install four screws cover

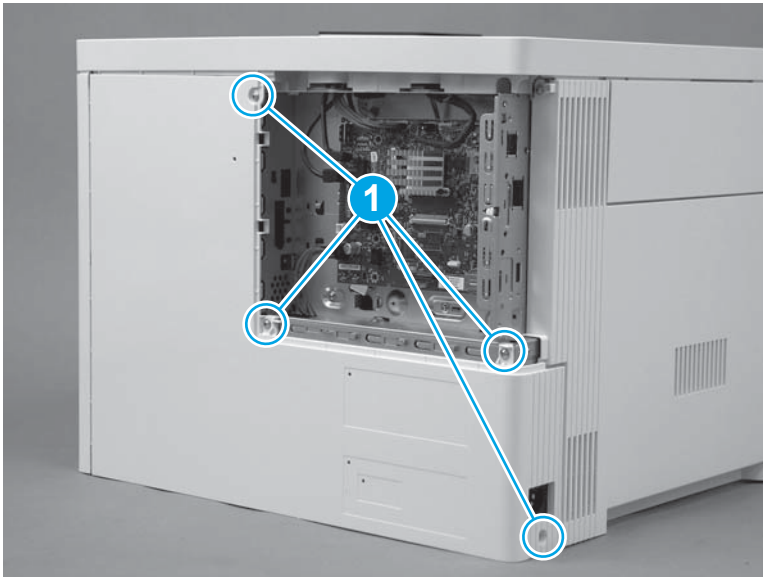

Step 22: Install the formatter (M577)



NOTE: This step is for the M577 models. For the M552 and M553 models, skip this step and to go [Step 25: Install the formatter \(M552 and M553\) on page 991](#).



CAUTION:  ESD-sensitive part.

1. Position the formatter in the printer. Make sure that the network port (callout 1) fits through the opening (callout 2) in the formatter case.

Figure 1-1726 Install the formatter

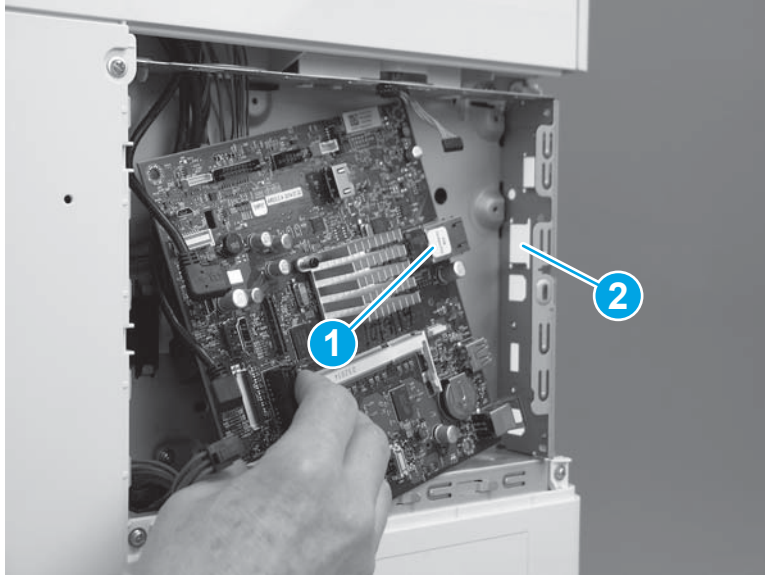

2. Install four screws (callout 1).

Figure 1-1727 Install four screws

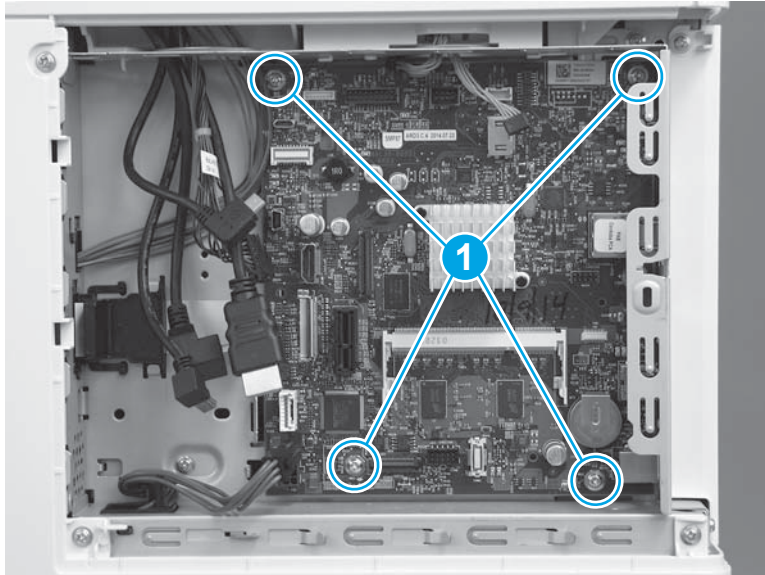

3. Connect all of the connectors on the formatter.

The following connectors are empty:

- All models: J1 (this connector is empty unless the optional DIMM is installed)
- All models: J3
- M577dn: J15 (this is the fax connector for the M577f/z/c models)
- All models: J21 (this connector is empty unless the optional internal USB ports component is installed)
- All models: J23

- All models: J24
- All models: J51
- All models: J57
- All models: J97
- All models: J98 (this connector is empty unless the optional trusted platform module (TPM) is installed)



 **IMPORTANT:** The flat-cable connector (callout 1) is a Zero Insertion Force (ZIF) connector that uses a hinged retainer to secure the flat cable. The hinged retainer must be opened to install the flat cable, and then closed after the cable is installed.

Figure 1-1728 Connect all connectors

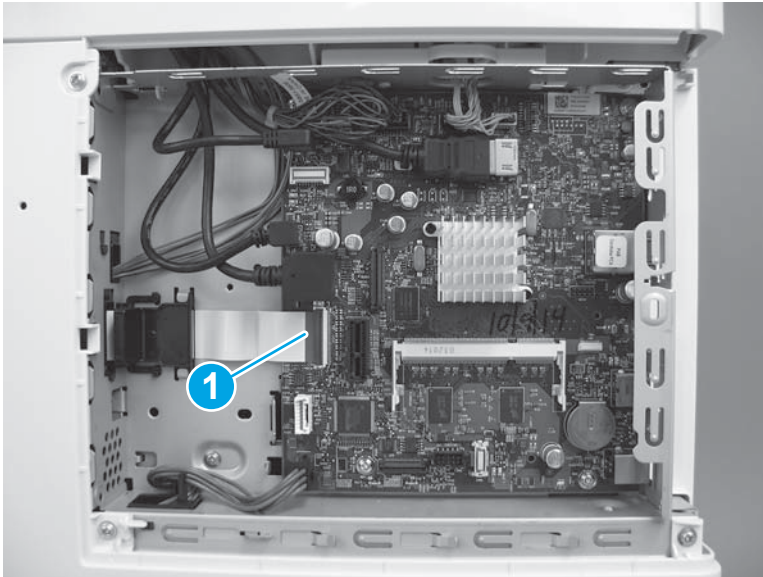

Step 23: Install the fax PCA (M577c/f/z)

 **NOTE:** This step is for the M577c/f/z models. For the M577n model, skip this step and go to [Step 24: Install the HDD \(M577\) on page 990](#).

For the M552 and M553 models, skip this step and go to [Step 25: Install the formatter \(M552 and M553\) on page 991](#).

 **CAUTION:**  ESD-sensitive part.

1. Position the tab and telephone port (callout 1) on the fax PCA in the slots (callout 2) in the formatter case.

Figure 1-1729 Position the fax PCA

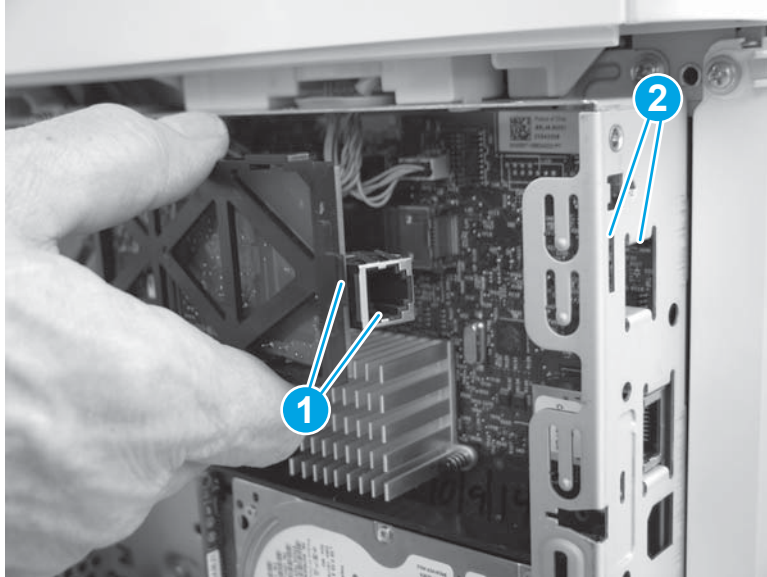

2. Slide the fax PCA to the right (callout 1) until the tab and telephone port described in the previous step and seated in the formatter case. Position the retainer (callout 2) in the slot (callout 3) in the formatter. Rotate the end of the fax PCA toward the formatter (callout 4) until the retainer snaps into place.

Figure 1-1730 Install the fax PCA

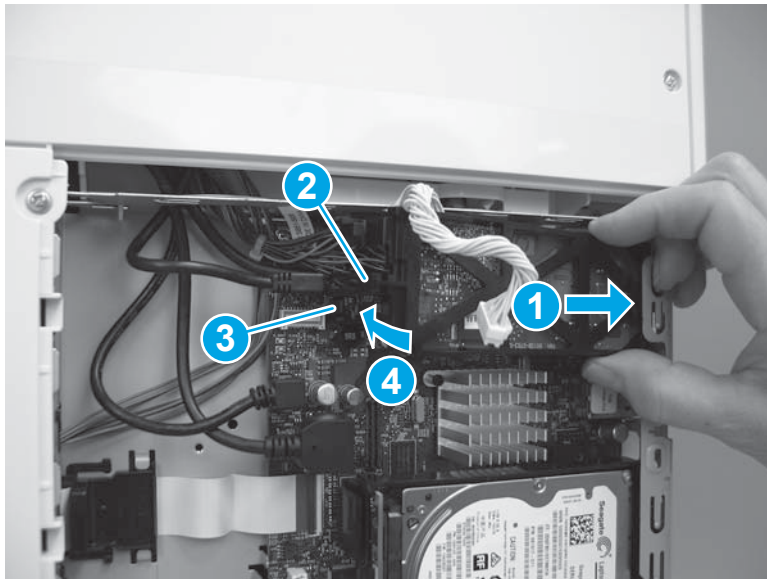

3. Position the cable (callout 1) in the guide (callout 2), and then connect one connector (callout 3).

Figure 1-1731 Connect the connector

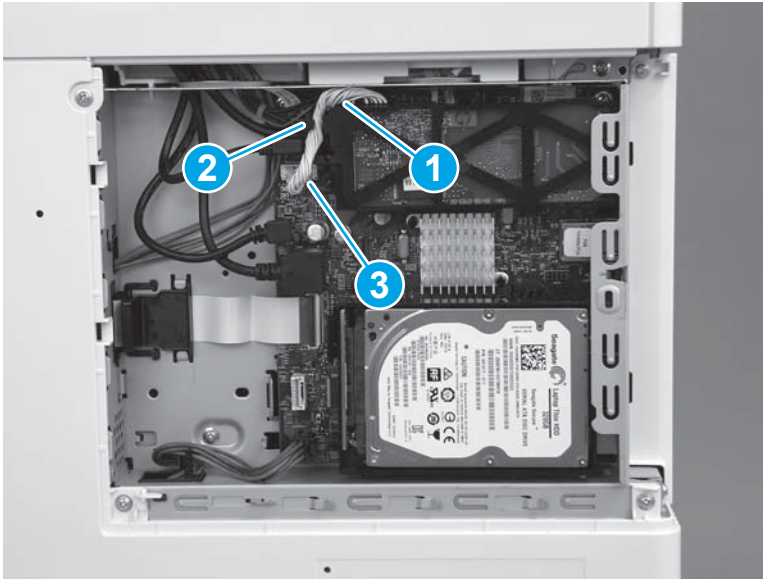

Step 24: Install the HDD (M577)



NOTE: This step is for the M577 models. For the M552 and M553 models, skip this step and go to [Step 25: Install the formatter \(M552 and M553\) on page 991](#).



CAUTION:  ESD-sensitive part.

1. Align the end of the bracket (callout 1) with the slot in the chassis (callout 2), and then slide the HDD into the printer (callout 3) to engage the bracket with the chassis.

Figure 1-1732 Install the holder

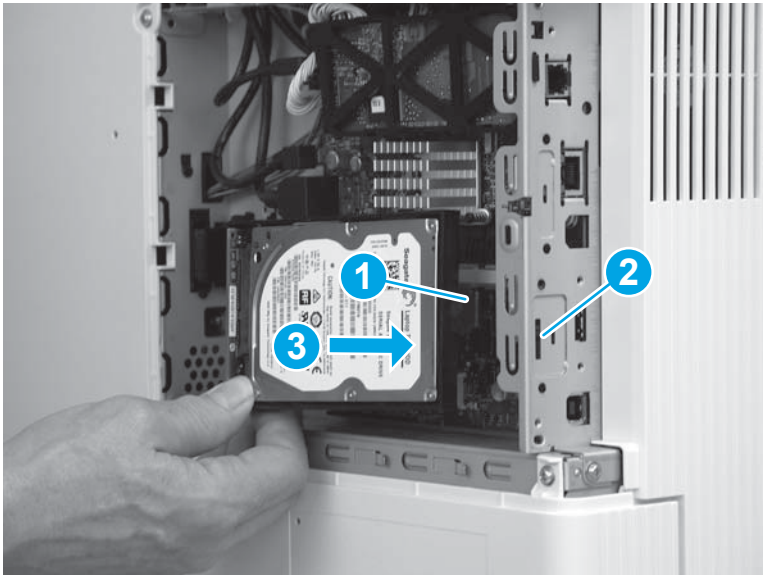

2. Hold the HDD connector latch (callout 1) in the released position, and then rotate the HDD down and into the connector on the formatter to install it.



 **NOTE:** Make sure that the tab (callout 2) snaps into place, and that the HDD is securely installed.

Figure 1-1733 Release the HDD

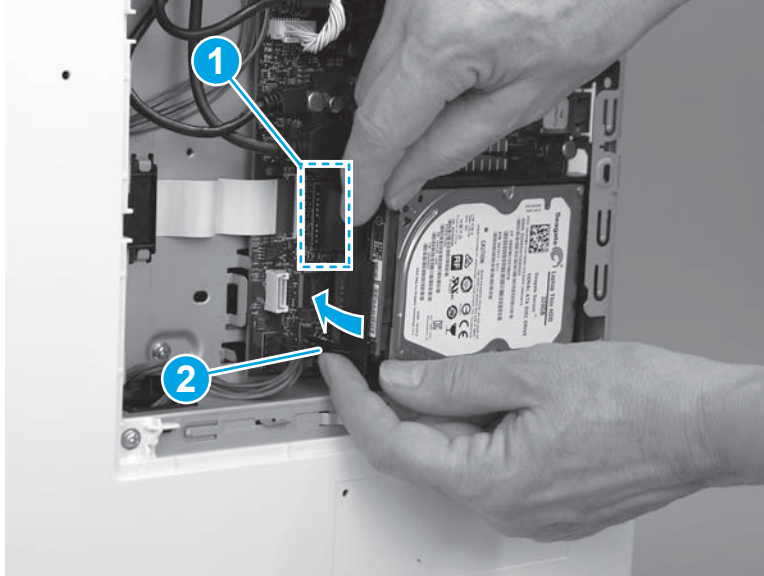

Step 25: Install the formatter (M552 and M553)

 **NOTE:** This step is for the M552 and M553 models. For the M577 models, skip this step and go to [Step 26: Install the formatter cover on page 993](#).

If the optional hard-disk drive (HDD) was removed, do not forget to reinstall it after the formatter is reinstalled.

Engage the HDD holder with the chassis, rotate the HDD connector down and into the connector on the formatter. Make sure that the tabs snap into place.

 **CAUTION:**  ESD-sensitive part.

1. Position the formatter in the printer, and then install four screws (callout 1).

Figure 1-1734 Install the formatter

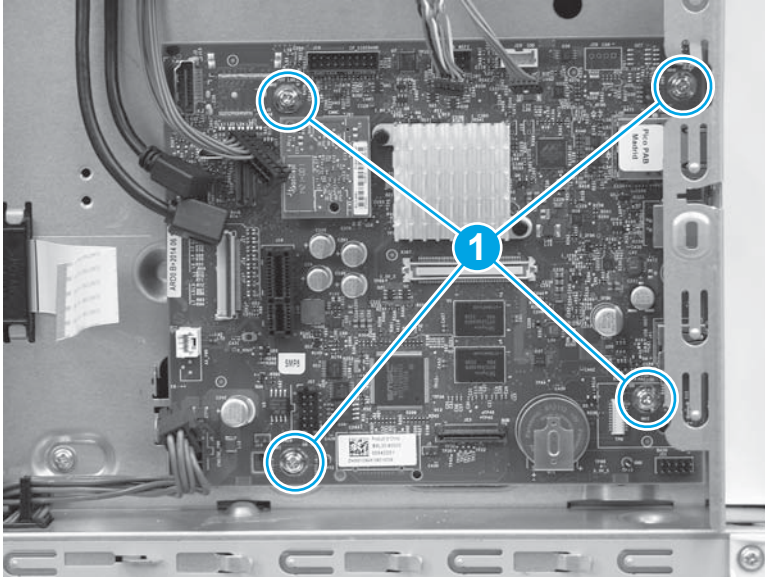

2. Connect all of the connectors on the formatter.

The following connectors are empty:

- All models: J1 (this connector is empty unless the optional DIMM is installed)
- M553n/dn and M552dn: J2 (callout 1; this is the touchscreen connector for the M553x model)
- All models: J9 (this connector is empty unless the optional internal USB ports component is installed)
- All models: J18 (this connector is empty unless the optional hard-disk-drive (HDD) is installed)
- All models: J23
- All models: J24
- M553n/dn and M552dn: J25 (this is the wireless connector for the M553x model)
- All models: J57
- All models: J98 (this connector is empty unless the optional trusted platform module (TPM) is installed)



 **IMPORTANT:** The flat-cable connector (callout 2) is a Zero Insertion Force (ZIF) connector that uses a hinged retainer to secure the flat cable. The hinged retainer must be opened to install the flat cable.

Figure 1-1735 Connect all connectors

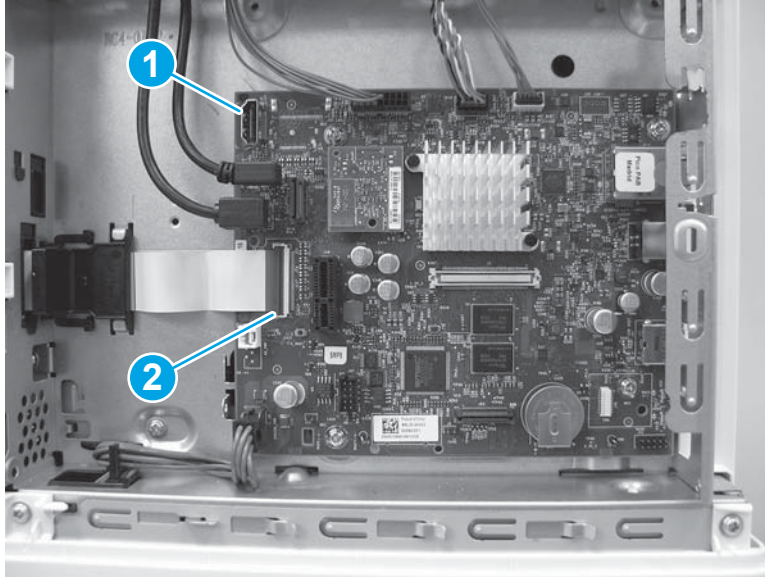

Step 26: Install the formatter cover

- ▲ Slide the cover onto the printer (callout 1) to install it.

 **NOTE:** Make sure that the tabs on the formatter cover align with the slots provided in the printer (callout 2). Tighten the two thumbscrews (callout 3).

 **TIP:** If needed, use the edge of a coin to turn the thumbscrews.

Figure 1-1736 Install the cover



Step 27: Install the TCU

1. Verify that the toner collection hatch cover is in the closed position on the TCU.

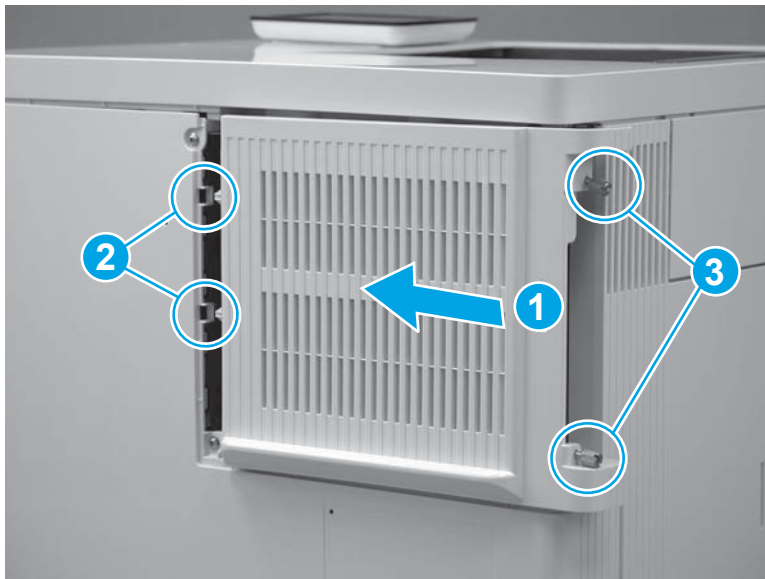
Figure 1-1737 Verify that the toner collection hatch cover is closed

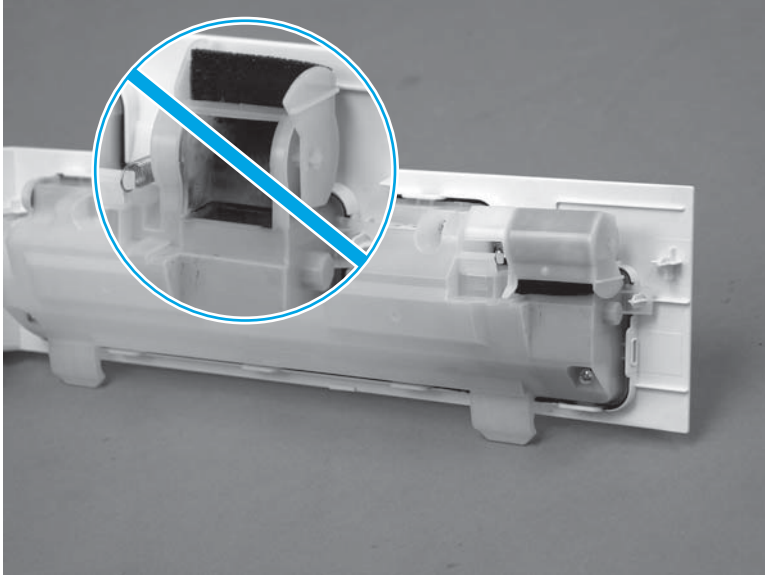

2. Position the TCU with the hinges in the slots provided in the printer (callout 1), and then rotate the TCU up and into the closed position.

 **NOTE:** The toner collection hatch cover automatically opens when the TCU is closed.

Figure 1-1738 Install the TCU



3. Close the front door.

Figure 1-1739 Close the front door

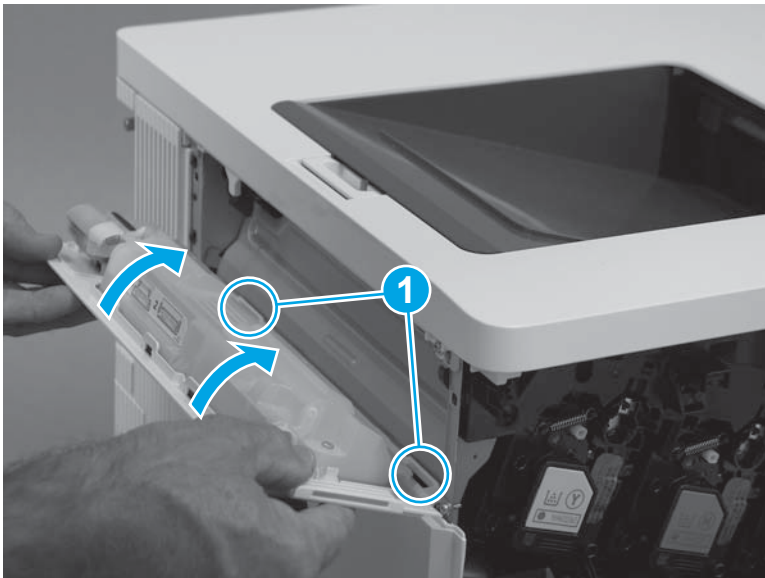

Removal and replacement: Drum motor 1 (M1)

- [Introduction](#)
- [Step 1: Remove the toner collection unit \(TCU\)](#)
- [Step 2: Remove the formatter cover](#)
- [Step 3: Remove the formatter \(M552 and M553\)](#)
- [Step 4: Remove the hard-disk drive \(HDD\) \(M577\)](#)
- [Step 5: Remove the fax PCA \(M577c/f/z\)](#)
- [Step 6: Remove the formatter \(M577\)](#)
- [Step 7: Remove the rear cover \(M552 and M553\)](#)
- [Step 8: Remove the rear upper cover \(M577\)](#)
- [Step 9: Remove the rear cover \(M577\)](#)
- [Step 10: Remove the left cover](#)
- [Step 11: Remove the formatter case](#)
- [Step 12: Remove drum motor 1 \(M1\)](#)
- [Step 13: Unpack the replacement assembly](#)
- [Step 14: Install drum motor 1 \(M1\)](#)
- [Step 15: Install the formatter case](#)
- [Step 16: Install the left cover](#)
- [Step 17: Install the rear cover \(M577\)](#)
- [Step 18: Install the rear upper cover \(M577\)](#)
- [Step 19: Install the rear cover \(M552 and M553\)](#)
- [Step 20: Install the formatter \(M577\)](#)
- [Step 21: Install the fax PCA \(M577c/f/z\)](#)
- [Step 22: Install the HDD \(M577\)](#)
- [Step 23: Install the formatter \(M552 and M553\)](#)
- [Step 24: Install the formatter cover](#)
- [Step 25: Install the TCU](#)

Introduction

This document provides the procedures to remove and replace the drum motor 1 (M1).

Before performing service

Turn the printer power off

- Disconnect the power cable.

 **WARNING!** To avoid damage to the printer, turn the printer off, wait 30 seconds, and then remove the power cord before attempting to service the printer.

Use the table below to identify the correct part number for your printer, and then go to <http://h20141.www2.hp.com/hpparts> to order the part.

Drum motor 1 (M1) part number	
RM2-0078-000CN	Drum motor 1 (M1)

Required tools

- #2 Phillips screwdriver with a magnetic tip

After performing service

Make sure that all of the connectors on the LVPS are fully seated.

Make sure that all of the connectors on the formatter are fully seated.

Make sure that the formatter cover is fully seated, and that the thumbscrews are finger tight after replacing it.

Turn the printer power on

- Connect the power cable.
- Use the power switch to turn the power on.

Post service test

Use the components test to test the motor. For more information, see the printer troubleshooting manual.

Step 1: Remove the toner collection unit (TCU)

1. Open the front door.

Figure 1-1740 Open the front door



2. Open the TCU.



NOTE: The toner collection hatch cover automatically closes when the TCU is opened.

Figure 1-1741 Open the TCU



3. Pull the TCU away from the printer at an angle to remove it.

⚠ CAUTION: Do not open the toner collection hatch cover when handling the TCU. If toner gets on clothing, wipe it off by using a dry cloth and wash the clothes in cold water. Hot water sets toner into fabric.

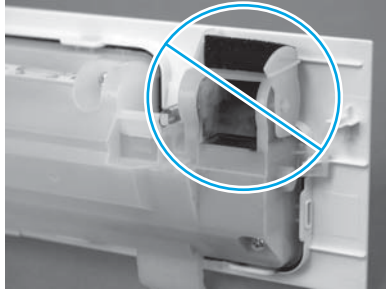
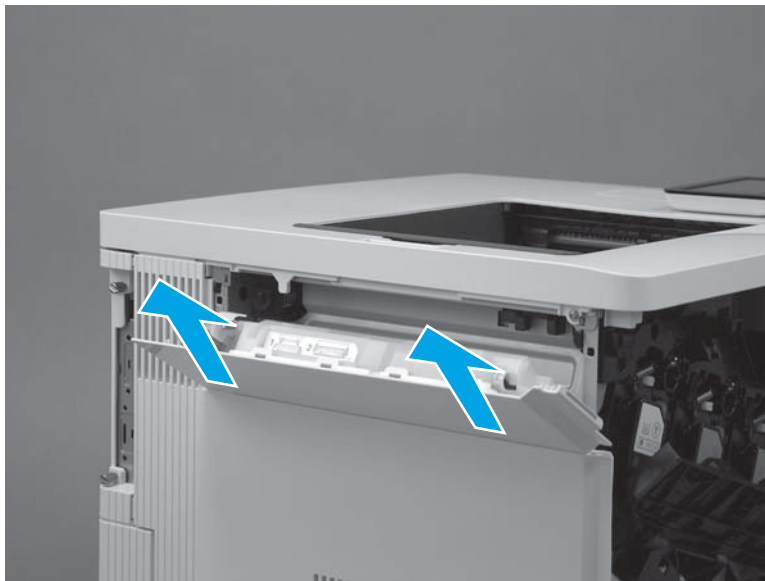

Figure 1-1742 Remove the TCU



Step 2: Remove the formatter cover

1. Locate the formatter cover.

Figure 1-1743 Locate the formatter cover

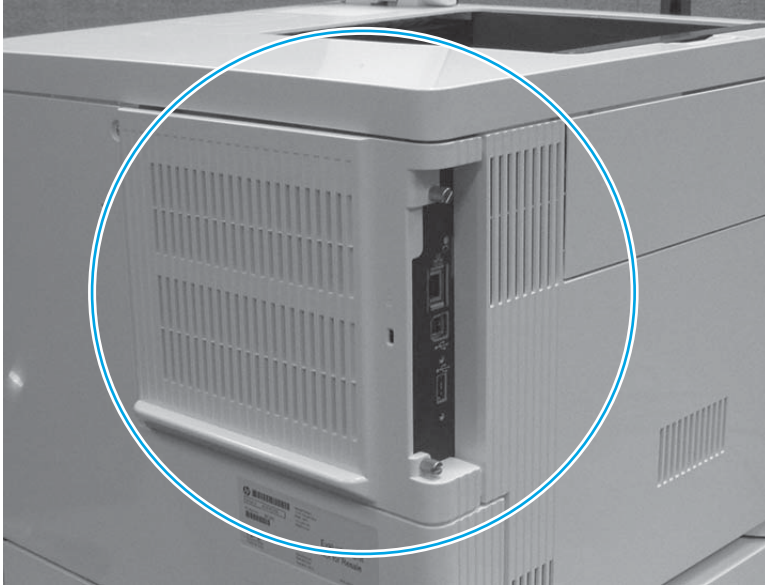

2. Loosen the two thumbscrews (callout 1). Grasp the two thumbscrews, and then slide the cover away from the printer (callout 2) to remove it.

 **TIP:** If needed, use the edge of a coin to turn the thumbscrews.

Figure 1-1744 Loosen the thumbscrews



Step 3: Remove the formatter (M552 and M553)

 **NOTE:** This step is for the M552 and M553 models. For the M577 models, skip this step and go to [Step 4: Remove the hard-disk drive \(HDD\) \(M577\) on page 1002](#).

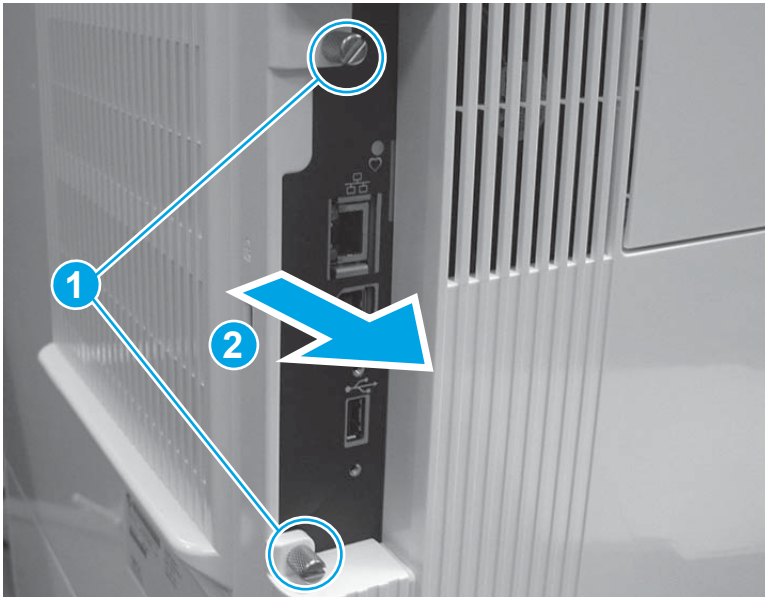
If the optional hard-disk drive (HDD) is installed, it must be removed to gain access to the formatter mounting screws.

Release two tabs along the left edge of the HDD, rotate the left edge away from the product, and then slide the HDD to the left to remove it.

 **CAUTION:**  ESD-sensitive part.

1. Disconnect all of the connectors on the formatter.

The following connectors are empty:

- All models: J1 (this connector is empty unless the optional DIMM is installed)
- M553n/dn and M552dn: J2 (callout 1; this is the touchscreen connector for the M553x model)
- All models: J9 (this connector is empty unless the optional internal USB ports component is installed)
- All models: J18 (this connector is empty unless the optional hard-disk-drive (HDD) is installed)
- All models: J23
- All models: J24
- M553n/dn and M552dn: J25 (this is the wireless connector for the M553x model)
- All models: J57
- All models: J98 (this connector is empty unless the optional trusted platform module (TPM) is installed)

 **IMPORTANT:** The flat-cable connector (callout 2) is a Zero Insertion Force (ZIF) connector that uses a hinged retainer to secure the flat cable. The hinged retainer must be opened to release the flat cable.

Figure 1-1745 Disconnect all connectors



2. Remove four screws (callout 1), and then remove the formatter.

Figure 1-1746 Remove the formatter

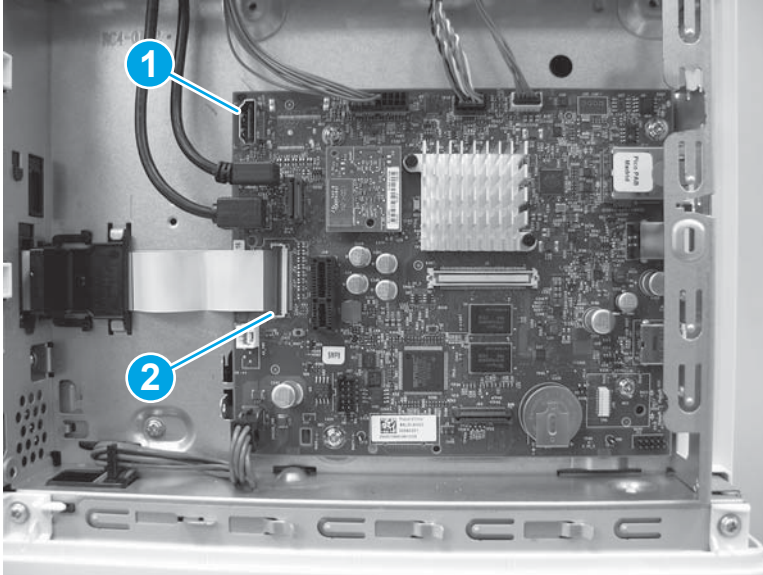
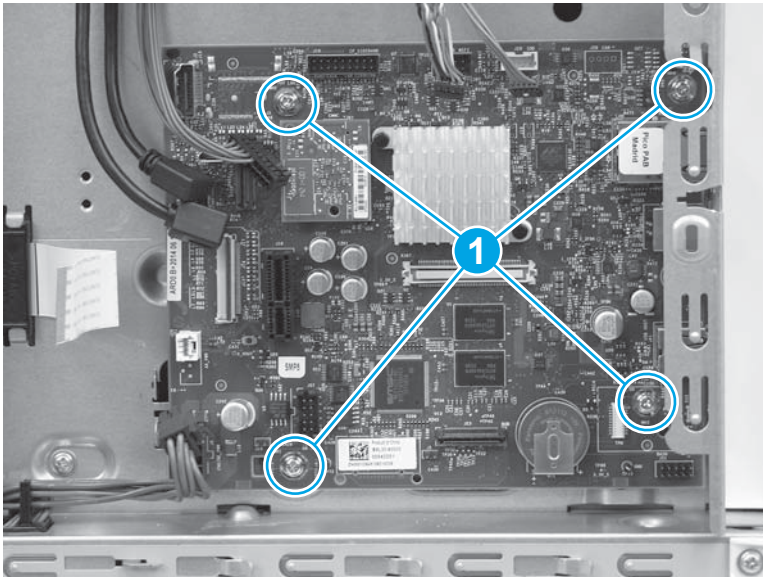

Step 4: Remove the hard-disk drive (HDD) (M577)

 **NOTE:** This step is for the M577 models. For the M552 and M553 models, skip this step and go to [Step 7: Remove the rear cover \(M552 and M553\)](#) on page 1007.

 **CAUTION:**  ESD-sensitive part.

1. Release two tabs (callout 1). Hold the tabs in the released position, and then rotate the hard disk drive (HDD) up (callout 2) to release the connector from the formatter.

Figure 1-1747 Release the HDD

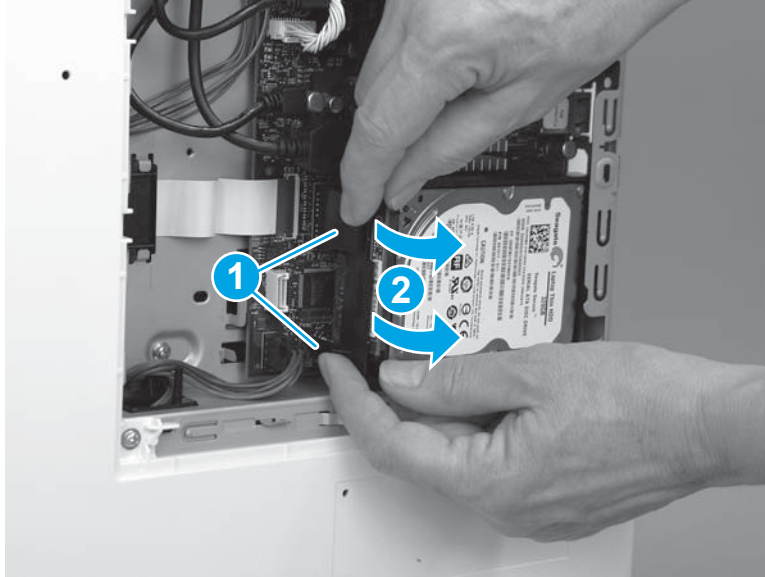

2. Slide the HDD away from the printer to remove it.

Figure 1-1748 Remove the HDD



Step 5: Remove the fax PCA (M577c/f/z)

 **NOTE:** This step is for the M577c/f/z models. For the M577n model, skip this step and go to [Step 6: Remove the formatter \(M577\) on page 1005](#).

For the M552 and M553 models, skip this step and go to [Step 7: Remove the rear cover \(M552 and M553\) on page 1007](#).

 **CAUTION:**  ESD-sensitive part.

1. Locate the fax PCA component on the formatter.

Figure 1-1749 Locate the fax PCA

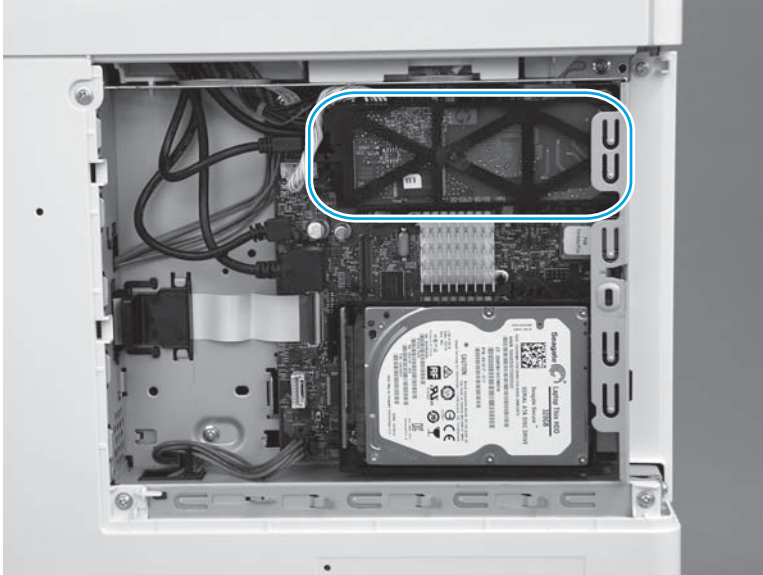

2. Release the connector latch (callout 1), and then pull the connector away from the formatter (callout 2) to disconnect it.

Figure 1-1750 Disconnect one connector

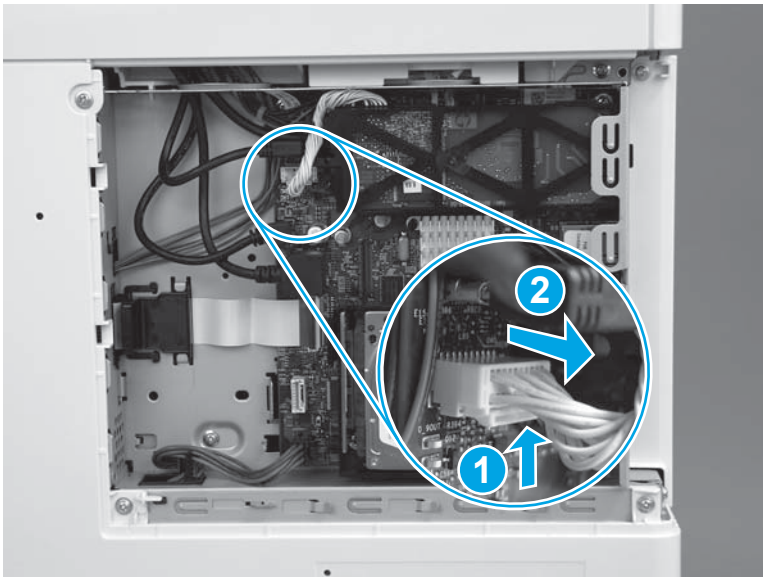

3. Release one retainer (callout 1) by pressing the bracket arms together.

Figure 1-1751 Release one latch

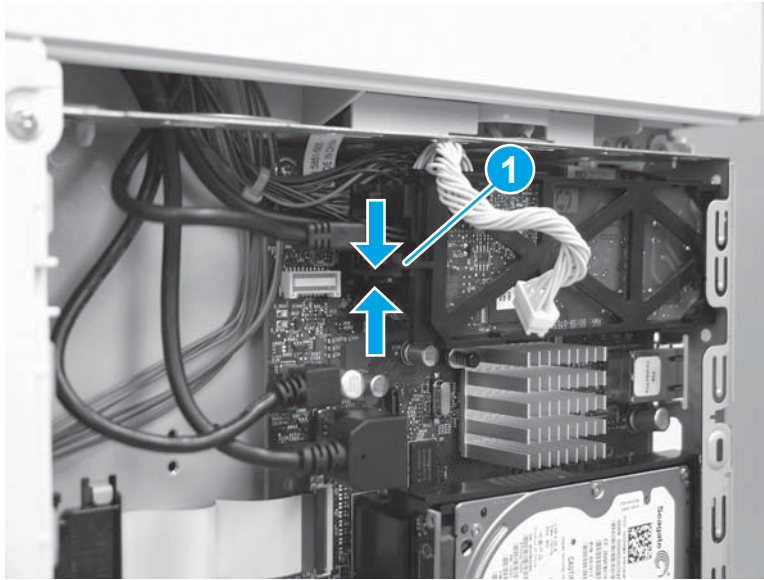

4. Rotate the end of the fax PCA (callout 1) away from the formatter, and then slide the PCA left (callout 2) to remove it.

Figure 1-1752 Remove the fax PCA

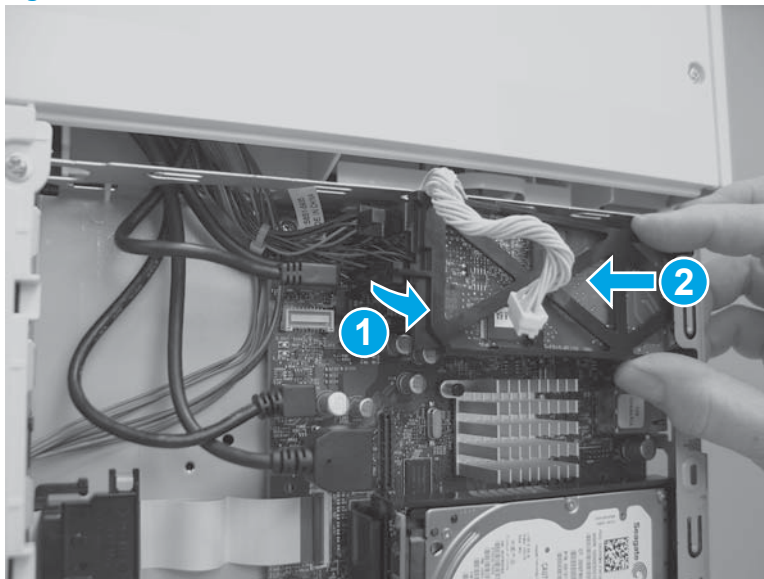

Step 6: Remove the formatter (M577)

 **NOTE:** This step is for the M577 models. For the M552 and M553 models, skip this step and go to [Step 7: Remove the rear cover \(M552 and M553\) on page 1007.](#)

 **CAUTION:**  ESD-sensitive part.

1. Disconnect all of the connectors on the formatter.

The following connectors are empty:

- All models: J1 (this connector is empty unless the optional DIMM is installed)
- All models: J3
- M577dn: J15 (this is the fax connector for the M577f/z/c models)
- All models: J21 (this connector is empty unless the optional internal USB ports component is installed)
- All models: J23
- All models: J24
- All models: J51
- All models: J57
- All models: J97
- All models: J98 (this connector is empty unless the optional trusted platform module (TPM) is installed)

 **IMPORTANT:** The flat-cable connector (callout 1) is a Zero Insertion Force (ZIF) connector that uses a hinged retainer to secure the flat cable. The hinged retainer must be opened to release the flat cable.

Figure 1-1753 Disconnect all connectors



2. Remove four screws (callout 1).

Figure 1-1754 Remove four screws

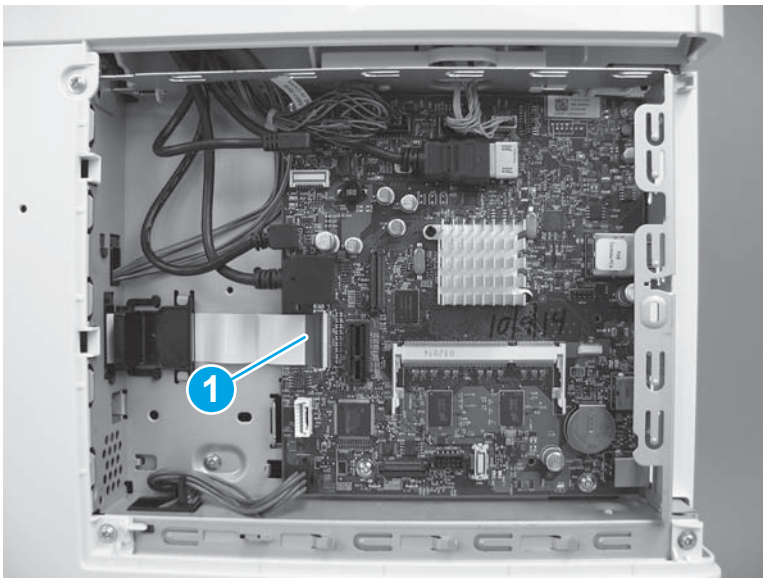
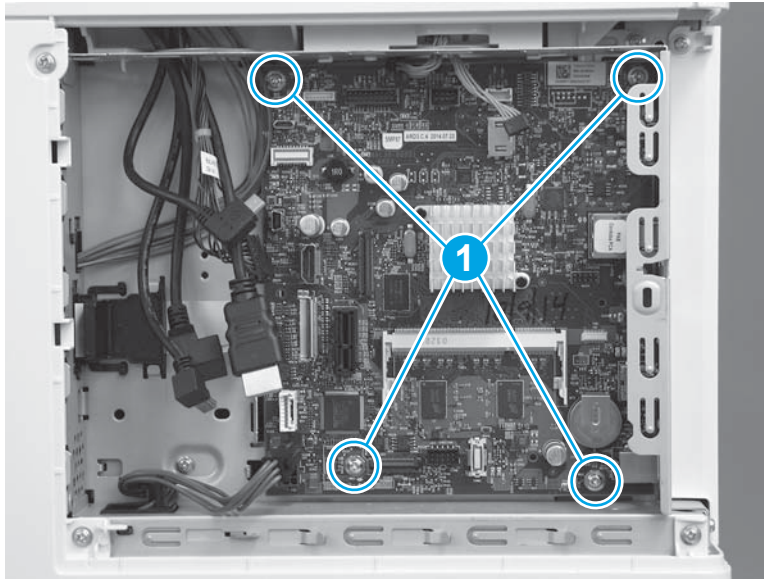

3. Remove the formatter.

Figure 1-1755 Remove the formatter

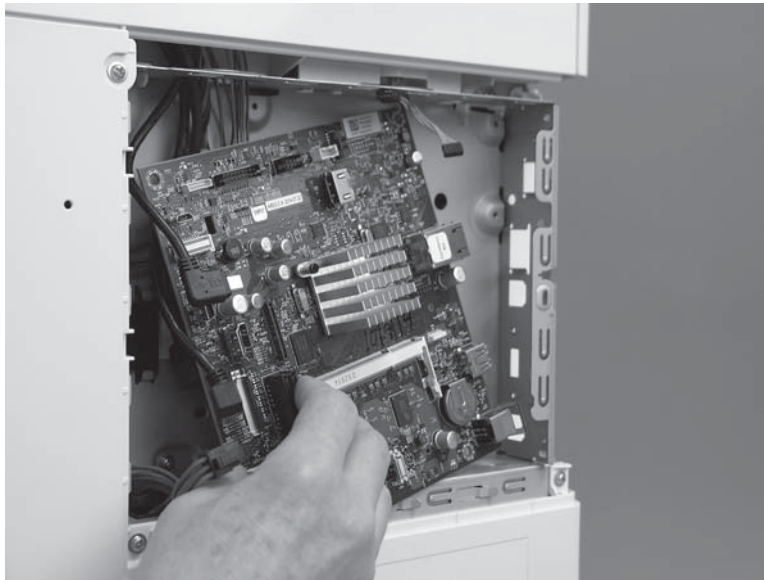

Step 7: Remove the rear cover (M552 and M553)

 **NOTE:** This step is for the M552 and M553 models. For the M577 models, skip this step and go to [Step 8: Remove the rear upper cover \(M577\) on page 1008.](#)

1. Remove four screws (callout 1).

Figure 1-1756 Remove four screws

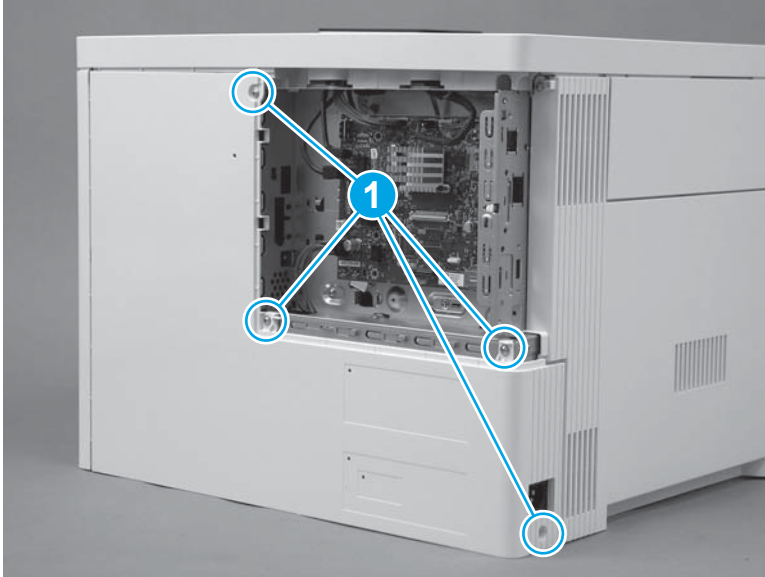

2. Slightly slide the cover to the right (callout 1), rotate the bottom of the cover away from the printer (callout 2), and then pull the top of the cover away from the printer (callout 3) to remove the cover.

Figure 1-1757 Remove the cover

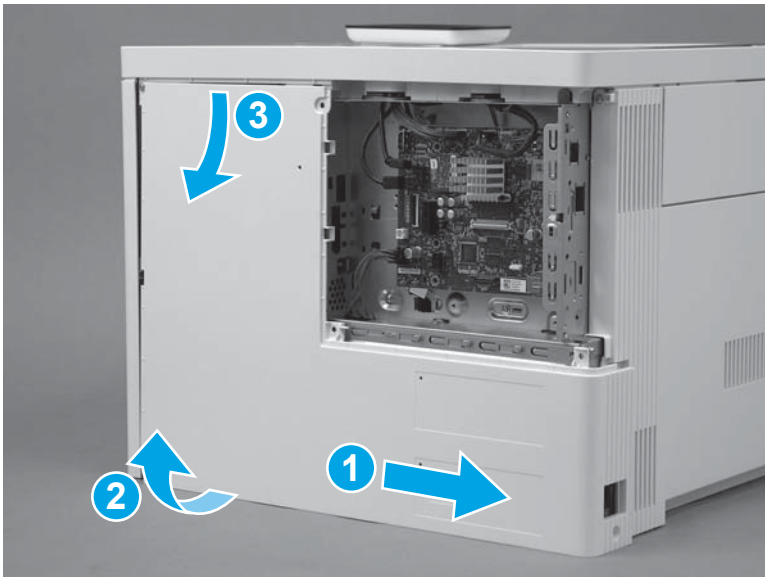

Step 8: Remove the rear upper cover (M577)



NOTE: This step is for the M577 models. For the M552 and M553 models, skip this step and go to [Step 10: Remove the left cover on page 1011](#).

1. Remove two screws (callout 1).



Reinstallation tip: These two screws are self-tapping screws for plastic. When reinstalling them, rotate the screws counterclockwise to align them with the existing thread pattern, and then carefully turn them clockwise to tighten. Do not overtighten. This will prevent stripping the threads inside the screw holes.

Figure 1-1758 Remove two screws

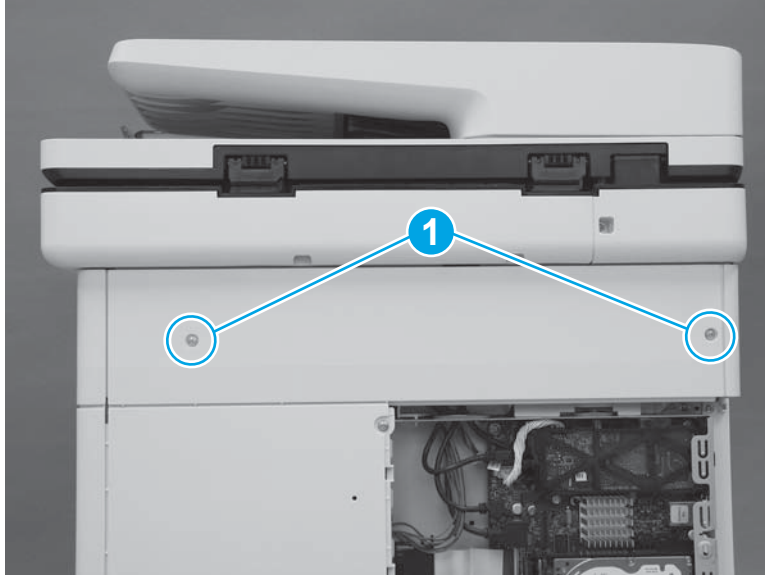

2. Use a small, flat blade screwdriver to release the right edge of the cover.

Figure 1-1759 Release the right edge

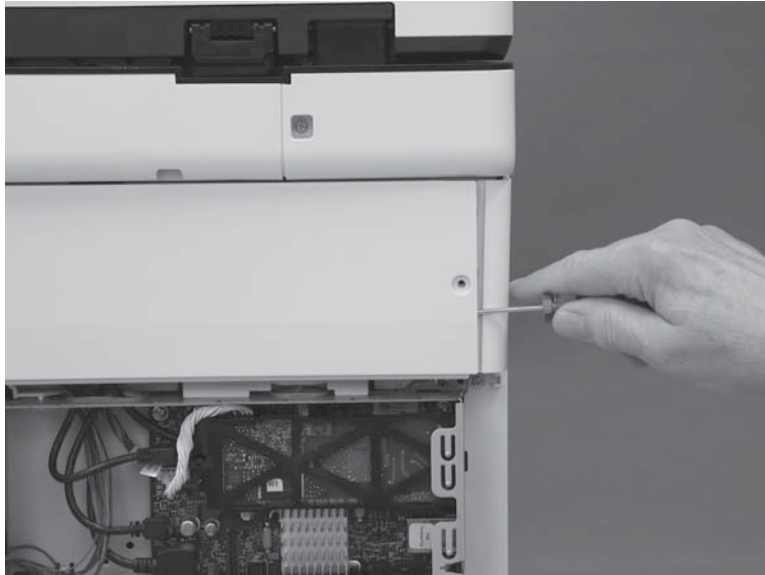

3. Pull the right edge of the cover (callout 1) away from the printer, and then slide the cover to the right (callout 2).

Figure 1-1760 Slide the cover right

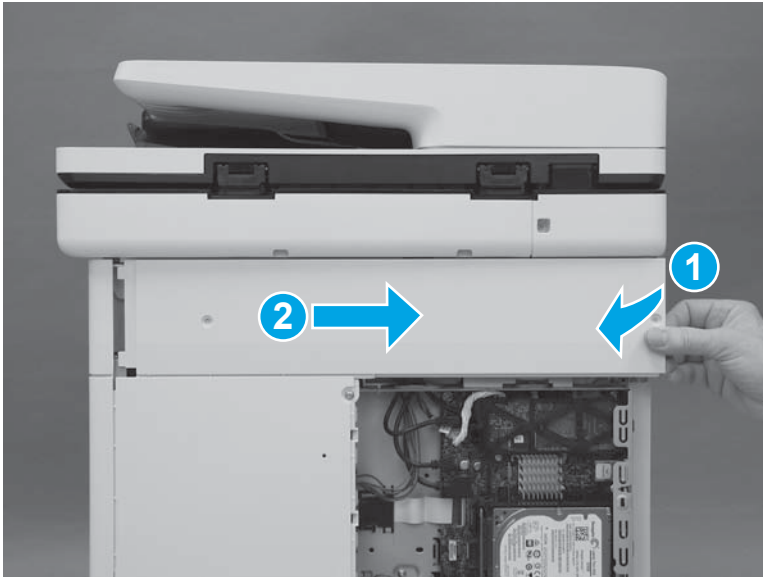

4. Remove the cover.

Figure 1-1761 Remove the cover

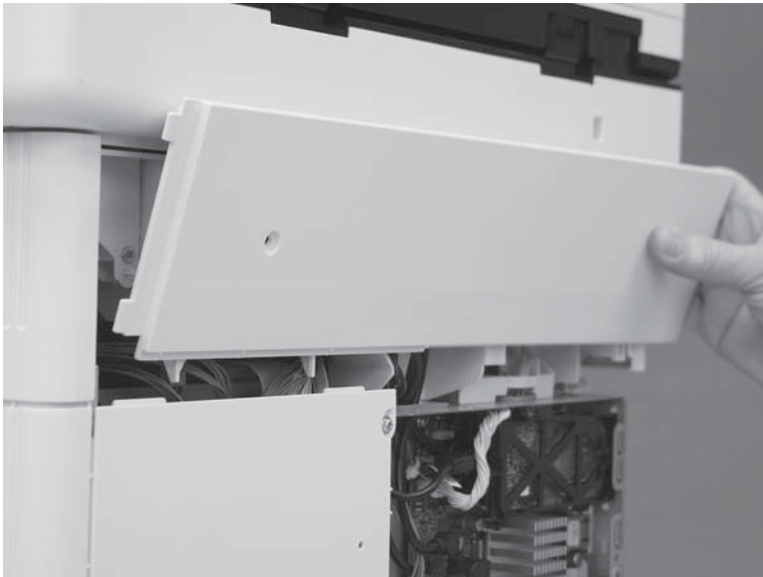

Step 9: Remove the rear cover (M577)



NOTE: This step is for the M577 models. For the M552 and M553 models, skip this step and go to [Step 10: Remove the left cover on page 1011](#).

1. Remove four screws (callout 1).

Figure 1-1762 Remove four screws

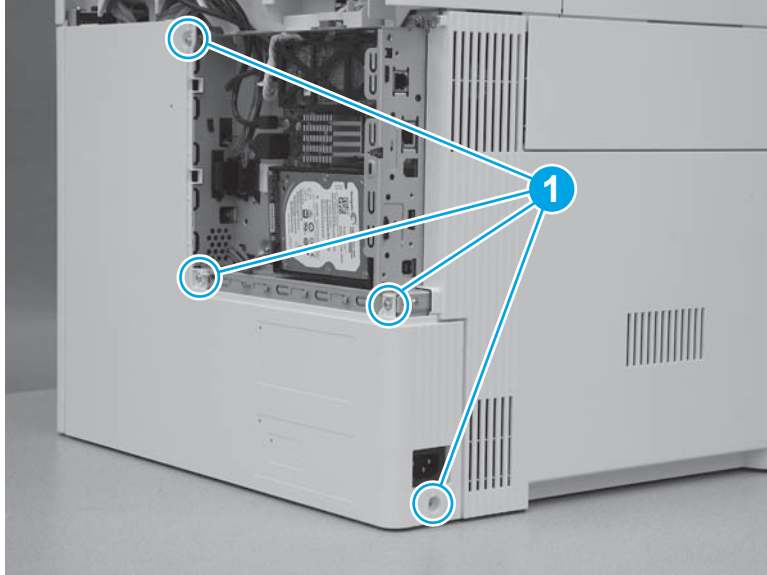

2. Slide the cover to the right to remove it.

Figure 1-1763 Remove the cover

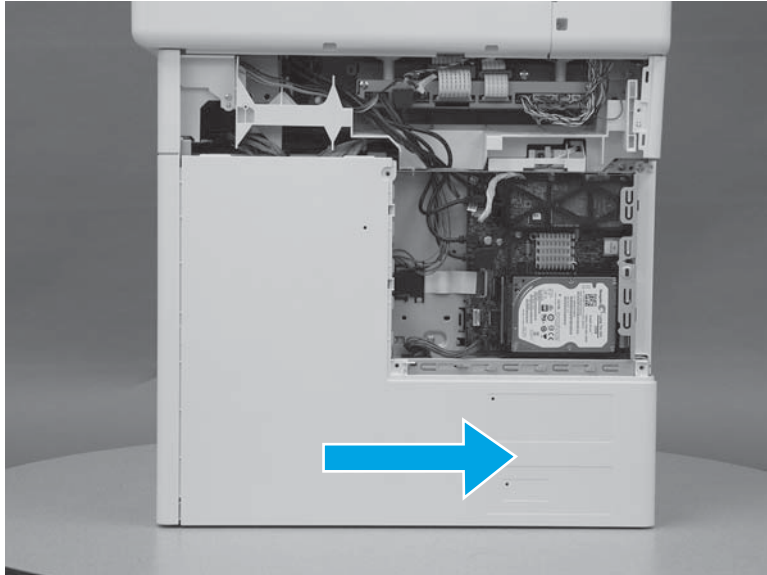

Step 10: Remove the left cover

1. At the left side of the printer, remove one screw (callout 1).

Figure 1-1764 Remove one screw



2. Release one tab (callout 1), rotate the front edge of the cover away from the printer (callout 2), and then slide the cover (callout 3) toward the rear of the printer to release it.

Figure 1-1765 Release the cover

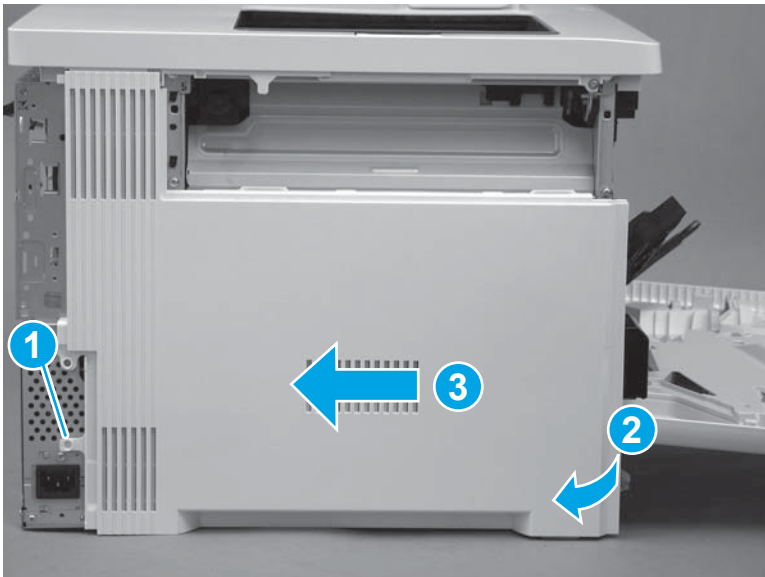

3. Remove the cover.

Figure 1-1766 Remove the cover

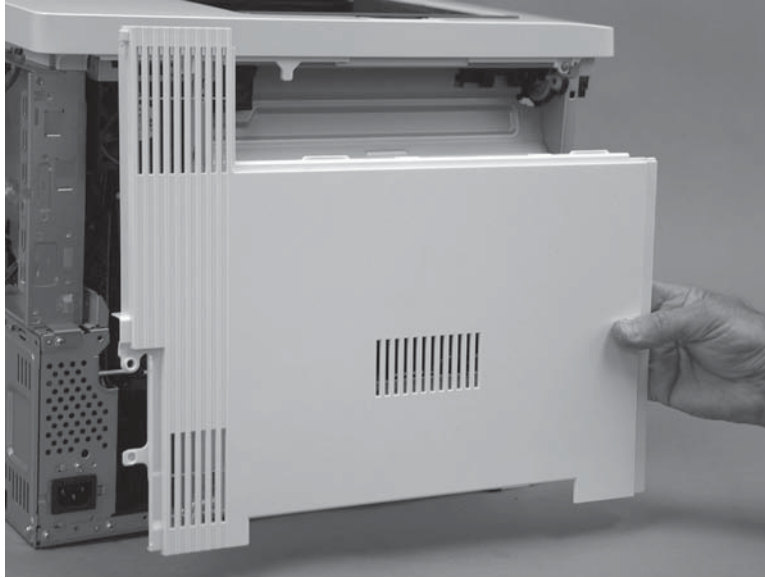

Step 11: Remove the formatter case

1. **M577 only:** Disconnect one connector (callout 1), and then pass the wire harness (callout 2) through two openings in the formatter case (callout 3).

Figure 1-1767 Disconnect one connector

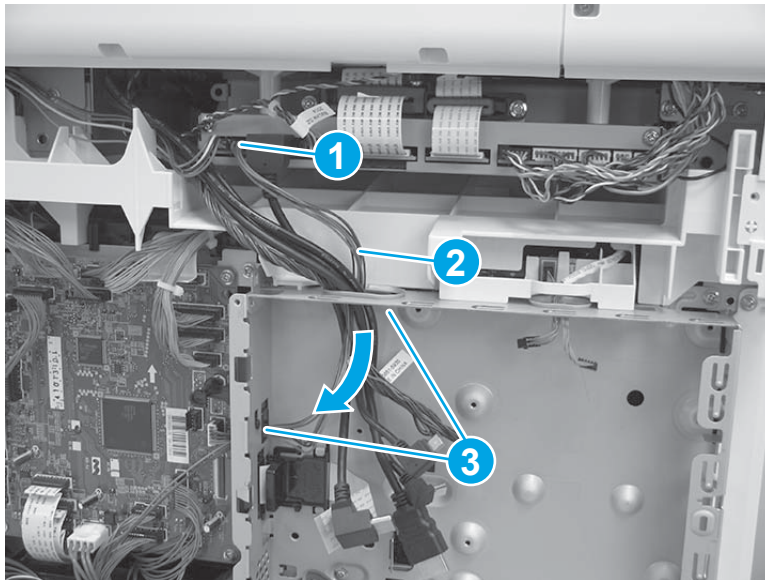

2. Release two tabs (callout 1) on the black plastic bracket. Hold the tabs in the released position, and then slide the bracket (callout 2) to the right to remove it from the formatter case.

Figure 1-1768 Remove the bracket

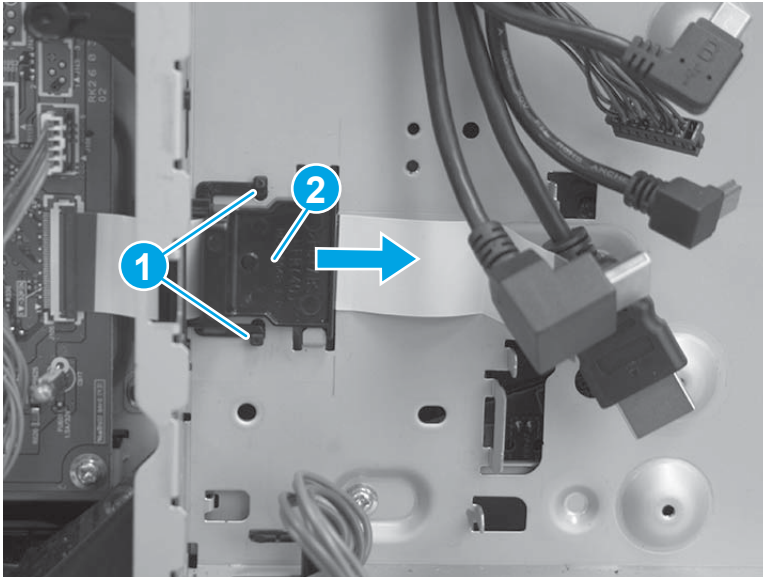

3. Remove two screws (callout 1), and then slide the low-voltage power supply (LVPS) cover to the right to remove it.

Figure 1-1769 Remove the LVPS cover

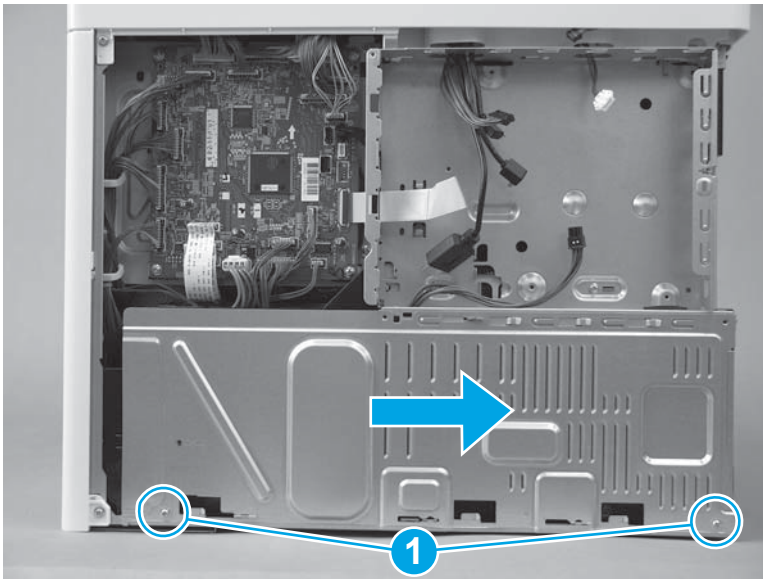

4. Pass two wire harnesses and one flat cable (callout 1) through the opening in the formatter case, and then release one wire harness from the retainer (callout 2).

CAUTION: The flat cable might be attached to the formatter case with double-sided tape. Make sure that this tape is released, so that the flat cable is not damaged when the formatter case is removed.

Figure 1-1770 Release wire harnesses and flat cable

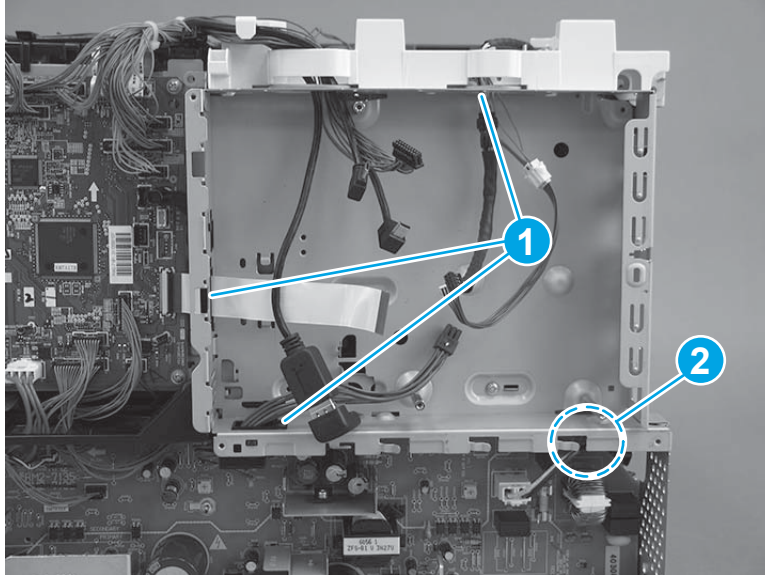

5. Remove six screws (callout 1).

Figure 1-1771 Remove six screws

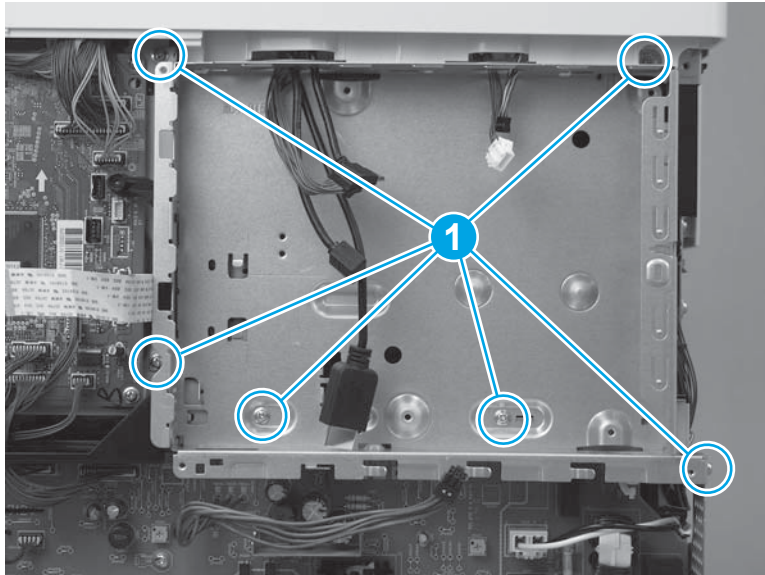

6. Rotate the bottom of the formatter case away from the printer (callout 1), and then pull it down (callout 2) to release it.

Figure 1-1772 Release the formatter case

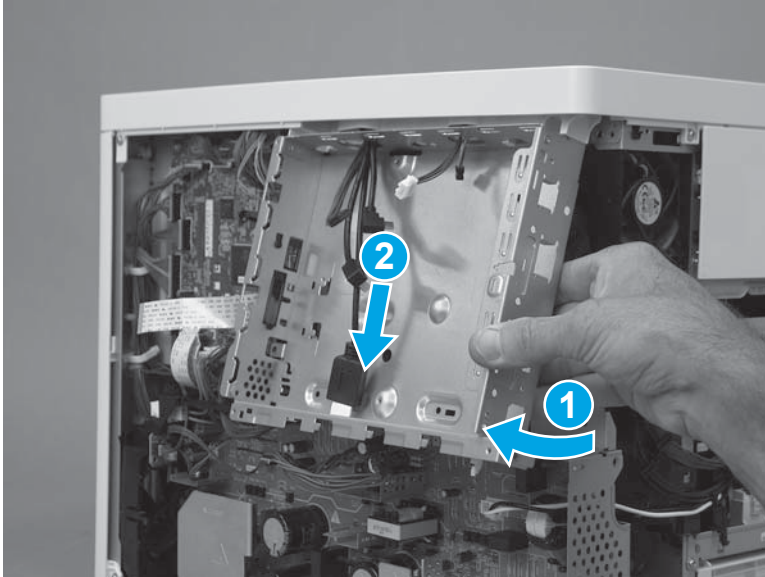

7. Pass the wire harnesses through the opening in the formatter case to remove it.

 **IMPORTANT:** If the formatter case is removed so that it can be replaced, make sure to transfer the memory PCA (island of data) and plastic bracket (callout 1) to the replacement case.

Figure 1-1773 Remove the formatter case



Step 12: Remove drum motor 1 (M1)

- ▲ Disconnect one connector (callout 1), remove four screws (callout 2), and then remove the motor.

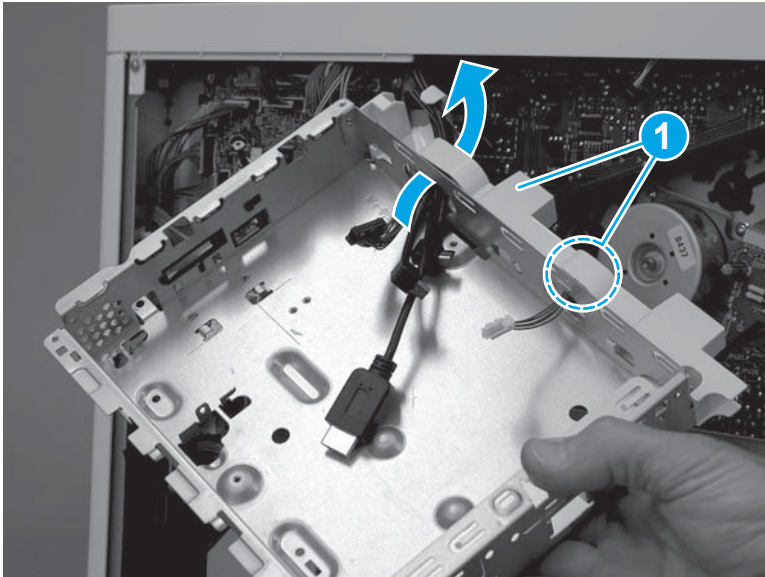
Figure 1-1774 Remove the motor

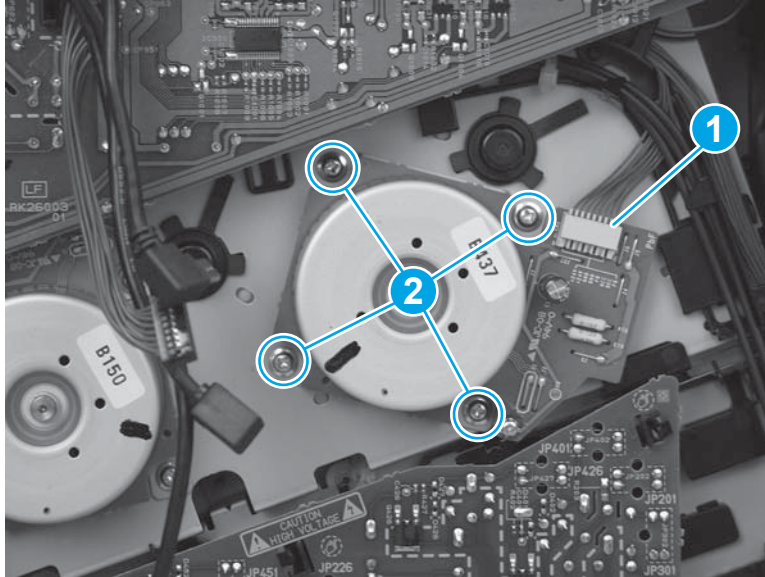

Step 13: Unpack the replacement assembly

Unpack the replacement assembly from the packaging.

For complete information on HP's recycling programs, go to [Product return and recycling](#).

 **NOTE:** HP recommends responsible disposal of the defective assembly.

Figure 1-1775 Recycle and unpack

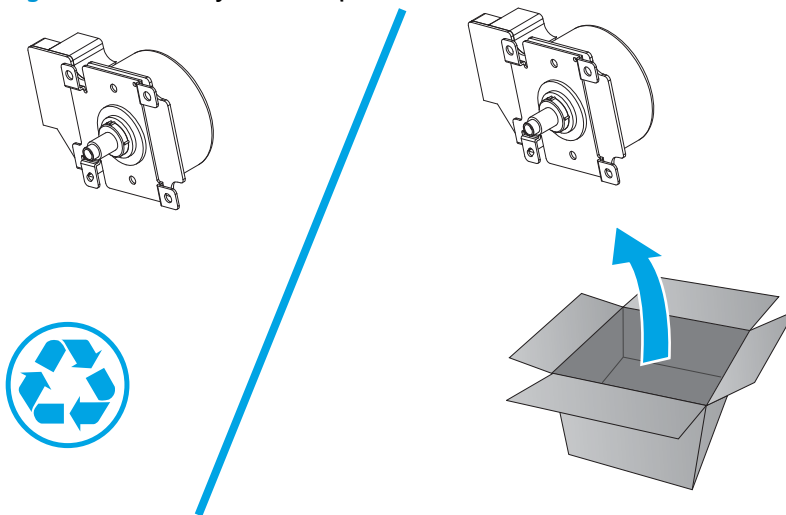

Step 14: Install drum motor 1 (M1)

- ▲ Position the motor on the printer, install four screws (callout 1), and then connect one connector (callout 2).

Figure 1-1776 Install the motor

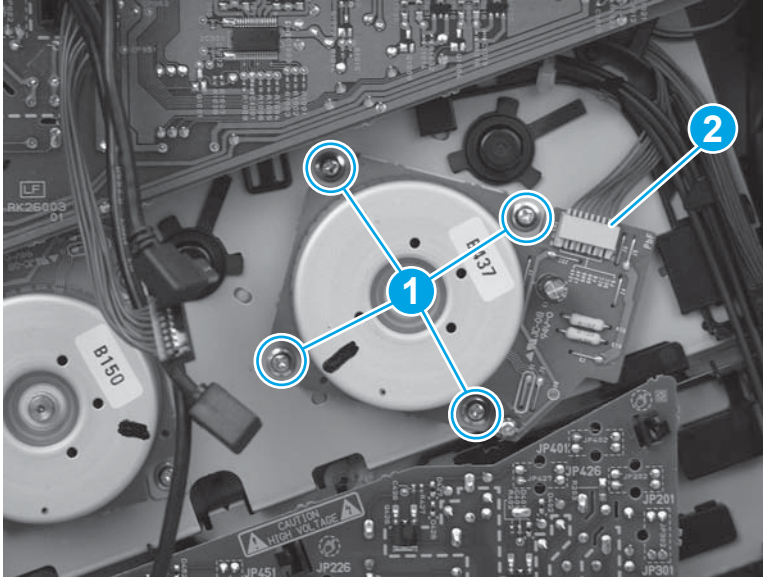

Step 15: Install the formatter case

1. Pass the wire harnesses through the opening in the formatter case.

Figure 1-1777 Pass the wire harnesses through the opening

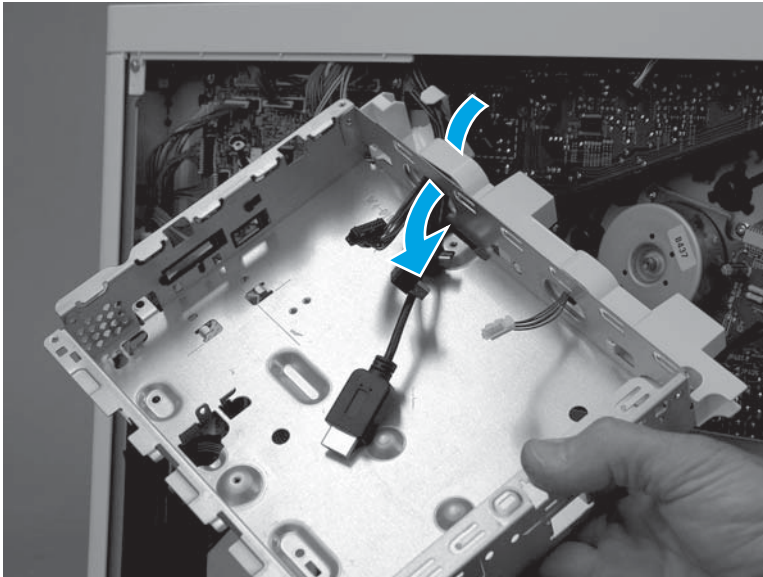

2. Position the top of the formatter case on the printer (callout 1), and then rotate the bottom of the case (callout 2) into the printer.

Figure 1-1778 Install the formatter case

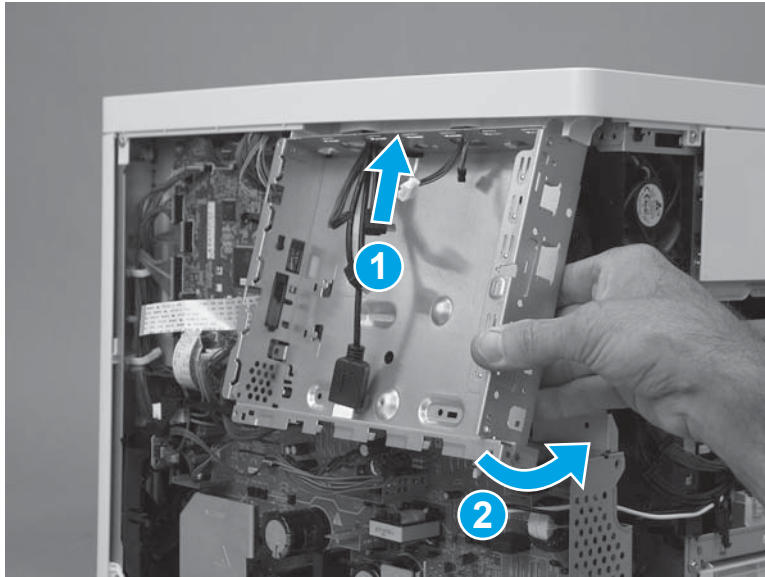

3. Install six screws (callout 1).

Figure 1-1779 Install six screws

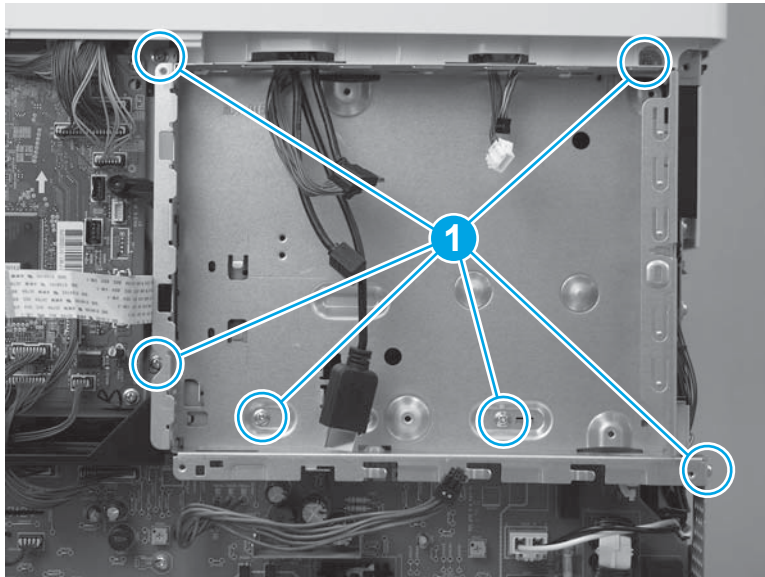

4. Pass two wire harnesses and one flat cable (callout 1) through the opening in the formatter case, and then install one wire harness in the retainer (callout 2).

 **IMPORTANT:** Make sure that the flat cable is securely fastened to the DC controller, and was not dislodged when the formatter case was removed.

Figure 1-1780 Install wire harnesses and flat cable



5. Position the LVPS cover on the printer, slide the cover to the left to install it, and then install two screws (callout 1).

Figure 1-1781 Install the LVPS cover

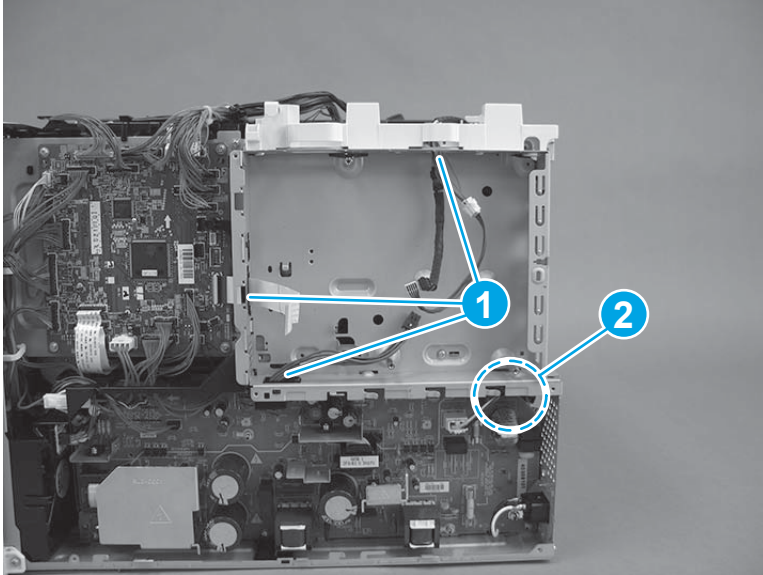
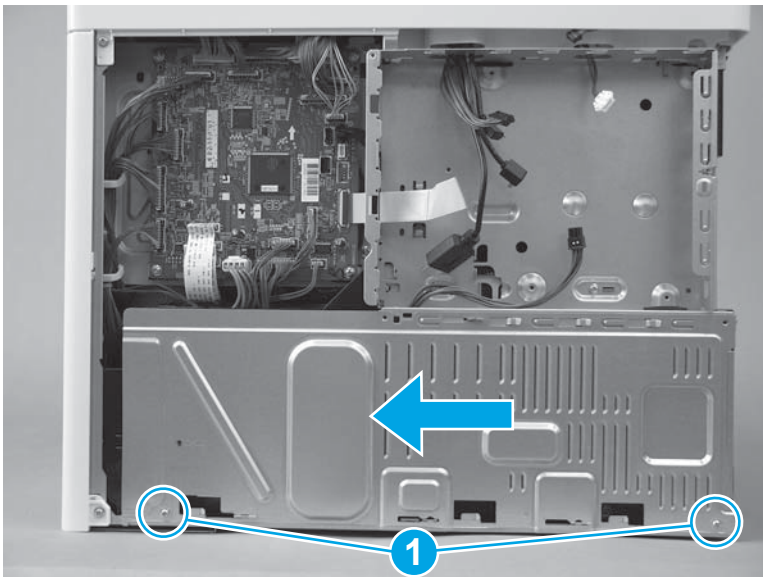

6. If no tape is affixed to the back of the flat cable, skip this step. If double-sided tape is affixed to the back of the flat cable, align the line (callout 1) on the cable with the edge (callout 2) of the opening in the sheet metal. Press to attach the flat cable to the formatter case.

Figure 1-1782 Attach the flat cable

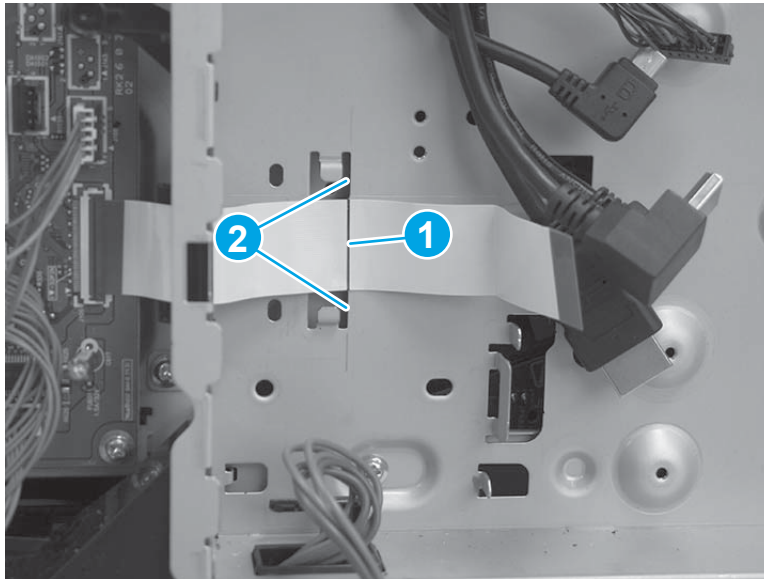

7. Position the bracket over the flat cable, and then slide the bracket to the left to install it. Make sure that the edges of the bracket fit under the sheet metal tabs (callout 1) on the formatter case and that the tabs (callout 2) snap into place.

Figure 1-1783 Position the bracket

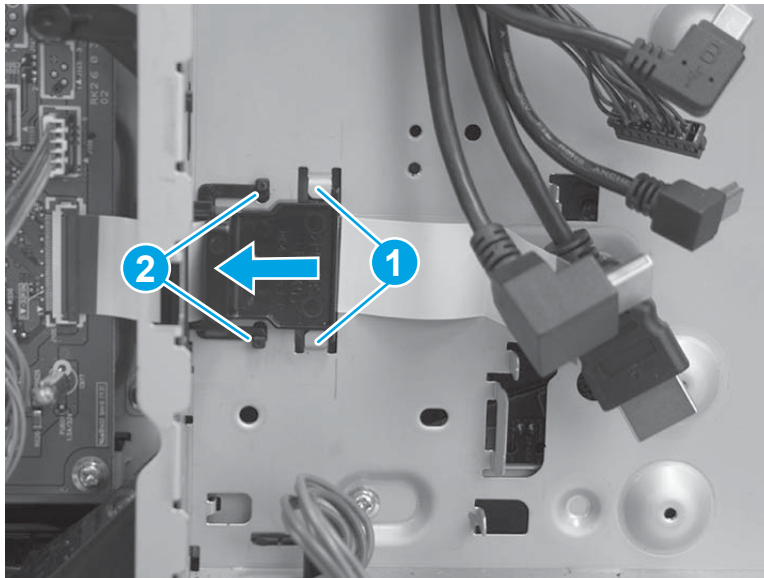

- 8. M577 only:** Pass the wire harness (callout 1) through the openings in the formatter case (callout 2), and then connect one connector (callout 3).

Figure 1-1784 Connect one connector

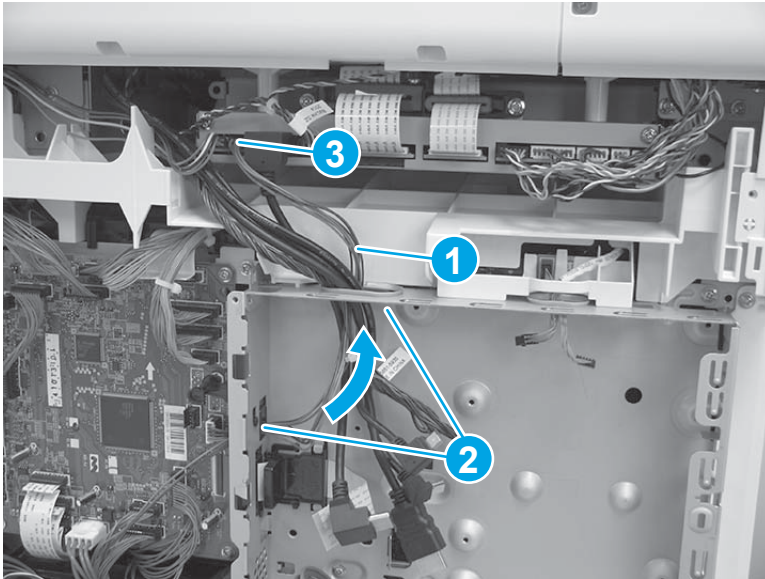

Step 16: Install the left cover

1. Position the cover on the printer.

 **NOTE:** Slightly offset the cover toward the rear of the printer.

Figure 1-1785 Install the cover

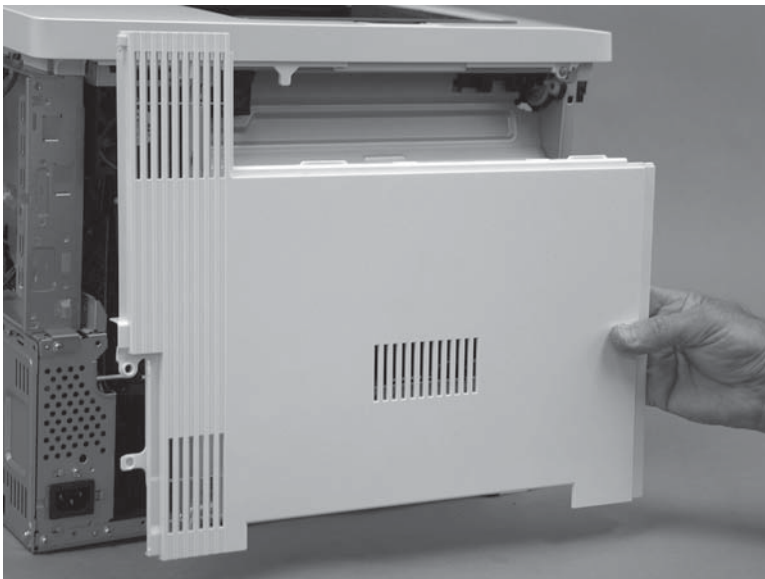

- Slide the cover (callout 1) toward the front of the printer to engage it. Make sure that the tab (callout 2) snaps into place.

 **NOTE:** Locate the alignment pin (callout 3) on the cover from the front door side of the printer, and then make sure that it is fully engaged in the slot in the chassis.

 **TIP:** While sliding the cover into place, push in on the center of the cover (callout 1) to make sure that the hooks on the back of the cover engage with the slots in the chassis.

Figure 1-1786 Engage the cover



- At the left side of the printer, install one screw (callout 1).

Figure 1-1787 Install one screw

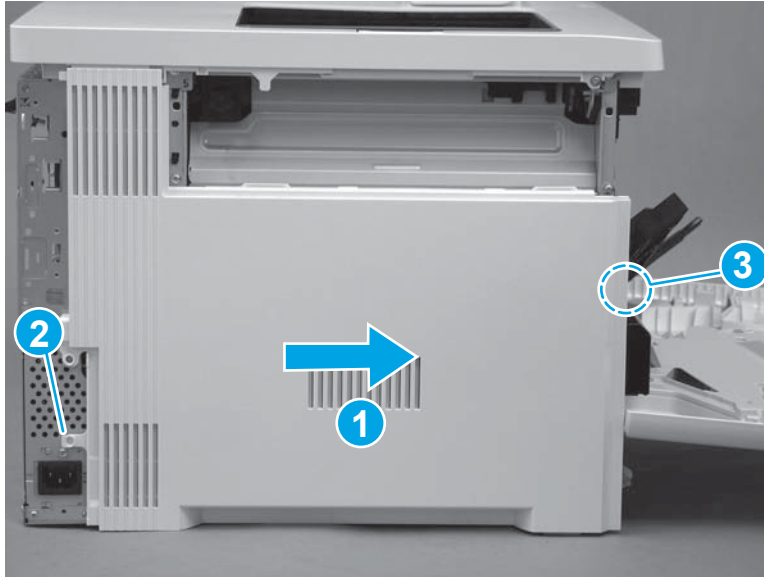

Step 17: Install the rear cover (M577)

 **NOTE:** This step is for the M577 models. For the M552 and M553 models, skip this step and go to [Step 19: Install the rear cover \(M552 and M553\) on page 1027](#).

1. Position the hooks (callout 1) on the cover in the slots (callout 2) in the printer.

Figure 1-1788 Position the hooks

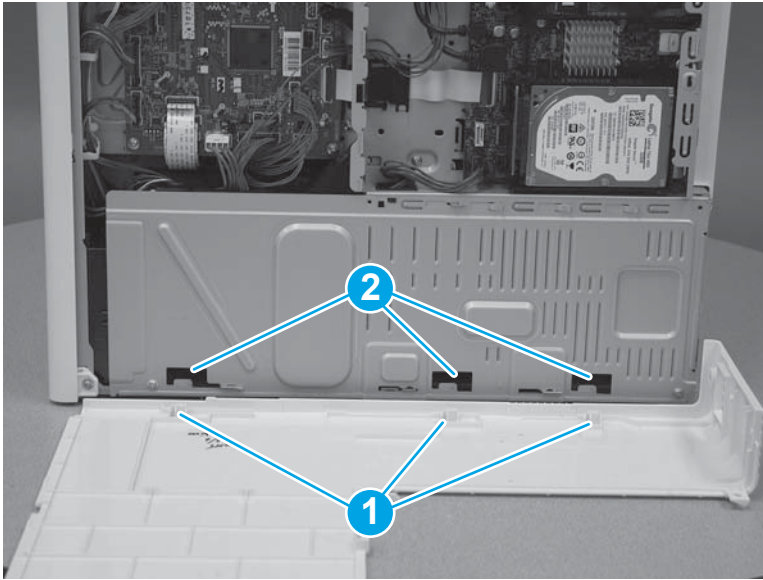

2. Position the back edge (callout 1) of the rear cover behind the edge (callout 2) of the right rear cover. Slide the cover to the left to install it.

Figure 1-1789 Install the cover

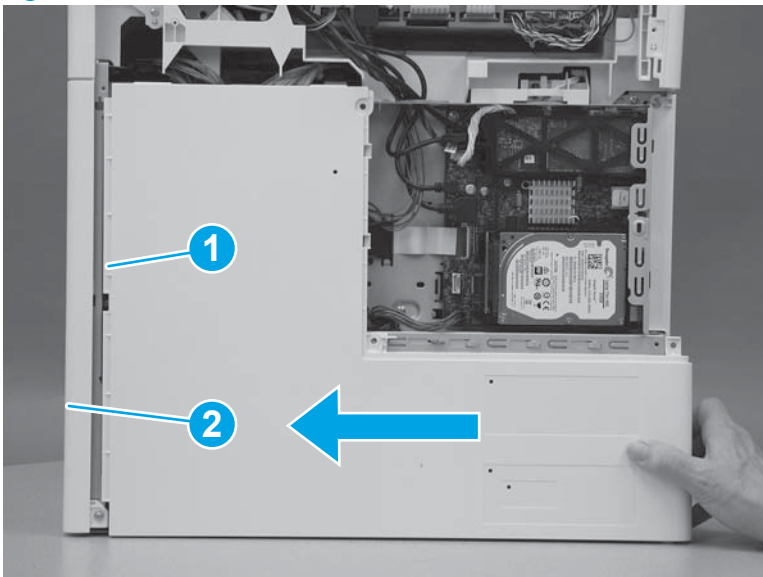

3. Install four screws (callout 1).

Figure 1-1790 Install four screws cover

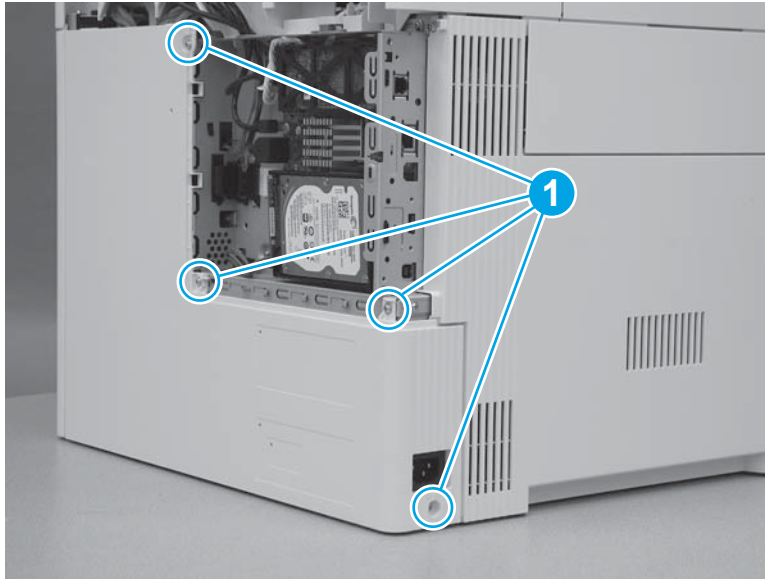

Step 18: Install the rear upper cover (M577)

 **NOTE:** This step is for the M577 models. For the M552 and M553 models, skip this step and go to [Step 19: Install the rear cover \(M552 and M553\) on page 1027](#).

1. Align the ridge (callout 1) on the lower edge of the rear upper cover in front of the tabs (callout 2) on the top edge of the rear cover.

Figure 1-1791 Align the cover

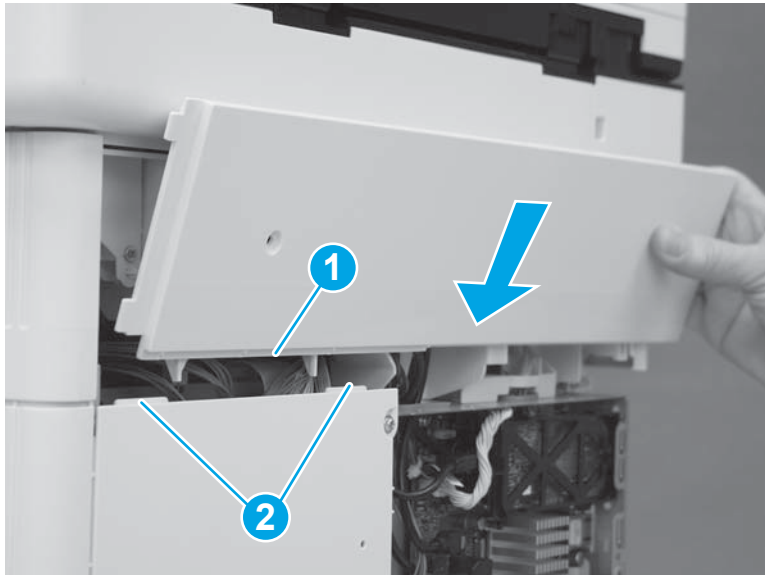

2. Rotate the top of the cover toward the printer.

Figure 1-1792 Rotate the top of the cover

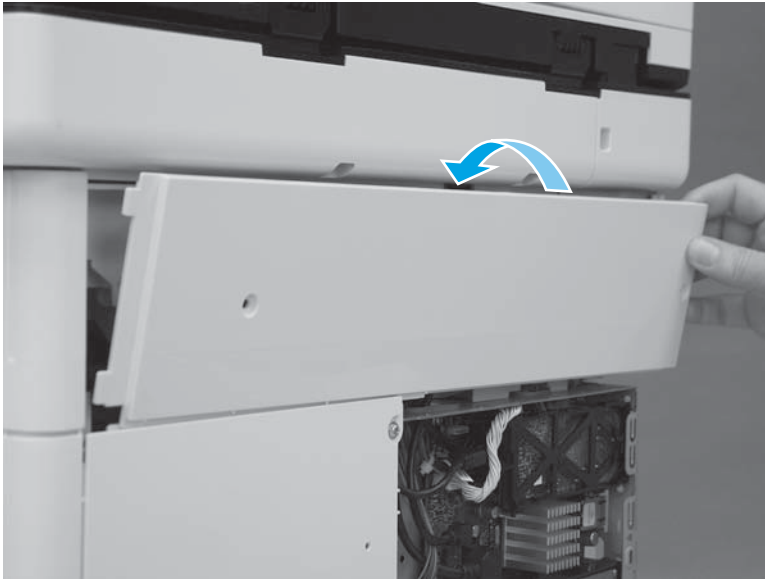

3. Slide the cover to the left (callout 1). Make sure that the tabs (callout 2) on the upper rear cover slide behind the edge (callout 3) of the right upper cover. Make sure that the cover is fully seated.

Figure 1-1793 Slide the cover

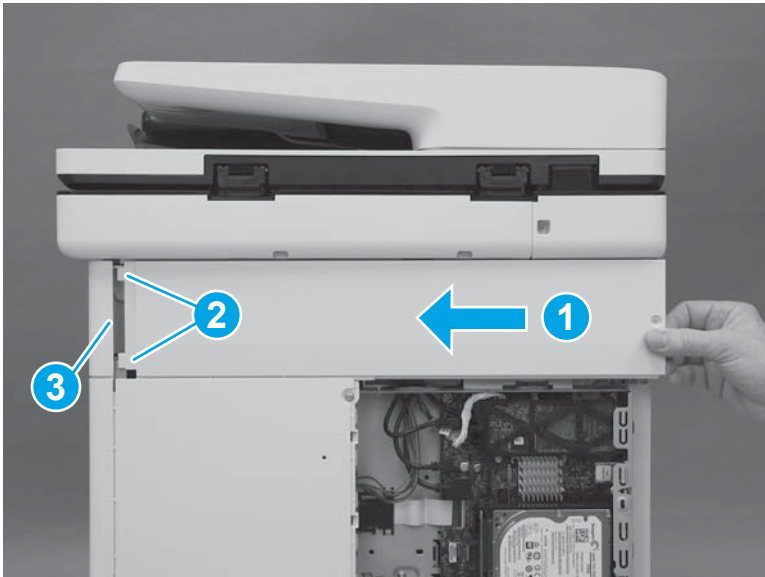

4. Install two screws (callout 1).



 **IMPORTANT:** These two screws are self-tapping screws for plastic. Rotate them counterclockwise to align them with the existing thread pattern, and then carefully turn them clockwise to tighten. Do not overtighten. This will prevent stripping the threads inside the screw holes.

Figure 1-1794 Install two screws

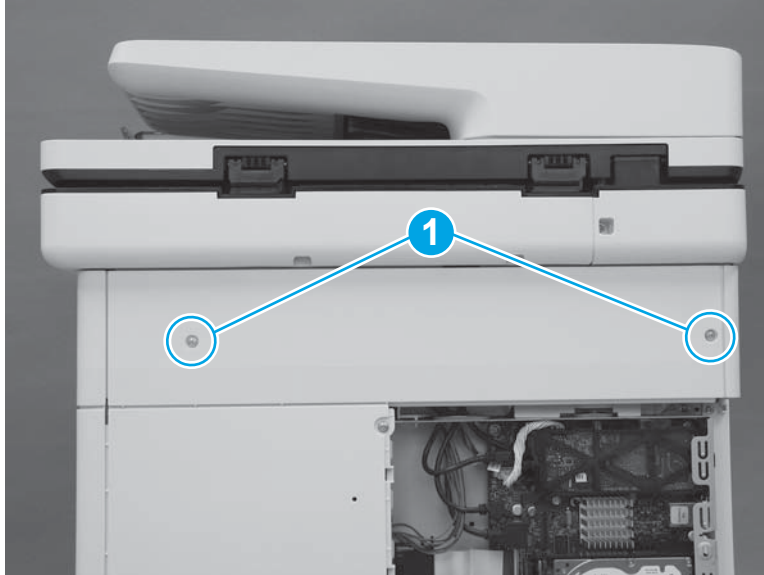

Step 19: Install the rear cover (M552 and M553)

 **NOTE:** This step is for the M552 and M553 models. For the M577 models, skip this step and go to [Step 20: Install the formatter \(M577\) on page 1028](#).

1. Position the top of the cover under the upper cover (callout 1), rotate the bottom of the cover onto the chassis (callout 2), and then slide the cover to the left (callout 3) to install it.

Figure 1-1795 Install the cover

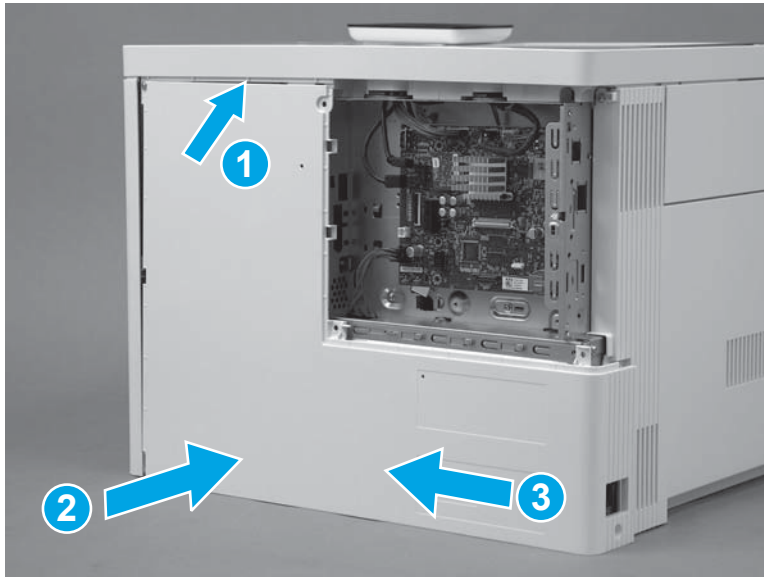

2. Install four screws (callout 1).

Figure 1-1796 Install four screws cover

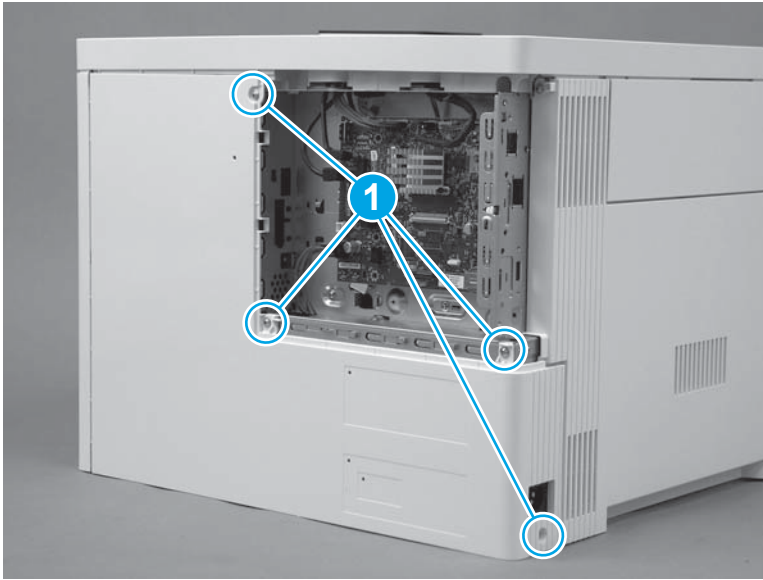

Step 20: Install the formatter (M577)



NOTE: This step is for the M577 models. For the M552 and M553 models, skip this step and to go [Step 23: Install the formatter \(M552 and M553\) on page 1033](#).



CAUTION:  ESD-sensitive part.

1. Position the formatter in the printer. Make sure that the network port (callout 1) fits through the opening (callout 2) in the formatter case.

Figure 1-1797 Install the formatter

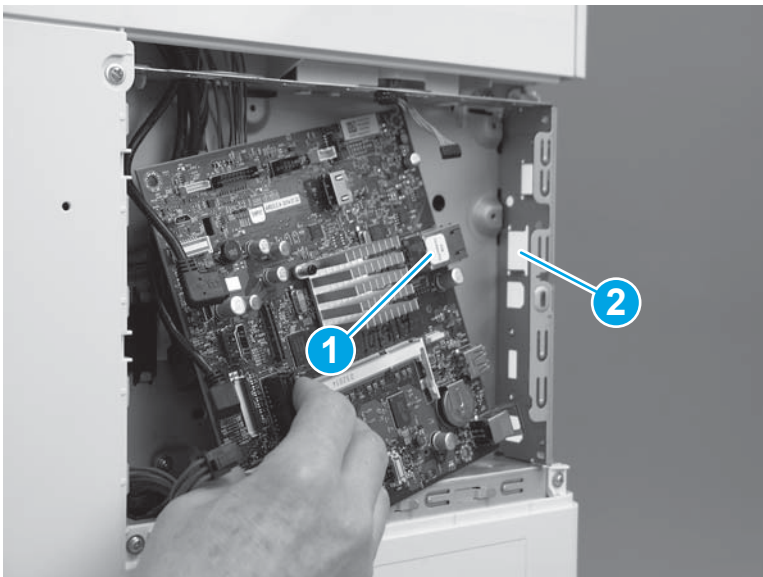

2. Install four screws (callout 1).

Figure 1-1798 Install four screws

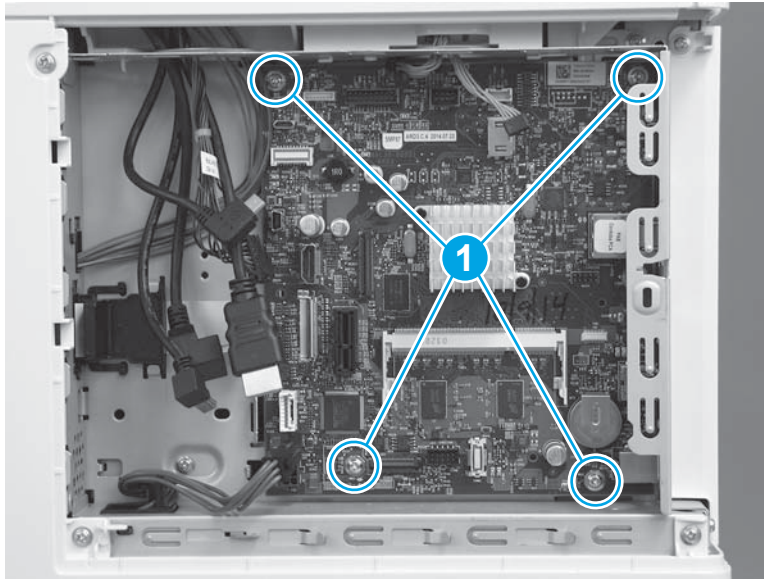

3. Connect all of the connectors on the formatter.

The following connectors are empty:

- All models: J1 (this connector is empty unless the optional DIMM is installed)
- All models: J3
- M577dn: J15 (this is the fax connector for the M577f/z/c models)
- All models: J21 (this connector is empty unless the optional internal USB ports component is installed)
- All models: J23
- All models: J24
- All models: J51
- All models: J57
- All models: J97
- All models: J98 (this connector is empty unless the optional trusted platform module (TPM) is installed)

 **IMPORTANT:** The flat-cable connector (callout 1) is a Zero Insertion Force (ZIF) connector that uses a hinged retainer to secure the flat cable. The hinged retainer must be opened to install the flat cable, and then closed after the cable is installed.

Figure 1-1799 Connect all connectors



Step 21: Install the fax PCA (M577c/f/z)

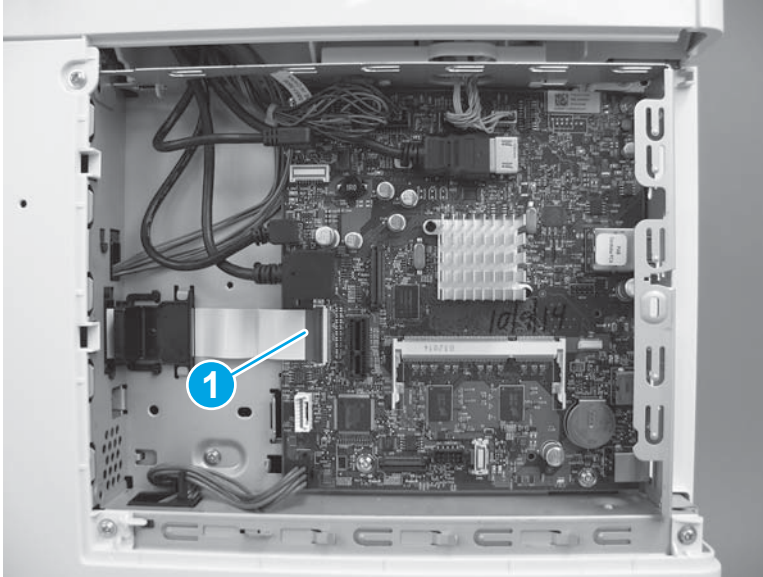

NOTE: This step is for the M577c/f/z models. For the M577n model, skip this step and go to [Step 22: Install the HDD \(M577\) on page 1031](#).

For the M552 and M553 models, skip this step and go to [Step 23: Install the formatter \(M552 and M553\) on page 1033](#).



CAUTION:  ESD-sensitive part.

1. Position the tab and telephone port (callout 1) on the fax PCA in the slots (callout 2) in the formatter case.

Figure 1-1800 Position the fax PCA

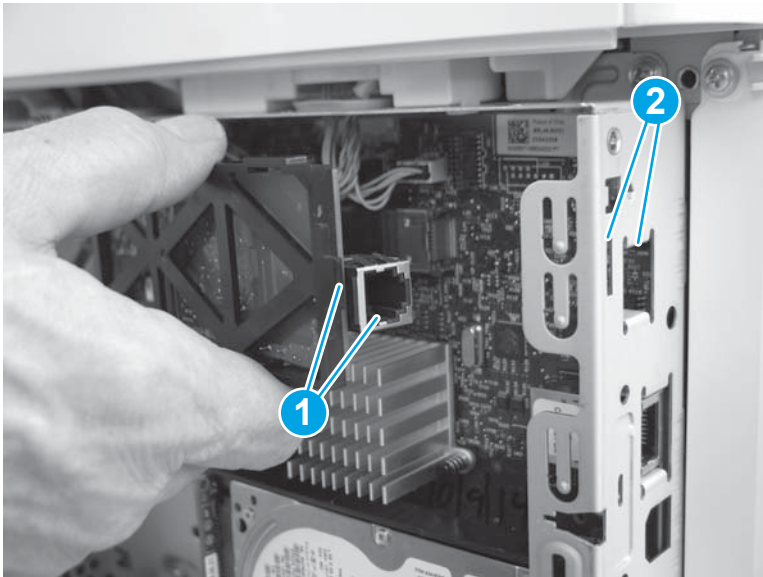

2. Slide the fax PCA to the right (callout 1) until the tab and telephone port described in the previous step and seated in the formatter case. Position the retainer (callout 2) in the slot (callout 3) in the formatter. Rotate the end of the fax PCA toward the formatter (callout 4) until the retainer snaps into place.

Figure 1-1801 Install the fax PCA

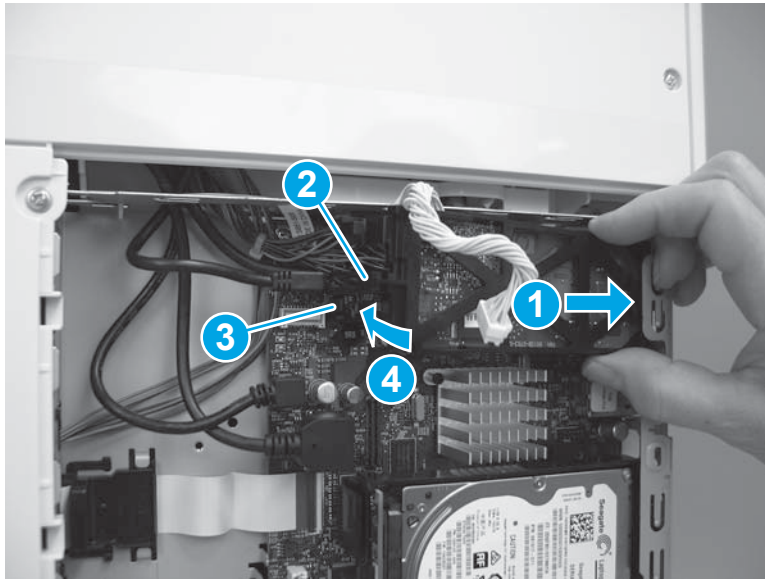

3. Position the cable (callout 1) in the guide (callout 2), and then connect one connector (callout 3).

Figure 1-1802 Connect the connector

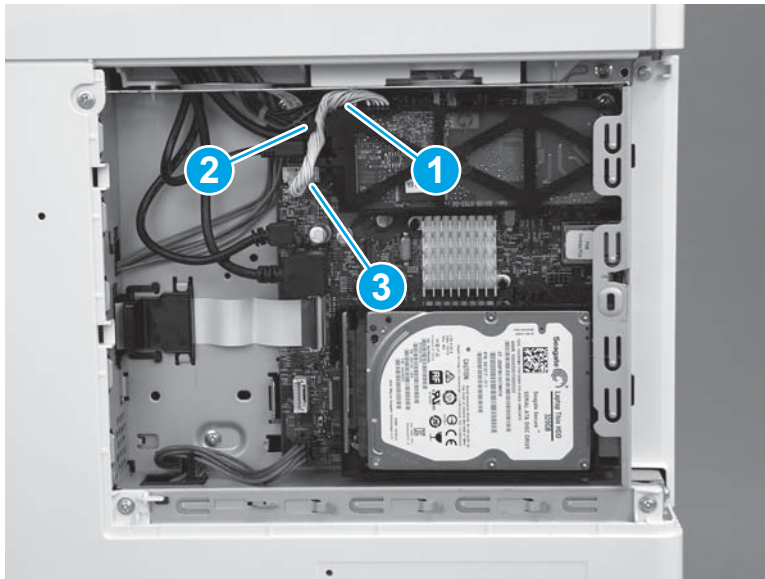

Step 22: Install the HDD (M577)

 **NOTE:** This step is for the M577 models. For the M552 and M553 models, skip this step and go to [Step 23: Install the formatter \(M552 and M553\) on page 1033.](#)

 **CAUTION:**  ESD-sensitive part.

1. Align the end of the bracket (callout 1) with the slot in the chassis (callout 2), and then slide the HDD into the printer (callout 3) to engage the bracket with the chassis.

Figure 1-1803 Install the holder

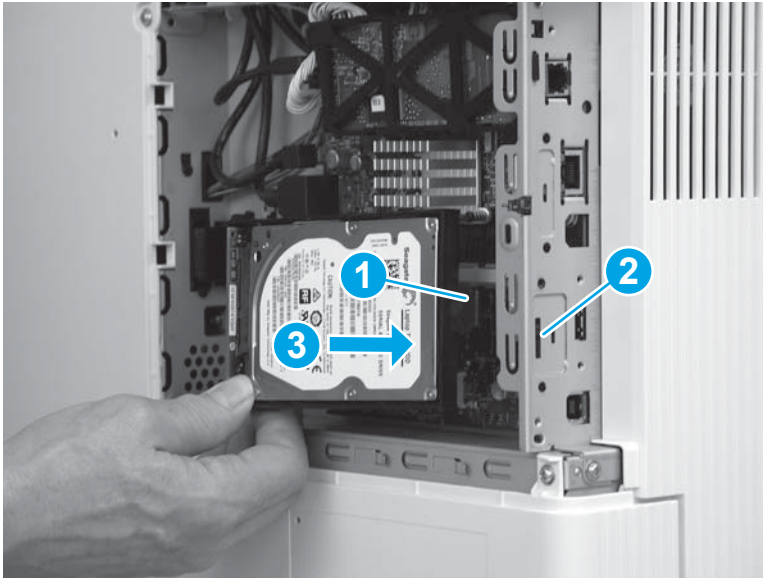

2. Hold the HDD connector latch (callout 1) in the released position, and then rotate the HDD down and into the connector on the formatter to install it.

 **NOTE:** Make sure that the tab (callout 2) snaps into place, and that the HDD is securely installed.

Figure 1-1804 Release the HDD

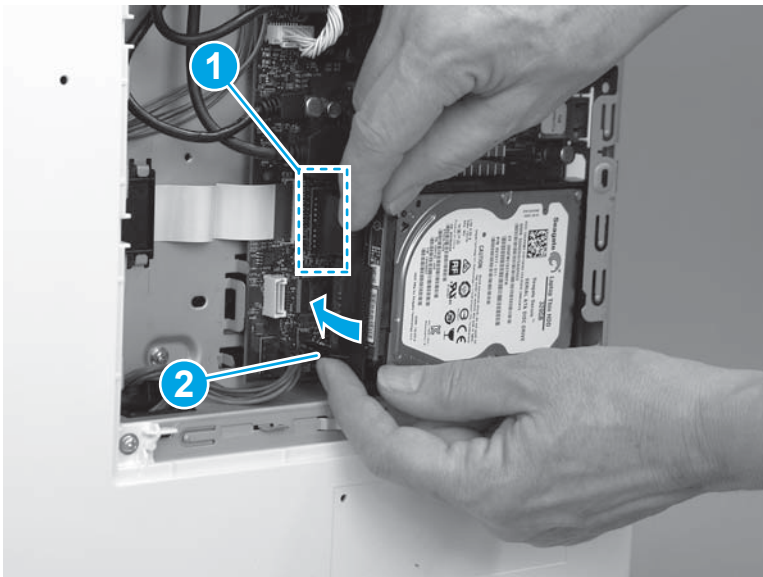

Step 23: Install the formatter (M552 and M553)

 **NOTE:** This step is for the M552 and M553 models. For the M577 models, skip this step and go to [Step 24: Install the formatter cover on page 1034](#).

If the optional hard-disk drive (HDD) was removed, do not forget to reinstall it after the formatter is reinstalled.

Engage the HDD holder with the chassis, rotate the HDD connector down and into the connector on the formatter. Make sure that the tabs snap into place.

 **CAUTION:**  ESD-sensitive part.

1. Position the formatter in the printer, and then install four screws (callout 1).

Figure 1-1805 Install the formatter

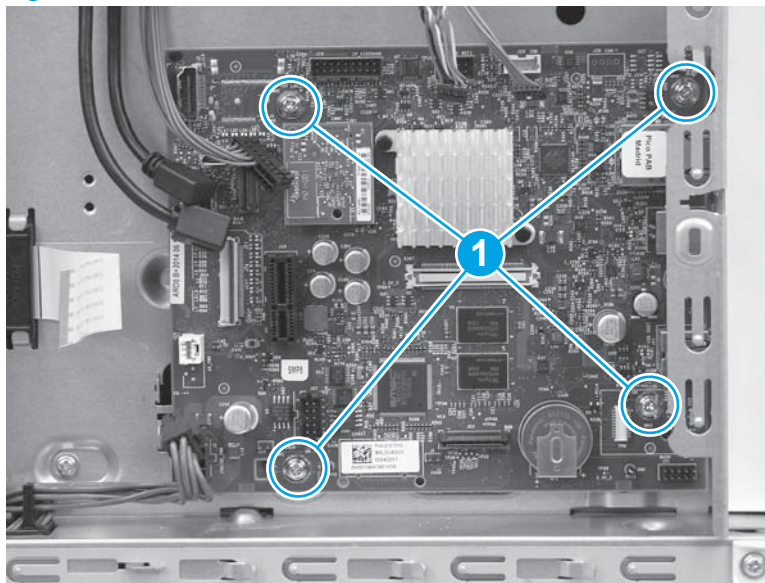

2. Connect all of the connectors on the formatter.

The following connectors are empty:

- All models: J1 (this connector is empty unless the optional DIMM is installed)
- M553n/dn and M552dn: J2 (callout 1; this is the touchscreen connector for the M553x model)
- All models: J9 (this connector is empty unless the optional internal USB ports component is installed)
- All models: J18 (this connector is empty unless the optional hard-disk-drive (HDD) is installed)
- All models: J23
- All models: J24
- M553n/dn and M552dn: J25 (this is the wireless connector for the M553x model)

- All models: J57
- All models: J98 (this connector is empty unless the optional trusted platform module (TPM) is installed)



 **IMPORTANT:** The flat-cable connector (callout 2) is a Zero Insertion Force (ZIF) connector that uses a hinged retainer to secure the flat cable. The hinged retainer must be opened to install the flat cable.

Figure 1-1806 Connect all connectors

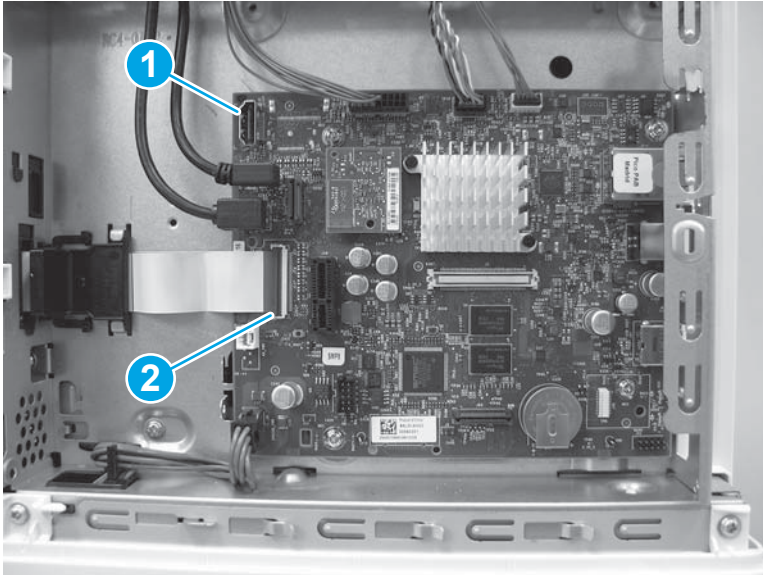

Step 24: Install the formatter cover

- ▲ Slide the cover onto the printer (callout 1) to install it.

 **NOTE:** Make sure that the tabs on the formatter cover align with the slots provided in the printer (callout 2). Tighten the two thumbscrews (callout 3).

 **TIP:** If needed, use the edge of a coin to turn the thumbscrews.

Figure 1-1807 Install the cover



Step 25: Install the TCU

1. Verify that the toner collection hatch cover is in the closed position on the TCU.

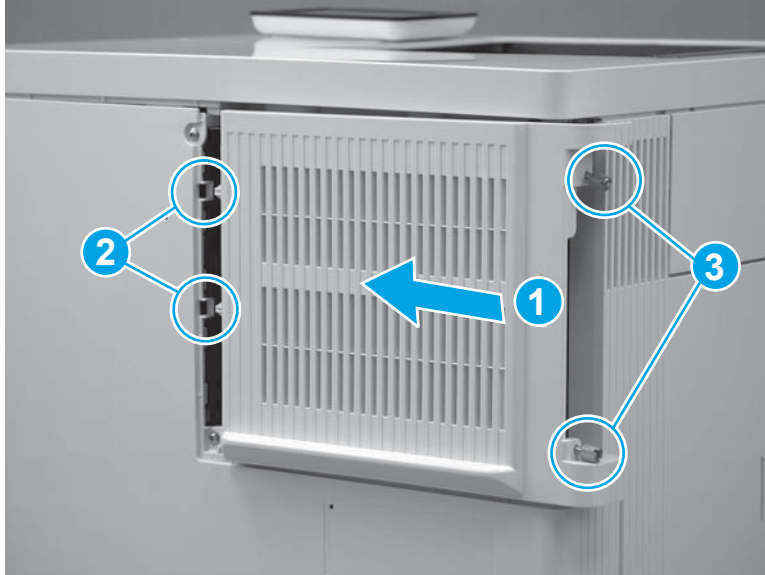
Figure 1-1808 Verify that the toner collection hatch cover is closed

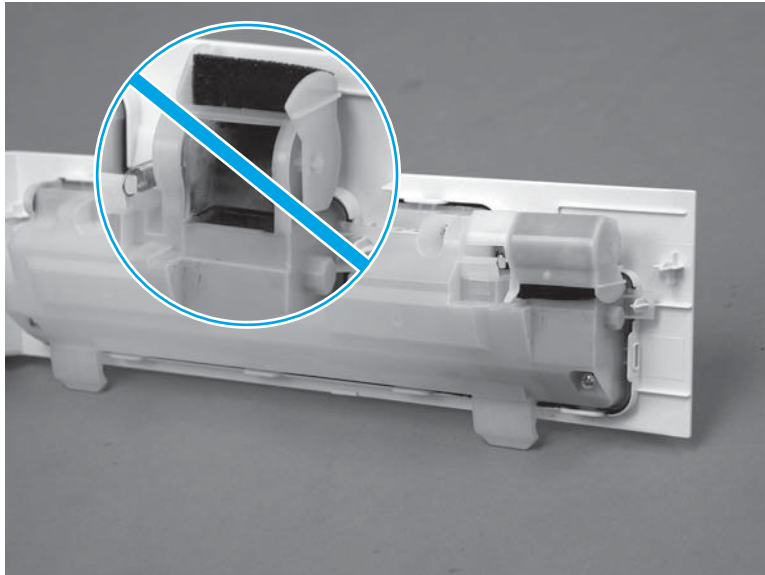

2. Position the TCU with the hinges in the slots provided in the printer (callout 1), and then rotate the TCU up and into the closed position.

 **NOTE:** The toner collection hatch cover automatically opens when the TCU is closed.

Figure 1-1809 Install the TCU



3. Close the front door.

Figure 1-1810 Close the front door

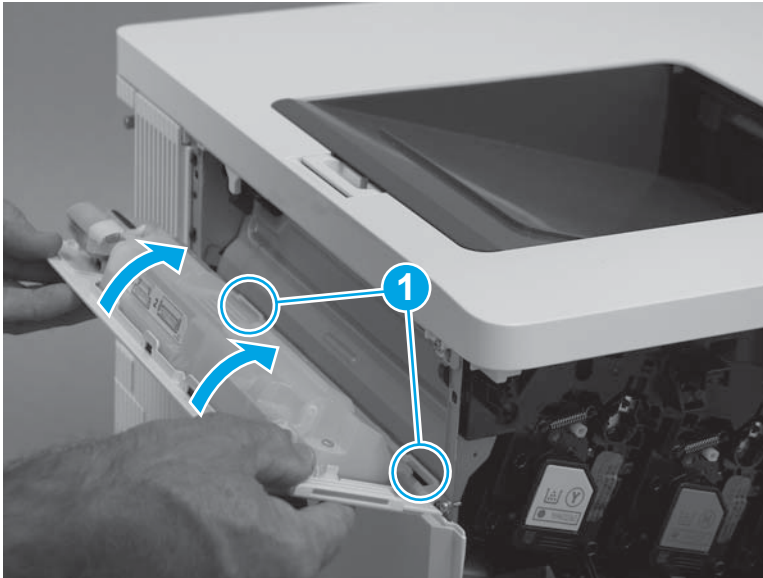

Removal and replacement: Power-supply fan (FM1)

- [Introduction](#)
- [Step 1: Remove the USB cover](#)
- [Step 2: Remove the control panel \(M553x only\)](#)
- [Step 3: Remove the toner collection unit \(TCU\)](#)
- [Step 4: Remove the formatter cover](#)
- [Step 5: Remove the rear cover \(M552 and M553\)](#)
- [Step 6: Remove the rear upper cover \(M577\)](#)
- [Step 7: Remove the rear cover \(M577\)](#)
- [Step 8: Remove the left cover](#)
- [Step 9: Remove the upper cover \(M552 and M553\)](#)
- [Step 10: Remove the right front upper cover \(M577dn\)](#)
- [Step 11: Remove the stapler cover assembly \(M577f and M577z\)](#)
- [Step 12: Remove the right upper cover \(M577\)](#)
- [Step 13: Remove the right rear cover](#)
- [Step 14: Remove the formatter \(M552 and M553\)](#)
- [Step 15: Remove the hard-disk drive \(HDD\) \(M577\)](#)
- [Step 16: Remove the fax PCA \(M577c/f/z\)](#)
- [Step 17: Remove the formatter \(M577\)](#)
- [Step 18: Remove the formatter case](#)
- [Step 19: Remove the low-voltage power supply \(LVPS\)](#)
- [Step 20: Remove the power supply fan \(FM1\)](#)
- [Step 21: Unpack the replacement assembly](#)
- [Step 22: Install the power-supply fan \(FM1\)](#)
- [Step 23: Install the LVPS](#)
- [Step 24: Install the formatter case](#)
- [Step 25: Install the formatter \(M577\)](#)
- [Step 26: Install the fax PCA \(M577c/f/z\)](#)
- [Step 27: Install the HDD \(M577\)](#)
- [Step 28: Install the formatter \(M552 and M553\)](#)
- [Step 29: Install the right rear cover](#)

- [Step 30: Install the right upper cover \(M577\)](#)
- [Step 31: Install the stapler cover assembly \(M577f and M577z\)](#)
- [Step 32: Install the right front upper cover \(M577dn\)](#)
- [Step 33: Install the upper cover \(M552 and M553\)](#)
- [Step 34: Install the left cover](#)
- [Step 35: Install the rear cover \(M577\)](#)
- [Step 36: Install the rear upper cover \(M577\)](#)
- [Step 37: Install the rear cover \(M552 and M553\)](#)
- [Step 38: Install the formatter cover](#)
- [Step 39: Install the TCU](#)
- [Step 40: Install the control-panel assembly \(M553x only\)](#)
- [Step 41: Install the USB cover](#)

Introduction

This document provides the procedures to remove and replace the power-supply fan (FM1).

Before performing service

Turn the printer power off

- Disconnect the power cable.

 **WARNING!** To avoid damage to the printer, turn the printer off, wait 30 seconds, and then remove the power cord before attempting to service the printer.

Use the table below to identify the correct part number for your printer, and then go to <http://h20141.www2.hp.com/hpparts> to order the part.

Power supply fan (FM1) part number

RK2-2416-000CN

Power supply fan (FM1)

Required tools

- #2 Phillips screwdriver with a magnetic tip

After performing service

Make sure that all of the connectors on the LVPS are fully seated.

Make sure that all of the connectors on the formatter are fully seated.

Make sure that the formatter cover is fully seated, and that the thumbscrews are finger tight after replacing it.

Turn the printer power on

- Connect the power cable.
- Use the power switch to turn the power on.

Step 1: Remove the USB cover

 **NOTE:** This step is for the M552 and M553 models. For the M577 models, skip this step and to go [Step 4: Remove the formatter cover on page 1045](#).

1. Locate the USB cover.

Figure 1-1811 Locate the USB cover

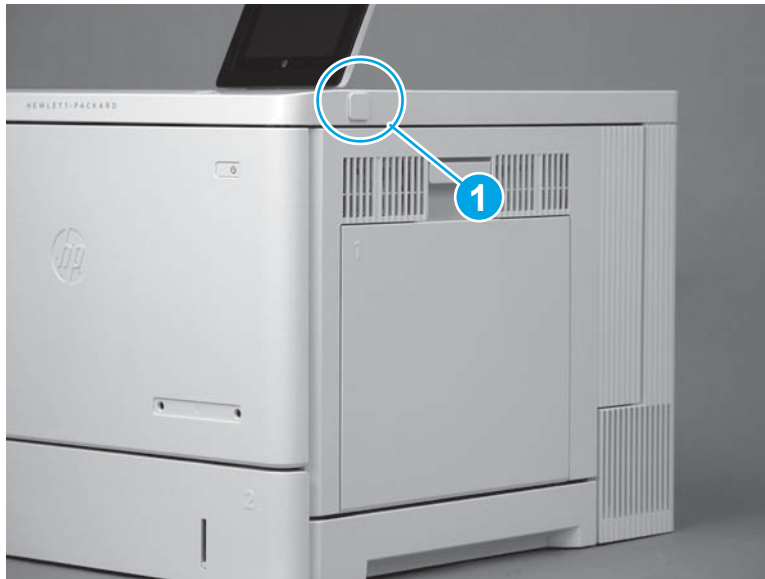

2. Pull the cover off of the printer to remove it.

Figure 1-1812 Remove the cover



Step 2: Remove the control panel (M553x only)

 **NOTE:** This step is for the M553x model. For the M553n/dn and M552dn models, skip this step and go to [Step 3: Remove the toner collection unit \(TCU\) on page 1043](#).

For the M577 models, skip this step and to go [Step 4: Remove the formatter cover on page 1045](#).

1. Tilt the control panel up.

Figure 1-1813 Tilt the control panel up



2. Use a small flat-blade screwdriver to release the control-panel screws cover tabs.

Figure 1-1814 Release the control-panel screws cover tabs



3. Rotate the cover up to remove it.

Figure 1-1815 Remove the cover



4. Use a small Phillips screwdriver to remove two screws (callout 1).

 **IMPORTANT:** Store the screws in a secure place where they cannot fall down into the printer.

Figure 1-1816 Remove two screws

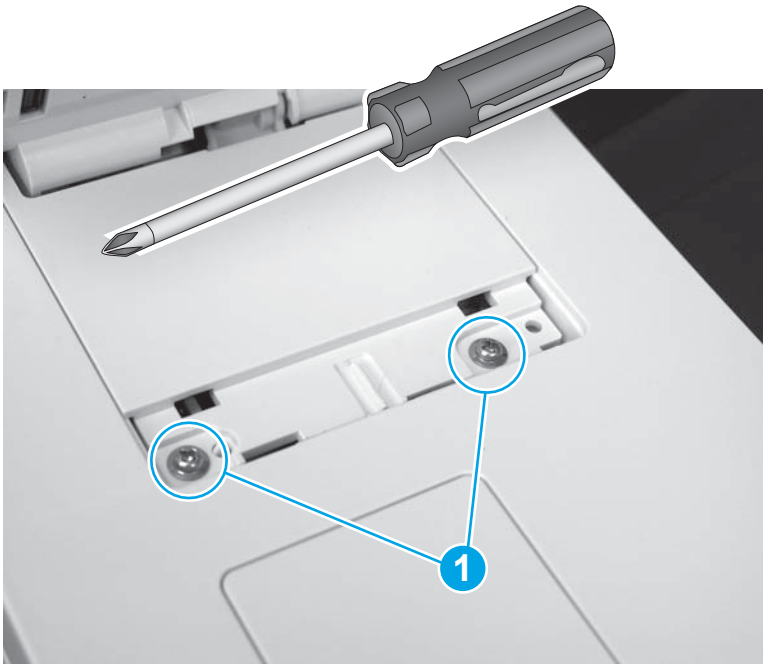

5. Rotate the control-panel base toward the front of the printer.

Figure 1-1817 Rotate the control-panel base up



6. Slightly slide the control-panel base toward the rear of the printer (callout 1) to release it, and then turn the control panel over (callout 2) to access the bottom side.

CAUTION: The control panel is still attached to the printer. Do not attempt to completely remove the control panel.

Figure 1-1818 Turn the control panel over

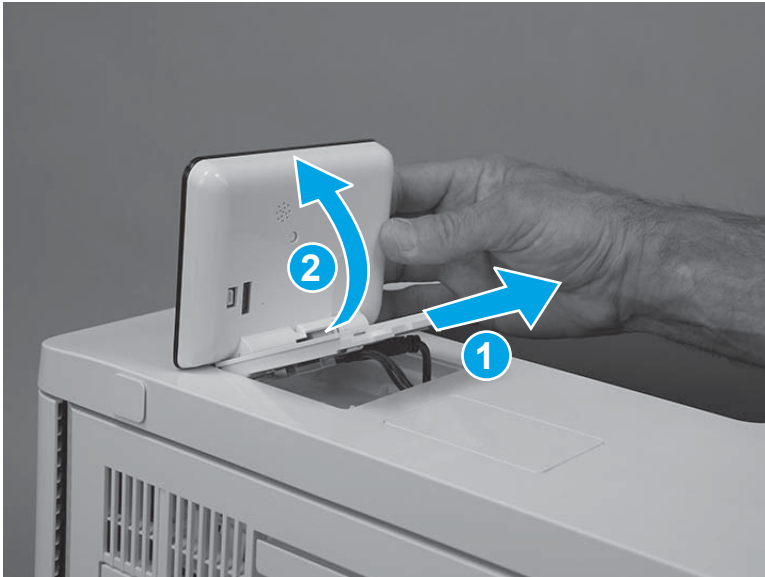

7. Disconnect one USB cable (callout 1), one connector (callout 2), and then remove the control panel.

Figure 1-1819 Disconnect two connectors

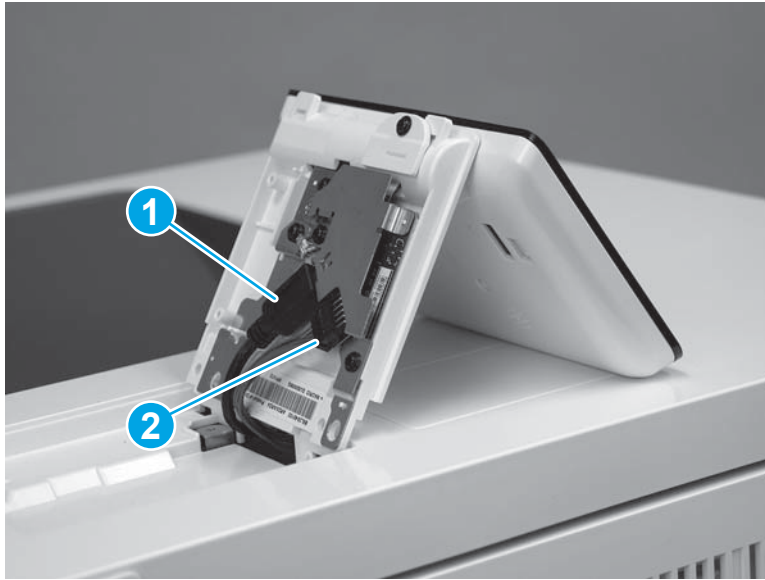

Step 3: Remove the toner collection unit (TCU)



NOTE: This step is for the M552 and M553 models. For the M577 models, skip this step and go to [Step 4: Remove the formatter cover on page 1045](#).

1. Open the front door.

Figure 1-1820 Open the front door



2. Open the TCU.

 **NOTE:** The toner collection hatch cover automatically closes when the TCU is opened.

Figure 1-1821 Open the TCU



3. Pull the TCU away from the printer at an angle to remove it.

⚠ CAUTION: Do not open the toner collection hatch cover when handling the TCU. If toner gets on clothing, wipe it off by using a dry cloth and wash the clothes in cold water. Hot water sets toner into fabric.

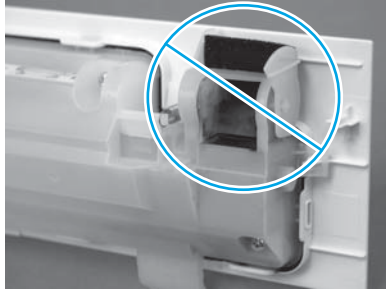
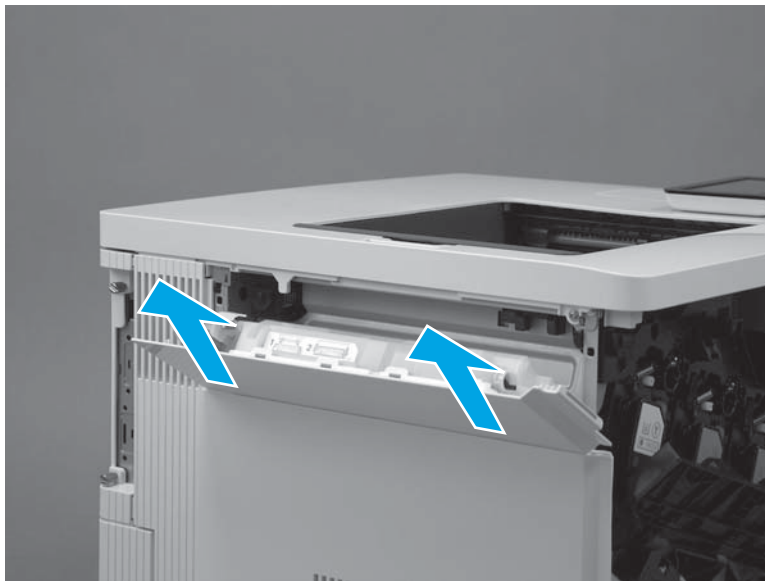

Figure 1-1822 Remove the TCU



Step 4: Remove the formatter cover

1. Locate the formatter cover.

Figure 1-1823 Locate the formatter cover

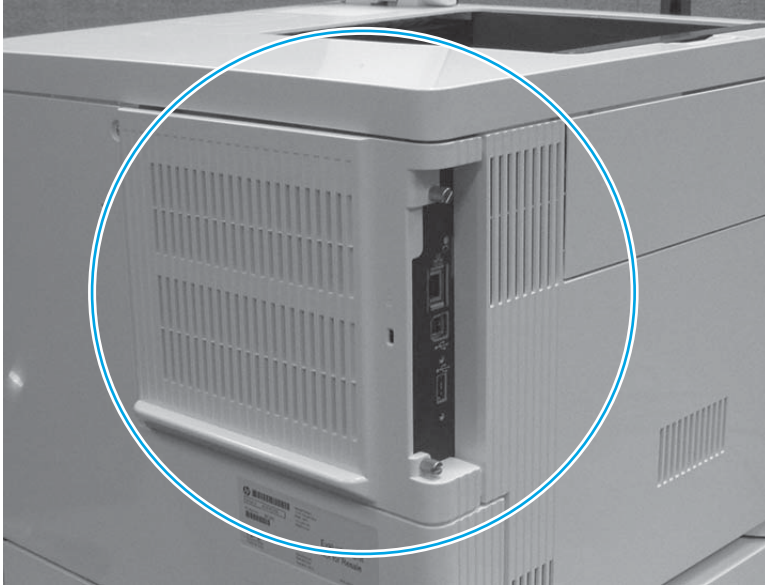

2. Loosen the two thumbscrews (callout 1). Grasp the two thumbscrews, and then slide the cover away from the printer (callout 2) to remove it.



 **TIP:** If needed, use the edge of a coin to turn the thumbscrews.

Figure 1-1824 Loosen the thumbscrews

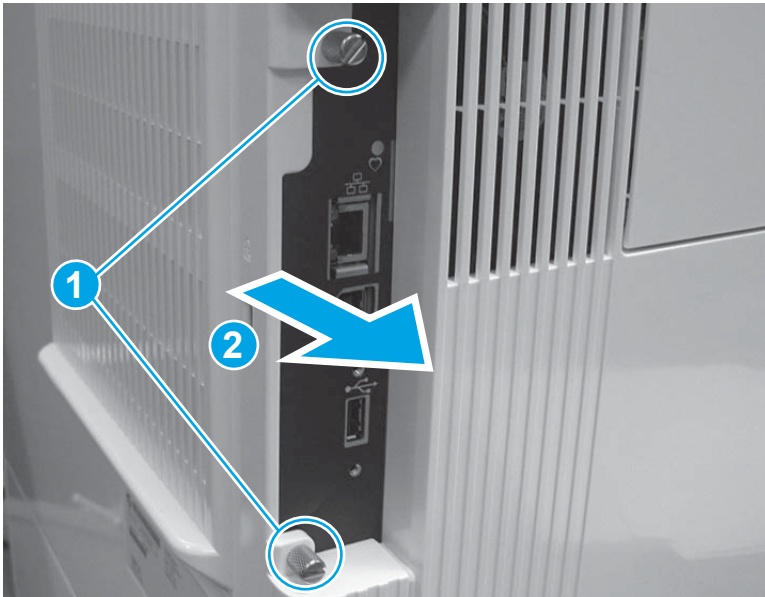

Step 5: Remove the rear cover (M552 and M553)

 **NOTE:** This step is for the M552 and M553 models. For the M577 models, skip this step and to go [Step 6: Remove the rear upper cover \(M577\) on page 1047.](#)

1. Remove four screws (callout 1).

Figure 1-1825 Remove four screws

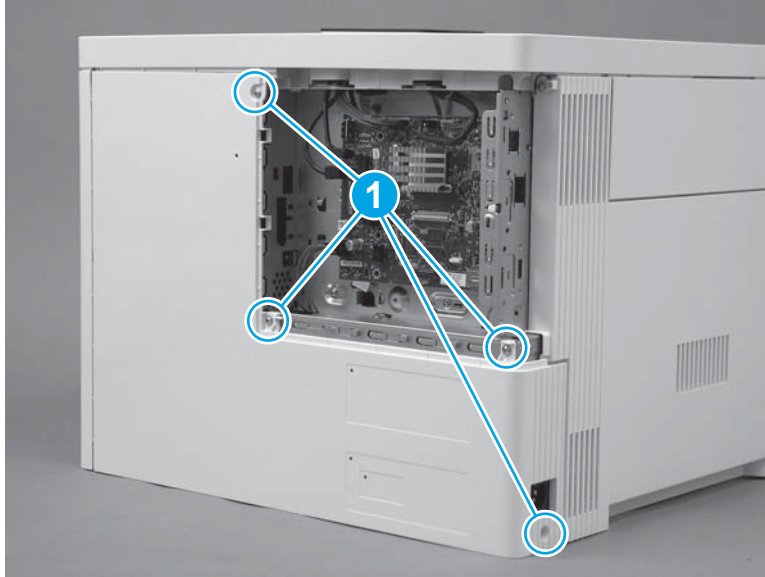

2. Slightly slide the cover to the right (callout 1), rotate the bottom of the cover away from the printer (callout 2), and then pull the top of the cover away from the printer (callout 3) to remove the cover.

Figure 1-1826 Remove the cover

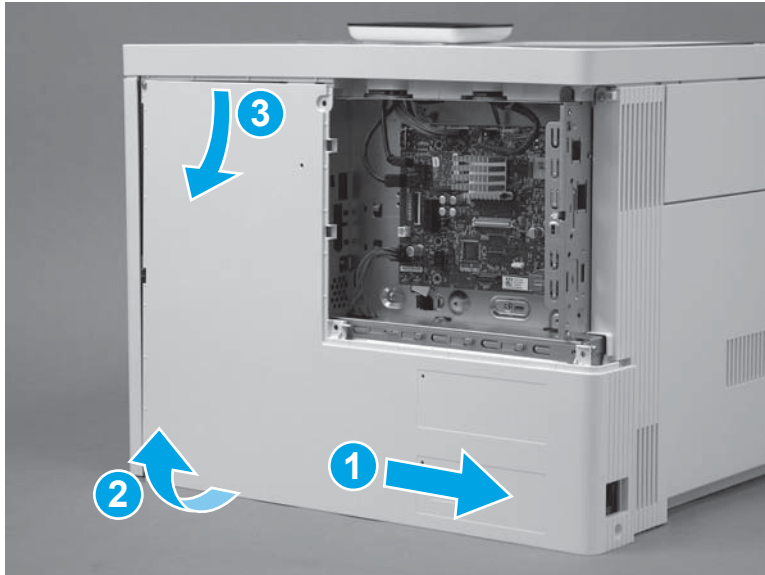

Step 6: Remove the rear upper cover (M577)



NOTE: This step is for the M577 models. For the M552 and M553 models, skip this step and go to [Step 8: Remove the left cover on page 1050](#).

1. Remove two screws (callout 1).



Reinstallation tip: These two screws are self-tapping screws for plastic. When reinstalling them, rotate the screws counterclockwise to align them with the existing thread pattern, and then carefully turn them clockwise to tighten. Do not overtighten. This will prevent stripping the threads inside the screw holes.

Figure 1-1827 Remove two screws

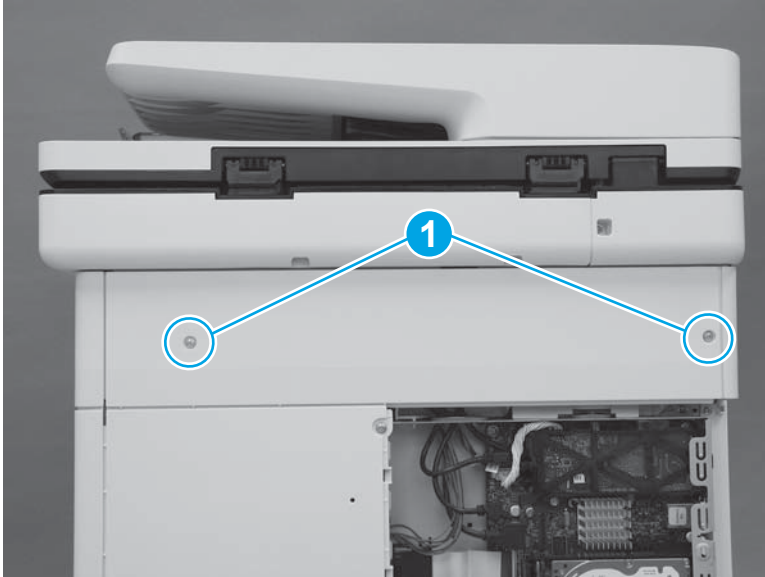

2. Use a small, flat blade screwdriver to release the right edge of the cover.

Figure 1-1828 Release the right edge

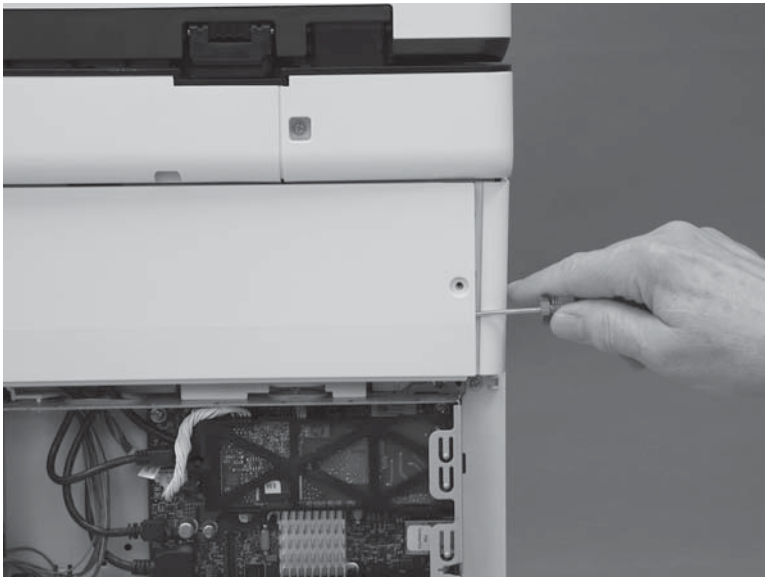

3. Pull the right edge of the cover (callout 1) away from the printer, and then slide the cover to the right (callout 2).

Figure 1-1829 Slide the cover right

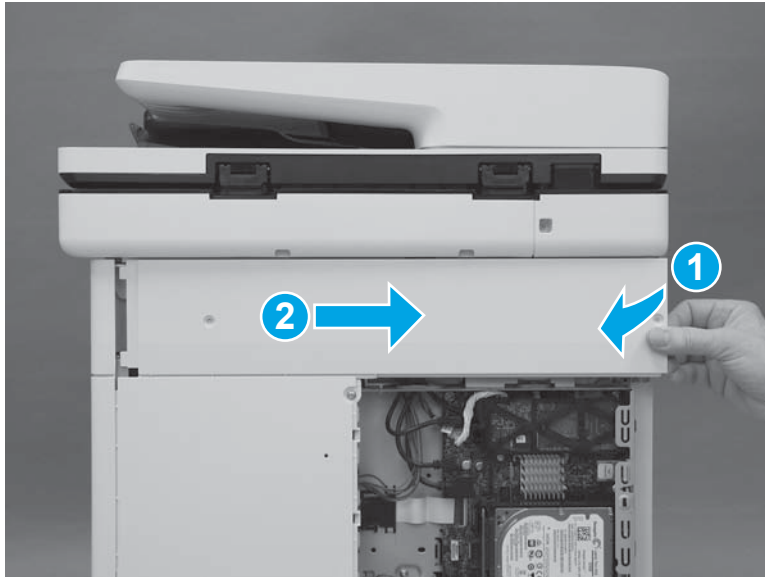

4. Remove the cover.

Figure 1-1830 Remove the cover

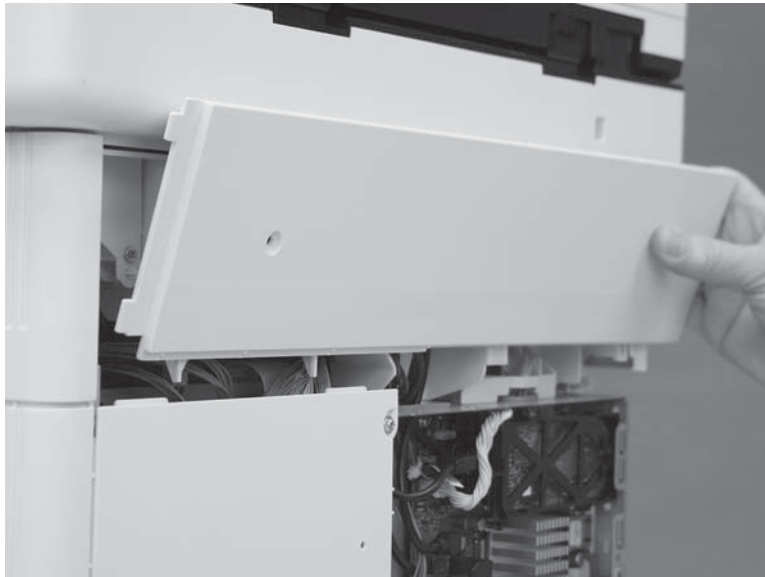

Step 7: Remove the rear cover (M577)

 **NOTE:** This step is for the M577 models. For the M552 and M553 models, skip this step and go to [Step 8: Remove the left cover on page 1050.](#)

1. Remove four screws (callout 1).

Figure 1-1831 Remove four screws

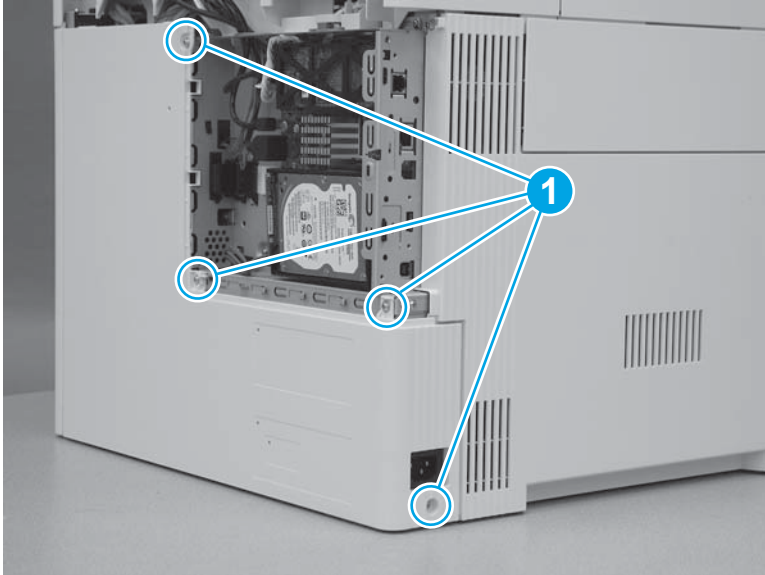

2. Slide the cover to the right to remove it.

Figure 1-1832 Remove the cover

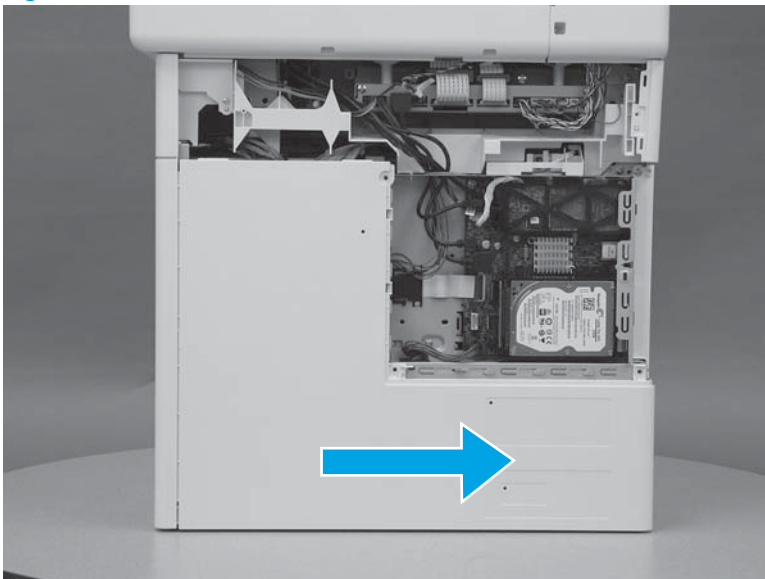

Step 8: Remove the left cover

1. At the left side of the printer, remove one screw (callout 1).

Figure 1-1833 Remove one screw



2. Release one tab (callout 1), rotate the front edge of the cover away from the printer (callout 2), and then slide the cover (callout 3) toward the rear of the printer to release it.

Figure 1-1834 Release the cover

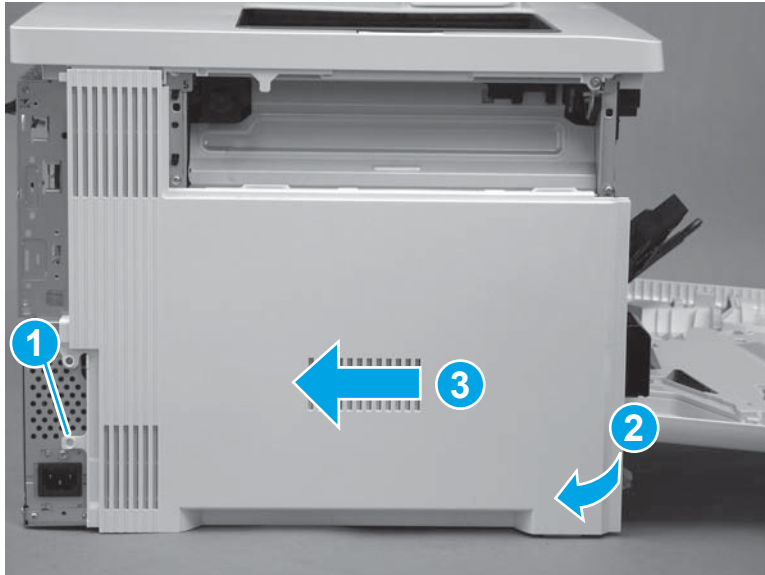

3. Remove the cover.

Figure 1-1835 Remove the cover

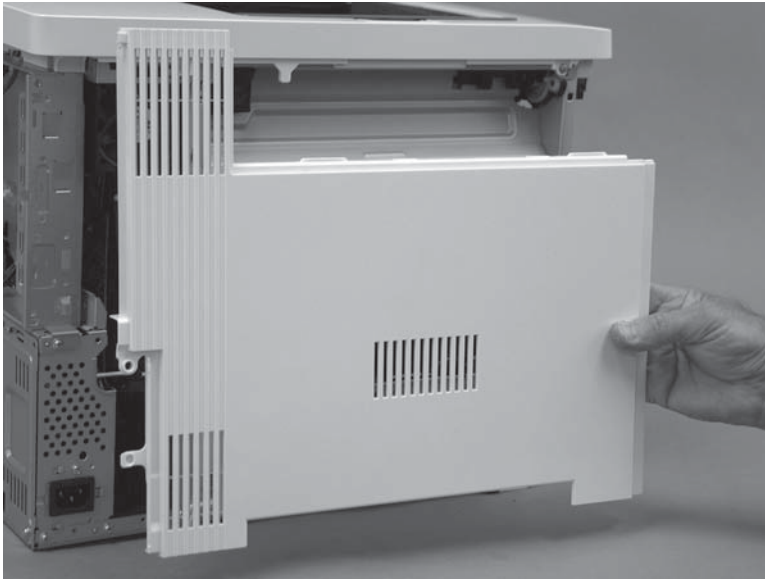

Step 9: Remove the upper cover (M552 and M553)



NOTE: This step is for the M552 and M553 models. For the M577 models, skip this step and go to [Step 10: Remove the right front upper cover \(M577dn\) on page 1054](#)

1. Remove three screws (callout 1).

Figure 1-1836 Remove three screws

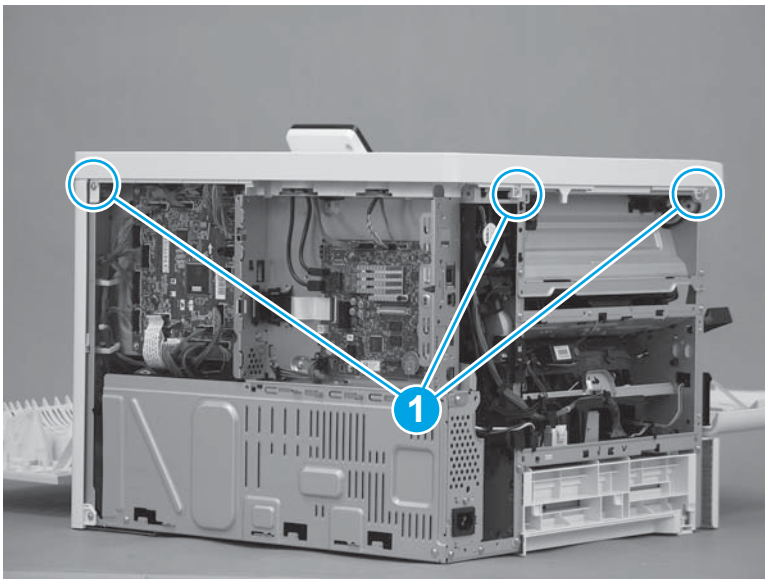

2. Remove one screw (callout 1), release one tab (callout 2), and then slightly separate the corner of the cover from the chassis.

 **NOTE:** This is a self-tapping plastic-thread screw. Make sure that this screw is used in this location when it is reinstalled.

Figure 1-1837 Remove one screw and release one tab



3. Release one tab (callout 1), and then lift up on the cover to release it.

 **NOTE:** If the cover does not release, check for additional tabs by locating the triangles embossed in the cover at tab locations.

Figure 1-1838 Release the cover



4. Remove the cover.

Figure 1-1839 Remove the cover

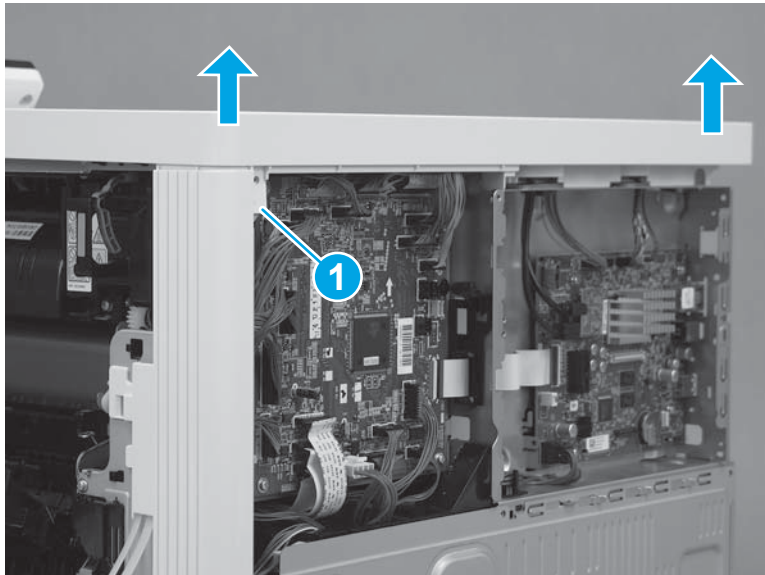
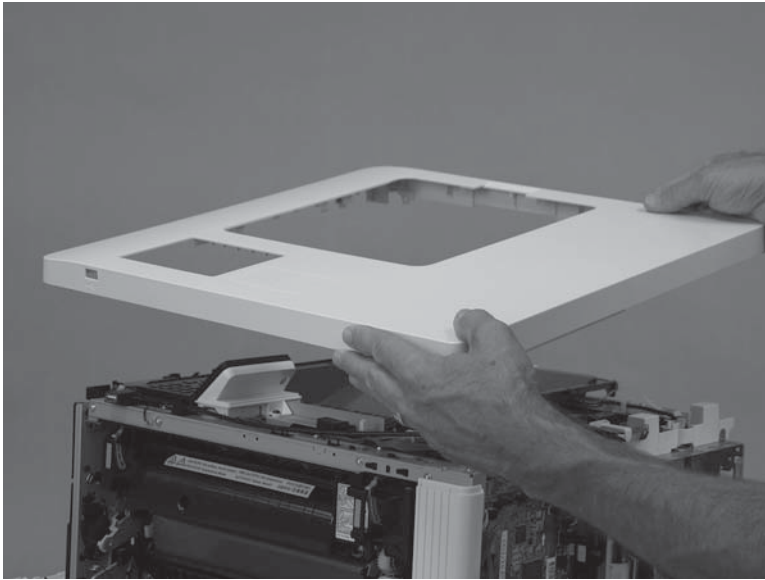

Step 10: Remove the right front upper cover (M577dn)



NOTE: This step is for the M577dn model. For the M577f and M577z models, skip this step and to go [Step 11: Remove the stapler cover assembly \(M577f and M577z\) on page 1055](#).

For the M552 and M553 models, skip this step and go to [Step 13: Remove the right rear cover on page 1059](#).

1. Remove one screw (callout 1).

Figure 1-1840 Remove one screw

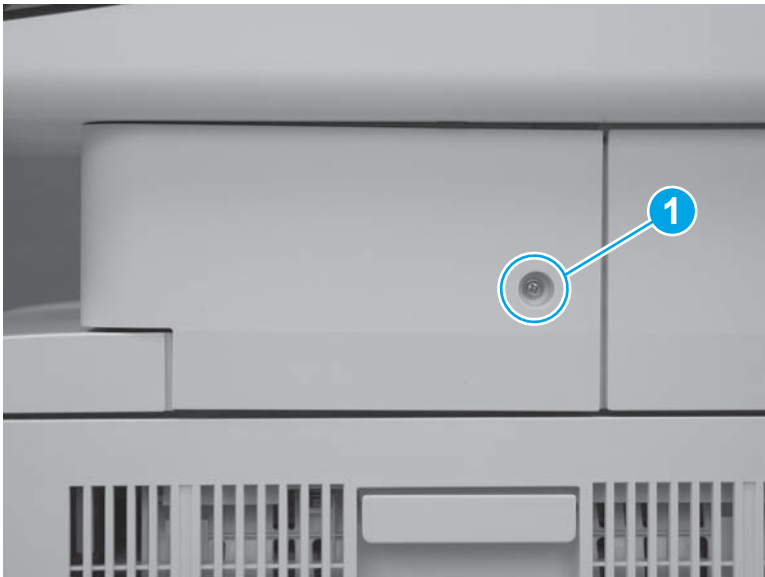

2. Release two tabs at the front edge of the cover (callout 1).

Figure 1-1841 Release two tabs



3. Rotate the front of the cover to the right to remove it.

Figure 1-1842 Rotate the cover



Step 11: Remove the stapler cover assembly (M577f and M577z)

 **NOTE:** This step is for the M577f and M577z models. For the M577dn model, skip this step and go to [Step 12: Remove the right upper cover \(M577\) on page 1057](#).

For the M552 and M553 models, skip this step and go to [Step 13: Remove the right rear cover on page 1059](#).

1. Remove one screw (callout 1).

 **Reinstallation tip:** This is a self-tapping screw for plastic. When reinstalling, rotate the screw counterclockwise to align it with the existing thread pattern, and then carefully turn it clockwise to tighten. Do not overtighten. This will prevent stripping the threads inside the screw hole.

Figure 1-1843 Remove one screw



2. Release two tabs at the front edge of the cover (callout 1).

Figure 1-1844 Release two tabs

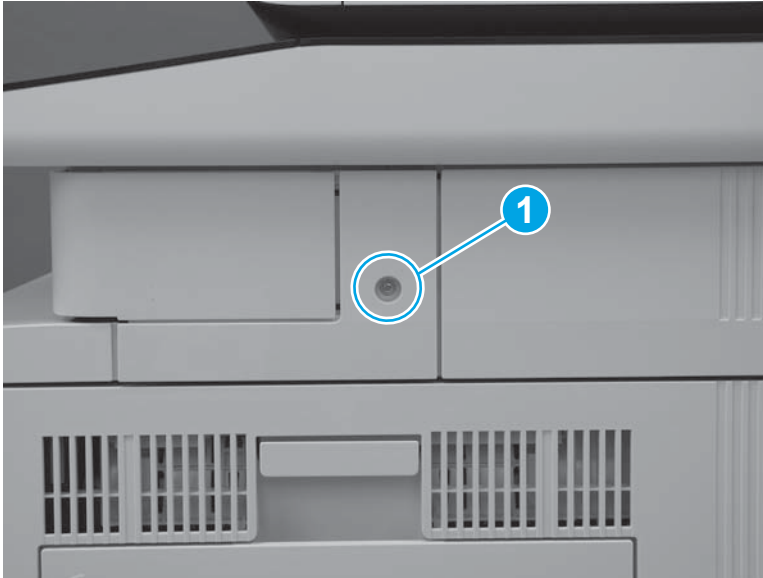

3. Release the back edge of the cover.

Figure 1-1845 Release the back edge of the cover

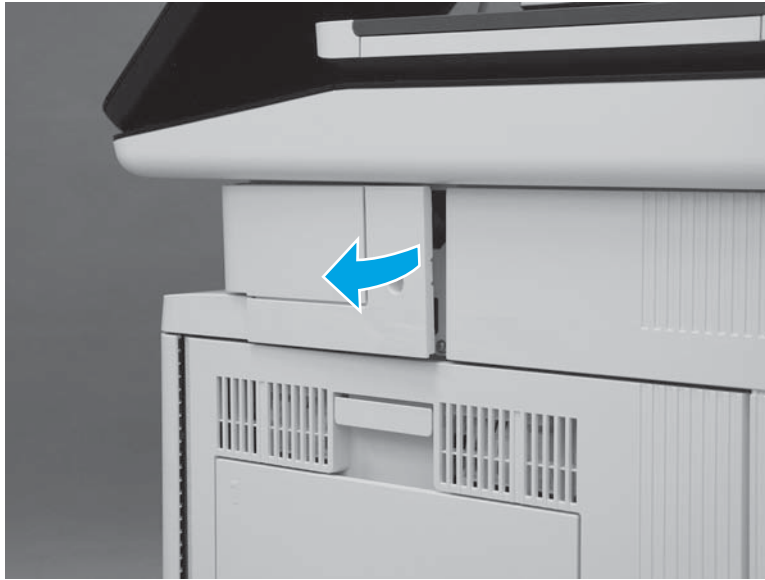

4. Rotate the cover away from the printer to remove it.

Figure 1-1846 Remove the cover



Step 12: Remove the right upper cover (M577)

 **NOTE:** This step is for the M577 models. For the M552 and M553 models, skip this step and go to [Step 13: Remove the right rear cover on page 1059.](#)



NOTE: The figures below show the image scanner installed. The procedures for removing and installing the right upper cover are the same whether the image scanner is installed or removed."

1. At the right side of the printer, remove two screws (callout 1).

M577c/f/z only: Disconnect one connector (callout 2), if it was not already disconnected in a previous step.

Figure 1-1847 Remove two screws and one connector

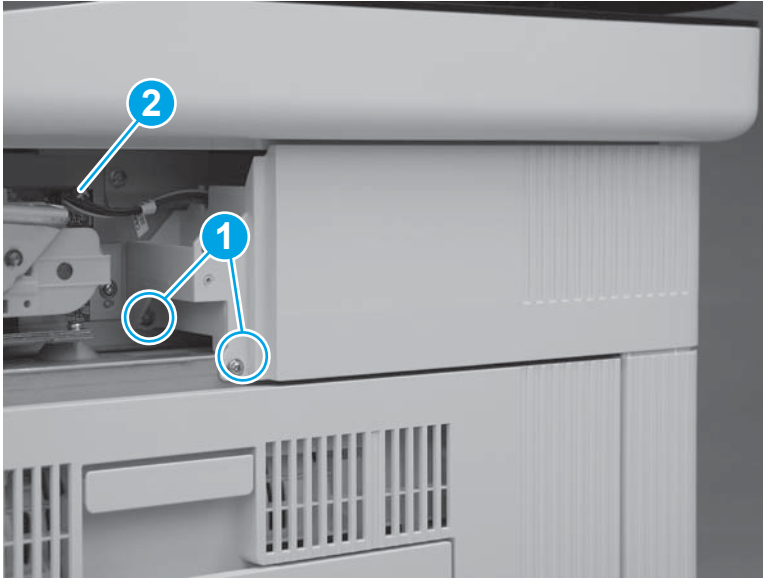

2. At the back of the printer, remove one screw (callout 1).

M577c/f/z only: Disconnect one connector (callout 2), if it was not already disconnected in a previous step.



Reinstallation tip: This screw is smaller than the screws removed in the previous step. When reinstalling the right upper cover, make sure that this screw is installed in the correct position.

Figure 1-1848 Remove one screw and connector

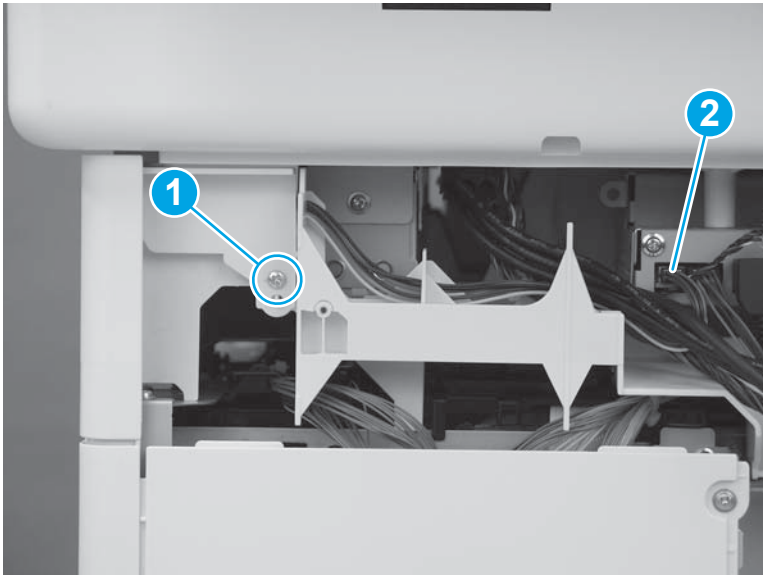

3. Slide the cover toward the back of the printer.

Figure 1-1849 Slide the cover

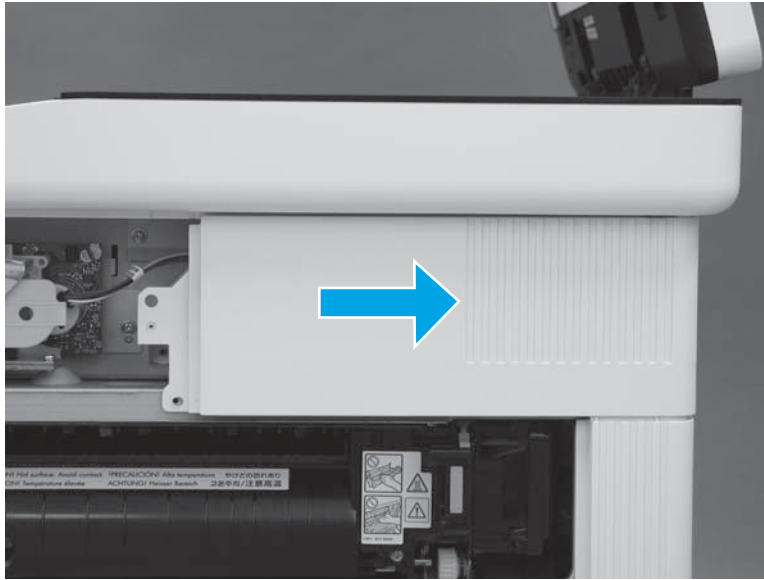

4. Lift the cover away from the printer to remove it.

M577c/f/z only: Release the cables (callout 1) through the slot (callout 2) in the printer.

Figure 1-1850 Remove the cover

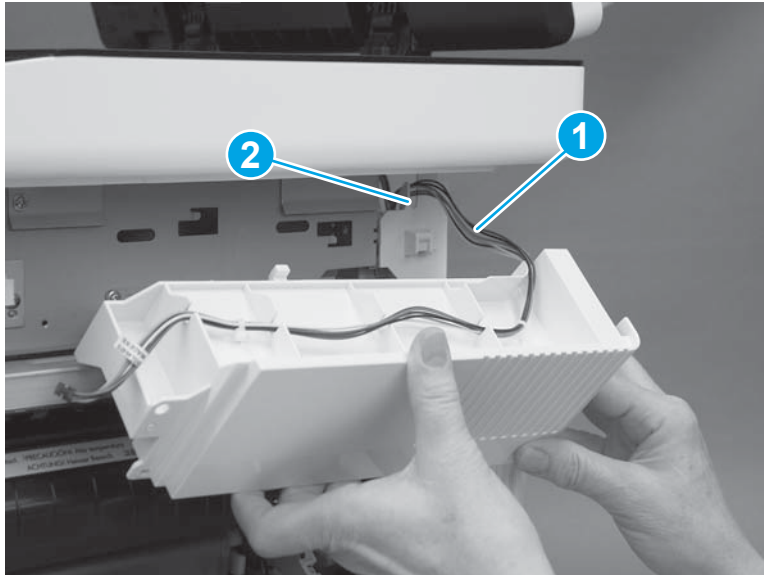

Step 13: Remove the right rear cover

1. Remove one screw (callout 1), and then slide the cover toward the rear of the printer (callout 2) to release it.

 **TIP:** If the right door is closed, open it now.

Figure 1-1851 Release the cover



2. Remove the cover.

Figure 1-1852 Remove the cover

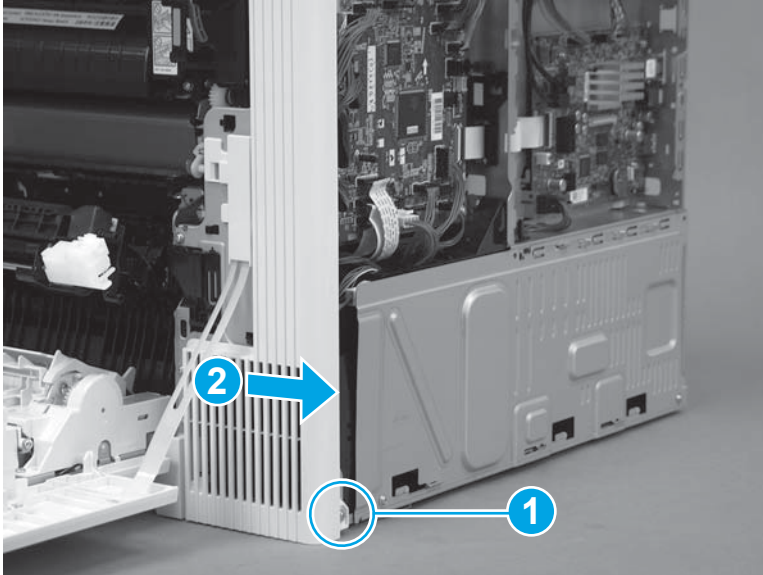
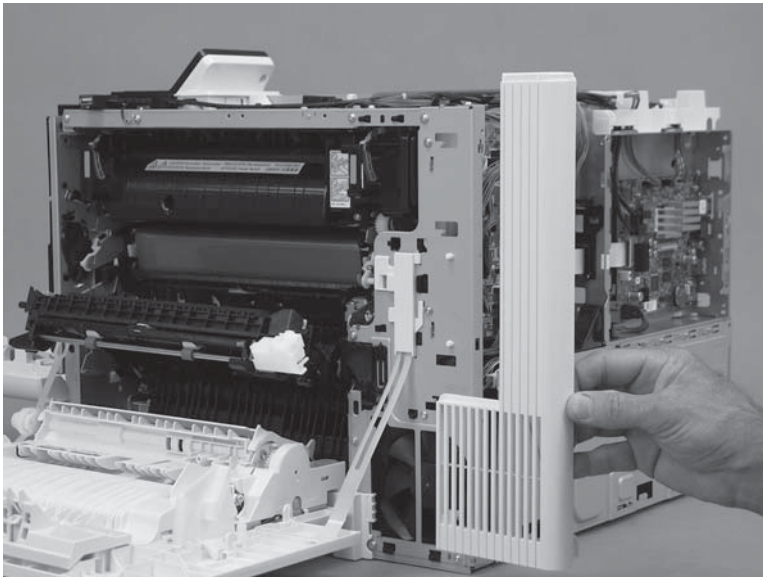

Step 14: Remove the formatter (M552 and M553)



NOTE: This step is for the M552 and M553 models. For the M577 models, skip this step and go to [Step 17: Remove the formatter \(M577\) on page 1065](#)

If the optional hard-disk drive (HDD) is installed, it must be removed to gain access to the formatter mounting screws.

Release two tabs along the left edge of the HDD, rotate the left edge away from the product, and then slide the HDD to the left to remove it.

CAUTION:  ESD-sensitive part.

1. Disconnect all of the connectors on the formatter.

The following connectors are empty:

- All models: J1 (this connector is empty unless the optional DIMM is installed)
- M553n/dn and M552dn: J2 (callout 1; this is the touchscreen connector for the M553x model)
- All models: J9 (this connector is empty unless the optional internal USB ports component is installed)
- All models: J18 (this connector is empty unless the optional hard-disk-drive (HDD) is installed)
- All models: J23
- All models: J24
- M553n/dn and M552dn: J25 (this is the wireless connector for the M553x model)
- All models: J57
- All models: J98 (this connector is empty unless the optional trusted platform module (TPM) is installed)

 **IMPORTANT:** The flat-cable connector (callout 2) is a Zero Insertion Force (ZIF) connector that uses a hinged retainer to secure the flat cable. The hinged retainer must be opened to release the flat cable.

Figure 1-1853 Disconnect all connectors



2. Remove four screws (callout 1), and then remove the formatter.

Figure 1-1854 Remove the formatter

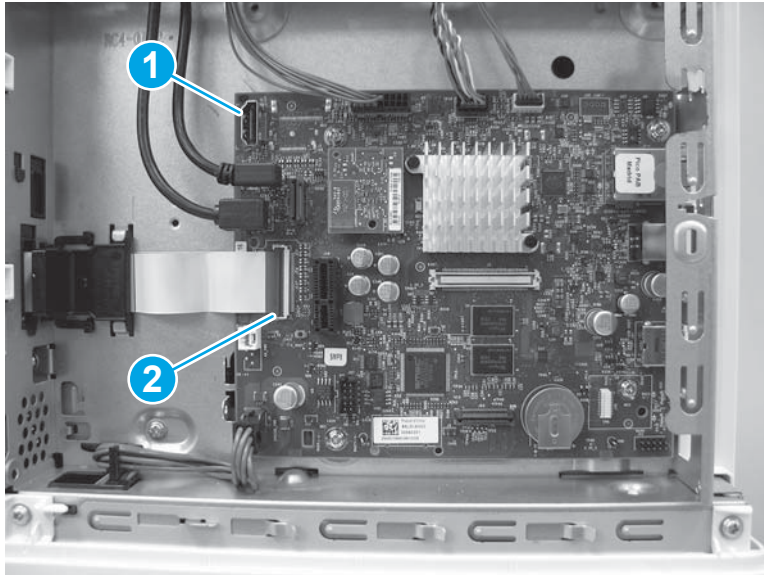
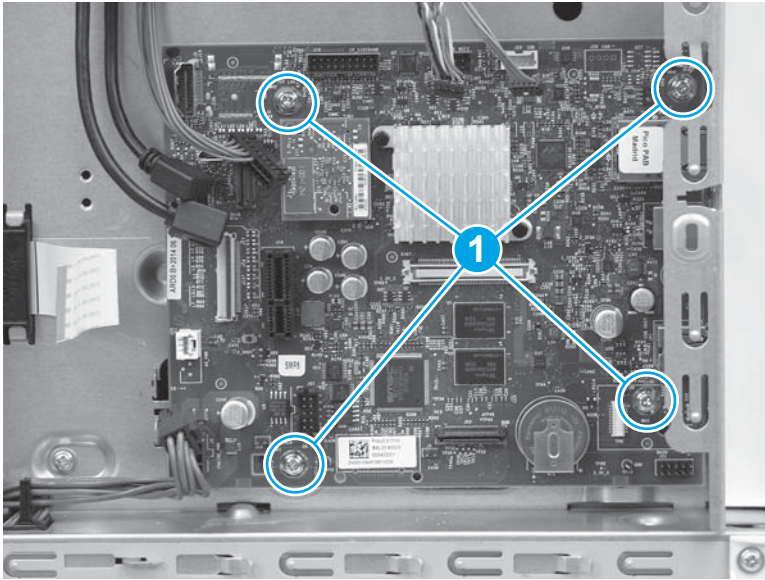

Step 15: Remove the hard-disk drive (HDD) (M577)



NOTE: This step is for the M577 models. For the M552 and M553 models, skip this step and go to [Step 18: Remove the formatter case on page 1067](#).



CAUTION:  ESD-sensitive part.

1. Release two tabs (callout 1). Hold the tabs in the released position, and then rotate the hard disk drive (HDD) up (callout 2) to release the connector from the formatter.

Figure 1-1855 Release the HDD

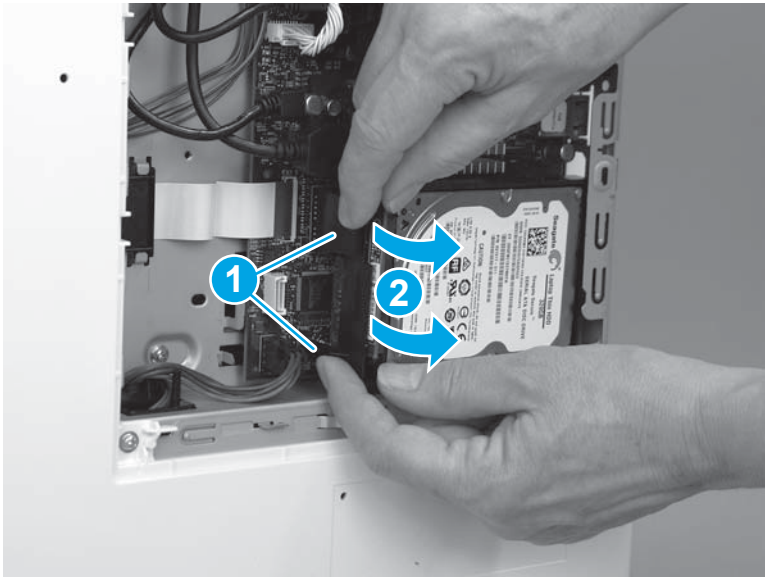

2. Slide the HDD away from the printer to remove it.

Figure 1-1856 Remove the HDD

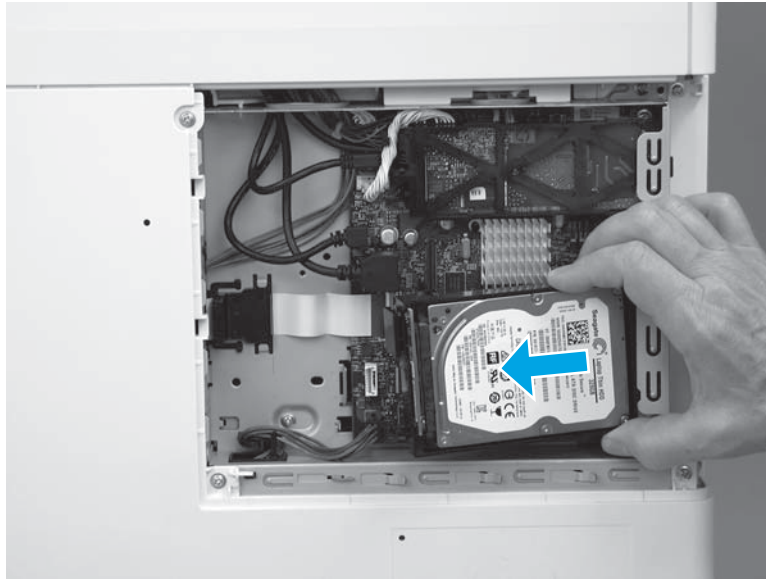

Step 16: Remove the fax PCA (M577c/f/z)

 **NOTE:** This step is for the M577c/f/z models. For the M577n model, skip this step and go to [Step 17: Remove the formatter \(M577\) on page 1065](#).

For the M552 and M553 models, skip this step and go to [Step 18: Remove the formatter case on page 1067](#).

 **CAUTION:**  ESD-sensitive part.

1. Locate the fax PCA component on the formatter.

Figure 1-1857 Locate the fax PCA

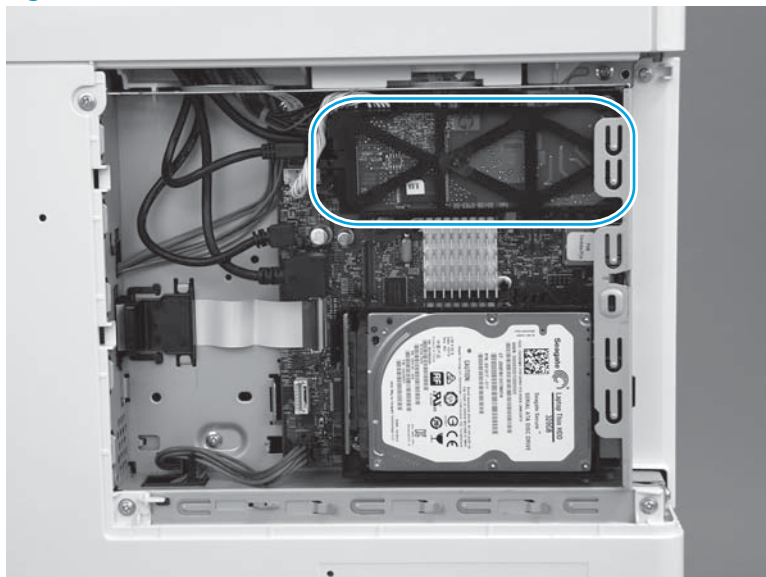

2. Release the connector latch (callout 1), and then pull the connector away from the formatter (callout 2) to disconnect it.

Figure 1-1858 Disconnect one connector

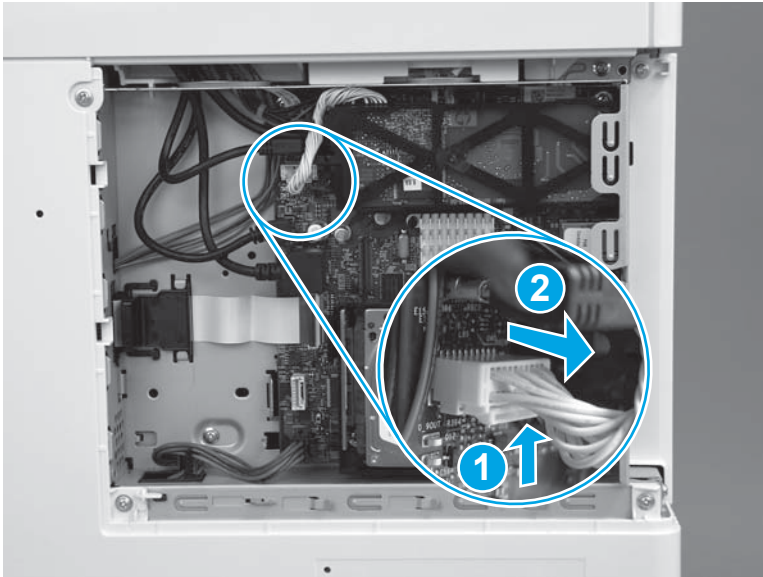

3. Release one retainer (callout 1) by pressing the bracket arms together.

Figure 1-1859 Release one latch

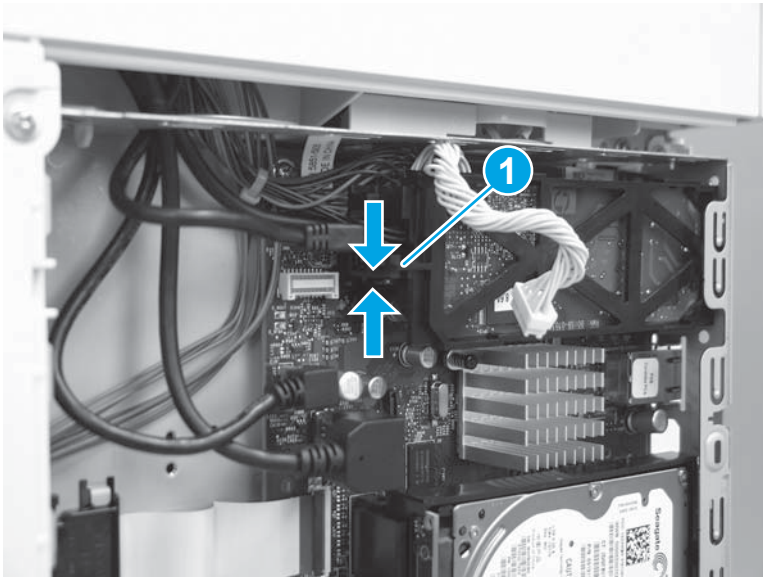

4. Rotate the end of the fax PCA (callout 1) away from the formatter, and then slide the PCA left (callout 2) to remove it.

Figure 1-1860 Remove the fax PCA

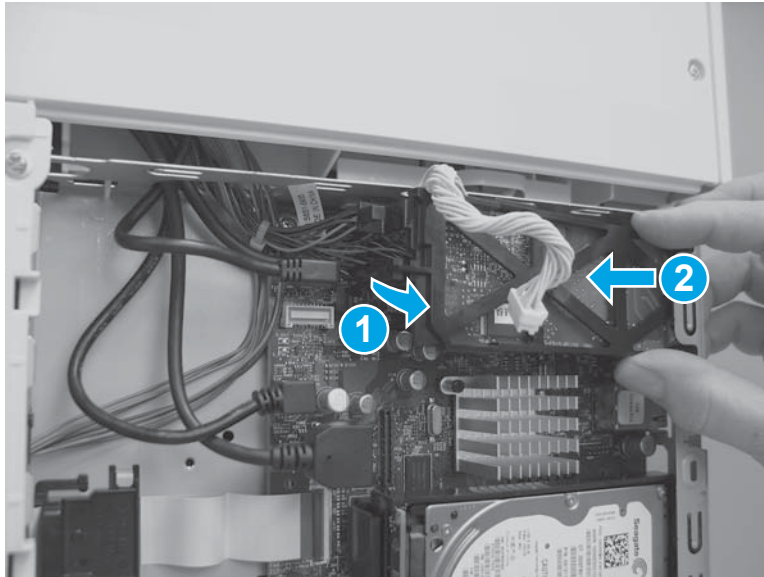

Step 17: Remove the formatter (M577)

 **NOTE:** This step is for the M577 models. For the M552 and M553 models, skip this step and go to [Step 18: Remove the formatter case on page 1067](#).

 **CAUTION:**  ESD-sensitive part.

1. Disconnect all of the connectors on the formatter.

The following connectors are empty:

- All models: J1 (this connector is empty unless the optional DIMM is installed)
- All models: J3
- M577dn: J15 (this is the fax connector for the M577f/z/c models)
- All models: J21 (this connector is empty unless the optional internal USB ports component is installed)
- All models: J23
- All models: J24
- All models: J51
- All models: J57
- All models: J97
- All models: J98 (this connector is empty unless the optional trusted platform module (TPM) is installed)

 **IMPORTANT:** The flat-cable connector (callout 1) is a Zero Insertion Force (ZIF) connector that uses a hinged retainer to secure the flat cable. The hinged retainer must be opened to release the flat cable.

Figure 1-1861 Disconnect all connectors



2. Remove four screws (callout 1).

Figure 1-1862 Remove four screws

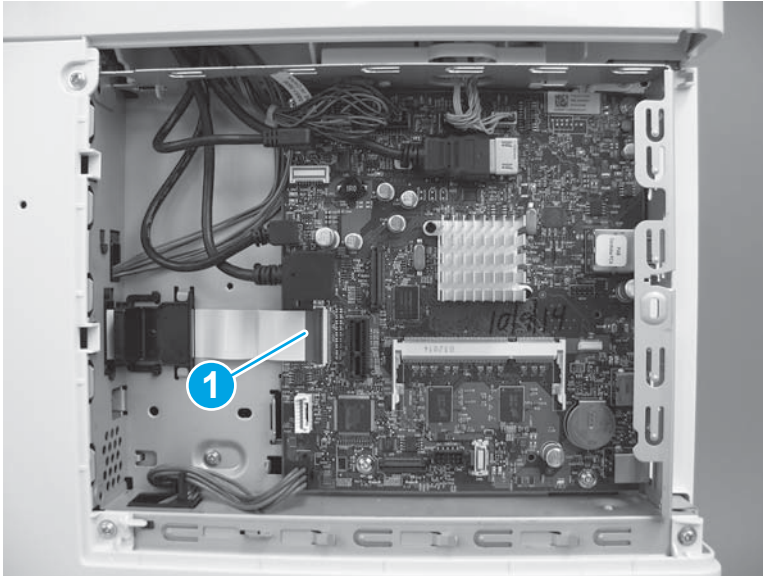
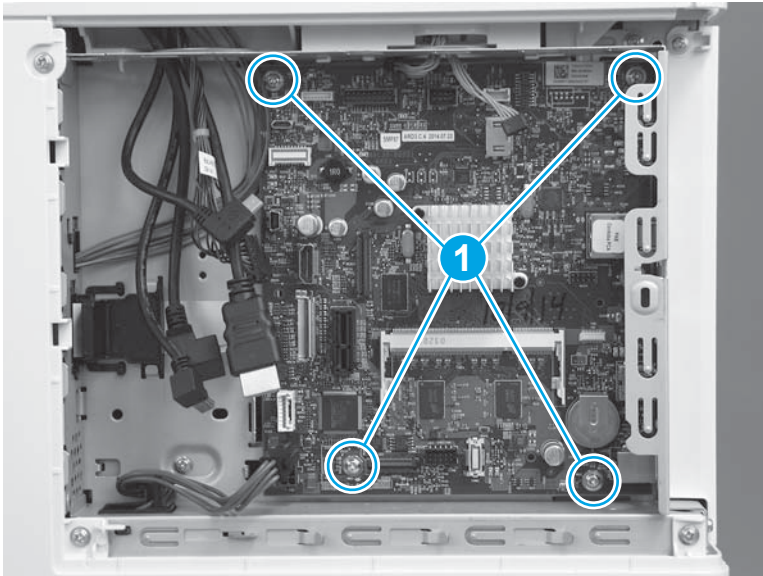

3. Remove the formatter.

Figure 1-1863 Remove the formatter

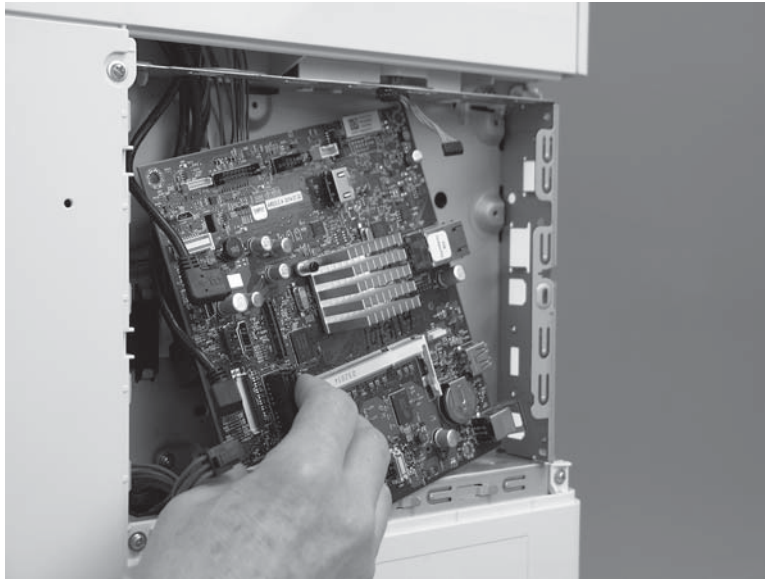

Step 18: Remove the formatter case

1. **M577 only:** Disconnect one connector (callout 1), and then pass the wire harness (callout 2) through two openings in the formatter case (callout 3).

Figure 1-1864 Disconnect one connector

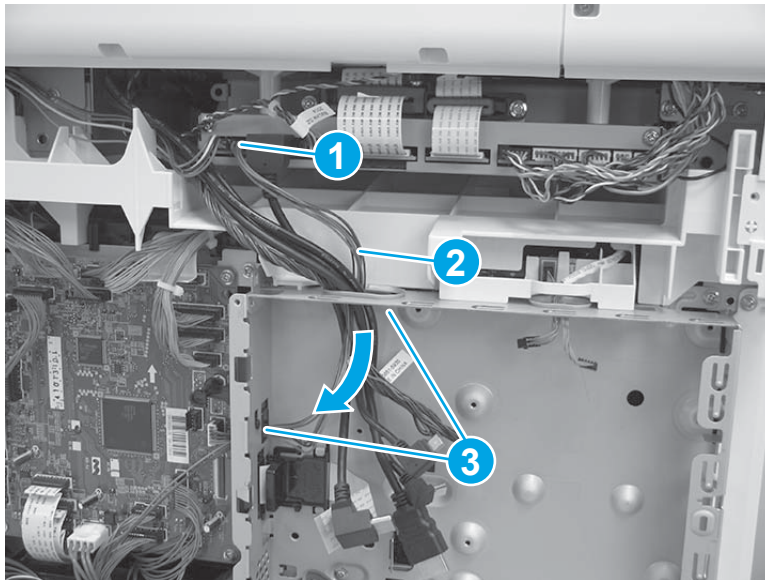

2. Release two tabs (callout 1) on the black plastic bracket. Hold the tabs in the released position, and then slide the bracket (callout 2) to the right to remove it from the formatter case.

Figure 1-1865 Remove the bracket

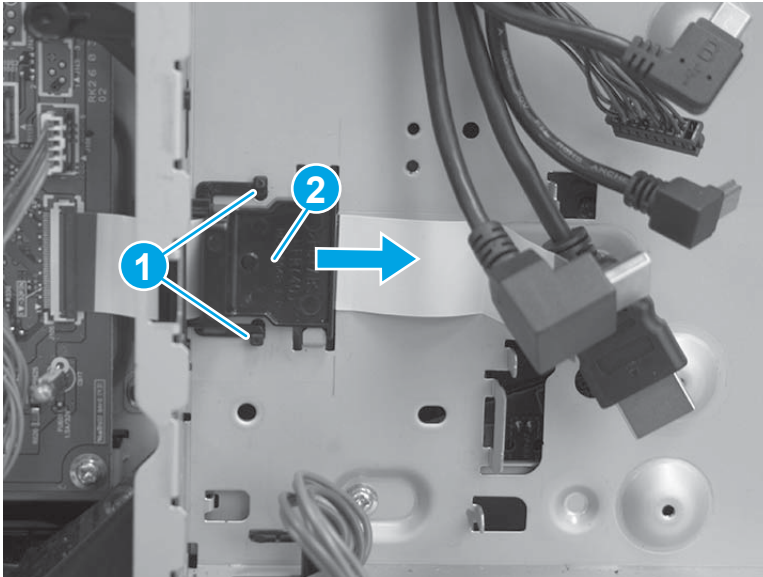

3. Remove two screws (callout 1), and then slide the low-voltage power supply (LVPS) cover to the right to remove it.

Figure 1-1866 Remove the LVPS cover

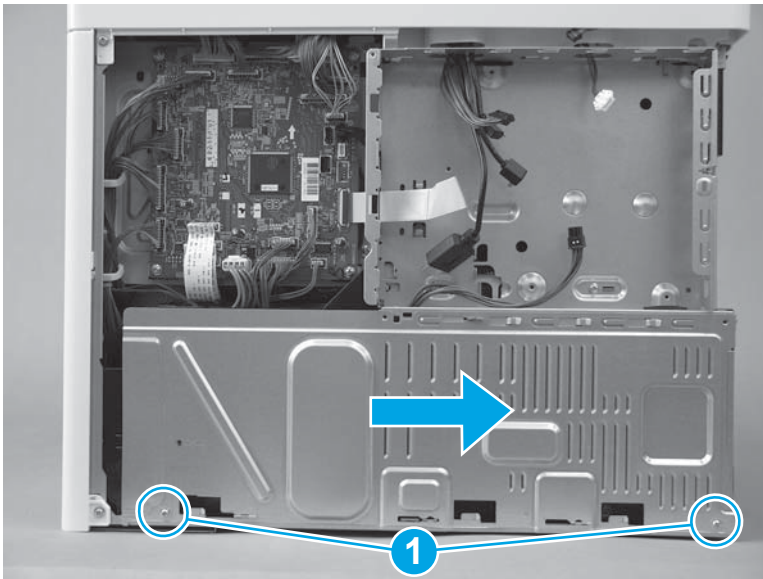

4. Pass two wire harnesses and one flat cable (callout 1) through the opening in the formatter case, and then release one wire harness from the retainer (callout 2).

CAUTION: The flat cable might be attached to the formatter case with double-sided tape. Make sure that this tape is released, so that the flat cable is not damaged when the formatter case is removed.

Figure 1-1867 Release wire harnesses and flat cable

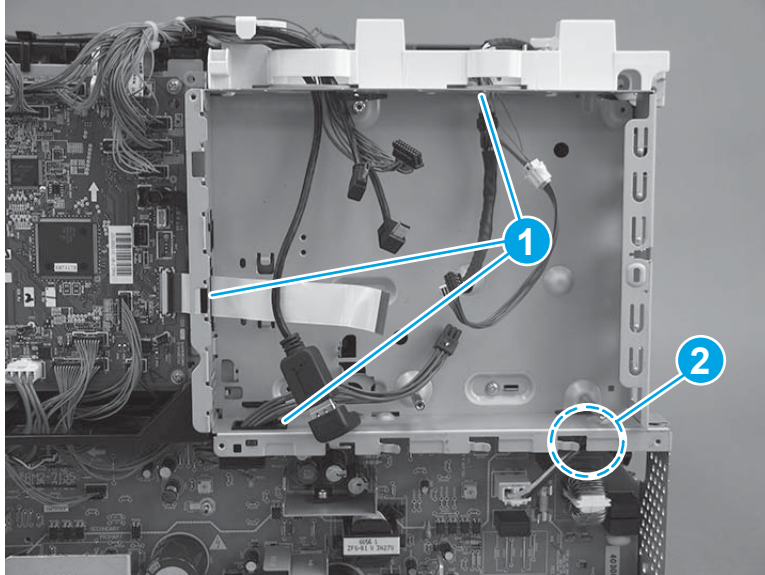

5. Remove six screws (callout 1).

Figure 1-1868 Remove six screws

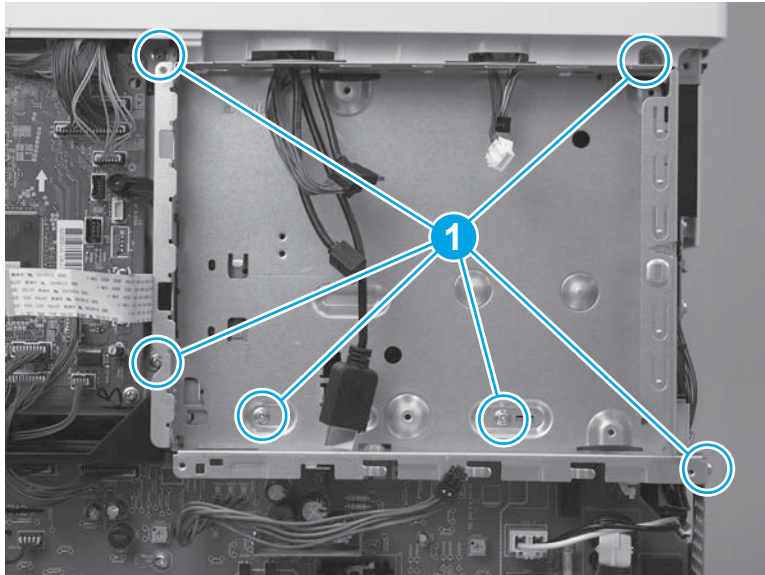

6. Rotate the bottom of the formatter case away from the printer (callout 1), and then pull it down (callout 2) to release it.

Figure 1-1869 Release the formatter case

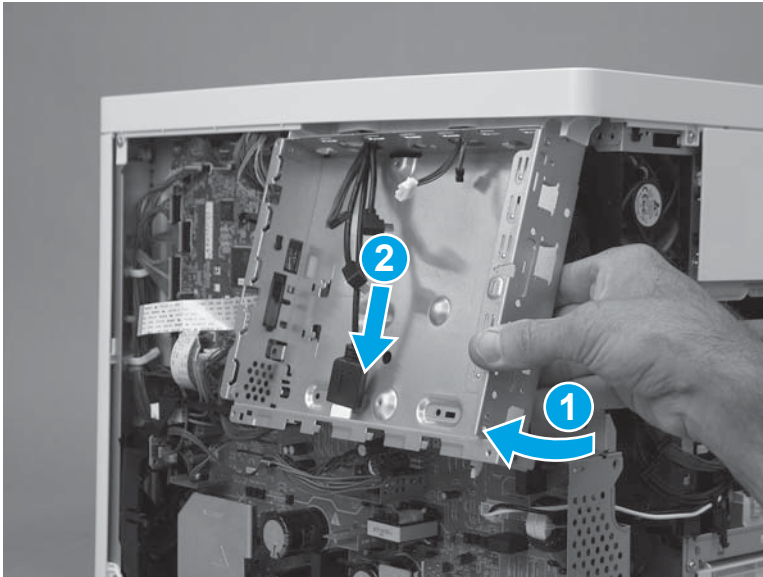

7. Pass the wire harnesses through the opening in the formatter case to remove it.

 **IMPORTANT:** If the formatter case is removed so that it can be replaced, make sure to transfer the memory PCA (island of data) and plastic bracket (callout 1) to the replacement case.

Figure 1-1870 Remove the formatter case



Step 19: Remove the low-voltage power supply (LVPS)

 **CAUTION:**  ESD-sensitive part.

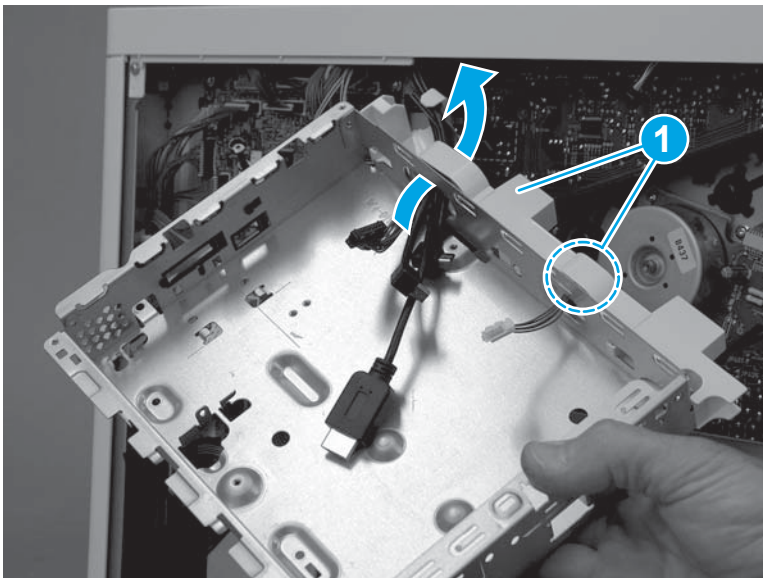
1. Disconnect one wire harness (callout 1), and then pass the wire harness through the opening (callout 2) in the chassis.

Figure 1-1871 Disconnect one wire harness

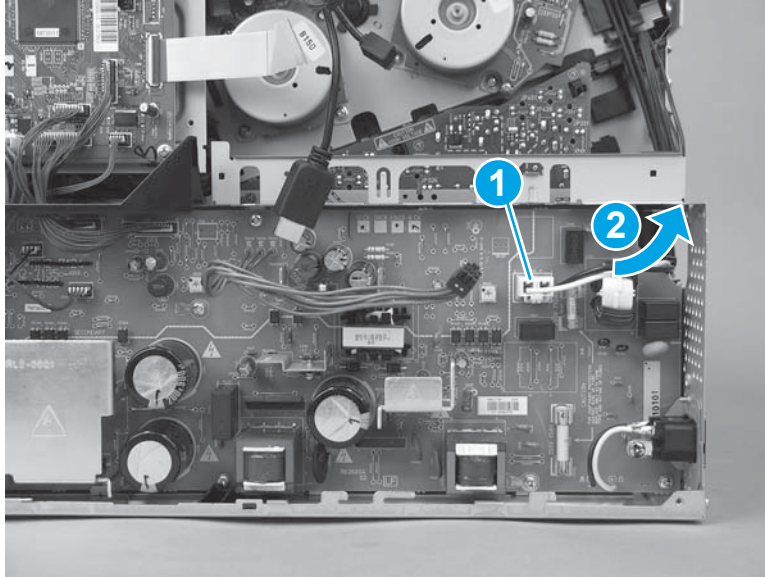

2. Disconnect three connectors on the DC controller (callout 1), and then disconnect four connectors (callout 2) on the LVPS.

Figure 1-1872 Disconnect seven connectors

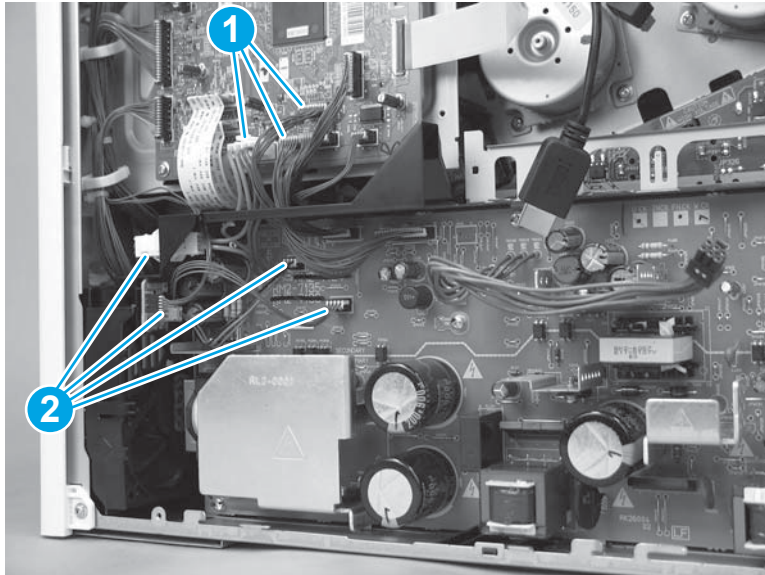

3. Pass the wire harnesses from the DC controller to the LVPS through the opening in the chassis (callout 1), and then release the wire harnesses from the retainer (callout 2).

Figure 1-1873 Pass the wire harnesses through the opening

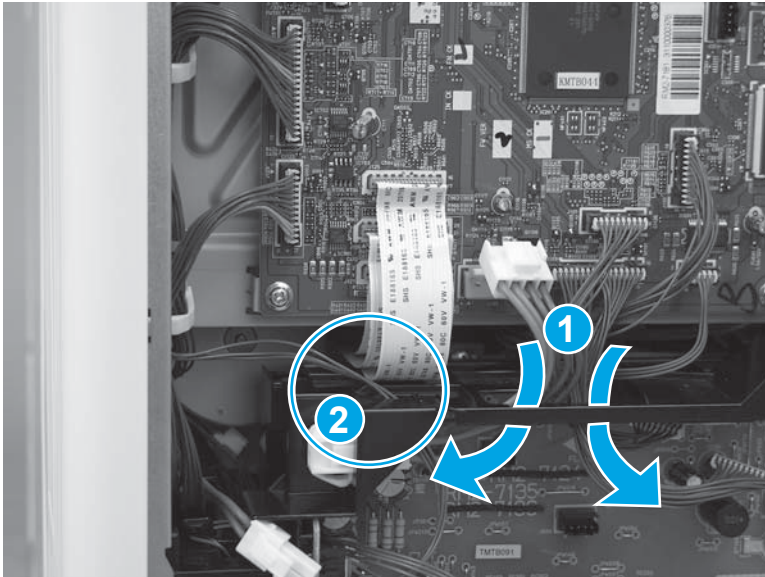

4. Remove three screws (callout 1).

Figure 1-1874 Remove three screws

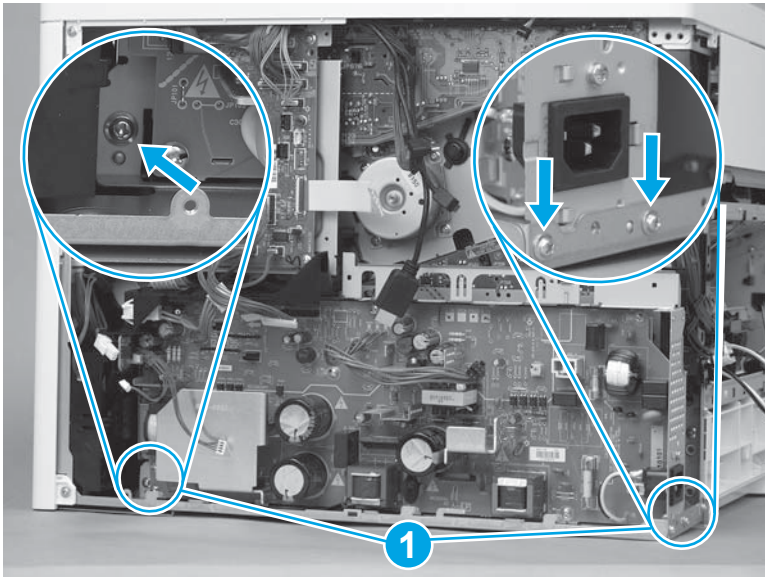

5. Rotate the top of the LVPS away from the printer (callout 1), and then slide it up and out (callout 2) of the printer to remove it.

Figure 1-1875 Remove the LVPS

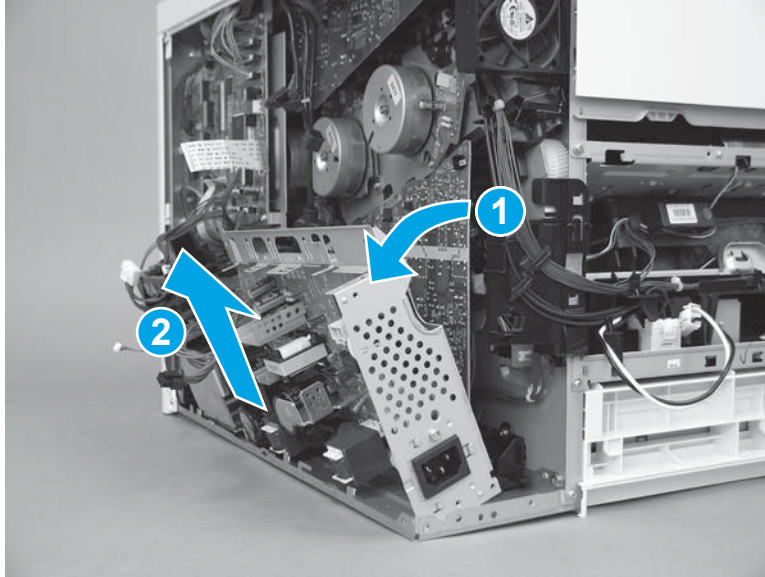

Step 20: Remove the power supply fan (FM1)

1. Remove one screw (callout 1).

Figure 1-1876 Remove one screw

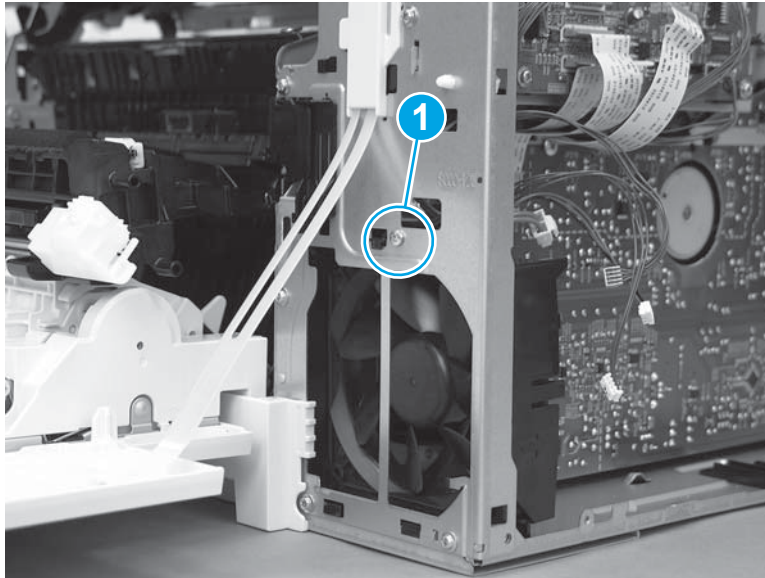

2. Release the wire harnesses from the retainer on the top of the fan bracket.

Figure 1-1877 Release the wire harnesses

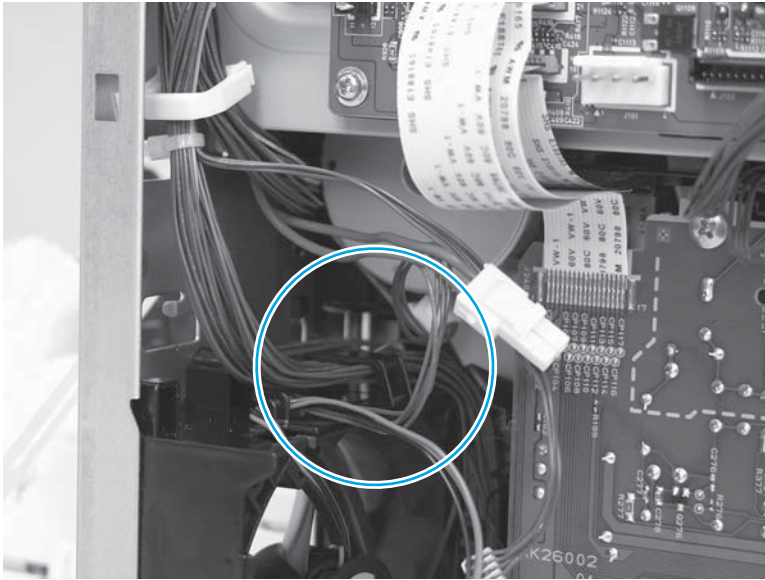

3. Lift the fan up (callout 1), and then slide it out of the printer (callout 2) to remove it.

Figure 1-1878 Remove the fan

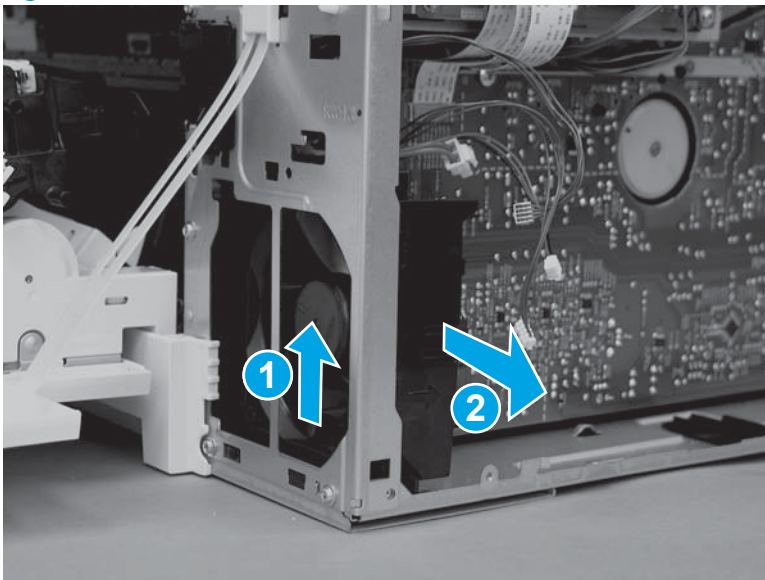

Step 21: Unpack the replacement assembly

Unpack the replacement assembly from the packaging.

For complete information on HP's recycling programs, go to [Product return and recycling](#).



NOTE: HP recommends responsible disposal of the defective assembly.

Figure 1-1879 Recycle and unpack

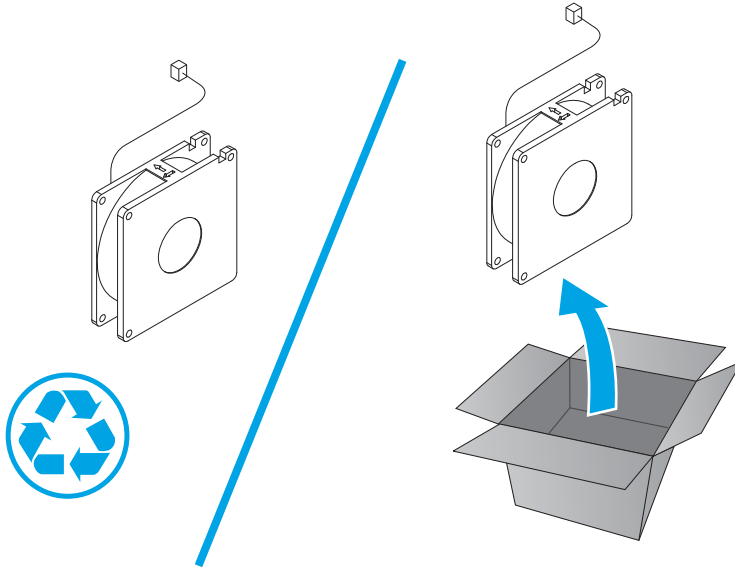

Step 22: Install the power-supply fan (FM1)

1. Slide the fan in (callout 1) and then down (callout 2) into the printer to install it.

 **NOTE:** Make sure that the arrow (callout 3) embossed on the fan holder faces into the printer.

Figure 1-1880 Install the fan



2. Place the wire harnesses in the retainer on the top of the fan bracket.

Figure 1-1881 Place the wire harnesses in the retainer

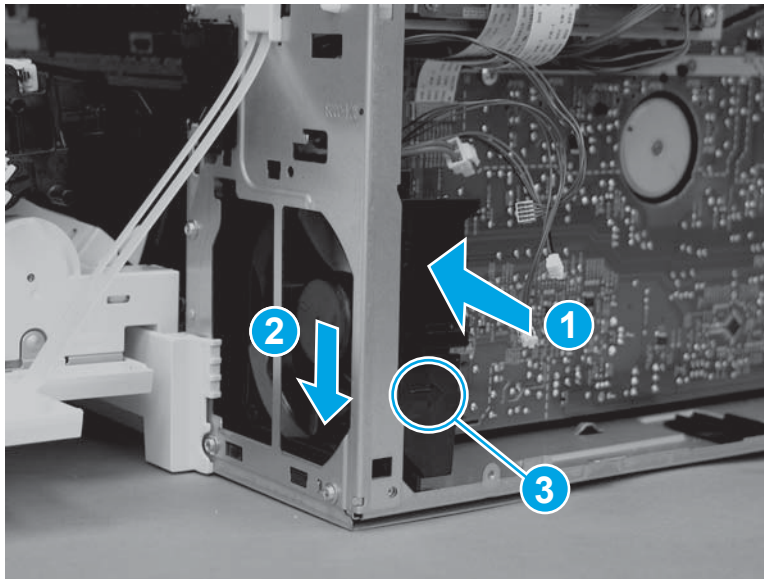
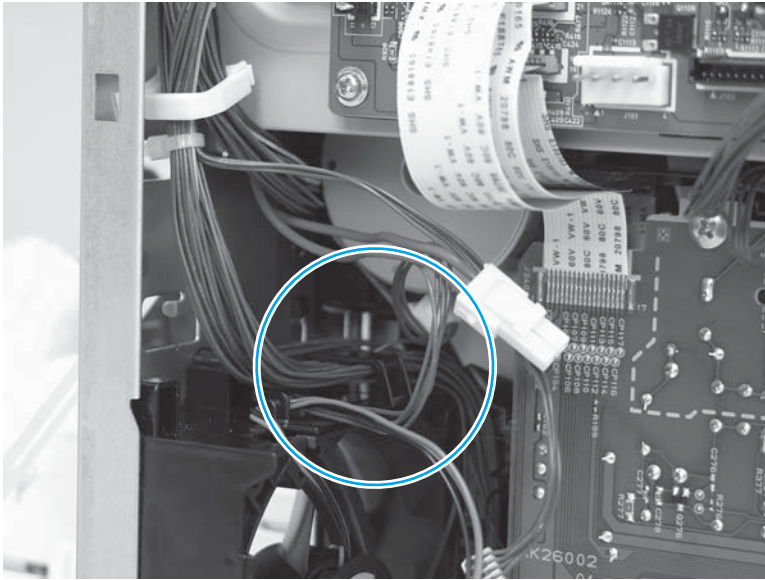

3. Install one screw (callout 1).

Figure 1-1882 Install one screw

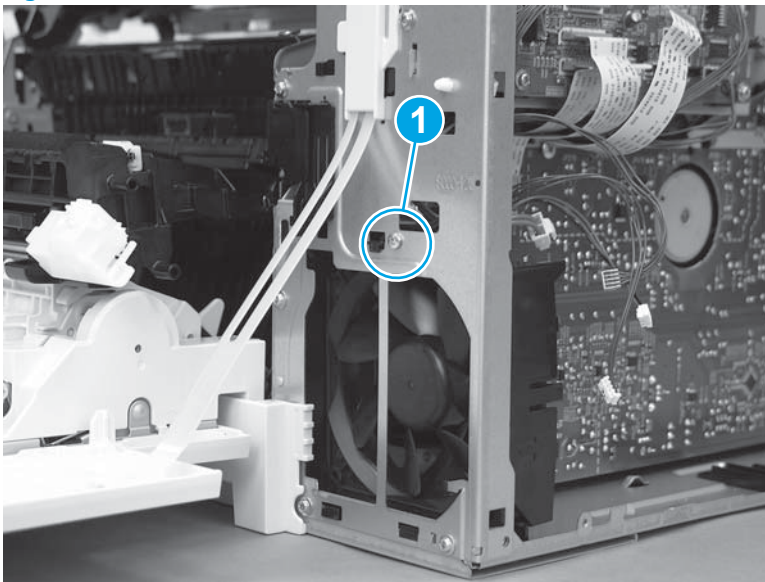

Step 23: Install the LVPS

 **CAUTION:**  ESD-sensitive part.

1. Position the bottom of the LVPS in the printer (callout 1) at a slight angle, and then rotate the top of it into the printer (callout 2) to install it.

Figure 1-1883 Install the LVPS

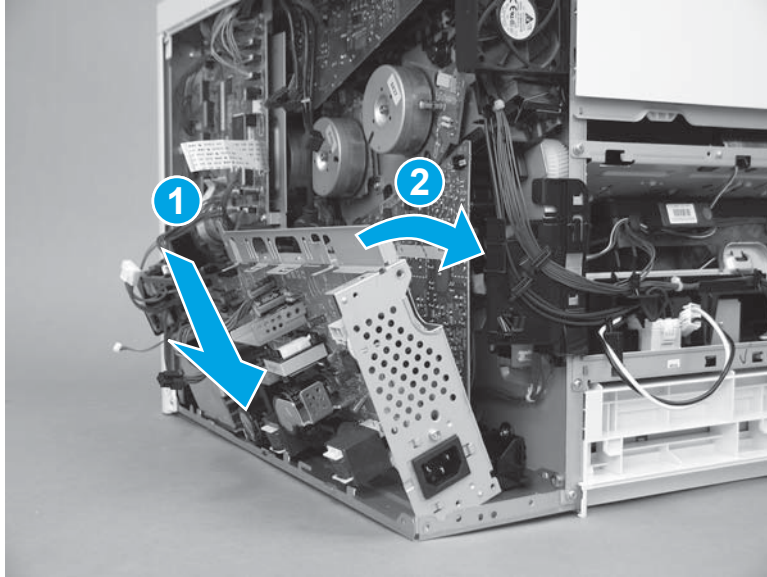

2. Install three screws (callout 1).

Figure 1-1884 Install three screws

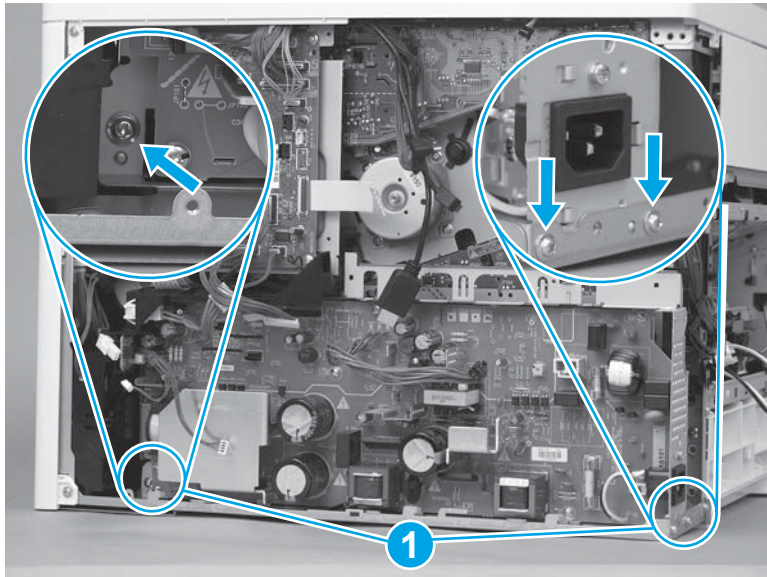

3. Pass the wire harnesses from the DC controller to the LVPS through the opening in the chassis (callout 1), and then install the wire harnesses in the retainer (callout 2).

Figure 1-1885 Pass the wire harnesses through the opening

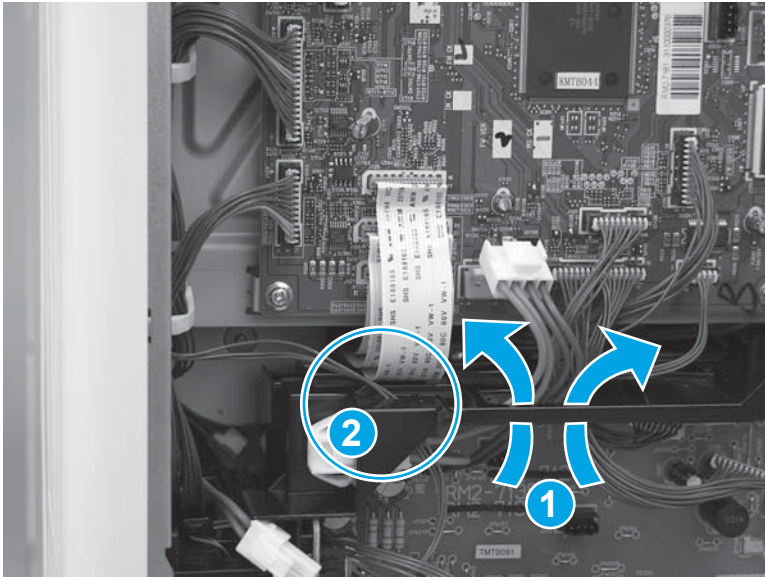

4. Connect three connectors on the DC controller (callout 1), and then connect four connectors (callout 2) on the LVPS.

Figure 1-1886 Connect seven connectors

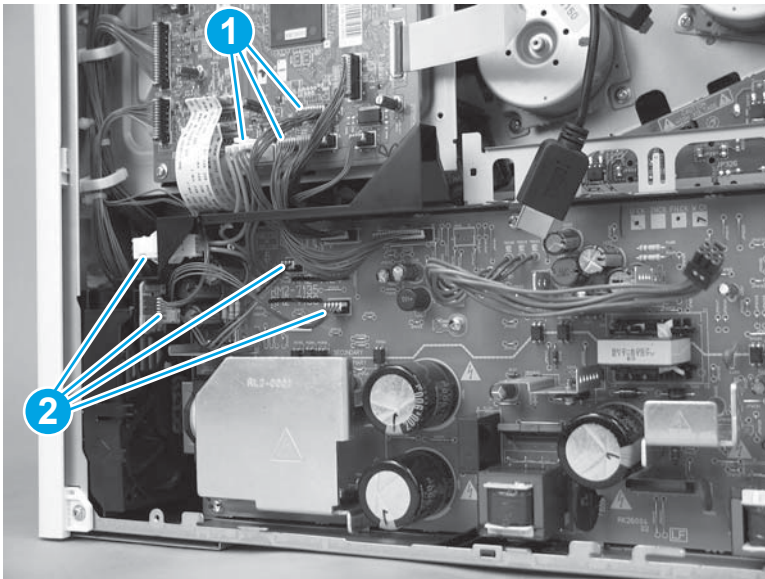

5. Pass the wire harness through the opening (callout 1) in the chassis, and then connect one wire harness (callout 2).

Figure 1-1887 Connect one wire harness

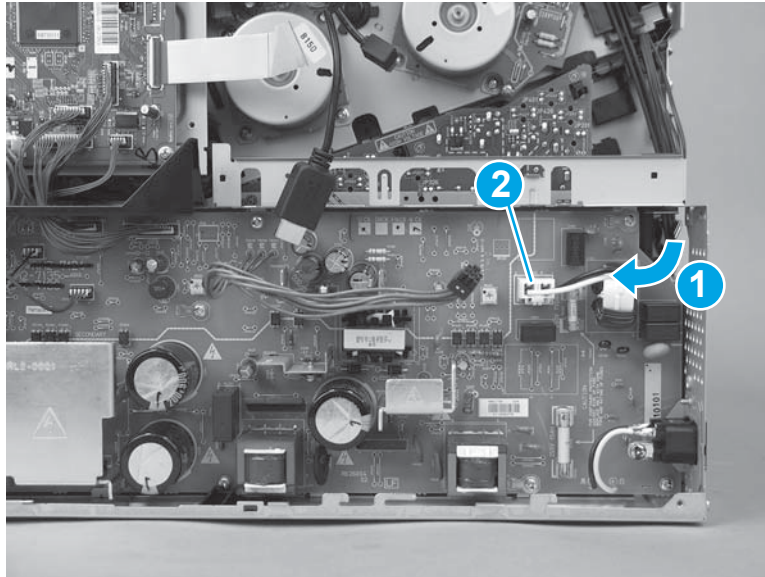

Step 24: Install the formatter case

1. Pass the wire harnesses through the opening in the formatter case.

Figure 1-1888 Pass the wire harnesses through the opening

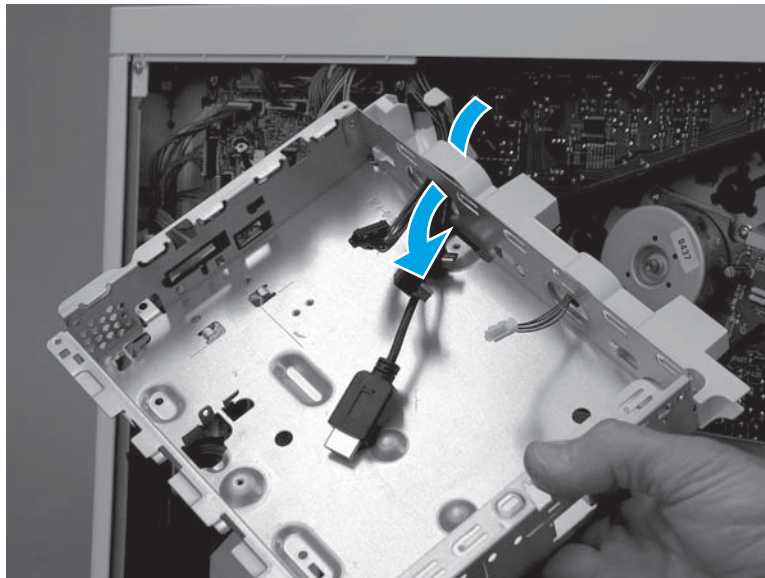

2. Position the top of the formatter case on the printer (callout 1), and then rotate the bottom of the case (callout 2) into the printer.

Figure 1-1889 Install the formatter case

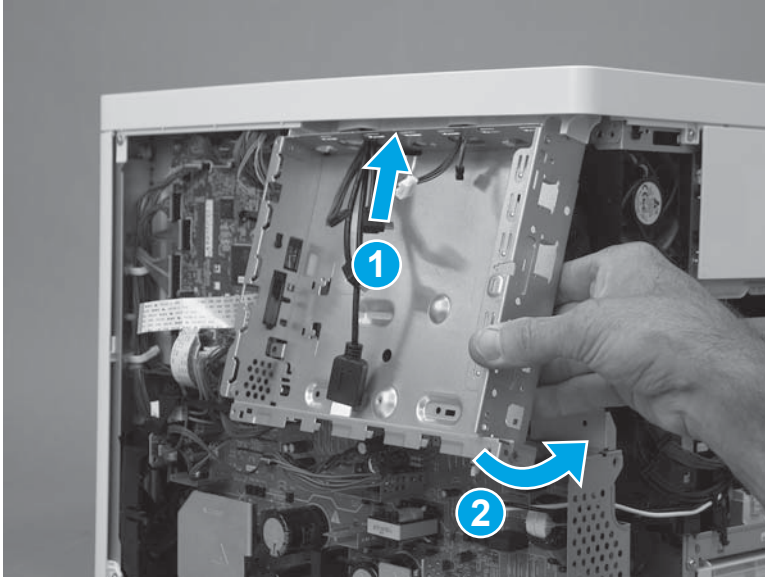

3. Install six screws (callout 1).

Figure 1-1890 Install six screws

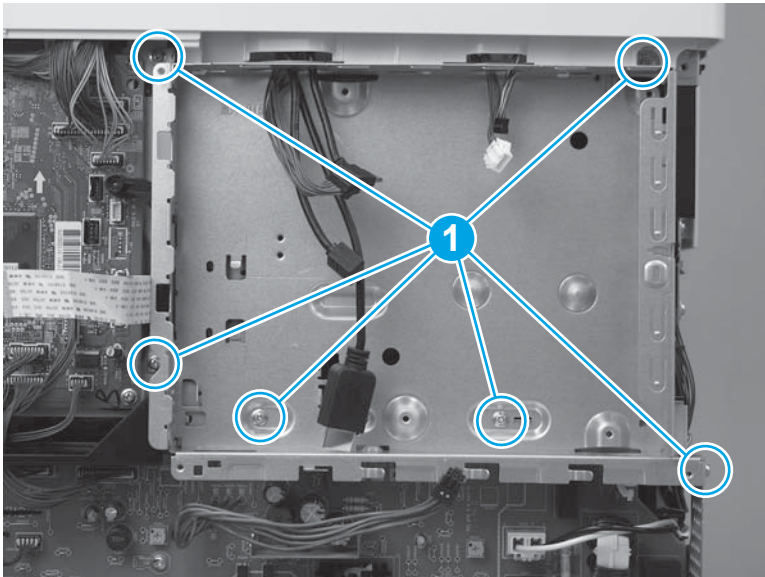

4. Pass two wire harnesses and one flat cable (callout 1) through the opening in the formatter case, and then install one wire harness in the retainer (callout 2).

 **IMPORTANT:** Make sure that the flat cable is securely fastened to the DC controller, and was not dislodged when the formatter case was removed.

Figure 1-1891 Install wire harnesses and flat cable



5. Position the LVPS cover on the printer, slide the cover to the left to install it, and then install two screws (callout 1).

Figure 1-1892 Install the LVPS cover

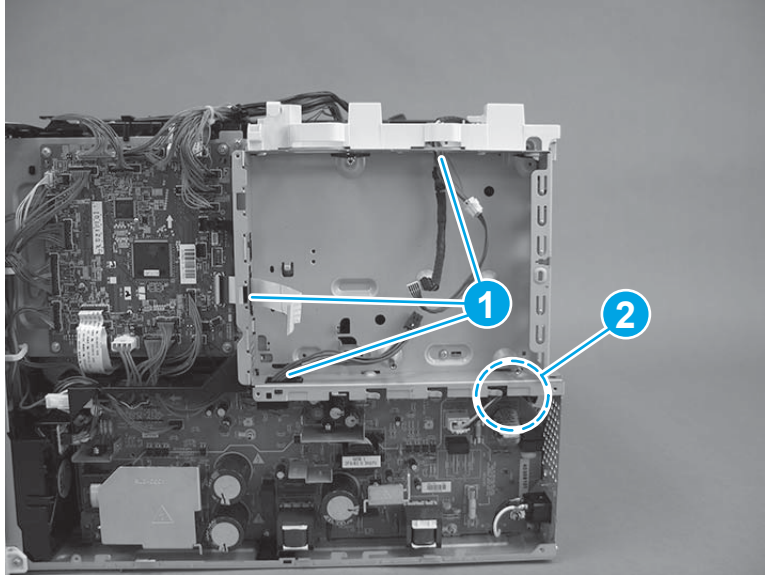
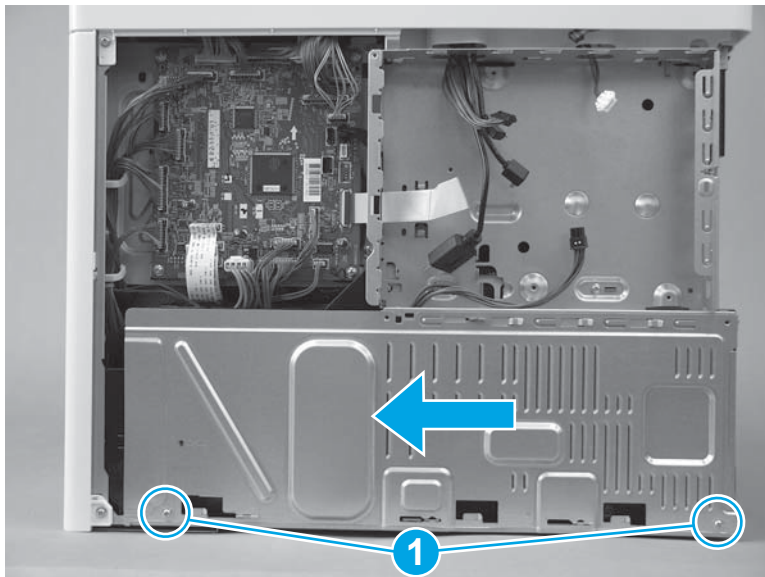

6. If no tape is affixed to the back of the flat cable, skip this step. If double-sided tape is affixed to the back of the flat cable, align the line (callout 1) on the cable with the edge (callout 2) of the opening in the sheet metal. Press to attach the flat cable to the formatter case.

Figure 1-1893 Attach the flat cable

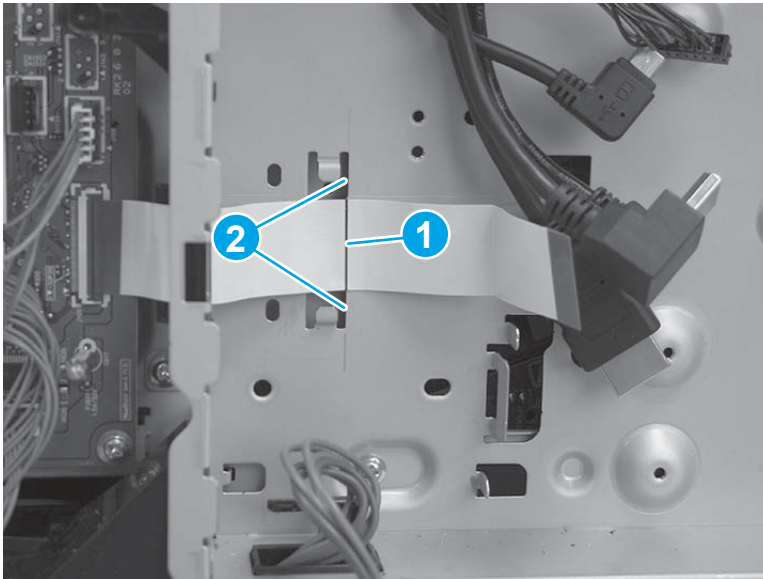

7. Position the bracket over the flat cable, and then slide the bracket to the left to install it. Make sure that the edges of the bracket fit under the sheet metal tabs (callout 1) on the formatter case and that the tabs (callout 2) snap into place.

Figure 1-1894 Position the bracket

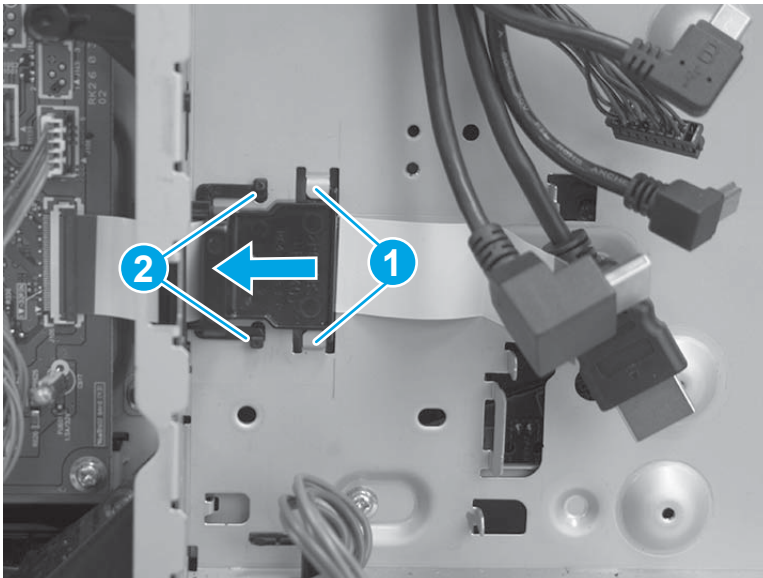

- 8. M577 only:** Pass the wire harness (callout 1) through the openings in the formatter case (callout 2), and then connect one connector (callout 3).

Figure 1-1895 Connect one connector

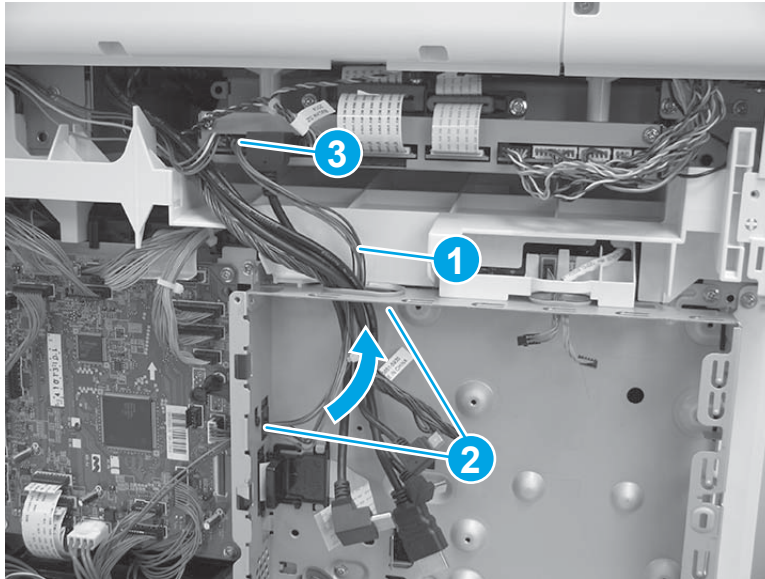

Step 25: Install the formatter (M577)

 **NOTE:** This step is for the M577 models. For the M552 and M553 models, skip this step and to go [Step 28: Install the formatter \(M552 and M553\)](#) on page 1088.

 **CAUTION:**  ESD-sensitive part.

- 1.** Position the formatter in the printer. Make sure that the network port (callout 1) fits through the opening (callout 2) in the formatter case.

Figure 1-1896 Install the formatter

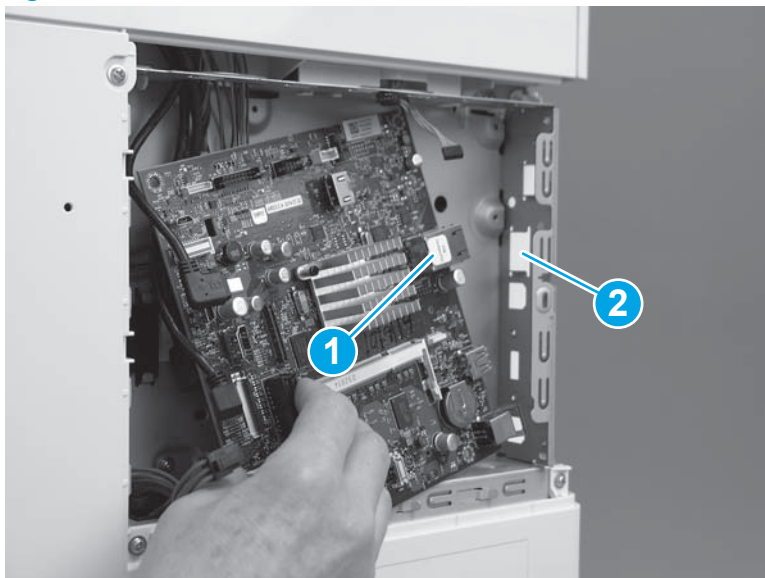

2. Install four screws (callout 1).

Figure 1-1897 Install four screws

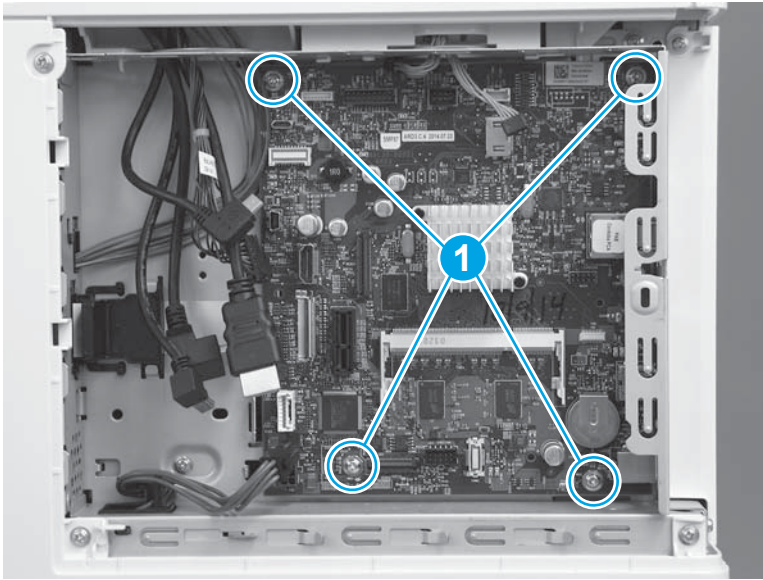

3. Connect all of the connectors on the formatter.

The following connectors are empty:

- All models: J1 (this connector is empty unless the optional DIMM is installed)
- All models: J3
- M577dn: J15 (this is the fax connector for the M577f/z/c models)
- All models: J21 (this connector is empty unless the optional internal USB ports component is installed)
- All models: J23
- All models: J24
- All models: J51
- All models: J57
- All models: J97
- All models: J98 (this connector is empty unless the optional trusted platform module (TPM) is installed)

 **IMPORTANT:** The flat-cable connector (callout 1) is a Zero Insertion Force (ZIF) connector that uses a hinged retainer to secure the flat cable. The hinged retainer must be opened to install the flat cable, and then closed after the cable is installed.

Figure 1-1898 Connect all connectors



Step 26: Install the fax PCA (M577c/f/z)

 **NOTE:** This step is for the M577c/f/z models. For the M577n model, skip this step and go to [Step 27: Install the HDD \(M577\) on page 1086](#).

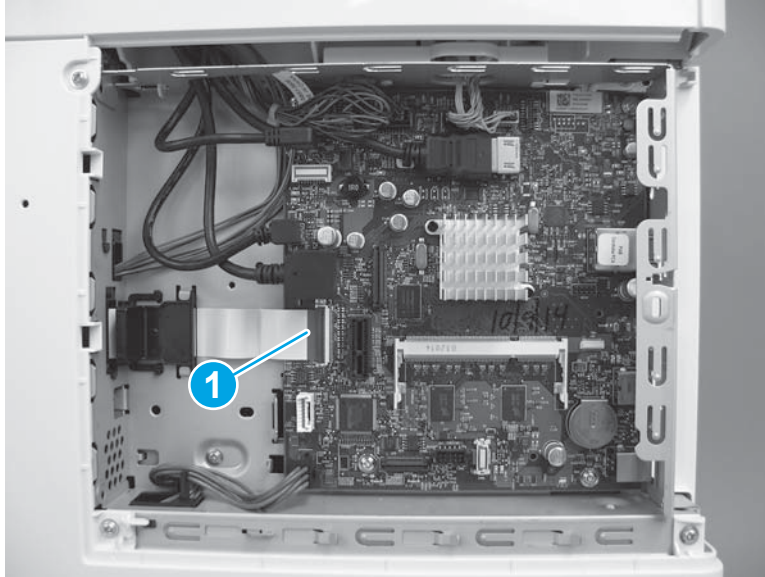
For the M552 and M553 models, skip this step and go to [Step 28: Install the formatter \(M552 and M553\) on page 1088](#).

 **CAUTION:**  ESD-sensitive part.

1. Position the tab and telephone port (callout 1) on the fax PCA in the slots (callout 2) in the formatter case.

Figure 1-1899 Position the fax PCA

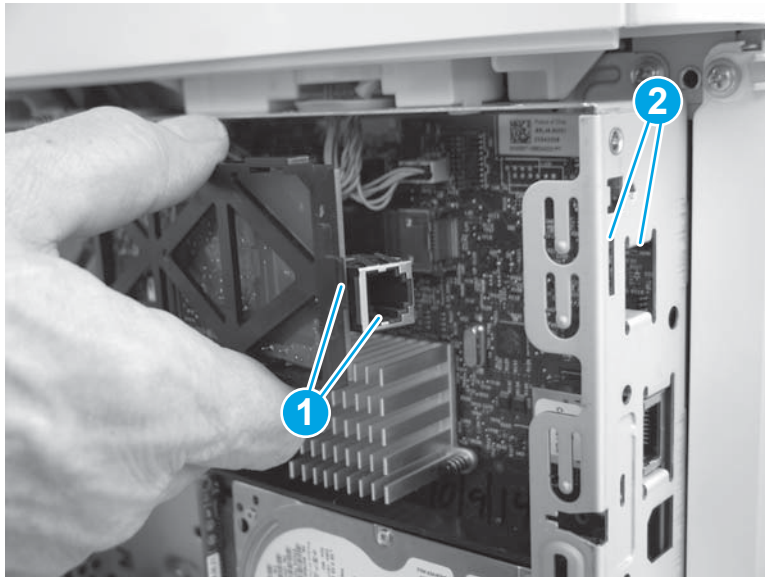

2. Slide the fax PCA to the right (callout 1) until the tab and telephone port described in the previous step and seated in the formatter case. Position the retainer (callout 2) in the slot (callout 3) in the formatter. Rotate the end of the fax PCA toward the formatter (callout 4) until the retainer snaps into place.

Figure 1-1900 Install the fax PCA

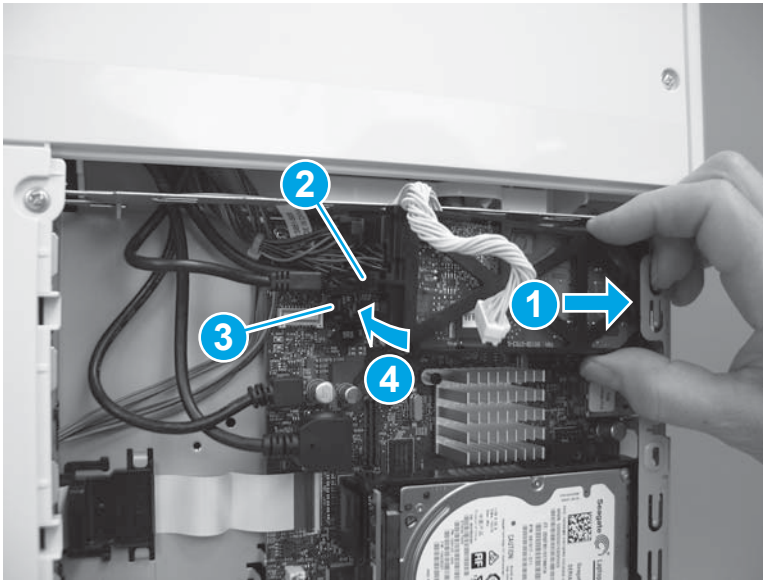

3. Position the cable (callout 1) in the guide (callout 2), and then connect one connector (callout 3).

Figure 1-1901 Connect the connector

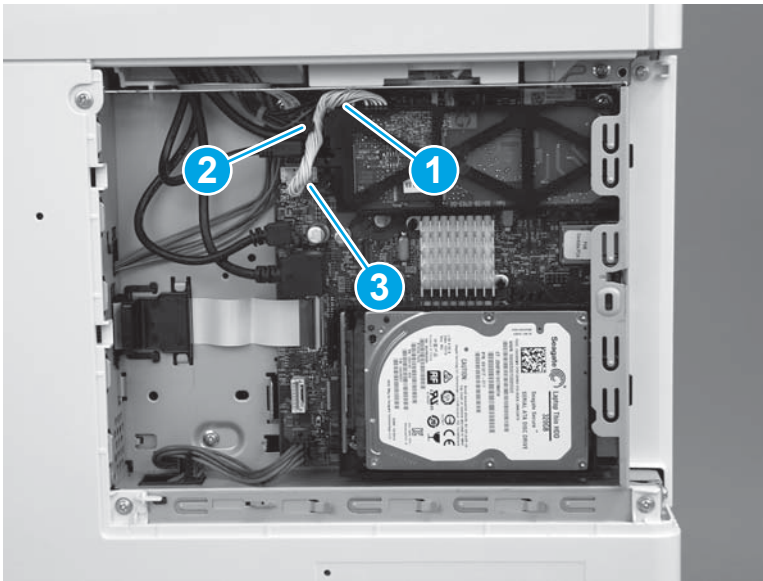

Step 27: Install the HDD (M577)



NOTE: This step is for the M577 models. For the M552 and M553 models, skip this step and go to [Step 28: Install the formatter \(M552 and M553\) on page 1088](#).

 **CAUTION:**  ESD-sensitive part.

1. Align the end of the bracket (callout 1) with the slot in the chassis (callout 2), and then slide the HDD into the printer (callout 3) to engage the bracket with the chassis.

Figure 1-1902 Install the holder

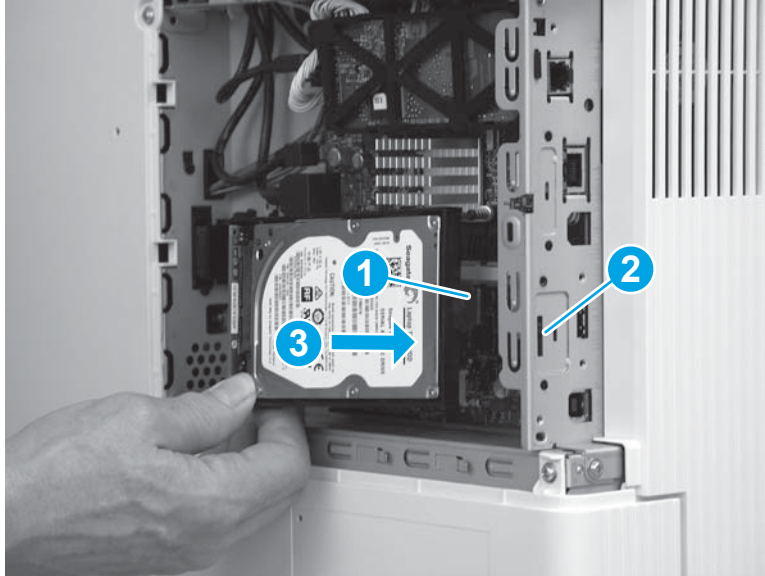

2. Hold the HDD connector latch (callout 1) in the released position, and then rotate the HDD down and into the connector on the formatter to install it.

 **NOTE:** Make sure that the tab (callout 2) snaps into place, and that the HDD is securely installed.

Figure 1-1903 Release the HDD

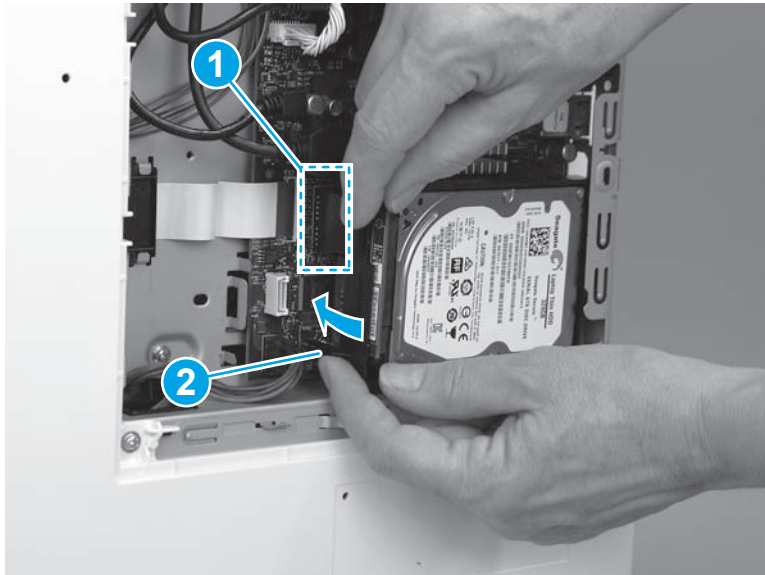

Step 28: Install the formatter (M552 and M553)

 **NOTE:** This step is for the M552 and M553 models. For the M577 models, skip this step and to go [Step 29: Install the right rear cover on page 1089](#)

If the optional hard-disk drive (HDD) was removed, do not forget to reinstall it after the formatter is reinstalled.

Engage the HDD holder with the chassis, rotate the HDD connector down and into the connector on the formatter. Make sure that the tabs snap into place.

 **CAUTION:**  ESD-sensitive part.

1. Position the formatter in the printer, and then install four screws (callout 1).

Figure 1-1904 Install the formatter

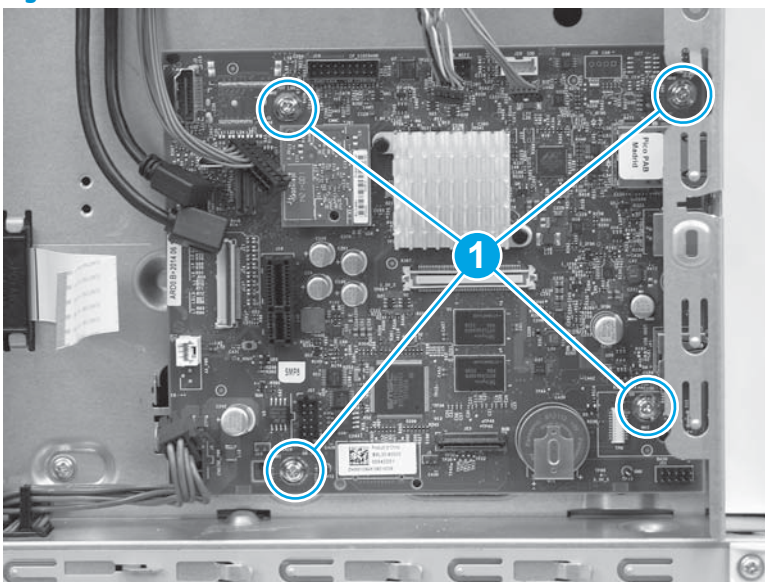

2. Connect all of the connectors on the formatter.

The following connectors are empty:

- All models: J1 (this connector is empty unless the optional DIMM is installed)
- M553n/dn and M552dn: J2 (callout 1; this is the touchscreen connector for the M553x model)
- All models: J9 (this connector is empty unless the optional internal USB ports component is installed)
- All models: J18 (this connector is empty unless the optional hard-disk-drive (HDD) is installed)
- All models: J23
- All models: J24
- M553n/dn and M552dn: J25 (this is the wireless connector for the M553x model)

- All models: J57
- All models: J98 (this connector is empty unless the optional trusted platform module (TPM) is installed)

 **IMPORTANT:** The flat-cable connector (callout 2) is a Zero Insertion Force (ZIF) connector that uses a hinged retainer to secure the flat cable. The hinged retainer must be opened to install the flat cable.

Figure 1-1905 Connect all connectors



Step 29: Install the right rear cover

1. Position the cover on the printer.

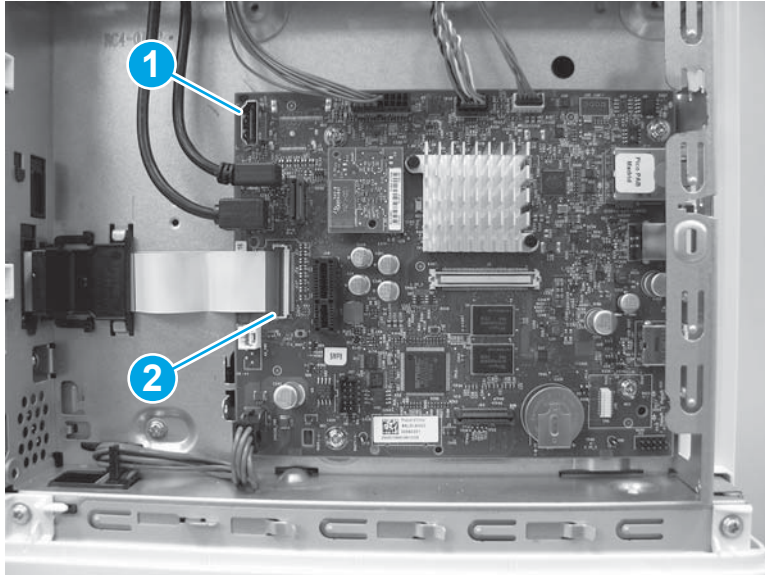
Figure 1-1906 Install the cover

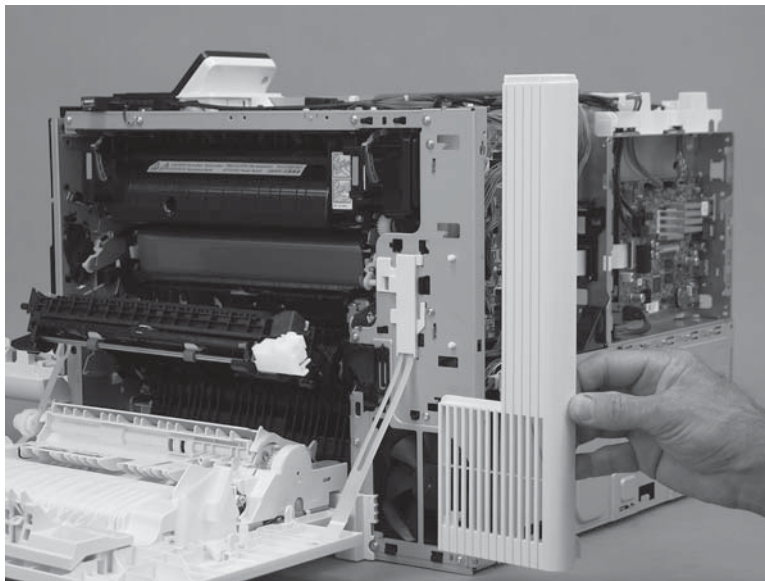

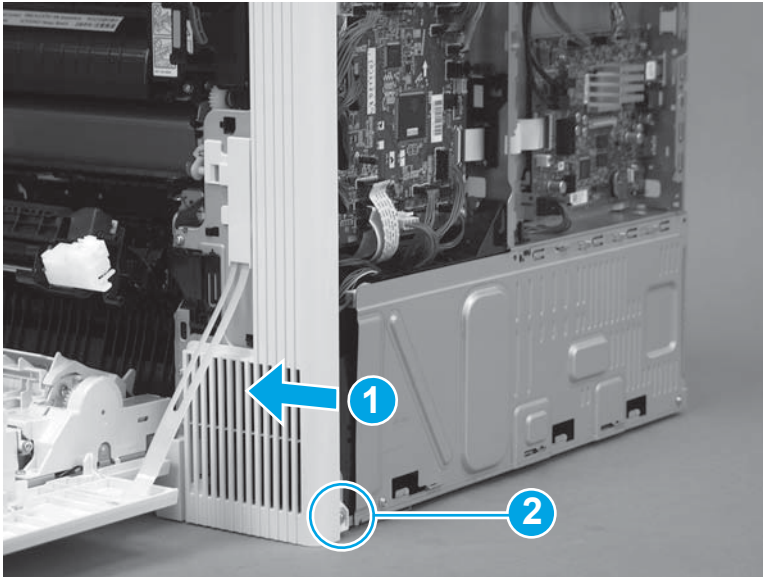

2. Slide the cover toward the right door (callout 1) to engage it with the printer, and then install one screw (callout 2).

Figure 1-1907 Install one screw



Step 30: Install the right upper cover (M577)

 **NOTE:** This step is for the M577 models. For the M552 and M553 models, skip this step and go to [Step 33: Install the upper cover \(M552 and M553\) on page 1096](#).

 **NOTE:** The figures below show the image scanner installed. The procedures for removing and installing the right upper cover are the same whether the image scanner is installed or removed."

1. **M577c/f/z only:** Install the cables (callout 1) through the slot (callout 2) in the printer.

Figure 1-1908 Install the cables

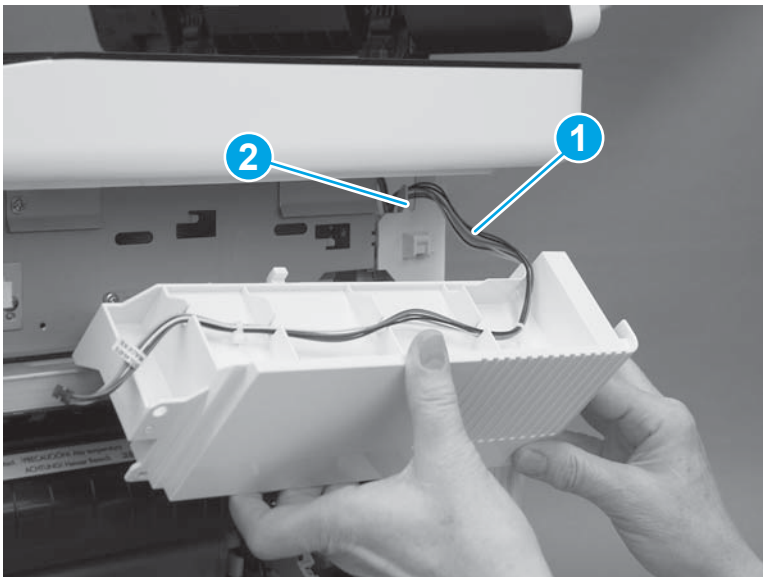

2. Position the hooks (callout 1) on the cover in the slots (callout 2) in the printer.

Figure 1-1909 Position the hooks

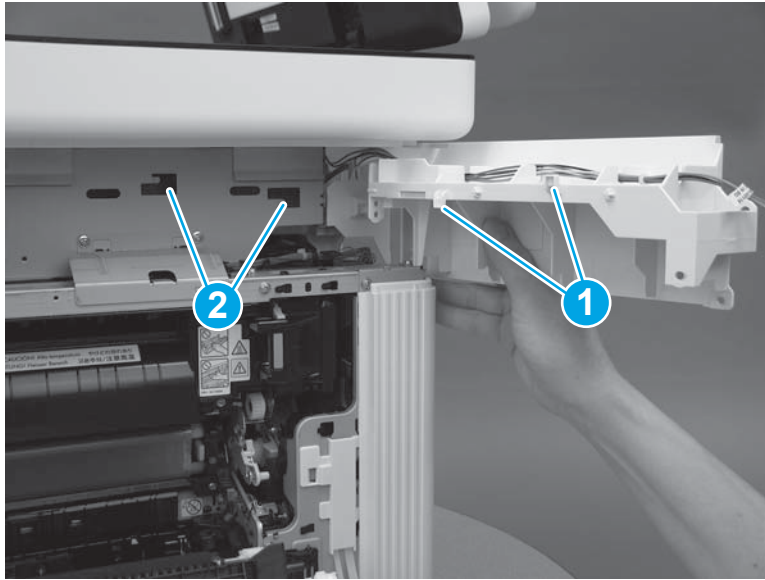

3. Slide the cover toward the front of the printer to install it.

Figure 1-1910 Install the cover

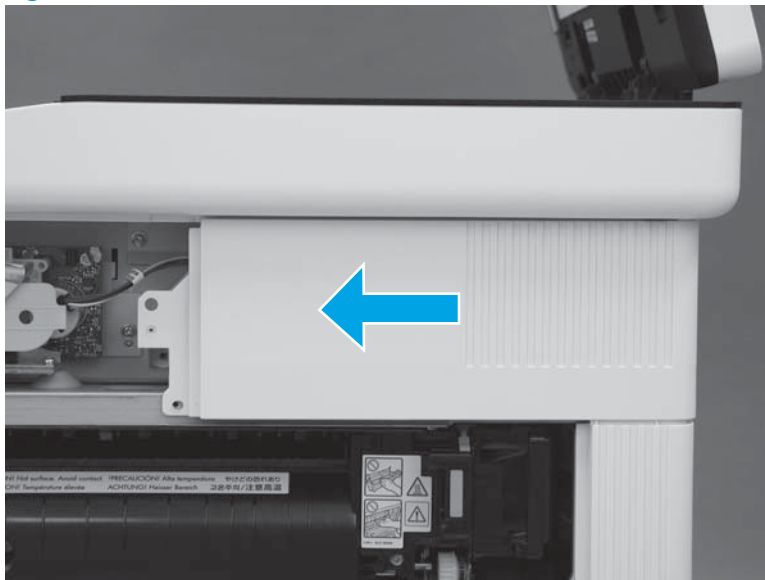

4. At the back of the printer, install one screw (callout 1).

M577c/f/z only: Connect one connector (callout 2), if the integrated scanner assembly is installed.

TIP: This screw is smaller than the screws installed in the next step. Make sure that this screw is installed in the correct position.

Figure 1-1911 Install one screw and connector



5. At the right side of the printer, install two screws (callout 1).

M577c/f/z only: Connect one connector (callout 2), if the stapler is installed.

Figure 1-1912 Install one screw and connector

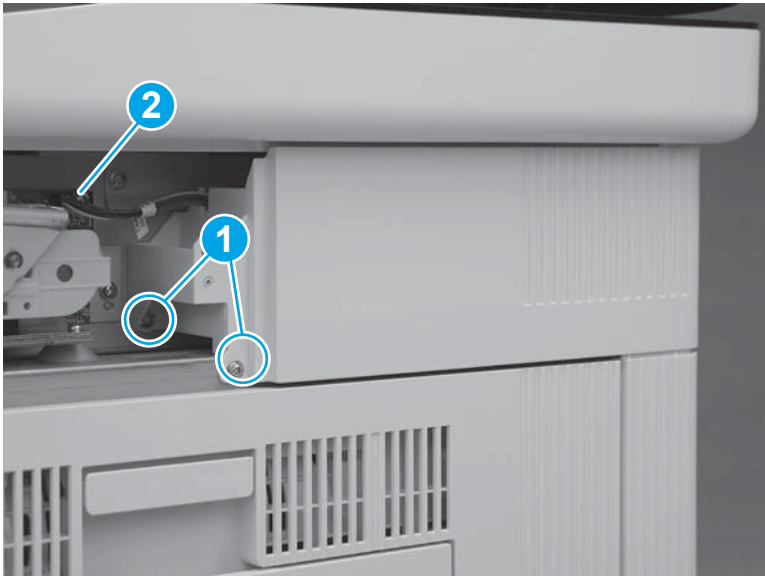

Step 31: Install the stapler cover assembly (M577f and M577z)

 **NOTE:** This step is for the M577c/f/z models. For the M577dn model, skip this step and to go [Step 32: Install the right front upper cover \(M577dn\) on page 1094](#).

For the M552 and M553 models, skip this step and go to [Step 33: Install the upper cover \(M552 and M553\) on page 1096](#).

1. Install the tabs (callout 1) on the cover in the slots (callout 2) in the printer.

Figure 1-1913 Install two tabs



2. Press the cover toward the left side of the printer until it snaps into place.

Figure 1-1914 Install the cover assembly



3. Install one screw (callout 1).



 **IMPORTANT:** This is a self-tapping screw for plastic. Rotate it counterclockwise to align it with the existing thread pattern, and then carefully turn it clockwise to tighten. Do not overtighten. This will prevent stripping the threads inside the screw hole.

Figure 1-1915 Install one screw

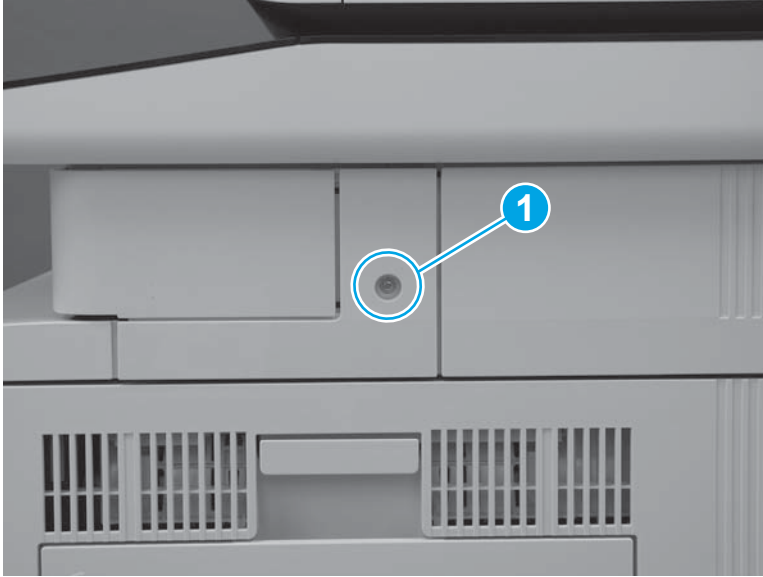

Step 32: Install the right front upper cover (M577dn)

 **NOTE:** This step is for the M577dn model. For the M577c/f/z models, skip this step and to go [Step 34: Install the left cover on page 1098](#).

For the M552 and M553 models, skip this step and go to [Step 33: Install the upper cover \(M552 and M553\) on page 1096](#).

1. Slide the cover toward the left side of the printer to install it. Make sure that the slots (callout 1) in the cover fit over the tabs (callout 2) on the inside of the paper feeder cover.

Figure 1-1916 Install the cover



2. Press the right front upper cover (callout 1) and the paper feeder cover (callout 2) together until the tabs on the inside of the covers snap into place.

Figure 1-1917 Press the cover



3. Install one screw (callout 1).

Figure 1-1918 Install one screw

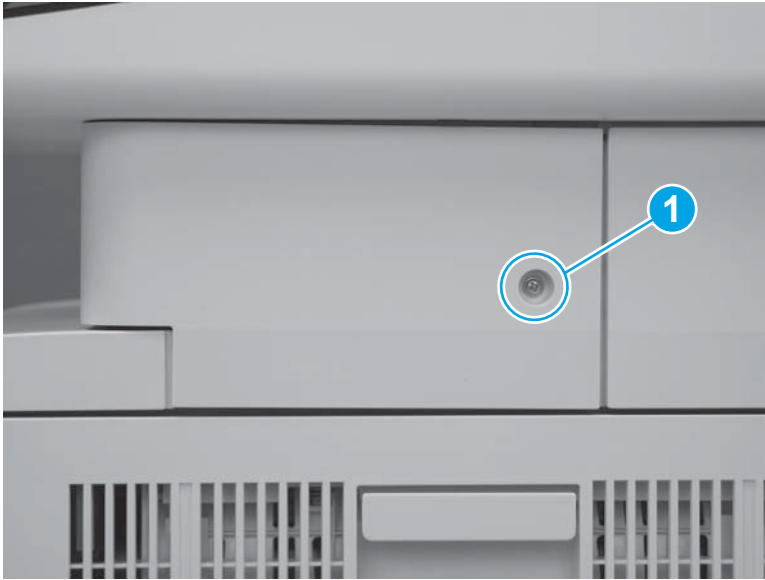

Step 33: Install the upper cover (M552 and M553)



NOTE: This step is for the M552 and M553 models. For the M577 models, skip this step and to go [Step 34: Install the left cover on page 1098](#)

1. Position the cover on the printer.



NOTE: For the M553x model, do not forget to pass the control-panel wire harness and USB cable through the opening in the cover.

Figure 1-1919 Install the cover

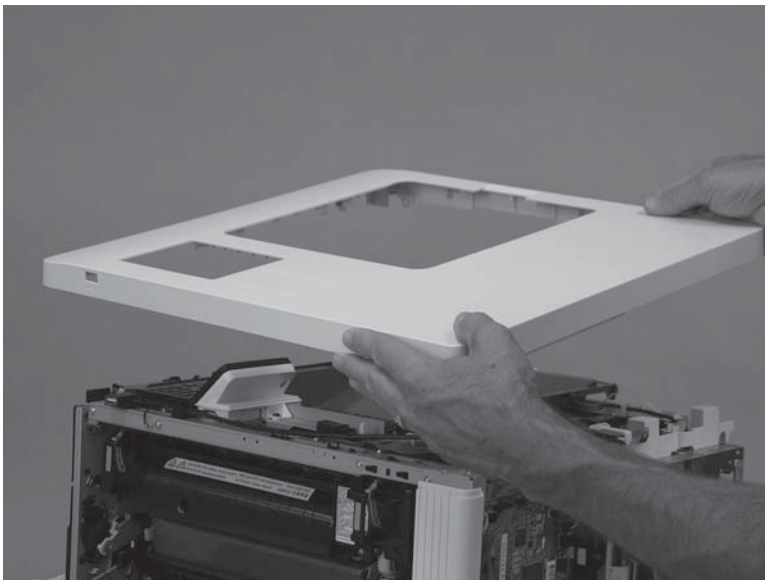

2. Push down on the rear corner of the cover to engage one tab (callout 1).

Figure 1-1920 Engage one tab

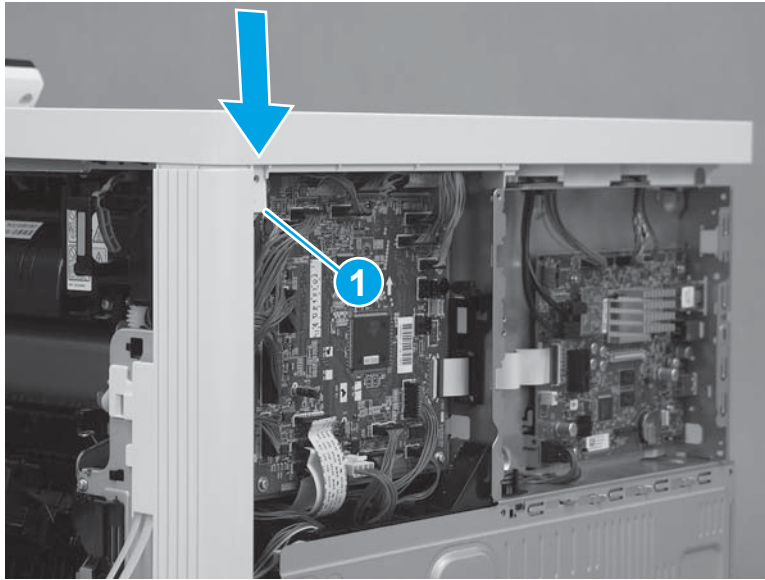

3. Push down on the front corner of the cover to engage one tab (callout 1), and then install one screw (callout 2).



NOTE: This is a self-tapping plastic-thread screw. Make sure that this screw is used in this location when it is reinstalled.

Figure 1-1921 Engage one tab and install one screw



4. Install three screws (callout 1).

Figure 1-1922 Install three screws

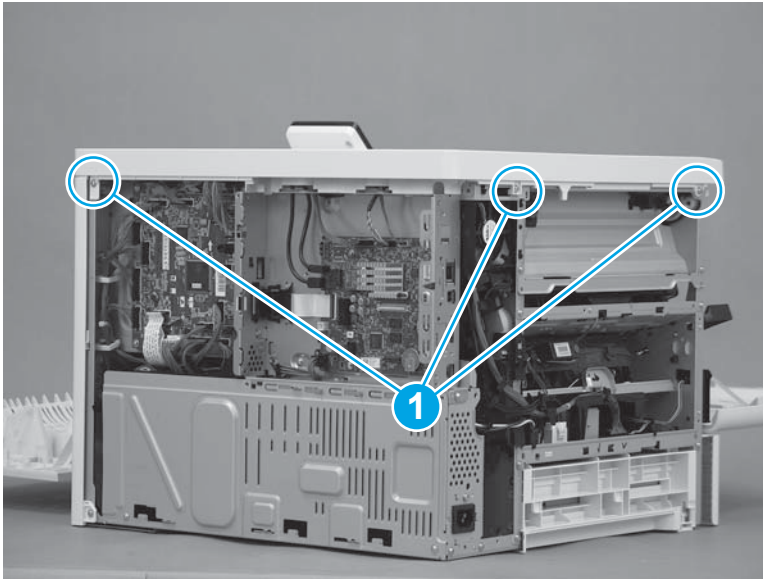

Step 34: Install the left cover

1. Position the cover on the printer.

 **NOTE:** Slightly offset the cover toward the rear of the printer.

Figure 1-1923 Install the cover

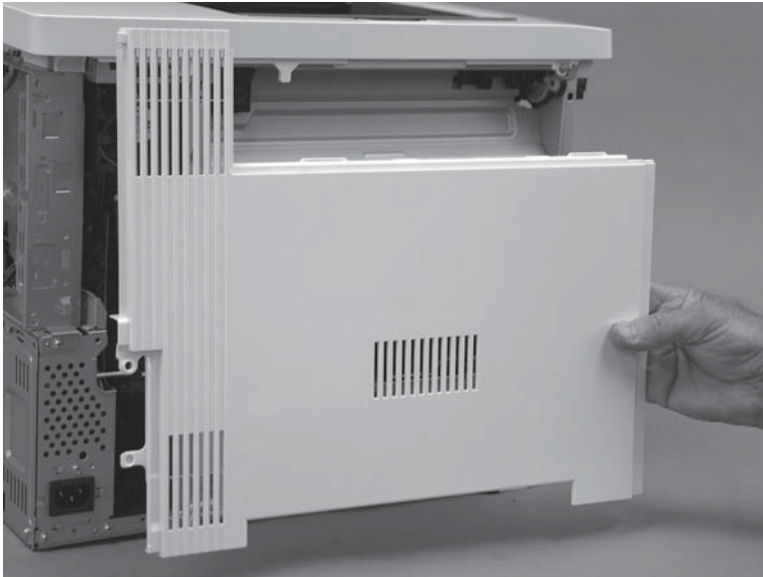

2. Slide the cover (callout 1) toward the front of the printer to engage it. Make sure that the tab (callout 2) snaps into place.

 **NOTE:** Locate the alignment pin (callout 3) on the cover from the front door side of the printer, and then make sure that it is fully engaged in the slot in the chassis.

 **TIP:** While sliding the cover into place, push in on the center of the cover (callout 1) to make sure that the hooks on the back of the cover engage with the slots in the chassis.

Figure 1-1924 Engage the cover



3. At the left side of the printer, install one screw (callout 1).

Figure 1-1925 Install one screw

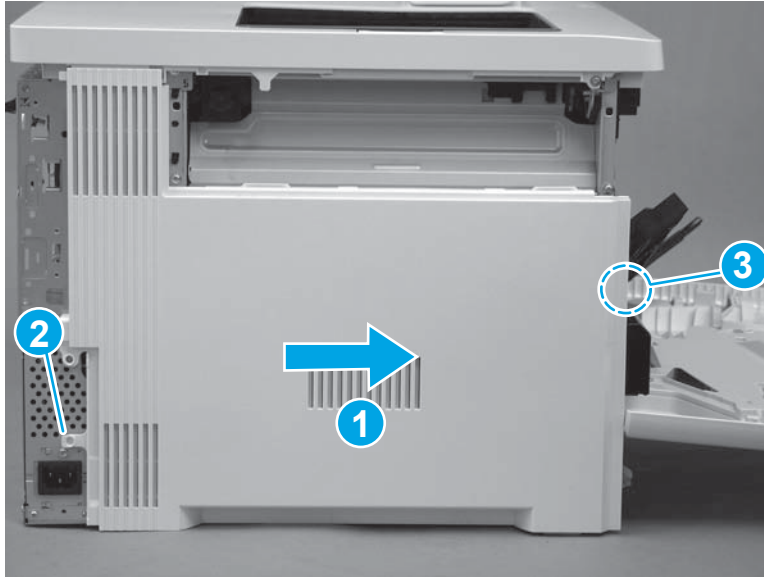

Step 35: Install the rear cover (M577)

 **NOTE:** This step is for the M577 models. For the M552 and M553 models, skip this step and go to [Step 37: Install the rear cover \(M552 and M553\) on page 1103](#).

1. Position the hooks (callout 1) on the cover in the slots (callout 2) in the printer.

Figure 1-1926 Position the hooks

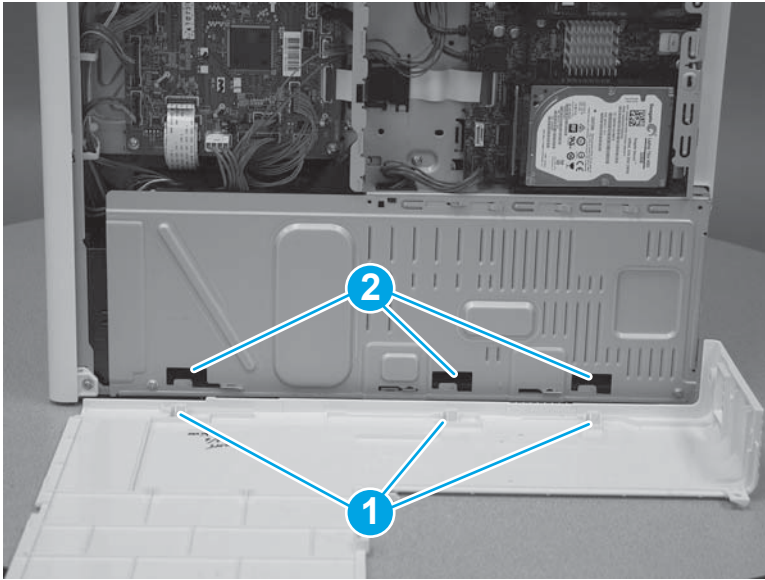

2. Position the back edge (callout 1) of the rear cover behind the edge (callout 2) of the right rear cover. Slide the cover to the left to install it.

Figure 1-1927 Install the cover

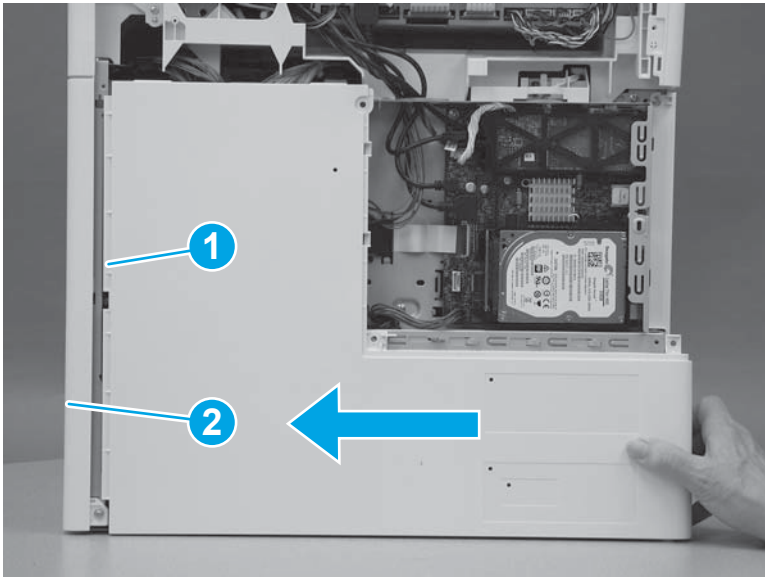

3. Install four screws (callout 1).

Figure 1-1928 Install four screws cover

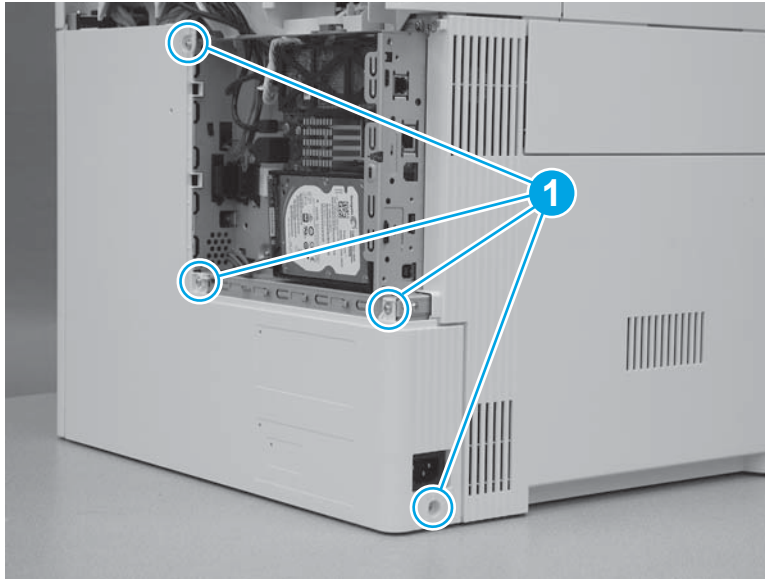

Step 36: Install the rear upper cover (M577)

 **NOTE:** This step is for the M577 models. For the M552 and M553 models, skip this step and go to [Step 37: Install the rear cover \(M552 and M553\)](#) on page 1103.

1. Align the ridge (callout 1) on the lower edge of the rear upper cover in front of the tabs (callout 2) on the top edge of the rear cover.

Figure 1-1929 Align the cover

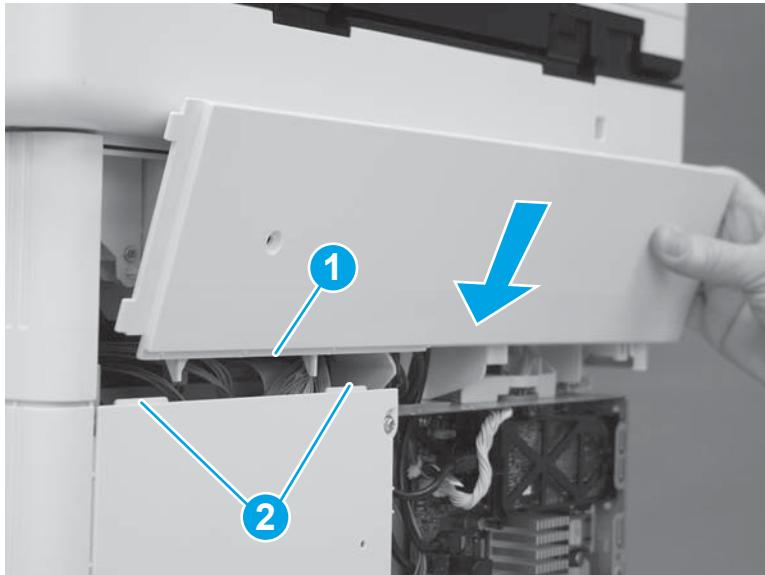

2. Rotate the top of the cover toward the printer.

Figure 1-1930 Rotate the top of the cover

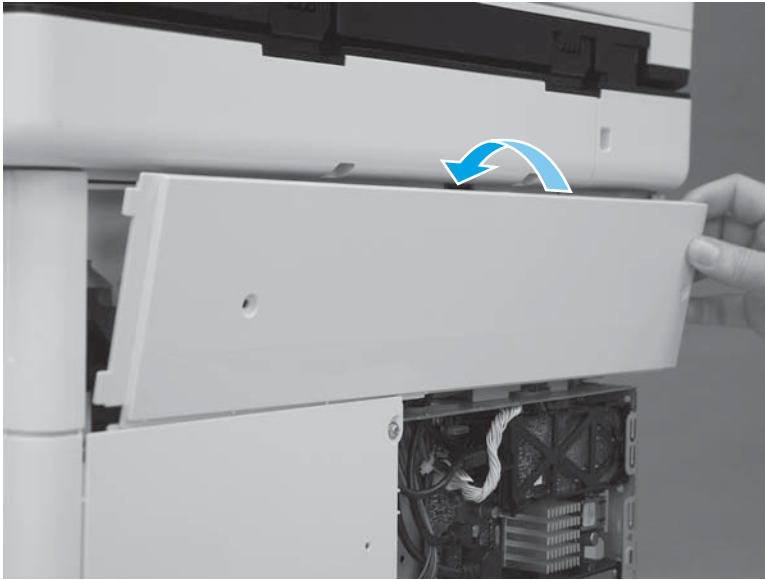

3. Slide the cover to the left (callout 1). Make sure that the tabs (callout 2) on the upper rear cover slide behind the edge (callout 3) of the right upper cover. Make sure that the cover is fully seated.

Figure 1-1931 Slide the cover

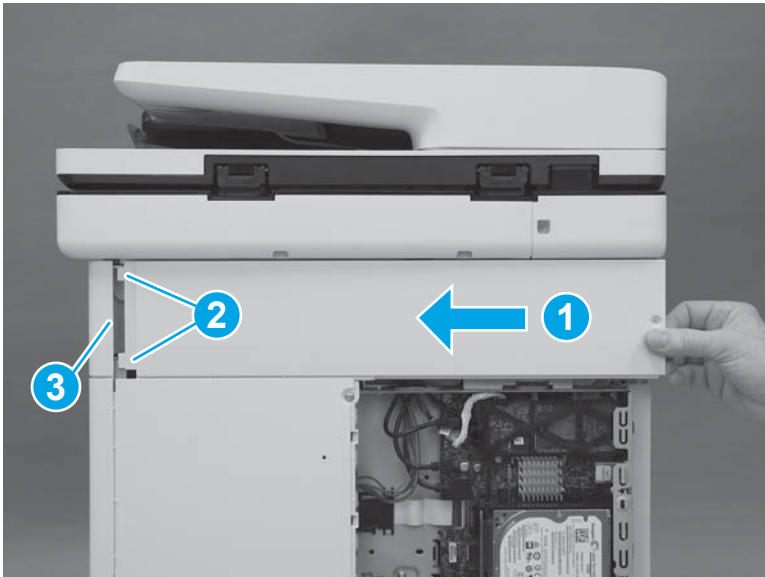

4. Install two screws (callout 1).

 **IMPORTANT:** These two screws are self-tapping screws for plastic. Rotate them counterclockwise to align them with the existing thread pattern, and then carefully turn them clockwise to tighten. Do not overtighten. This will prevent stripping the threads inside the screw holes.

Figure 1-1932 Install two screws



Step 37: Install the rear cover (M552 and M553)

 **NOTE:** This step is for the M552 and M553 models. For the M577 models, skip this step and go to [Step 38: Install the formatter cover on page 1104](#)

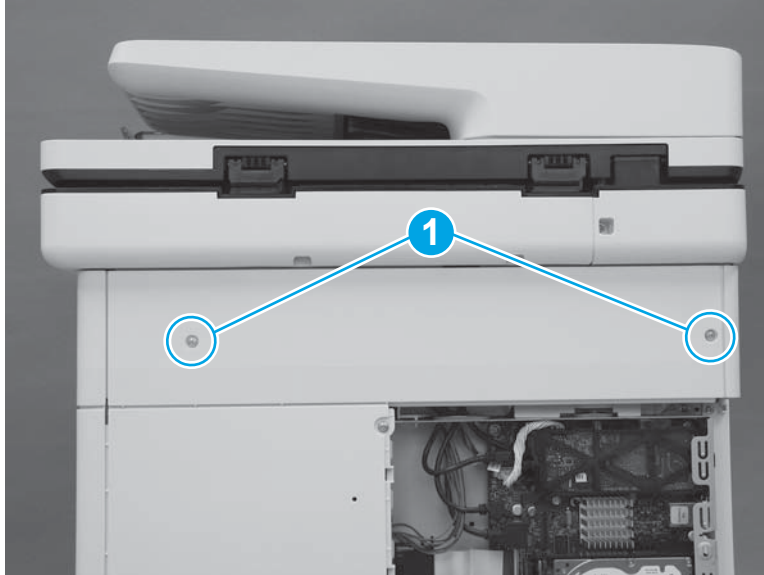
1. Position the top of the cover under the upper cover (callout 1), rotate the bottom of the cover onto the chassis (callout 2), and then slide the cover to the left (callout 3) to install it.

Figure 1-1933 Install the cover

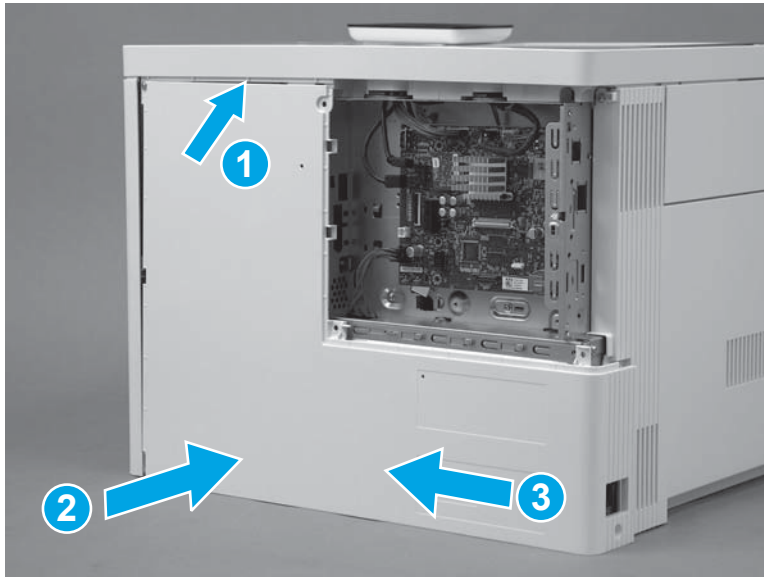

2. Install four screws (callout 1).

Figure 1-1934 Install four screws cover

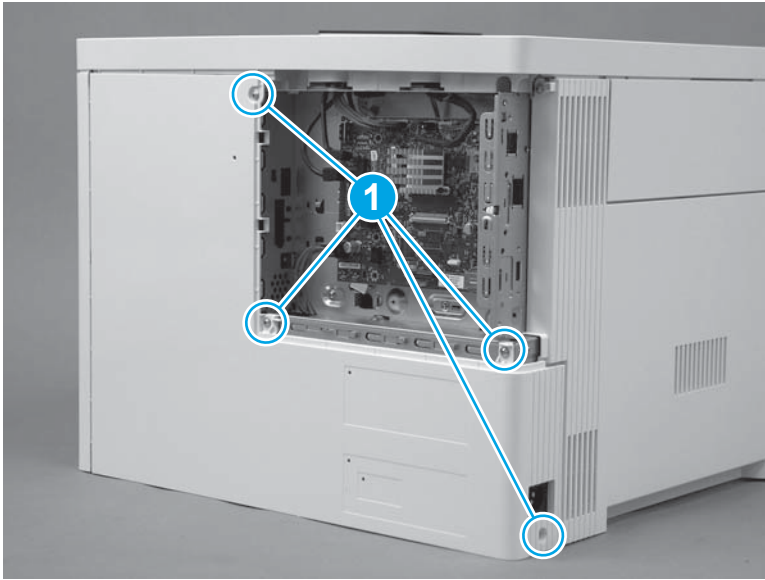

Step 38: Install the formatter cover

- ▲ Slide the cover onto the printer (callout 1) to install it.

 **NOTE:** Make sure that the tabs on the formatter cover align with the slots provided in the printer (callout 2). Tighten the two thumbscrews (callout 3).

 **TIP:** If needed, use the edge of a coin to turn the thumbscrews.

Figure 1-1935 Install the cover



Step 39: Install the TCU

 **NOTE:** This step is for the M552 and M553 models. For the M577 models, skip this step.

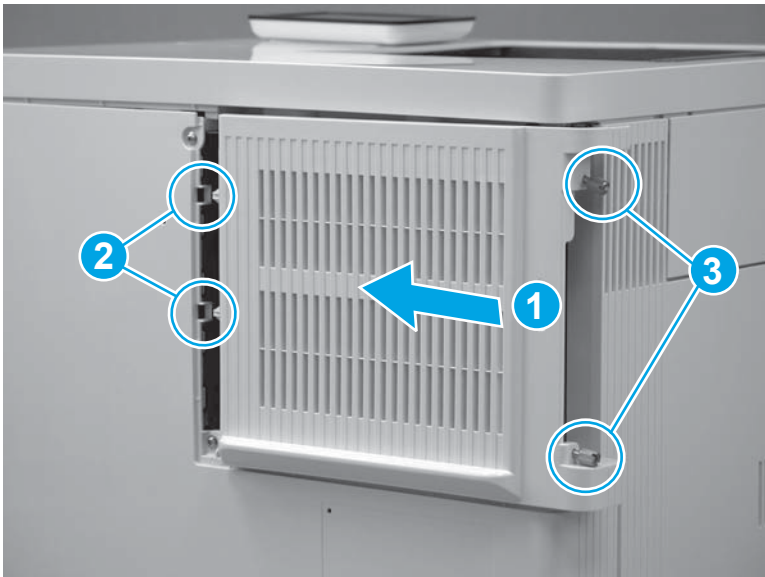
1. Verify that the toner collection hatch cover is in the closed position on the TCU.

Figure 1-1936 Verify that the toner collection hatch cover is closed

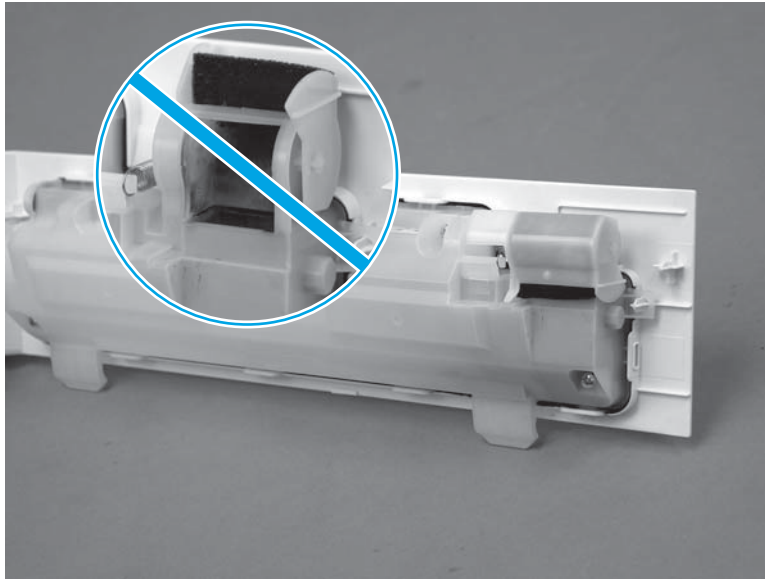

2. Position the TCU with the hinges in the slots provided in the printer (callout 1), and then rotate the TCU up and into the closed position.

 **NOTE:** The toner collection hatch cover automatically opens when the TCU is closed.

Figure 1-1937 Install the TCU



3. Close the front door.

Figure 1-1938 Close the front door

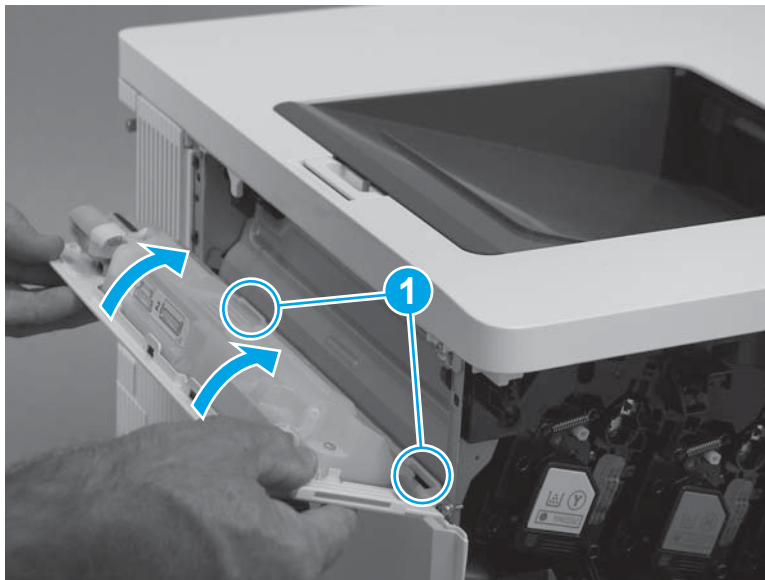

Step 40: Install the control-panel assembly (M553x only)



NOTE: This step is for the M553x model. For the M553n/dn and M552dn models, skip this step and go to [Step 17: Install the USB cover on page 517](#).

For the M577 models, skip this step.

1. Place the control panel on the printer as shown.

Figure 1-1939 Place the control panel on the product

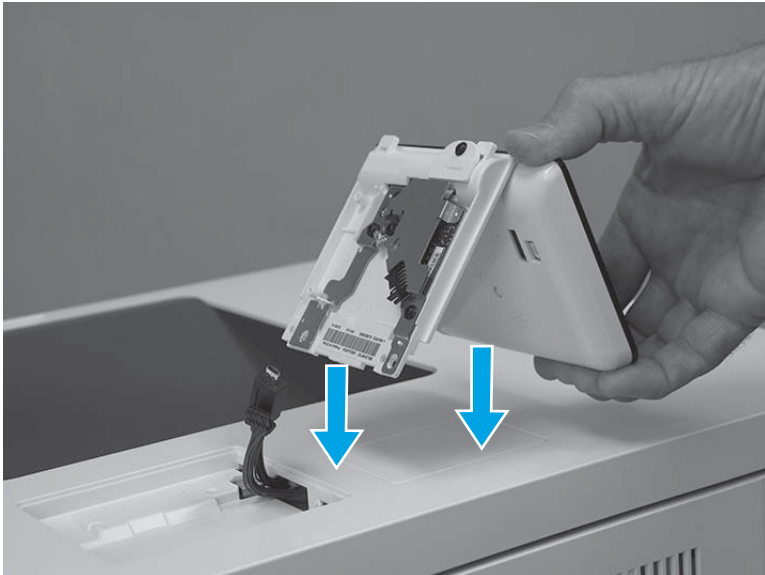

2. Connect one USB cable (callout 1), and one connector (callout 2).

 **IMPORTANT:** Take note of the location of the two mounting tabs (callout 3) on the control-panel assembly.

Figure 1-1940 Connect two connectors



3. Turn the control panel over, and then position the front edge tabs in the slots in the top cover.

Figure 1-1941 Turn the control panel over

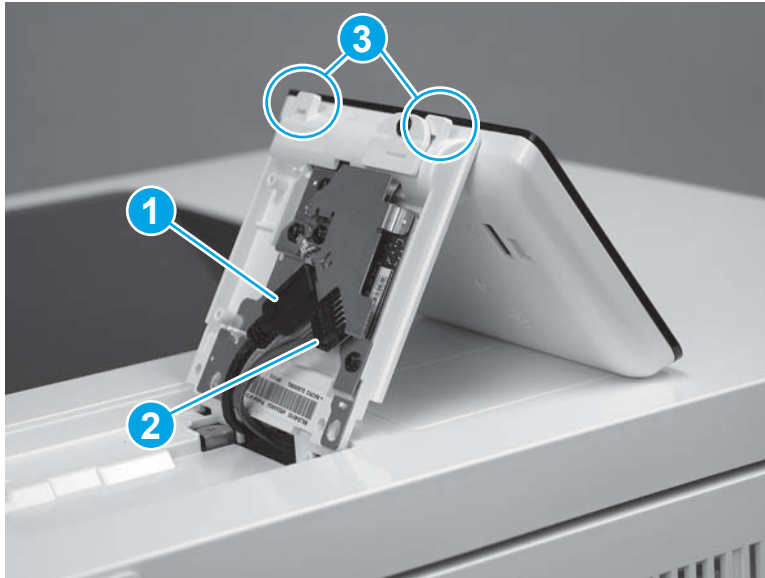
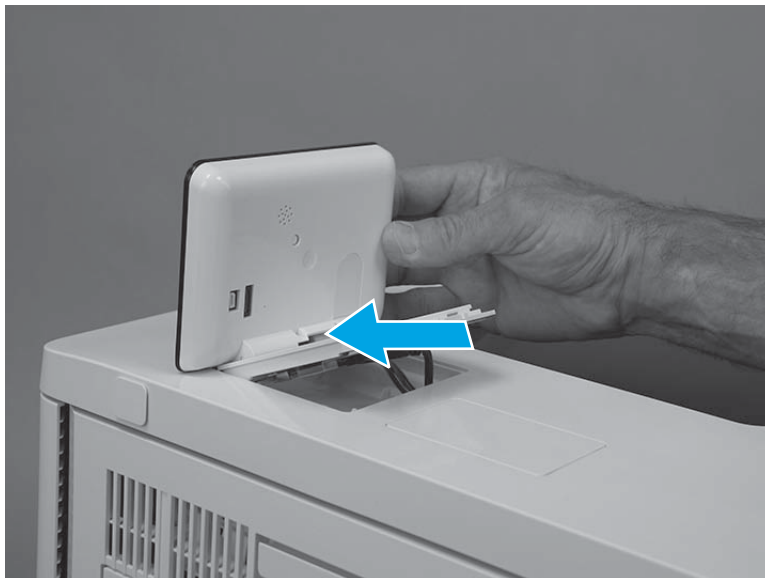

4. Rotate the control-panel base down onto the printer.

Figure 1-1942 Rotate the control-panel base down



5. Use a small Phillips screwdriver to install two screws (callout 1).

Figure 1-1943 Install two screws

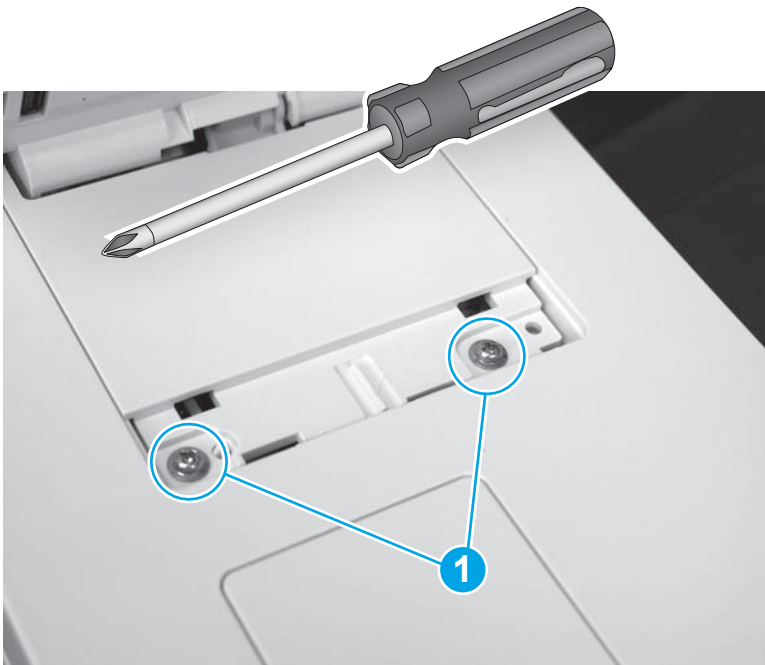

6. Position the screw cover mounting feet into the slots in the top cover (callout 1), and then rotate the cover down (callout 2) to install it.

 **NOTE:** Press down on the cover firmly to make sure that the tabs on the cover (callout 3) snap into place.

Figure 1-1944 Install the cover



Step 41: Install the USB cover

 **NOTE:** This step is for the M552 and M553 models. For the M577 models, skip this step.

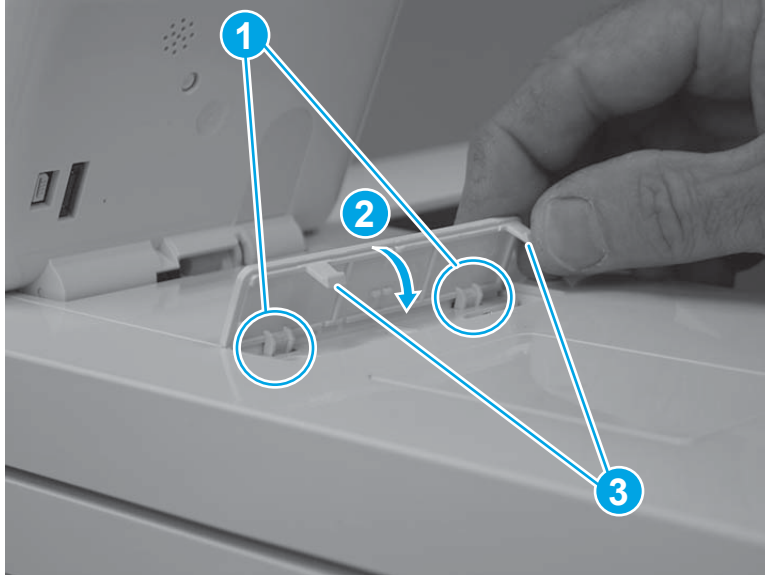
1. Push the cover into the USB port to install it.

Figure 1-1945 Install the cover



2. Make sure that the USB cover is fully seated after installing it.

Figure 1-1946 Check the installation

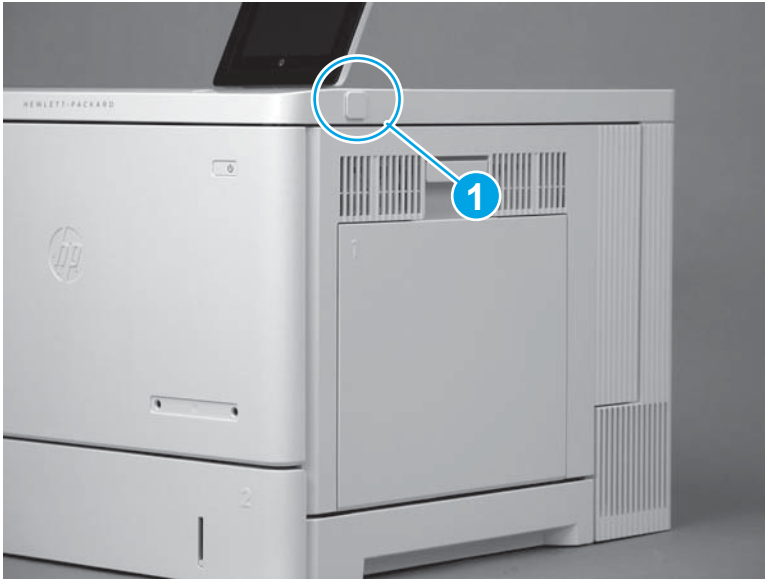

Removal and replacement: Developing disengagement motor (M6)

- [Introduction](#)
- [Step 1: Remove the toner collection unit \(TCU\)](#)
- [Step 2: Remove the formatter cover](#)
- [Step 3: Remove the formatter \(M552 and M553\)](#)
- [Step 4: Remove the hard-disk drive \(HDD\) \(M577\)](#)
- [Step 5: Remove the fax PCA \(M577c/f/z\)](#)
- [Step 6: Remove the formatter \(M577\)](#)
- [Step 7: Remove the rear cover \(M552 and M553\)](#)
- [Step 8: Remove the rear upper cover \(M577\)](#)
- [Step 9: Remove the rear cover \(M577\)](#)
- [Step 10: Remove the left cover](#)
- [Step 11: Remove the formatter case](#)
- [Step 12: Remove the low-voltage power supply \(LVPS\)](#)
- [Step 13: Remove the high-voltage power supply D \(HVPSD\)](#)
- [Step 14: Remove the developing disengagement motor \(M6\)](#)
- [Step 15: Unpack the replacement assembly](#)
- [Step 16: Install the developing disengagement motor \(M6\)](#)
- [Step 17: Install the HVPSD](#)
- [Step 18: Install the LVPS](#)
- [Step 19: Install the formatter case](#)
- [Step 20: Install the left cover](#)
- [Step 21: Install the rear cover \(M577\)](#)
- [Step 22: Install the rear upper cover \(M577\)](#)
- [Step 23: Install the rear cover \(M552 and M553\)](#)
- [Step 24: Install the formatter \(M577\)](#)
- [Step 25: Install the fax PCA \(M577c/f/z\)](#)
- [Step 26: Install the HDD \(M577\)](#)
- [Step 27: Install the formatter \(M552 and M553\)](#)
- [Step 28: Install the formatter cover](#)
- [Step 29: Install the TCU](#)

Introduction

This document provides the procedures to remove and replace the developing disengagement motor (M6).

Before performing service

Turn the printer power off

- Disconnect the power cable.

 **WARNING!** To avoid damage to the printer, turn the printer off, wait 30 seconds, and then remove the power cord before attempting to service the printer.

Use the table below to identify the correct part number for your printer, and then go to <http://h20141.www2.hp.com/hpparts> to order the part.

Developing disengagement motor (M6) part number	
---	--

RK2-6027-000CN

Developing disengagement motor (M6)

Required tools

- #2 Phillips screwdriver with a magnetic tip

After performing service

Make sure that all of the connectors on the HVPSD are fully seated.

Make sure that all of the connectors on the LVPS are fully seated.

Make sure that all of the connectors on the formatter are fully seated.

Make sure that the formatter cover is fully seated, and that the thumbscrews are finger tight after replacing it.

Turn the printer power on

- Connect the power cable.
- Use the power switch to turn the power on.

Post service test

Use the components test to test the motor. For more information, see the printer troubleshooting manual.

Step 1: Remove the toner collection unit (TCU)

1. Open the front door.

Figure 1-1947 Open the front door



2. Open the TCU.

 **NOTE:** The toner collection hatch cover automatically closes when the TCU is opened.

Figure 1-1948 Open the TCU



3. Pull the TCU away from the printer at an angle to remove it.

⚠ CAUTION: Do not open the toner collection hatch cover when handling the TCU. If toner gets on clothing, wipe it off by using a dry cloth and wash the clothes in cold water. Hot water sets toner into fabric.

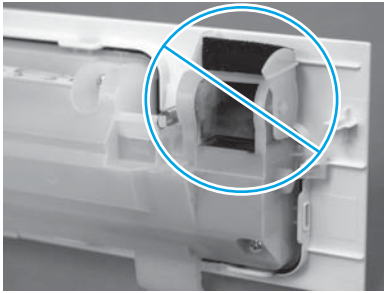
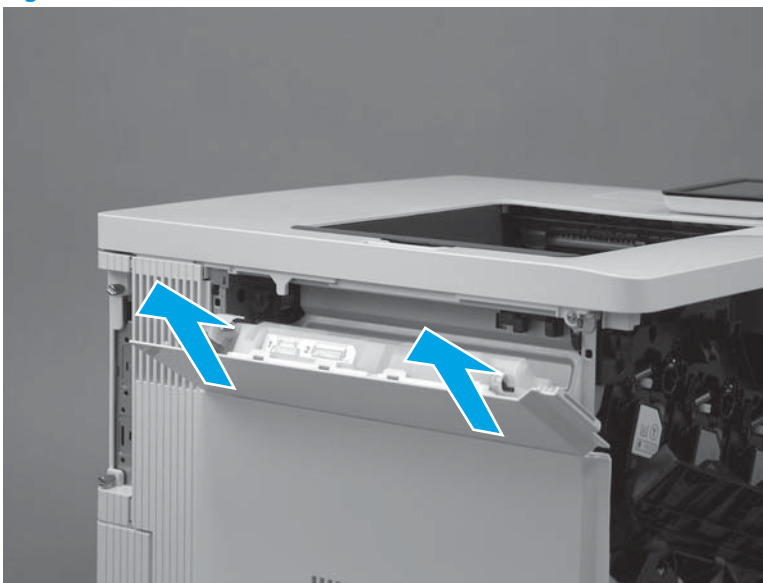

Figure 1-1949 Remove the TCU



Step 2: Remove the formatter cover

1. Locate the formatter cover.

Figure 1-1950 Locate the formatter cover

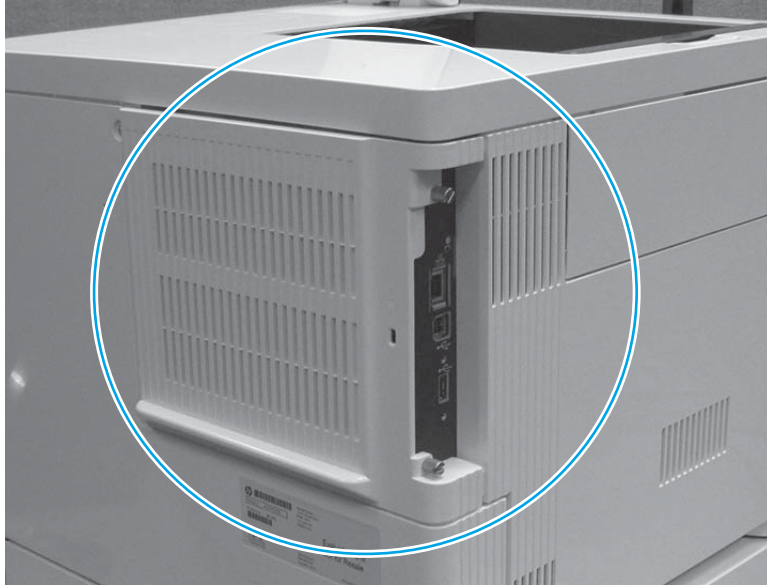

2. Loosen the two thumbscrews (callout 1). Grasp the two thumbscrews, and then slide the cover away from the printer (callout 2) to remove it.

 **TIP:** If needed, use the edge of a coin to turn the thumbscrews.

Figure 1-1951 Loosen the thumbscrews



Step 3: Remove the formatter (M552 and M553)

 **NOTE:** This step is for the M552 and M553 models. For the M577 models, skip this step and go to [Step 4: Remove the hard-disk drive \(HDD\) \(M577\) on page 1117](#).

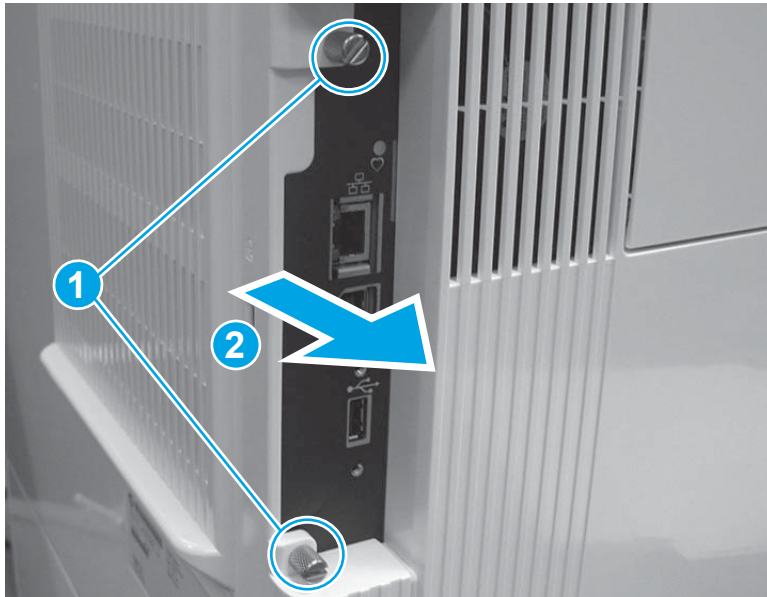
If the optional hard-disk drive (HDD) is installed, it must be removed to gain access to the formatter mounting screws.

Release two tabs along the left edge of the HDD, rotate the left edge away from the product, and then slide the HDD to the left to remove it.

 **CAUTION:**  ESD-sensitive part.

1. Disconnect all of the connectors on the formatter.

The following connectors are empty:

- All models: J1 (this connector is empty unless the optional DIMM is installed)
- M553n/dn and M552dn: J2 (callout 1; this is the touchscreen connector for the M553x model)
- All models: J9 (this connector is empty unless the optional internal USB ports component is installed)
- All models: J18 (this connector is empty unless the optional hard-disk-drive (HDD) is installed)
- All models: J23
- All models: J24
- M553n/dn and M552dn: J25 (this is the wireless connector for the M553x model)
- All models: J57
- All models: J98 (this connector is empty unless the optional trusted platform module (TPM) is installed)

 **IMPORTANT:** The flat-cable connector (callout 2) is a Zero Insertion Force (ZIF) connector that uses a hinged retainer to secure the flat cable. The hinged retainer must be opened to release the flat cable.

Figure 1-1952 Disconnect all connectors



2. Remove four screws (callout 1), and then remove the formatter.

Figure 1-1953 Remove the formatter

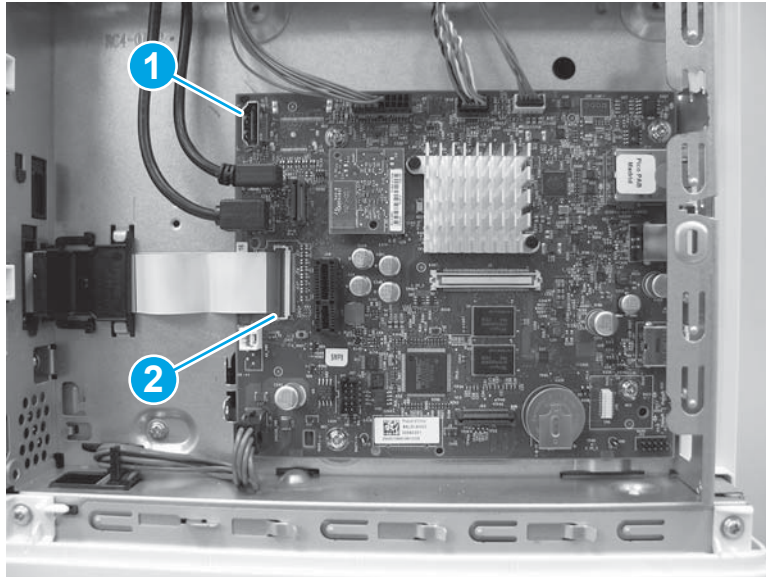
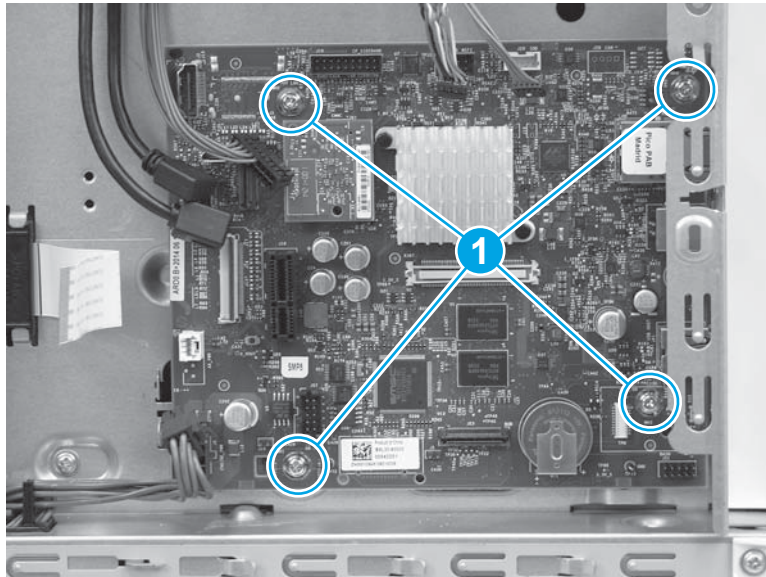

Step 4: Remove the hard-disk drive (HDD) (M577)

 **NOTE:** This step is for the M577 models. For the M552 and M553 models, skip this step and go to [Step 7: Remove the rear cover \(M552 and M553\) on page 1122](#).

 **CAUTION:**  ESD-sensitive part.

1. Release two tabs (callout 1). Hold the tabs in the released position, and then rotate the hard disk drive (HDD) up (callout 2) to release the connector from the formatter.

Figure 1-1954 Release the HDD

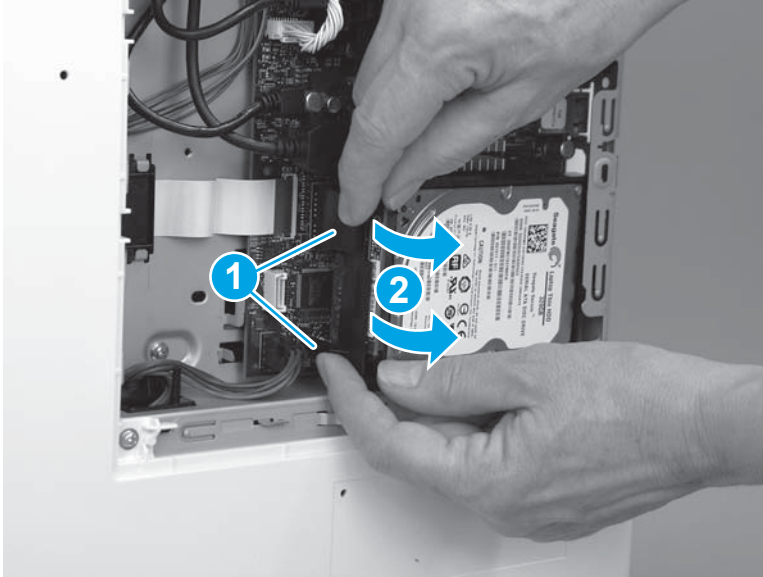

2. Slide the HDD away from the printer to remove it.

Figure 1-1955 Remove the HDD

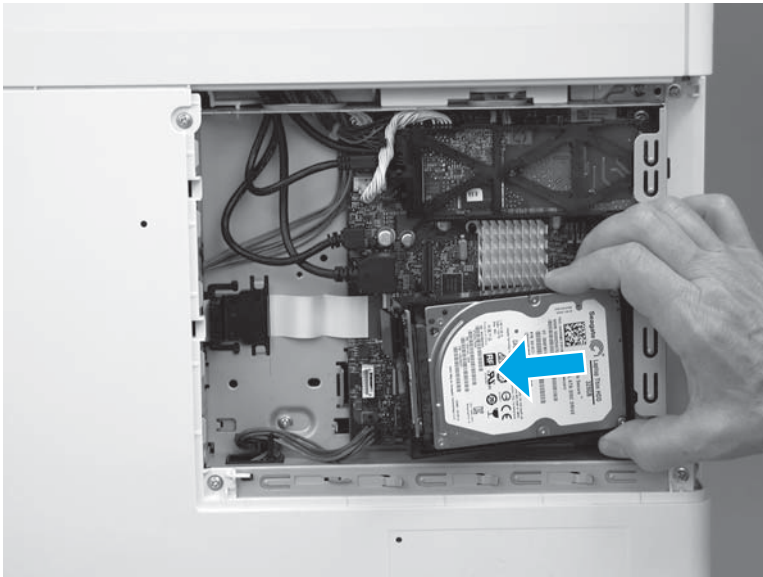

Step 5: Remove the fax PCA (M577c/f/z)

 **NOTE:** This step is for the M577c/f/z models. For the M577n model, skip this step and go to [Step 6: Remove the formatter \(M577\) on page 1120](#).

For the M552 and M553 models, skip this step and go to [Step 7: Remove the rear cover \(M552 and M553\) on page 1122](#).

 **CAUTION:**  ESD-sensitive part.

1. Locate the fax PCA component on the formatter.

Figure 1-1956 Locate the fax PCA

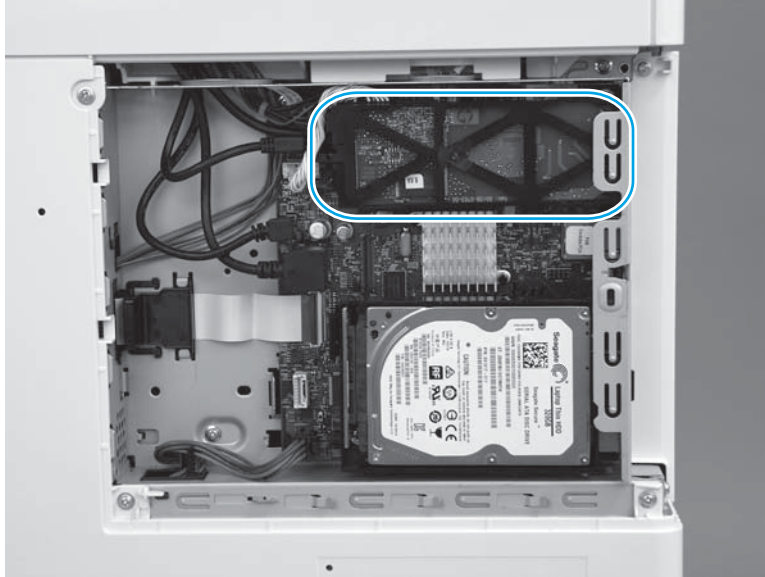

2. Release the connector latch (callout 1), and then pull the connector away from the formatter (callout 2) to disconnect it.

Figure 1-1957 Disconnect one connector

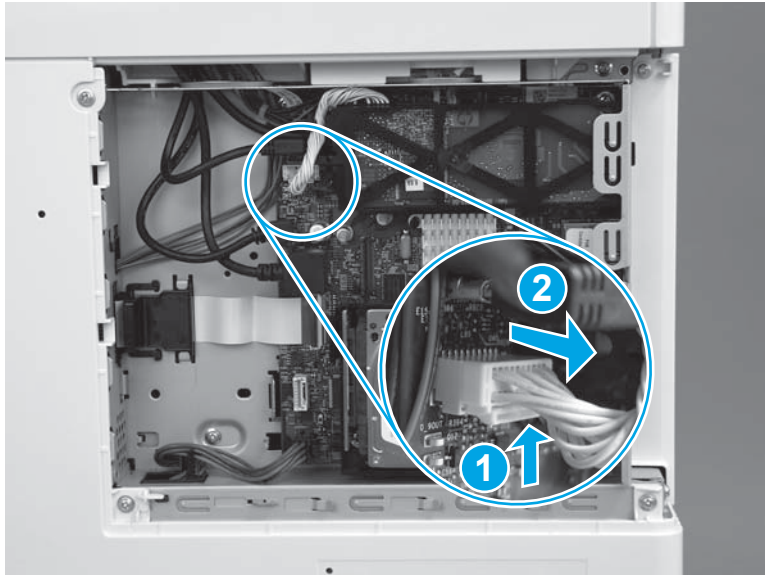

3. Release one retainer (callout 1) by pressing the bracket arms together.

Figure 1-1958 Release one latch

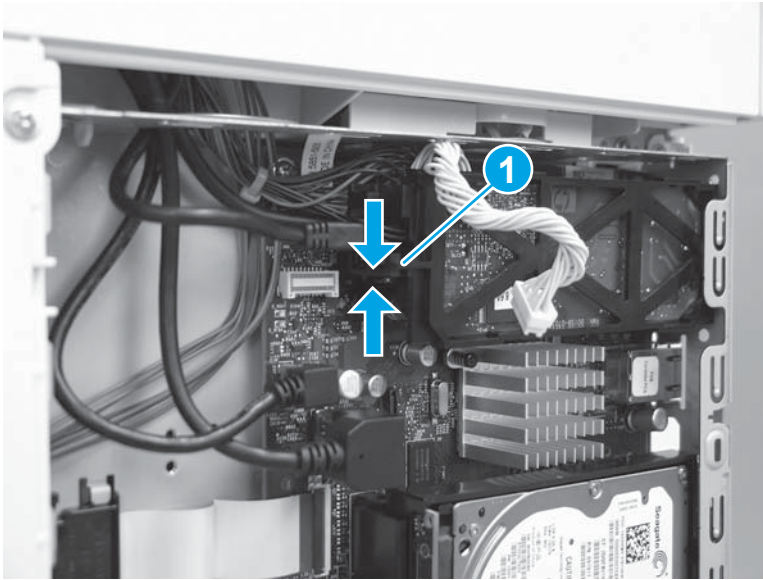

4. Rotate the end of the fax PCA (callout 1) away from the formatter, and then slide the PCA left (callout 2) to remove it.

Figure 1-1959 Remove the fax PCA

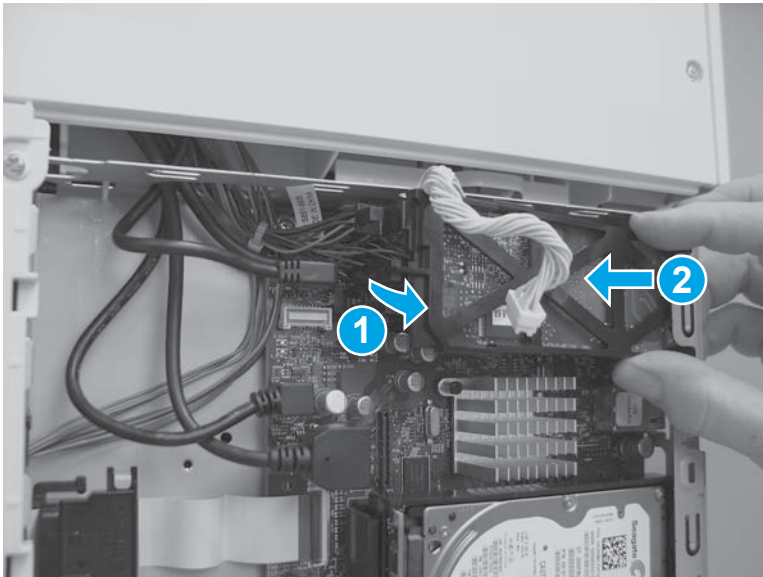

Step 6: Remove the formatter (M577)

 **NOTE:** This step is for the M577 models. For the M552 and M553 models, skip this step and go to [Step 7: Remove the rear cover \(M552 and M553\) on page 1122.](#)

 **CAUTION:**  ESD-sensitive part.

1. Disconnect all of the connectors on the formatter.

The following connectors are empty:

- All models: J1 (this connector is empty unless the optional DIMM is installed)
- All models: J3
- M577dn: J15 (this is the fax connector for the M577f/z/c models)
- All models: J21 (this connector is empty unless the optional internal USB ports component is installed)
- All models: J23
- All models: J24
- All models: J51
- All models: J57
- All models: J97
- All models: J98 (this connector is empty unless the optional trusted platform module (TPM) is installed)

 **IMPORTANT:** The flat-cable connector (callout 1) is a Zero Insertion Force (ZIF) connector that uses a hinged retainer to secure the flat cable. The hinged retainer must be opened to release the flat cable.

Figure 1-1960 Disconnect all connectors



2. Remove four screws (callout 1).

Figure 1-1961 Remove four screws

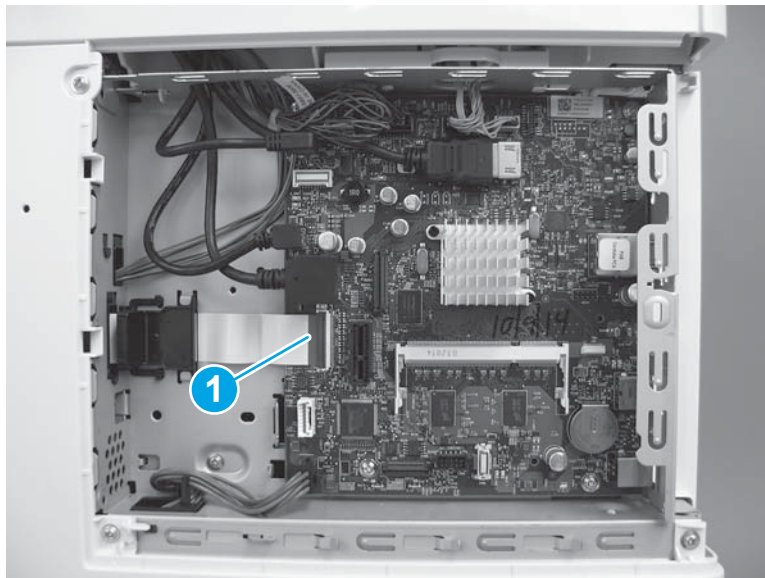
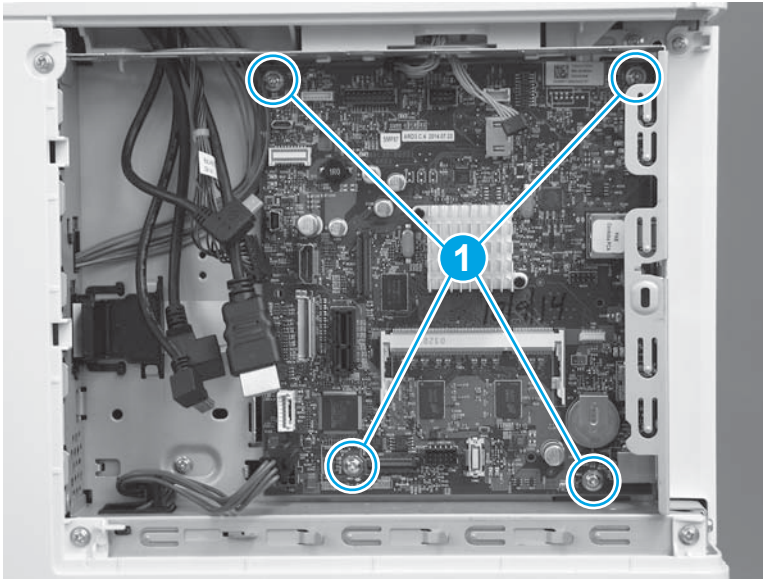

3. Remove the formatter.

Figure 1-1962 Remove the formatter

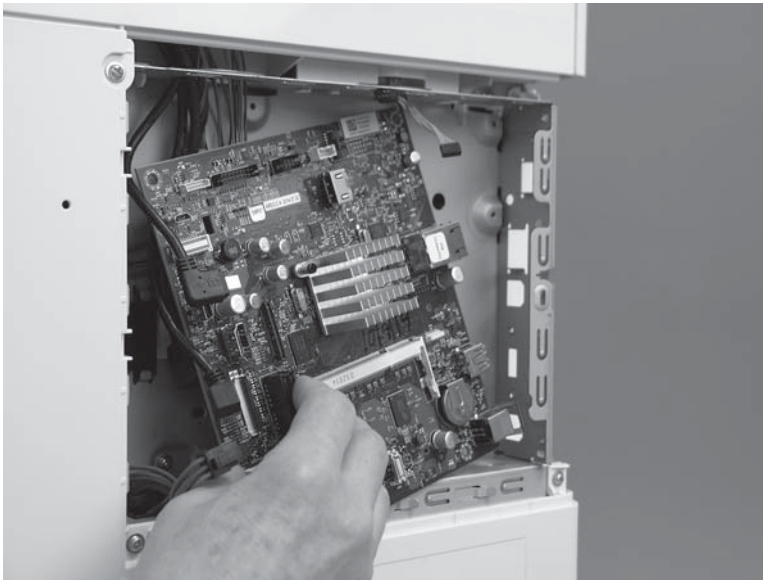

Step 7: Remove the rear cover (M552 and M553)



NOTE: This step is for the M552 and M553 models. For the M577 models, skip this step and go to [Step 8: Remove the rear upper cover \(M577\) on page 1123.](#)

1. Remove four screws (callout 1).

Figure 1-1963 Remove four screws

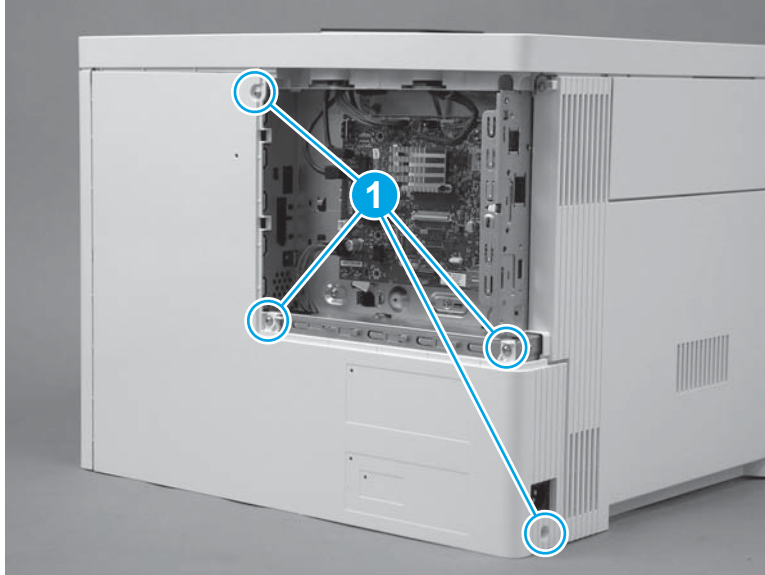

2. Slightly slide the cover to the right (callout 1), rotate the bottom of the cover away from the printer (callout 2), and then pull the top of the cover away from the printer (callout 3) to remove the cover.

Figure 1-1964 Remove the cover

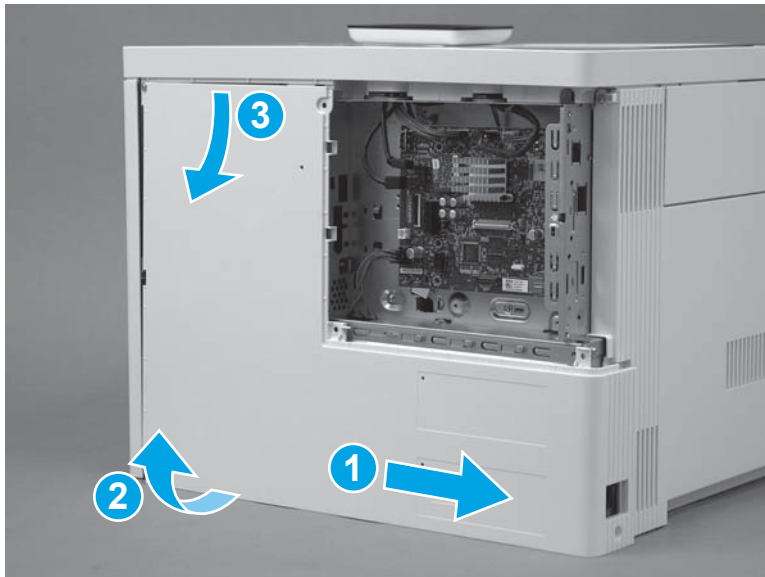

Step 8: Remove the rear upper cover (M577)

 **NOTE:** This step is for the M577 models. For the M552 and M553 models, skip this step and go to [Step 10: Remove the left cover on page 1126](#).

1. Remove two screws (callout 1).

 **Reinstallation tip:** These two screws are self-tapping screws for plastic. When reinstalling them, rotate the screws counterclockwise to align them with the existing thread pattern, and then carefully turn them clockwise to tighten. Do not overtighten. This will prevent stripping the threads inside the screw holes.

Figure 1-1965 Remove two screws



2. Use a small, flat blade screwdriver to release the right edge of the cover.

Figure 1-1966 Release the right edge

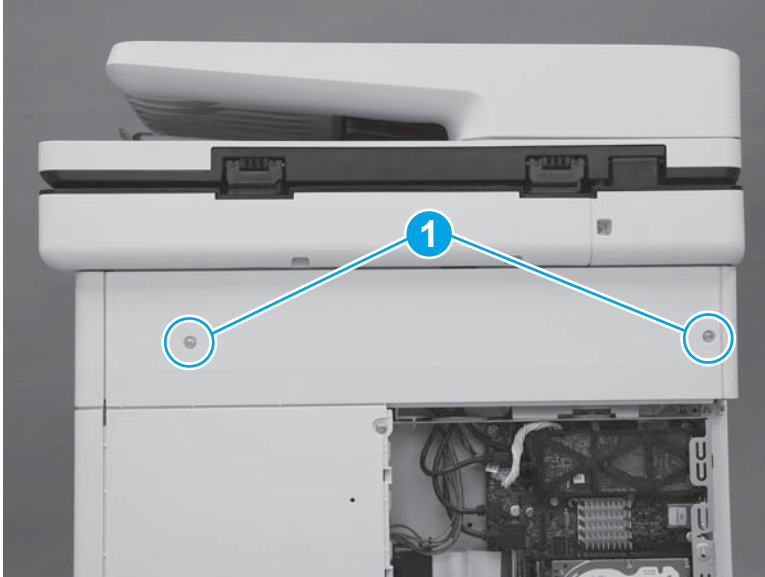
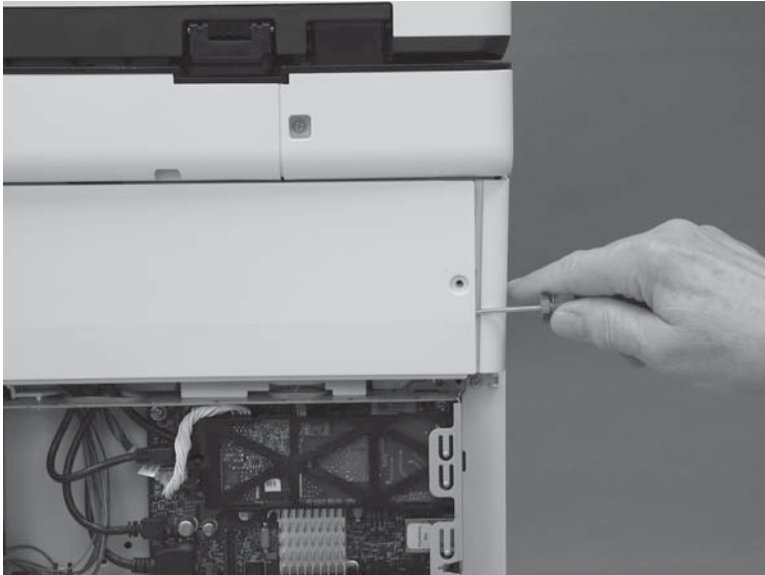

3. Pull the right edge of the cover (callout 1) away from the printer, and then slide the cover to the right (callout 2).

Figure 1-1967 Slide the cover right

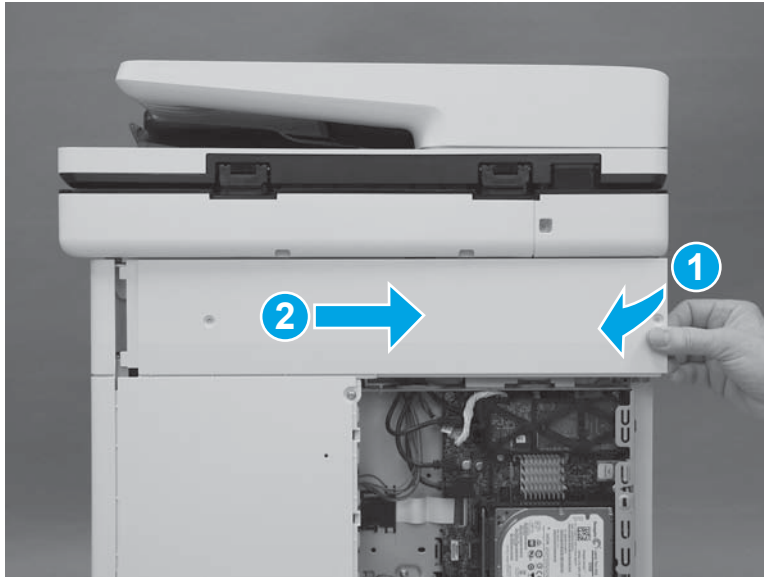

4. Remove the cover.

Figure 1-1968 Remove the cover

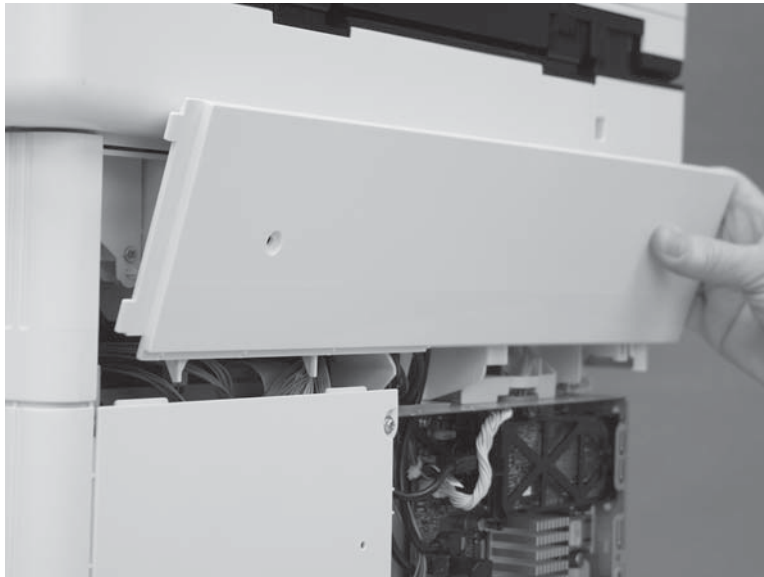

Step 9: Remove the rear cover (M577)

 **NOTE:** This step is for the M577 models. For the M552 and M553 models, skip this step and go to [Step 10: Remove the left cover on page 1126.](#)

1. Remove four screws (callout 1).

Figure 1-1969 Remove four screws

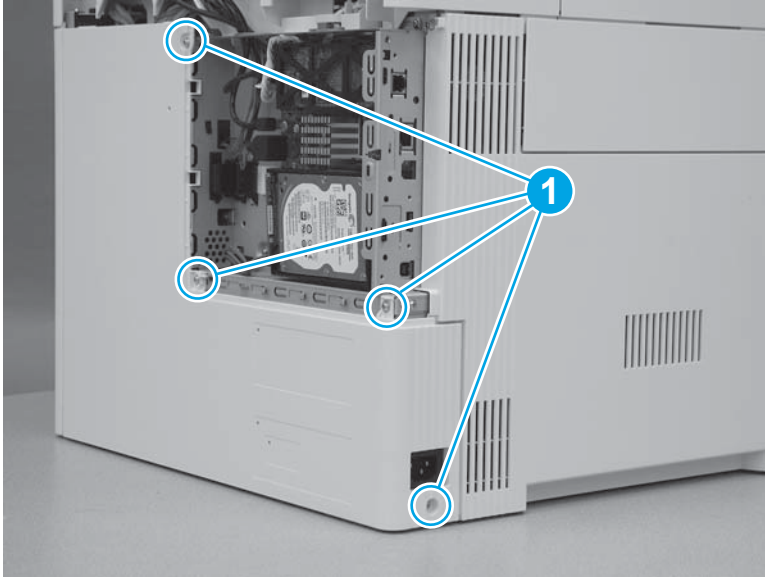

2. Slide the cover to the right to remove it.

Figure 1-1970 Remove the cover

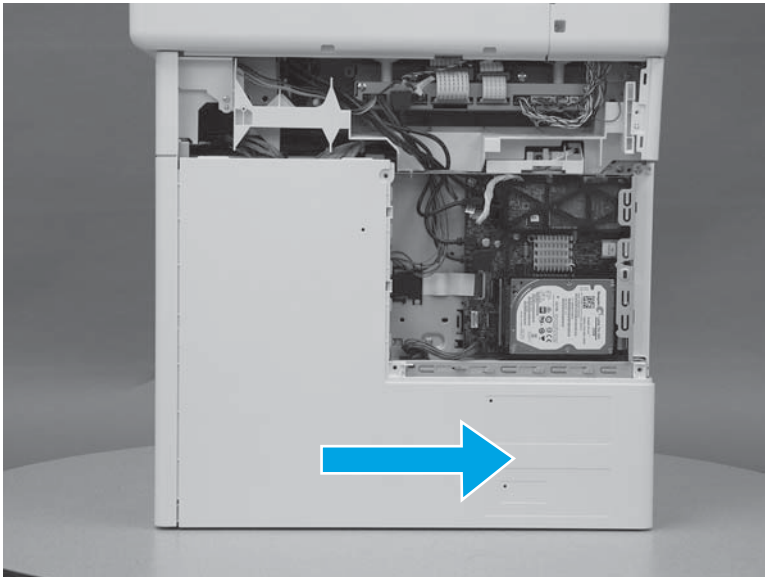

Step 10: Remove the left cover

1. At the left side of the printer, remove one screw (callout 1).

Figure 1-1971 Remove one screw



2. Release one tab (callout 1), rotate the front edge of the cover away from the printer (callout 2), and then slide the cover (callout 3) toward the rear of the printer to release it.

Figure 1-1972 Release the cover

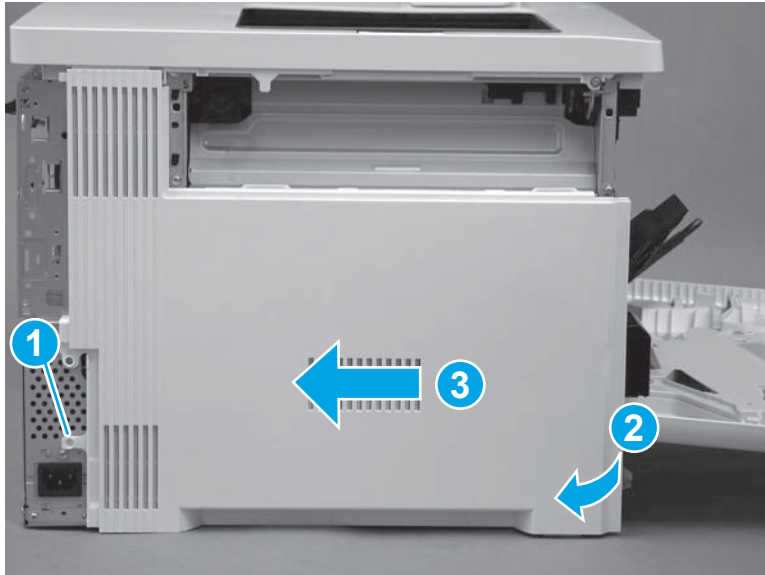

3. Remove the cover.

Figure 1-1973 Remove the cover

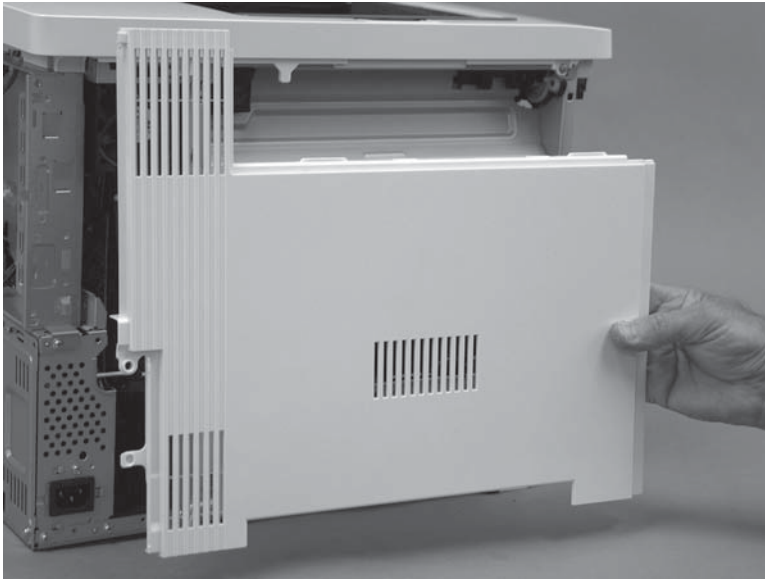

Step 11: Remove the formatter case

1. **M577 only:** Disconnect one connector (callout 1), and then pass the wire harness (callout 2) through two openings in the formatter case (callout 3).

Figure 1-1974 Disconnect one connector

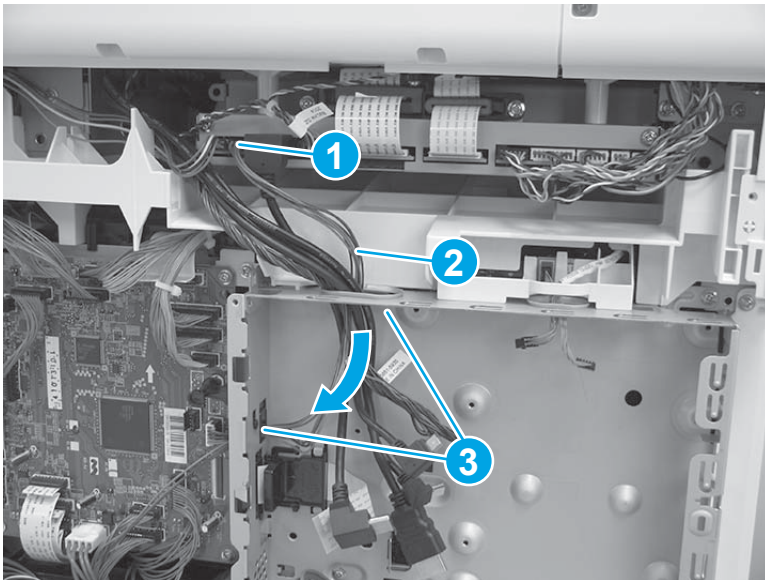

2. Release two tabs (callout 1) on the black plastic bracket. Hold the tabs in the released position, and then slide the bracket (callout 2) to the right to remove it from the formatter case.

Figure 1-1975 Remove the bracket

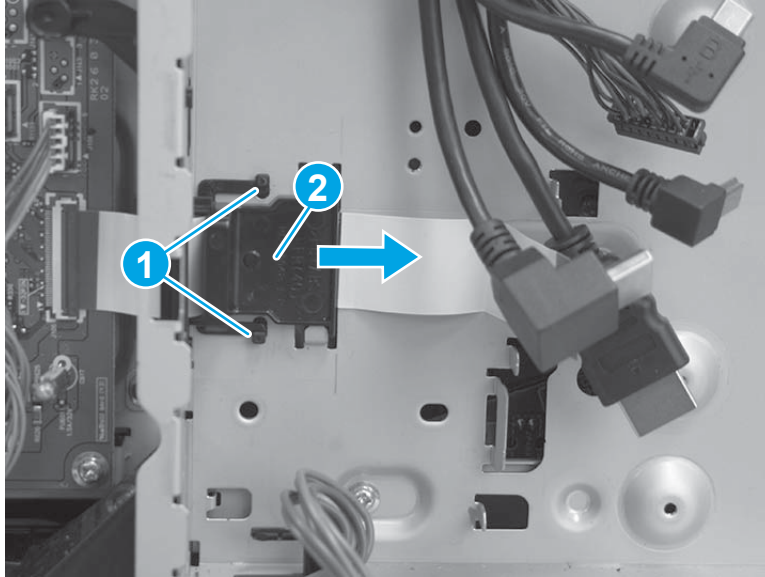

3. Remove two screws (callout 1), and then slide the low-voltage power supply (LVPS) cover to the right to remove it.

Figure 1-1976 Remove the LVPS cover

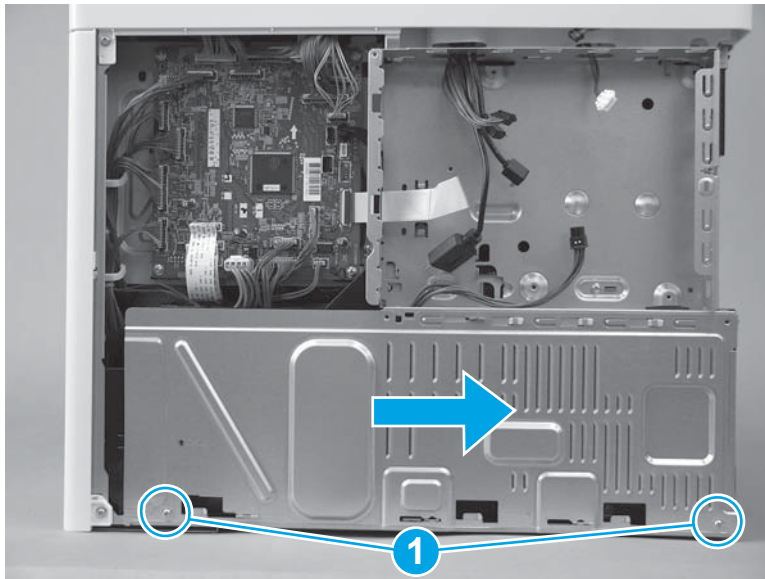

4. Pass two wire harnesses and one flat cable (callout 1) through the opening in the formatter case, and then release one wire harness from the retainer (callout 2).

⚠ CAUTION: The flat cable might be attached to the formatter case with double-sided tape. Make sure that this tape is released, so that the flat cable is not damaged when the formatter case is removed.

Figure 1-1977 Release wire harnesses and flat cable

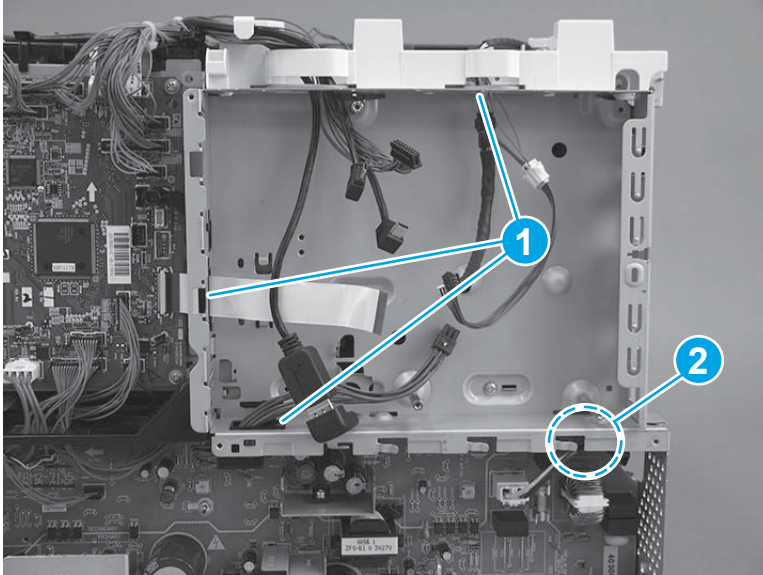

5. Remove six screws (callout 1).

Figure 1-1978 Remove six screws

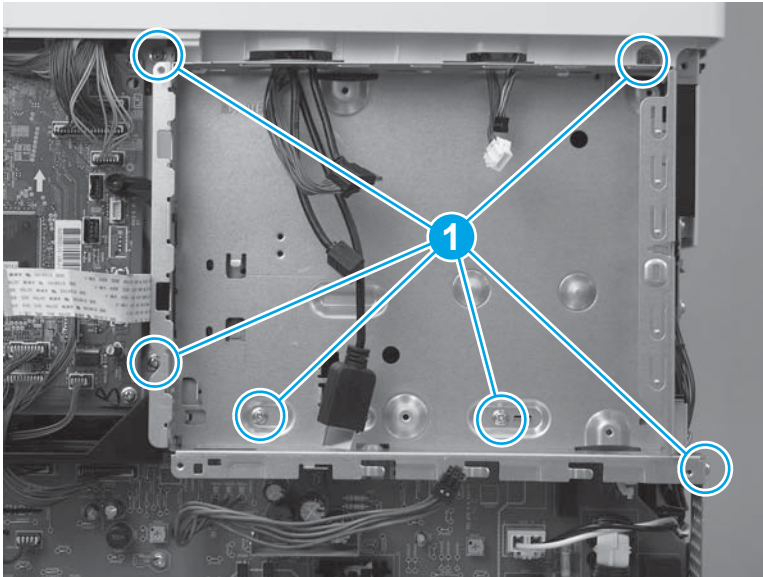

6. Rotate the bottom of the formatter case away from the printer (callout 1), and then pull it down (callout 2) to release it.

Figure 1-1979 Release the formatter case

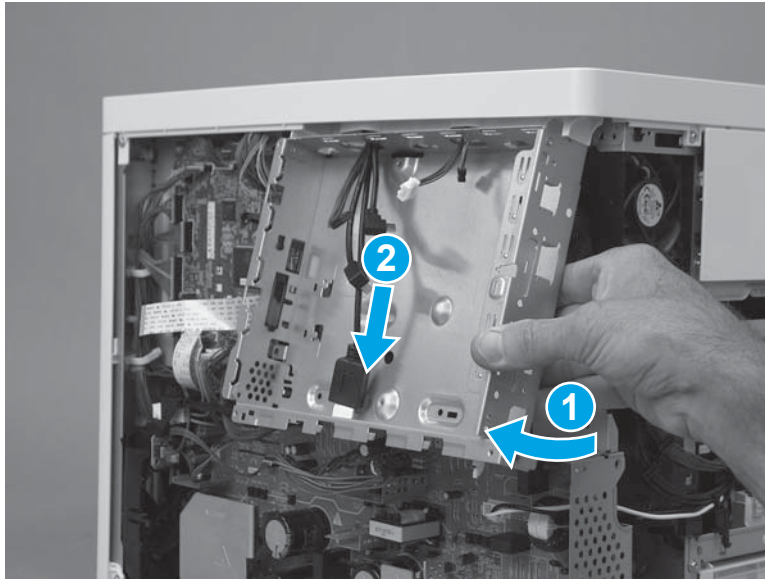

7. Pass the wire harnesses through the opening in the formatter case to remove it.

 **IMPORTANT:** If the formatter case is removed so that it can be replaced, make sure to transfer the memory PCA (island of data) and plastic bracket (callout 1) to the replacement case.

Figure 1-1980 Remove the formatter case



Step 12: Remove the low-voltage power supply (LVPS)

 **CAUTION:**  ESD-sensitive part.

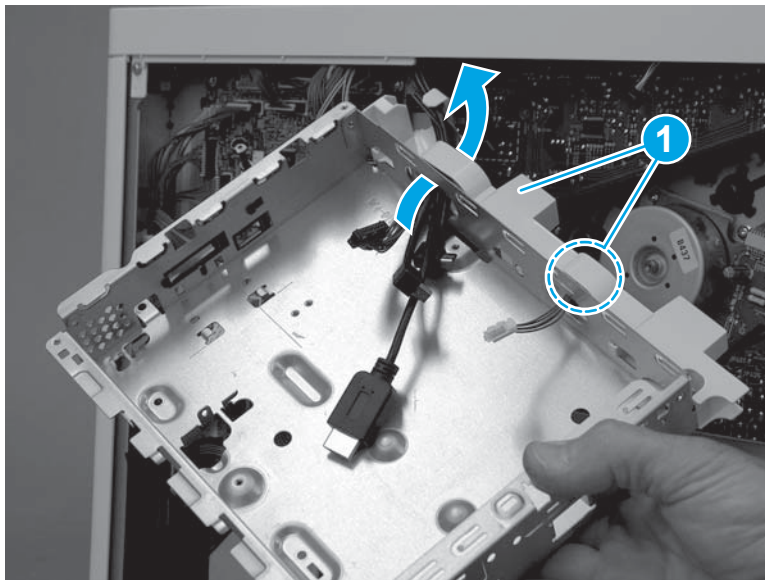
1. Disconnect one wire harness (callout 1), and then pass the wire harness through the opening (callout 2) in the chassis.

Figure 1-1981 Disconnect one wire harness

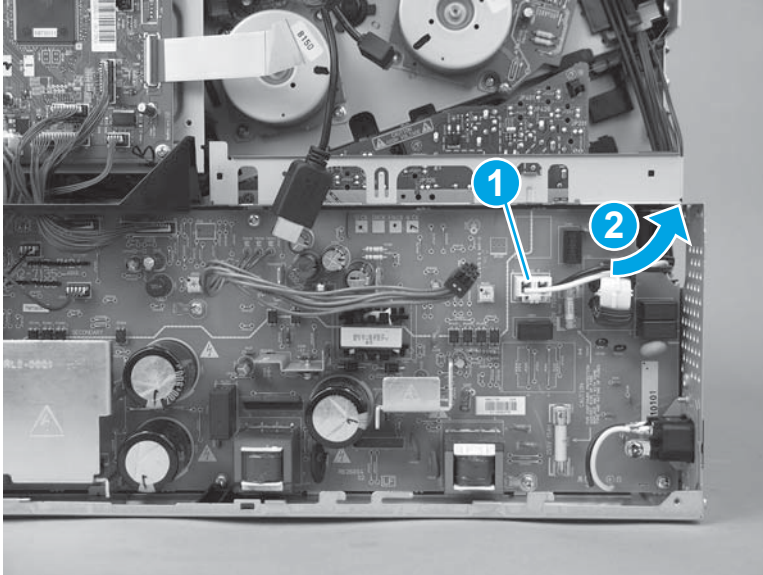

2. Disconnect three connectors on the DC controller (callout 1), and then disconnect four connectors (callout 2) on the LVPS.

Figure 1-1982 Disconnect seven connectors

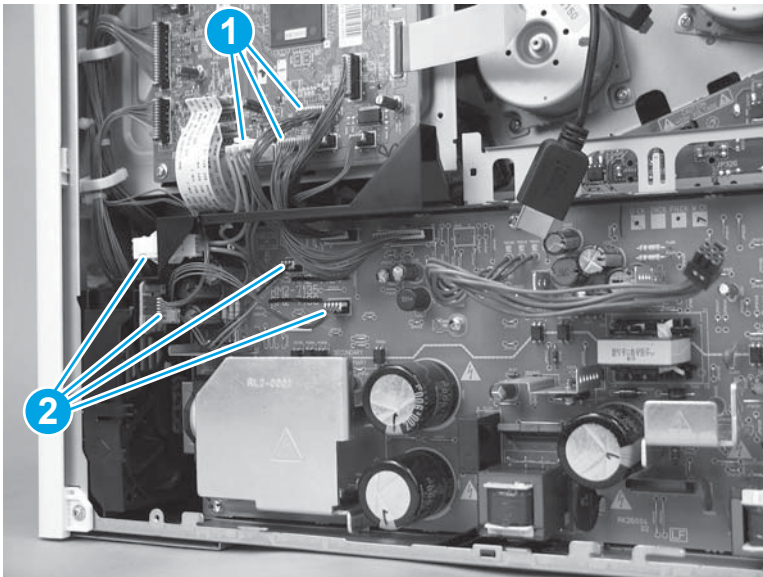

3. Pass the wire harnesses from the DC controller to the LVPS through the opening in the chassis (callout 1), and then release the wire harnesses from the retainer (callout 2).

Figure 1-1983 Pass the wire harnesses through the opening

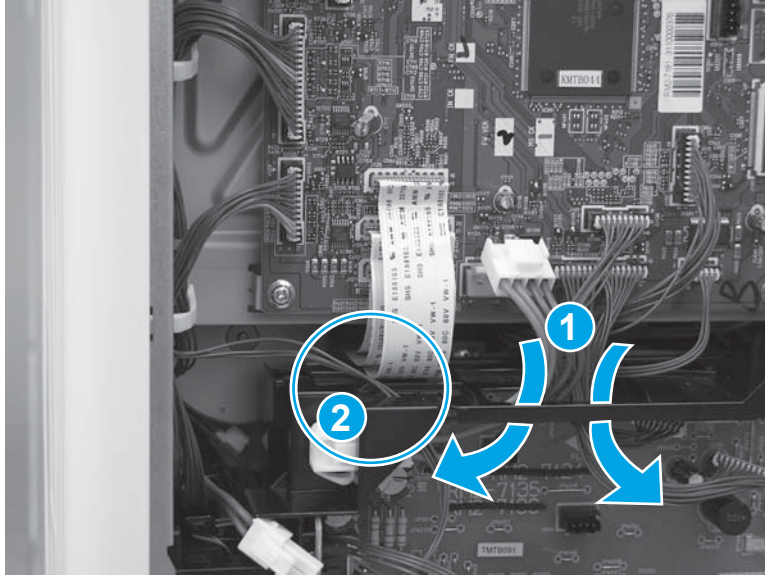

4. Remove three screws (callout 1).

Figure 1-1984 Remove three screws

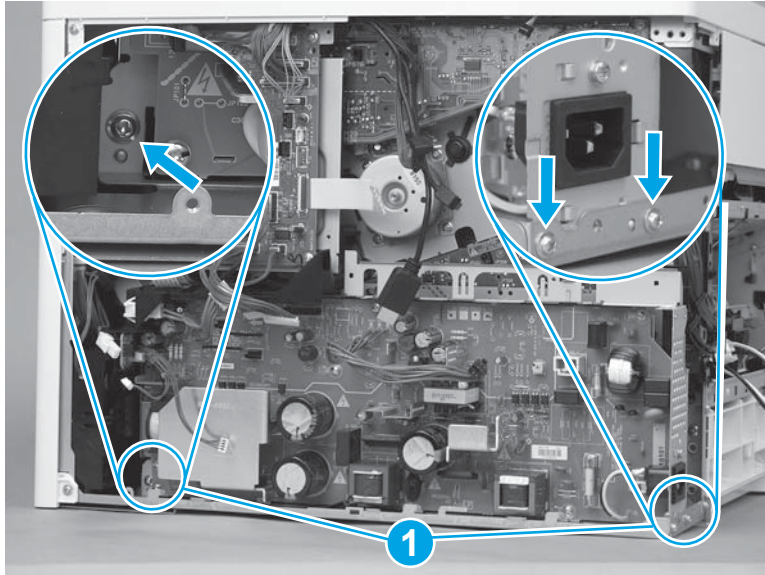

5. Rotate the top of the LVPS away from the printer (callout 1), and then slide it up and out (callout 2) of the printer to remove it.

Figure 1-1985 Remove the LVPS

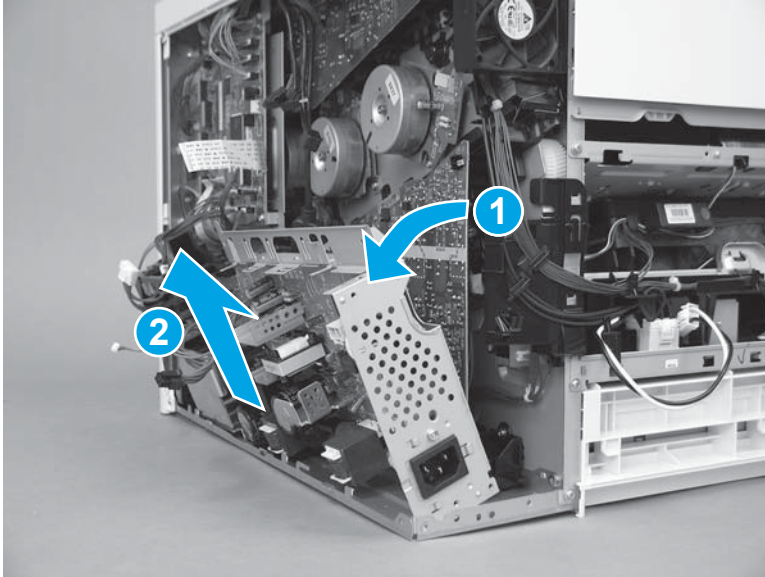

Step 13: Remove the high-voltage power supply D (HVPSD)

 **CAUTION:**  ESD-sensitive part.

1. Disconnect one flat cable (callout 1) on the DC controller.

Figure 1-1986 Disconnect one flat cable

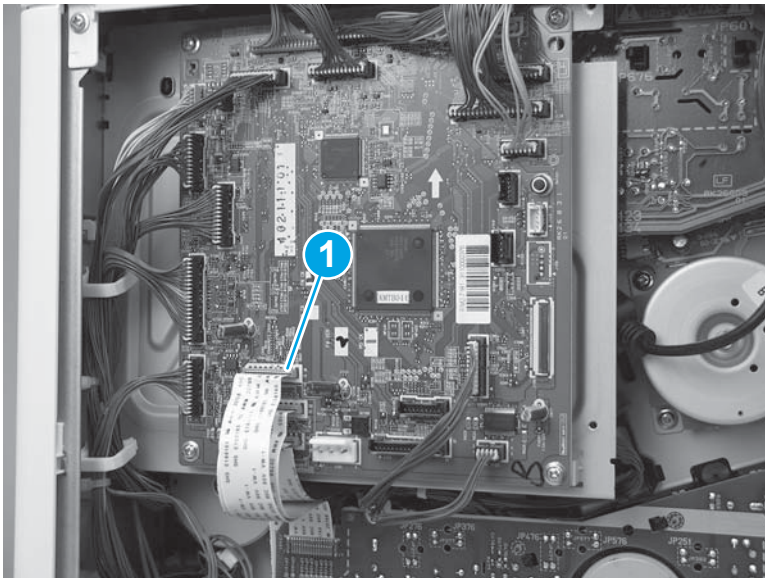

2. Remove two screws (callout 1), and then remove one self tapping screw (callout 2) on the HVPSD.

Figure 1-1987 Remove three screws

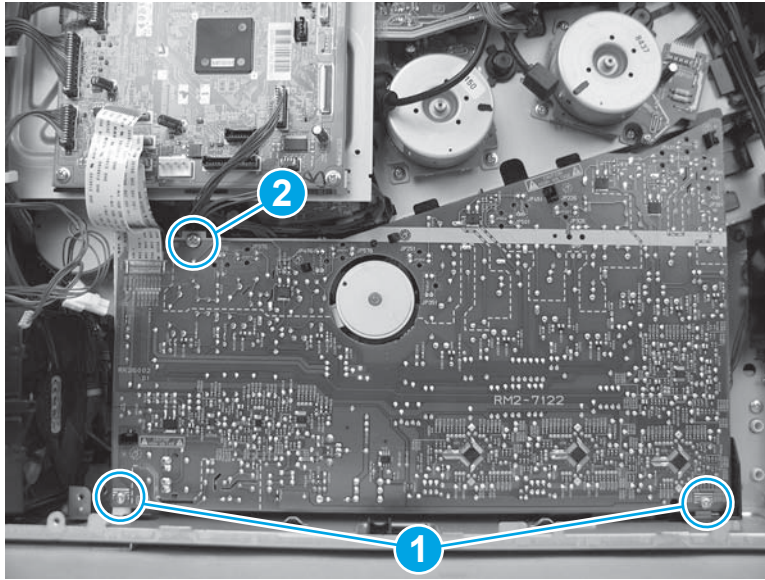

3. Release five tabs (callout 1), and then remove the HVPSD (callout 2).

Figure 1-1988 Remove the HVPSD

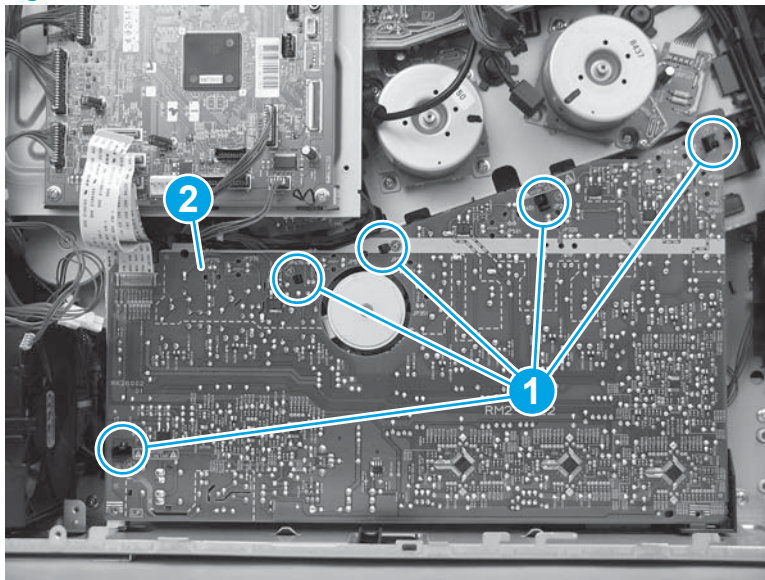

Step 14: Remove the developing disengagement motor (M6)

- ▲ Disconnect one connector (callout 1), remove two screws (callout 2), and then remove the motor.

Figure 1-1989 Remove the motor

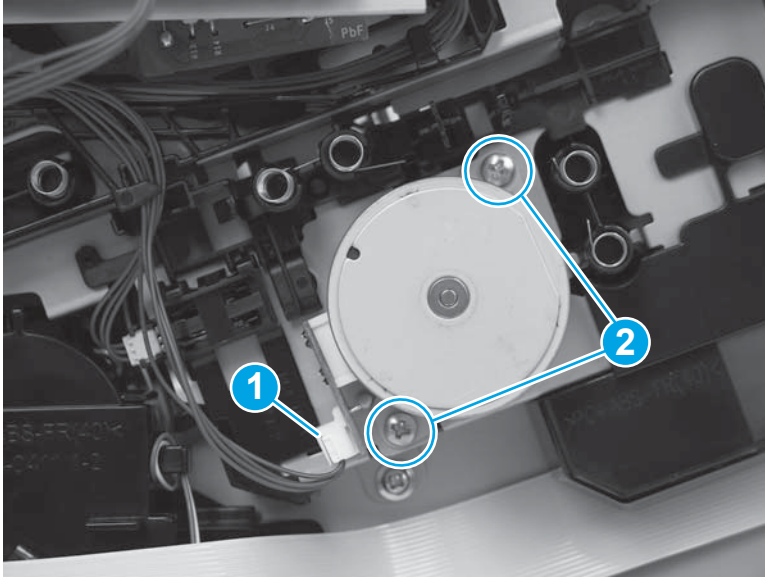

Step 15: Unpack the replacement assembly

Unpack the replacement assembly from the packaging.

For complete information on HP's recycling programs, go to [Product return and recycling](#).

 **NOTE:** HP recommends responsible disposal of the defective assembly.

Figure 1-1990 Recycle and unpack

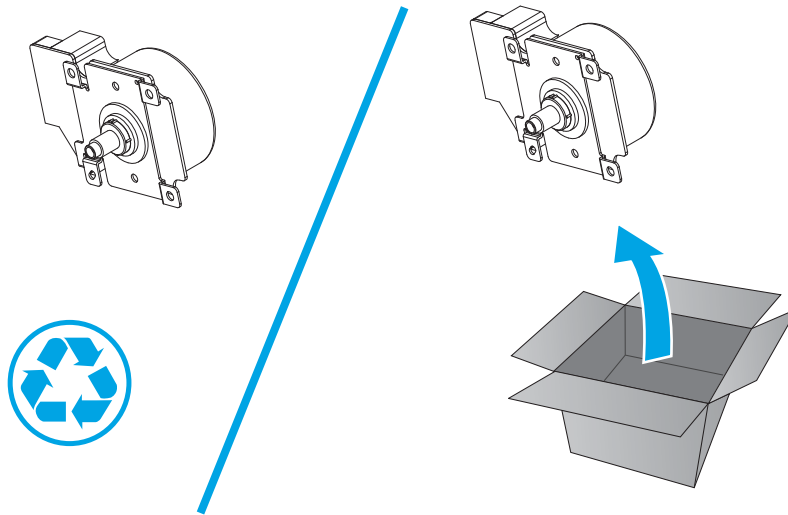

Step 16: Install the developing disengagement motor (M6)

- ▲ Position the motor on the printer, install two screws (callout 1), and then connect one connector (callout 2).

Figure 1-1991 Install the motor

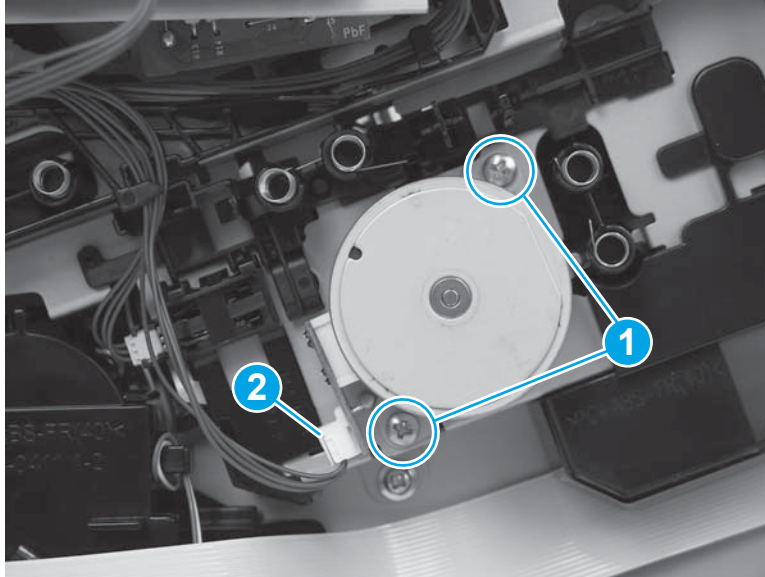

Step 17: Install the HVPSD

CAUTION:  ESD-sensitive part.

1. Position the bottom right corner of the HVPSD (callout 1) behind the black tab, and then rotate it up and onto the printer (callout 2).

Figure 1-1992 Install the HVPSD

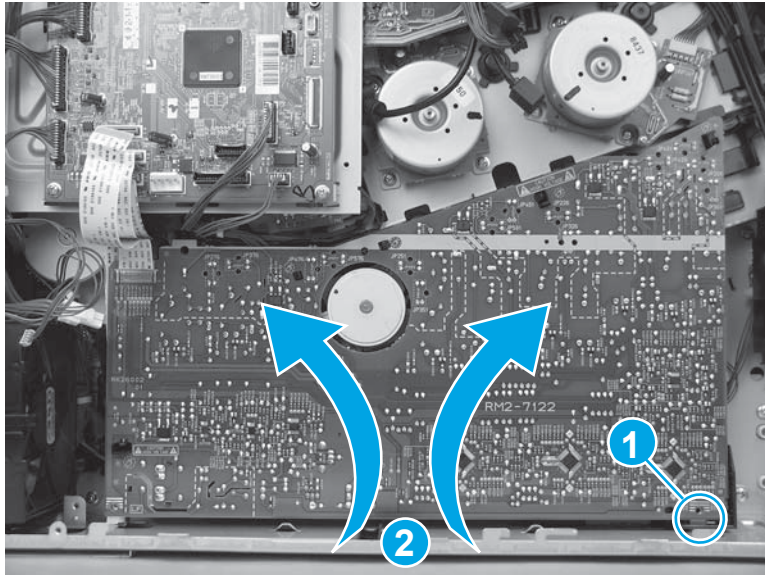

2. Press it onto five tabs (callout 2).

 **IMPORTANT:** Make sure that all five tabs snap into place.

Figure 1-1993 Press the tabs



3. Install two screws (callout 1), and then install one self tapping screw (callout 2) on the HVPSD.

Figure 1-1994 Install three screws

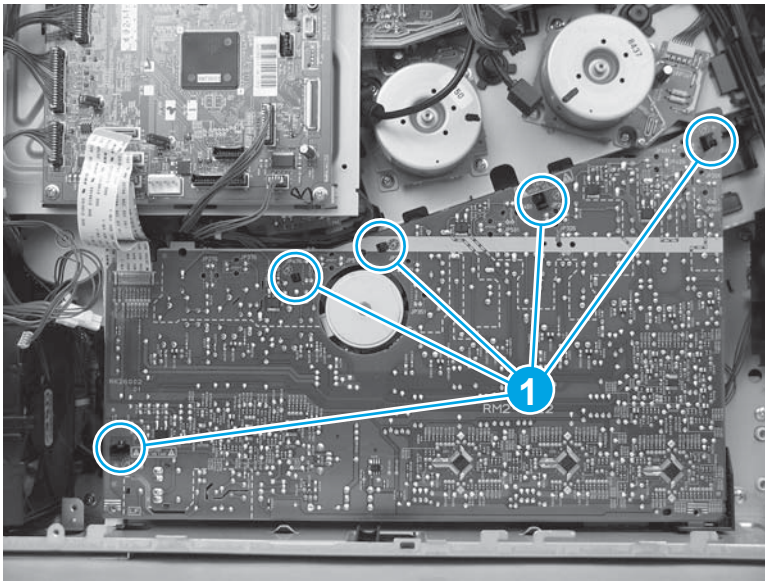
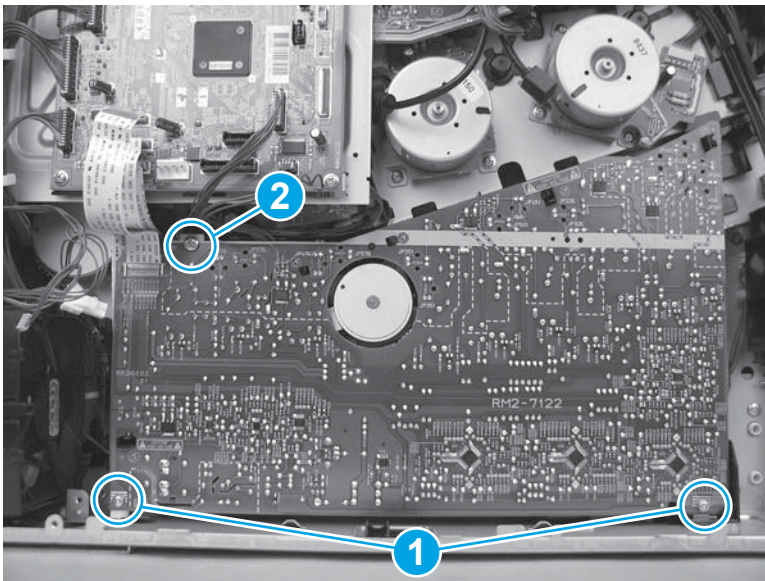

4. Connect one flat cable (callout 1) on the DC controller.

Figure 1-1995 Connect one flat cable

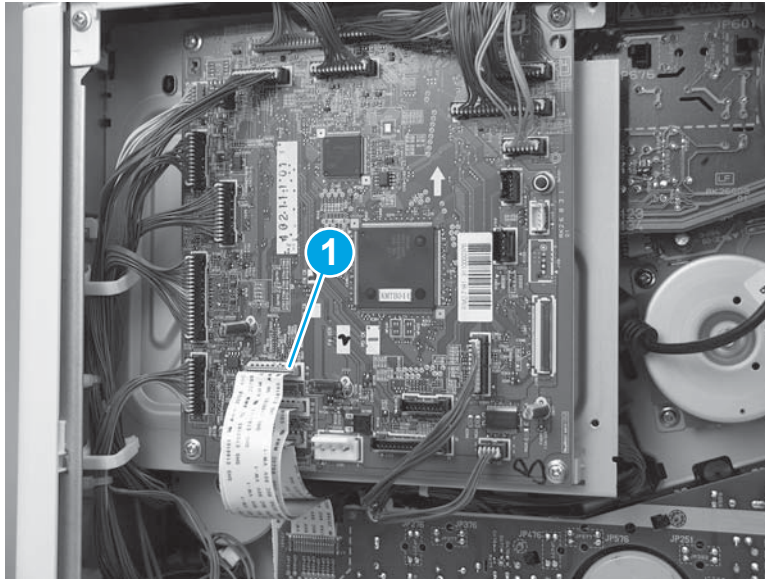

Step 18: Install the LVPS

CAUTION:  ESD-sensitive part.

1. Position the bottom of the LVPS in the printer (callout 1) at a slight angle, and then rotate the top of it into the printer (callout 2) to install it.

Figure 1-1996 Install the LVPS

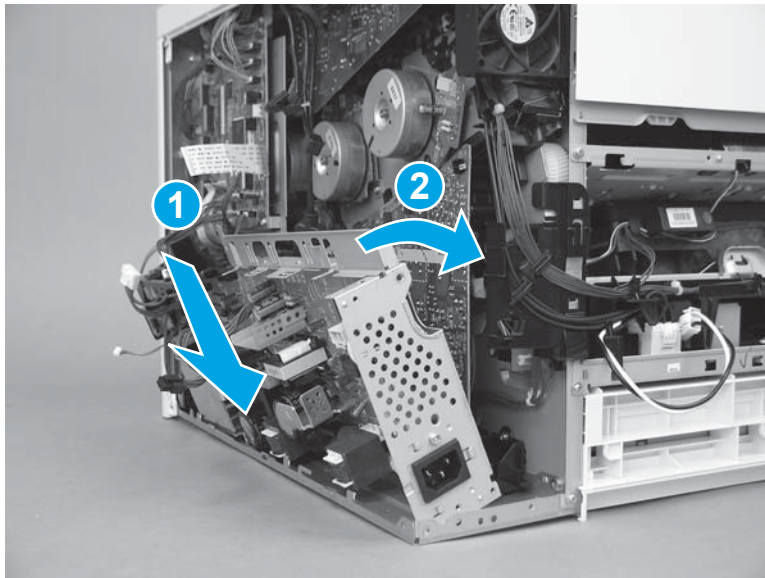

2. Install three screws (callout 1).

Figure 1-1997 Install three screws

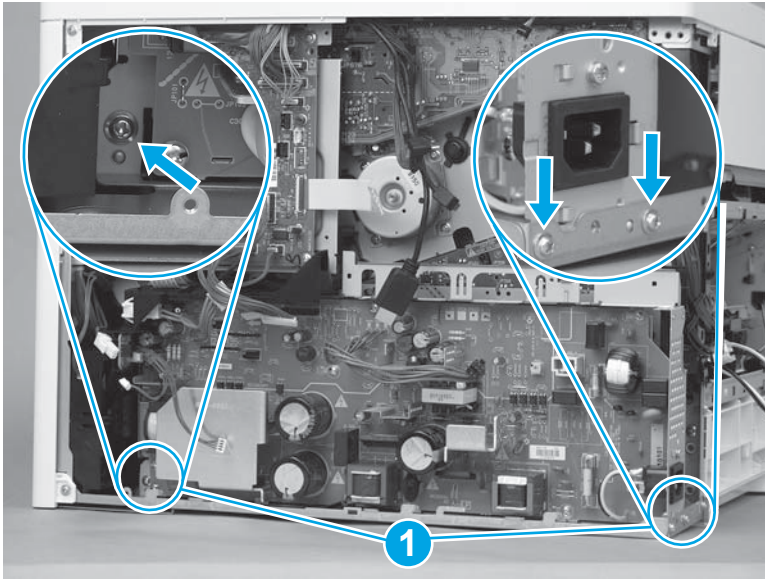

3. Pass the wire harnesses from the DC controller to the LVPS through the opening in the chassis (callout 1), and then install the wire harnesses in the retainer (callout 2).

Figure 1-1998 Pass the wire harnesses through the opening

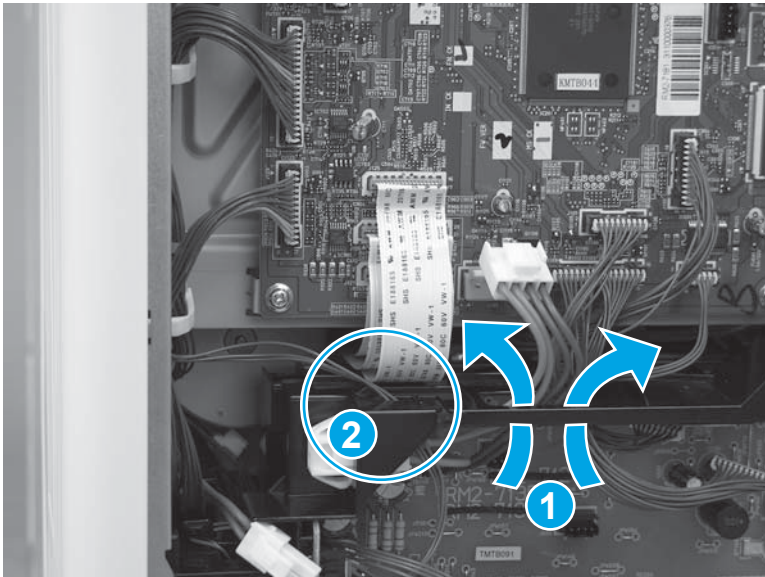

4. Connect three connectors on the DC controller (callout 1), and then connect four connectors (callout 2) on the LVPS.

Figure 1-1999 Connect seven connectors

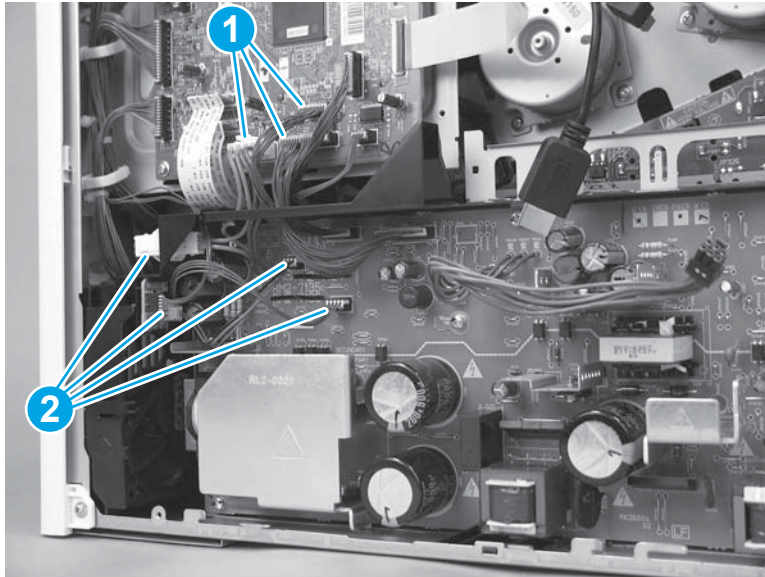

5. Pass the wire harness through the opening (callout 1) in the chassis, and then connect one wire harness (callout 2).

Figure 1-2000 Connect one wire harness

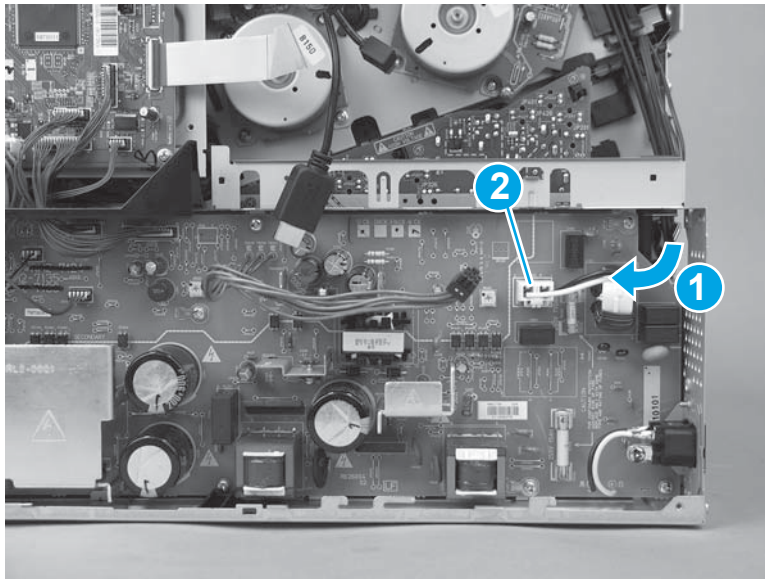

Step 19: Install the formatter case

1. Pass the wire harnesses through the opening in the formatter case.

Figure 1-2001 Pass the wire harnesses through the opening

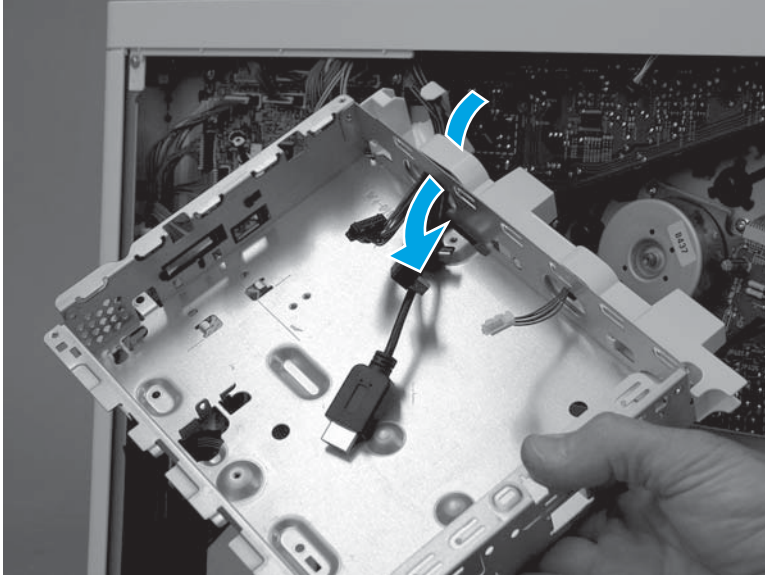

2. Position the top of the formatter case on the printer (callout 1), and then rotate the bottom of the case (callout 2) into the printer.

Figure 1-2002 Install the formatter case

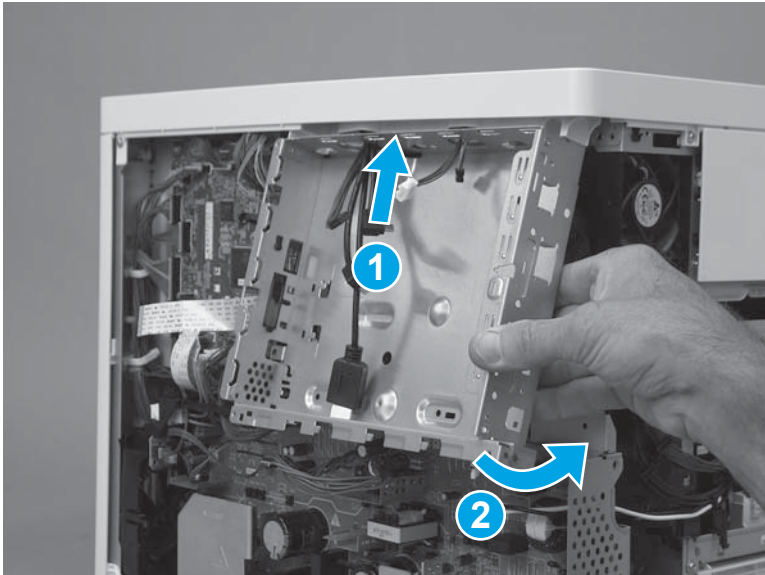

3. Install six screws (callout 1).

Figure 1-2003 Install six screws

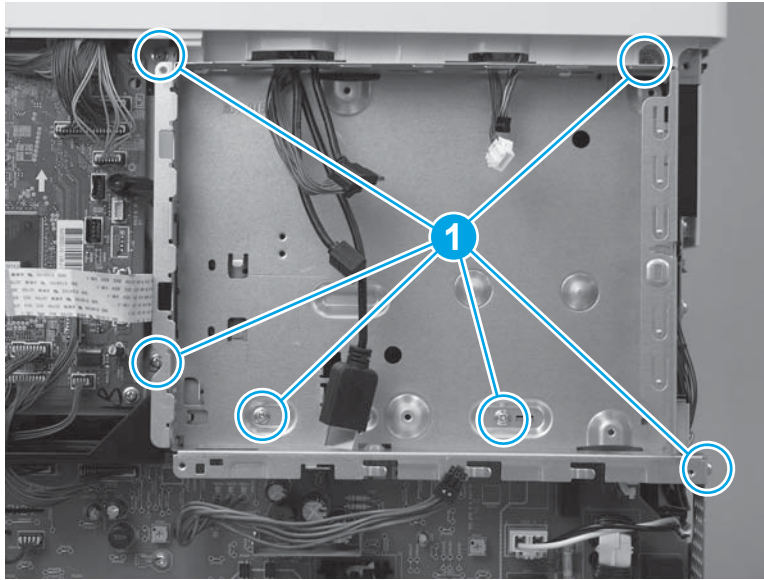

4. Pass two wire harnesses and one flat cable (callout 1) through the opening in the formatter case, and then install one wire harness in the retainer (callout 2).

 **IMPORTANT:** Make sure that the flat cable is securely fastened to the DC controller, and was not dislodged when the formatter case was removed.

Figure 1-2004 Install wire harnesses and flat cable



5. Position the LVPS cover on the printer, slide the cover to the left to install it, and then install two screws (callout 1).

Figure 1-2005 Install the LVPS cover

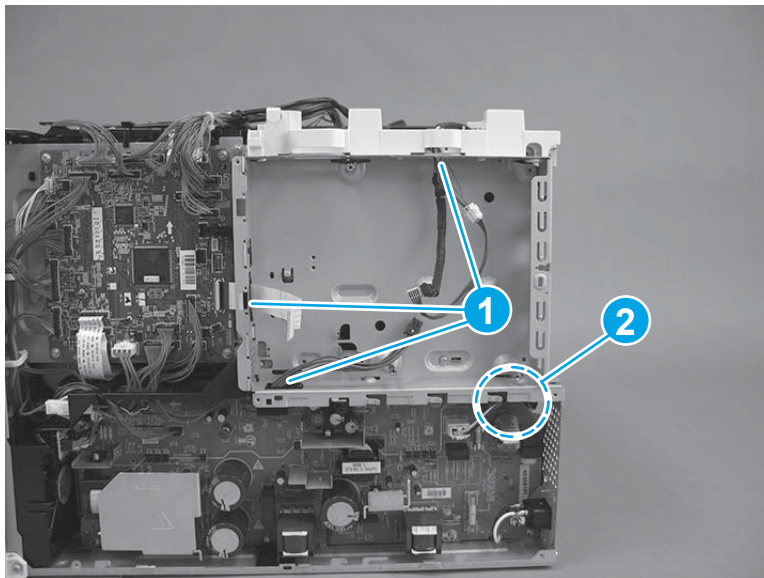
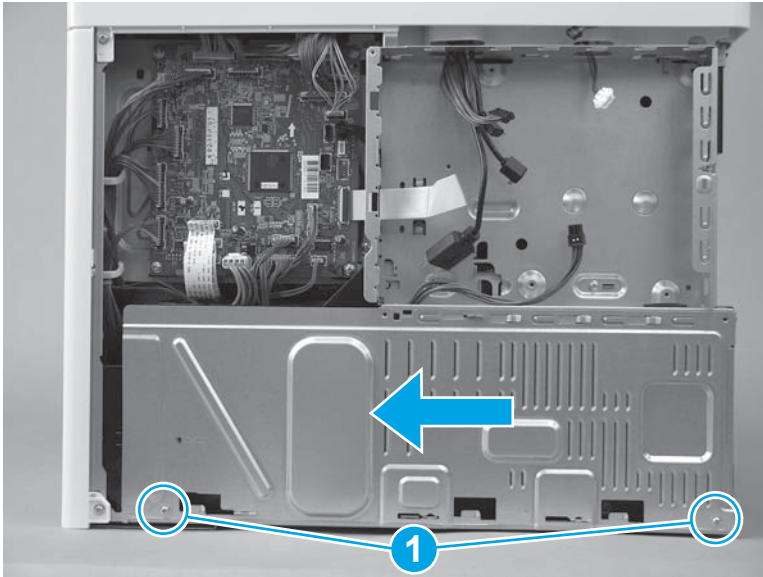

6. If no tape is affixed to the back of the flat cable, skip this step. If double-sided tape is affixed to the back of the flat cable, align the line (callout 1) on the cable with the edge (callout 2) of the opening in the sheet metal. Press to attach the flat cable to the formatter case.

Figure 1-2006 Attach the flat cable

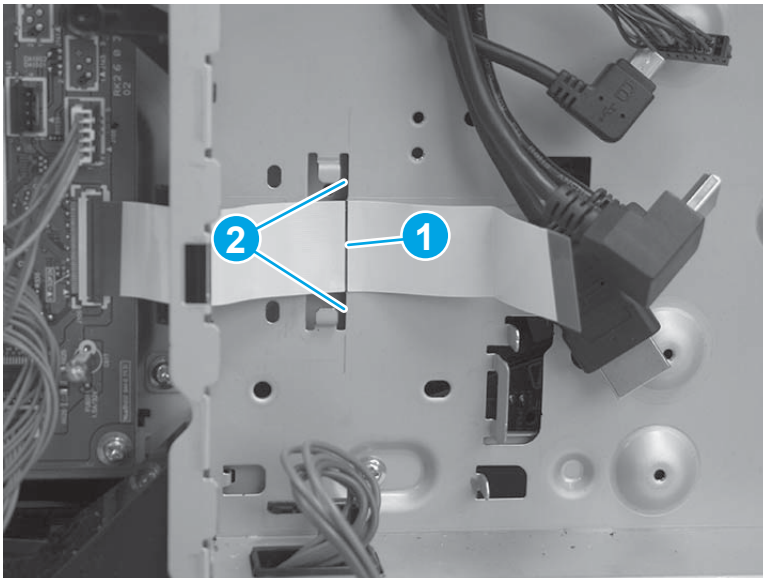

7. Position the bracket over the flat cable, and then slide the bracket to the left to install it. Make sure that the edges of the bracket fit under the sheet metal tabs (callout 1) on the formatter case and that the tabs (callout 2) snap into place.

Figure 1-2007 Position the bracket

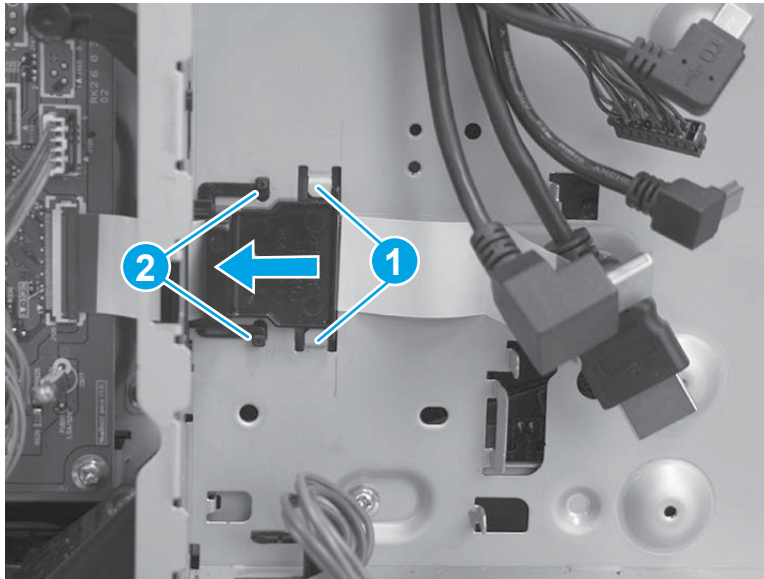

8. **M577 only:** Pass the wire harness (callout 1) through the openings in the formatter case (callout 2), and then connect one connector (callout 3).

Figure 1-2008 Connect one connector

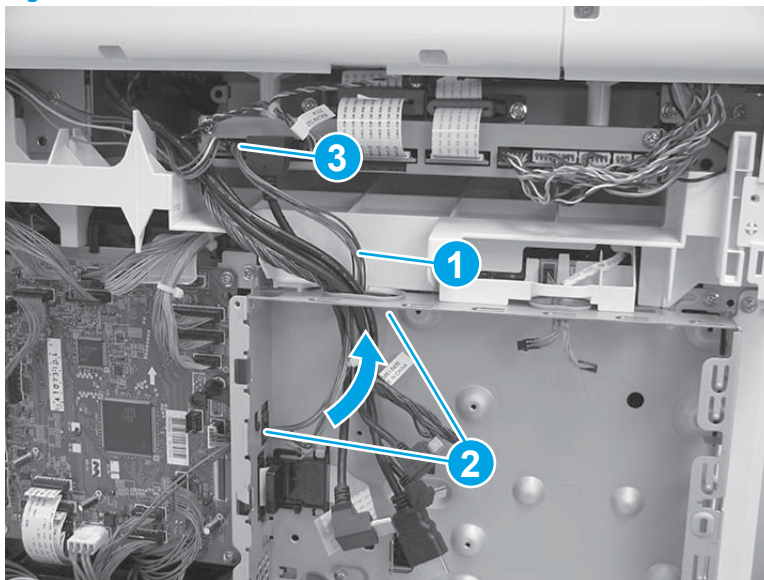

Step 20: Install the left cover

1. Position the cover on the printer.

 **NOTE:** Slightly offset the cover toward the rear of the printer.

Figure 1-2009 Install the cover

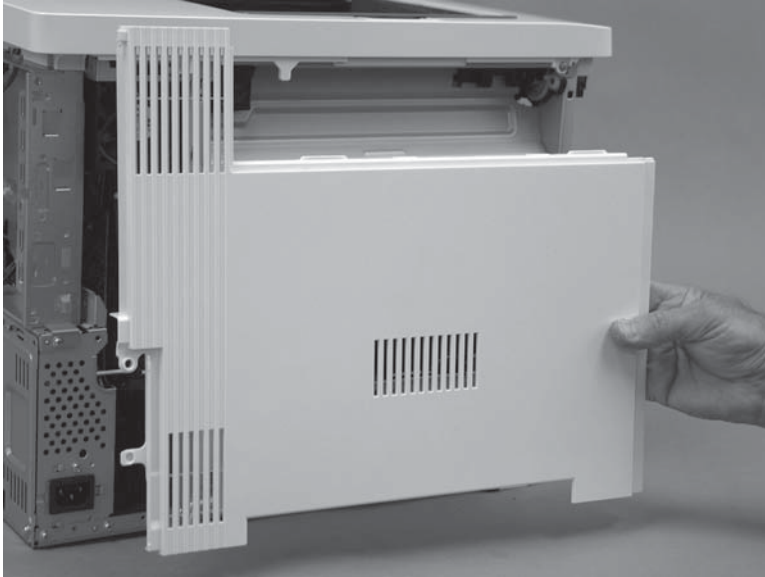

2. Slide the cover (callout 1) toward the front of the printer to engage it. Make sure that the tab (callout 2) snaps into place.

 **NOTE:** Locate the alignment pin (callout 3) on the cover from the front door side of the printer, and then make sure that it is fully engaged in the slot in the chassis.

 **TIP:** While sliding the cover into place, push in on the center of the cover (callout 1) to make sure that the hooks on the back of the cover engage with the slots in the chassis.

Figure 1-2010 Engage the cover



3. At the left side of the printer, install one screw (callout 1).

Figure 1-2011 Install one screw

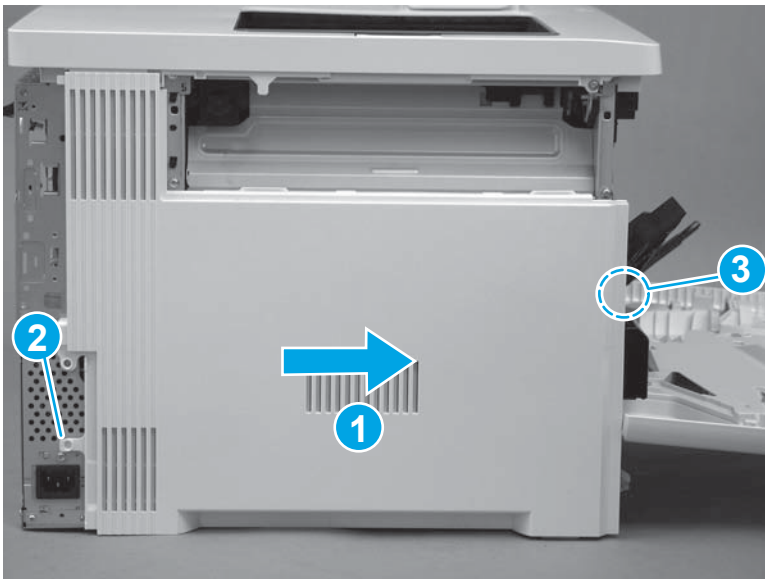

Step 21: Install the rear cover (M577)

 **NOTE:** This step is for the M577 models. For the M552 and M553 models, skip this step and go to [Step 23: Install the rear cover \(M552 and M553\) on page 1150](#).

1. Position the hooks (callout 1) on the cover in the slots (callout 2) in the printer.

Figure 1-2012 Position the hooks

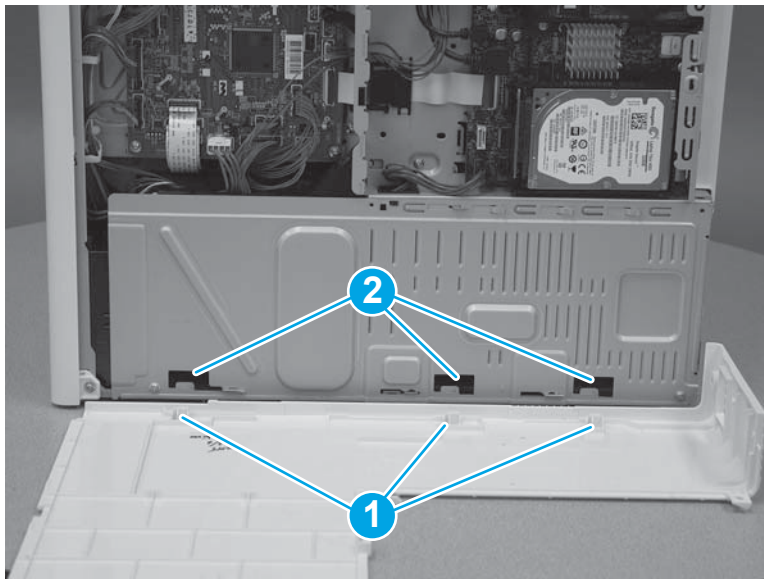

2. Position the back edge (callout 1) of the rear cover behind the edge (callout 2) of the right rear cover. Slide the cover to the left to install it.

Figure 1-2013 Install the cover

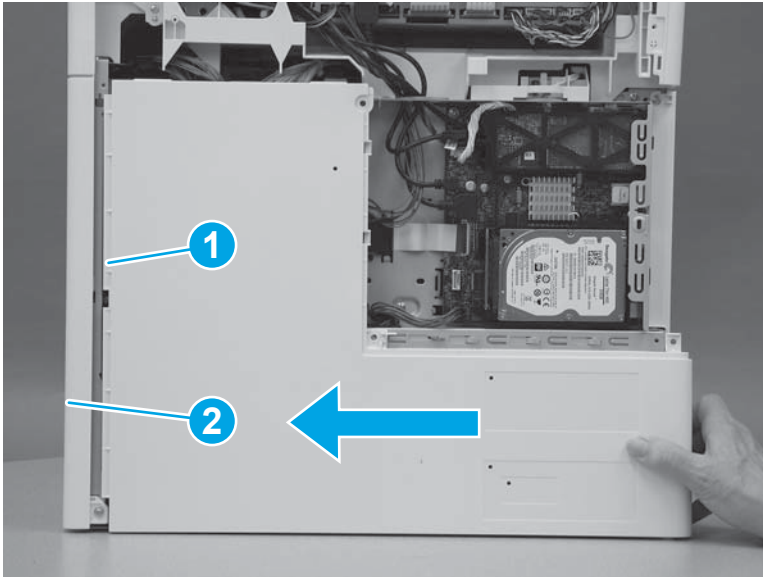

3. Install four screws (callout 1).

Figure 1-2014 Install four screws cover

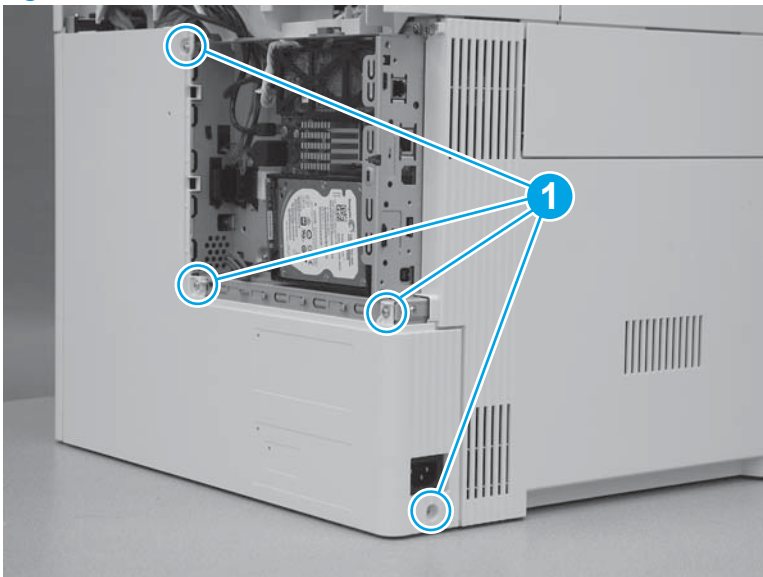

Step 22: Install the rear upper cover (M577)



NOTE: This step is for the M577 models. For the M552 and M553 models, skip this step and go to [Step 23: Install the rear cover \(M552 and M553\) on page 1150.](#)

1. Align the ridge (callout 1) on the lower edge of the rear upper cover in front of the tabs (callout 2) on the top edge of the rear cover.

Figure 1-2015 Align the cover

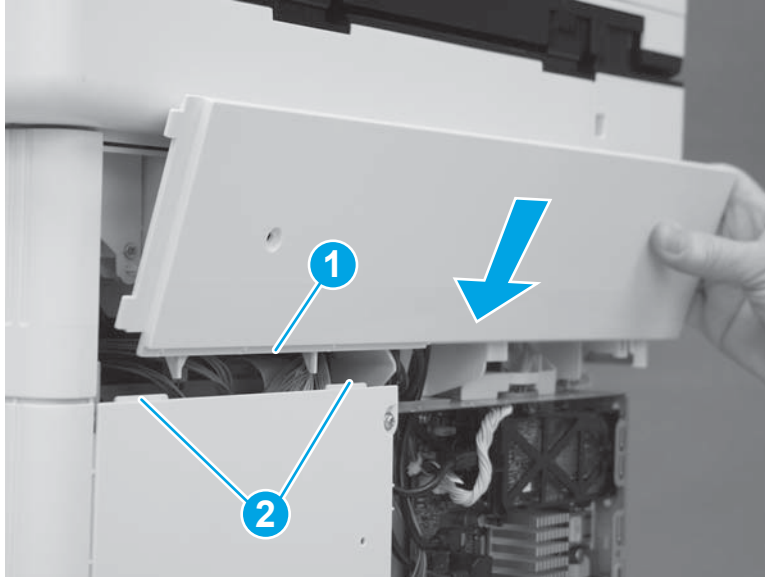

2. Rotate the top of the cover toward the printer.

Figure 1-2016 Rotate the top of the cover

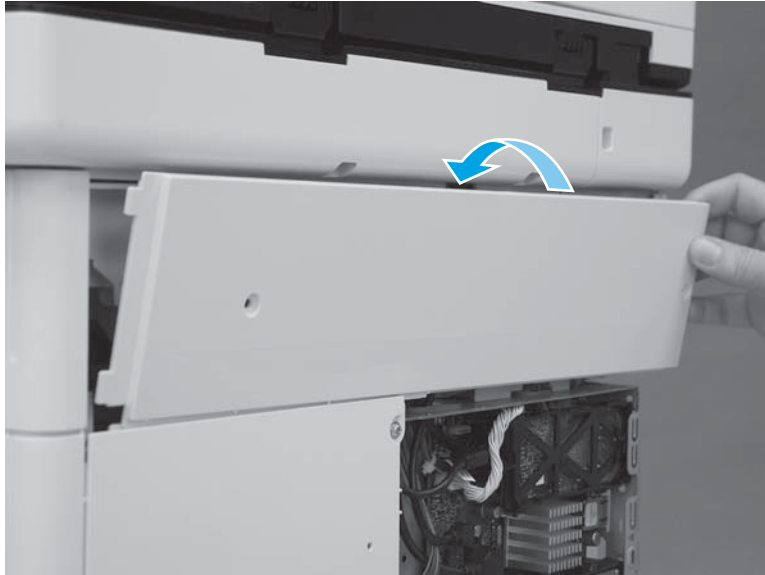

3. Slide the cover to the left (callout 1). Make sure that the tabs (callout 2) on the upper rear cover slide behind the edge (callout 3) of the right upper cover. Make sure that the cover is fully seated.

Figure 1-2017 Slide the cover

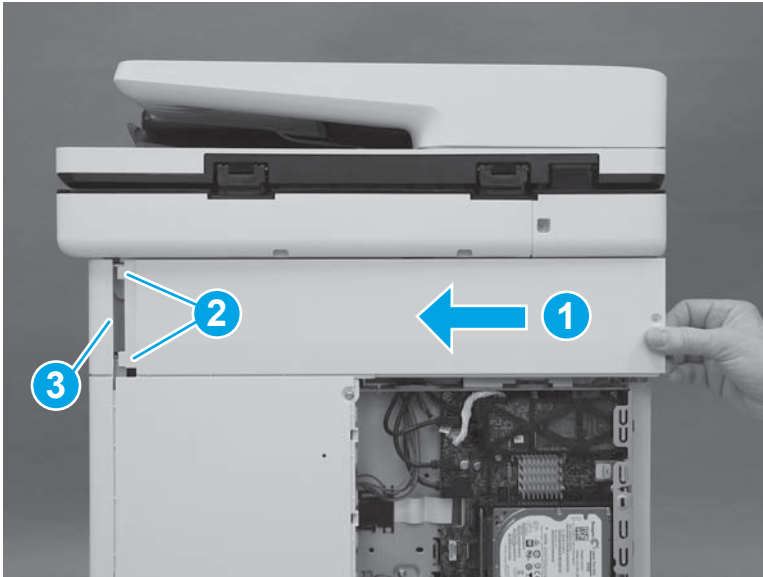

4. Install two screws (callout 1).

 **IMPORTANT:** These two screws are self-tapping screws for plastic. Rotate them counterclockwise to align them with the existing thread pattern, and then carefully turn them clockwise to tighten. Do not overtighten. This will prevent stripping the threads inside the screw holes.

Figure 1-2018 Install two screws



Step 23: Install the rear cover (M552 and M553)

 **NOTE:** This step is for the M552 and M553 models. For the M577 models, skip this step and go to [Step 24: Install the formatter \(M577\) on page 1151](#).

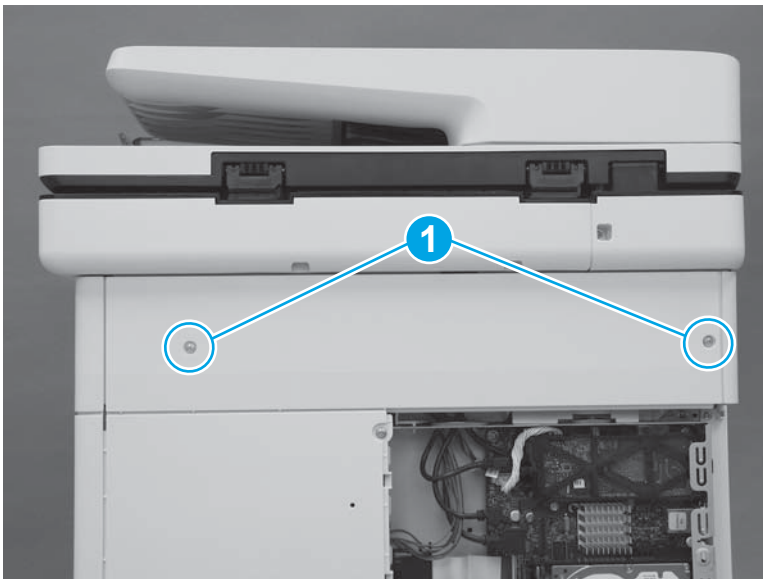
1. Position the top of the cover under the upper cover (callout 1), rotate the bottom of the cover onto the chassis (callout 2), and then slide the cover to the left (callout 3) to install it.

Figure 1-2019 Install the cover

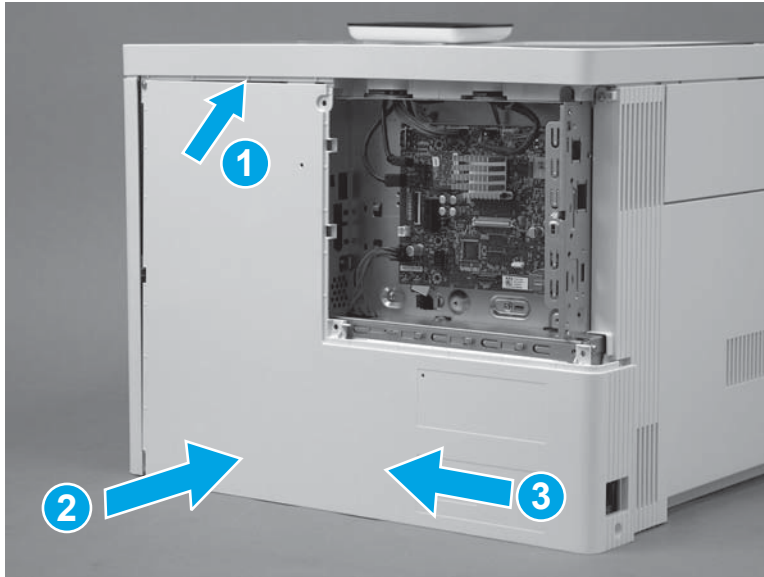

2. Install four screws (callout 1).

Figure 1-2020 Install four screws cover

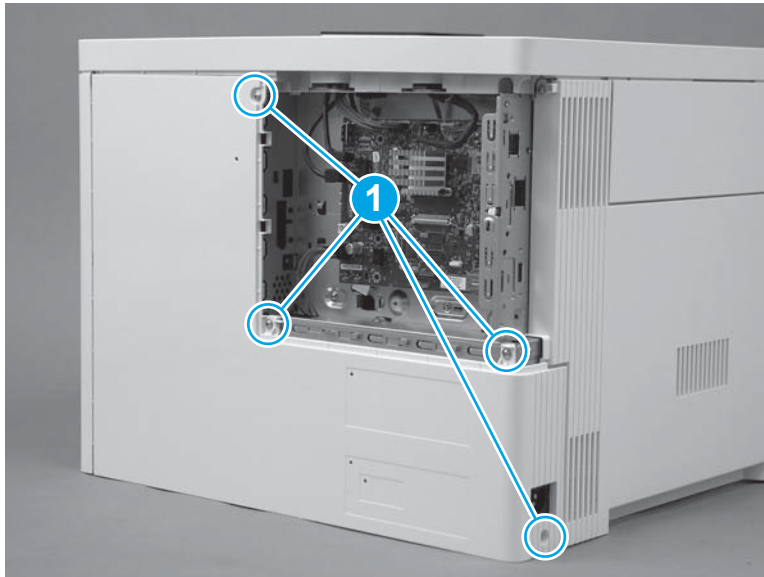

Step 24: Install the formatter (M577)

 **NOTE:** This step is for the M577 models. For the M552 and M553 models, skip this step and to go [Step 27: Install the formatter \(M552 and M553\) on page 1156](#).

 **CAUTION:**  ESD-sensitive part.

1. Position the formatter in the printer. Make sure that the network port (callout 1) fits through the opening (callout 2) in the formatter case.

Figure 1-2021 Install the formatter

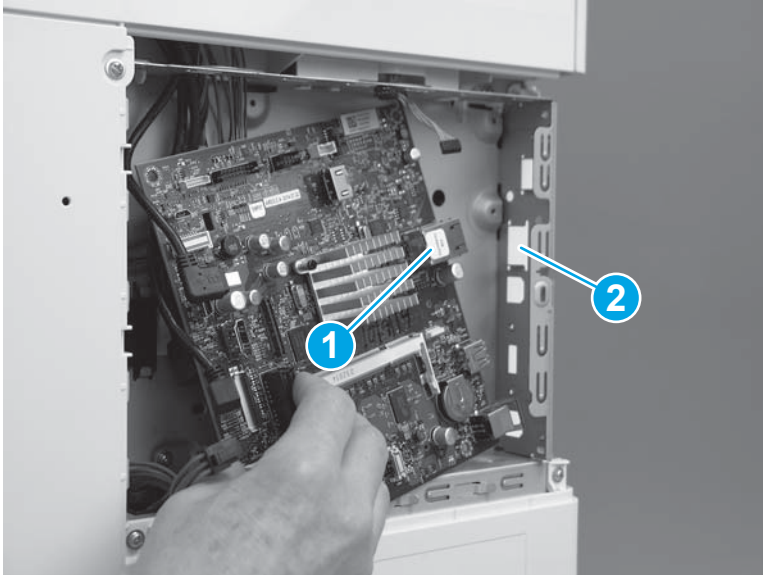

2. Install four screws (callout 1).

Figure 1-2022 Install four screws

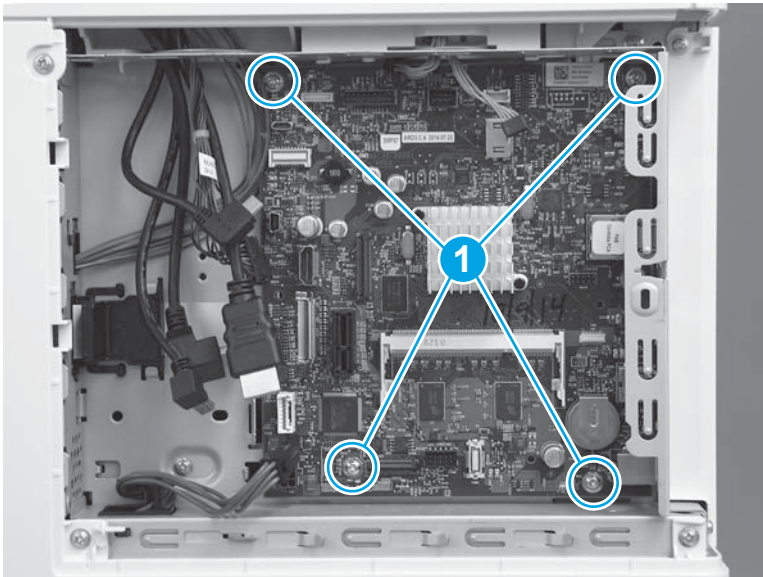

3. Connect all of the connectors on the formatter.

The following connectors are empty:

- All models: J1 (this connector is empty unless the optional DIMM is installed)
- All models: J3
- M577dn: J15 (this is the fax connector for the M577f/z/c models)
- All models: J21 (this connector is empty unless the optional internal USB ports component is installed)
- All models: J23

- All models: J24
- All models: J51
- All models: J57
- All models: J97
- All models: J98 (this connector is empty unless the optional trusted platform module (TPM) is installed)



 **IMPORTANT:** The flat-cable connector (callout 1) is a Zero Insertion Force (ZIF) connector that uses a hinged retainer to secure the flat cable. The hinged retainer must be opened to install the flat cable, and then closed after the cable is installed.

Figure 1-2023 Connect all connectors

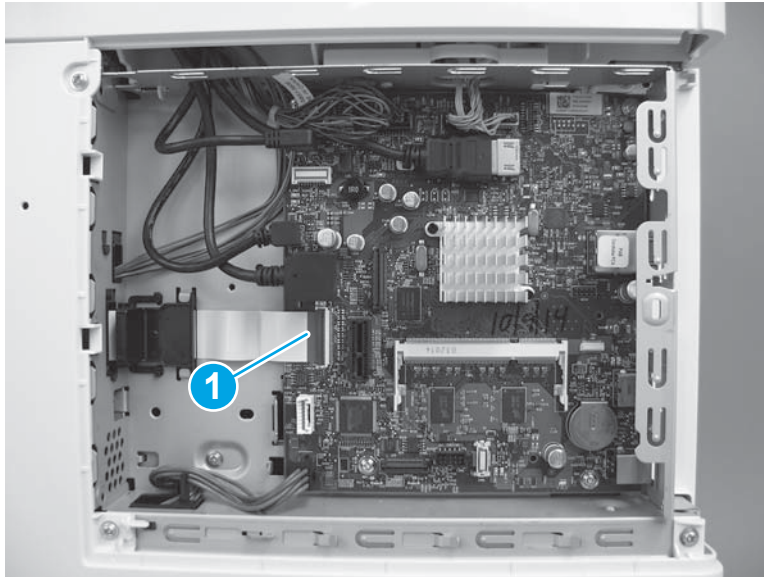

Step 25: Install the fax PCA (M577c/f/z)

 **NOTE:** This step is for the M577c/f/z models. For the M577n model, skip this step and go to [Step 26: Install the HDD \(M577\) on page 1155](#).

For the M552 and M553 models, skip this step and go to [Step 27: Install the formatter \(M552 and M553\) on page 1156](#).

 **CAUTION:**  ESD-sensitive part.

1. Position the tab and telephone port (callout 1) on the fax PCA in the slots (callout 2) in the formatter case.

Figure 1-2024 Position the fax PCA

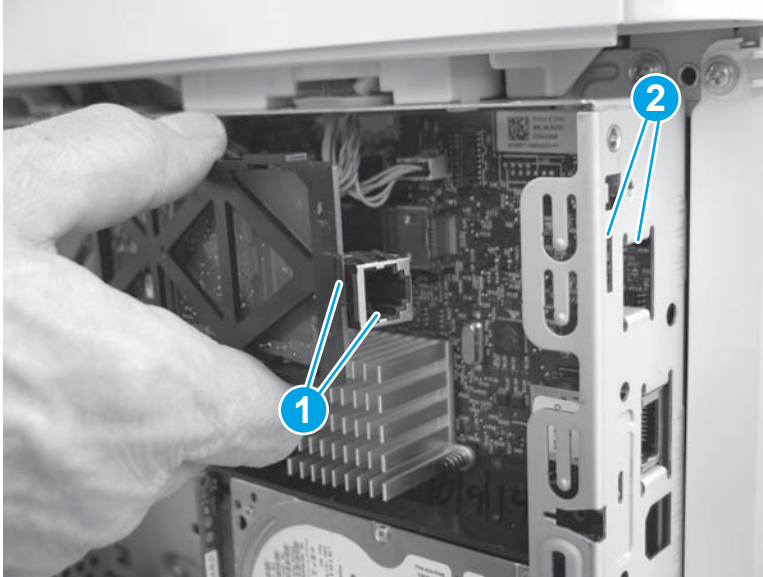

2. Slide the fax PCA to the right (callout 1) until the tab and telephone port described in the previous step and seated in the formatter case. Position the retainer (callout 2) in the slot (callout 3) in the formatter. Rotate the end of the fax PCA toward the formatter (callout 4) until the retainer snaps into place.

Figure 1-2025 Install the fax PCA

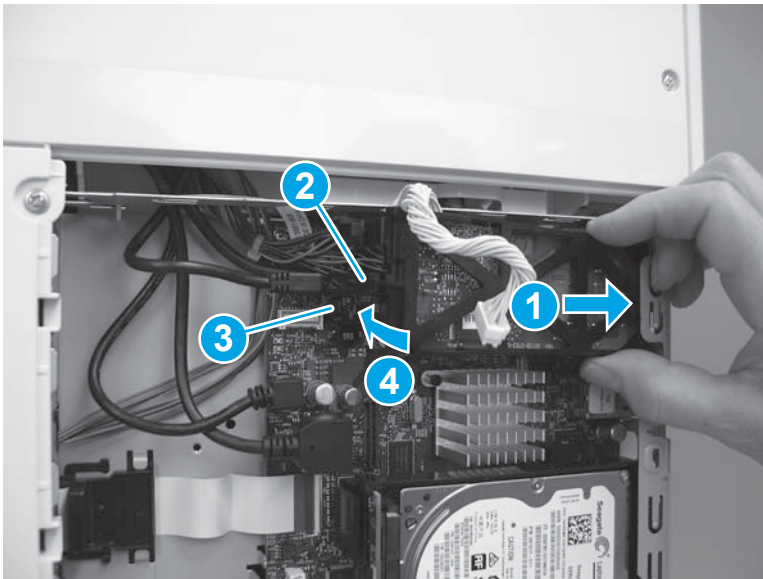

3. Position the cable (callout 1) in the guide (callout 2), and then connect one connector (callout 3).

Figure 1-2026 Connect the connector

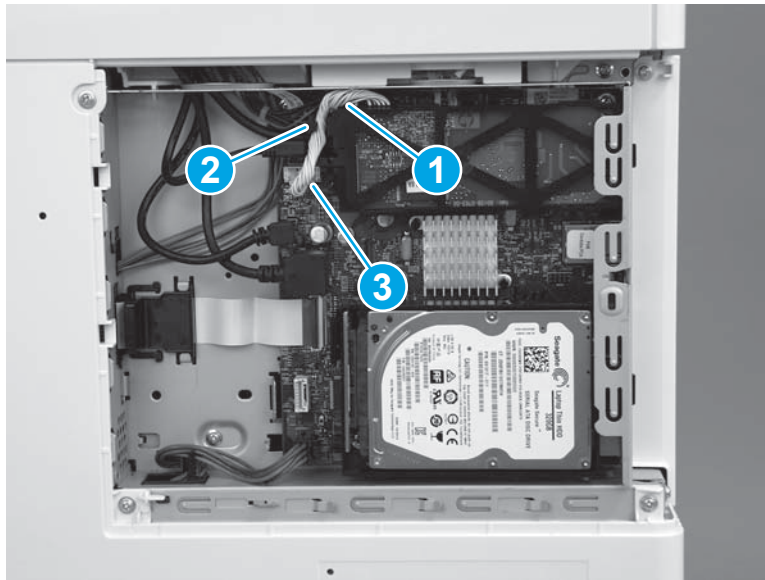

Step 26: Install the HDD (M577)

 **NOTE:** This step is for the M577 models. For the M552 and M553 models, skip this step and go to [Step 27: Install the formatter \(M552 and M553\)](#) on page 1156.

 **CAUTION:**  ESD-sensitive part.

1. Align the end of the bracket (callout 1) with the slot in the chassis (callout 2), and then slide the HDD into the printer (callout 3) to engage the bracket with the chassis.

Figure 1-2027 Install the holder

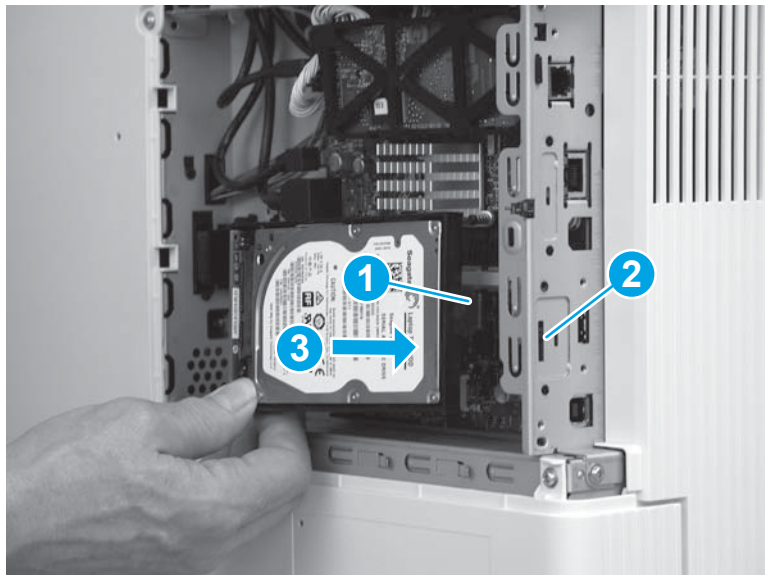

2. Hold the HDD connector latch (callout 1) in the released position, and then rotate the HDD down and into the connector on the formatter to install it.

 **NOTE:** Make sure that the tab (callout 2) snaps into place, and that the HDD is securely installed.

Figure 1-2028 Release the HDD



Step 27: Install the formatter (M552 and M553)

 **NOTE:** This step is for the M552 and M553 models. For the M577 models, skip this step and go to [Step 28: Install the formatter cover on page 1158](#).

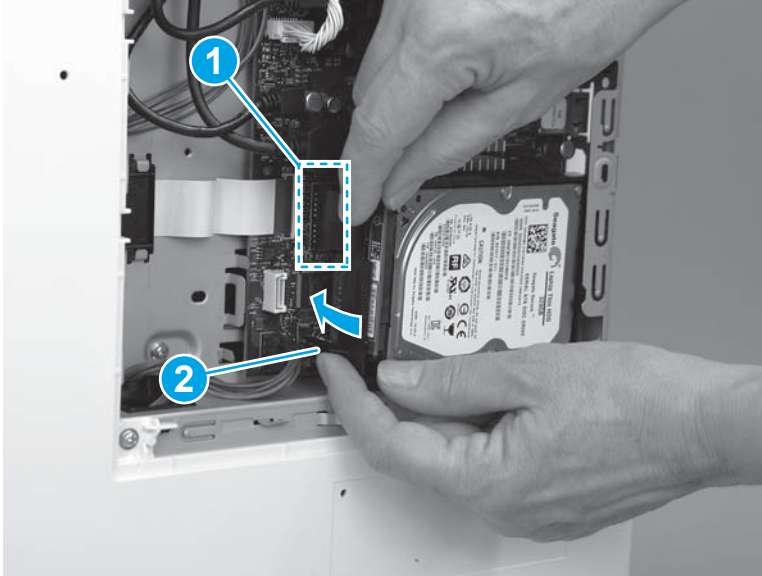
If the optional hard-disk drive (HDD) was removed, do not forget to reinstall it after the formatter is reinstalled.

Engage the HDD holder with the chassis, rotate the HDD connector down and into the connector on the formatter. Make sure that the tabs snap into place.

 **CAUTION:**  ESD-sensitive part.

1. Position the formatter in the printer, and then install four screws (callout 1).

Figure 1-2029 Install the formatter

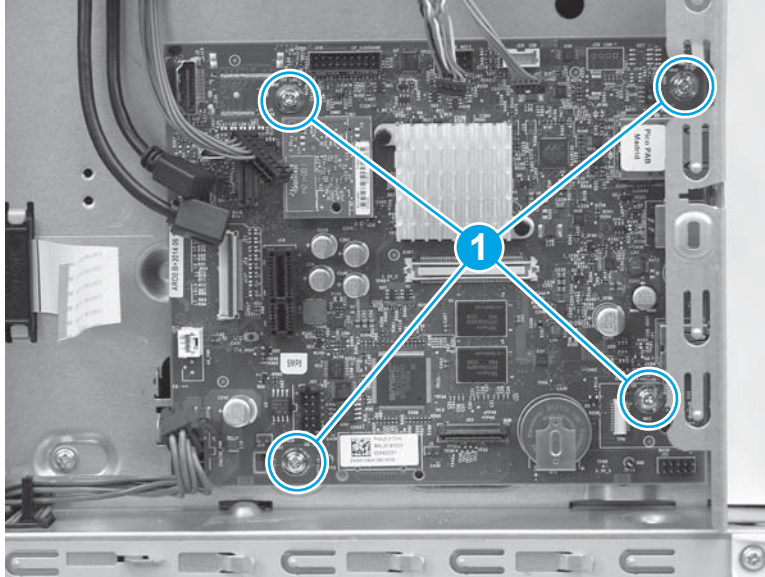

2. Connect all of the connectors on the formatter.

The following connectors are empty:

- All models: J1 (this connector is empty unless the optional DIMM is installed)
- M553n/dn and M552dn: J2 (callout 1; this is the touchscreen connector for the M553x model)
- All models: J9 (this connector is empty unless the optional internal USB ports component is installed)
- All models: J18 (this connector is empty unless the optional hard-disk-drive (HDD) is installed)
- All models: J23
- All models: J24
- M553n/dn and M552dn: J25 (this is the wireless connector for the M553x model)
- All models: J57
- All models: J98 (this connector is empty unless the optional trusted platform module (TPM) is installed)



 **IMPORTANT:** The flat-cable connector (callout 2) is a Zero Insertion Force (ZIF) connector that uses a hinged retainer to secure the flat cable. The hinged retainer must be opened to install the flat cable.

Figure 1-2030 Connect all connectors

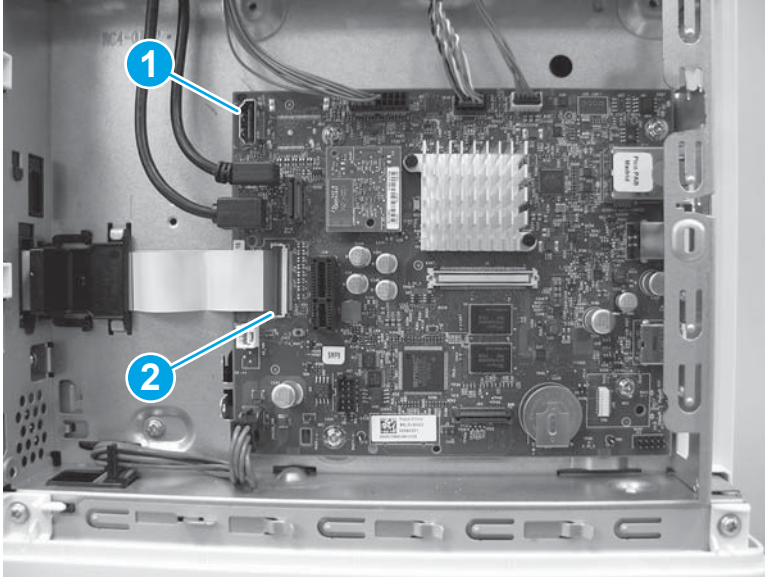

Step 28: Install the formatter cover

- ▲ Slide the cover onto the printer (callout 1) to install it.

 **NOTE:** Make sure that the tabs on the formatter cover align with the slots provided in the printer (callout 2). Tighten the two thumbscrews (callout 3).

 **TIP:** If needed, use the edge of a coin to turn the thumbscrews.

Figure 1-2031 Install the cover



Step 29: Install the TCU

1. Verify that the toner collection hatch cover is in the closed position on the TCU.

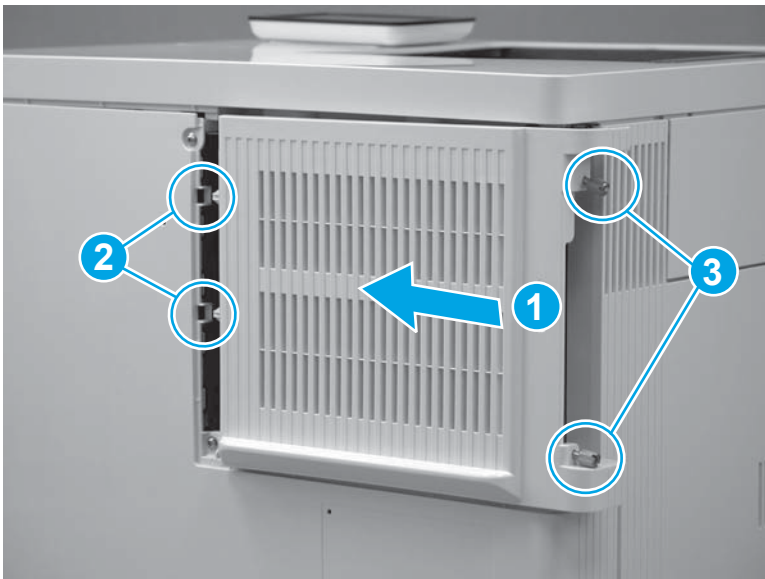
Figure 1-2032 Verify that the toner collection hatch cover is closed

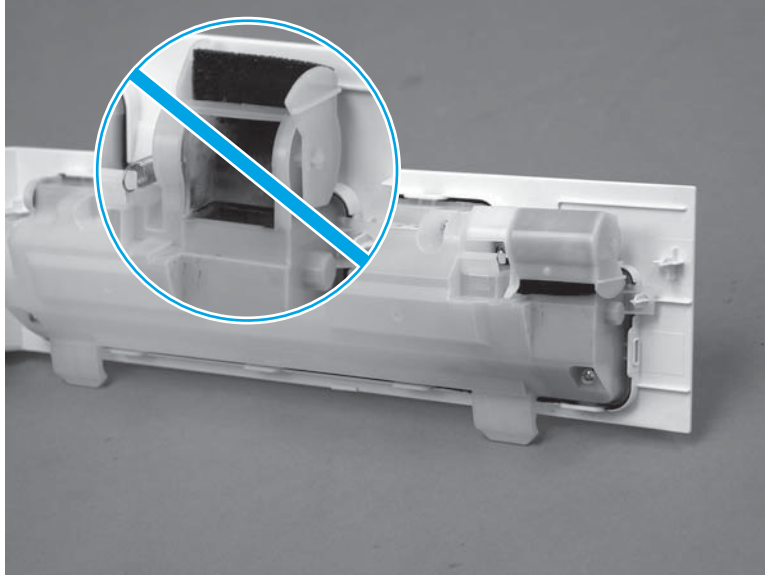

2. Position the TCU with the hinges in the slots provided in the printer (callout 1), and then rotate the TCU up and into the closed position.

 **NOTE:** The toner collection hatch cover automatically opens when the TCU is closed.

Figure 1-2033 Install the TCU



3. Close the front door.

Figure 1-2034 Close the front door

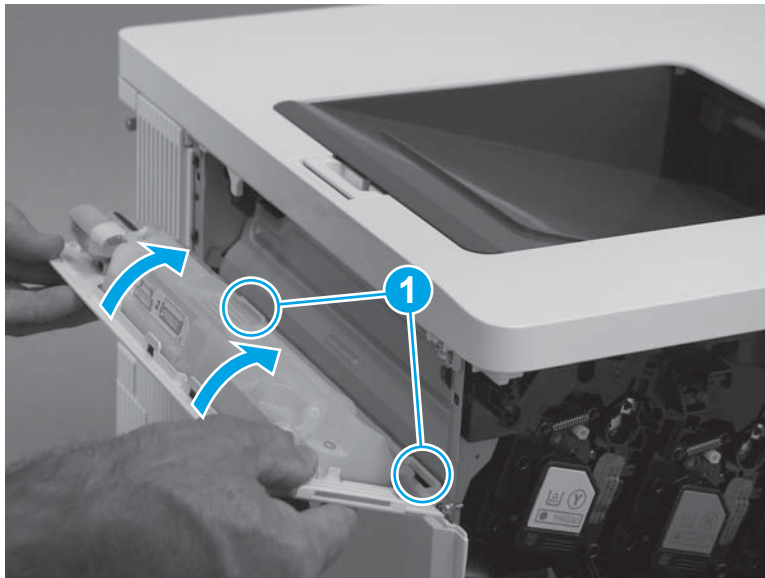

Removal and replacement: Auto close assembly

- [Introduction](#)
- [Step 1: Remove the toner collection unit \(TCU\)](#)
- [Step 2: Remove the formatter cover](#)
- [Step 3: Remove the formatter \(M552 and M553\)](#)
- [Step 4: Remove the hard-disk drive \(HDD\) \(M577\)](#)
- [Step 5: Remove the fax PCA \(M577c/f/z\)](#)
- [Step 6: Remove the formatter \(M577\)](#)
- [Step 7: Remove the rear cover \(M552 and M553\)](#)
- [Step 8: Remove the rear upper cover \(M577\)](#)
- [Step 9: Remove the rear cover \(M577\)](#)
- [Step 10: Remove the left cover](#)
- [Step 11: Remove the formatter case](#)
- [Step 12: Remove the low-voltage power supply \(LVPS\)](#)
- [Step 13: Remove the high-voltage power supply D \(HVPSD\)](#)
- [Step 14: Remove the auto close assembly](#)
- [Step 15: Unpack the replacement assembly](#)
- [Step 16: Install the auto close assembly](#)
- [Step 17: Install the HVPSD](#)
- [Step 18: Install the LVPS](#)
- [Step 19: Install the formatter case](#)
- [Step 20: Install the left cover](#)
- [Step 21: Install the rear cover \(M577\)](#)
- [Step 22: Install the rear upper cover \(M577\)](#)
- [Step 23: Install the rear cover \(M552 and M553\)](#)
- [Step 24: Install the formatter \(M577\)](#)
- [Step 25: Install the fax PCA \(M577c/f/z\)](#)
- [Step 26: Install the HDD \(M577\)](#)
- [Step 27: Install the formatter \(M552 and M553\)](#)
- [Step 28: Install the formatter cover](#)
- [Step 29: Install the TCU](#)

Introduction

This document provides the procedures to remove and replace the auto close assembly.

Before performing service

Turn the printer power off

- Disconnect the power cable.

⚠ WARNING! To avoid damage to the printer, turn the printer off, wait 30 seconds, and then remove the power cord before attempting to service the printer.

Use the table below to identify the correct part number for your printer, and then go to <http://h20141.www2.hp.com/hpparts> to order the part.

Auto close assembly part number	
---------------------------------	--

RM2-5147-000CN

Auto close assembly

Required tools

- #2 Phillips screwdriver with a magnetic tip

After performing service

Make sure that all of the connectors on the HVPSD are fully seated.

Make sure that all of the connectors on the LVPS are fully seated.

Make sure that all of the connectors on the formatter are fully seated.

Make sure that the formatter cover is fully seated, and that the thumbscrews are finger tight after replacing it.

Turn the printer power on

- Connect the power cable.
- Use the power switch to turn the power on.

Step 1: Remove the toner collection unit (TCU)

1. Open the front door.

Figure 1-2035 Open the front door



2. Open the TCU.

 **NOTE:** The toner collection hatch cover automatically closes when the TCU is opened.

Figure 1-2036 Open the TCU



3. Pull the TCU away from the printer at an angle to remove it.

⚠ CAUTION: Do not open the toner collection hatch cover when handling the TCU. If toner gets on clothing, wipe it off by using a dry cloth and wash the clothes in cold water. Hot water sets toner into fabric.

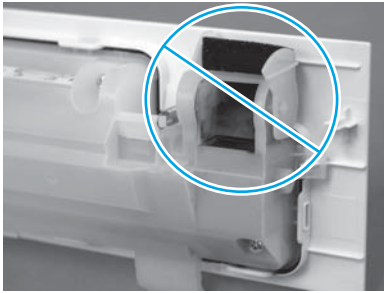
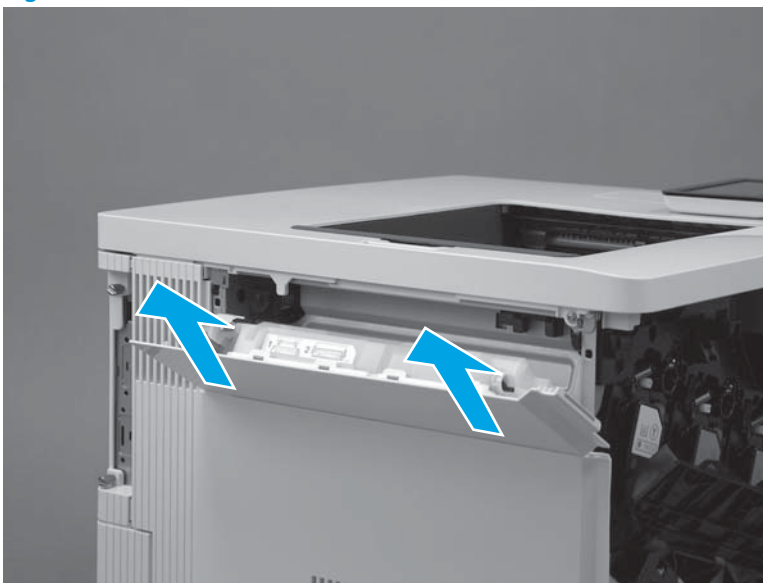

Figure 1-2037 Remove the TCU



Step 2: Remove the formatter cover

1. Locate the formatter cover.

Figure 1-2038 Locate the formatter cover

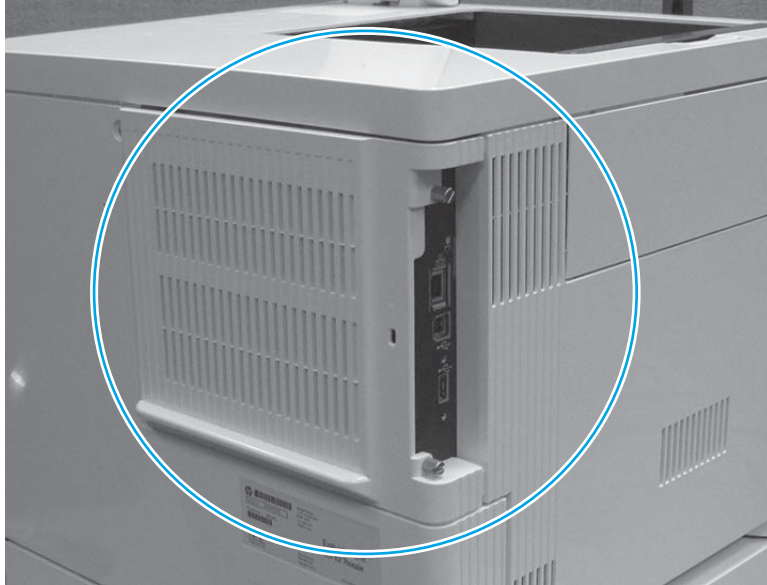

2. Loosen the two thumbscrews (callout 1). Grasp the two thumbscrews, and then slide the cover away from the printer (callout 2) to remove it.

 **TIP:** If needed, use the edge of a coin to turn the thumbscrews.

Figure 1-2039 Loosen the thumbscrews



Step 3: Remove the formatter (M552 and M553)

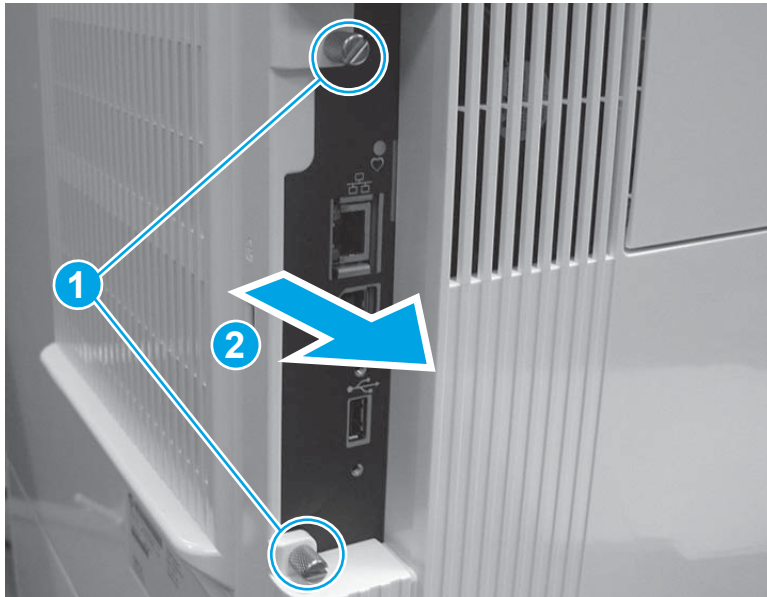

NOTE: This step is for the M552 and M553 models. For the M577 models, skip this step and go to [Step 4: Remove the hard-disk drive \(HDD\) \(M577\) on page 953](#).

If the optional hard-disk drive (HDD) is installed, it must be removed to gain access to the formatter mounting screws.

Release two tabs along the left edge of the HDD, rotate the left edge away from the product, and then slide the HDD to the left to remove it.



CAUTION:  ESD-sensitive part.

1. Disconnect all of the connectors on the formatter.

The following connectors are empty:

- All models: J1 (this connector is empty unless the optional DIMM is installed)
- M553n/dn and M552dn: J2 (callout 1; this is the touchscreen connector for the M553x model)
- All models: J9 (this connector is empty unless the optional internal USB ports component is installed)
- All models: J18 (this connector is empty unless the optional hard-disk-drive (HDD) is installed)
- All models: J23
- All models: J24
- M553n/dn and M552dn: J25 (this is the wireless connector for the M553x model)
- All models: J57
- All models: J98 (this connector is empty unless the optional trusted platform module (TPM) is installed)



IMPORTANT: The flat-cable connector (callout 2) is a Zero Insertion Force (ZIF) connector that uses a hinged retainer to secure the flat cable. The hinged retainer must be opened to release the flat cable.

Figure 1-2040 Disconnect all connectors

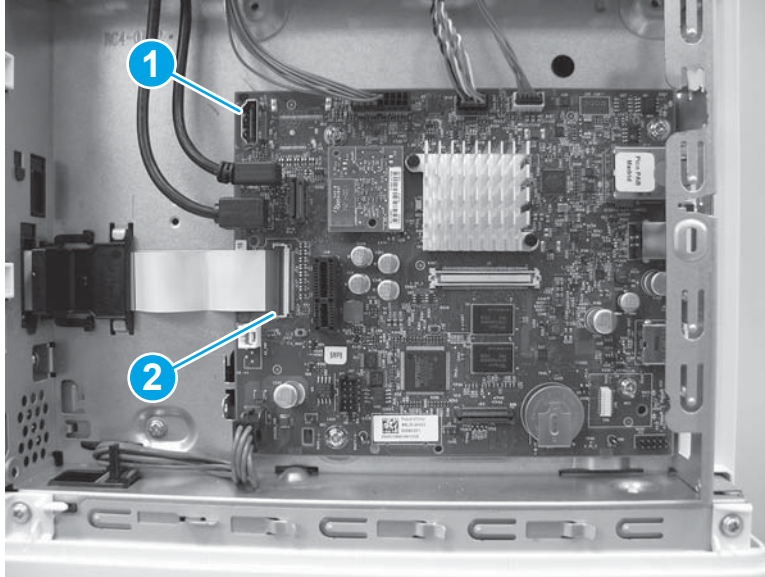

2. Remove four screws (callout 1), and then remove the formatter.

Figure 1-2041 Remove the formatter

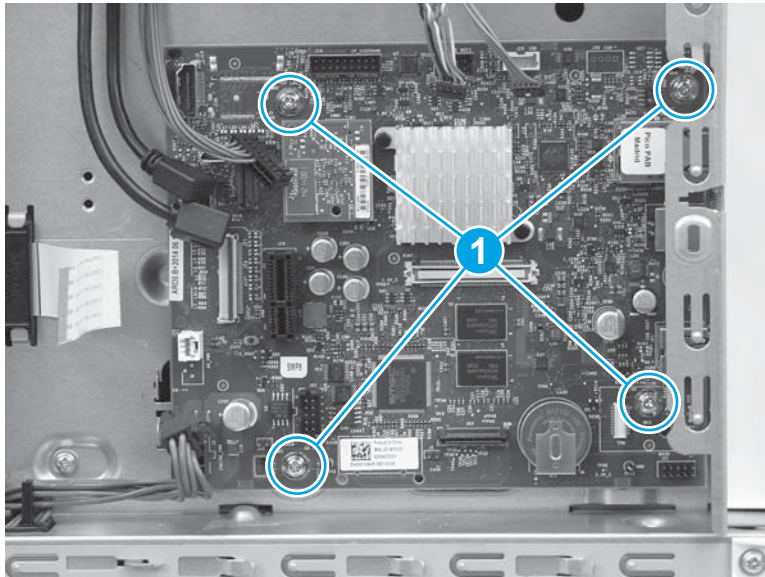

Step 4: Remove the hard-disk drive (HDD) (M577)

 **NOTE:** This step is for the M577 models. For the M552 and M553 models, skip this step and go to [Step 7: Remove the rear cover \(M552 and M553\) on page 1172](#).

 **CAUTION:**  ESD-sensitive part.

1. Release two tabs (callout 1). Hold the tabs in the released position, and then rotate the hard disk drive (HDD) up (callout 2) to release the connector from the formatter.

Figure 1-2042 Release the HDD

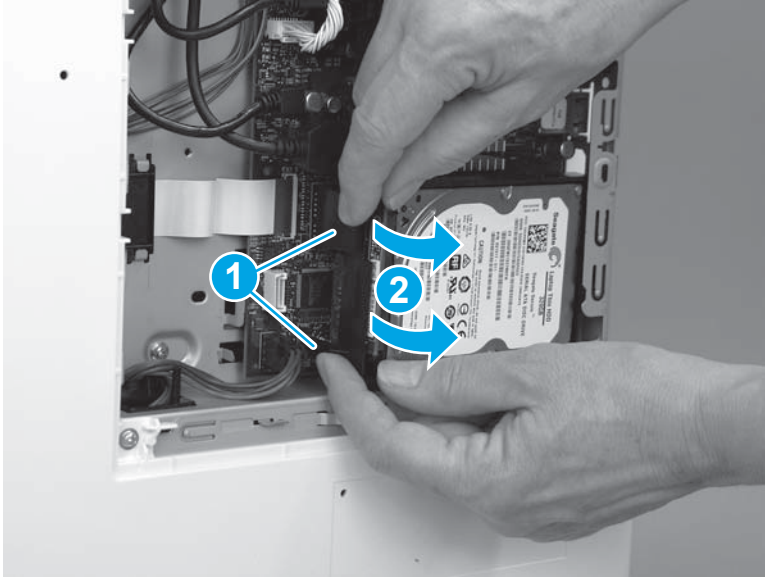

2. Slide the HDD away from the printer to remove it.

Figure 1-2043 Remove the HDD



Step 5: Remove the fax PCA (M577c/f/z)



NOTE: This step is for the M577c/f/z models. For the M577n model, skip this step and go to [Step 6: Remove the formatter \(M577\) on page 1170](#).

For the M552 and M553 models, skip this step and go to [Step 7: Remove the rear cover \(M552 and M553\) on page 1172](#).



CAUTION:  ESD-sensitive part.

1. Locate the fax PCA component on the formatter.

Figure 1-2044 Locate the fax PCA

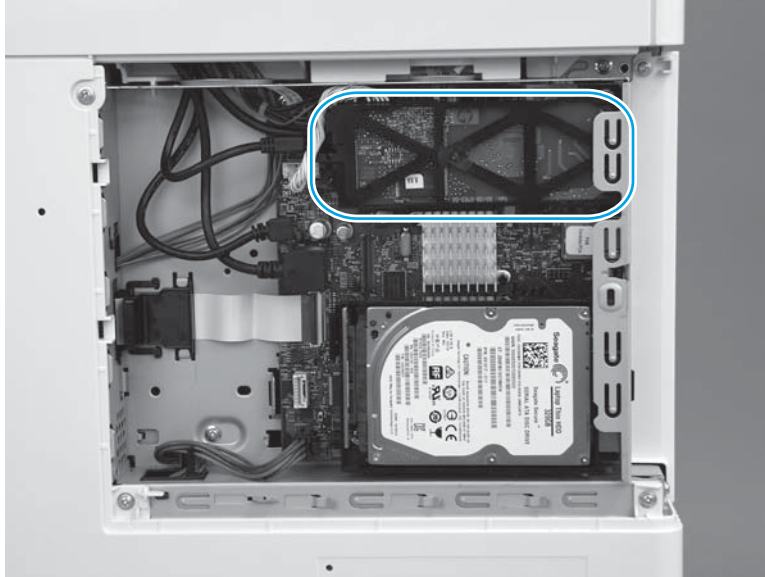

2. Release the connector latch (callout 1), and then pull the connector away from the formatter (callout 2) to disconnect it.

Figure 1-2045 Disconnect one connector

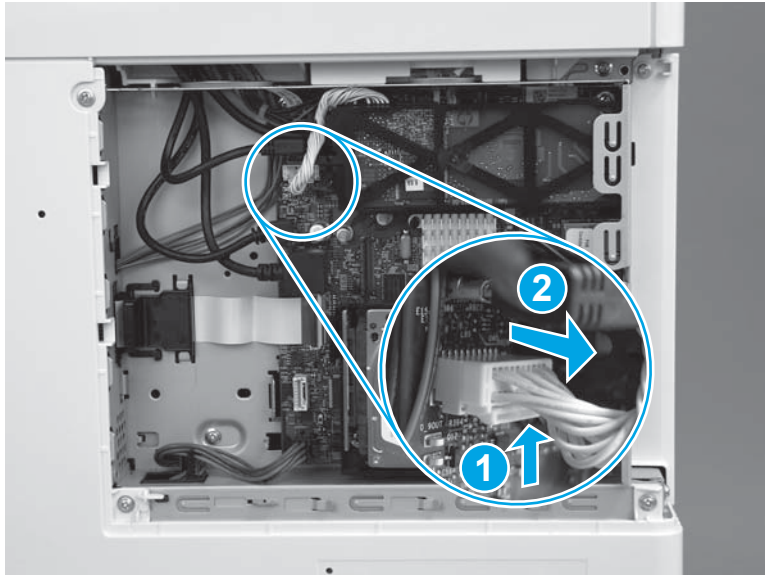

3. Release one retainer (callout 1) by pressing the bracket arms together.

Figure 1-2046 Release one latch

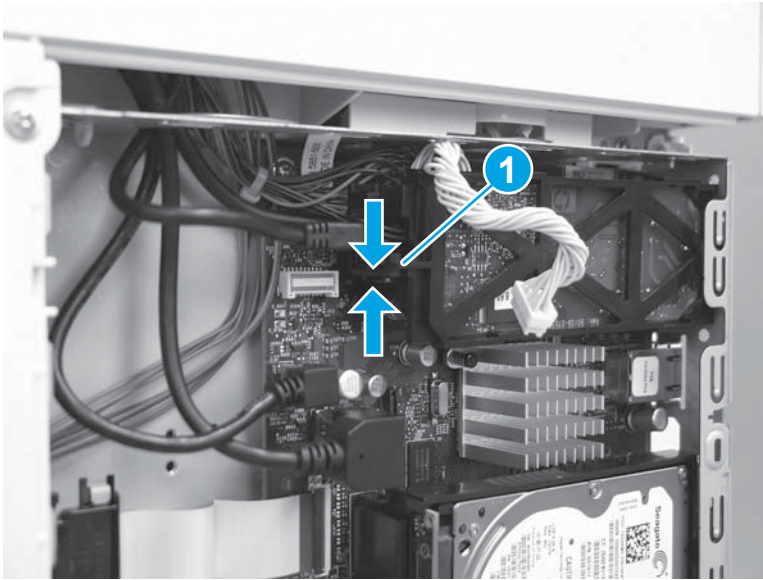

4. Rotate the end of the fax PCA (callout 1) away from the formatter, and then slide the PCA left (callout 2) to remove it.

Figure 1-2047 Remove the fax PCA

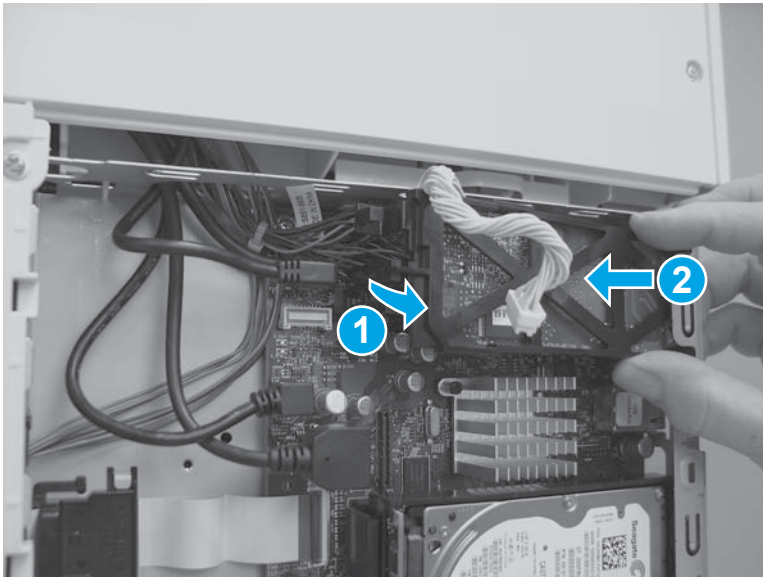

Step 6: Remove the formatter (M577)

 **NOTE:** This step is for the M577 models. For the M552 and M553 models, skip this step and go to [Step 7: Remove the rear cover \(M552 and M553\) on page 1172.](#)

 **CAUTION:**  ESD-sensitive part.

1. Disconnect all of the connectors on the formatter.

The following connectors are empty:

- All models: J1 (this connector is empty unless the optional DIMM is installed)
- All models: J3
- M577dn: J15 (this is the fax connector for the M577f/z/c models)
- All models: J21 (this connector is empty unless the optional internal USB ports component is installed)
- All models: J23
- All models: J24
- All models: J51
- All models: J57
- All models: J97
- All models: J98 (this connector is empty unless the optional trusted platform module (TPM) is installed)

 **IMPORTANT:** The flat-cable connector (callout 1) is a Zero Insertion Force (ZIF) connector that uses a hinged retainer to secure the flat cable. The hinged retainer must be opened to release the flat cable.

Figure 1-2048 Disconnect all connectors



2. Remove four screws (callout 1).

Figure 1-2049 Remove four screws

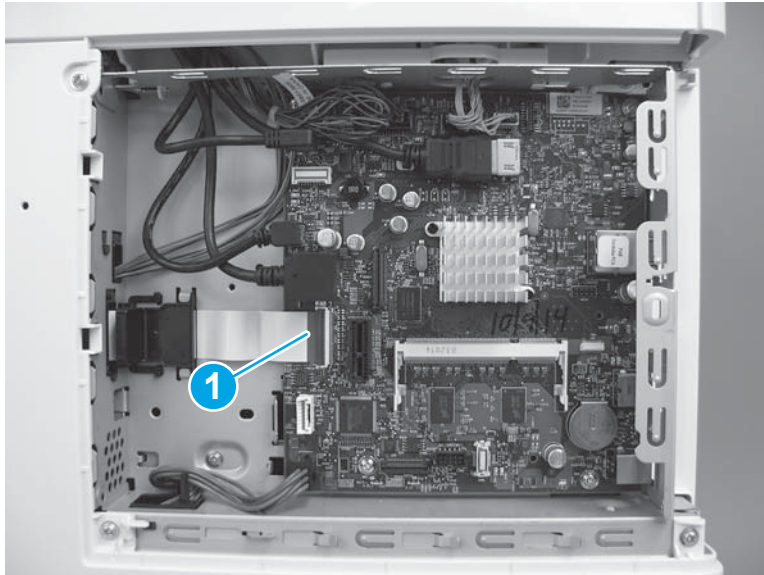
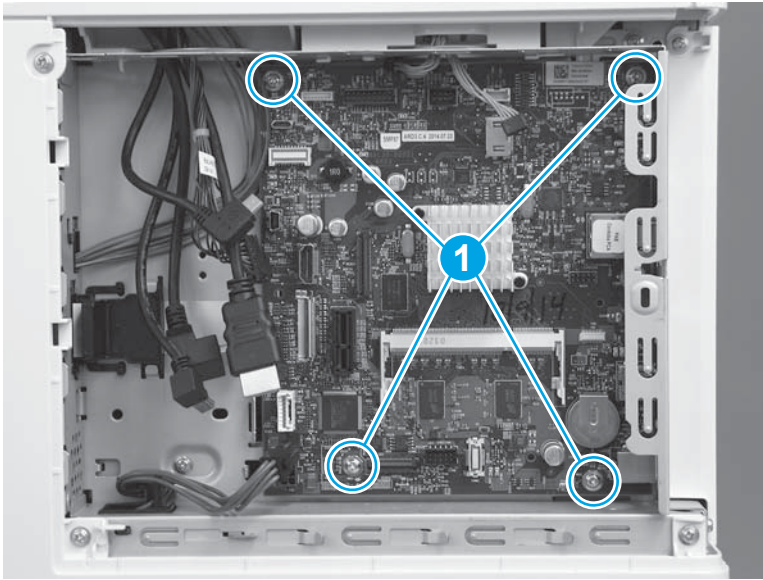

3. Remove the formatter.

Figure 1-2050 Remove the formatter

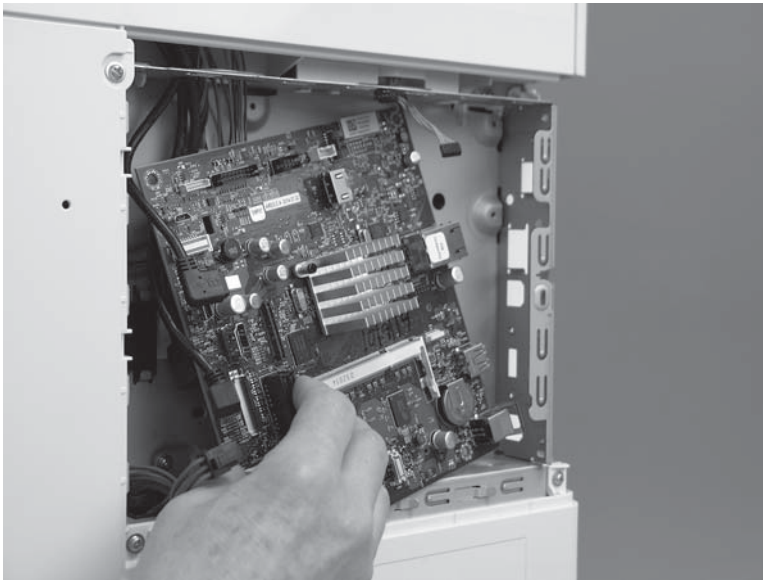

Step 7: Remove the rear cover (M552 and M553)



NOTE: This step is for the M552 and M553 models. For the M577 models, skip this step and go to [Step 8: Remove the rear upper cover \(M577\) on page 1173.](#)

1. Remove four screws (callout 1).

Figure 1-2051 Remove four screws

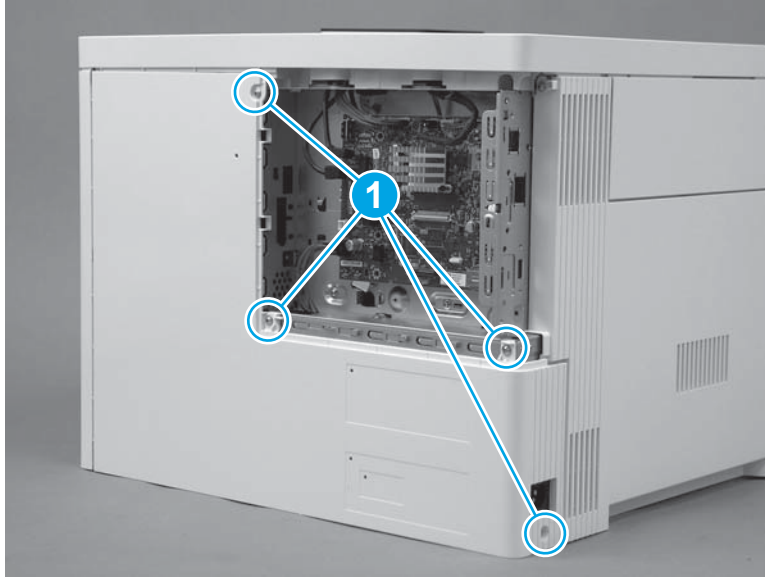

2. Slightly slide the cover to the right (callout 1), rotate the bottom of the cover away from the printer (callout 2), and then pull the top of the cover away from the printer (callout 3) to remove the cover.

Figure 1-2052 Remove the cover

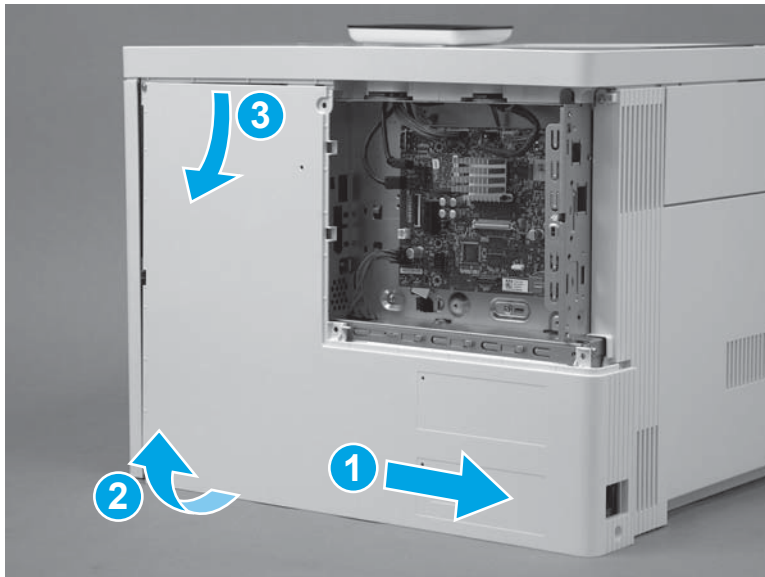

Step 8: Remove the rear upper cover (M577)

 **NOTE:** This step is for the M577 models. For the M552 and M553 models, skip this step and go to [Step 10: Remove the left cover on page 1176](#).

1. Remove two screws (callout 1).

 **Reinstallation tip:** These two screws are self-tapping screws for plastic. When reinstalling them, rotate the screws counterclockwise to align them with the existing thread pattern, and then carefully turn them clockwise to tighten. Do not overtighten. This will prevent stripping the threads inside the screw holes.

Figure 1-2053 Remove two screws



2. Use a small, flat blade screwdriver to release the right edge of the cover.

Figure 1-2054 Release the right edge

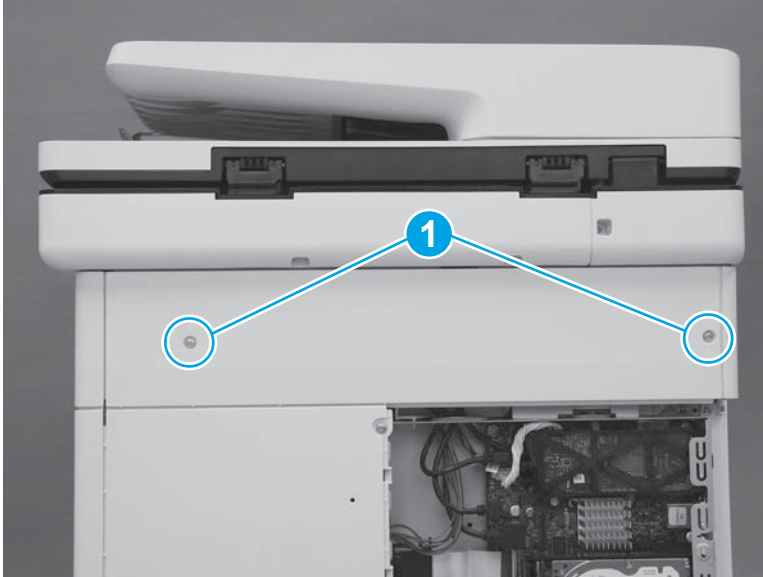
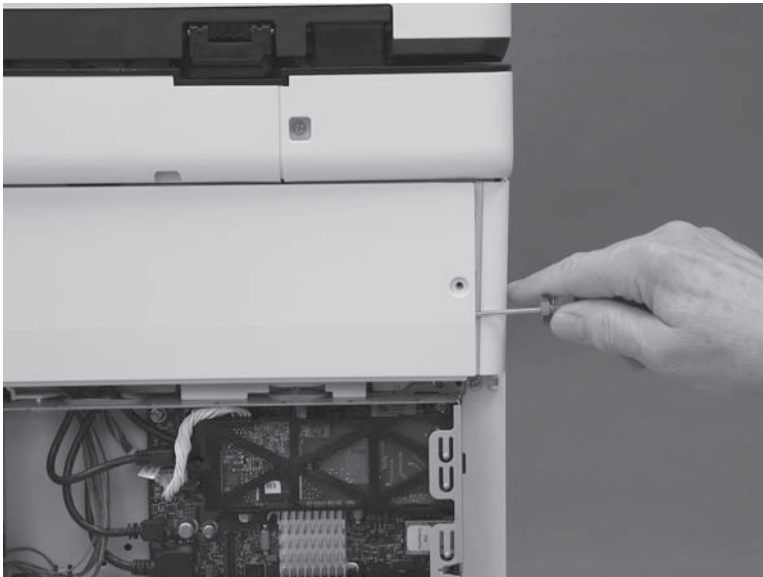

3. Pull the right edge of the cover (callout 1) away from the printer, and then slide the cover to the right (callout 2).

Figure 1-2055 Slide the cover right

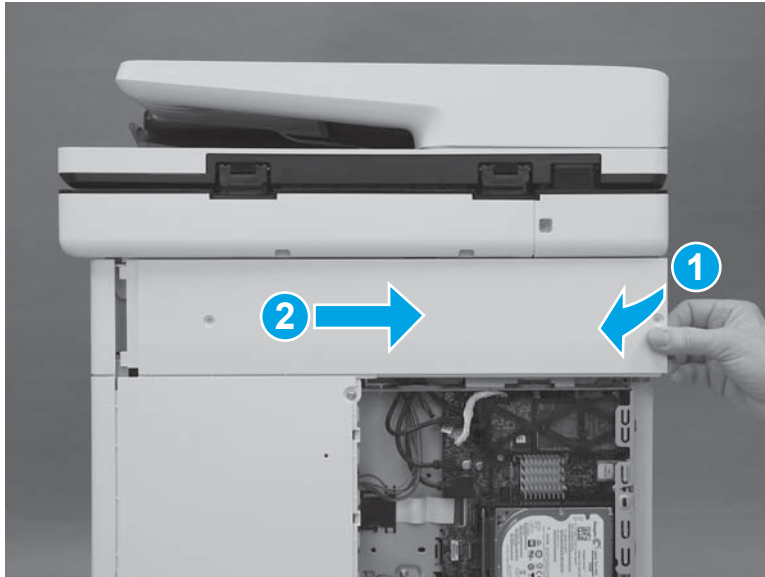

4. Remove the cover.

Figure 1-2056 Remove the cover

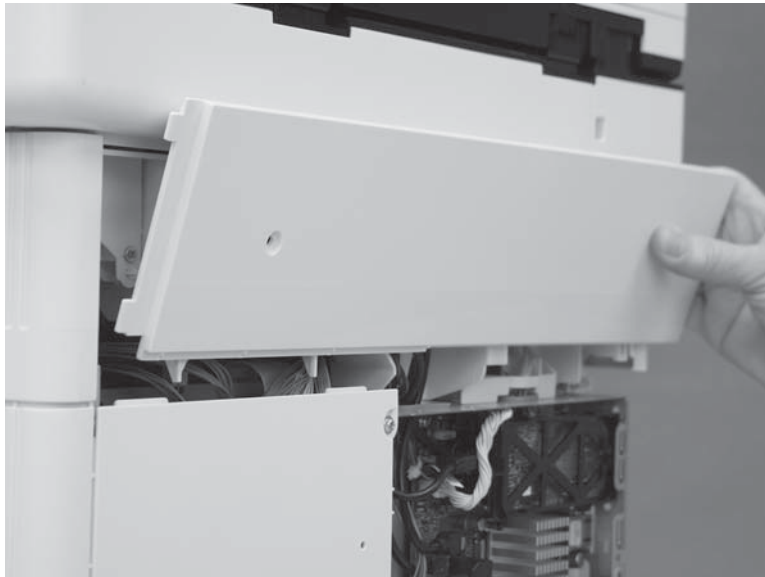

Step 9: Remove the rear cover (M577)

 **NOTE:** This step is for the M577 models. For the M552 and M553 models, skip this step and go to [Step 10: Remove the left cover on page 1176.](#)

1. Remove four screws (callout 1).

Figure 1-2057 Remove four screws

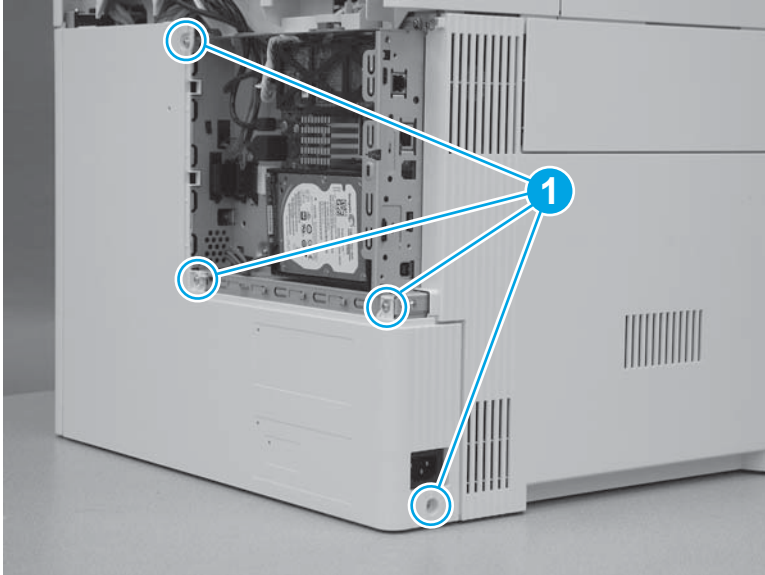

2. Slide the cover to the right to remove it.

Figure 1-2058 Remove the cover

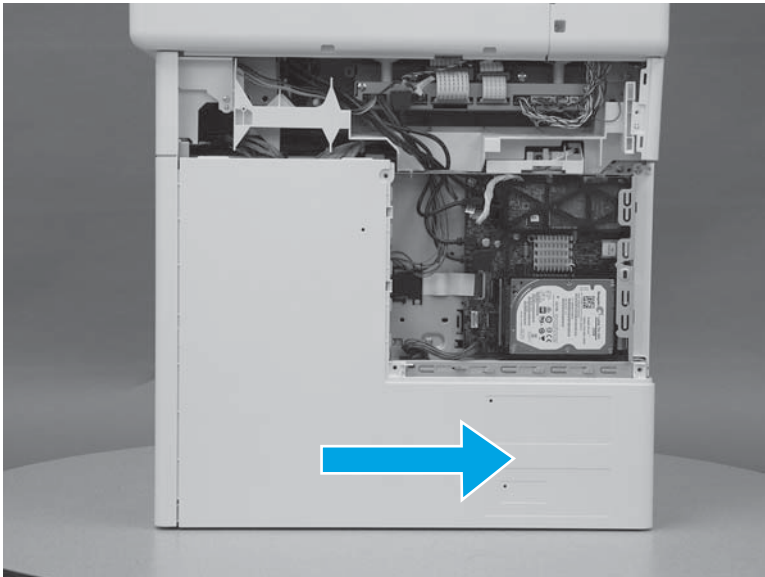

Step 10: Remove the left cover

1. At the left side of the printer, remove one screw (callout 1).

Figure 1-2059 Remove one screw



2. Release one tab (callout 1), rotate the front edge of the cover away from the printer (callout 2), and then slide the cover (callout 3) toward the rear of the printer to release it.

Figure 1-2060 Release the cover

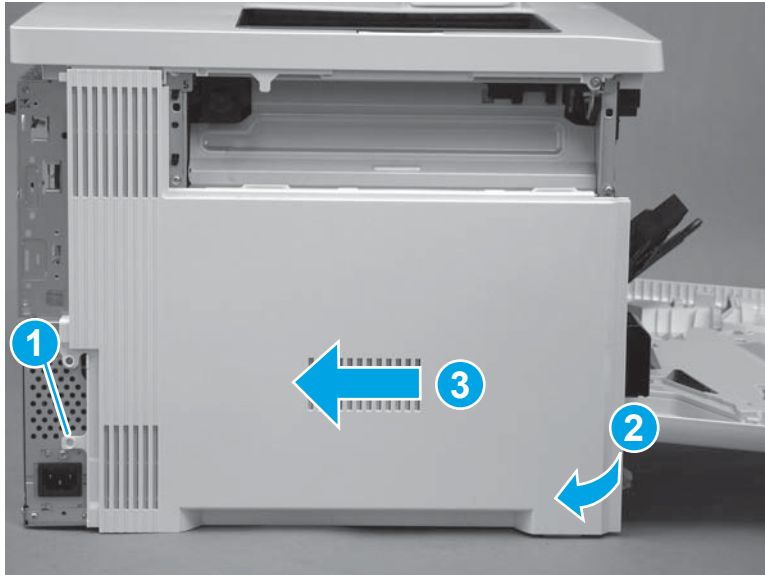

3. Remove the cover.

Figure 1-2061 Remove the cover

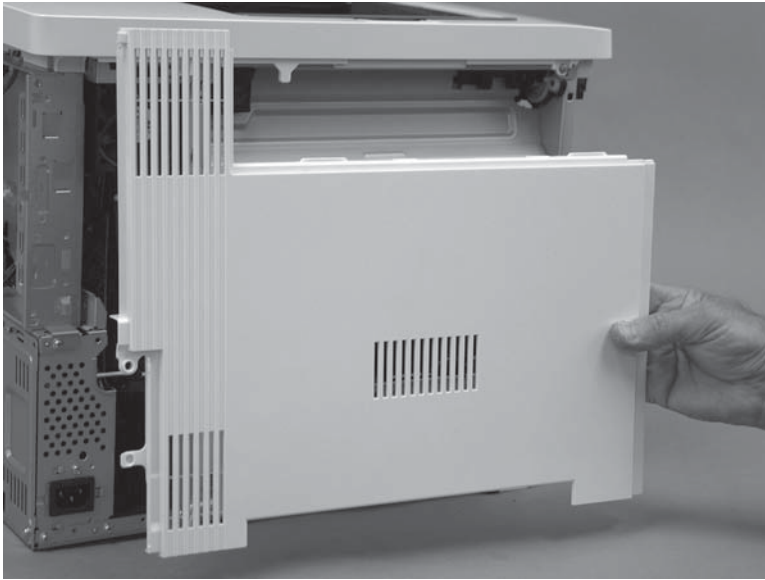

Step 11: Remove the formatter case

1. **M577 only:** Disconnect one connector (callout 1), and then pass the wire harness (callout 2) through two openings in the formatter case (callout 3).

Figure 1-2062 Disconnect one connector

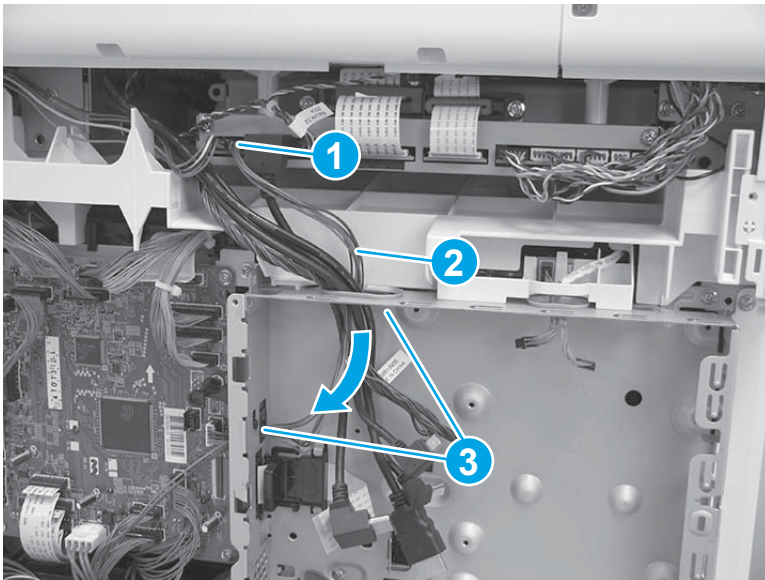

2. Release two tabs (callout 1) on the black plastic bracket. Hold the tabs in the released position, and then slide the bracket (callout 2) to the right to remove it from the formatter case.

Figure 1-2063 Remove the bracket

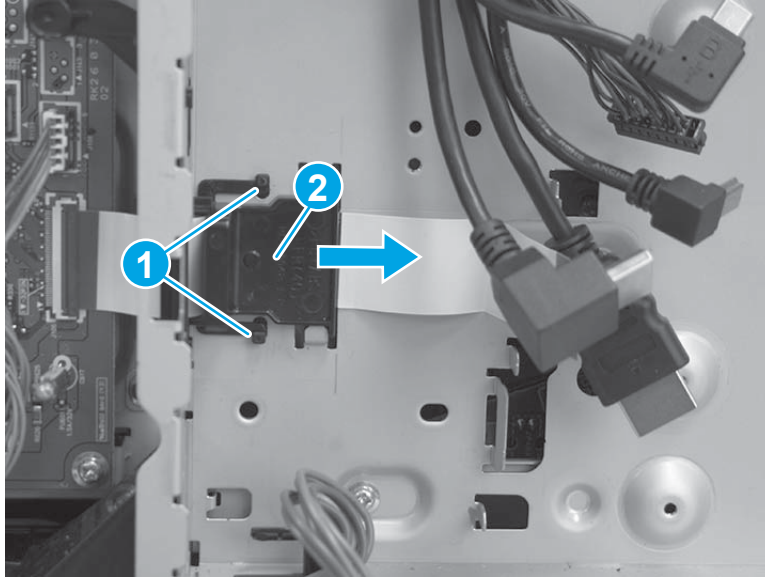

3. Remove two screws (callout 1), and then slide the low-voltage power supply (LVPS) cover to the right to remove it.

Figure 1-2064 Remove the LVPS cover

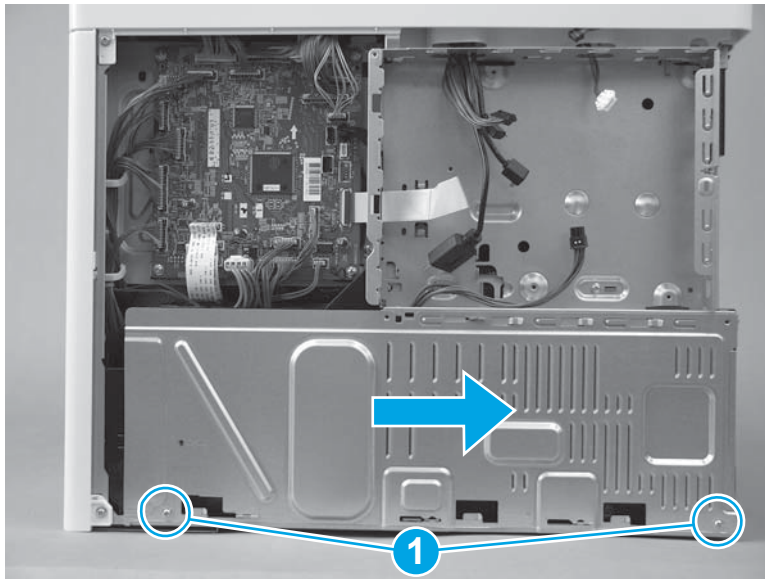

4. Pass two wire harnesses and one flat cable (callout 1) through the opening in the formatter case, and then release one wire harness from the retainer (callout 2).

⚠ CAUTION: The flat cable might be attached to the formatter case with double-sided tape. Make sure that this tape is released, so that the flat cable is not damaged when the formatter case is removed.

Figure 1-2065 Release wire harnesses and flat cable

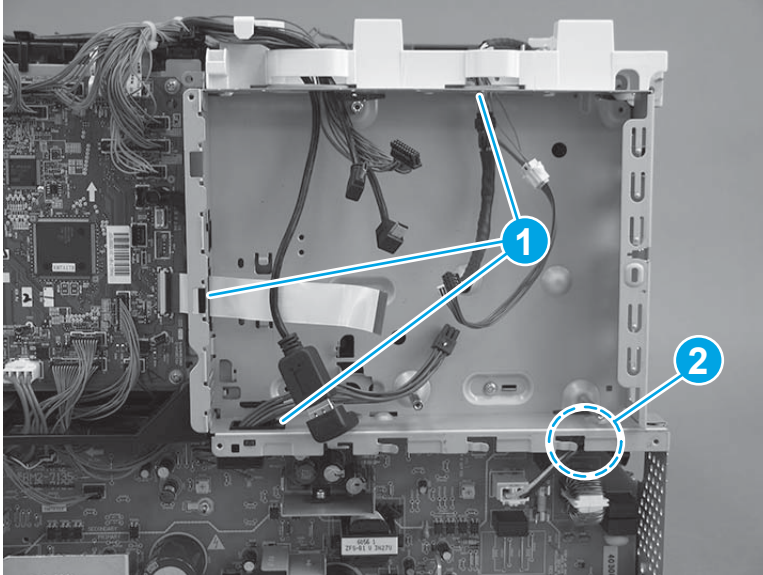

5. Remove six screws (callout 1).

Figure 1-2066 Remove six screws

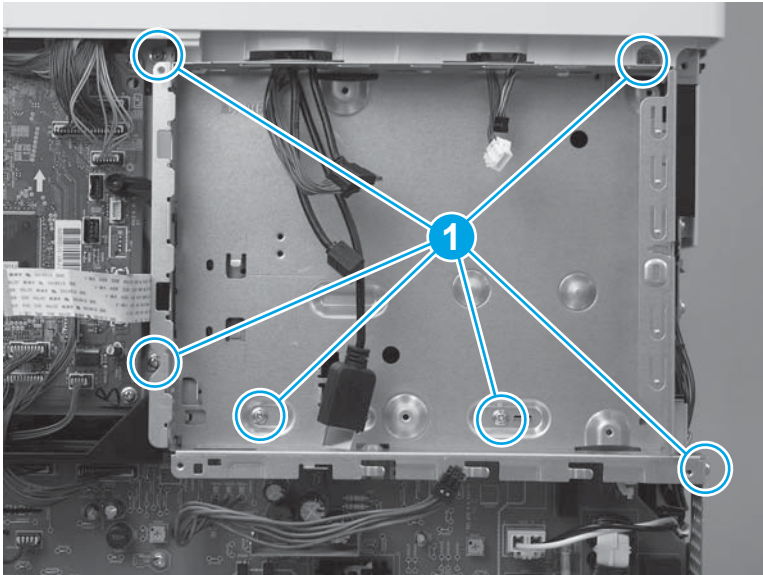

6. Rotate the bottom of the formatter case away from the printer (callout 1), and then pull it down (callout 2) to release it.

Figure 1-2067 Release the formatter case

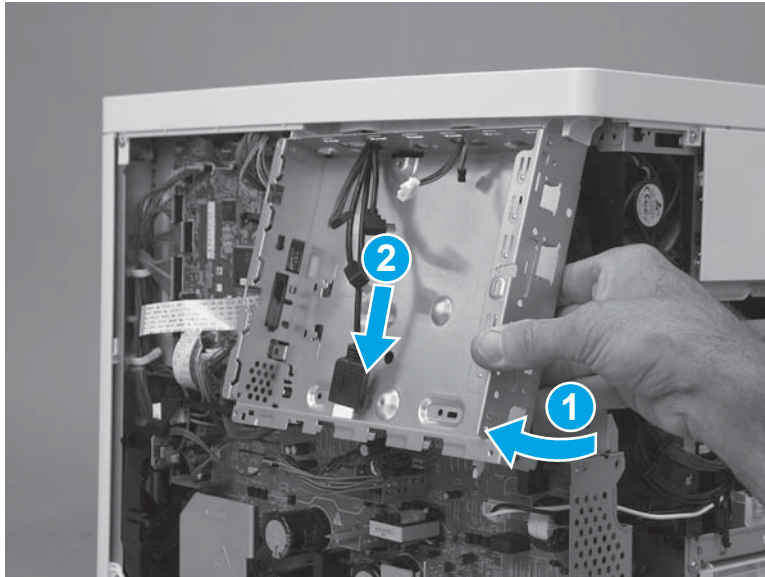

7. Pass the wire harnesses through the opening in the formatter case to remove it.

 **IMPORTANT:** If the formatter case is removed so that it can be replaced, make sure to transfer the memory PCA (island of data) and plastic bracket (callout 1) to the replacement case.

Figure 1-2068 Remove the formatter case



Step 12: Remove the low-voltage power supply (LVPS)

 **CAUTION:**  ESD-sensitive part.

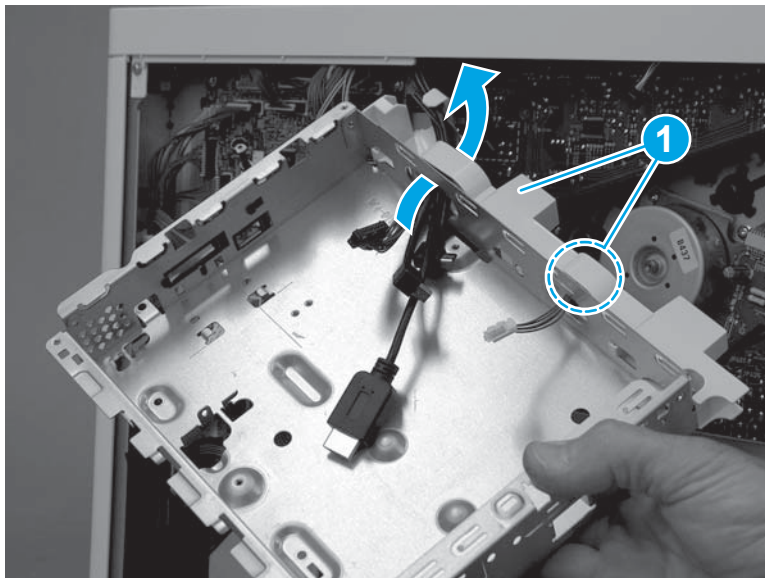
1. Disconnect one wire harness (callout 1), and then pass the wire harness through the opening (callout 2) in the chassis.

Figure 1-2069 Disconnect one wire harness

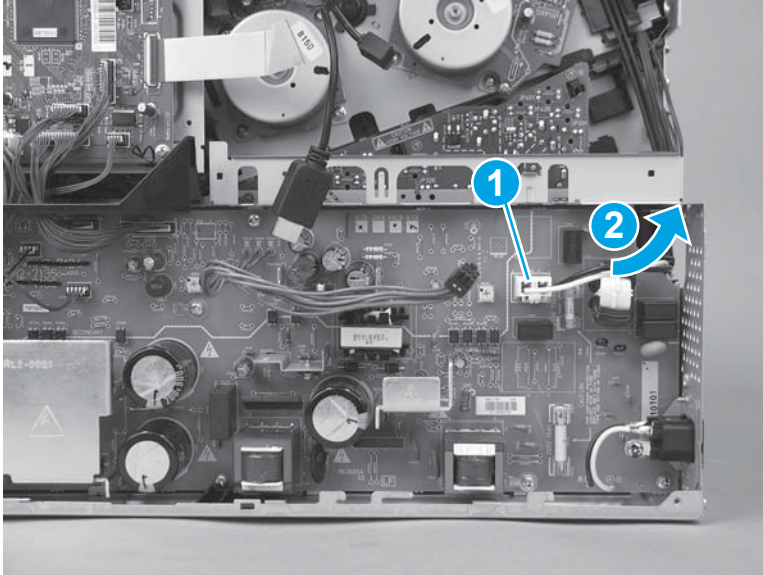

2. Disconnect three connectors on the DC controller (callout 1), and then disconnect four connectors (callout 2) on the LVPS.

Figure 1-2070 Disconnect seven connectors

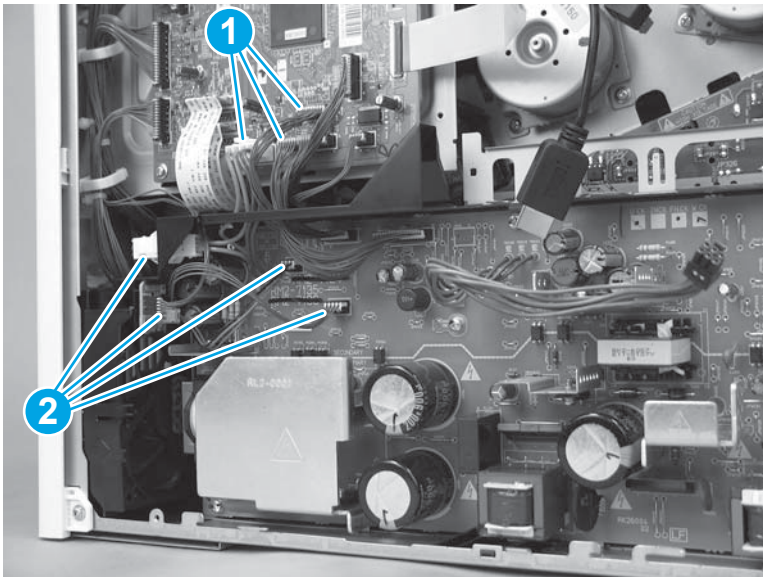

3. Pass the wire harnesses from the DC controller to the LVPS through the opening in the chassis (callout 1), and then release the wire harnesses from the retainer (callout 2).

Figure 1-2071 Pass the wire harnesses through the opening

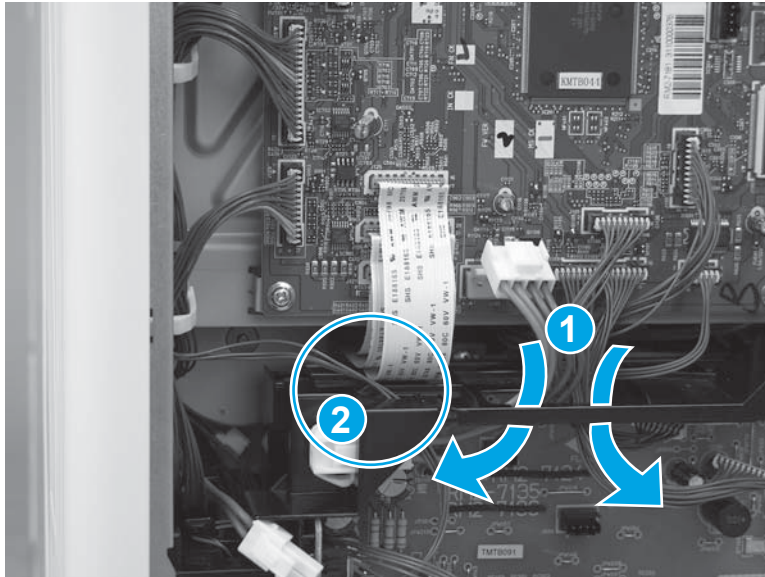

4. Remove three screws (callout 1).

Figure 1-2072 Remove three screws

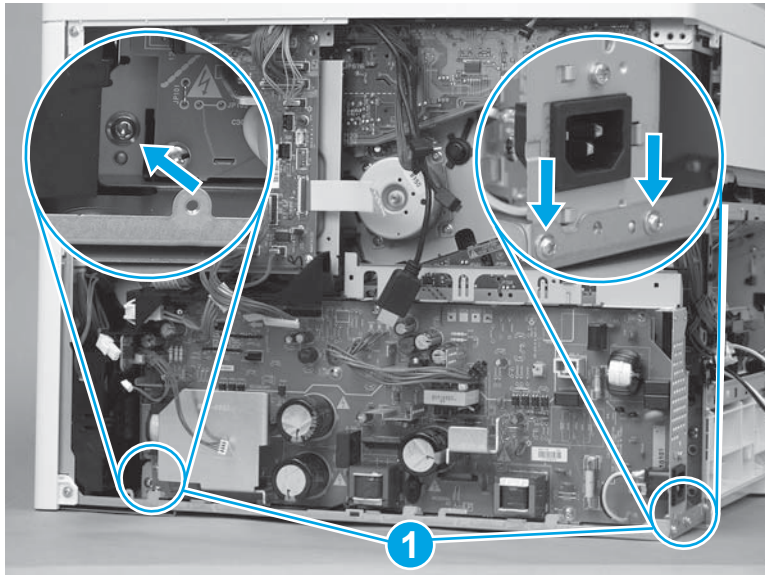

5. Rotate the top of the LVPS away from the printer (callout 1), and then slide it up and out (callout 2) of the printer to remove it.

Figure 1-2073 Remove the LVPS

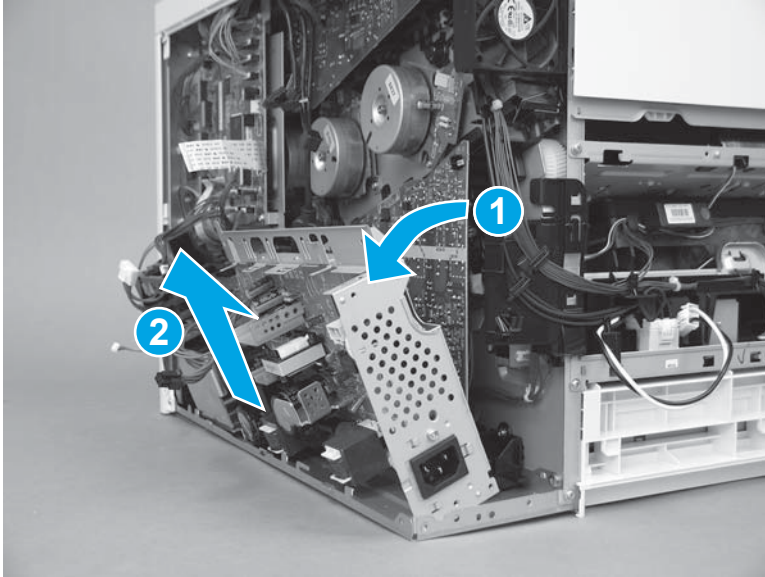

Step 13: Remove the high-voltage power supply D (HVPSD)

 **CAUTION:**  ESD-sensitive part.

1. Disconnect one flat cable (callout 1) on the DC controller.

Figure 1-2074 Disconnect one flat cable

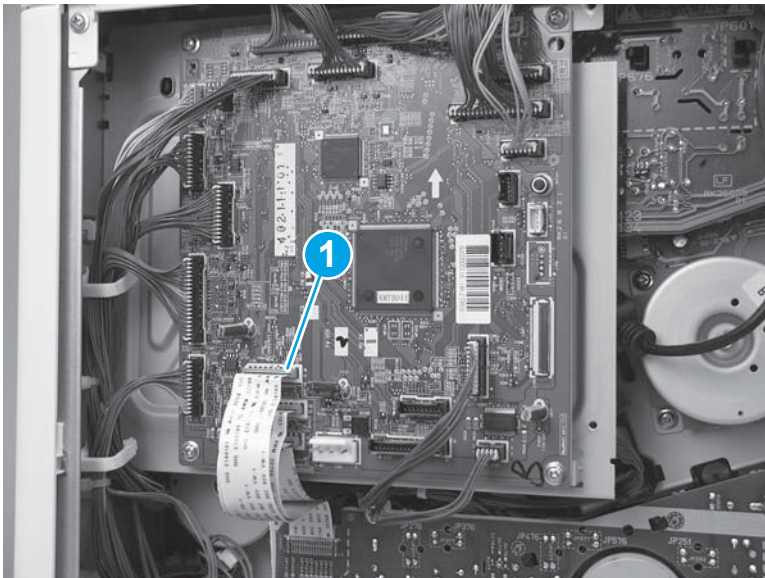

2. Remove two screws (callout 1), and then remove one self tapping screw (callout 2) on the HVPSD.

Figure 1-2075 Remove three screws

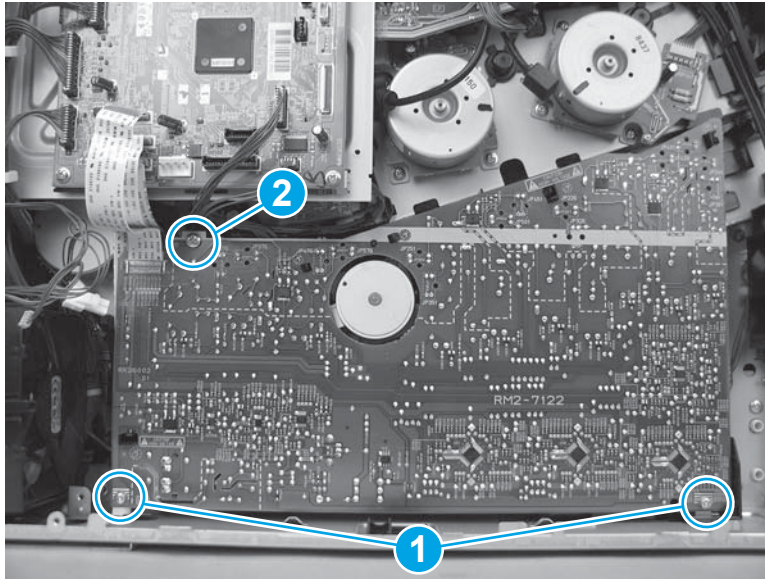

3. Release five tabs (callout 1), and then remove the HVPSD (callout 2).

Figure 1-2076 Remove the HVPSD

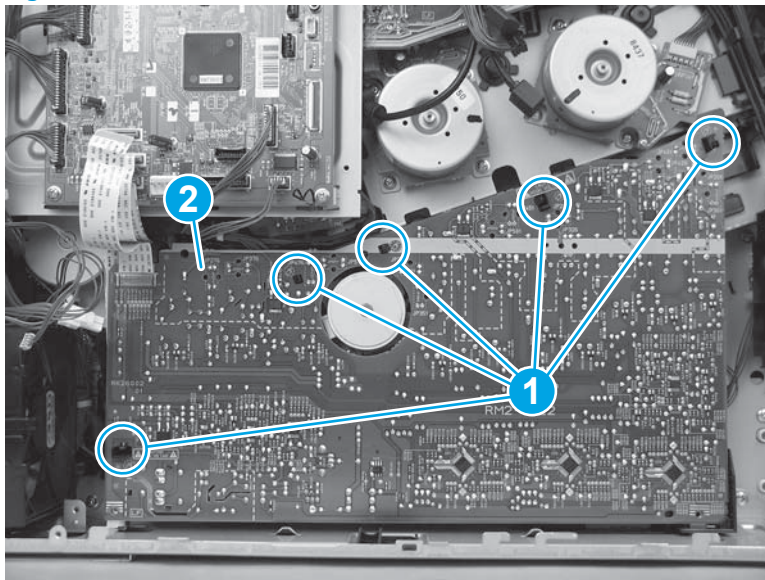

Step 14: Remove the auto close assembly

- ▲ Disconnect four connectors (callout 1/2), remove two screws (callout 3), and then remove the auto close assembly (callout 4).

Figure 1-2077 Remove the assembly

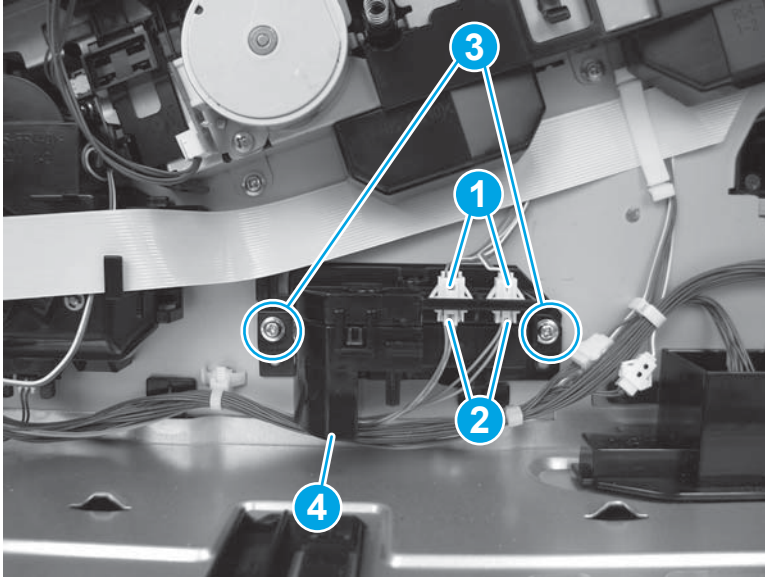

Step 15: Unpack the replacement assembly

Unpack the replacement assembly from the packaging.

For complete information on HP's recycling programs, go to [Product return and recycling](#).

 **NOTE:** HP recommends responsible disposal of the defective assembly.

Figure 1-2078 Recycle and unpack

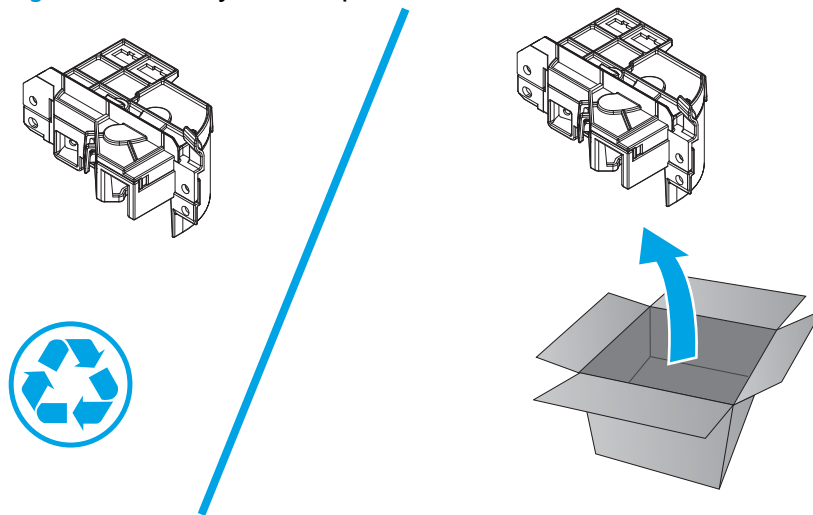

Step 16: Install the auto close assembly

- ▲ Position the auto close assembly on the printer, install two screws (callout 1), and then connect four connectors (callout 2/3).

Figure 1-2079 Install the assembly

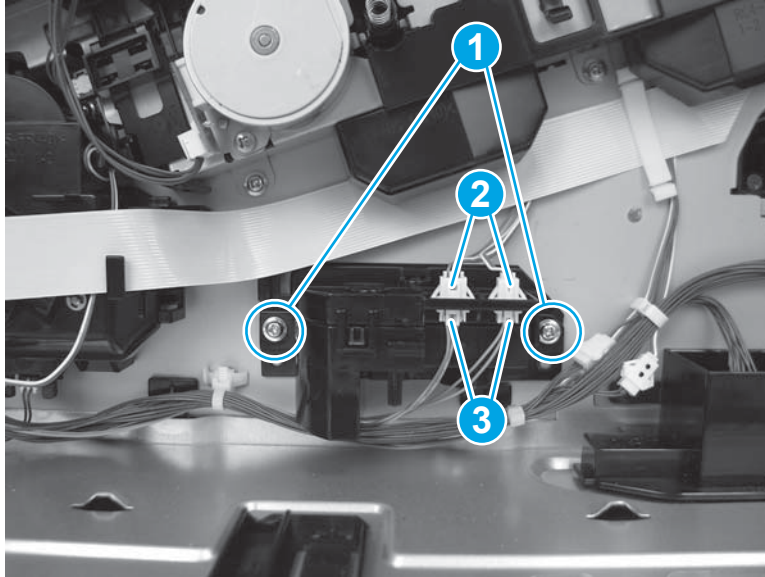

Step 17: Install the HVPSD

 **CAUTION:**  ESD-sensitive part.

1. Position the bottom right corner of the HVPSD (callout 1) behind the black tab, and then rotate it up and onto the printer (callout 2).

Figure 1-2080 Install the HVPSD

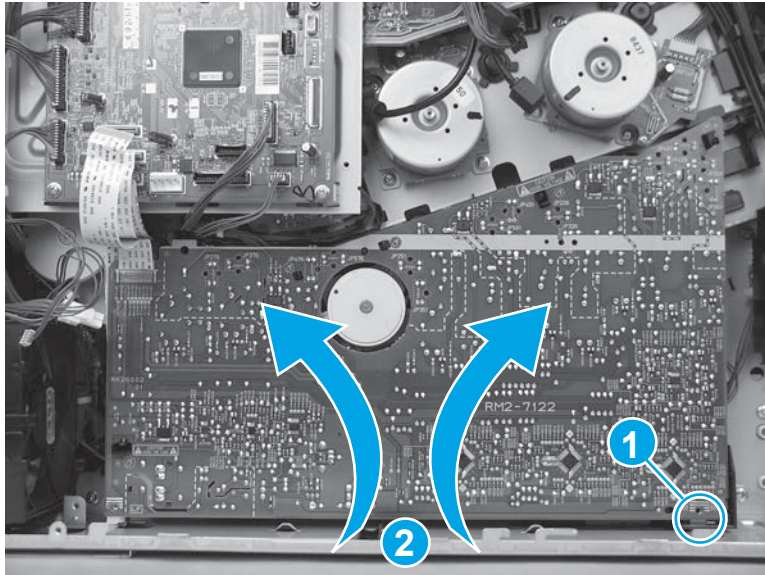

2. Press it onto five tabs (callout 2).

 **IMPORTANT:** Make sure that all five tabs snap into place.

Figure 1-2081 Press the tabs



3. Install two screws (callout 1), and then install one self tapping screw (callout 2) on the HVPSD.

Figure 1-2082 Install three screws

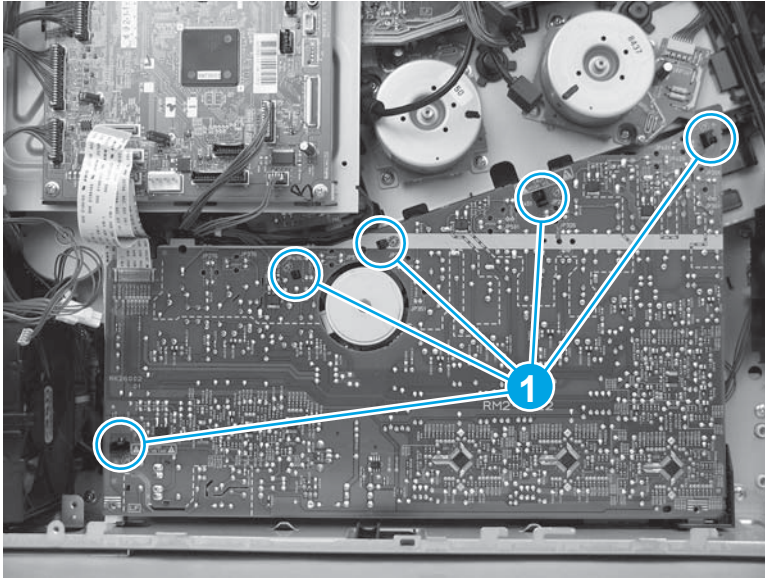
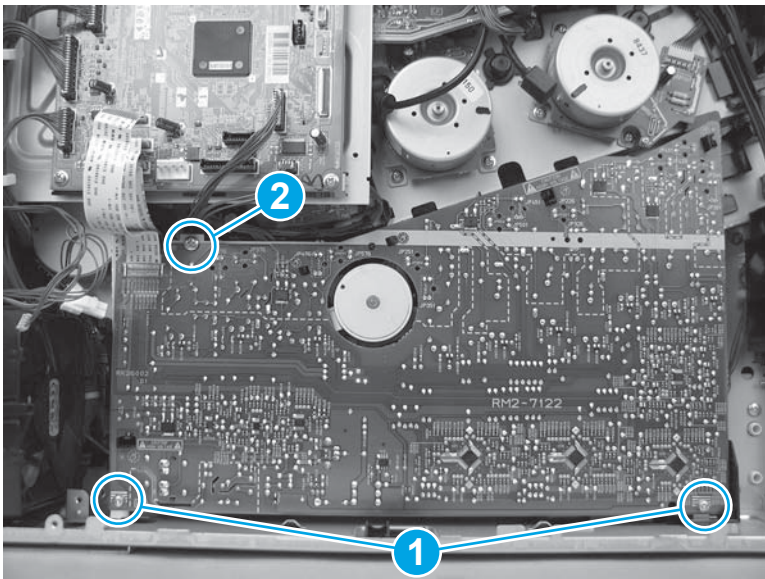

4. Connect one flat cable (callout 1) on the DC controller.

Figure 1-2083 Connect one flat cable

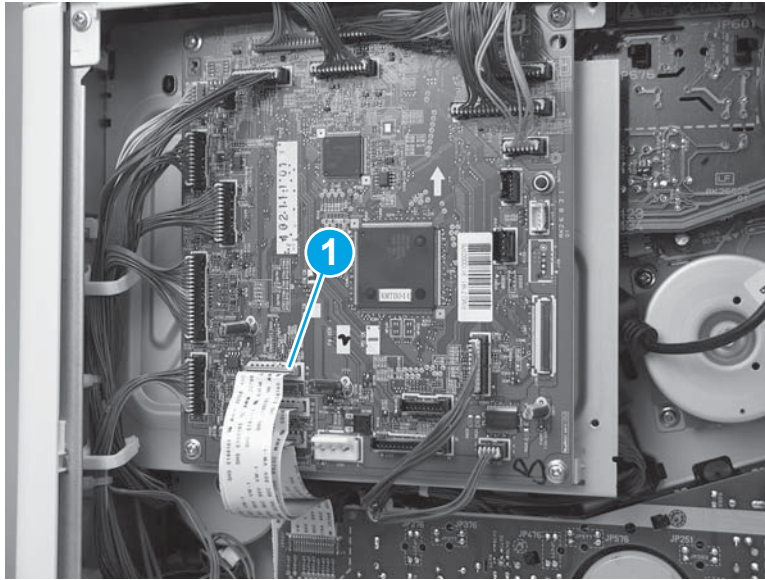

Step 18: Install the LVPS

CAUTION:  ESD-sensitive part.

1. Position the bottom of the LVPS in the printer (callout 1) at a slight angle, and then rotate the top of it into the printer (callout 2) to install it.

Figure 1-2084 Install the LVPS

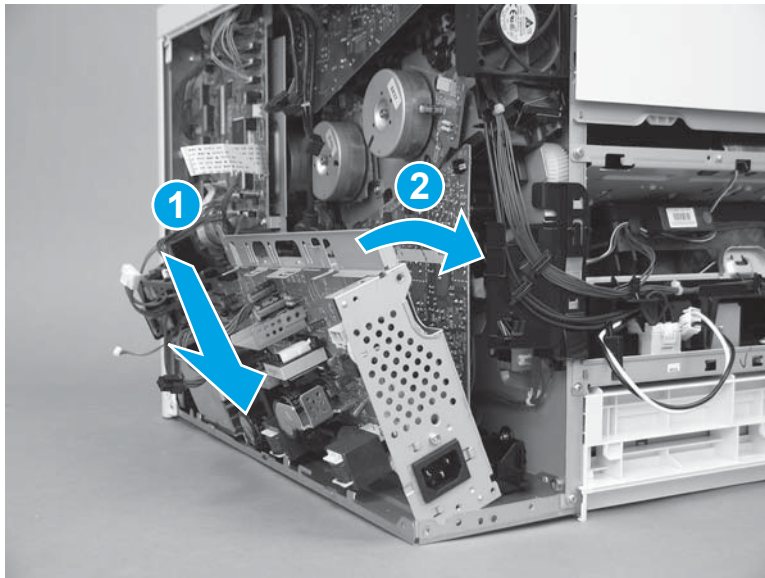

2. Install three screws (callout 1).

Figure 1-2085 Install three screws

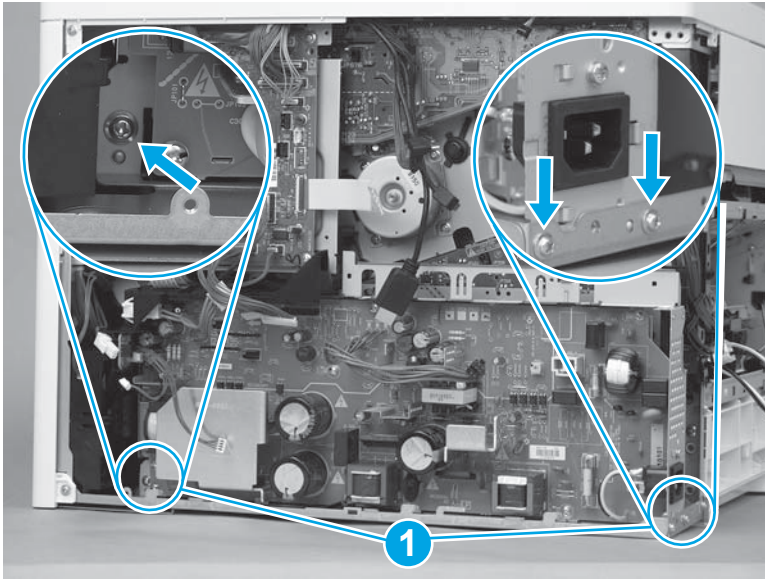

3. Pass the wire harnesses from the DC controller to the LVPS through the opening in the chassis (callout 1), and then install the wire harnesses in the retainer (callout 2).

Figure 1-2086 Pass the wire harnesses through the opening

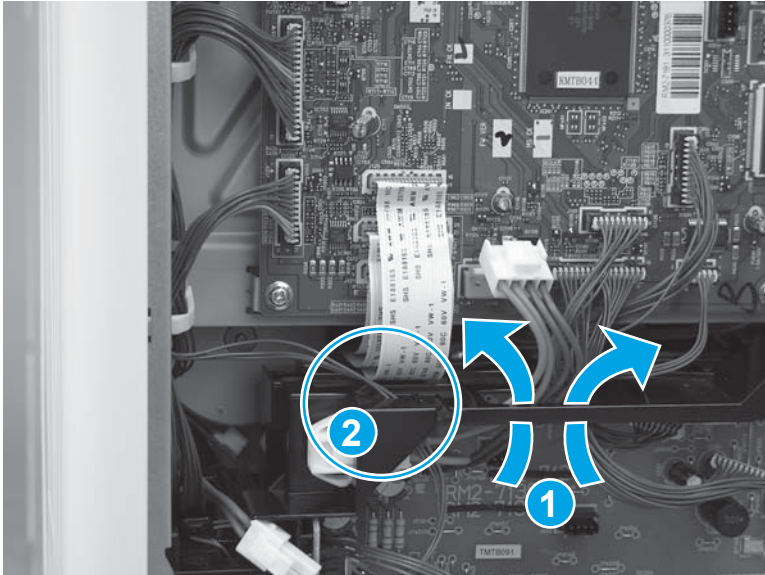

4. Connect three connectors on the DC controller (callout 1), and then connect four connectors (callout 2) on the LVPS.

Figure 1-2087 Connect seven connectors

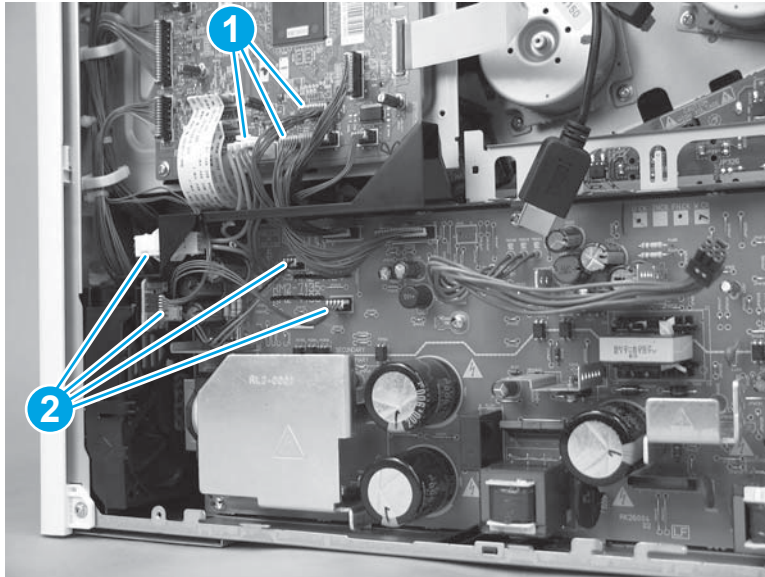

5. Pass the wire harness through the opening (callout 1) in the chassis, and then connect one wire harness (callout 2).

Figure 1-2088 Connect one wire harness

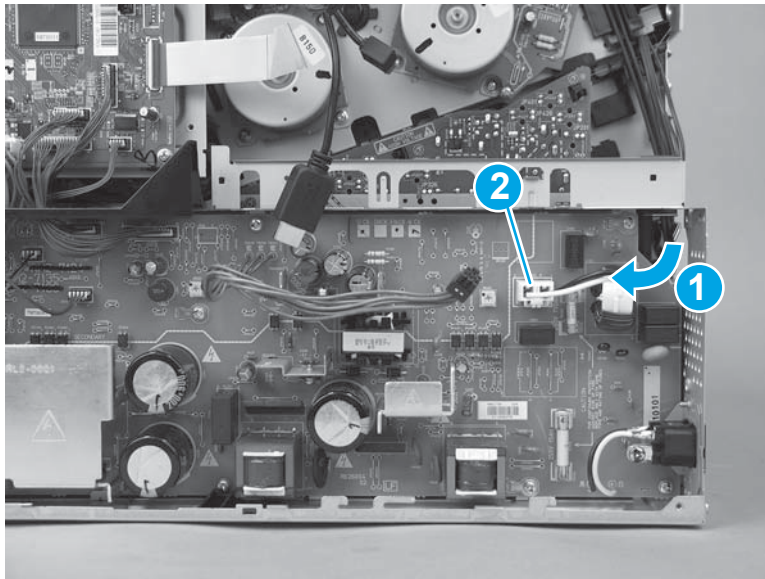

Step 19: Install the formatter case

1. Pass the wire harnesses through the opening in the formatter case.

Figure 1-2089 Pass the wire harnesses through the opening

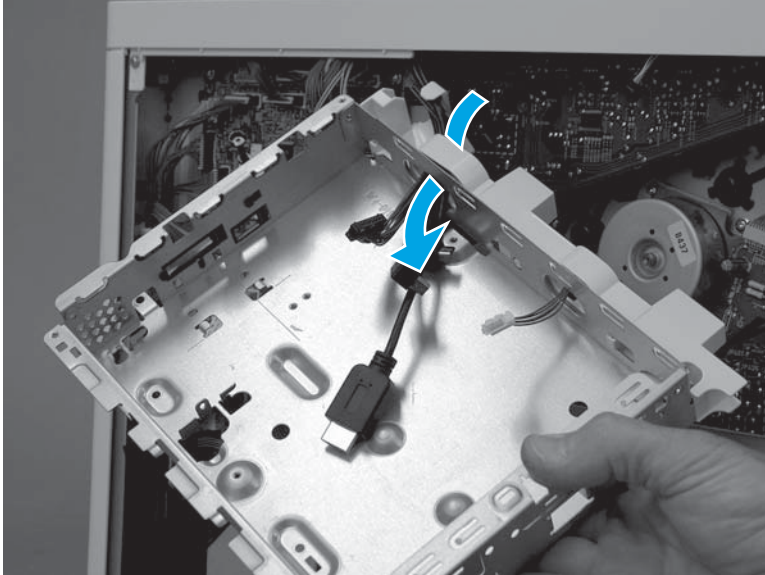

2. Position the top of the formatter case on the printer (callout 1), and then rotate the bottom of the case (callout 2) into the printer.

Figure 1-2090 Install the formatter case

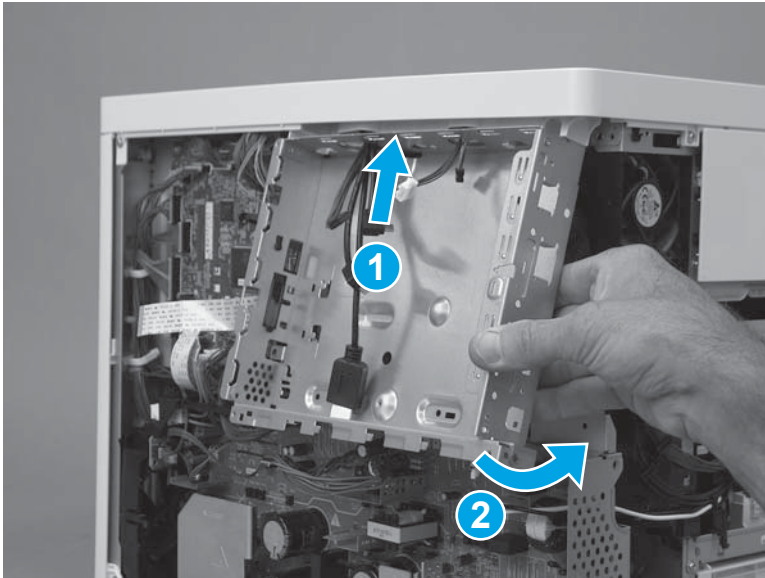

3. Install six screws (callout 1).

Figure 1-2091 Install six screws

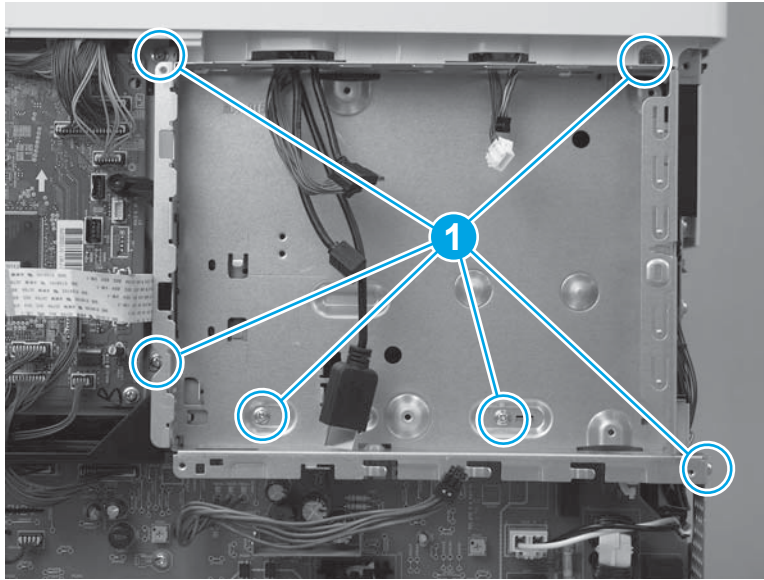

4. Pass two wire harnesses and one flat cable (callout 1) through the opening in the formatter case, and then install one wire harness in the retainer (callout 2).

 **IMPORTANT:** Make sure that the flat cable is securely fastened to the DC controller, and was not dislodged when the formatter case was removed.

Figure 1-2092 Install wire harnesses and flat cable



5. Position the LVPS cover on the printer, slide the cover to the left to install it, and then install two screws (callout 1).

Figure 1-2093 Install the LVPS cover

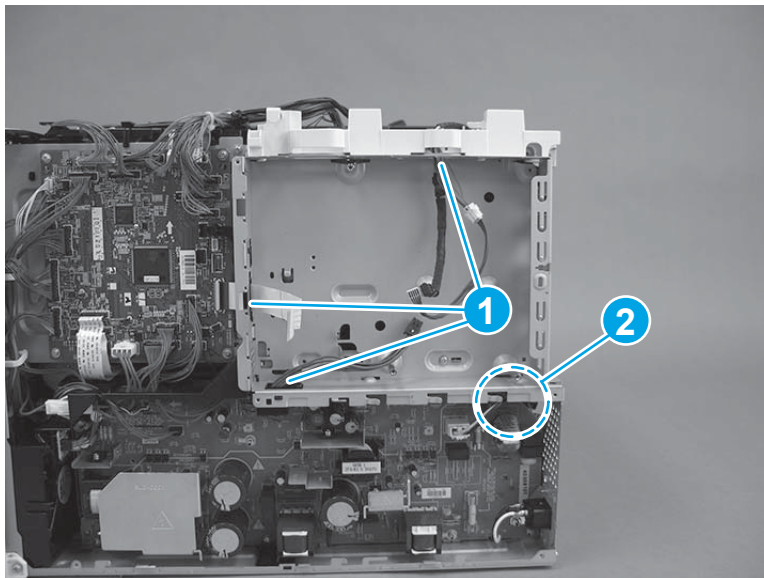
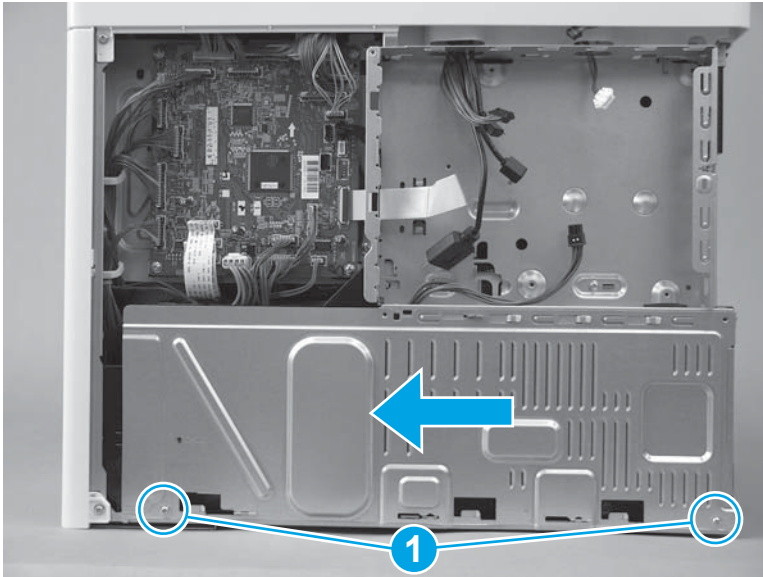

6. If no tape is affixed to the back of the flat cable, skip this step. If double-sided tape is affixed to the back of the flat cable, align the line (callout 1) on the cable with the edge (callout 2) of the opening in the sheet metal. Press to attach the flat cable to the formatter case.

Figure 1-2094 Attach the flat cable

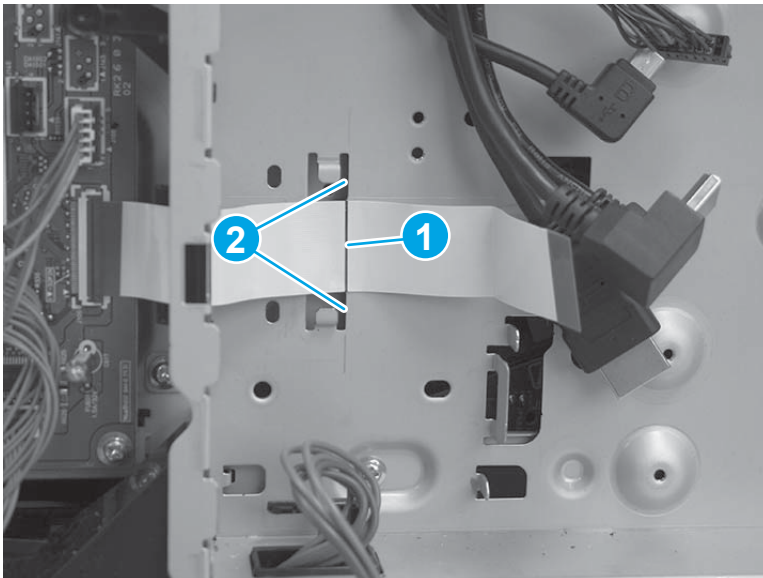

7. Position the bracket over the flat cable, and then slide the bracket to the left to install it. Make sure that the edges of the bracket fit under the sheet metal tabs (callout 1) on the formatter case and that the tabs (callout 2) snap into place.

Figure 1-2095 Position the bracket

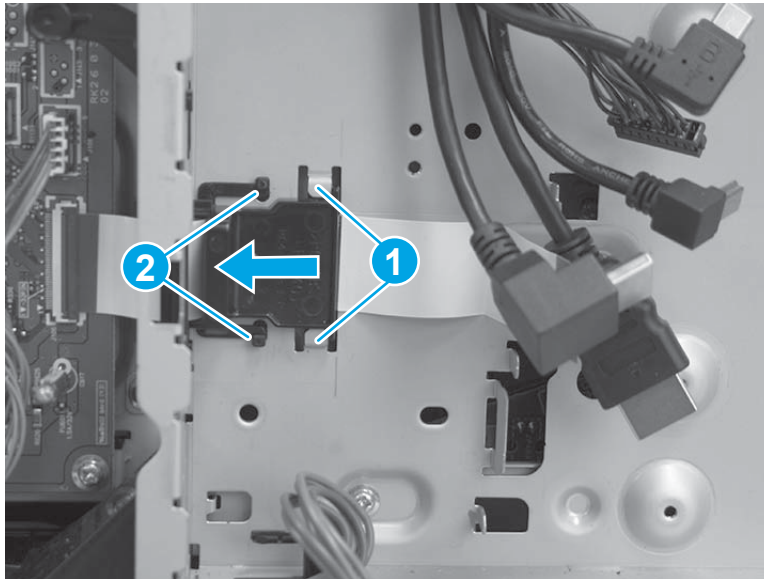

8. **M577 only:** Pass the wire harness (callout 1) through the openings in the formatter case (callout 2), and then connect one connector (callout 3).

Figure 1-2096 Connect one connector

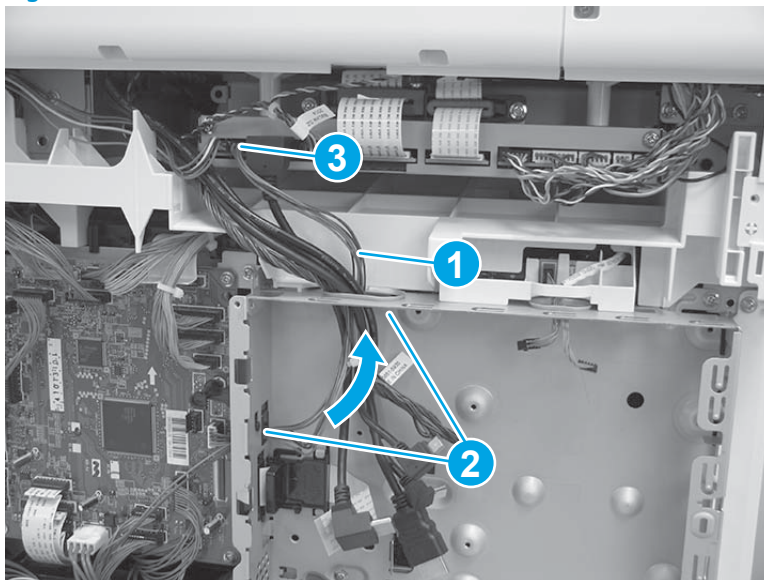

Step 20: Install the left cover

1. Position the cover on the printer.

 **NOTE:** Slightly offset the cover toward the rear of the printer.

Figure 1-2097 Install the cover

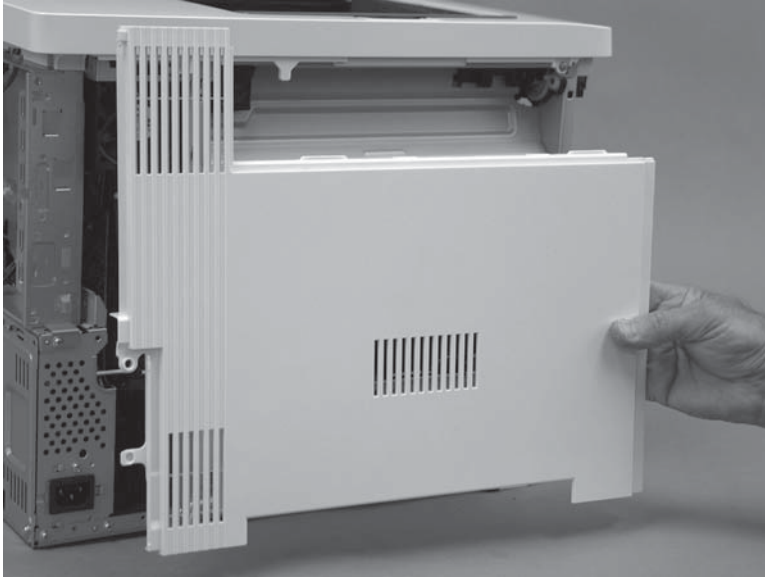

2. Slide the cover (callout 1) toward the front of the printer to engage it. Make sure that the tab (callout 2) snaps into place.

 **NOTE:** Locate the alignment pin (callout 3) on the cover from the front door side of the printer, and then make sure that it is fully engaged in the slot in the chassis.

 **TIP:** While sliding the cover into place, push in on the center of the cover (callout 1) to make sure that the hooks on the back of the cover engage with the slots in the chassis.

Figure 1-2098 Engage the cover



3. At the left side of the printer, install one screw (callout 1).

Figure 1-2099 Install one screw

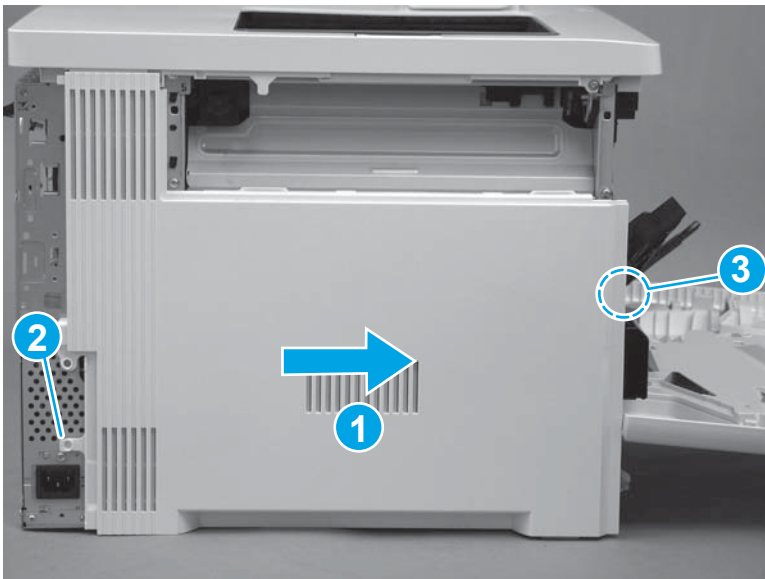

Step 21: Install the rear cover (M577)

 **NOTE:** This step is for the M577 models. For the M552 and M553 models, skip this step and go to [Step 23: Install the rear cover \(M552 and M553\) on page 1200](#).

1. Position the hooks (callout 1) on the cover in the slots (callout 2) in the printer.

Figure 1-2100 Position the hooks

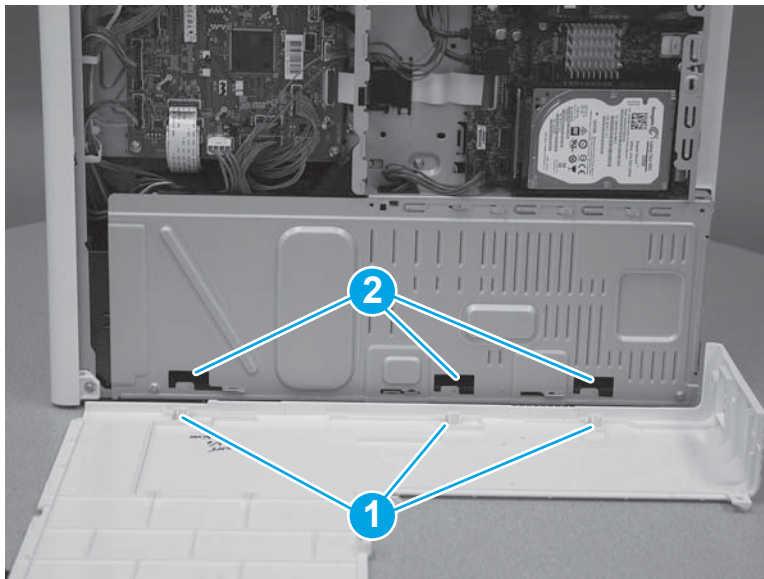

2. Position the back edge (callout 1) of the rear cover behind the edge (callout 2) of the right rear cover. Slide the cover to the left to install it.

Figure 1-2101 Install the cover

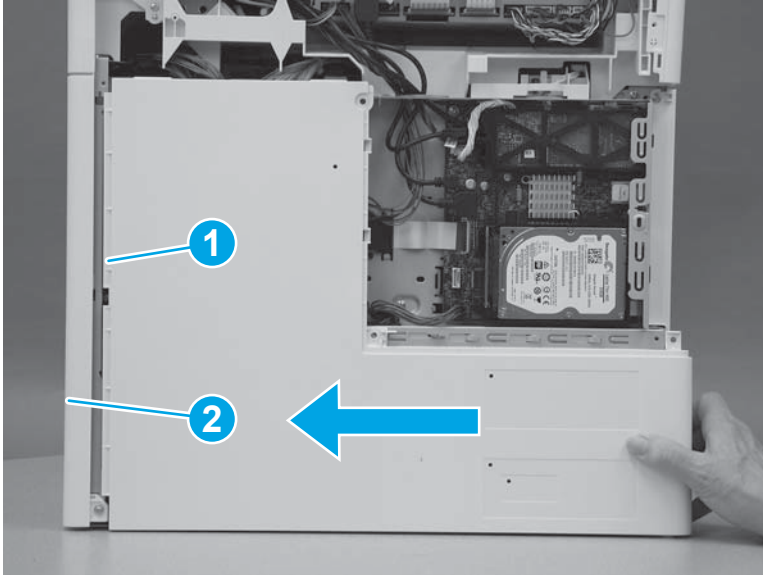

3. Install four screws (callout 1).

Figure 1-2102 Install four screws cover

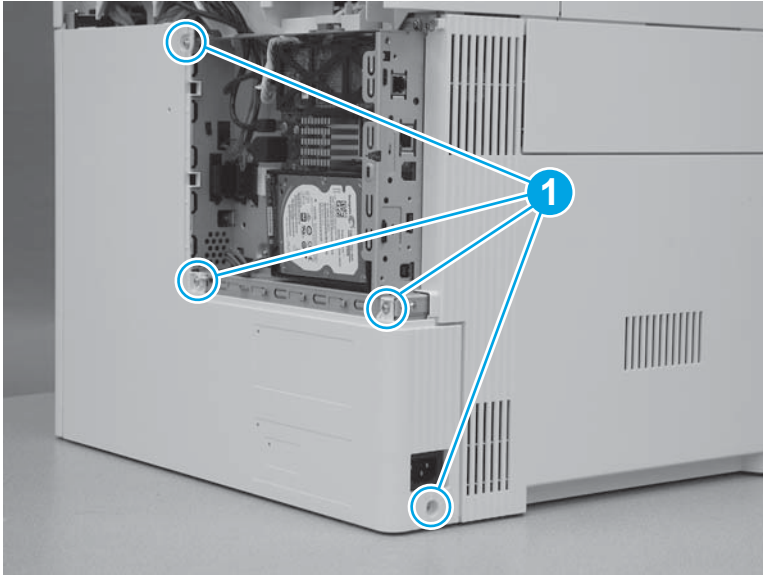

Step 22: Install the rear upper cover (M577)



NOTE: This step is for the M577 models. For the M552 and M553 models, skip this step and go to [Step 23: Install the rear cover \(M552 and M553\) on page 1200.](#)

1. Align the ridge (callout 1) on the lower edge of the rear upper cover in front of the tabs (callout 2) on the top edge of the rear cover.

Figure 1-2103 Align the cover

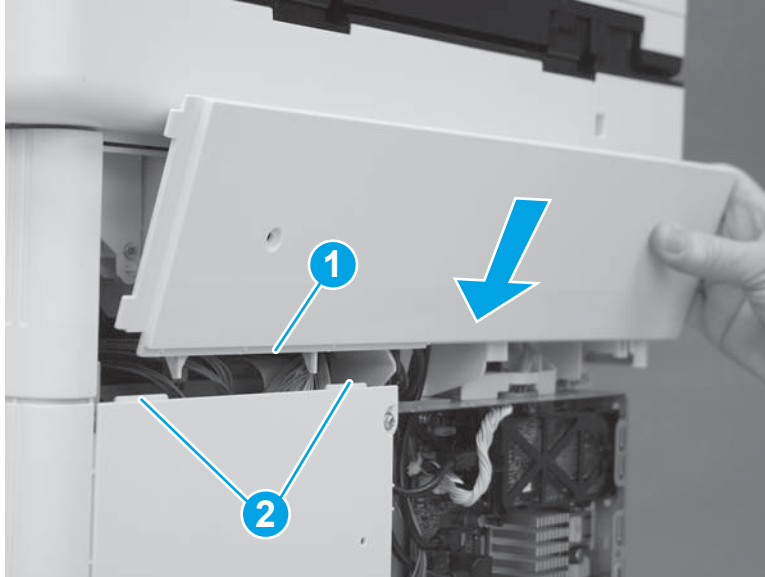

2. Rotate the top of the cover toward the printer.

Figure 1-2104 Rotate the top of the cover



3. Slide the cover to the left (callout 1). Make sure that the tabs (callout 2) on the upper rear cover slide behind the edge (callout 3) of the right upper cover. Make sure that the cover is fully seated.

Figure 1-2105 Slide the cover

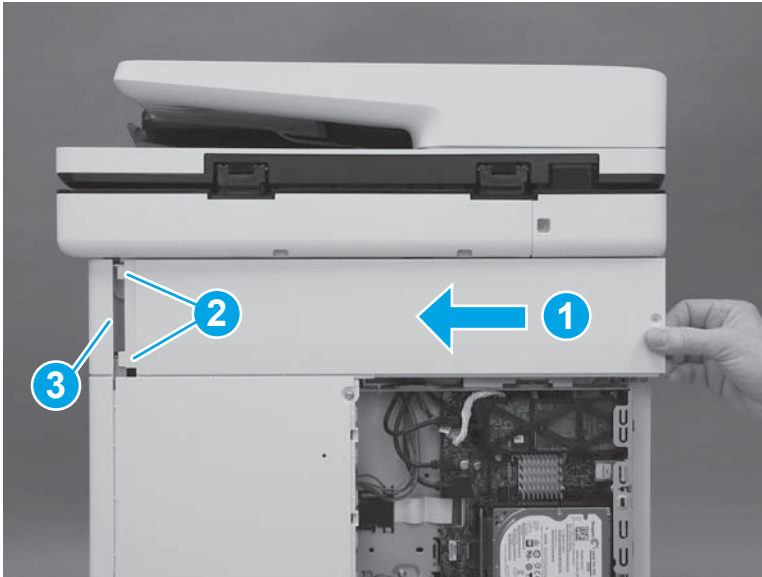

4. Install two screws (callout 1).

 **IMPORTANT:** These two screws are self-tapping screws for plastic. Rotate them counterclockwise to align them with the existing thread pattern, and then carefully turn them clockwise to tighten. Do not overtighten. This will prevent stripping the threads inside the screw holes.

Figure 1-2106 Install two screws



Step 23: Install the rear cover (M552 and M553)

 **NOTE:** This step is for the M552 and M553 models. For the M577 models, skip this step and go to [Step 24: Install the formatter \(M577\) on page 1201](#).

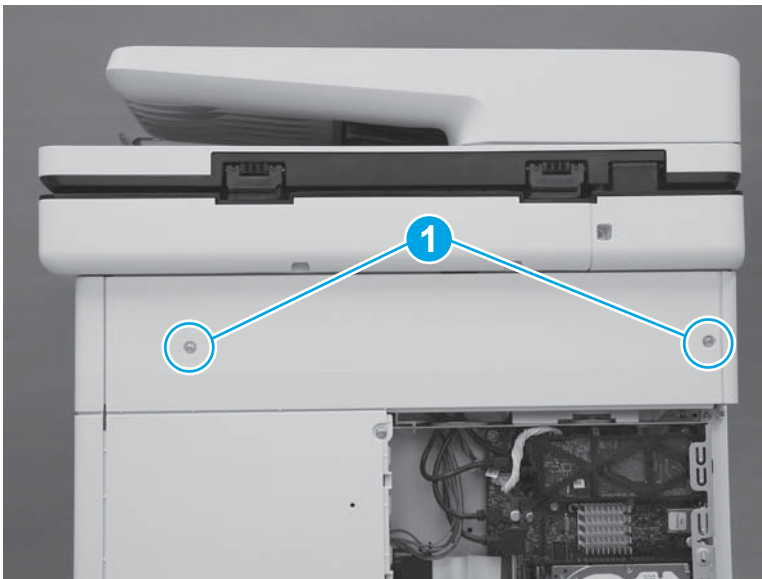
1. Position the top of the cover under the upper cover (callout 1), rotate the bottom of the cover onto the chassis (callout 2), and then slide the cover to the left (callout 3) to install it.

Figure 1-2107 Install the cover

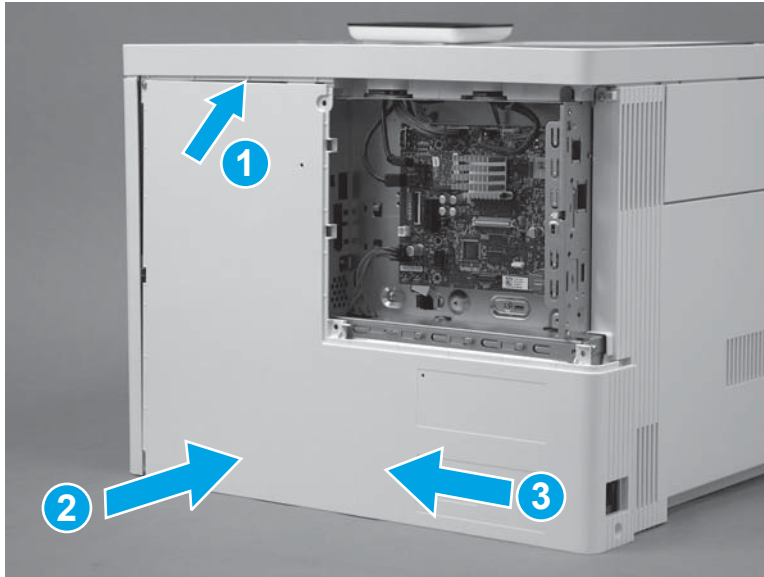

2. Install four screws (callout 1).

Figure 1-2108 Install four screws cover

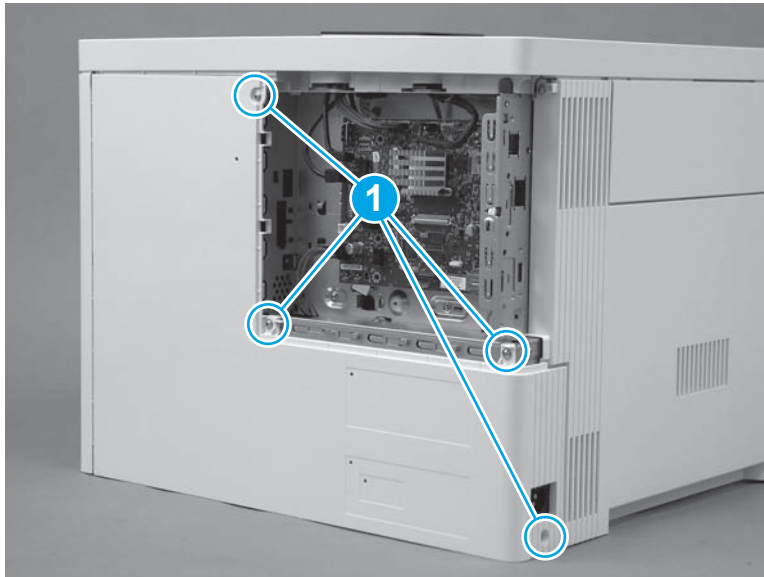

Step 24: Install the formatter (M577)

 **NOTE:** This step is for the M577 models. For the M552 and M553 models, skip this step and to go [Step 27: Install the formatter \(M552 and M553\) on page 1206](#).

 **CAUTION:**  ESD-sensitive part.

1. Position the formatter in the printer. Make sure that the network port (callout 1) fits through the opening (callout 2) in the formatter case.

Figure 1-2109 Install the formatter

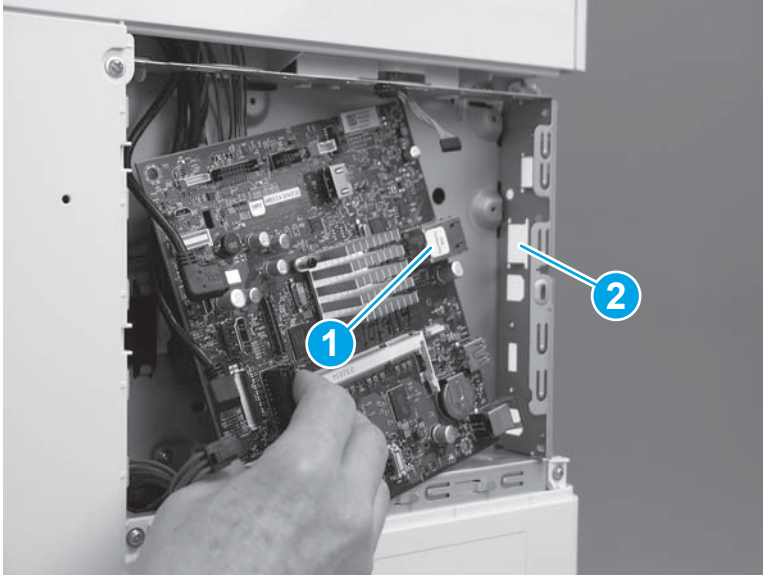

2. Install four screws (callout 1).

Figure 1-2110 Install four screws

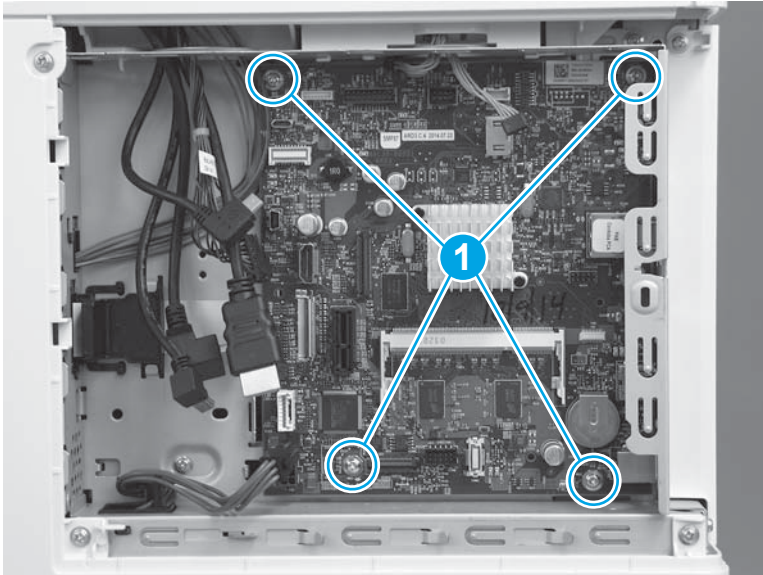

3. Connect all of the connectors on the formatter.

The following connectors are empty:

- All models: J1 (this connector is empty unless the optional DIMM is installed)
- All models: J3
- M577dn: J15 (this is the fax connector for the M577f/z/c models)
- All models: J21 (this connector is empty unless the optional internal USB ports component is installed)
- All models: J23

- All models: J24
- All models: J51
- All models: J57
- All models: J97
- All models: J98 (this connector is empty unless the optional trusted platform module (TPM) is installed)



 **IMPORTANT:** The flat-cable connector (callout 1) is a Zero Insertion Force (ZIF) connector that uses a hinged retainer to secure the flat cable. The hinged retainer must be opened to install the flat cable, and then closed after the cable is installed.

Figure 1-2111 Connect all connectors

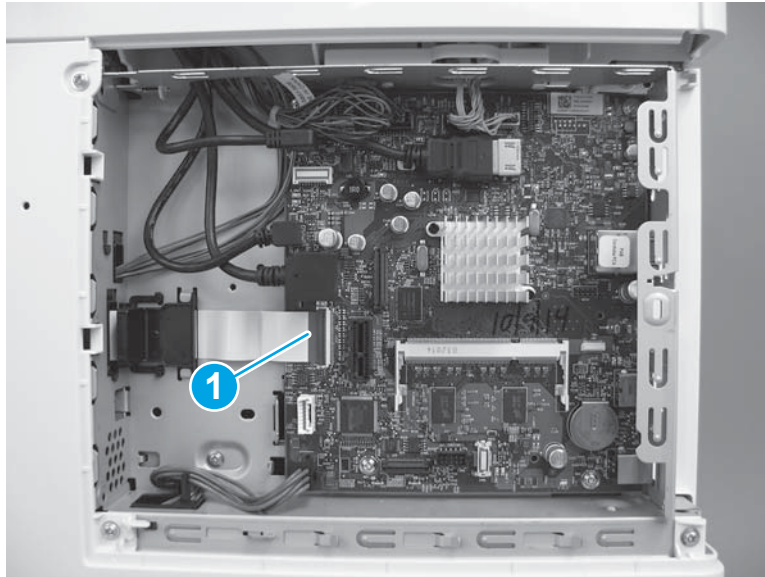

Step 25: Install the fax PCA (M577c/f/z)

 **NOTE:** This step is for the M577c/f/z models. For the M577n model, skip this step and go to [Step 26: Install the HDD \(M577\) on page 1205](#).

For the M552 and M553 models, skip this step and go to [Step 27: Install the formatter \(M552 and M553\) on page 1206](#).

 **CAUTION:**  ESD-sensitive part.

1. Position the tab and telephone port (callout 1) on the fax PCA in the slots (callout 2) in the formatter case.

Figure 1-2112 Position the fax PCA

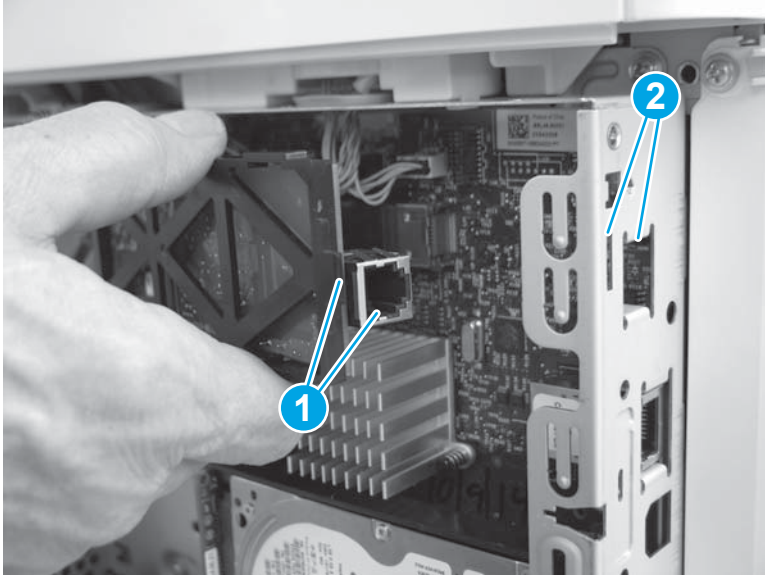

2. Slide the fax PCA to the right (callout 1) until the tab and telephone port described in the previous step and seated in the formatter case. Position the retainer (callout 2) in the slot (callout 3) in the formatter. Rotate the end of the fax PCA toward the formatter (callout 4) until the retainer snaps into place.

Figure 1-2113 Install the fax PCA

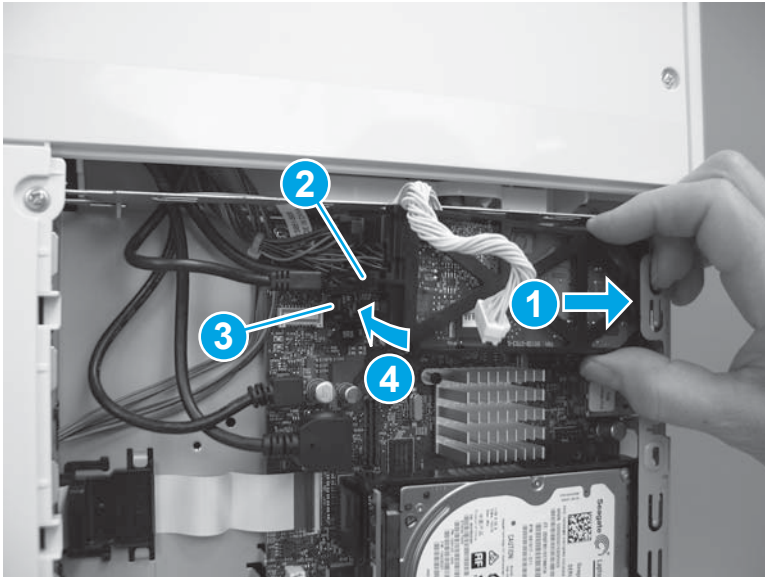

3. Position the cable (callout 1) in the guide (callout 2), and then connect one connector (callout 3).

Figure 1-2114 Connect the connector

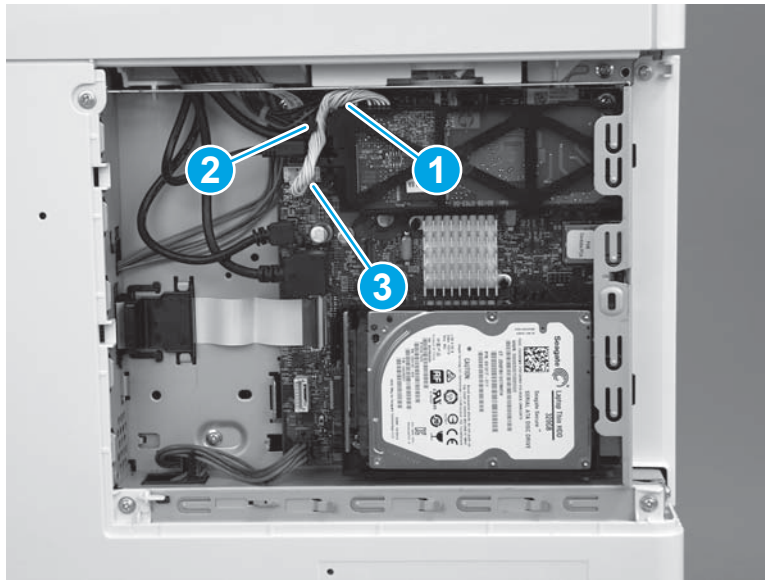

Step 26: Install the HDD (M577)

 **NOTE:** This step is for the M577 models. For the M552 and M553 models, skip this step and go to [Step 27: Install the formatter \(M552 and M553\)](#) on page 1206.

 **CAUTION:**  ESD-sensitive part.

1. Align the end of the bracket (callout 1) with the slot in the chassis (callout 2), and then slide the HDD into the printer (callout 3) to engage the bracket with the chassis.

Figure 1-2115 Install the holder

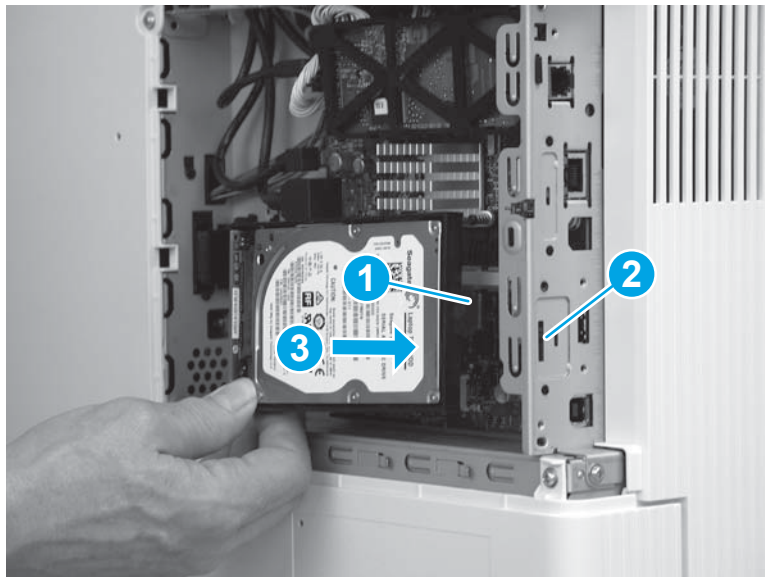

2. Hold the HDD connector latch (callout 1) in the released position, and then rotate the HDD down and into the connector on the formatter to install it.

 **NOTE:** Make sure that the tab (callout 2) snaps into place, and that the HDD is securely installed.

Figure 1-2116 Release the HDD

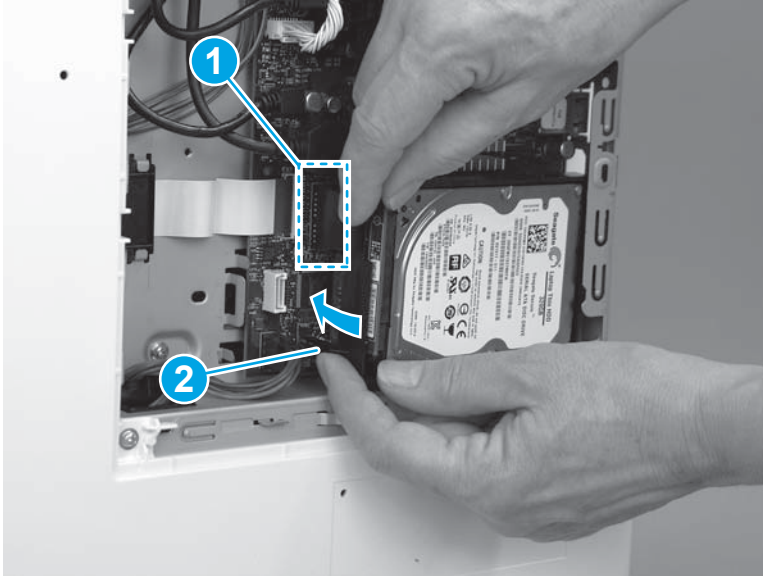

Step 27: Install the formatter (M552 and M553)

 **NOTE:** This step is for the M552 and M553 models. For the M577 models, skip this step and go to [Step 28: Install the formatter cover on page 1208](#).

If the optional hard-disk drive (HDD) was removed, do not forget to reinstall it after the formatter is reinstalled.

Engage the HDD holder with the chassis, rotate the HDD connector down and into the connector on the formatter. Make sure that the tabs snap into place.

 **CAUTION:**  ESD-sensitive part.

1. Position the formatter in the printer, and then install four screws (callout 1).

Figure 1-2117 Install the formatter

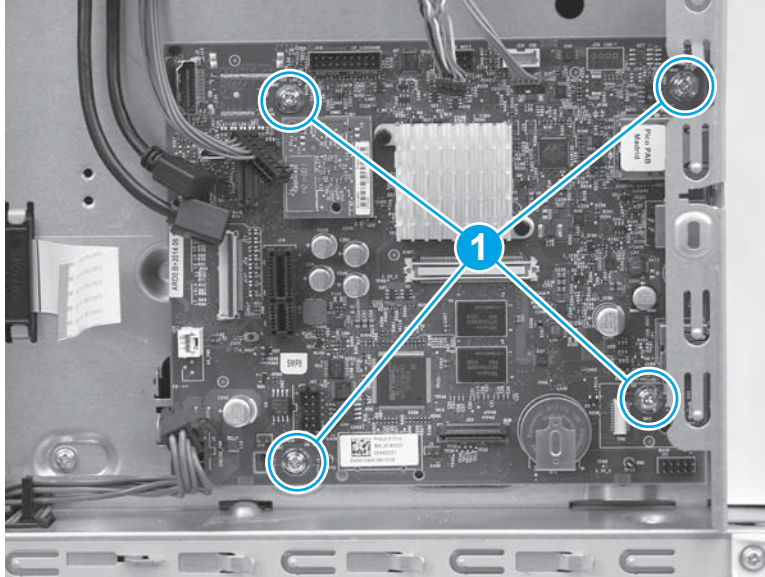

2. Connect all of the connectors on the formatter.

The following connectors are empty:

- All models: J1 (this connector is empty unless the optional DIMM is installed)
- M553n/dn and M552dn: J2 (callout 1; this is the touchscreen connector for the M553x model)
- All models: J9 (this connector is empty unless the optional internal USB ports component is installed)
- All models: J18 (this connector is empty unless the optional hard-disk-drive (HDD) is installed)
- All models: J23
- All models: J24
- M553n/dn and M552dn: J25 (this is the wireless connector for the M553x model)
- All models: J57
- All models: J98 (this connector is empty unless the optional trusted platform module (TPM) is installed)



 **IMPORTANT:** The flat-cable connector (callout 2) is a Zero Insertion Force (ZIF) connector that uses a hinged retainer to secure the flat cable. The hinged retainer must be opened to install the flat cable.

Figure 1-2118 Connect all connectors

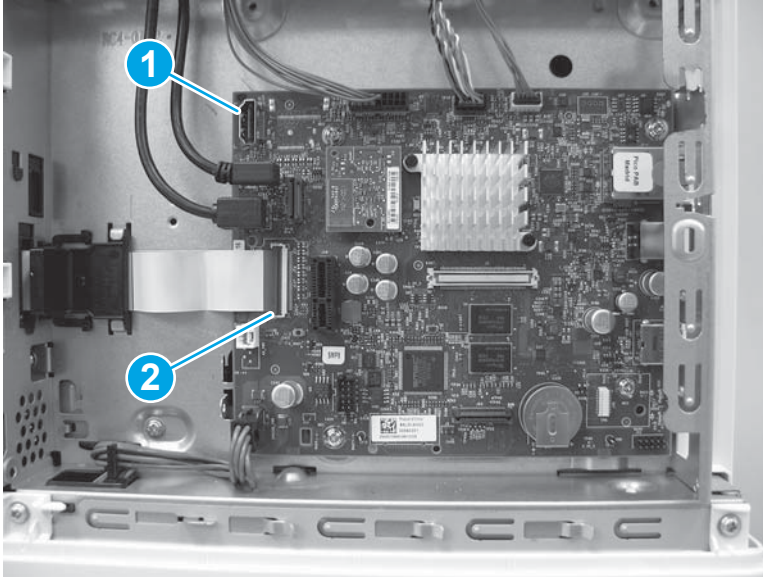

Step 28: Install the formatter cover

- ▲ Slide the cover onto the printer (callout 1) to install it.

 **NOTE:** Make sure that the tabs on the formatter cover align with the slots provided in the printer (callout 2). Tighten the two thumbscrews (callout 3).

 **TIP:** If needed, use the edge of a coin to turn the thumbscrews.

Figure 1-2119 Install the cover



Step 29: Install the TCU

1. Verify that the toner collection hatch cover is in the closed position on the TCU.

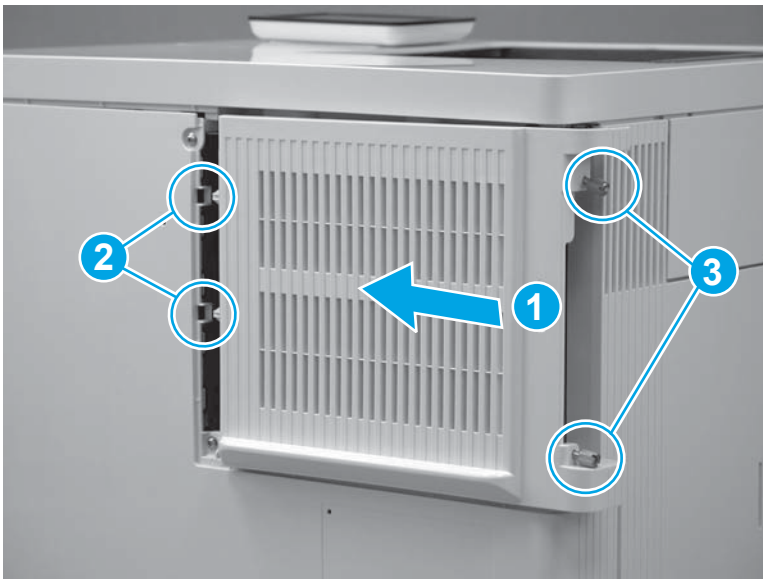
Figure 1-2120 Verify that the toner collection hatch cover is closed

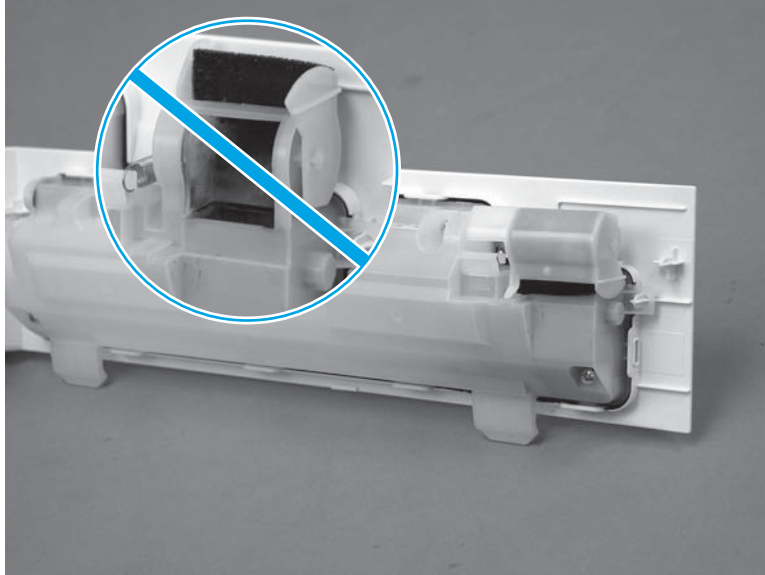

2. Position the TCU with the hinges in the slots provided in the printer (callout 1), and then rotate the TCU up and into the closed position.

 **NOTE:** The toner collection hatch cover automatically opens when the TCU is closed.

Figure 1-2121 Install the TCU



3. Close the front door.

Figure 1-2122 Close the front door

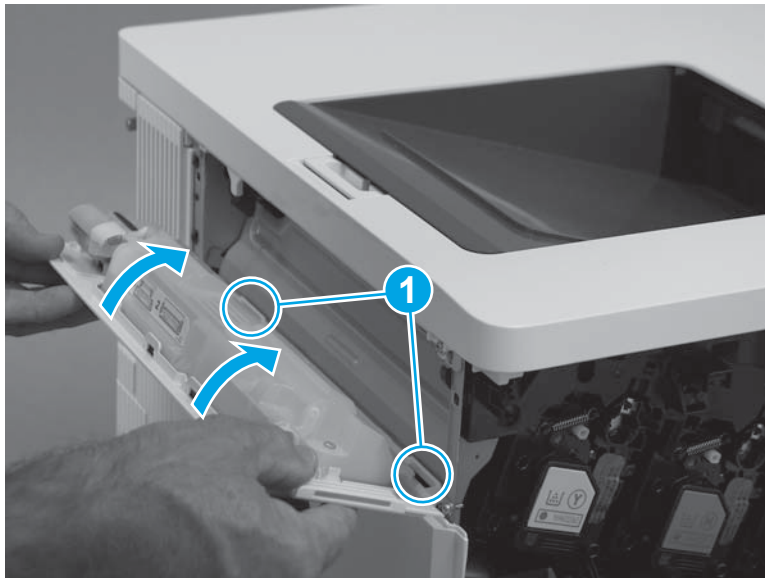

Removal and replacement: Lifter drive assembly

- [Introduction](#)
- [Step 1: Remove the toner collection unit \(TCU\)](#)
- [Step 2: Remove the formatter cover](#)
- [Step 3: Remove the formatter \(M552 and M553\)](#)
- [Step 4: Remove the hard-disk drive \(HDD\) \(M577\)](#)
- [Step 5: Remove the fax PCA \(M577c/f/z\)](#)
- [Step 6: Remove the formatter \(M577\)](#)
- [Step 7: Remove the rear cover \(M552 and M553\)](#)
- [Step 8: Remove the rear upper cover \(M577\)](#)
- [Step 9: Remove the rear cover \(M577\)](#)
- [Step 10: Remove the left cover](#)
- [Step 11: Remove the formatter case](#)
- [Step 12: Remove the low-voltage power supply \(LVPS\)](#)
- [Step 13: Remove the high-voltage power supply D \(HVPSD\)](#)
- [Step 14: Remove the lifter drive assembly](#)
- [Step 15: Unpack the replacement assembly](#)
- [Step 16: Install the lifter drive assembly](#)
- [Step 17: Install the HVPSD](#)
- [Step 18: Install the LVPS](#)
- [Step 19: Install the formatter case](#)
- [Step 20: Install the left cover](#)
- [Step 21: Install the rear cover \(M577\)](#)
- [Step 22: Install the rear upper cover \(M577\)](#)
- [Step 23: Install the rear cover \(M552 and M553\)](#)
- [Step 24: Install the formatter \(M577\)](#)
- [Step 25: Install the fax PCA \(M577c/f/z\)](#)
- [Step 26: Install the HDD \(M577\)](#)
- [Step 27: Install the formatter \(M552 and M553\)](#)
- [Step 28: Install the formatter cover](#)
- [Step 29: Install the TCU](#)

Introduction

This document provides the procedures to remove and replace the lifter drive assembly.

Before performing service

Turn the printer power off

- Disconnect the power cable.

 **WARNING!** To avoid damage to the printer, turn the printer off, wait 30 seconds, and then remove the power cord before attempting to service the printer.

Use the table below to identify the correct part number for your printer, and then go to <http://h20141.www2.hp.com/hpparts> to order the part.

Lifter drive assembly part number	
RM2-0010-000CN	Lifter drive assembly

Required tools

- #2 Phillips screwdriver with a magnetic tip

After performing service

Make sure that all of the connectors on the HVPSD are fully seated.

Make sure that all of the connectors on the LVPS are fully seated.

Make sure that all of the connectors on the formatter are fully seated.

Make sure that the formatter cover is fully seated, and that the thumbscrews are finger tight after replacing it.

Turn the printer power on

- Connect the power cable.
- Use the power switch to turn the power on.

Post service test

Print a configuration page to make sure that the printer is functioning correctly.

Step 1: Remove the toner collection unit (TCU)

1. Open the front door.

Figure 1-2123 Open the front door



2. Open the TCU.

 **NOTE:** The toner collection hatch cover automatically closes when the TCU is opened.

Figure 1-2124 Open the TCU



3. Pull the TCU away from the printer at an angle to remove it.

⚠ CAUTION: Do not open the toner collection hatch cover when handling the TCU. If toner gets on clothing, wipe it off by using a dry cloth and wash the clothes in cold water. Hot water sets toner into fabric.

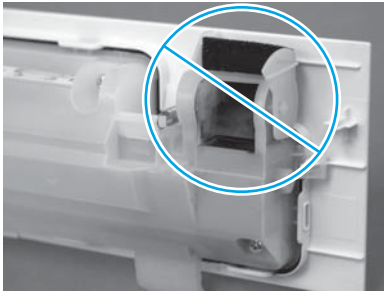
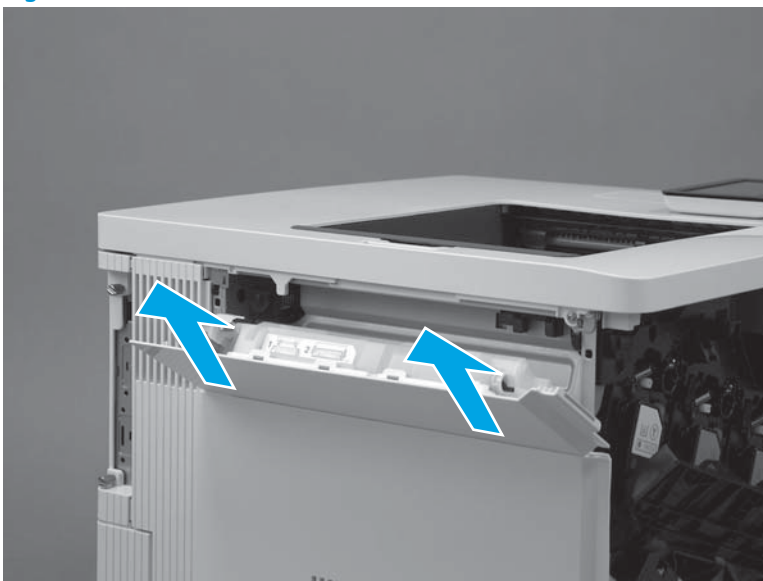

Figure 1-2125 Remove the TCU



Step 2: Remove the formatter cover

1. Locate the formatter cover.

Figure 1-2126 Locate the formatter cover

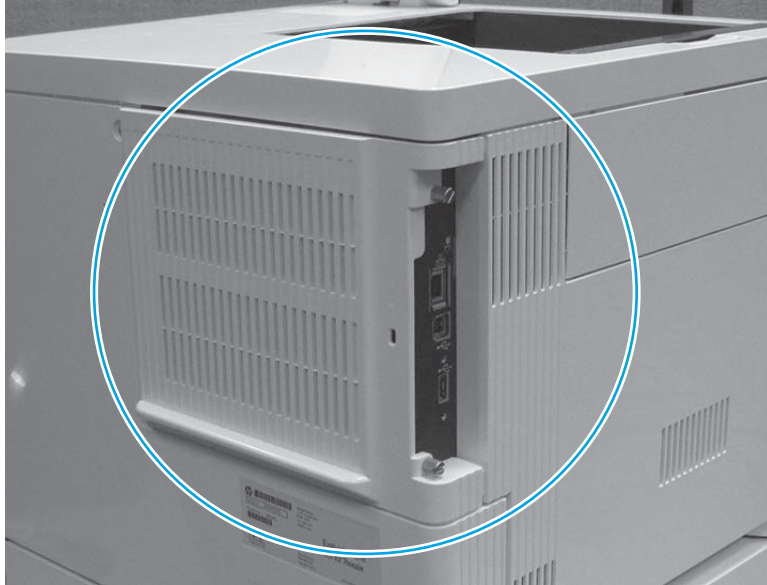

2. Loosen the two thumbscrews (callout 1). Grasp the two thumbscrews, and then slide the cover away from the printer (callout 2) to remove it.

 **TIP:** If needed, use the edge of a coin to turn the thumbscrews.

Figure 1-2127 Loosen the thumbscrews



Step 3: Remove the formatter (M552 and M553)

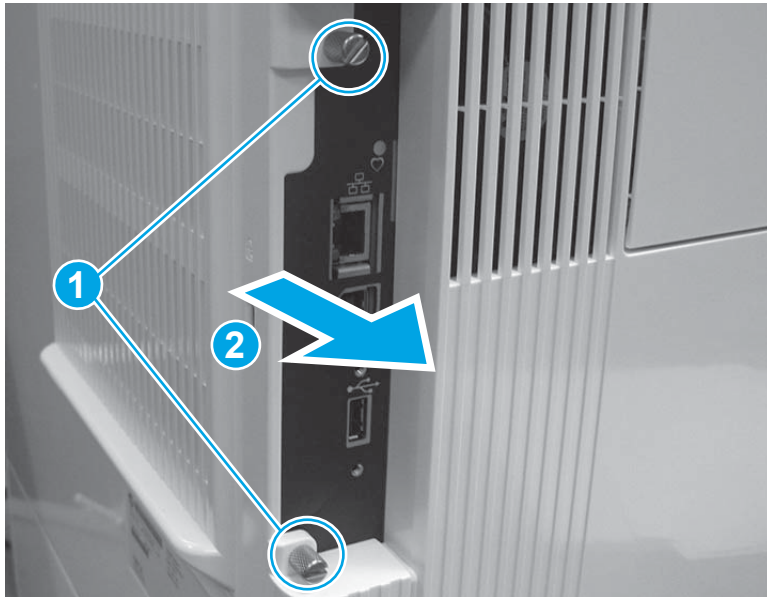

NOTE: This step is for the M552 and M553 models. For the M577 models, skip this step and go to [Step 4: Remove the hard-disk drive \(HDD\) \(M577\) on page 1217](#).

If the optional hard-disk drive (HDD) is installed, it must be removed to gain access to the formatter mounting screws.

Release two tabs along the left edge of the HDD, rotate the left edge away from the product, and then slide the HDD to the left to remove it.



CAUTION:  ESD-sensitive part.

1. Disconnect all of the connectors on the formatter.

The following connectors are empty:

- All models: J1 (this connector is empty unless the optional DIMM is installed)
- M553n/dn and M552dn: J2 (callout 1; this is the touchscreen connector for the M553x model)
- All models: J9 (this connector is empty unless the optional internal USB ports component is installed)
- All models: J18 (this connector is empty unless the optional hard-disk-drive (HDD) is installed)
- All models: J23
- All models: J24
- M553n/dn and M552dn: J25 (this is the wireless connector for the M553x model)
- All models: J57
- All models: J98 (this connector is empty unless the optional trusted platform module (TPM) is installed)



IMPORTANT: The flat-cable connector (callout 2) is a Zero Insertion Force (ZIF) connector that uses a hinged retainer to secure the flat cable. The hinged retainer must be opened to release the flat cable.

Figure 1-2128 Disconnect all connectors

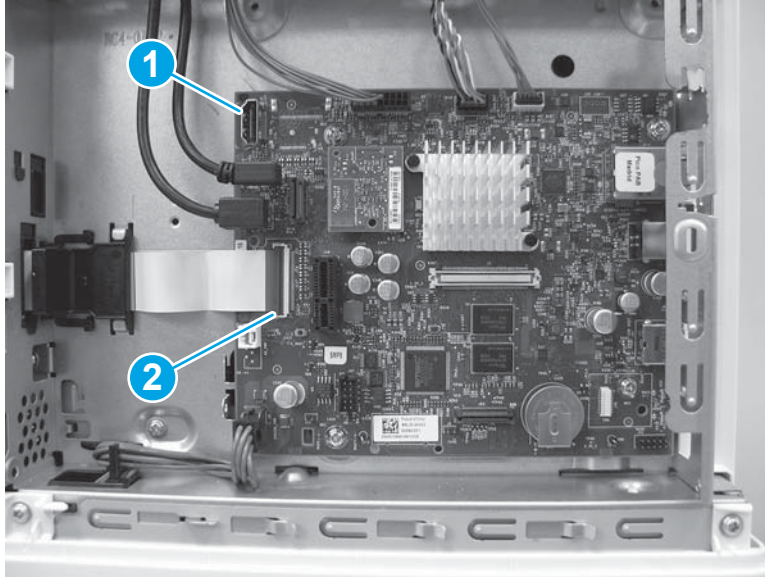

2. Remove four screws (callout 1), and then remove the formatter.

Figure 1-2129 Remove the formatter

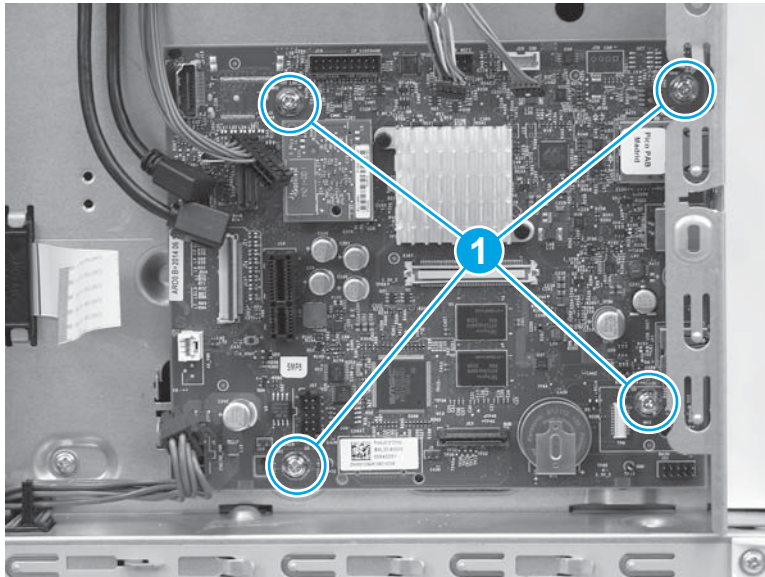

Step 4: Remove the hard-disk drive (HDD) (M577)

 **NOTE:** This step is for the M577 models. For the M552 and M553 models, skip this step and go to [Step 7: Remove the rear cover \(M552 and M553\) on page 1222](#).

 **CAUTION:**  ESD-sensitive part.

1. Release two tabs (callout 1). Hold the tabs in the released position, and then rotate the hard disk drive (HDD) up (callout 2) to release the connector from the formatter.

Figure 1-2130 Release the HDD

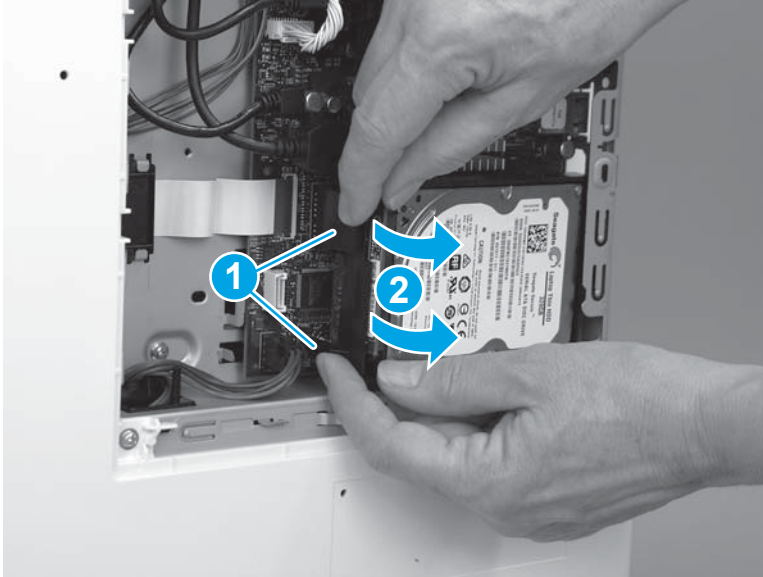

2. Slide the HDD away from the printer to remove it.

Figure 1-2131 Remove the HDD



Step 5: Remove the fax PCA (M577c/f/z)



NOTE: This step is for the M577c/f/z models. For the M577n model, skip this step and go to [Step 6: Remove the formatter \(M577\) on page 1220](#).

For the M552 and M553 models, skip this step and go to [Step 7: Remove the rear cover \(M552 and M553\) on page 1222](#).



CAUTION:  ESD-sensitive part.

1. Locate the fax PCA component on the formatter.

Figure 1-2132 Locate the fax PCA

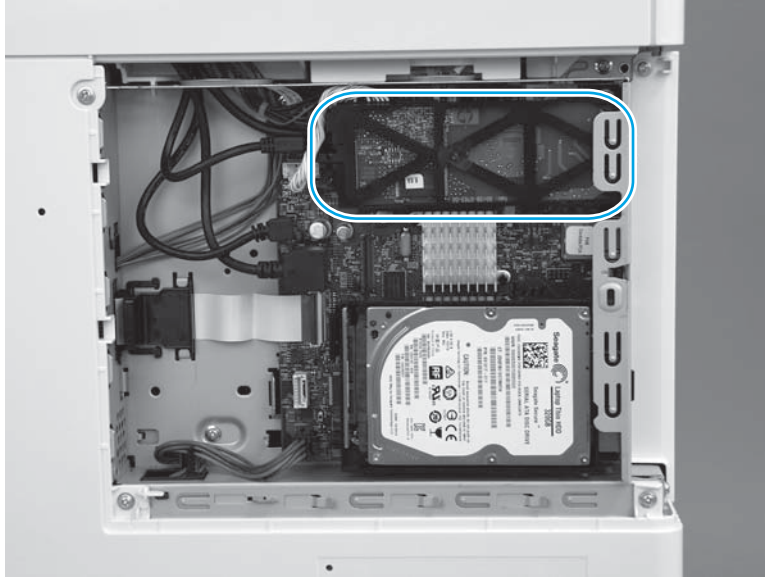

2. Release the connector latch (callout 1), and then pull the connector away from the formatter (callout 2) to disconnect it.

Figure 1-2133 Disconnect one connector

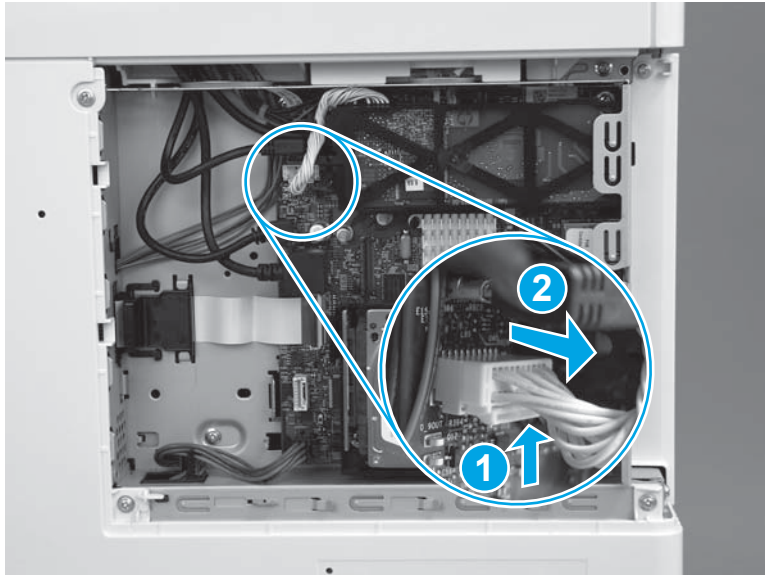

3. Release one retainer (callout 1) by pressing the bracket arms together.

Figure 1-2134 Release one latch

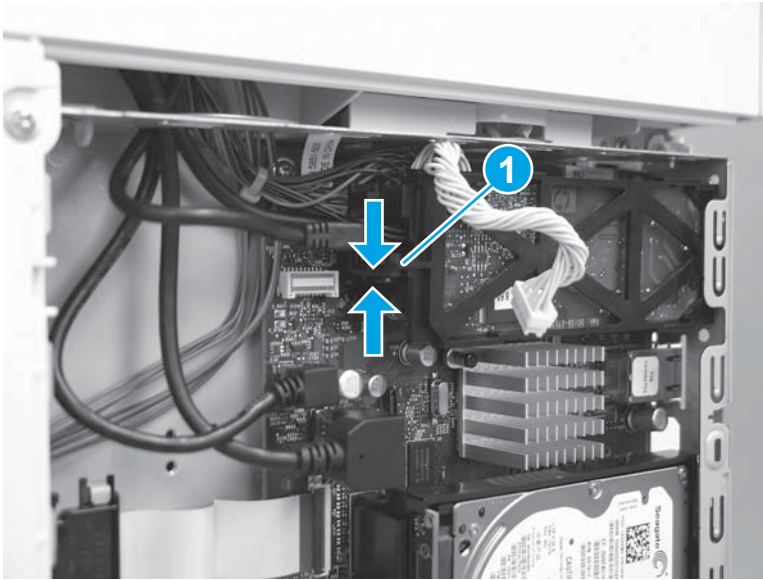

4. Rotate the end of the fax PCA (callout 1) away from the formatter, and then slide the PCA left (callout 2) to remove it.

Figure 1-2135 Remove the fax PCA

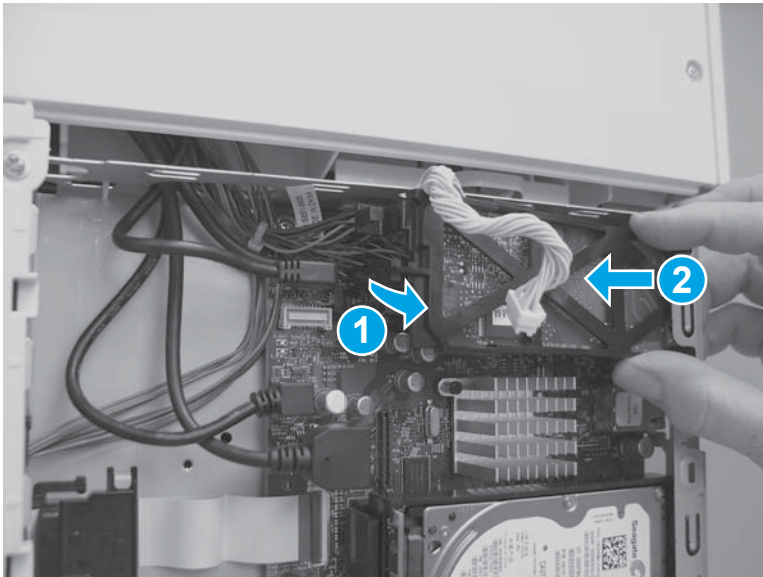

Step 6: Remove the formatter (M577)

 **NOTE:** This step is for the M577 models. For the M552 and M553 models, skip this step and go to [Step 7: Remove the rear cover \(M552 and M553\) on page 1222](#).

 **CAUTION:**  ESD-sensitive part.

1. Disconnect all of the connectors on the formatter.

The following connectors are empty:

- All models: J1 (this connector is empty unless the optional DIMM is installed)
- All models: J3
- M577dn: J15 (this is the fax connector for the M577f/z/c models)
- All models: J21 (this connector is empty unless the optional internal USB ports component is installed)
- All models: J23
- All models: J24
- All models: J51
- All models: J57
- All models: J97
- All models: J98 (this connector is empty unless the optional trusted platform module (TPM) is installed)

 **IMPORTANT:** The flat-cable connector (callout 1) is a Zero Insertion Force (ZIF) connector that uses a hinged retainer to secure the flat cable. The hinged retainer must be opened to release the flat cable.

Figure 1-2136 Disconnect all connectors



2. Remove four screws (callout 1).

Figure 1-2137 Remove four screws

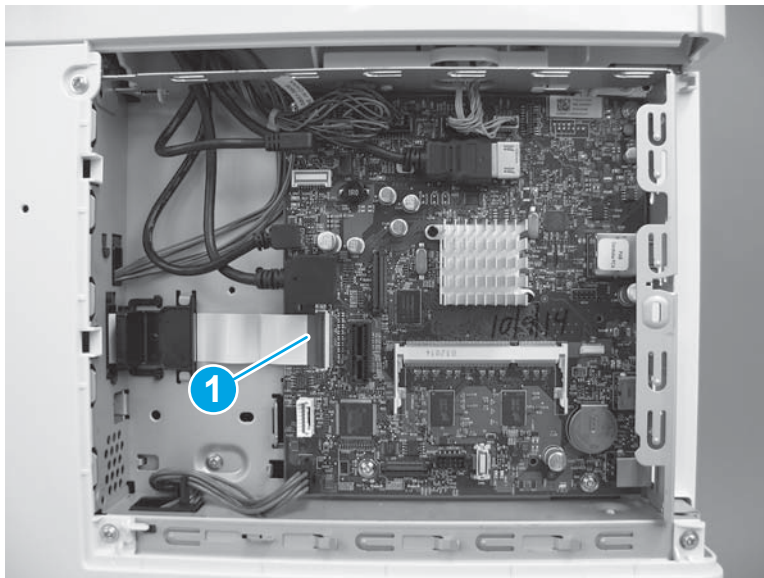
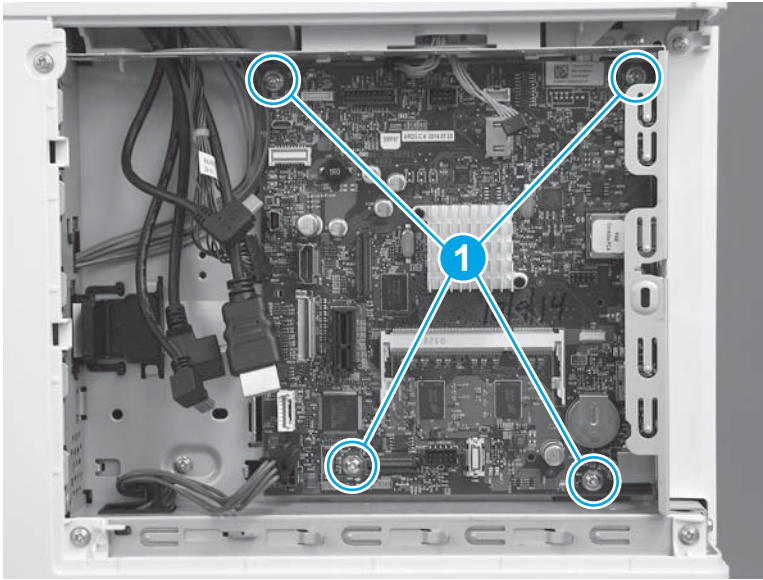

3. Remove the formatter.

Figure 1-2138 Remove the formatter

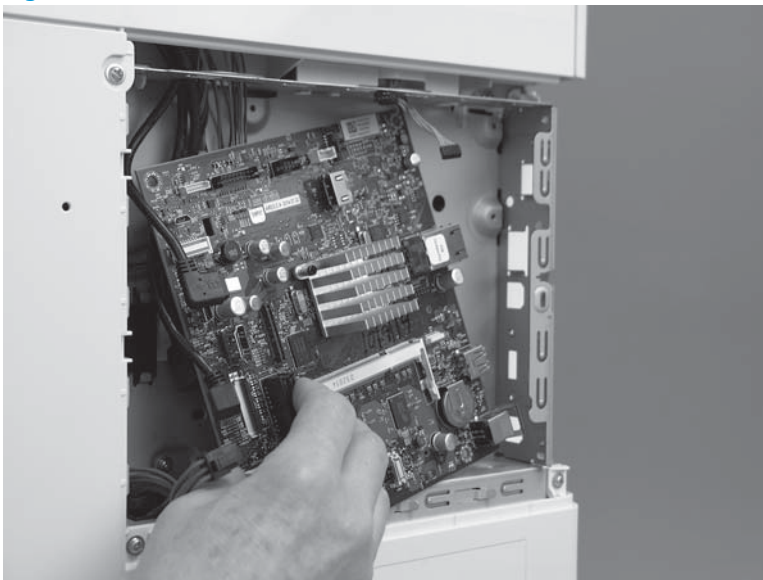

Step 7: Remove the rear cover (M552 and M553)

 **NOTE:** This step is for the M552 and M553 models. For the M577 models, skip this step and go to [Step 6: Remove the rear upper cover \(M577\) on page 434.](#)

1. Remove four screws (callout 1).

Figure 1-2139 Remove four screws

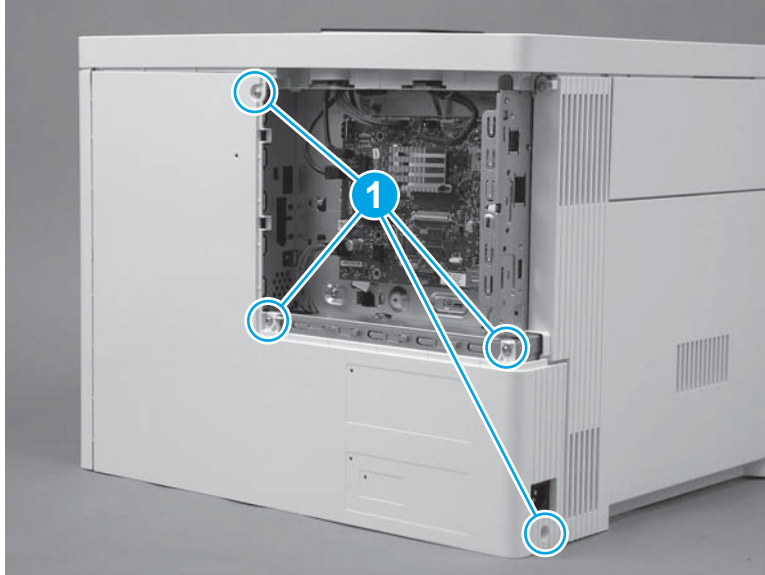

2. Slightly slide the cover to the right (callout 1), rotate the bottom of the cover away from the printer (callout 2), and then pull the top of the cover away from the printer (callout 3) to remove the cover.

Figure 1-2140 Remove the cover

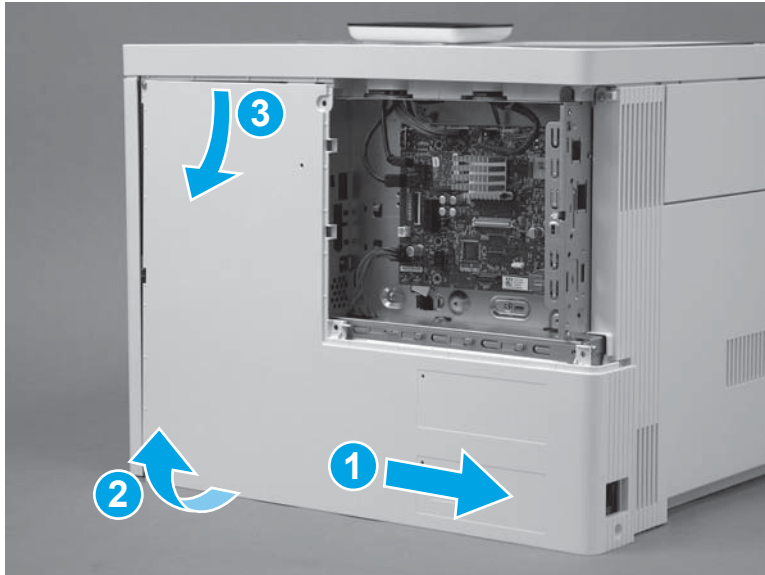

Step 8: Remove the rear upper cover (M577)



NOTE: This step is for the M577 models. For the M552 and M553 models, skip this step and go to [Step 10: Remove the left cover on page 1226](#).

1. Remove two screws (callout 1).



Reinstallation tip: These two screws are self-tapping screws for plastic. When reinstalling them, rotate the screws counterclockwise to align them with the existing thread pattern, and then carefully turn them clockwise to tighten. Do not overtighten. This will prevent stripping the threads inside the screw holes.

Figure 1-2141 Remove two screws

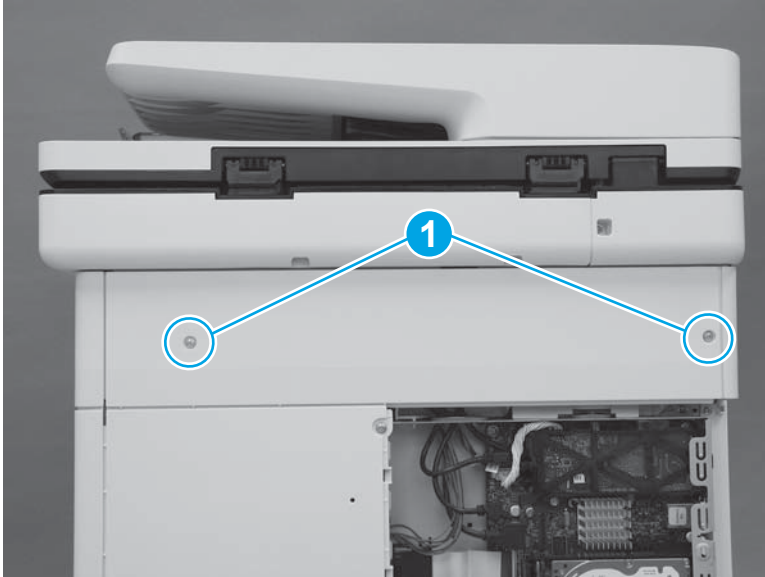

2. Use a small, flat blade screwdriver to release the right edge of the cover.

Figure 1-2142 Release the right edge

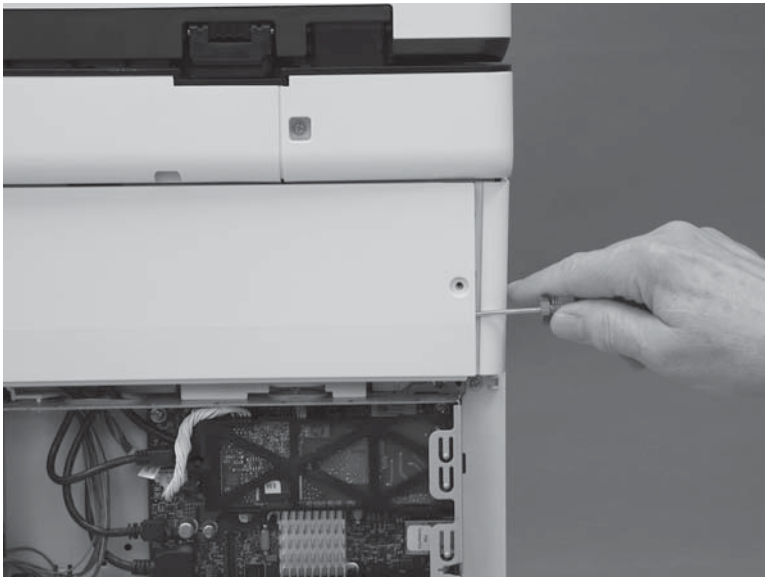

3. Pull the right edge of the cover (callout 1) away from the printer, and then slide the cover to the right (callout 2).

Figure 1-2143 Slide the cover right

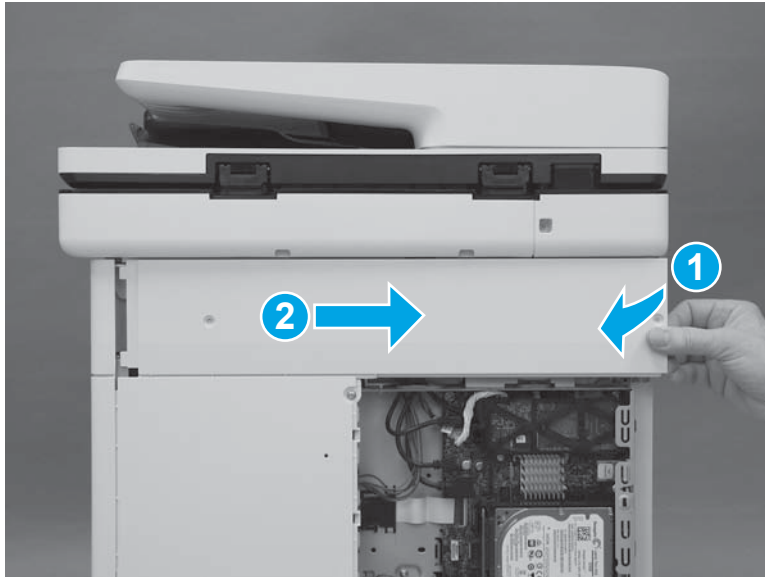

4. Remove the cover.

Figure 1-2144 Remove the cover

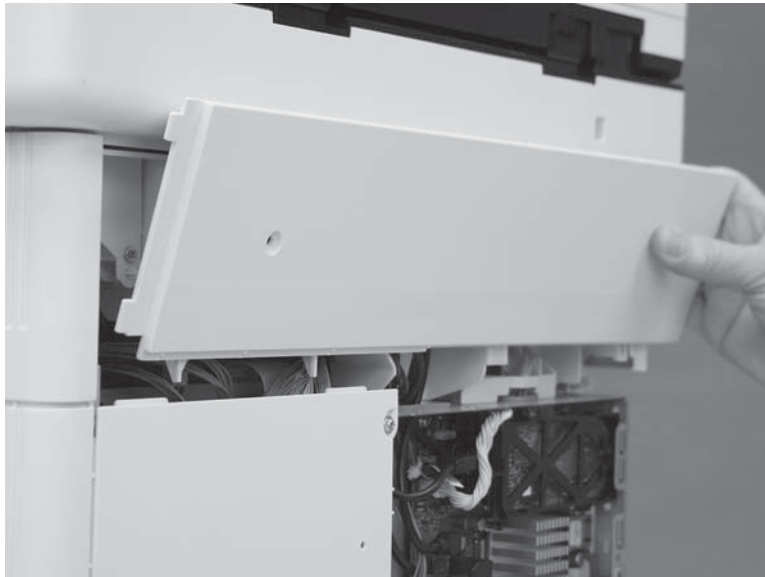

Step 9: Remove the rear cover (M577)

 **NOTE:** This step is for the M577 models. For the M552 and M553 models, skip this step and go to [Step 10: Remove the left cover on page 1226](#).

1. Remove four screws (callout 1).

Figure 1-2145 Remove four screws

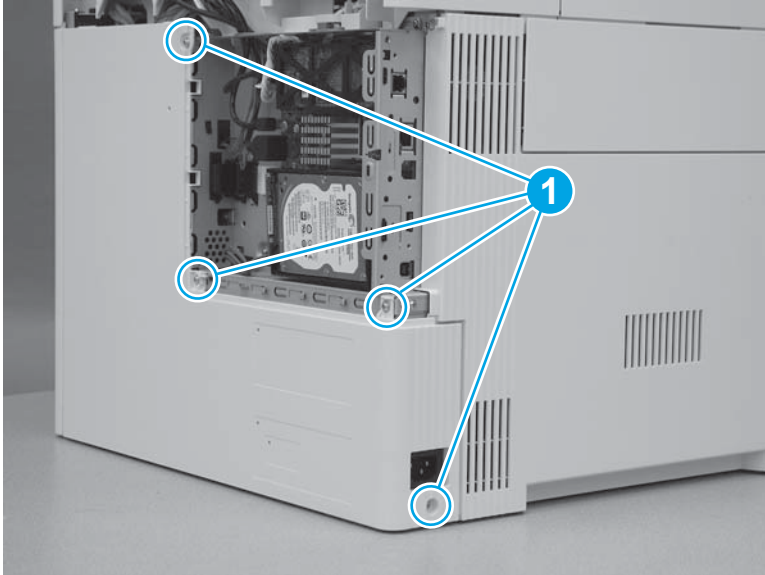

2. Slide the cover to the right to remove it.

Figure 1-2146 Remove the cover

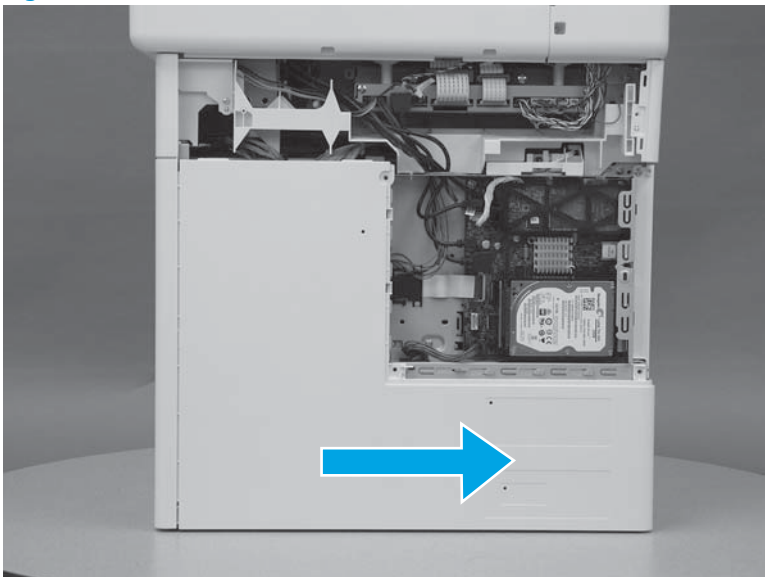

Step 10: Remove the left cover

1. At the left side of the printer, remove one screw (callout 1).

Figure 1-2147 Remove one screw



2. Release one tab (callout 1), rotate the front edge of the cover away from the printer (callout 2), and then slide the cover (callout 3) toward the rear of the printer to release it.

Figure 1-2148 Release the cover

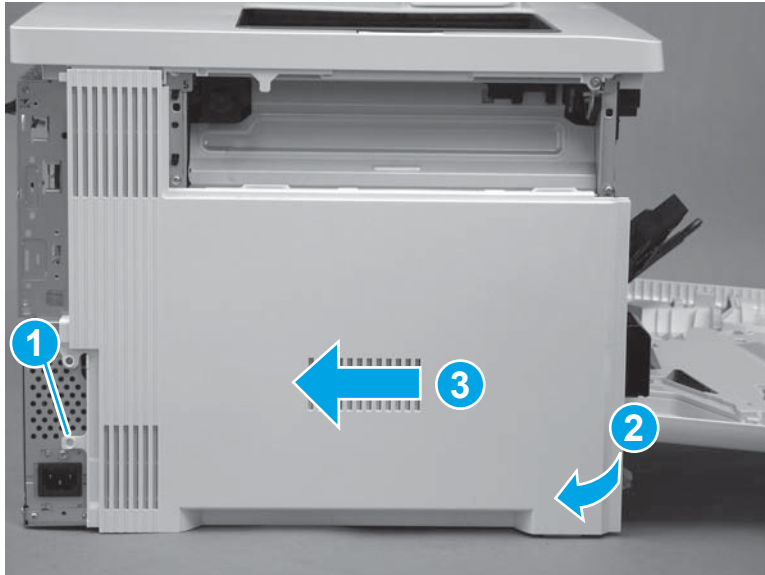

3. Remove the cover.

Figure 1-2149 Remove the cover

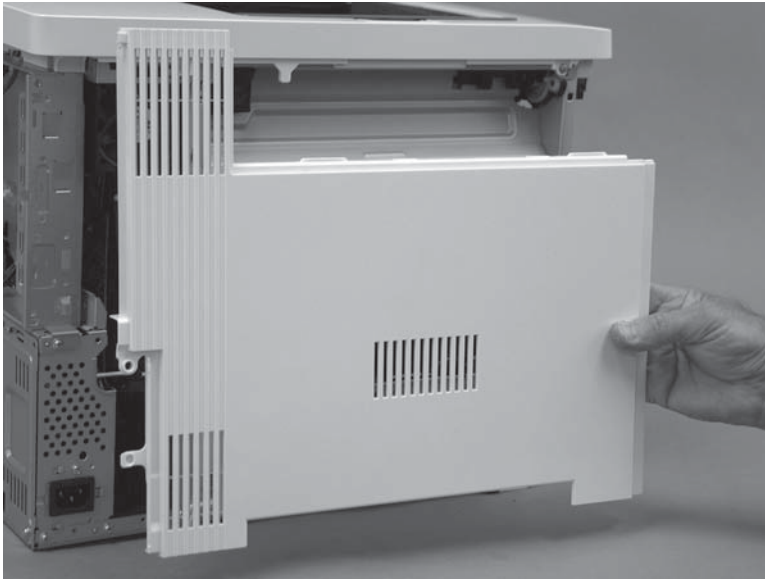

Step 11: Remove the formatter case

1. **M577 only:** Disconnect one connector (callout 1), and then pass the wire harness (callout 2) through two openings in the formatter case (callout 3).

Figure 1-2150 Disconnect one connector

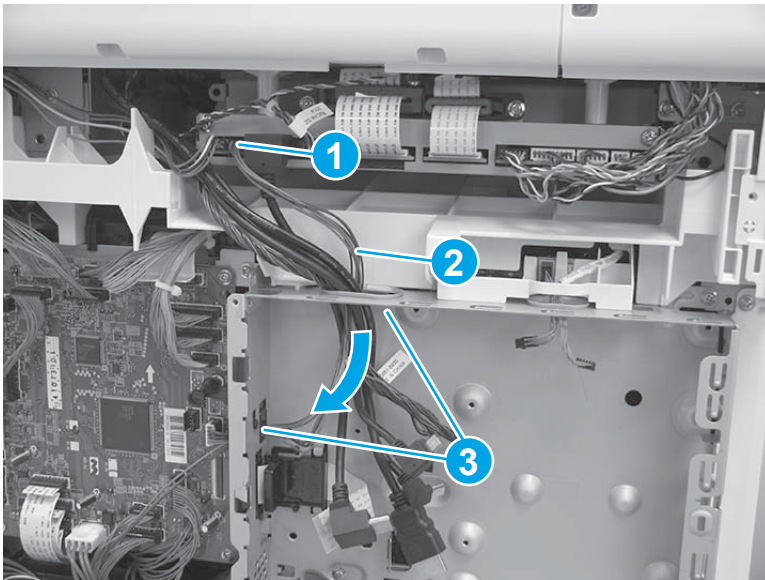

2. Release two tabs (callout 1) on the black plastic bracket. Hold the tabs in the released position, and then slide the bracket (callout 2) to the right to remove it from the formatter case.

Figure 1-2151 Remove the bracket

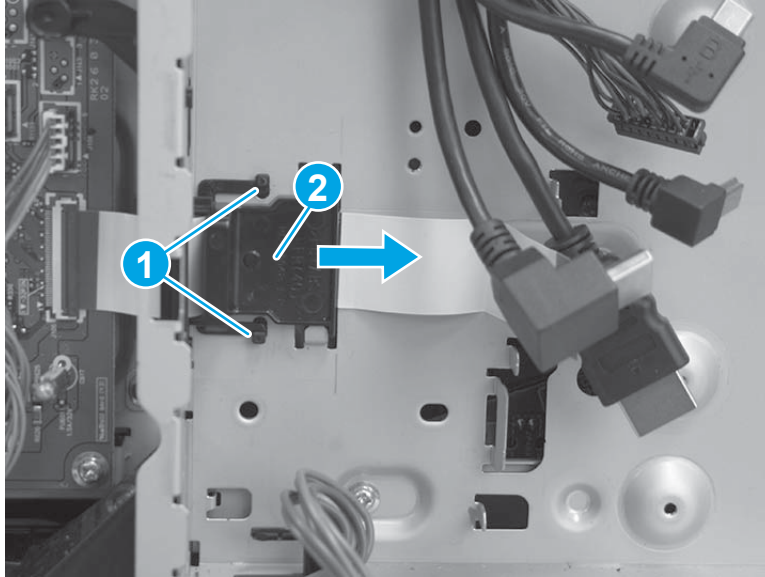

3. Remove two screws (callout 1), and then slide the low-voltage power supply (LVPS) cover to the right to remove it.

Figure 1-2152 Remove the LVPS cover

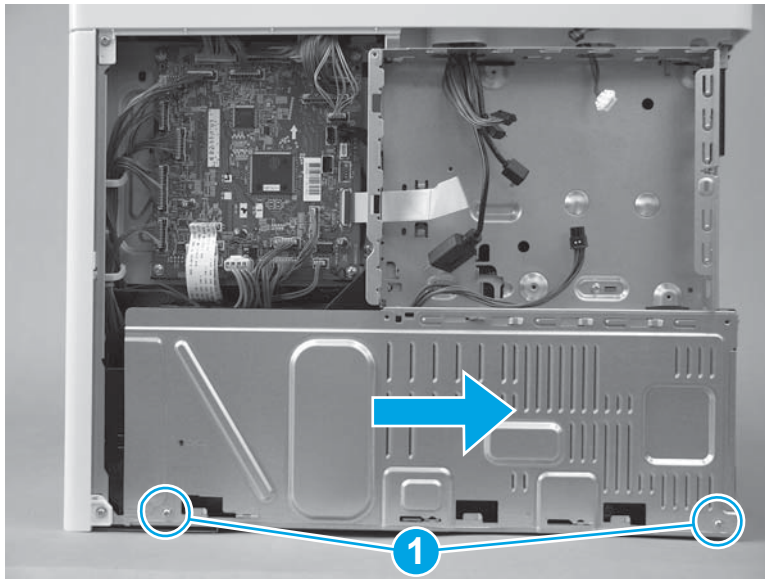

4. Pass two wire harnesses and one flat cable (callout 1) through the opening in the formatter case, and then release one wire harness from the retainer (callout 2).

⚠ CAUTION: The flat cable might be attached to the formatter case with double-sided tape. Make sure that this tape is released, so that the flat cable is not damaged when the formatter case is removed.

Figure 1-2153 Release wire harnesses and flat cable

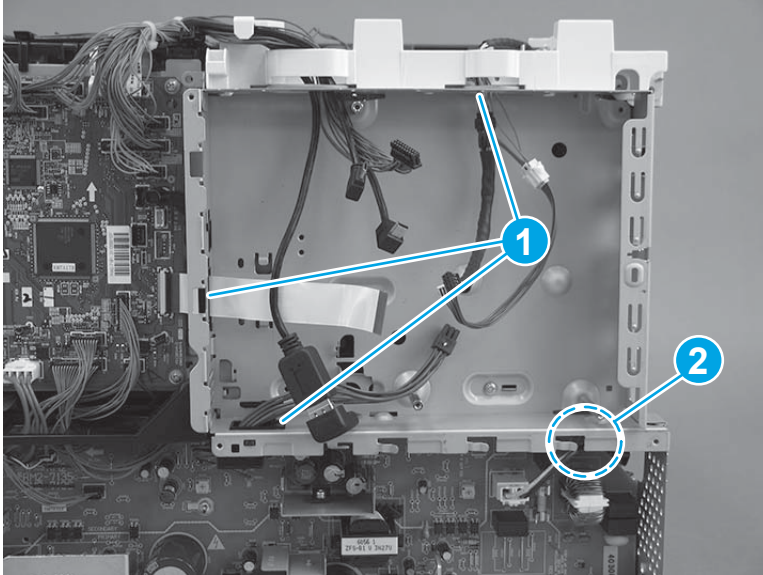

5. Remove six screws (callout 1).

Figure 1-2154 Remove six screws

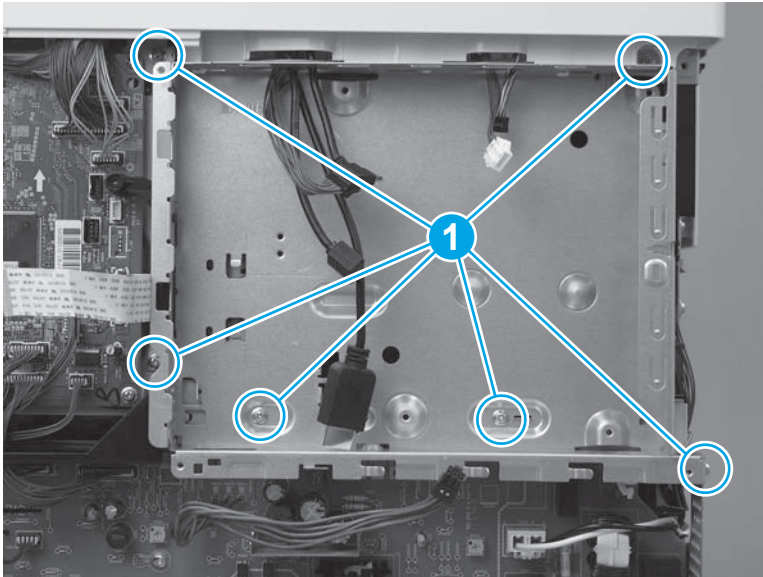

6. Rotate the bottom of the formatter case away from the printer (callout 1), and then pull it down (callout 2) to release it.

Figure 1-2155 Release the formatter case

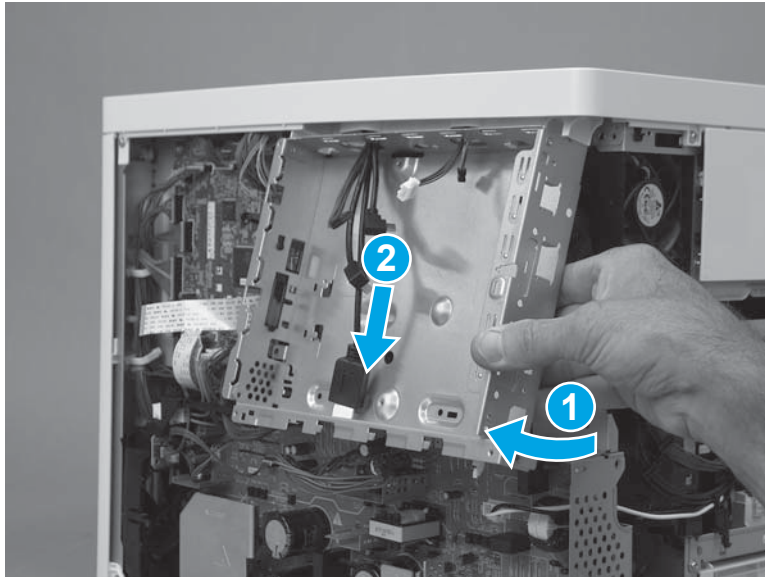

7. Pass the wire harnesses through the opening in the formatter case to remove it.

 **IMPORTANT:** If the formatter case is removed so that it can be replaced, make sure to transfer the memory PCA (island of data) and plastic bracket (callout 1) to the replacement case.

Figure 1-2156 Remove the formatter case



Step 12: Remove the low-voltage power supply (LVPS)

 **CAUTION:**  ESD-sensitive part.

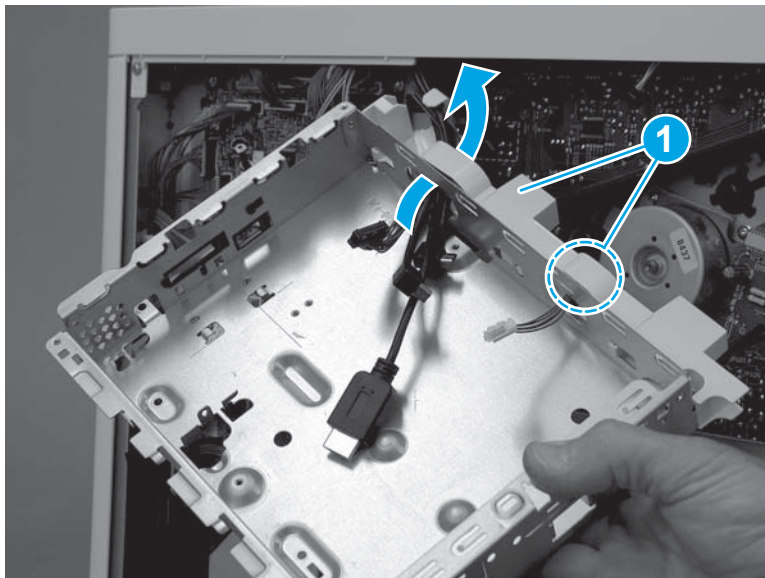
1. Disconnect one wire harness (callout 1), and then pass the wire harness through the opening (callout 2) in the chassis.

Figure 1-2157 Disconnect one wire harness

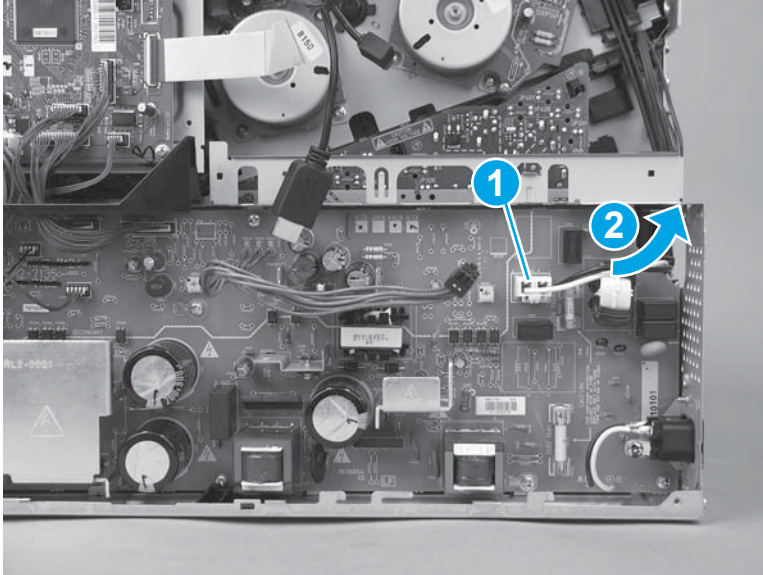

2. Disconnect three connectors on the DC controller (callout 1), and then disconnect four connectors (callout 2) on the LVPS.

Figure 1-2158 Disconnect seven connectors

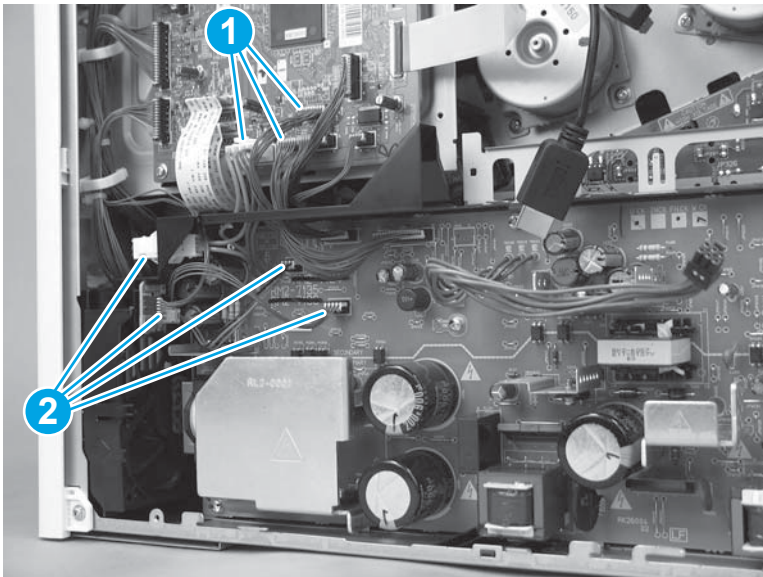

3. Pass the wire harnesses from the DC controller to the LVPS through the opening in the chassis (callout 1), and then release the wire harnesses from the retainer (callout 2).

Figure 1-2159 Pass the wire harnesses through the opening

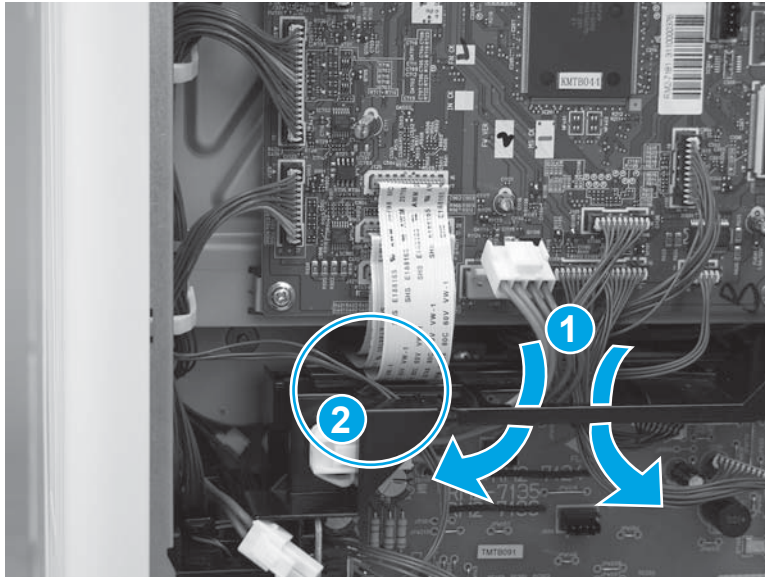

4. Remove three screws (callout 1).

Figure 1-2160 Remove three screws

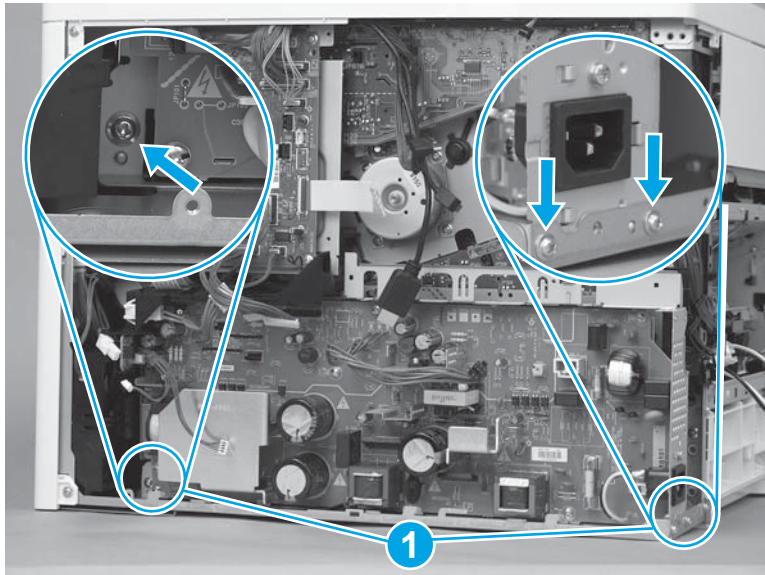

5. Rotate the top of the LVPS away from the printer (callout 1), and then slide it up and out (callout 2) of the printer to remove it.

Figure 1-2161 Remove the LVPS

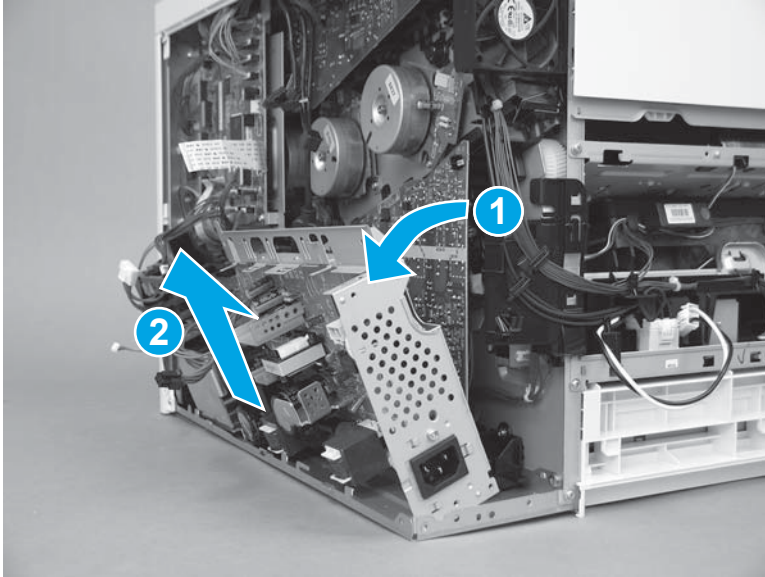

Step 13: Remove the high-voltage power supply D (HVPSD)

 **CAUTION:**  ESD-sensitive part.

1. Disconnect one flat cable (callout 1) on the DC controller.

Figure 1-2162 Disconnect one flat cable

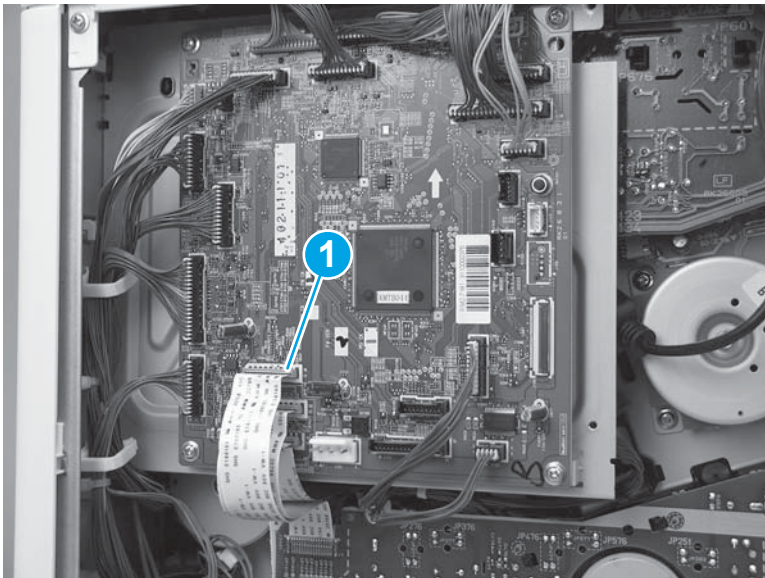

2. Remove two screws (callout 1), and then remove one self tapping screw (callout 2) on the HVPSD.

Figure 1-2163 Remove three screws

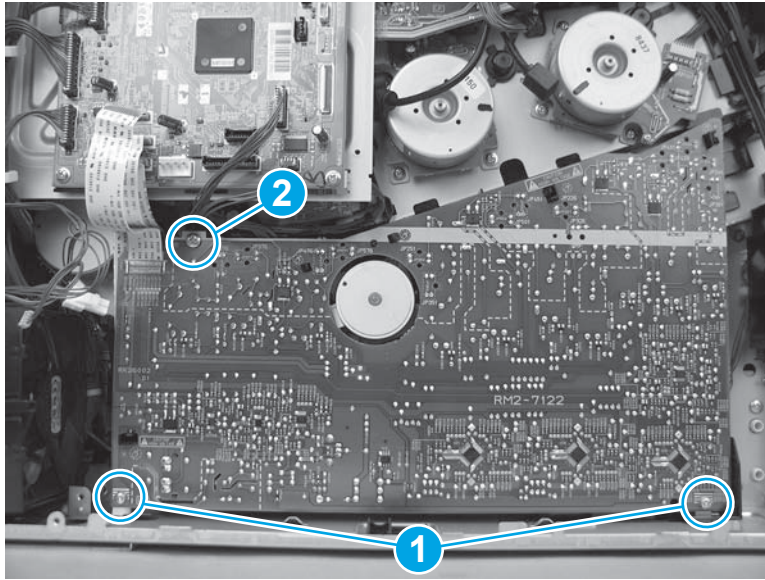

3. Release five tabs (callout 1), and then remove the HVPSD (callout 2).

Figure 1-2164 Remove the HVPSD

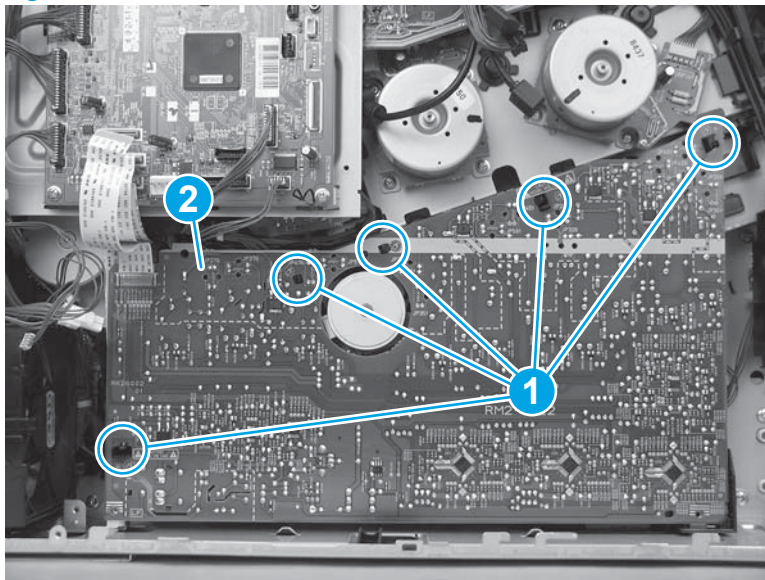

Step 14: Remove the lifter drive assembly

1. Disconnect two connectors (callout 1).

Figure 1-2165 Disconnect two connectors

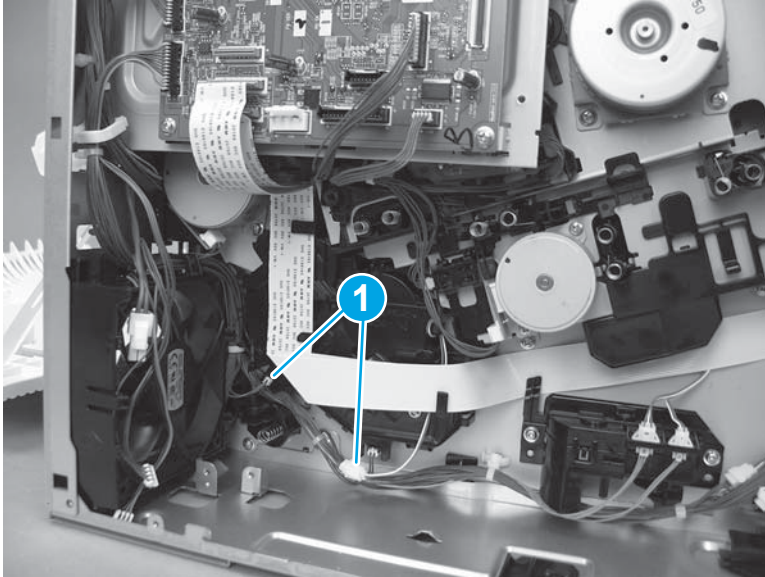

2. Disconnect two flat cables (callout 1), and then release them from the retainers (callout 2).

Figure 1-2166 Disconnect two flat cables

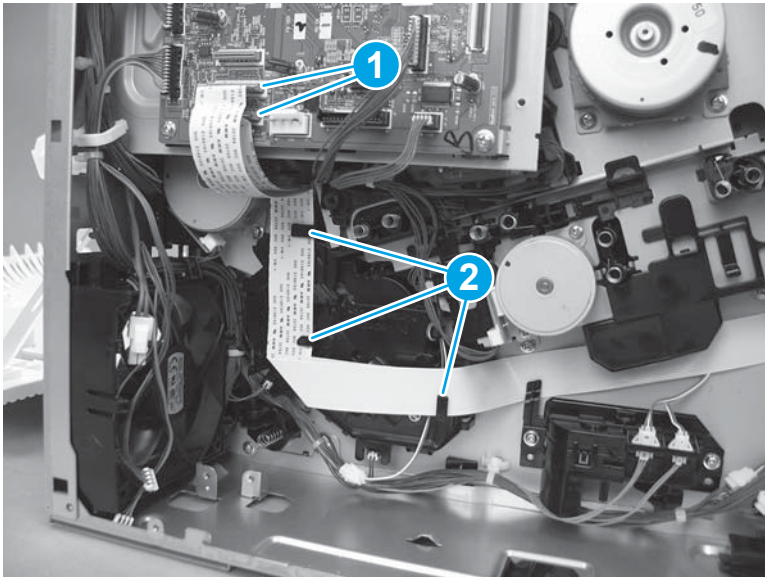

3. Remove two screws (callout 1), release one tab (callout 2), and then remove the lifter drive assembly (callout 3).

 **NOTE:** Release one wire harness from the retainer (callout 4) as the assembly is removed.

Figure 1-2167 Remove the assembly



Step 15: Unpack the replacement assembly

Unpack the replacement assembly from the packaging.

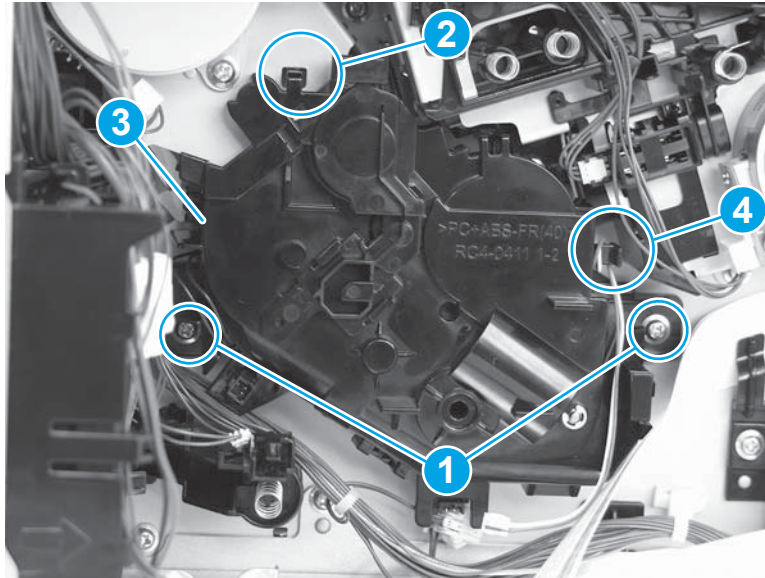
For complete information on HP's recycling programs, go to [Product return and recycling](#).

 **NOTE:** HP recommends responsible disposal of the defective assembly.

Figure 1-2168 Recycle and unpack

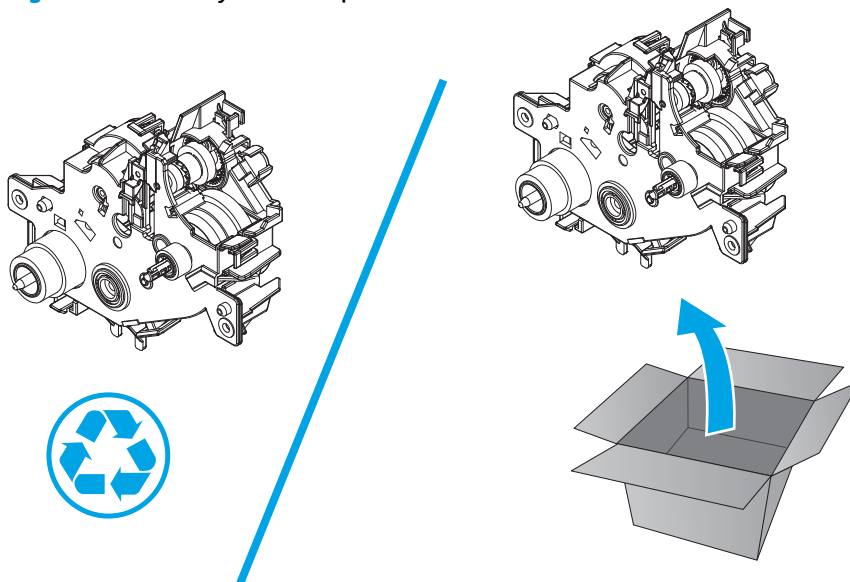

Step 16: Install the lifter drive assembly

1. Install one wire harness on the retainer (callout 1), position the lifter drive assembly in the printer (make sure that one tab (callout 2) snaps into place), and then install two screws (callout 3).

 **TIP:** It might be easier to install the assembly if the bottom of the assembly is installed first, and then the top of the assembly is rotated into place.

Figure 1-2169 Install the lifter drive



2. Connect two flat cables (callout 1), and then place them in the retainers (callout 2).

Figure 1-2170 Connect two flat cables

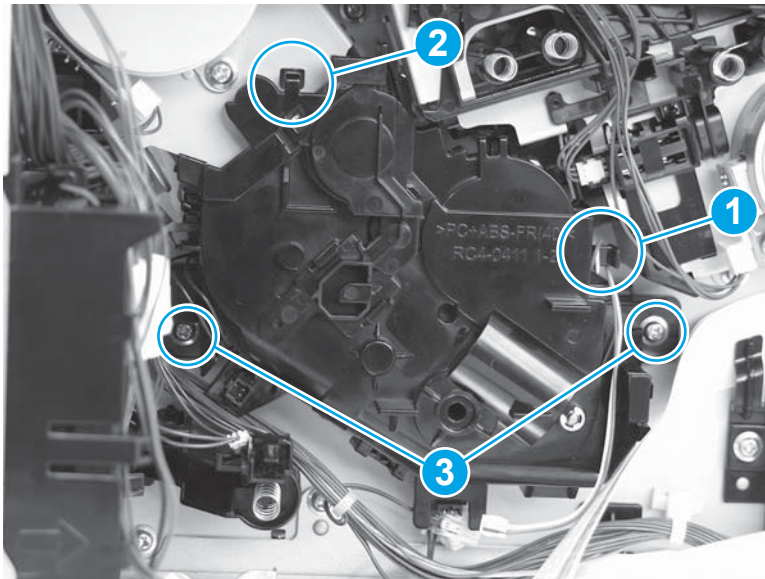
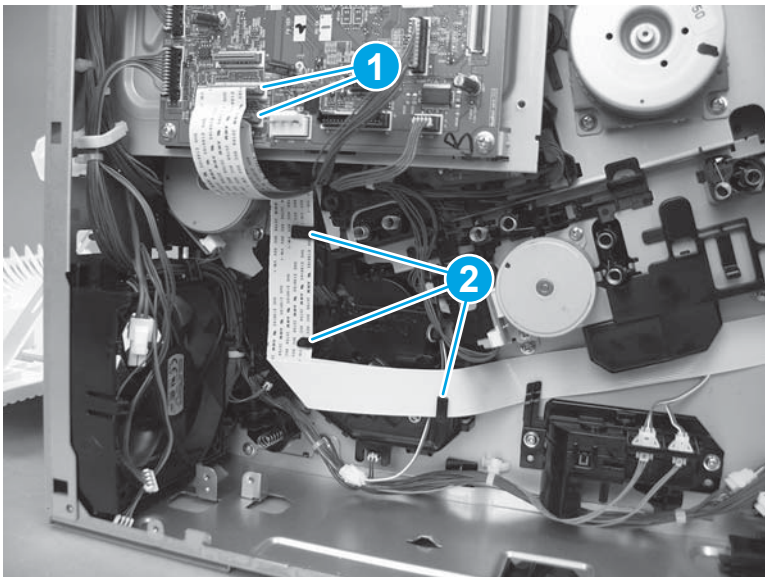

3. Connect two connectors (callout 1).

Figure 1-2171 Connect two connectors

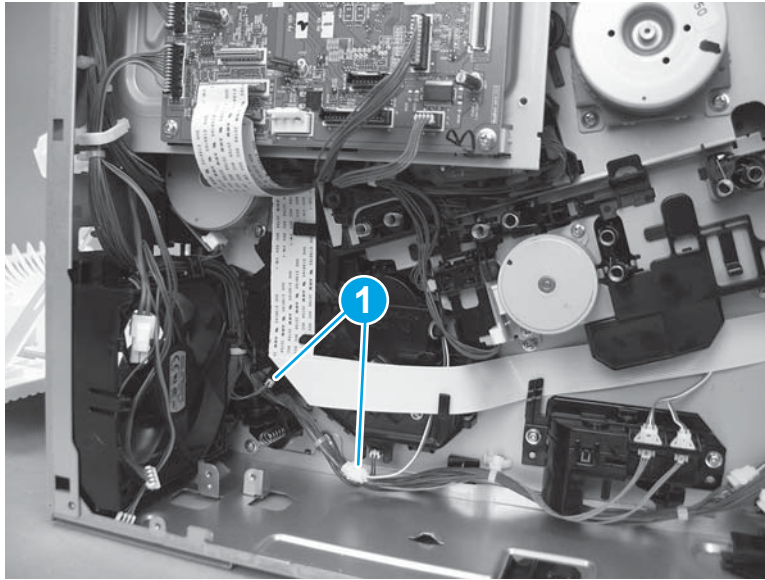

Step 17: Install the HVPSD

CAUTION:  ESD-sensitive part.

1. Position the bottom right corner of the HVPSD (callout 1) behind the black tab, and then rotate it up and onto the printer (callout 2).

Figure 1-2172 Install the HVPSD

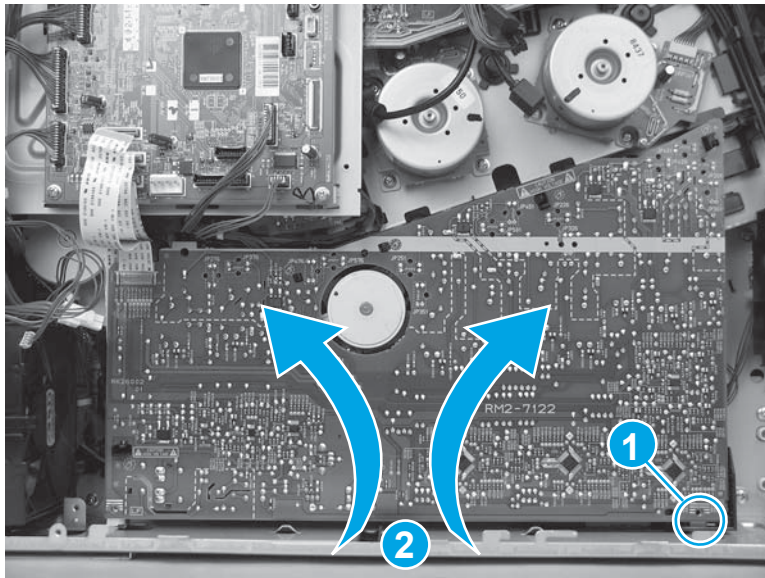

2. Press it onto five tabs (callout 2).

 **IMPORTANT:** Make sure that all five tabs snap into place.

Figure 1-2173 Press the tabs



3. Install two screws (callout 1), and then install one self tapping screw (callout 2) on the HVPSD.

Figure 1-2174 Install three screws

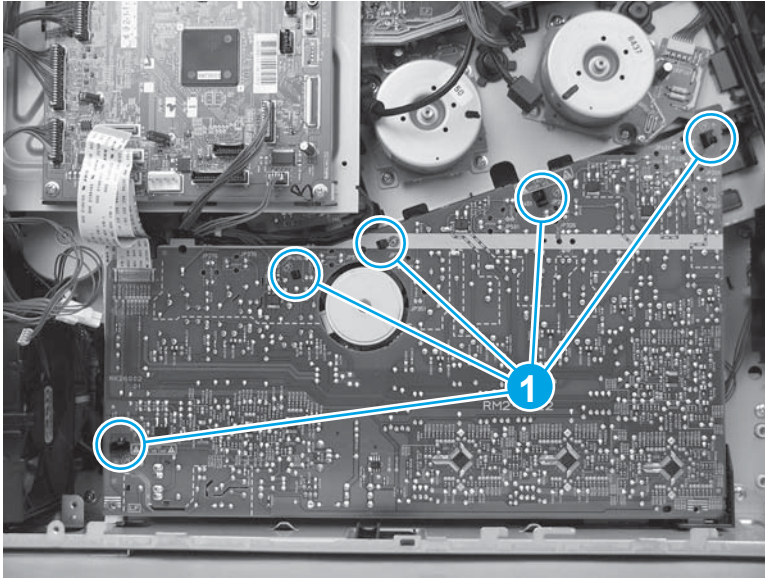
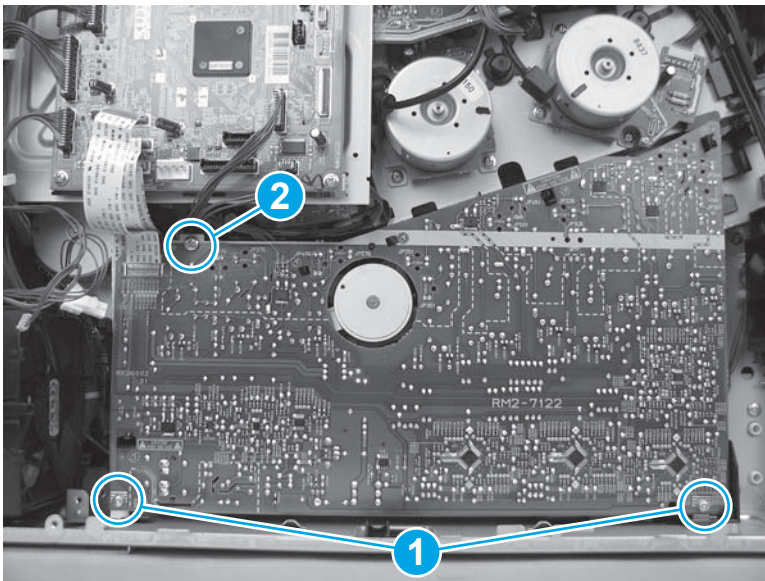

4. Connect one flat cable (callout 1) on the DC controller.

Figure 1-2175 Connect one flat cable

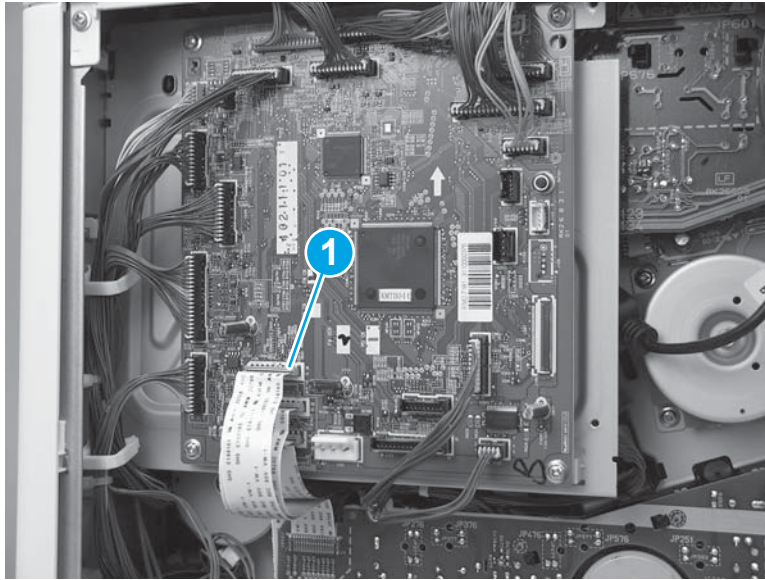

Step 18: Install the LVPS

CAUTION:  ESD-sensitive part.

1. Position the bottom of the LVPS in the printer (callout 1) at a slight angle, and then rotate the top of it into the printer (callout 2) to install it.

Figure 1-2176 Install the LVPS

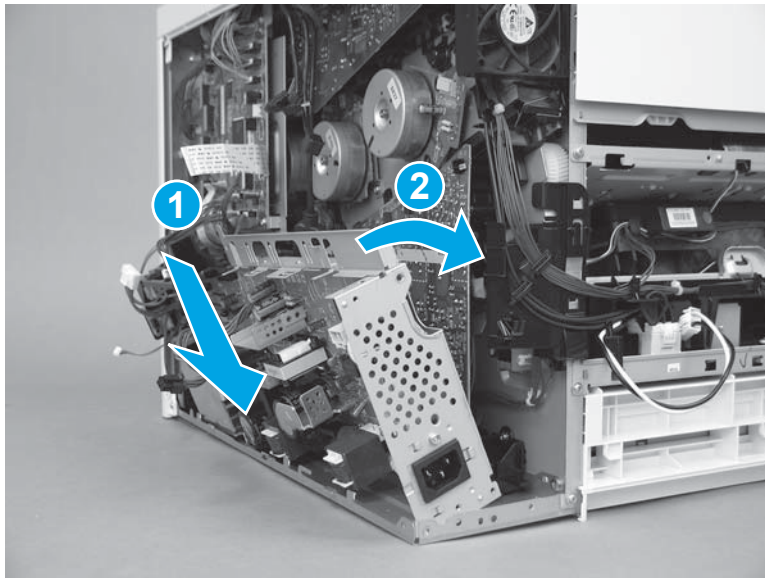

2. Install three screws (callout 1).

Figure 1-2177 Install three screws

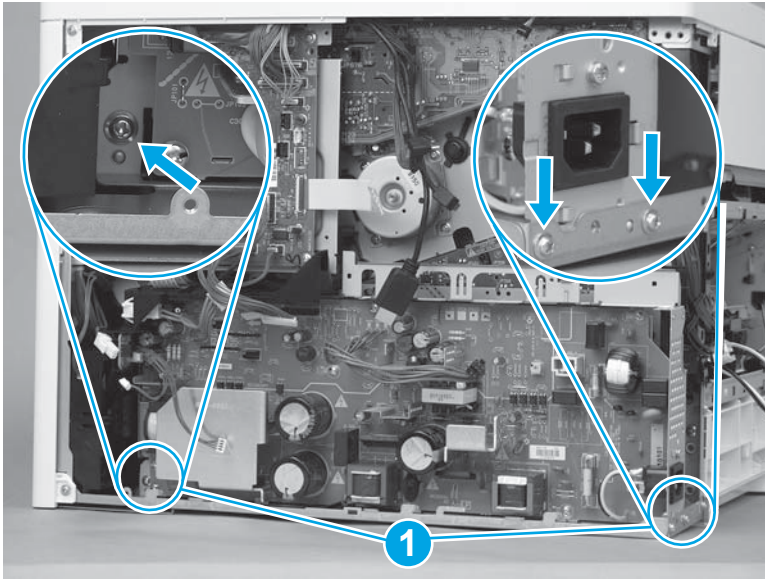

3. Pass the wire harnesses from the DC controller to the LVPS through the opening in the chassis (callout 1), and then install the wire harnesses in the retainer (callout 2).

Figure 1-2178 Pass the wire harnesses through the opening

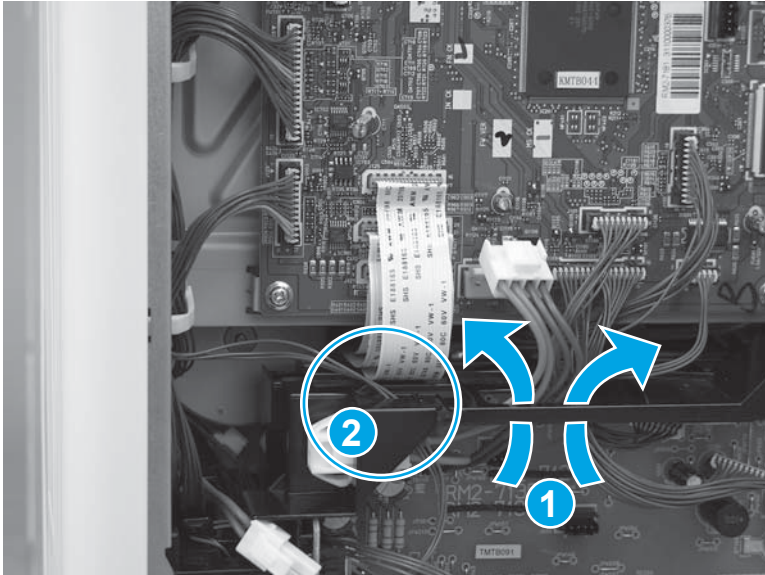

4. Connect three connectors on the DC controller (callout 1), and then connect four connectors (callout 2) on the LVPS.

Figure 1-2179 Connect seven connectors

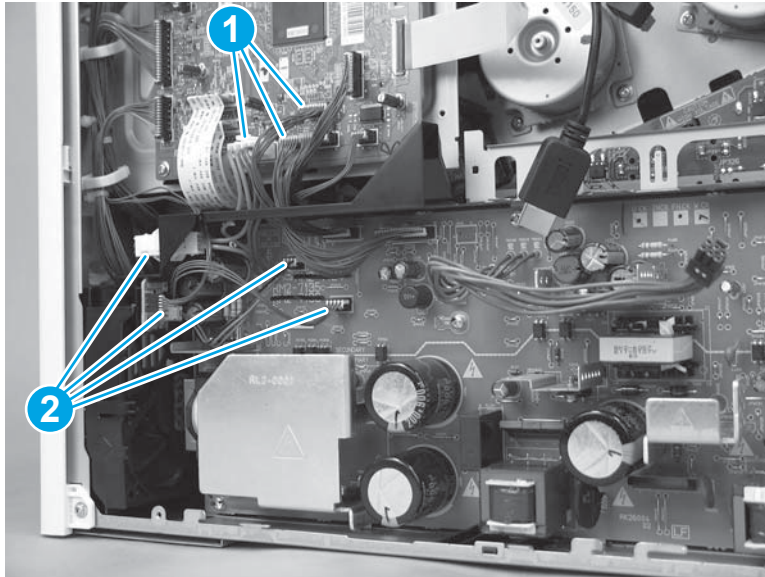

5. Pass the wire harness through the opening (callout 1) in the chassis, and then connect one wire harness (callout 2).

Figure 1-2180 Connect one wire harness

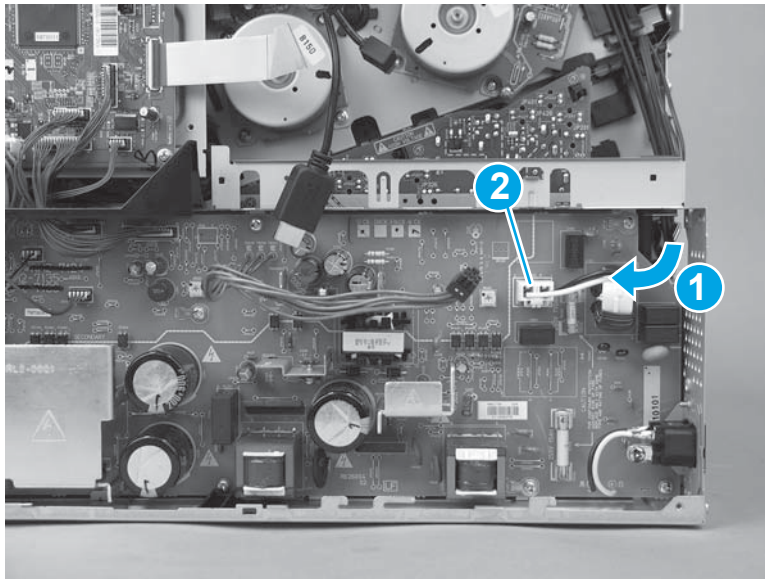

Step 19: Install the formatter case

1. Pass the wire harnesses through the opening in the formatter case.

Figure 1-2181 Pass the wire harnesses through the opening

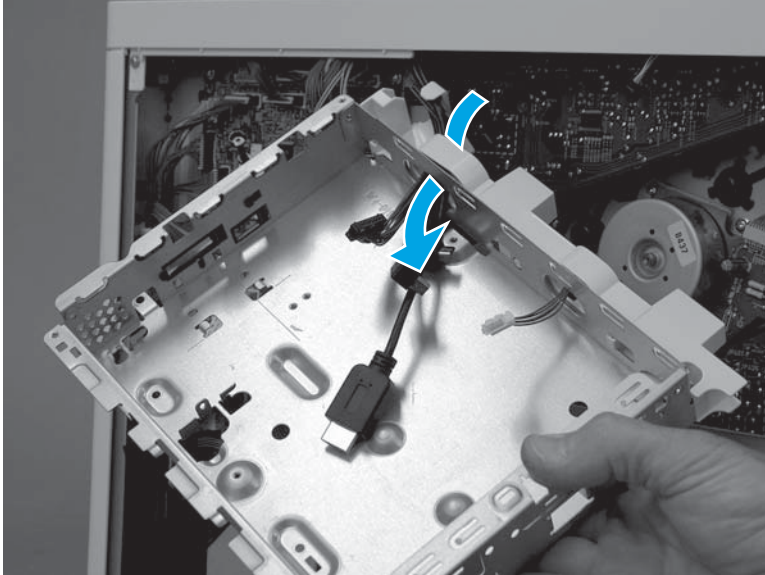

2. Position the top of the formatter case on the printer (callout 1), and then rotate the bottom of the case (callout 2) into the printer.

Figure 1-2182 Install the formatter case

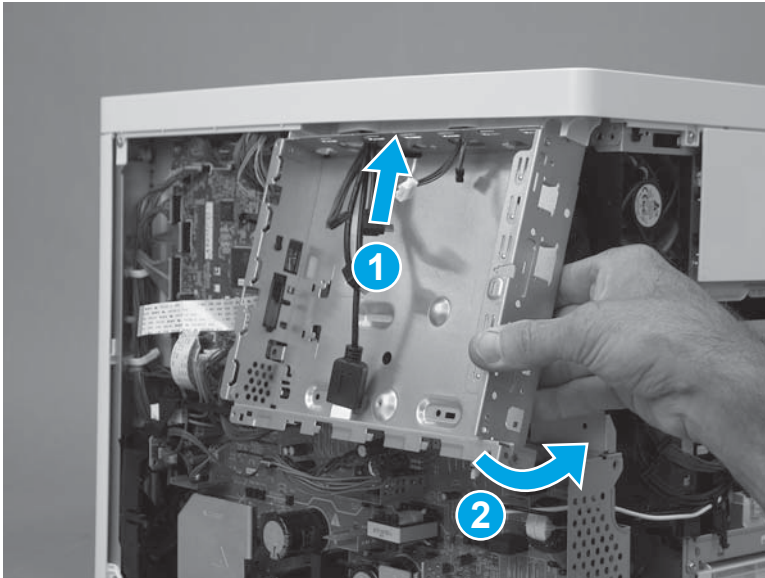

3. Install six screws (callout 1).

Figure 1-2183 Install six screws

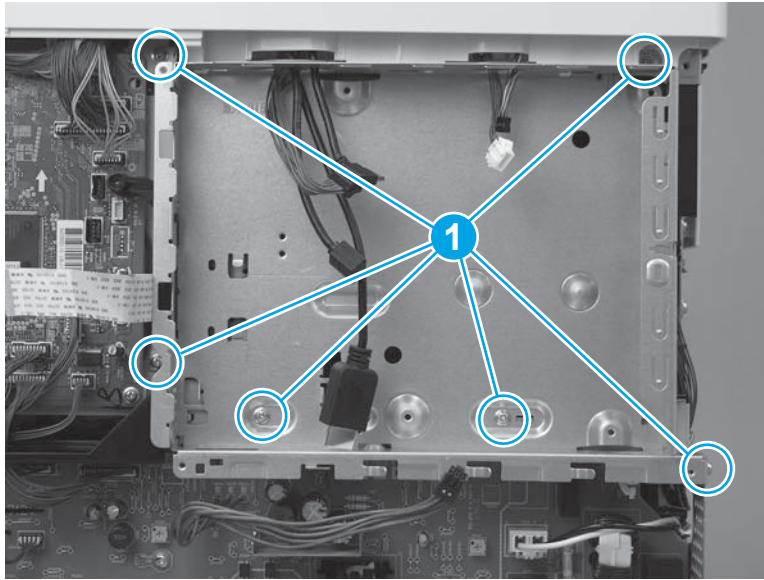

4. Pass two wire harnesses and one flat cable (callout 1) through the opening in the formatter case, and then install one wire harness in the retainer (callout 2).

 **IMPORTANT:** Make sure that the flat cable is securely fastened to the DC controller, and was not dislodged when the formatter case was removed.

Figure 1-2184 Install wire harnesses and flat cable



5. Position the LVPS cover on the printer, slide the cover to the left to install it, and then install two screws (callout 1).

Figure 1-2185 Install the LVPS cover

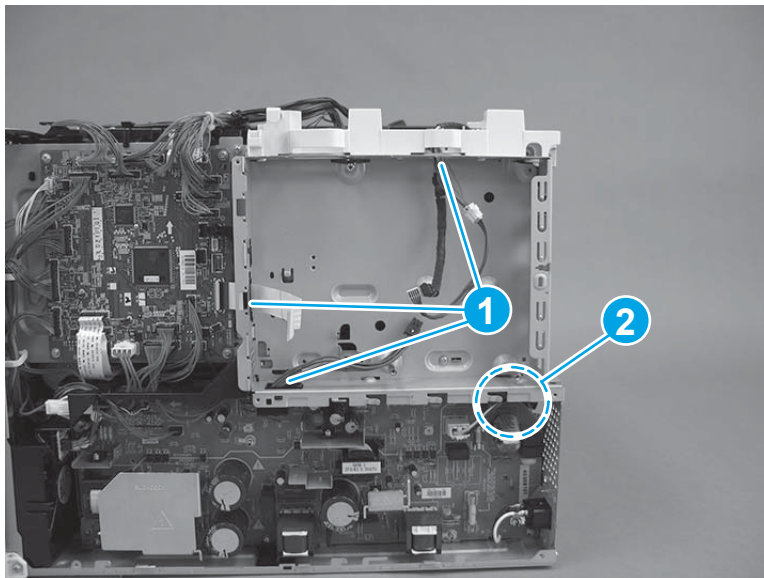
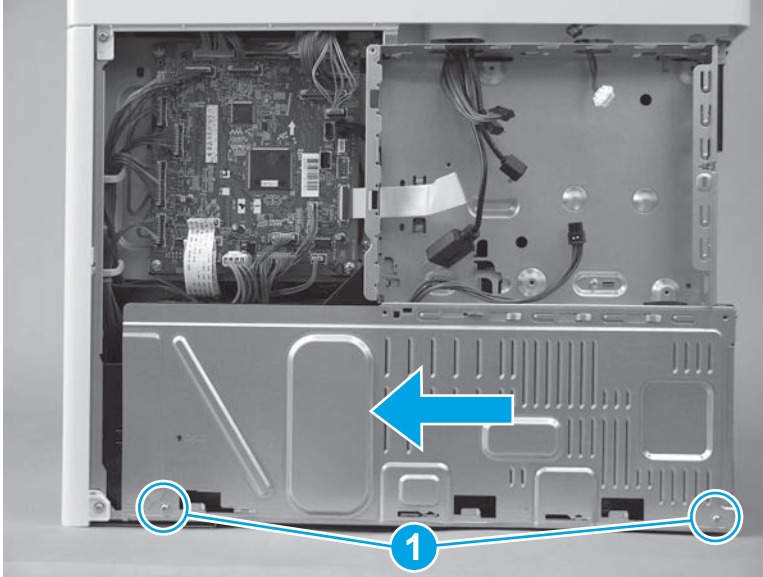

6. If no tape is affixed to the back of the flat cable, skip this step. If double-sided tape is affixed to the back of the flat cable, align the line (callout 1) on the cable with the edge (callout 2) of the opening in the sheet metal. Press to attach the flat cable to the formatter case.

Figure 1-2186 Attach the flat cable

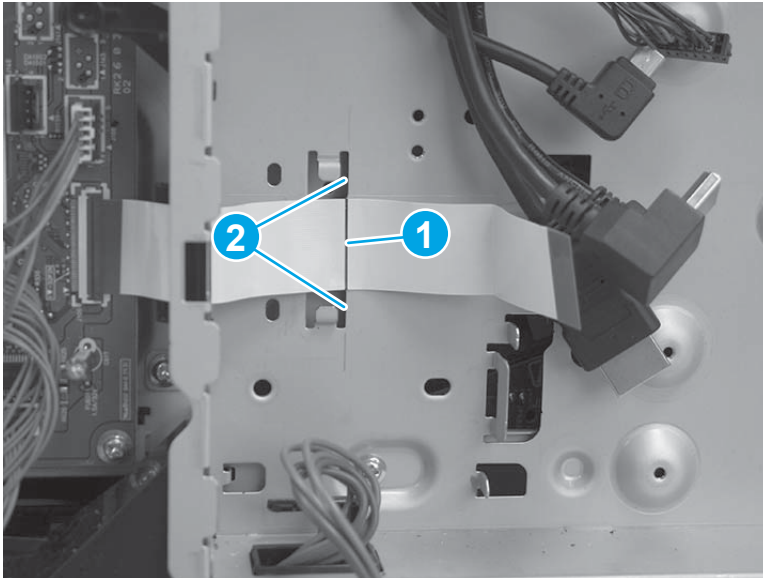

7. Position the bracket over the flat cable, and then slide the bracket to the left to install it. Make sure that the edges of the bracket fit under the sheet metal tabs (callout 1) on the formatter case and that the tabs (callout 2) snap into place.

Figure 1-2187 Position the bracket

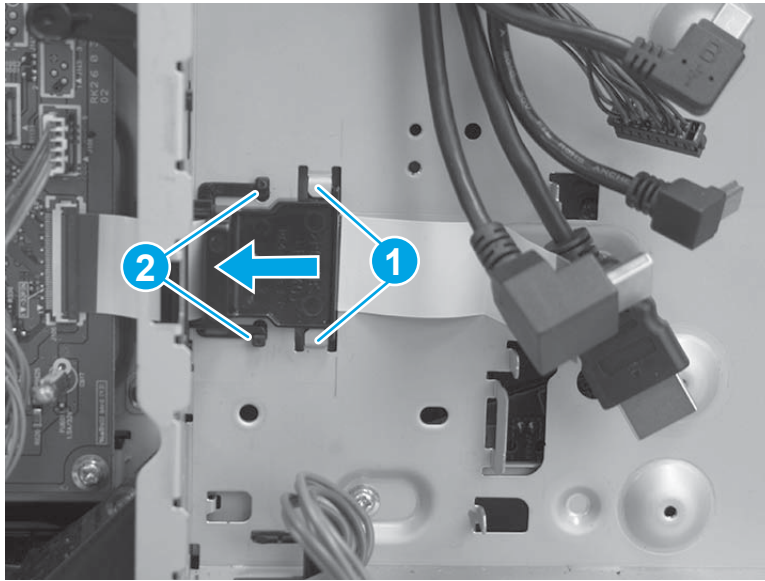

8. **M577 only:** Pass the wire harness (callout 1) through the openings in the formatter case (callout 2), and then connect one connector (callout 3).

Figure 1-2188 Connect one connector

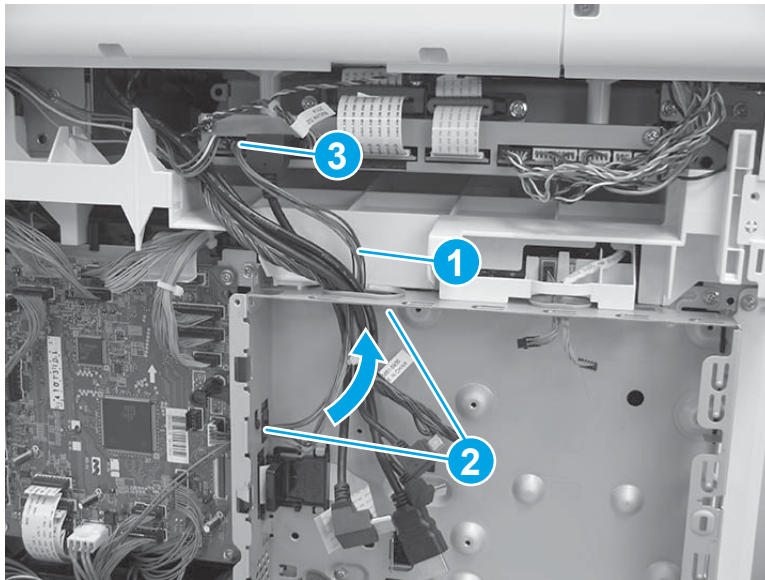

Step 20: Install the left cover

1. Position the cover on the printer.

 **NOTE:** Slightly offset the cover toward the rear of the printer.

Figure 1-2189 Install the cover

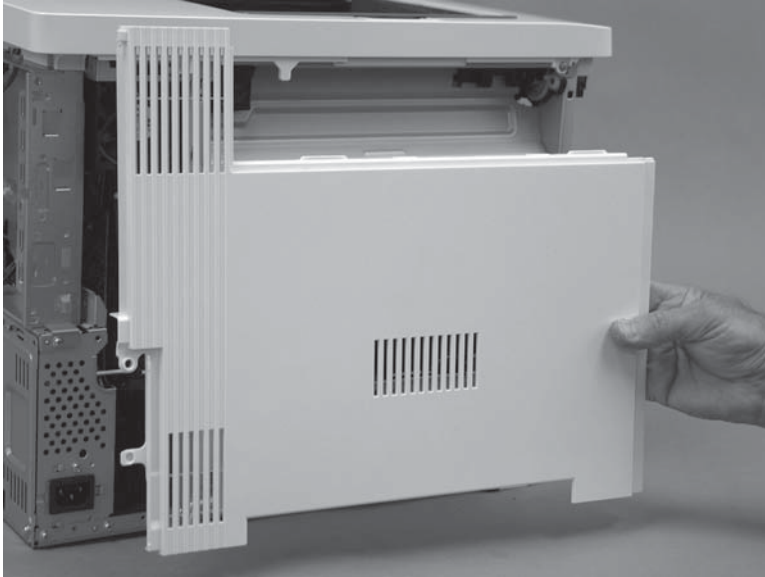

2. Slide the cover (callout 1) toward the front of the printer to engage it. Make sure that the tab (callout 2) snaps into place.

 **NOTE:** Locate the alignment pin (callout 3) on the cover from the front door side of the printer, and then make sure that it is fully engaged in the slot in the chassis.

 **TIP:** While sliding the cover into place, push in on the center of the cover (callout 1) to make sure that the hooks on the back of the cover engage with the slots in the chassis.

Figure 1-2190 Engage the cover



3. At the left side of the printer, install one screw (callout 1).

Figure 1-2191 Install one screw

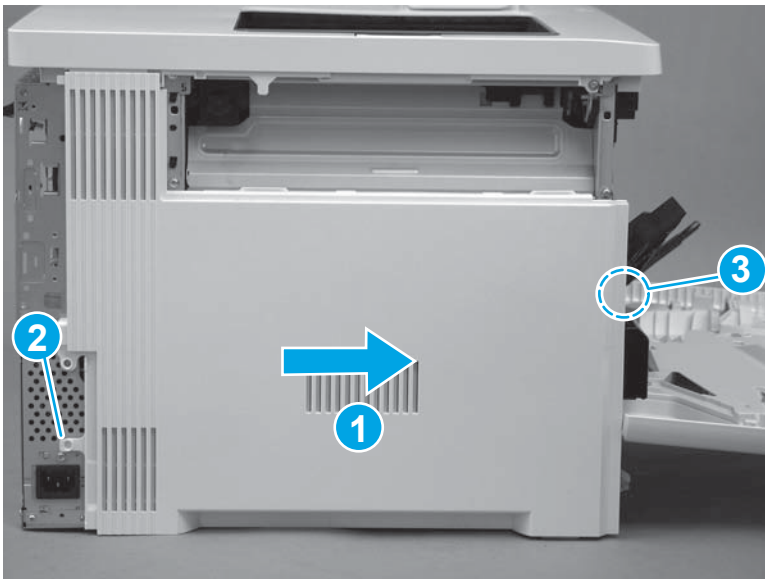

Step 21: Install the rear cover (M577)

 **NOTE:** This step is for the M577 models. For the M552 and M553 models, skip this step and go to [Step 23: Install the rear cover \(M552 and M553\) on page 1252](#).

1. Position the hooks (callout 1) on the cover in the slots (callout 2) in the printer.

Figure 1-2192 Position the hooks

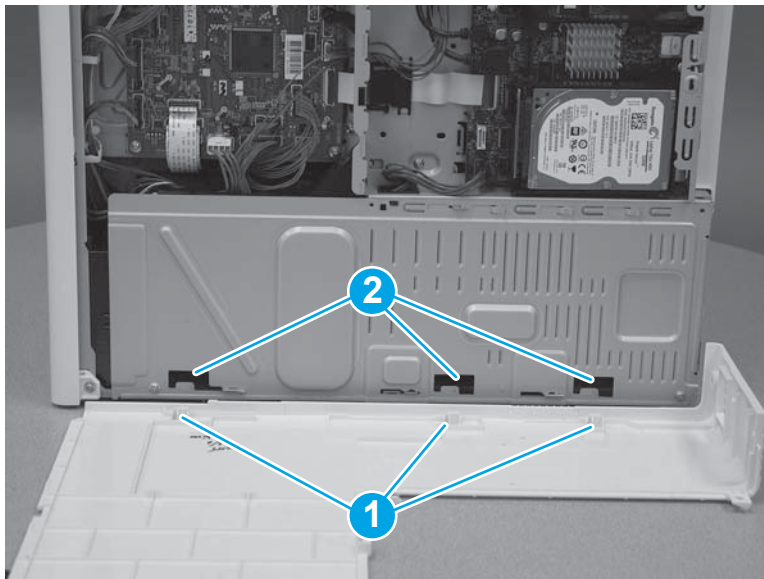

2. Position the back edge (callout 1) of the rear cover behind the edge (callout 2) of the right rear cover. Slide the cover to the left to install it.

Figure 1-2193 Install the cover

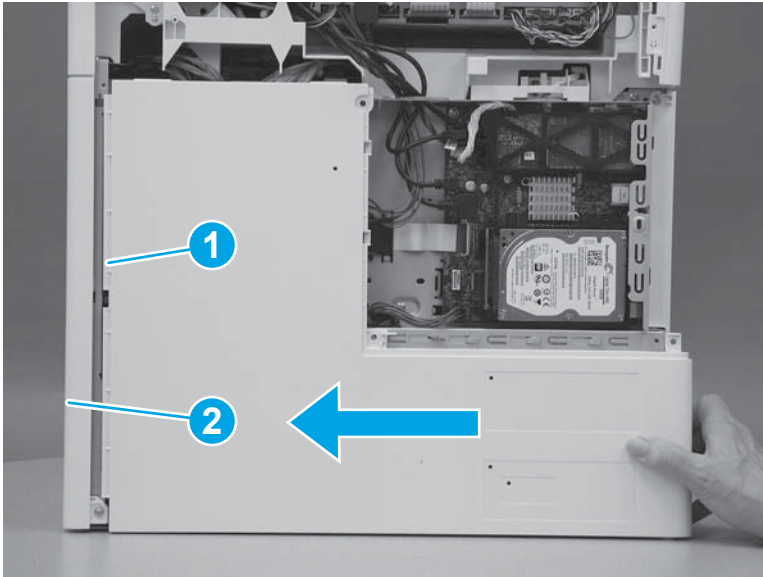

3. Install four screws (callout 1).

Figure 1-2194 Install four screws cover

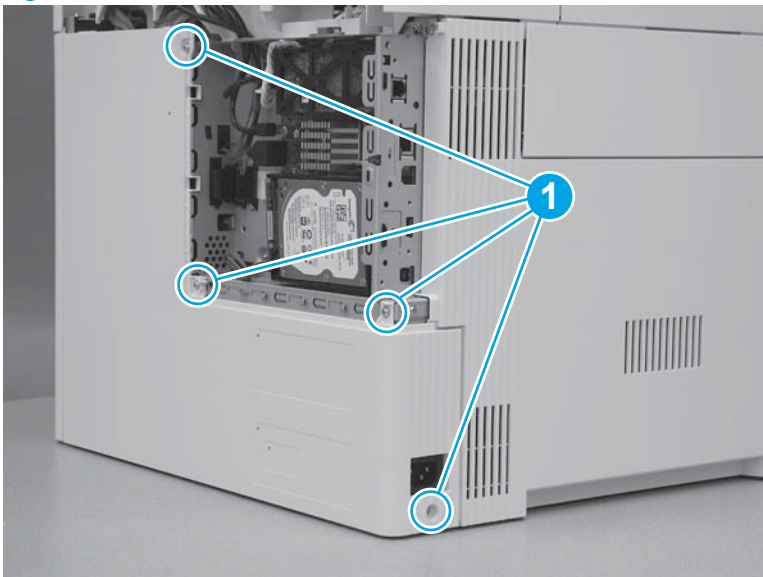

Step 22: Install the rear upper cover (M577)



NOTE: This step is for the M577 models. For the M552 and M553 models, skip this step and go to [Step 23: Install the rear cover \(M552 and M553\) on page 1252.](#)

1. Align the ridge (callout 1) on the lower edge of the rear upper cover in front of the tabs (callout 2) on the top edge of the rear cover.

Figure 1-2195 Align the cover

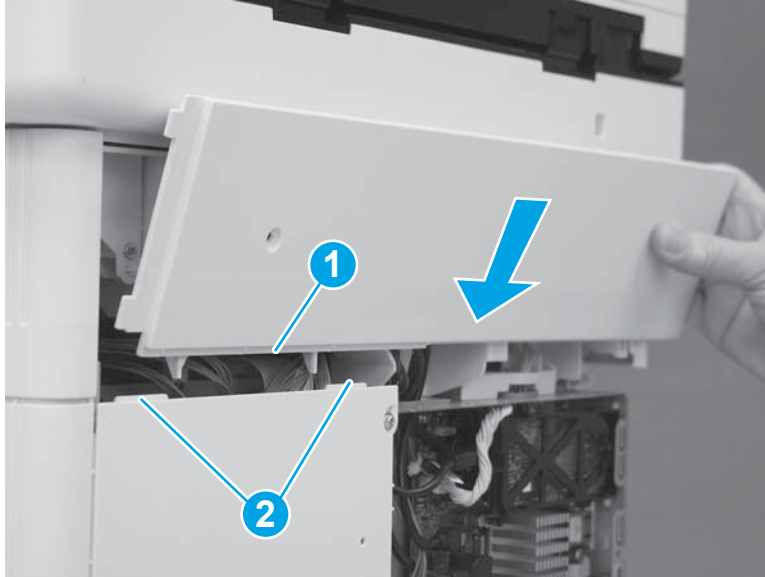

2. Rotate the top of the cover toward the printer.

Figure 1-2196 Rotate the top of the cover

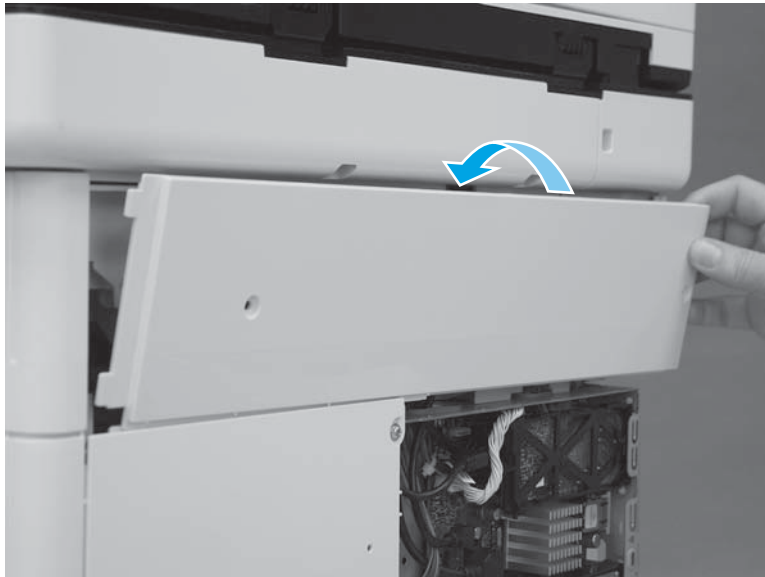

3. Slide the cover to the left (callout 1). Make sure that the tabs (callout 2) on the upper rear cover slide behind the edge (callout 3) of the right upper cover. Make sure that the cover is fully seated.

Figure 1-2197 Slide the cover

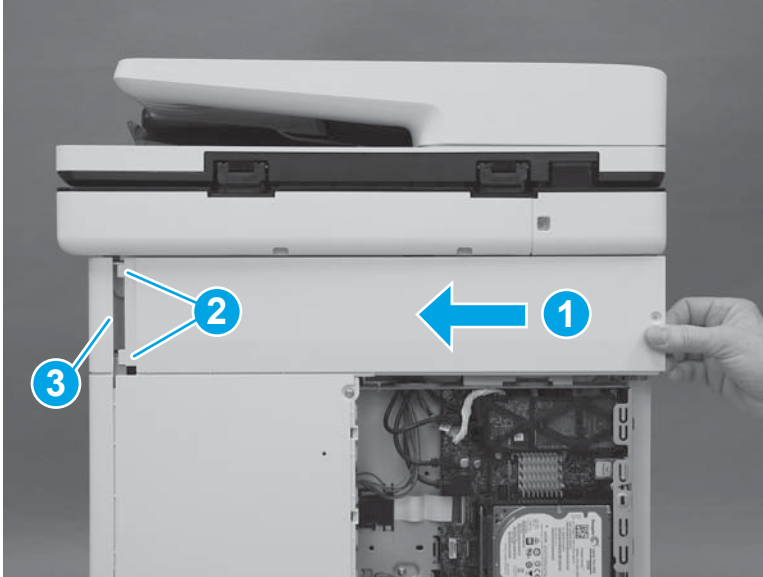

4. Install two screws (callout 1).

 **IMPORTANT:** These two screws are self-tapping screws for plastic. Rotate them counterclockwise to align them with the existing thread pattern, and then carefully turn them clockwise to tighten. Do not overtighten. This will prevent stripping the threads inside the screw holes.

Figure 1-2198 Install two screws



Step 23: Install the rear cover (M552 and M553)

 **NOTE:** This step is for the M552 and M553 models. For the M577 models, skip this step and go to [Step 24: Install the formatter \(M577\) on page 1253](#).

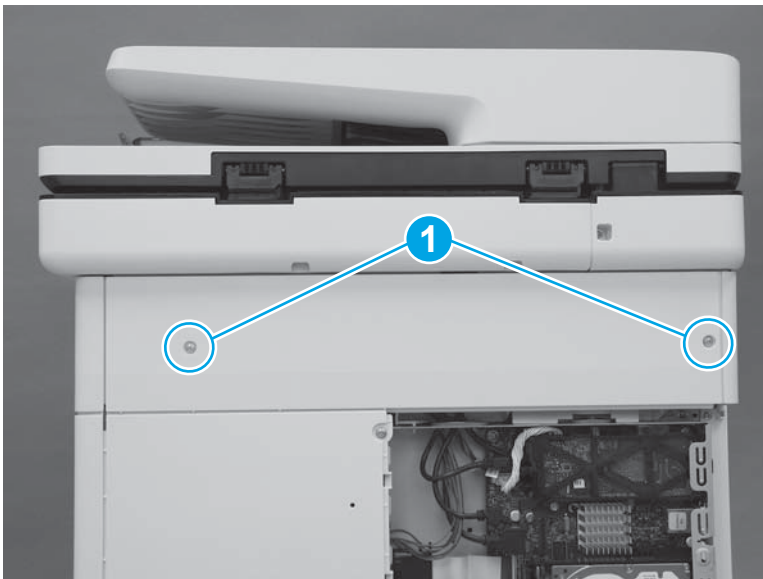
1. Position the top of the cover under the upper cover (callout 1), rotate the bottom of the cover onto the chassis (callout 2), and then slide the cover to the left (callout 3) to install it.

Figure 1-2199 Install the cover

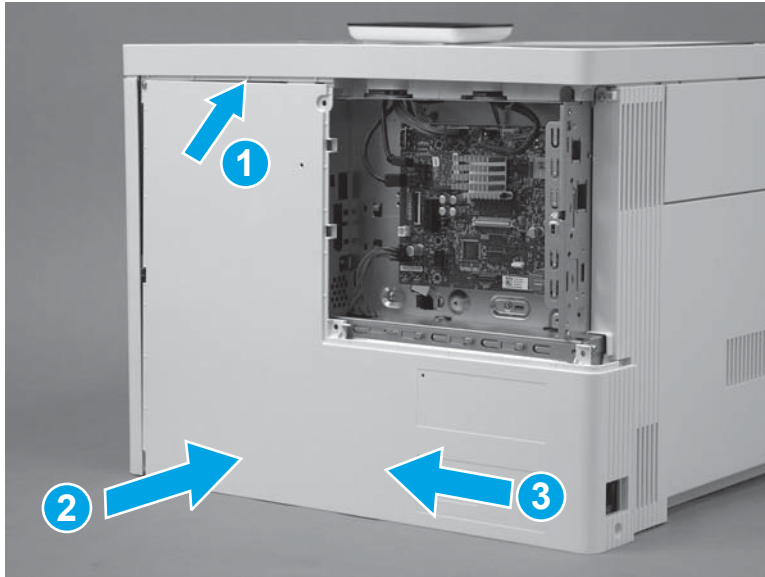

2. Install four screws (callout 1).

Figure 1-2200 Install four screws cover

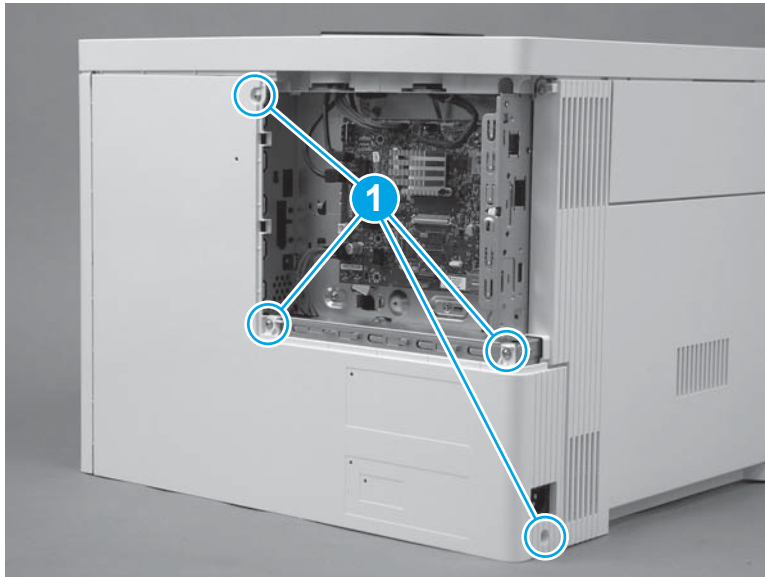

Step 24: Install the formatter (M577)

 **NOTE:** This step is for the M577 models. For the M552 and M553 models, skip this step and to go [Step 27: Install the formatter \(M552 and M553\) on page 1258.](#)

 **CAUTION:**  ESD-sensitive part.

1. Position the formatter in the printer. Make sure that the network port (callout 1) fits through the opening (callout 2) in the formatter case.

Figure 1-2201 Install the formatter

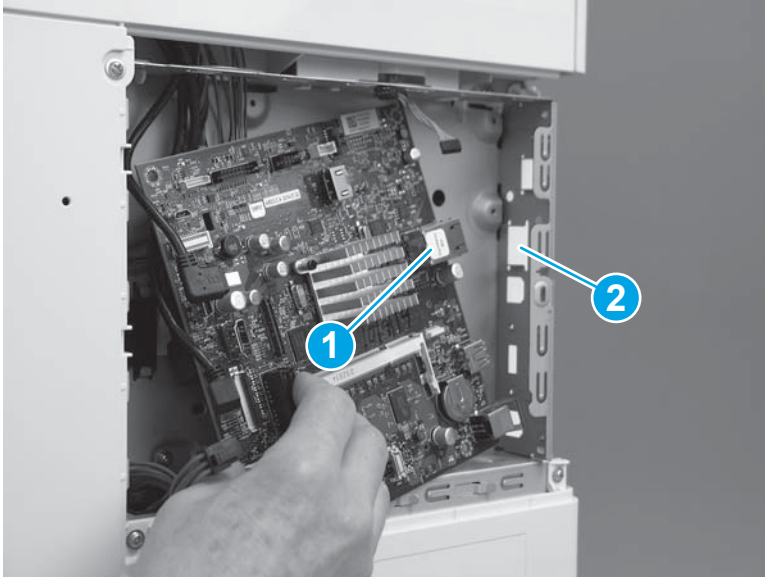

2. Install four screws (callout 1).

Figure 1-2202 Install four screws

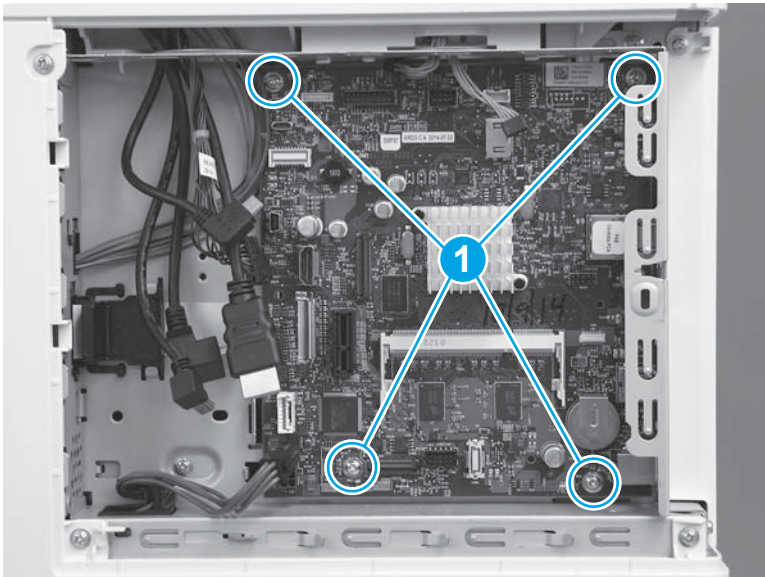

3. Connect all of the connectors on the formatter.

The following connectors are empty:

- All models: J1 (this connector is empty unless the optional DIMM is installed)
- All models: J3
- M577dn: J15 (this is the fax connector for the M577f/z/c models)
- All models: J21 (this connector is empty unless the optional internal USB ports component is installed)
- All models: J23

- All models: J24
- All models: J51
- All models: J57
- All models: J97
- All models: J98 (this connector is empty unless the optional trusted platform module (TPM) is installed)



 **IMPORTANT:** The flat-cable connector (callout 1) is a Zero Insertion Force (ZIF) connector that uses a hinged retainer to secure the flat cable. The hinged retainer must be opened to install the flat cable, and then closed after the cable is installed.

Figure 1-2203 Connect all connectors

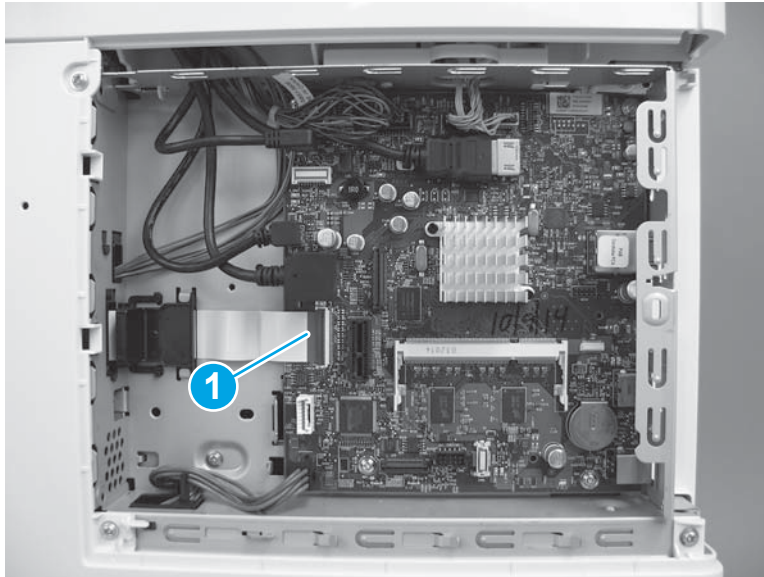

Step 25: Install the fax PCA (M577c/f/z)

 **NOTE:** This step is for the M577c/f/z models. For the M577n model, skip this step and go to [Step 26: Install the HDD \(M577\) on page 1257](#).

For the M552 and M553 models, skip this step and go to [Step 27: Install the formatter \(M552 and M553\) on page 1258](#).

 **CAUTION:**  ESD-sensitive part.

1. Position the tab and telephone port (callout 1) on the fax PCA in the slots (callout 2) in the formatter case.

Figure 1-2204 Position the fax PCA

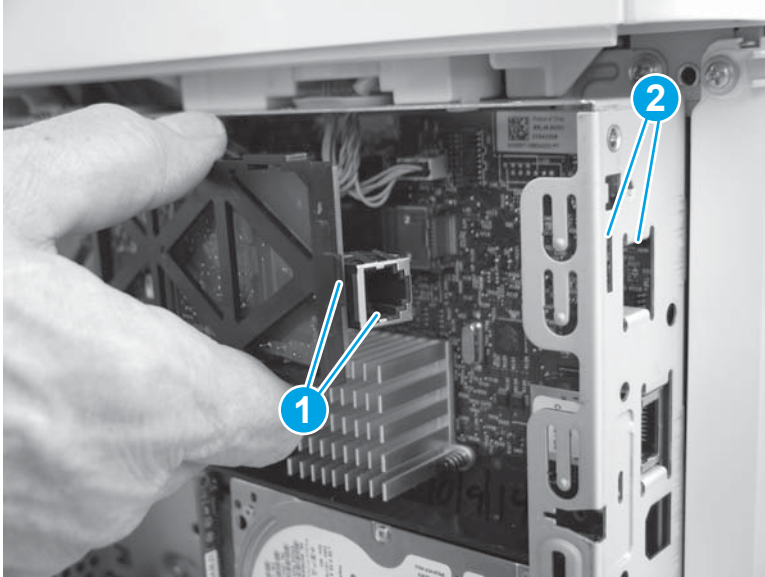

2. Slide the fax PCA to the right (callout 1) until the tab and telephone port described in the previous step and seated in the formatter case. Position the retainer (callout 2) in the slot (callout 3) in the formatter. Rotate the end of the fax PCA toward the formatter (callout 4) until the retainer snaps into place.

Figure 1-2205 Install the fax PCA

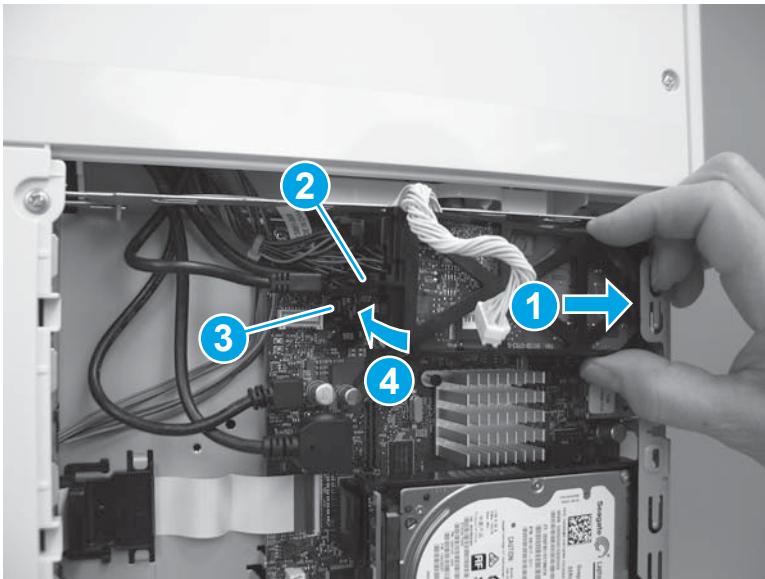

3. Position the cable (callout 1) in the guide (callout 2), and then connect one connector (callout 3).

Figure 1-2206 Connect the connector

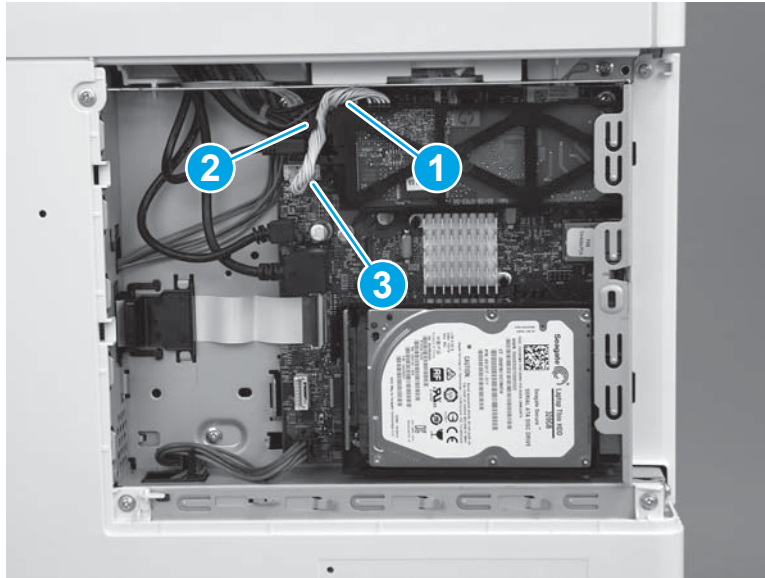

Step 26: Install the HDD (M577)

 **NOTE:** This step is for the M577 models. For the M552 and M553 models, skip this step and go to [Step 27: Install the formatter \(M552 and M553\)](#) on page 1258.

 **CAUTION:**  ESD-sensitive part.

1. Align the end of the bracket (callout 1) with the slot in the chassis (callout 2), and then slide the HDD into the printer (callout 3) to engage the bracket with the chassis.

Figure 1-2207 Install the holder

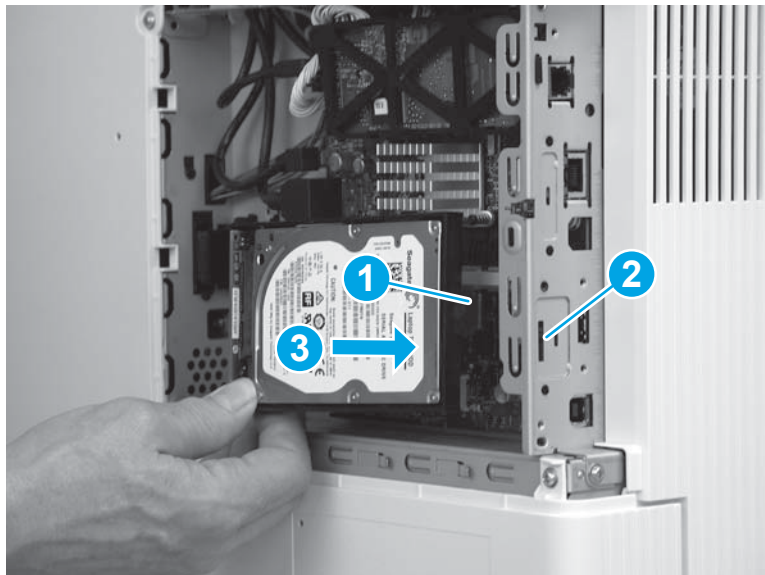

2. Hold the HDD connector latch (callout 1) in the released position, and then rotate the HDD down and into the connector on the formatter to install it.

 **NOTE:** Make sure that the tab (callout 2) snaps into place, and that the HDD is securely installed.

Figure 1-2208 Release the HDD



Step 27: Install the formatter (M552 and M553)

 **NOTE:** This step is for the M552 and M553 models. For the M577 models, skip this step and go to [Step 28: Install the formatter cover on page 1260](#).

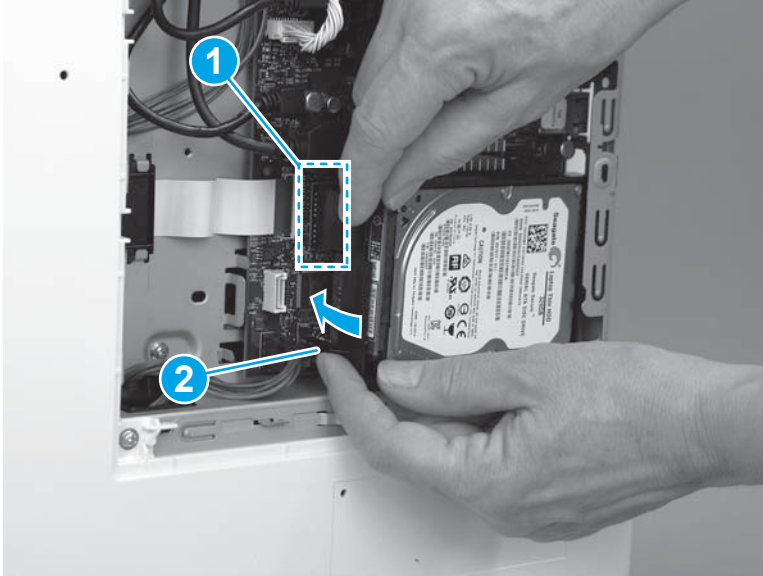
If the optional hard-disk drive (HDD) was removed, do not forget to reinstall it after the formatter is reinstalled.

Engage the HDD holder with the chassis, rotate the HDD connector down and into the connector on the formatter. Make sure that the tabs snap into place.

 **CAUTION:**  ESD-sensitive part.

1. Position the formatter in the printer, and then install four screws (callout 1).

Figure 1-2209 Install the formatter

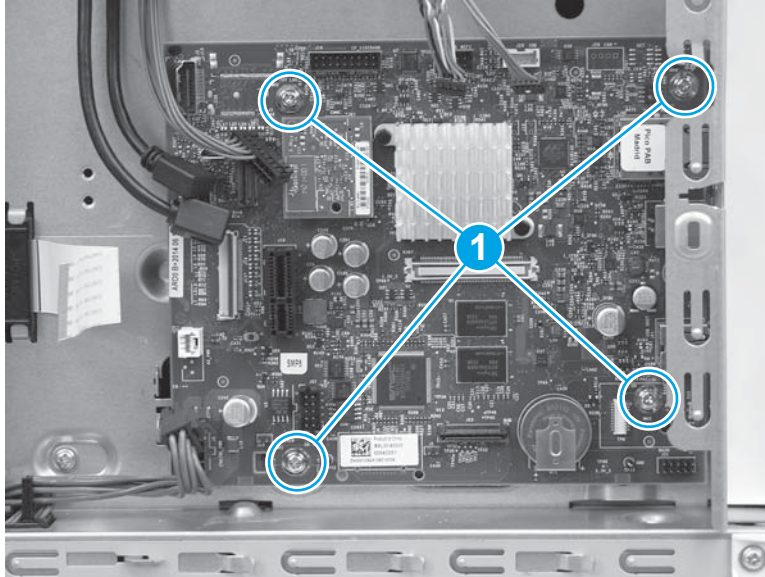

2. Connect all of the connectors on the formatter.

The following connectors are empty:

- All models: J1 (this connector is empty unless the optional DIMM is installed)
- M553n/dn and M552dn: J2 (callout 1; this is the touchscreen connector for the M553x model)
- All models: J9 (this connector is empty unless the optional internal USB ports component is installed)
- All models: J18 (this connector is empty unless the optional hard-disk-drive (HDD) is installed)
- All models: J23
- All models: J24
- M553n/dn and M552dn: J25 (this is the wireless connector for the M553x model)
- All models: J57
- All models: J98 (this connector is empty unless the optional trusted platform module (TPM) is installed)



 **IMPORTANT:** The flat-cable connector (callout 2) is a Zero Insertion Force (ZIF) connector that uses a hinged retainer to secure the flat cable. The hinged retainer must be opened to install the flat cable.

Figure 1-2210 Connect all connectors

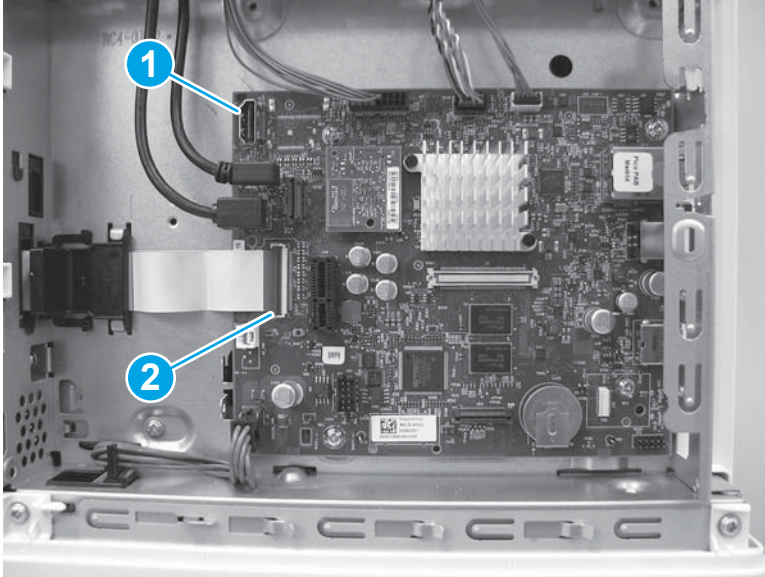

Step 28: Install the formatter cover

- ▲ Slide the cover onto the printer (callout 1) to install it.

 **NOTE:** Make sure that the tabs on the formatter cover align with the slots provided in the printer (callout 2). Tighten the two thumbscrews (callout 3).

 **TIP:** If needed, use the edge of a coin to turn the thumbscrews.

Figure 1-2211 Install the cover



Step 29: Install the TCU

1. Verify that the toner collection hatch cover is in the closed position on the TCU.

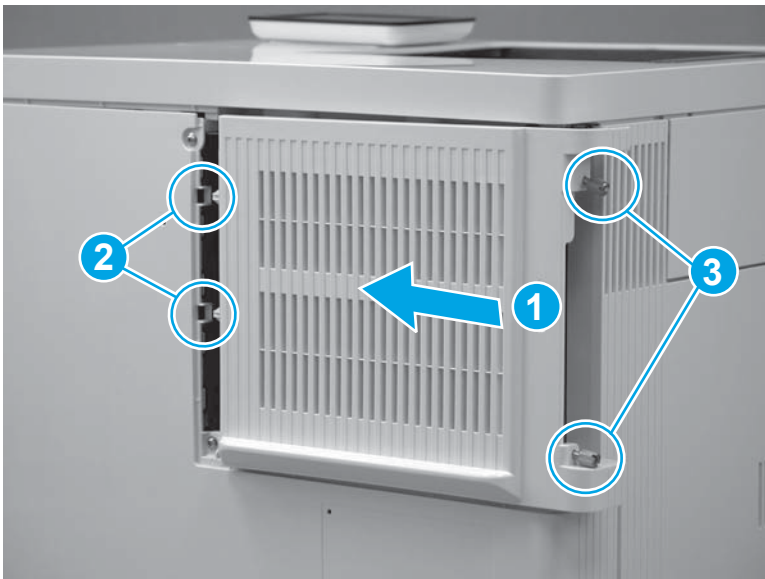
Figure 1-2212 Verify that the toner collection hatch cover is closed

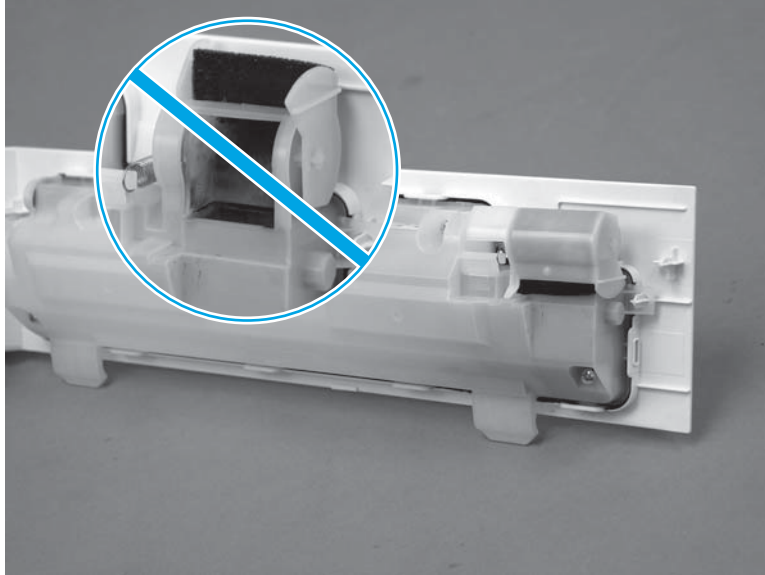

2. Position the TCU with the hinges in the slots provided in the printer (callout 1), and then rotate the TCU up and into the closed position.

 **NOTE:** The toner collection hatch cover automatically opens when the TCU is closed.

Figure 1-2213 Install the TCU



3. Close the front door.

Figure 1-2214 Close the front door

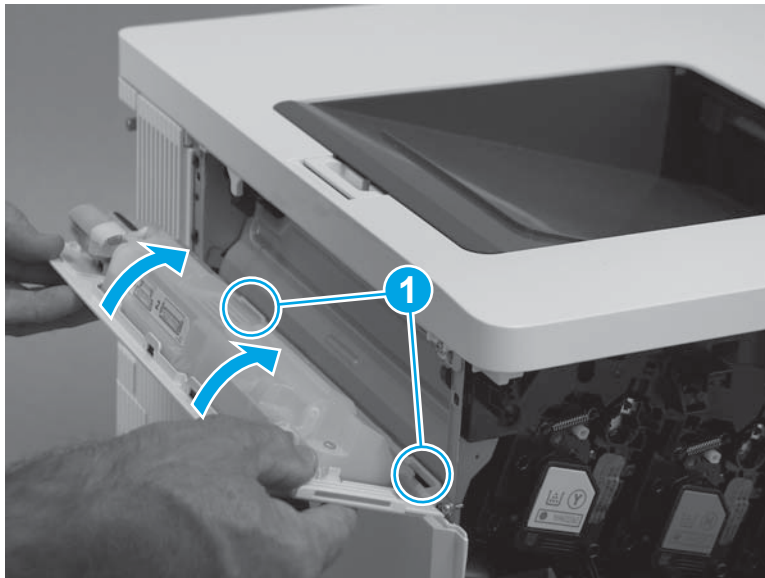

Removal and replacement: Laser/scanner assembly

- [Introduction](#)
- [Step 1: Remove the toner collection unit \(TCU\)](#)
- [Step 2: Remove the toner cartridges](#)
- [Step 3: Remove the formatter cover](#)
- [Step 4: Remove the formatter \(M552 and M553\)](#)
- [Step 5: Remove the hard-disk drive \(HDD\) \(M577\)](#)
- [Step 6: Remove the fax PCA \(M577c/f/z\)](#)
- [Step 7: Remove the formatter \(M577\)](#)
- [Step 8: Remove the rear cover \(M552 and M553\)](#)
- [Step 9: Remove the rear upper cover \(M577\)](#)
- [Step 10: Remove the rear cover \(M577\)](#)
- [Step 11: Remove the left cover](#)
- [Step 12: Remove the formatter case](#)
- [Step 13: Remove the low-voltage power supply \(LVPS\)](#)
- [Step 14: Remove the high-voltage power supply D \(HVPSD\)](#)
- [Step 15: Remove the laser/scanner assembly](#)
- [Step 16: Unpack the replacement assembly](#)
- [Step 17: Install the laser/scanner assembly](#)
- [Step 18: Install the HVPSD](#)
- [Step 19: Install the LVPS](#)
- [Step 20: Install the formatter case](#)
- [Step 21: Install the left cover](#)
- [Step 22: Install the rear cover \(M577\)](#)
- [Step 23: Install the rear upper cover \(M577\)](#)
- [Step 24: Install the rear cover \(M552 and M553\)](#)
- [Step 25: Install the formatter \(M577\)](#)
- [Step 26: Install the fax PCA \(M577c/f/z\)](#)
- [Step 27: Install the HDD \(M577\)](#)
- [Step 28: Install the formatter \(M552 and M553\)](#)
- [Step 29: Install the formatter cover](#)

- [Step 30: Install the toner cartridges](#)
- [Step 31: Install the TCU](#)

Introduction



This document provides the procedures to remove and replace the laser/scanner assembly.

Before performing service

Turn the printer power off

- Disconnect the power cable.

 **WARNING!** To avoid damage to the printer, turn the printer off, wait 30 seconds, and then remove the power cord before attempting to service the printer.

 **CAUTION:**  This part contains components that are electrostatic discharge (ESD) sensitive. To reduce the possibility of ESD damage, always touch the sheet-metal chassis to ground yourself before touching an ESD sensitive part.

Use the table below to identify the correct part number for your printer, and then go to <http://h20141.www2.hp.com/hpparts> to order the part.

Laser/scanner assembly part number	
RM2-6545-000CN	Laser/scanner assembly

Required tools

- #2 Phillips screwdriver with a magnetic tip

After performing service

Make sure that all of the connectors on the HVPSD are fully seated.

Make sure that all of the connectors on the LVPS are fully seated.

Make sure that all of the connectors on the formatter are fully seated.

Make sure that the formatter cover is fully seated, and that the thumbscrews are finger tight after replacing it.

Turn the printer power on

- Connect the power cable.
- Use the power switch to turn the power on.

Post service test

Print a configuration page to make sure that the printer is functioning correctly.

Step 1: Remove the toner collection unit (TCU)

1. Open the front door.

Figure 1-2215 Open the front door



2. Open the TCU.

 **NOTE:** The toner collection hatch cover automatically closes when the TCU is opened.

Figure 1-2216 Open the TCU



3. Pull the TCU away from the printer at an angle to remove it.

⚠ CAUTION: Do not open the toner collection hatch cover when handling the TCU. If toner gets on clothing, wipe it off by using a dry cloth and wash the clothes in cold water. Hot water sets toner into fabric.

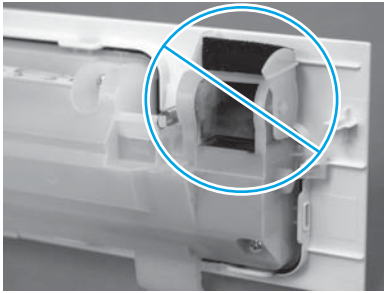
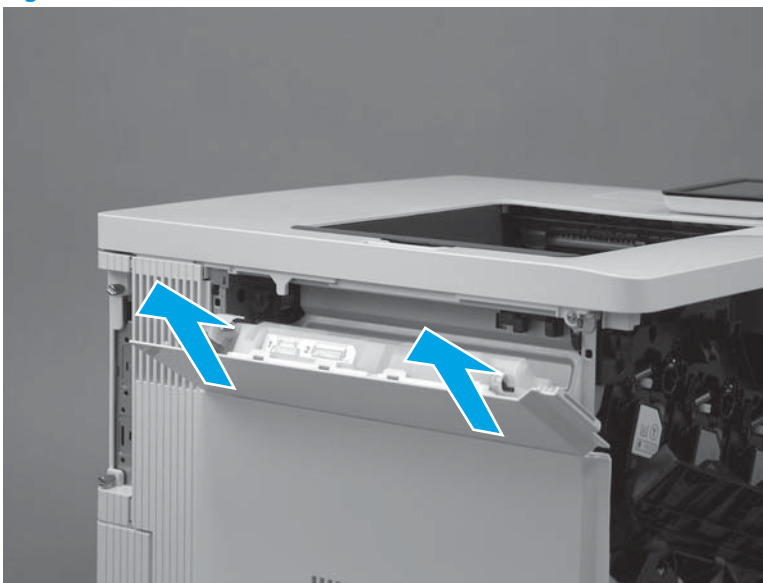

Figure 1-2217 Remove the TCU



Step 2: Remove the toner cartridges

- ▲ Grasp the handle of the toner cartridge and pull out to remove it. Repeat this step for the remaining toner cartridges.

Figure 1-2218 Remove the toner cartridge

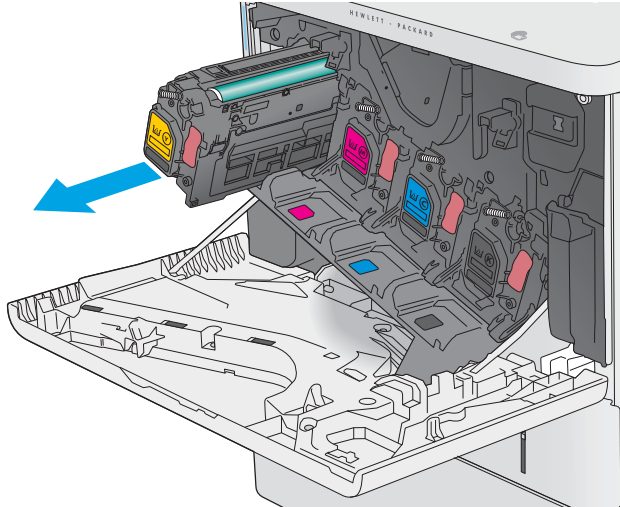

Step 3: Remove the formatter cover

1. Locate the formatter cover.

Figure 1-2219 Locate the formatter cover

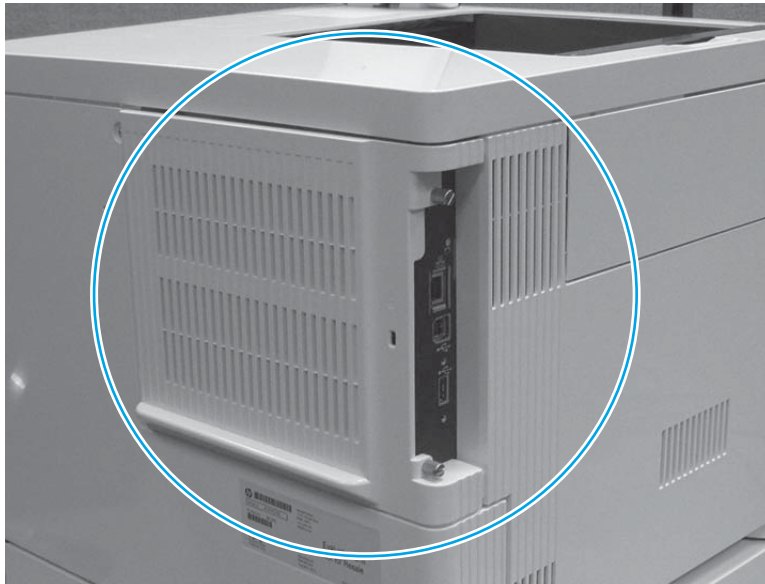

2. Loosen the two thumbscrews (callout 1). Grasp the two thumbscrews, and then slide the cover away from the printer (callout 2) to remove it.

 **TIP:** If needed, use the edge of a coin to turn the thumbscrews.

Figure 1-2220 Loosen the thumbscrews



Step 4: Remove the formatter (M552 and M553)

 **NOTE:** This step is for the M552 and M553 models. For the M577 models, skip this step and go to [Step 5: Remove the hard-disk drive \(HDD\) \(M577\) on page 1270](#).

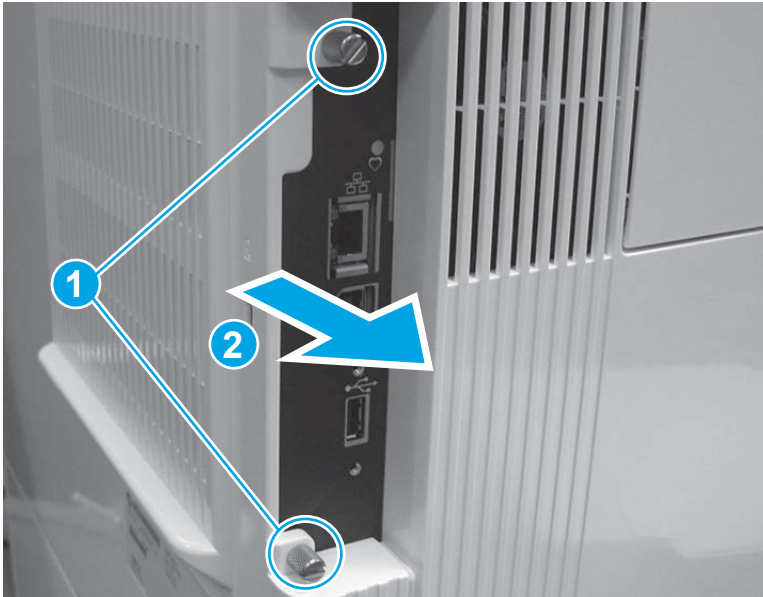
If the optional hard-disk drive (HDD) is installed, it must be removed to gain access to the formatter mounting screws.

Release two tabs along the left edge of the HDD, rotate the left edge away from the product, and then slide the HDD to the left to remove it.

 **CAUTION:**  ESD-sensitive part.

1. Disconnect all of the connectors on the formatter.

The following connectors are empty:

- All models: J1 (this connector is empty unless the optional DIMM is installed)
- M553n/dn and M552dn: J2 (callout 1; this is the touchscreen connector for the M553x model)
- All models: J9 (this connector is empty unless the optional internal USB ports component is installed)
- All models: J18 (this connector is empty unless the optional hard-disk-drive (HDD) is installed)
- All models: J23
- All models: J24

- M553n/dn and M552dn: J25 (this is the wireless connector for the M553x model)
- All models: J57
- All models: J98 (this connector is empty unless the optional trusted platform module (TPM) is installed)

 **IMPORTANT:** The flat-cable connector (callout 2) is a Zero Insertion Force (ZIF) connector that uses a hinged retainer to secure the flat cable. The hinged retainer must be opened to release the flat cable.

Figure 1-2221 Disconnect all connectors



2. Remove four screws (callout 1), and then remove the formatter.

Figure 1-2222 Remove the formatter

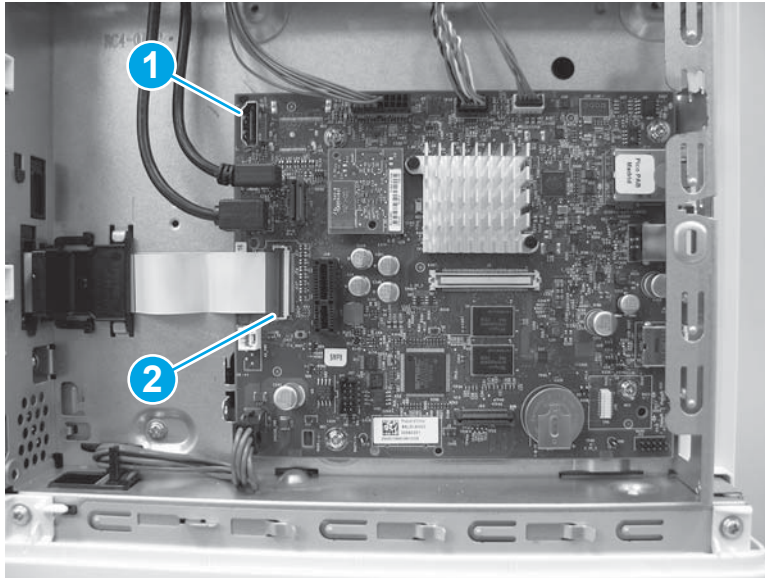
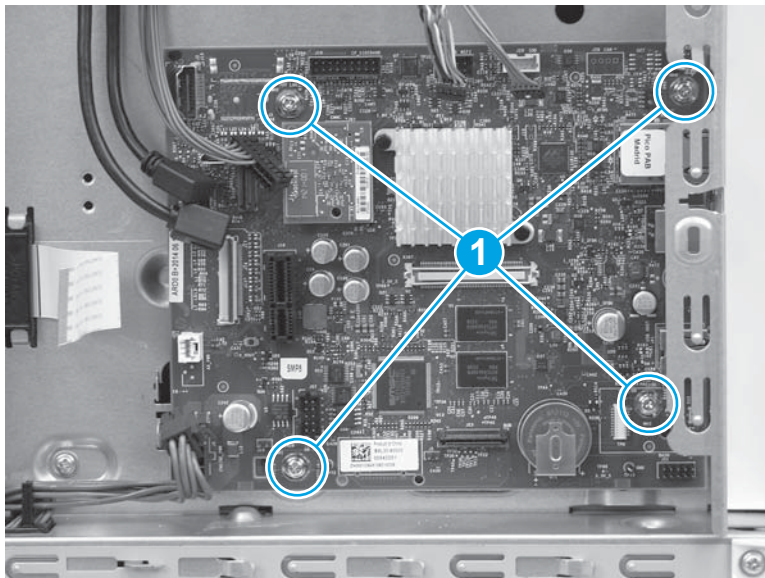

Step 5: Remove the hard-disk drive (HDD) (M577)

 **NOTE:** This step is for the M577 models. For the M552 and M553 models, skip this step and go to [Step 8: Remove the rear cover \(M552 and M553\) on page 1274.](#)

 **CAUTION:**  ESD-sensitive part.

1. Release two tabs (callout 1). Hold the tabs in the released position, and then rotate the hard disk drive (HDD) up (callout 2) to release the connector from the formatter.

Figure 1-2223 Release the HDD

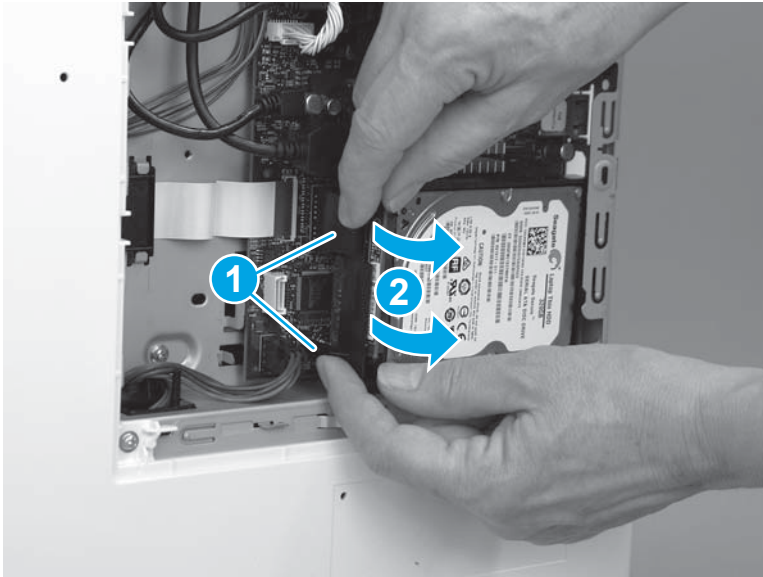

2. Slide the HDD away from the printer to remove it.

Figure 1-2224 Remove the HDD

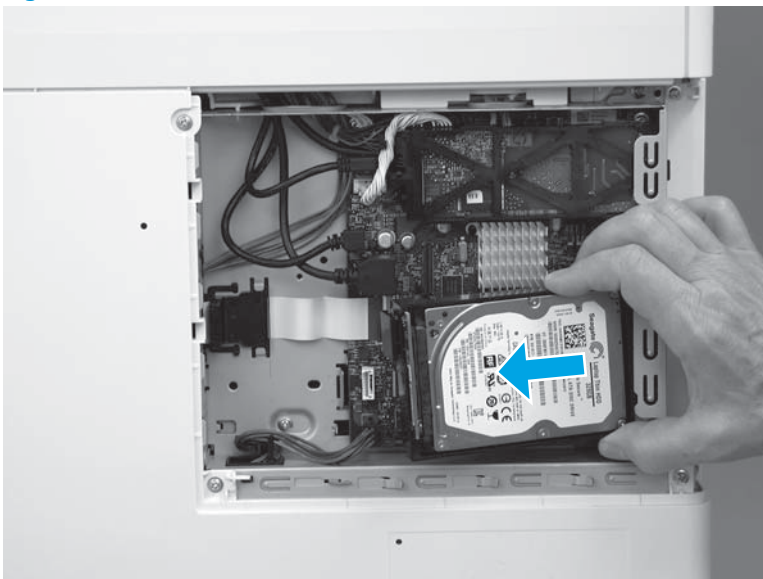

Step 6: Remove the fax PCA (M577c/f/z)

 **NOTE:** This step is for the M577c/f/z models. For the M577n model, skip this step and go to [Step 7: Remove the formatter \(M577\) on page 1272](#).

For the M552 and M553 models, skip this step and go to [Step 8: Remove the rear cover \(M552 and M553\) on page 1274](#).

 **CAUTION:**  ESD-sensitive part.

1. Locate the fax PCA component on the formatter.

Figure 1-2225 Locate the fax PCA

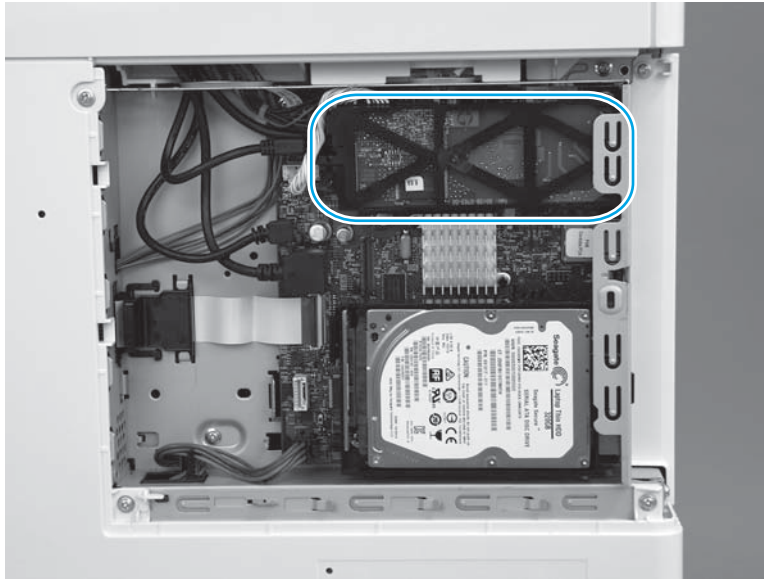

2. Release the connector latch (callout 1), and then pull the connector away from the formatter (callout 2) to disconnect it.

Figure 1-2226 Disconnect one connector

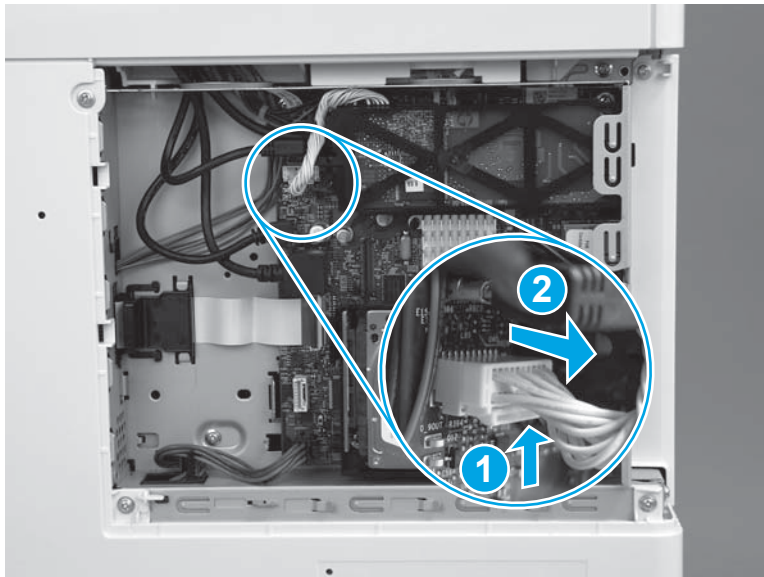

3. Release one retainer (callout 1) by pressing the bracket arms together.

Figure 1-2227 Release one latch

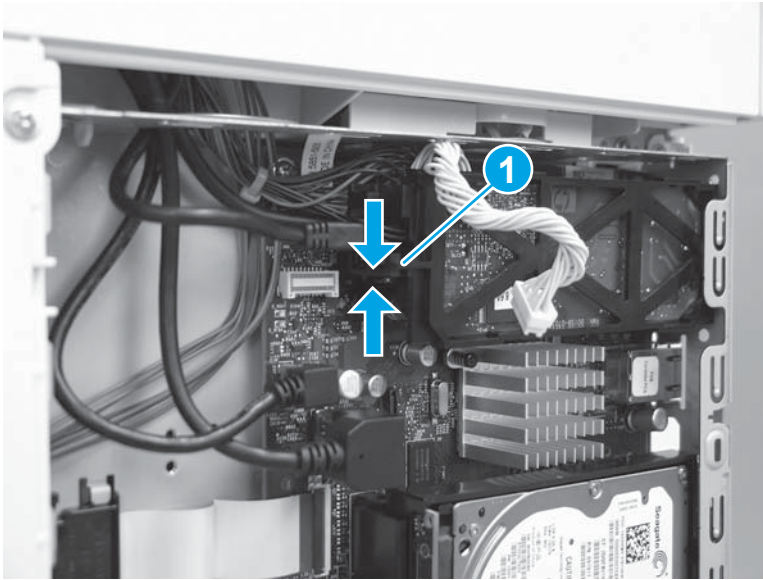

4. Rotate the end of the fax PCA (callout 1) away from the formatter, and then slide the PCA left (callout 2) to remove it.

Figure 1-2228 Remove the fax PCA

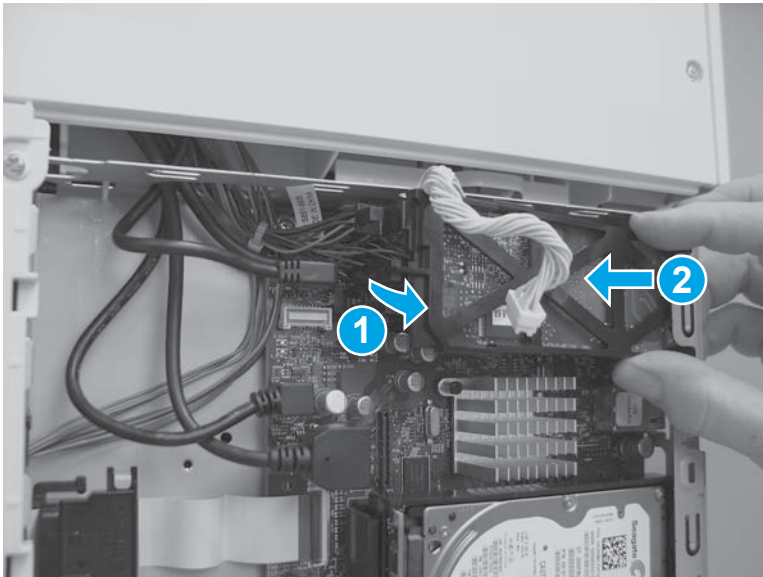

Step 7: Remove the formatter (M577)

 **NOTE:** This step is for the M577 models. For the M552 and M553 models, skip this step and go to [Step 8: Remove the rear cover \(M552 and M553\) on page 1274.](#)

 **CAUTION:**  ESD-sensitive part.

1. Disconnect all of the connectors on the formatter.

The following connectors are empty:

- All models: J1 (this connector is empty unless the optional DIMM is installed)
- All models: J3
- M577dn: J15 (this is the fax connector for the M577f/z/c models)
- All models: J21 (this connector is empty unless the optional internal USB ports component is installed)
- All models: J23
- All models: J24
- All models: J51
- All models: J57
- All models: J97
- All models: J98 (this connector is empty unless the optional trusted platform module (TPM) is installed)

 **IMPORTANT:** The flat-cable connector (callout 1) is a Zero Insertion Force (ZIF) connector that uses a hinged retainer to secure the flat cable. The hinged retainer must be opened to release the flat cable.

Figure 1-2229 Disconnect all connectors



2. Remove four screws (callout 1).

Figure 1-2230 Remove four screws

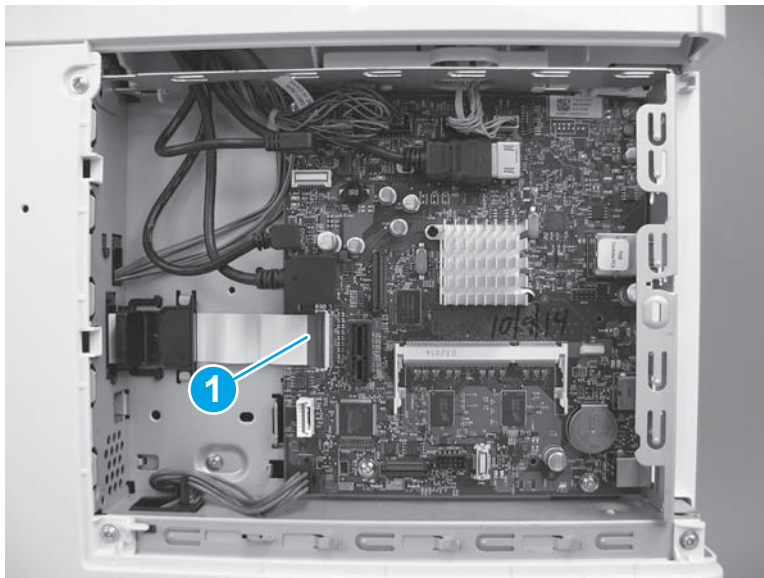
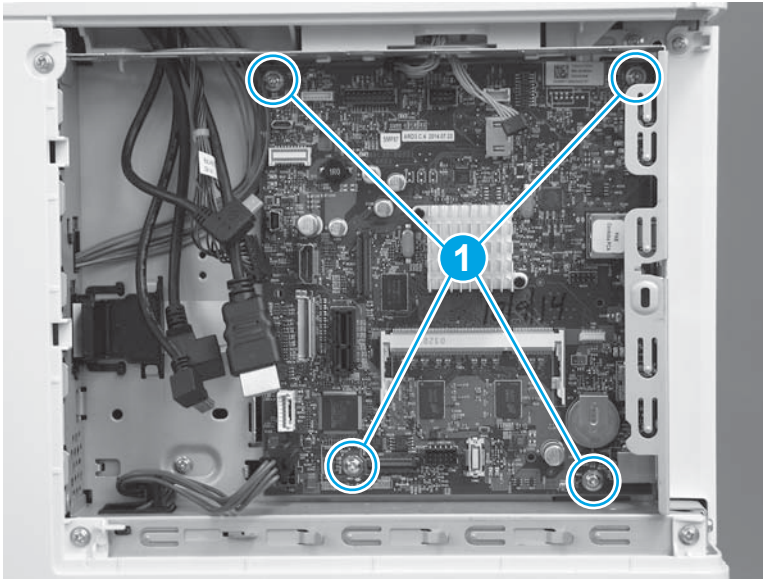

3. Remove the formatter.

Figure 1-2231 Remove the formatter

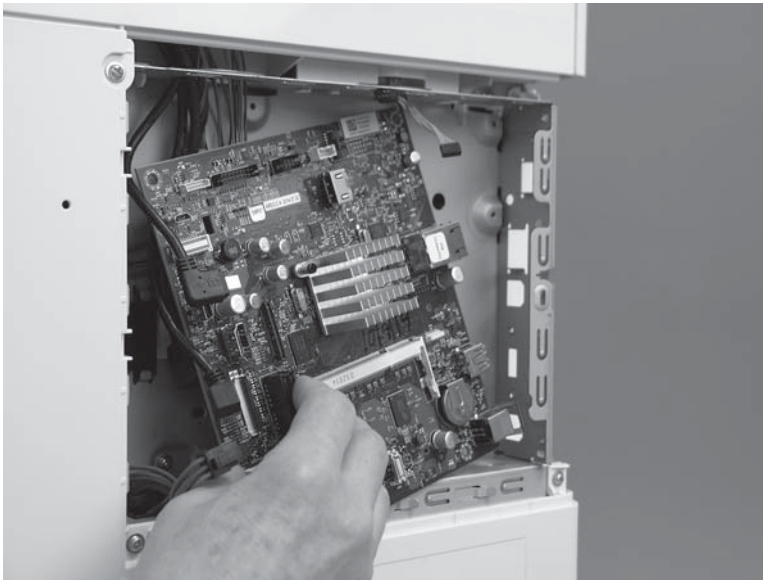

Step 8: Remove the rear cover (M552 and M553)



NOTE: This step is for the M552 and M553 models. For the M577 models, skip this step and go to [Step 9: Remove the rear upper cover \(M577\) on page 1275.](#)

1. Remove four screws (callout 1).

Figure 1-2232 Remove four screws

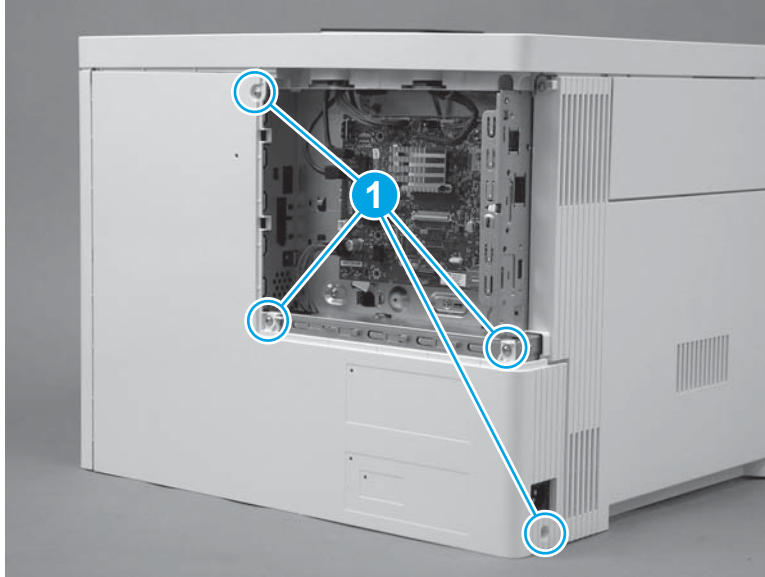

2. Slightly slide the cover to the right (callout 1), rotate the bottom of the cover away from the printer (callout 2), and then pull the top of the cover away from the printer (callout 3) to remove the cover.

Figure 1-2233 Remove the cover

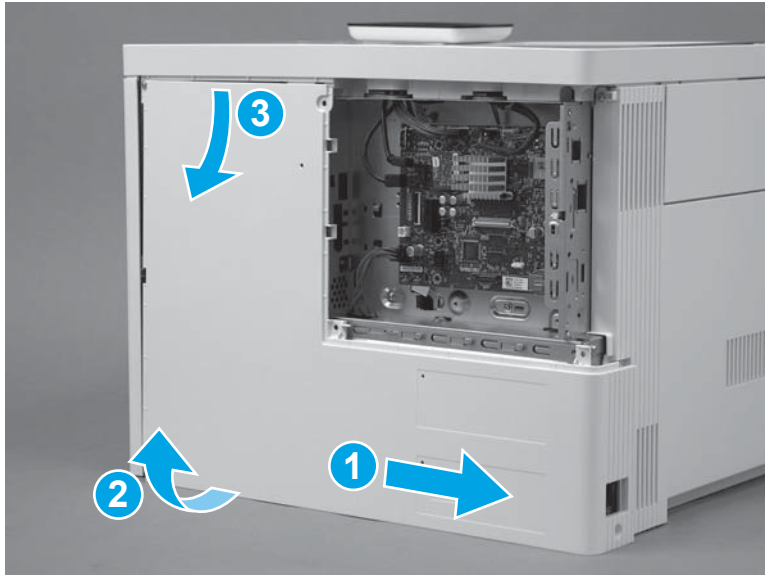

Step 9: Remove the rear upper cover (M577)



NOTE: This step is for the M577 models. For the M552 and M553 models, skip this step and go to [Step 11: Remove the left cover on page 1278](#).

1. Remove two screws (callout 1).



Reinstallation tip: These two screws are self-tapping screws for plastic. When reinstalling them, rotate the screws counterclockwise to align them with the existing thread pattern, and then carefully turn them clockwise to tighten. Do not overtighten. This will prevent stripping the threads inside the screw holes.

Figure 1-2234 Remove two screws

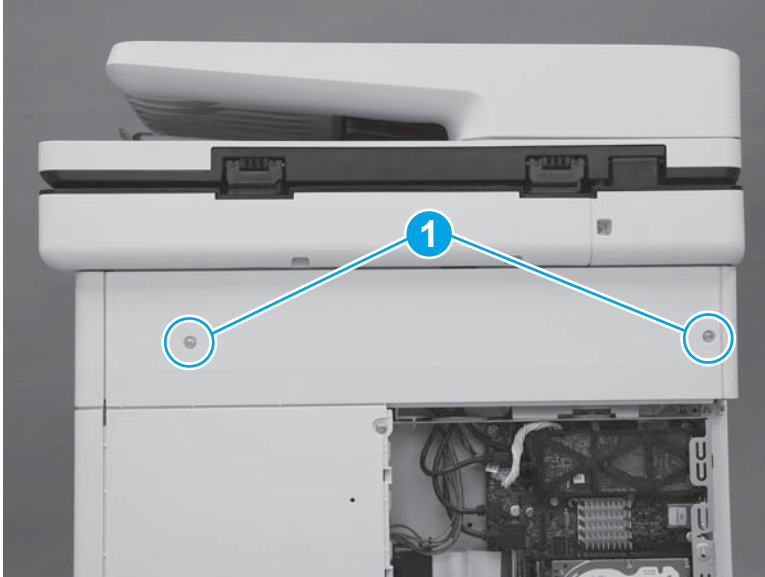

2. Use a small, flat blade screwdriver to release the right edge of the cover.

Figure 1-2235 Release the right edge

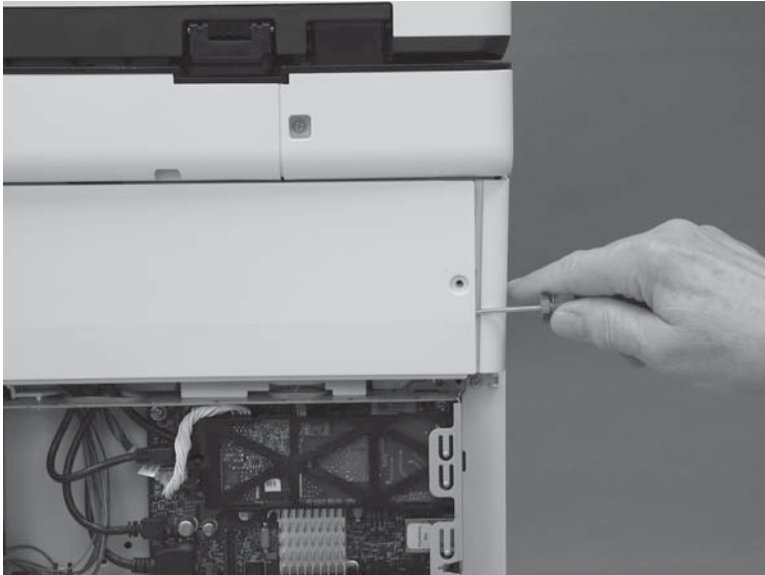

3. Pull the right edge of the cover (callout 1) away from the printer, and then slide the cover to the right (callout 2).

Figure 1-2236 Slide the cover right

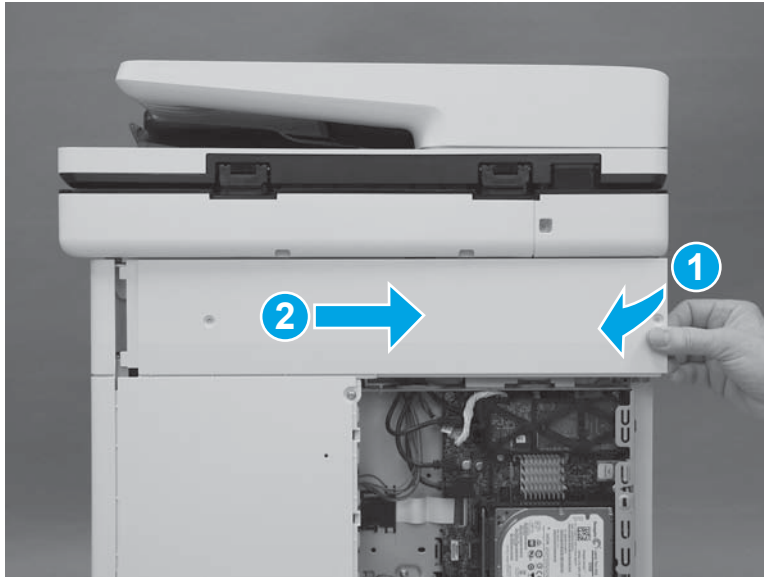

4. Remove the cover.

Figure 1-2237 Remove the cover

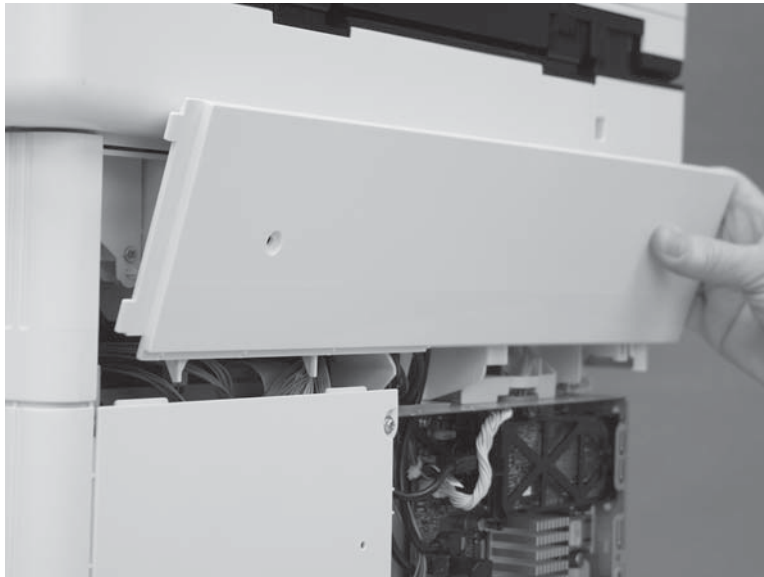

Step 10: Remove the rear cover (M577)

 **NOTE:** This step is for the M577 models. For the M552 and M553 models, skip this step and go to [Step 11: Remove the left cover on page 1278.](#)

1. Remove four screws (callout 1).

Figure 1-2238 Remove four screws

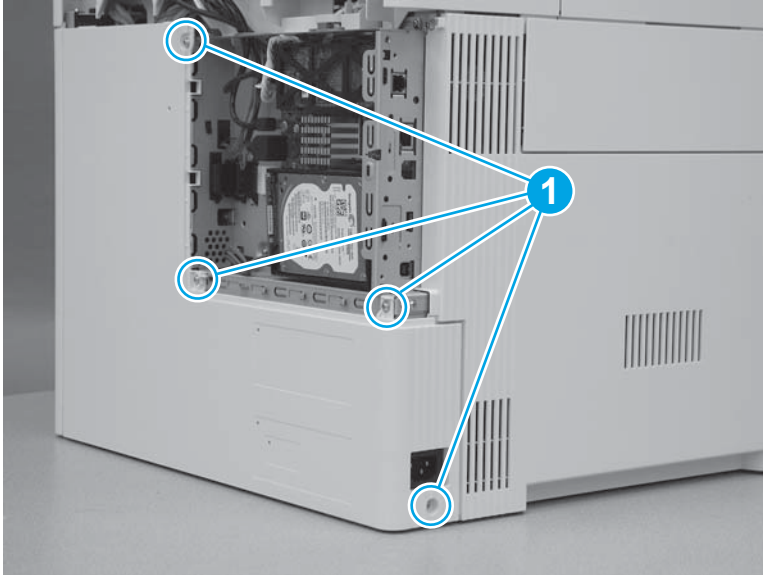

2. Slide the cover to the right to remove it.

Figure 1-2239 Remove the cover

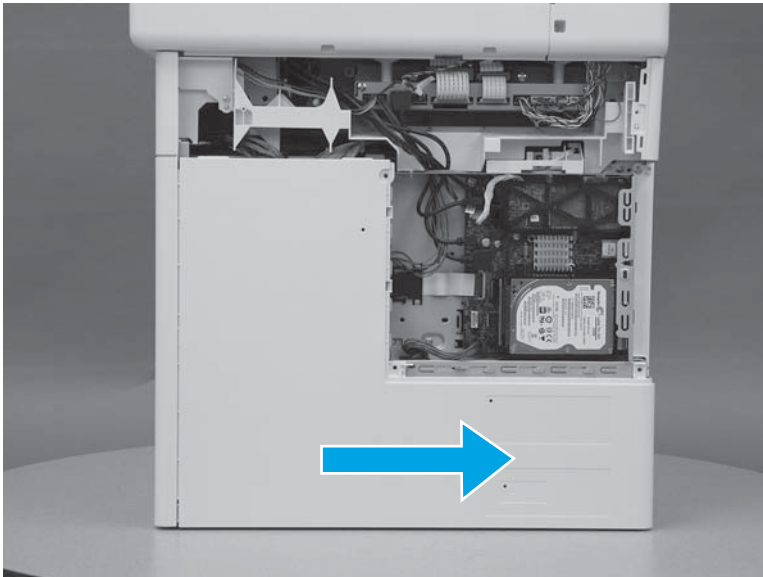

Step 11: Remove the left cover

1. At the left side of the printer, remove one screw (callout 1).

Figure 1-2240 Remove one screw



2. Release one tab (callout 1), rotate the front edge of the cover away from the printer (callout 2), and then slide the cover (callout 3) toward the rear of the printer to release it.

Figure 1-2241 Release the cover

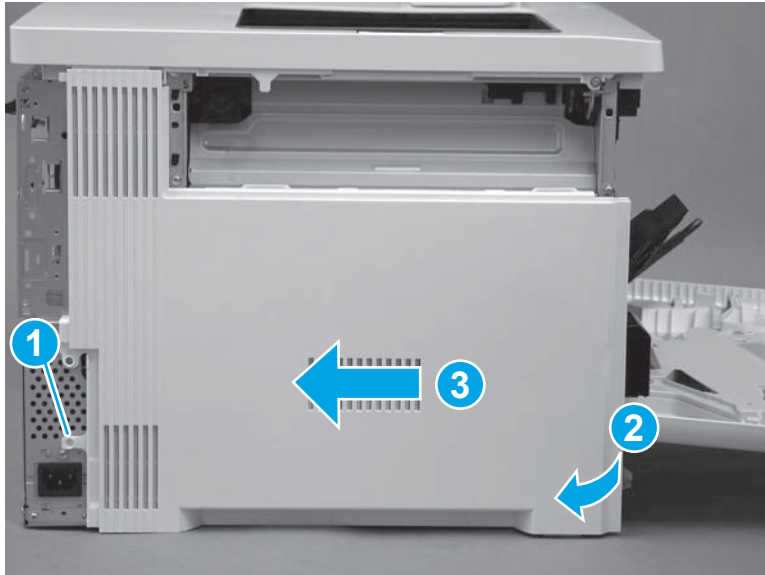

3. Remove the cover.

Figure 1-2242 Remove the cover

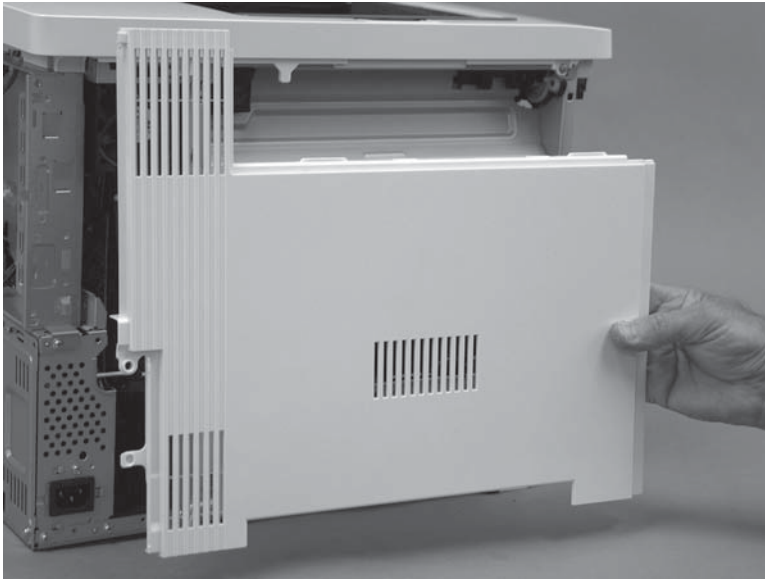

Step 12: Remove the formatter case

1. **M577 only:** Disconnect one connector (callout 1), and then pass the wire harness (callout 2) through two openings in the formatter case (callout 3).

Figure 1-2243 Disconnect one connector

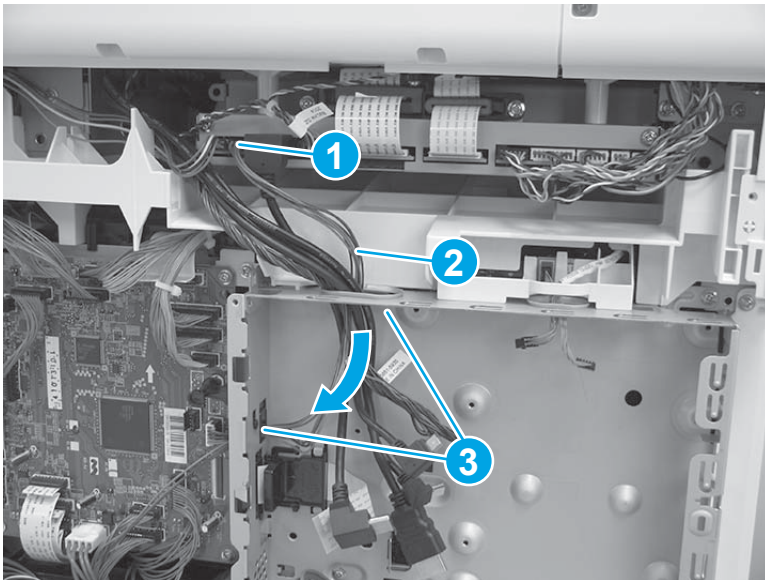

2. Release two tabs (callout 1) on the black plastic bracket. Hold the tabs in the released position, and then slide the bracket (callout 2) to the right to remove it from the formatter case.

Figure 1-2244 Remove the bracket

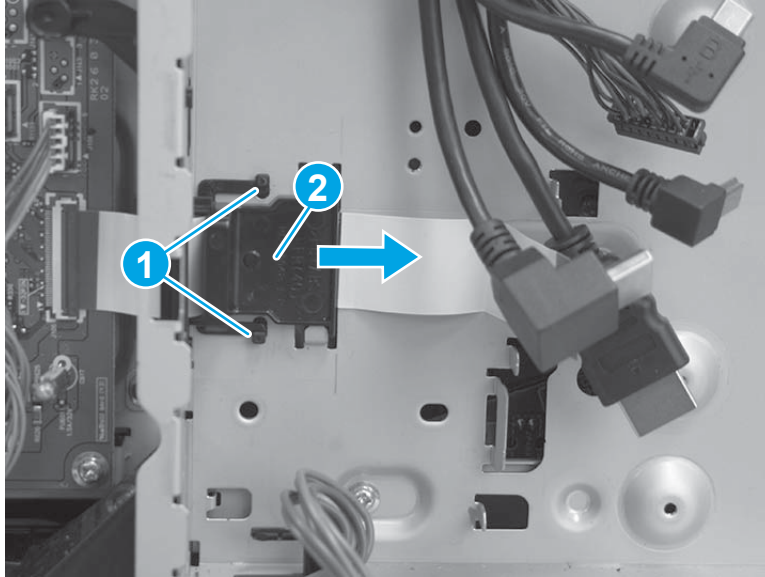

3. Remove two screws (callout 1), and then slide the low-voltage power supply (LVPS) cover to the right to remove it.

Figure 1-2245 Remove the LVPS cover

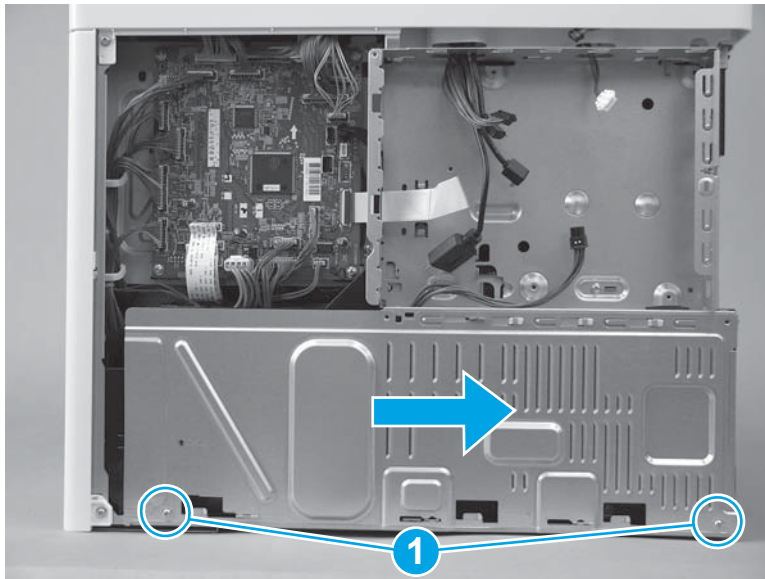

4. Pass two wire harnesses and one flat cable (callout 1) through the opening in the formatter case, and then release one wire harness from the retainer (callout 2).

⚠ CAUTION: The flat cable might be attached to the formatter case with double-sided tape. Make sure that this tape is released, so that the flat cable is not damaged when the formatter case is removed.

Figure 1-2246 Release wire harnesses and flat cable

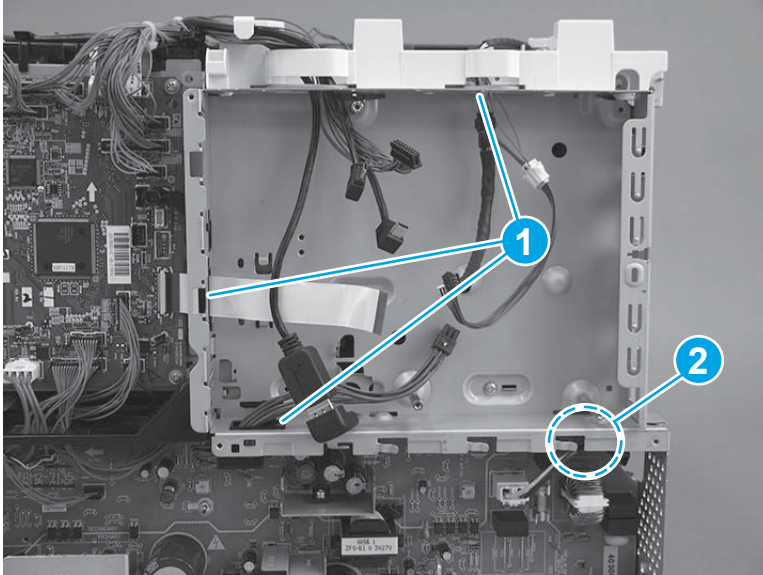

5. Remove six screws (callout 1).

Figure 1-2247 Remove six screws

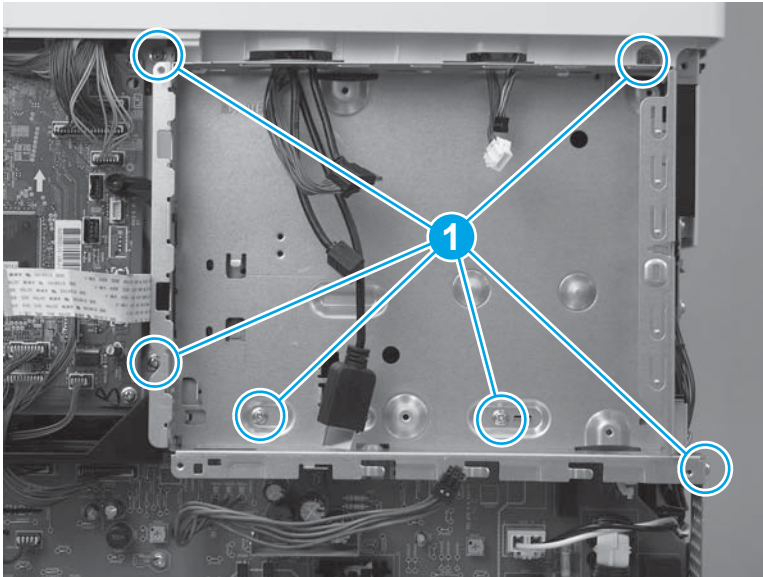

6. Rotate the bottom of the formatter case away from the printer (callout 1), and then pull it down (callout 2) to release it.

Figure 1-2248 Release the formatter case

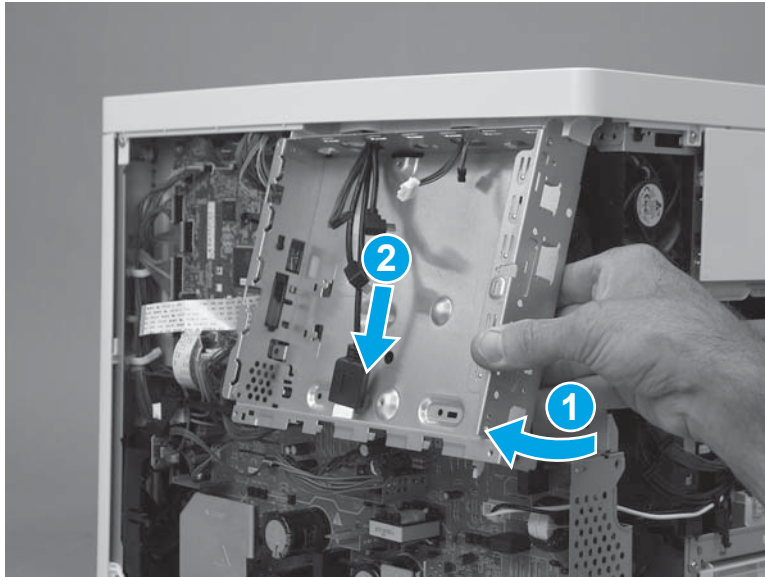

7. Pass the wire harnesses through the opening in the formatter case to remove it.

 **IMPORTANT:** If the formatter case is removed so that it can be replaced, make sure to transfer the memory PCA (island of data) and plastic bracket (callout 1) to the replacement case.

Figure 1-2249 Remove the formatter case



Step 13: Remove the low-voltage power supply (LVPS)

 **CAUTION:**  ESD-sensitive part.

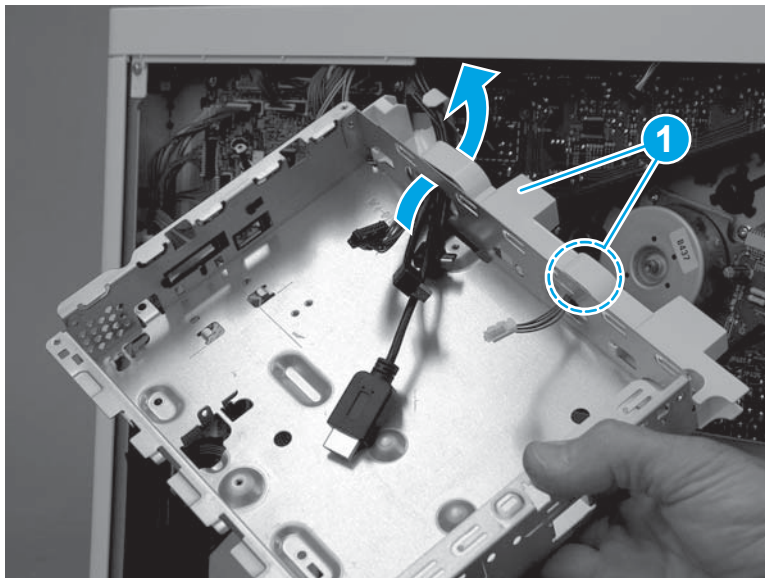
1. Disconnect one wire harness (callout 1), and then pass the wire harness through the opening (callout 2) in the chassis.

Figure 1-2250 Disconnect one wire harness

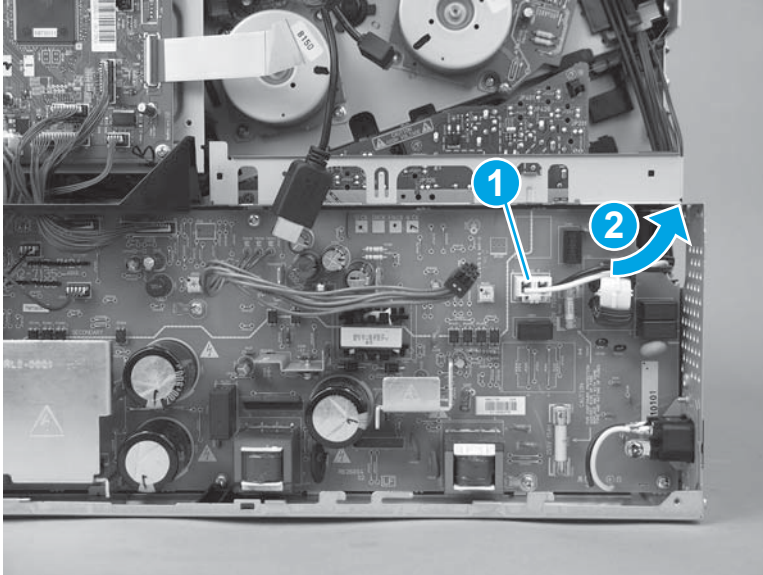

2. Disconnect three connectors on the DC controller (callout 1), and then disconnect four connectors (callout 2) on the LVPS.

Figure 1-2251 Disconnect seven connectors

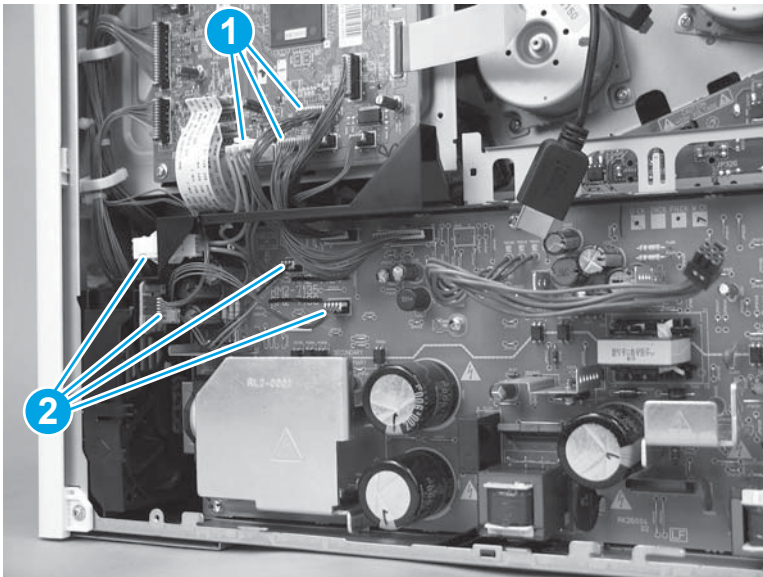

3. Pass the wire harnesses from the DC controller to the LVPS through the opening in the chassis (callout 1), and then release the wire harnesses from the retainer (callout 2).

Figure 1-2252 Pass the wire harnesses through the opening

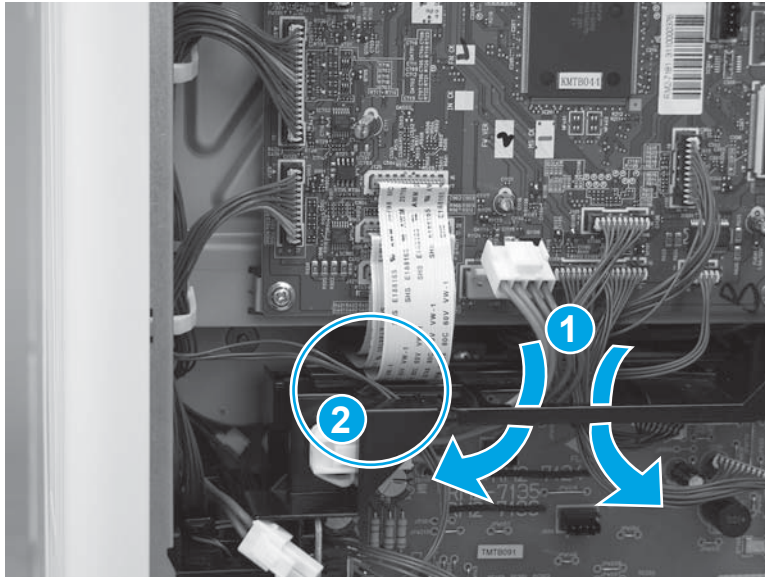

4. Remove three screws (callout 1).

Figure 1-2253 Remove three screws

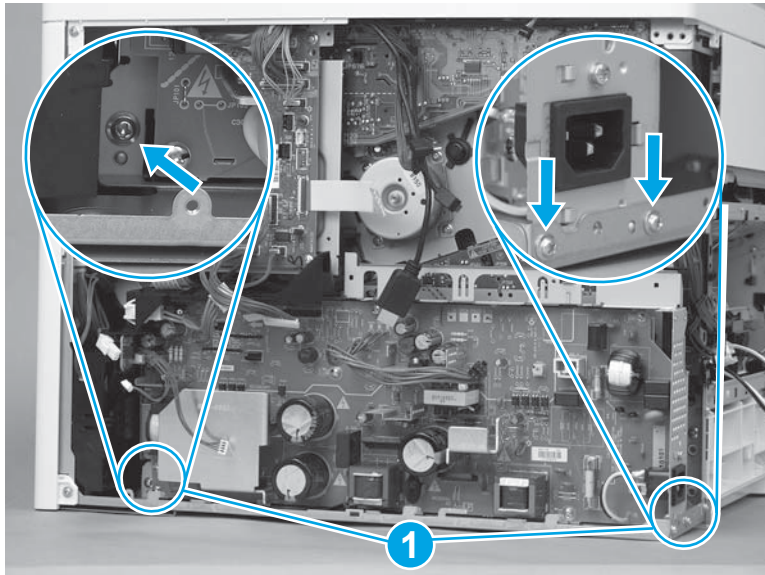

5. Rotate the top of the LVPS away from the printer (callout 1), and then slide it up and out (callout 2) of the printer to remove it.

Figure 1-2254 Remove the LVPS

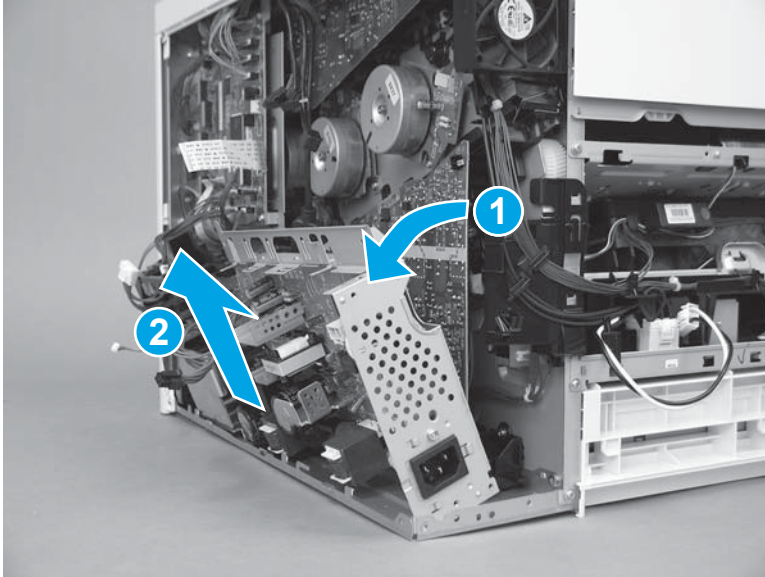

Step 14: Remove the high-voltage power supply D (HVPSD)

 **CAUTION:**  ESD-sensitive part.

1. Disconnect one flat cable (callout 1) on the DC controller.

Figure 1-2255 Disconnect one flat cable

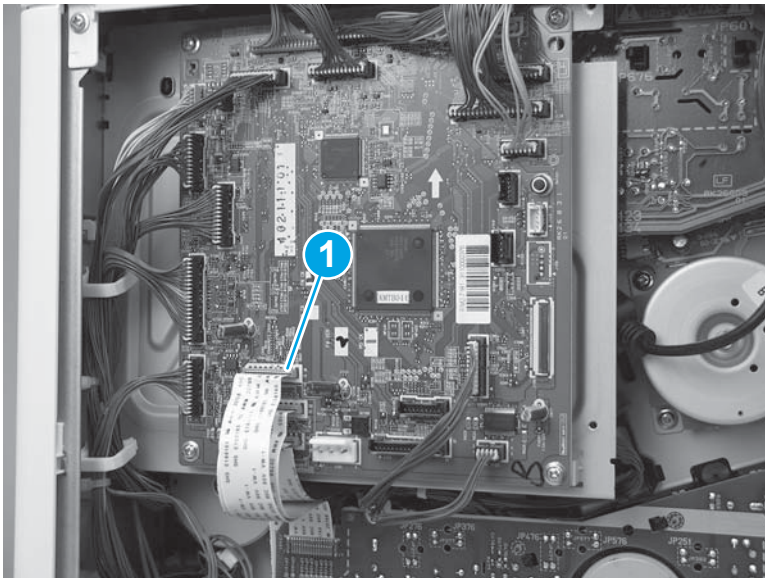

2. Remove two screws (callout 1), and then remove one self tapping screw (callout 2) on the HVPSD.

Figure 1-2256 Remove three screws

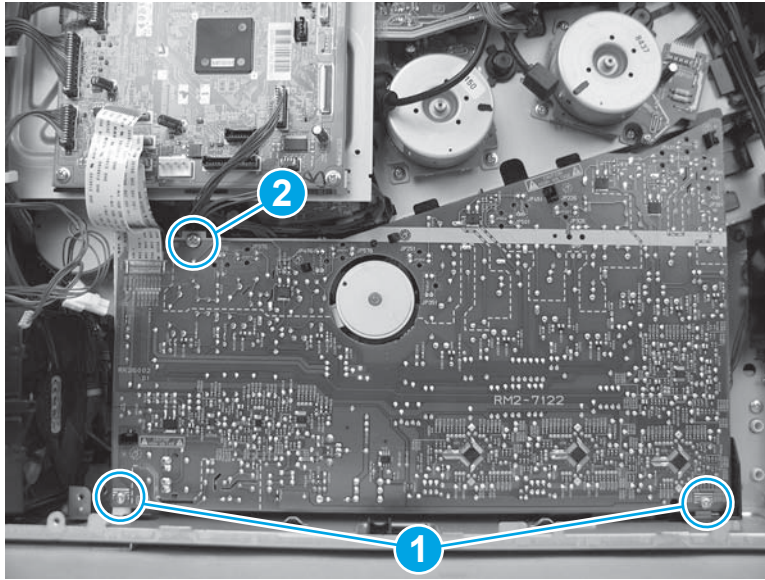

3. Release five tabs (callout 1), and then remove the HVPSD (callout 2).

Figure 1-2257 Remove the HVPSD

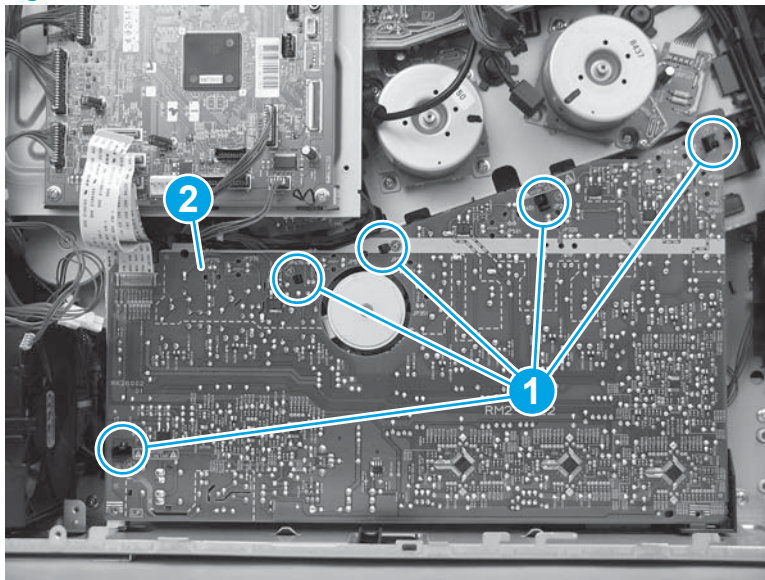

Step 15: Remove the laser/scanner assembly

1. Release one wire harness from the retainer (callout 1).

Figure 1-2258 Release one wire harness

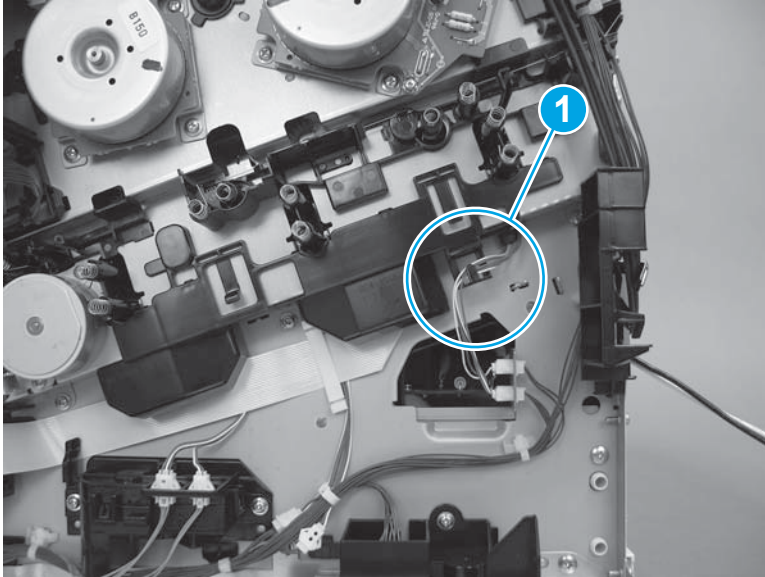

2. Release two tabs (callout 1), and then pull down on the guide (callout 2) to release it.

Figure 1-2259 Release two tabs

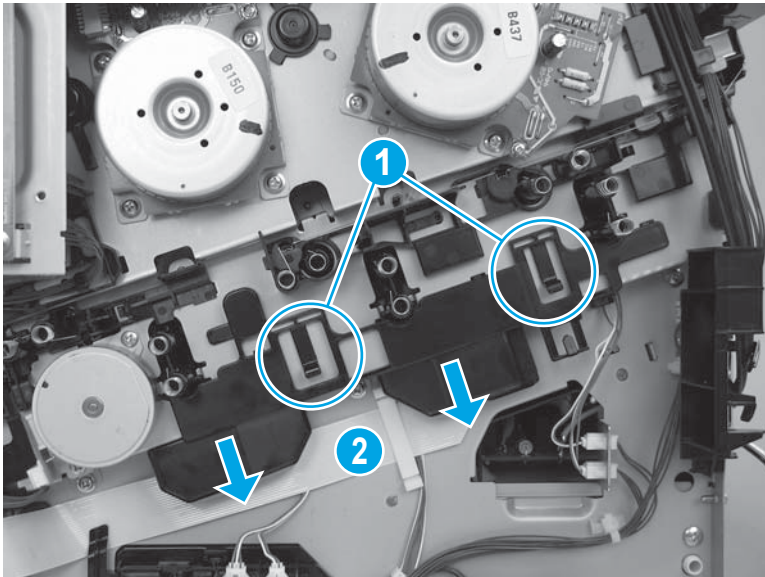

3. Remove the guide.

Figure 1-2260 Remove the guide

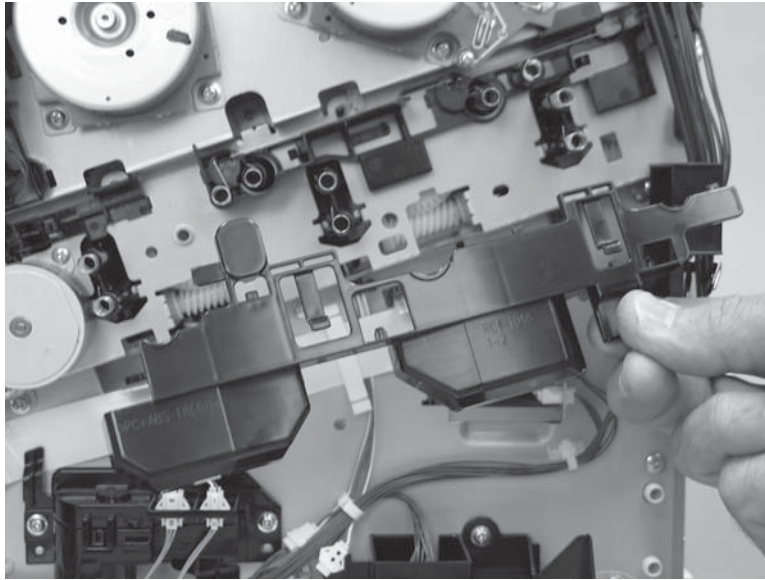

4. Disconnect two flat cables (callout 1).

Figure 1-2261 Disconnect two flat cables

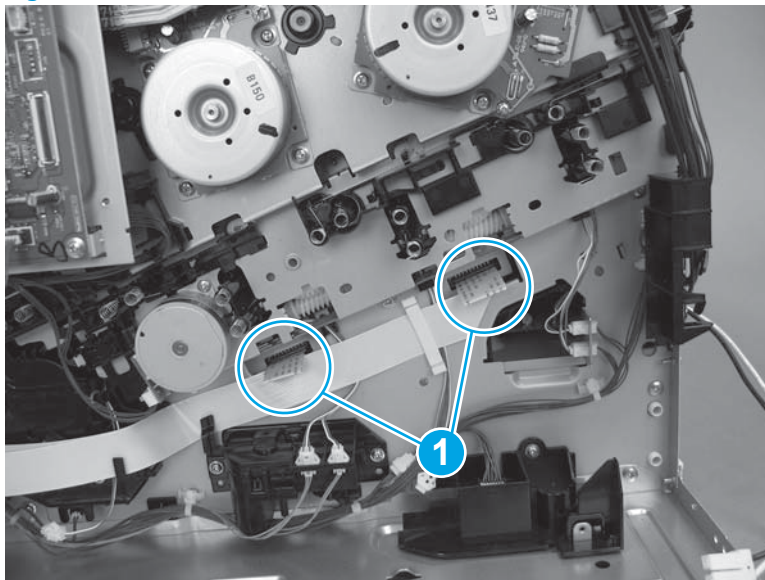

5. At the rear of the printer, disconnect two connectors (callout 1).

Figure 1-2262 Disconnect two connectors

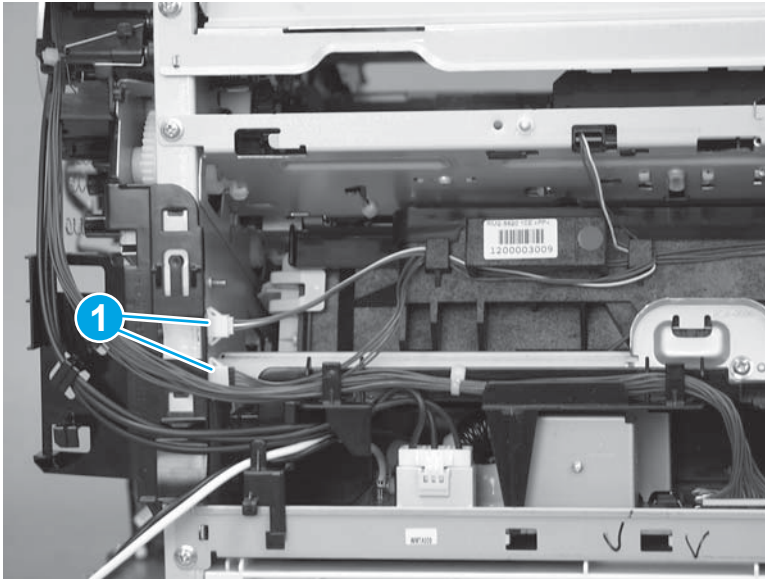

6. At the rear of the printer, remove one screw (callout 1), and then remove the sheet-metal plate (callout 2).

Figure 1-2263 Remove one screw and the plate

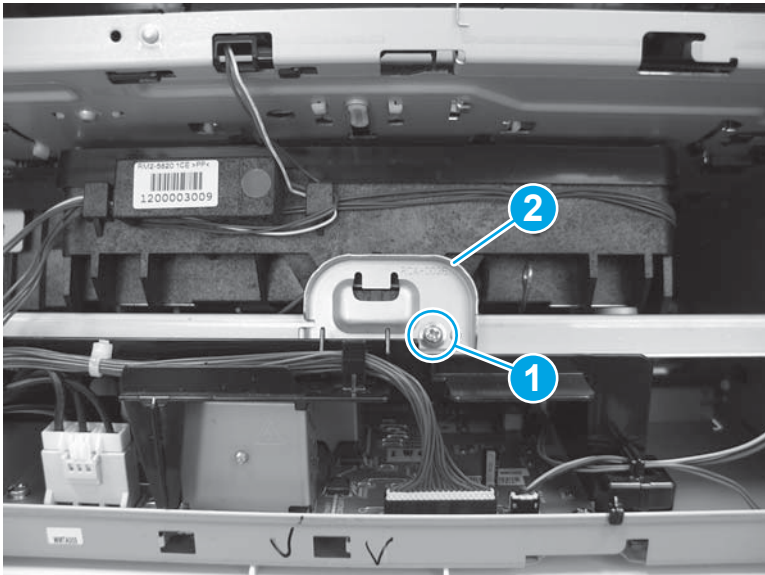

7. At the rear of the printer, push down on the spring (callout 1), and then lift it up (callout 2) to release it from the tab on the chassis.

Figure 1-2264 Release the spring

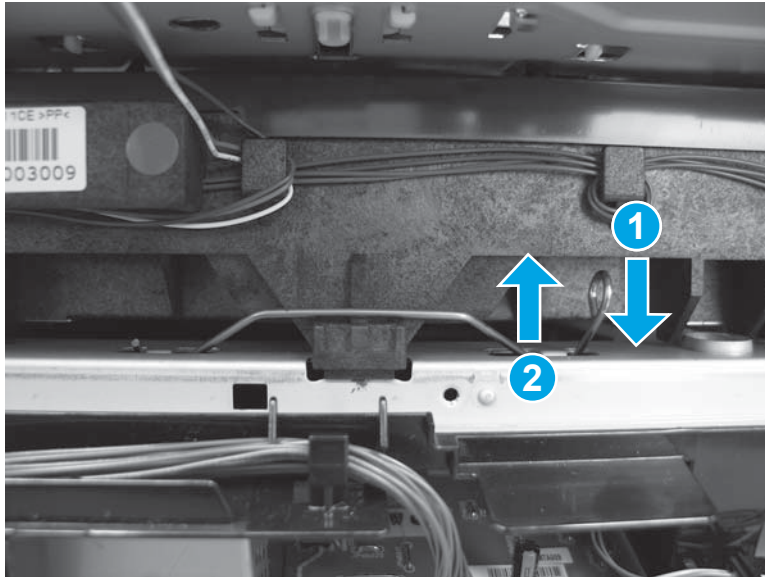

8. Remove the spring.

Figure 1-2265 Remove the spring

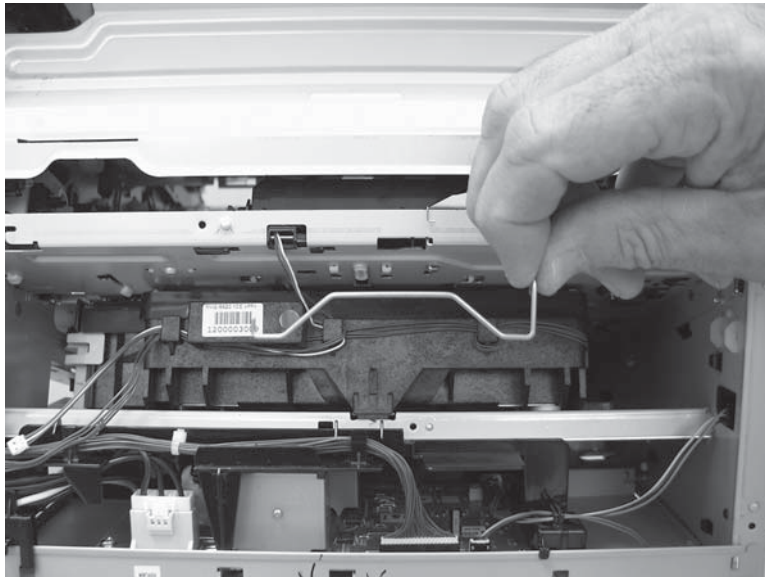

9. At the rear of the printer, release the wire harness from the retainers (callout 1).

Figure 1-2266 Release the wire harness

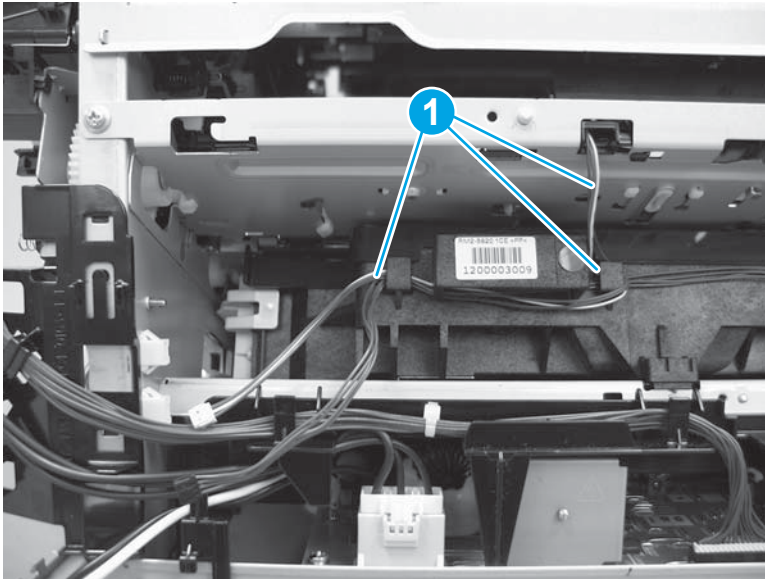

10. Pull the laser/scanner assembly straight out of the printer to remove it.

CAUTION: To avoid damaging the glass cleaners, make sure that the front door is open before removing the laser/scanner assembly.

Figure 1-2267 Remove the laser/scanner assembly

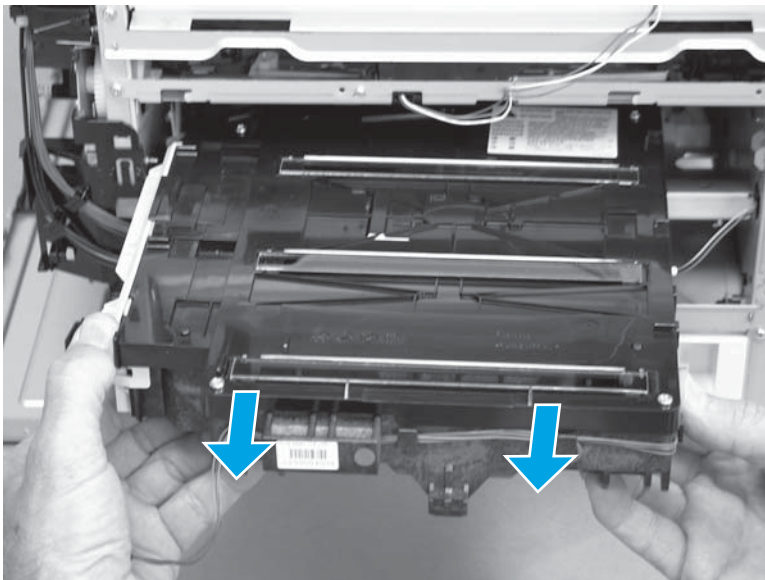

Step 16: Unpack the replacement assembly

Unpack the replacement assembly from the packaging.

For complete information on HP's recycling programs, go to [Product return and recycling](#).

NOTE: HP recommends responsible disposal of the defective assembly.

Figure 1-2268 Recycle and unpack

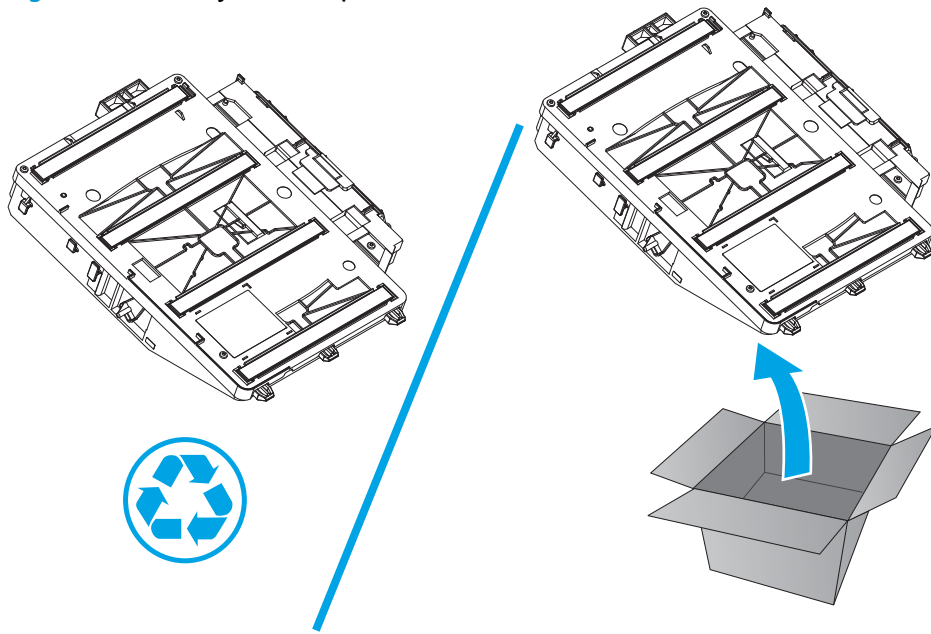

Step 17: Install the laser/scanner assembly

1. Handle the replacement laser/scanner assembly by the edges. Do not touch the two glass windows. Skin oils on the windows can cause image quality problems.

Figure 1-2269 Handle the laser/scanner assembly carefully

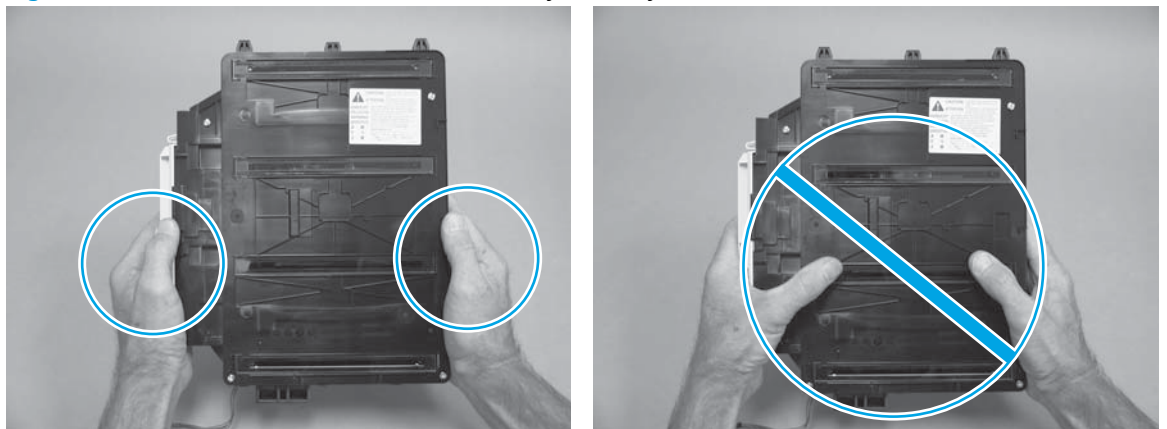

2. Slide the laser/scanner assembly straight into the printer to install it.

⚠ CAUTION: To avoid damaging the glass cleaners, make sure that the front door is open before installing the laser/scanner assembly.

Figure 1-2270 Install the laser/scanner assembly

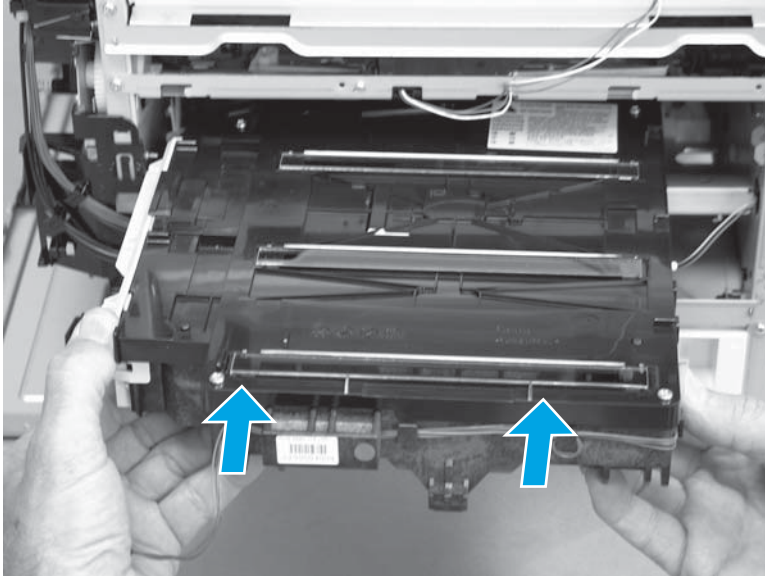

3. Hook the spring under the tab on the chassis (callout 1), and then push it down and under the second tab (callout 2) to install it.

Figure 1-2271 Release the spring

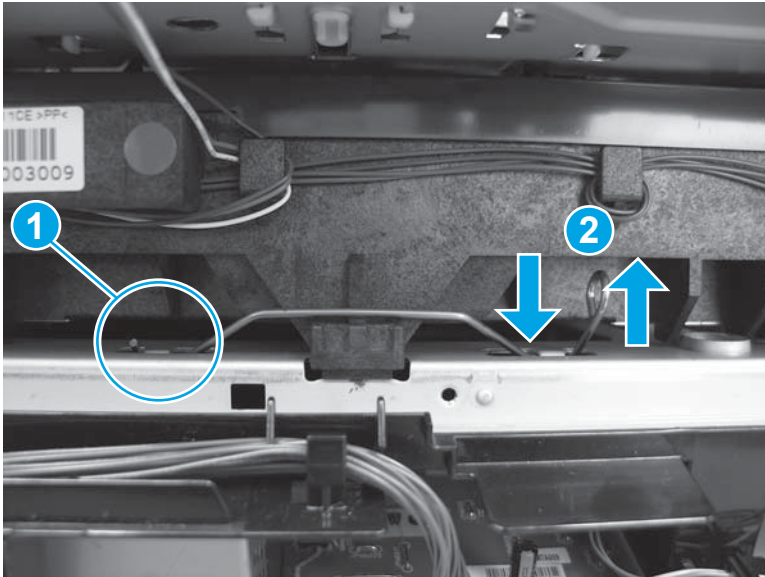

4. Position the sheet-metal plate (callout 1) on the printer, and then install one screw (callout 2).

Figure 1-2272 Install the plate and one screw

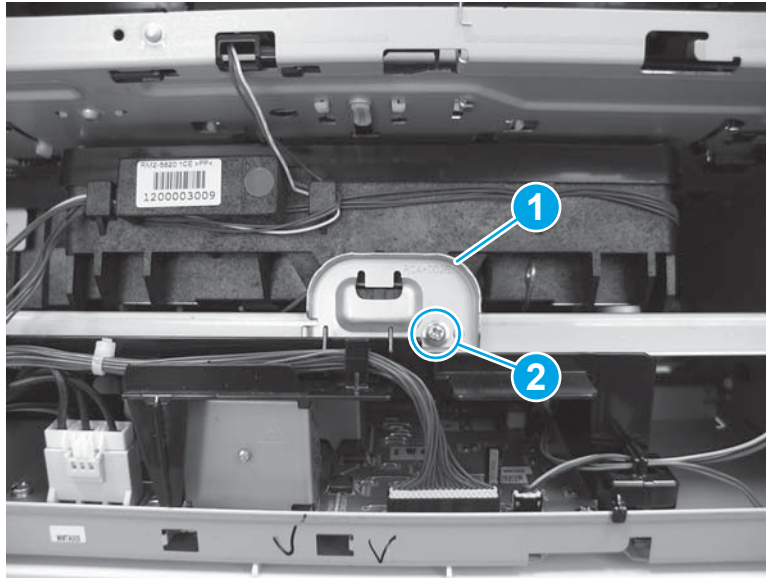

5. Place the wire harness in the retainers (callout 1).

Figure 1-2273 Place the wire harness in the retainers

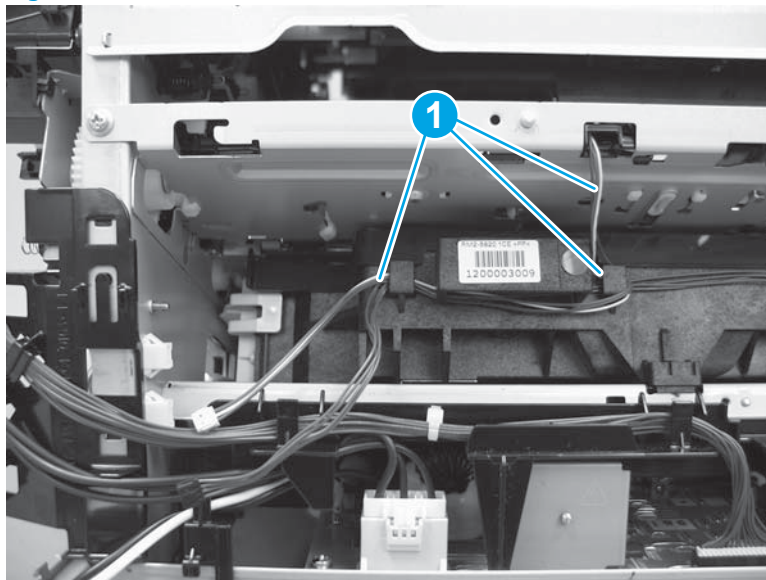

6. Connect two connectors (callout 1).

Figure 1-2274 Connect two connectors

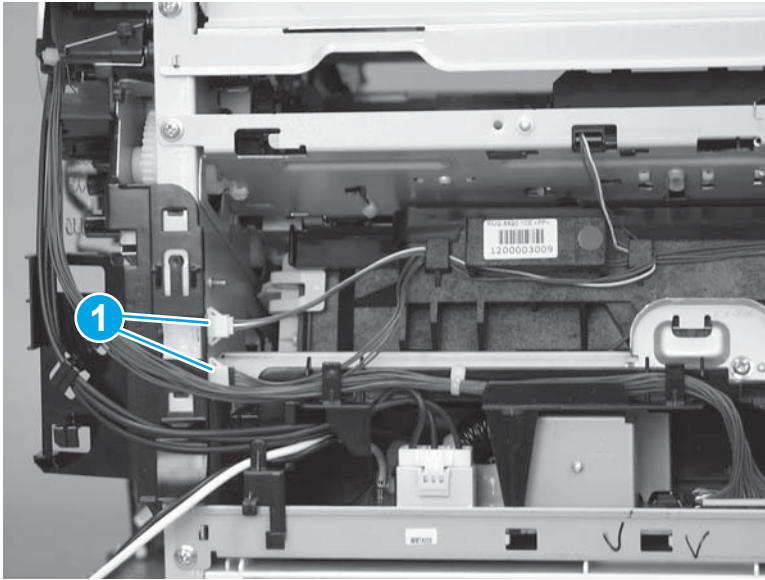

7. Connect two flat cables (callout 1).

Figure 1-2275 Connect two flat cables

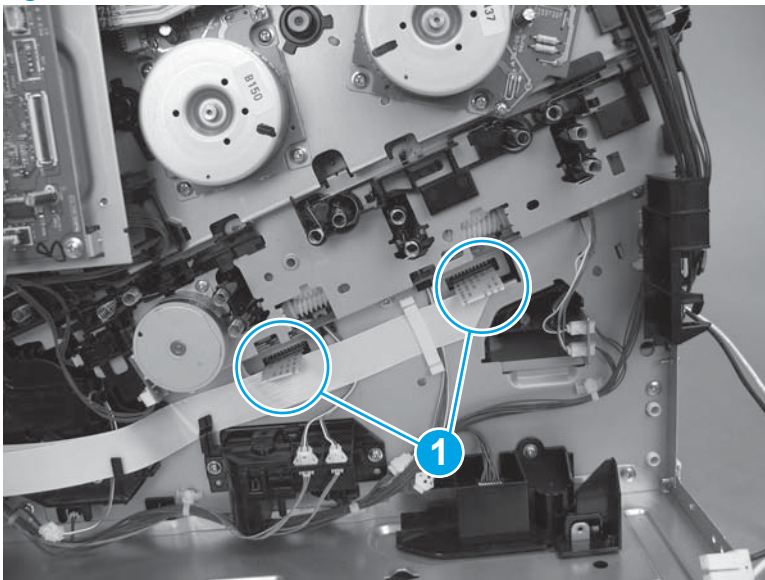

8. Position the guide on the printer, and then slide it up to engage the two tabs (callout 1) and install it.

Figure 1-2276 Install the guide

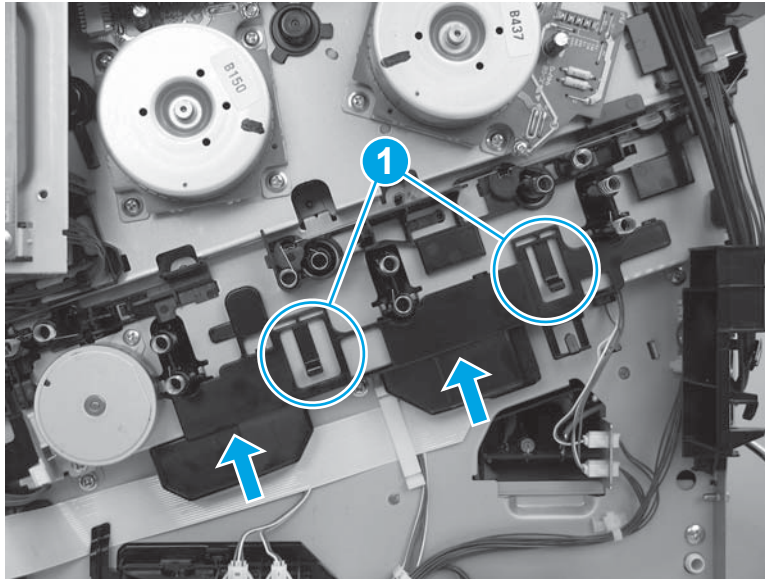

9. Place one wire harness in the retainer (callout 1).

Figure 1-2277 Place one wire harness in the retainer

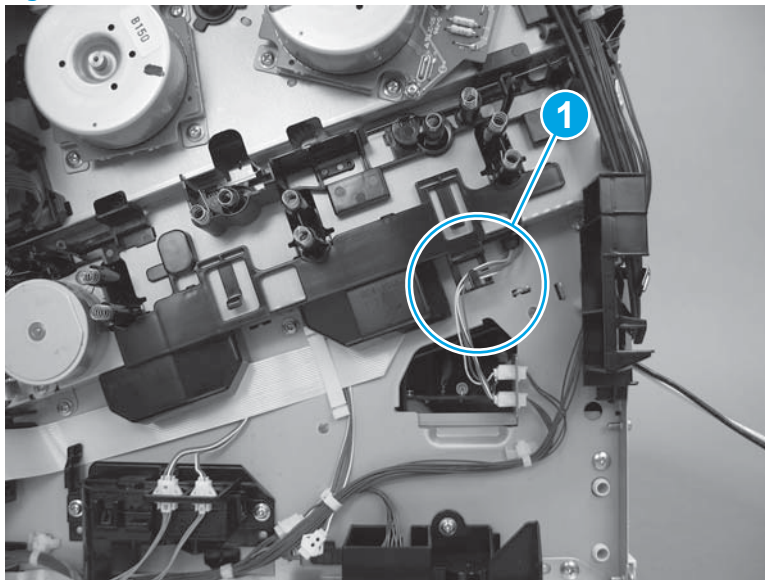

Step 18: Install the HVPSD

 **CAUTION:**  ESD-sensitive part.

1. Position the bottom right corner of the HVPSD (callout 1) behind the black tab, and then rotate it up and onto the printer (callout 2).

Figure 1-2278 Install the HVPSD

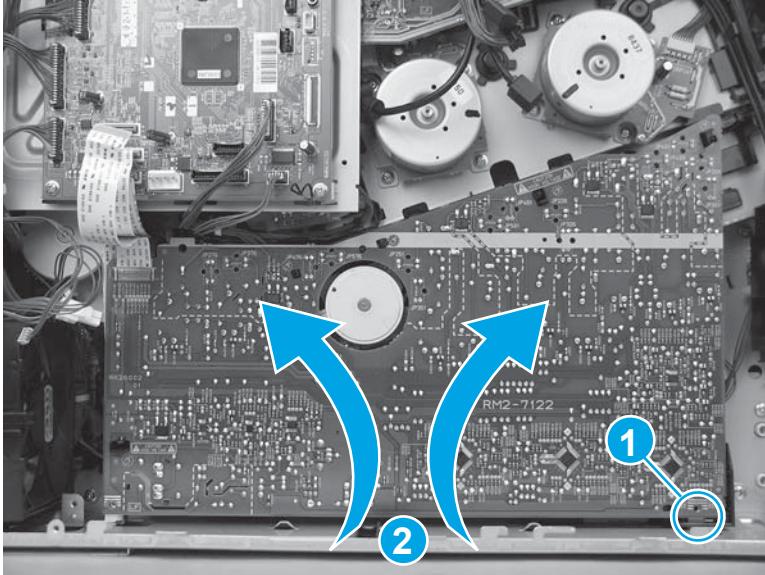

2. Press it onto five tabs (callout 2).

 **IMPORTANT:** Make sure that all five tabs snap into place.

Figure 1-2279 Press the tabs



3. Install two screws (callout 1), and then install one self tapping screw (callout 2) on the HVPSD.

Figure 1-2280 Install three screws

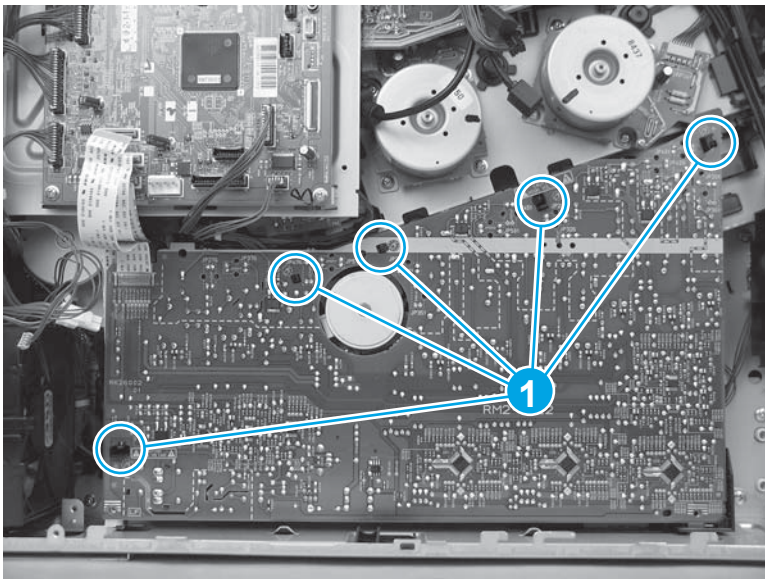
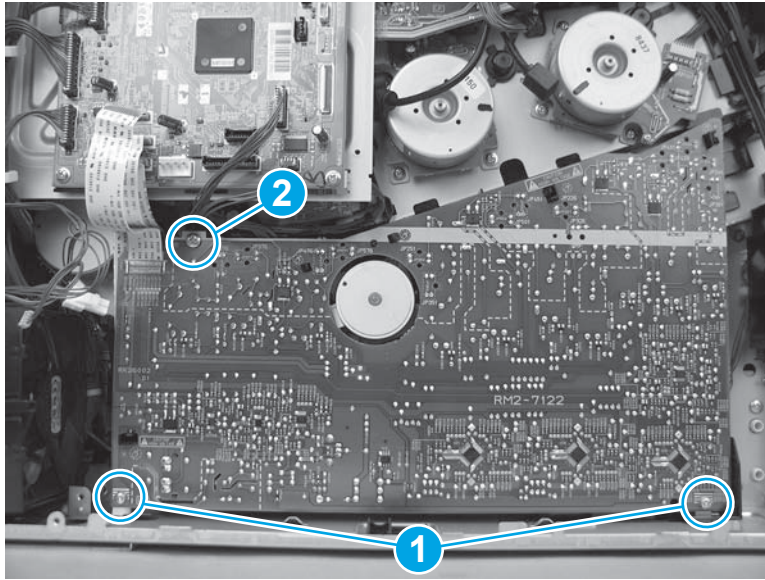

4. Connect one flat cable (callout 1) on the DC controller.

Figure 1-2281 Connect one flat cable

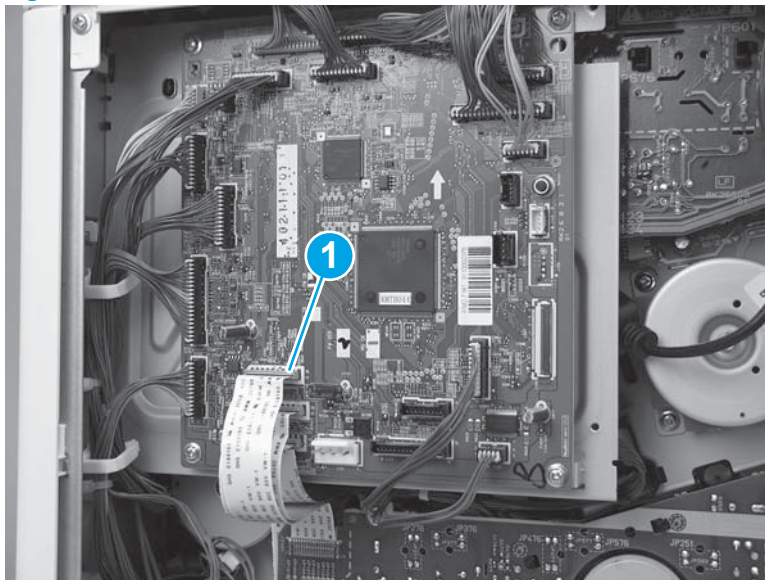

Step 19: Install the LVPS

CAUTION:  ESD-sensitive part.

1. Position the bottom of the LVPS in the printer (callout 1) at a slight angle, and then rotate the top of it into the printer (callout 2) to install it.

Figure 1-2282 Install the LVPS

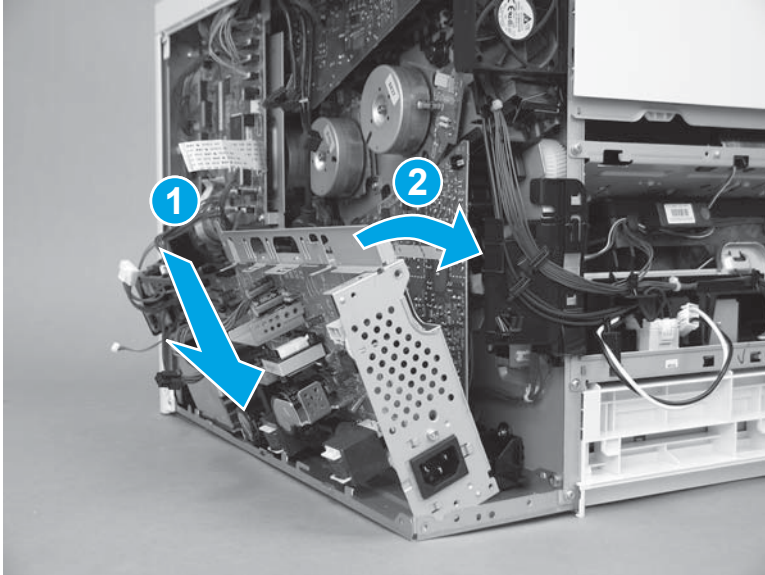

2. Install three screws (callout 1).

Figure 1-2283 Install three screws

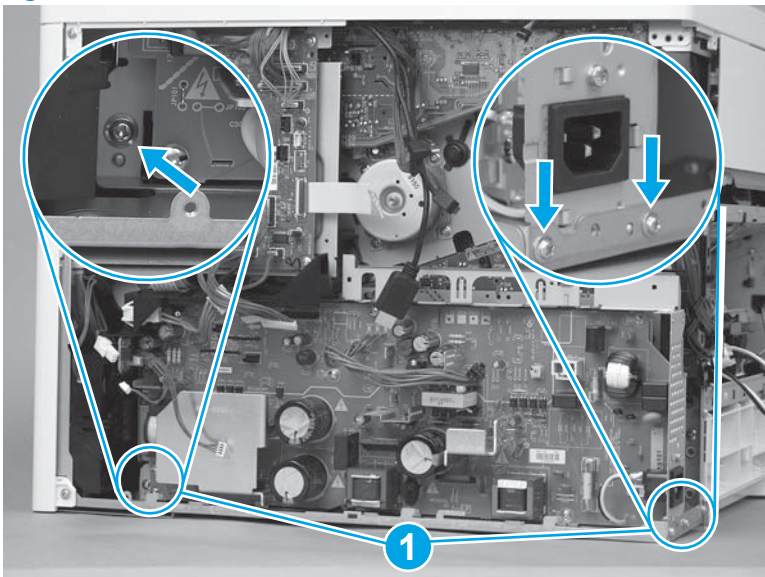

3. Pass the wire harnesses from the DC controller to the LVPS through the opening in the chassis (callout 1), and then install the wire harnesses in the retainer (callout 2).

Figure 1-2284 Pass the wire harnesses through the opening

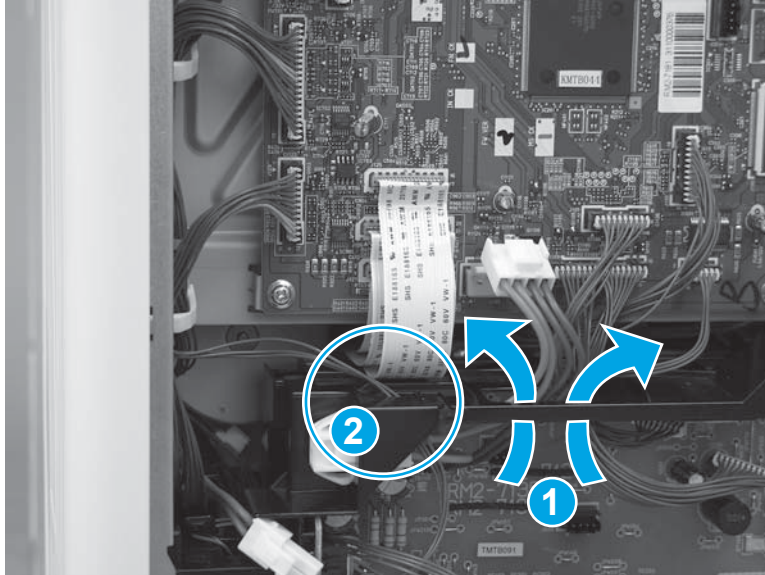

4. Connect three connectors on the DC controller (callout 1), and then connect four connectors (callout 2) on the LVPS.

Figure 1-2285 Connect seven connectors

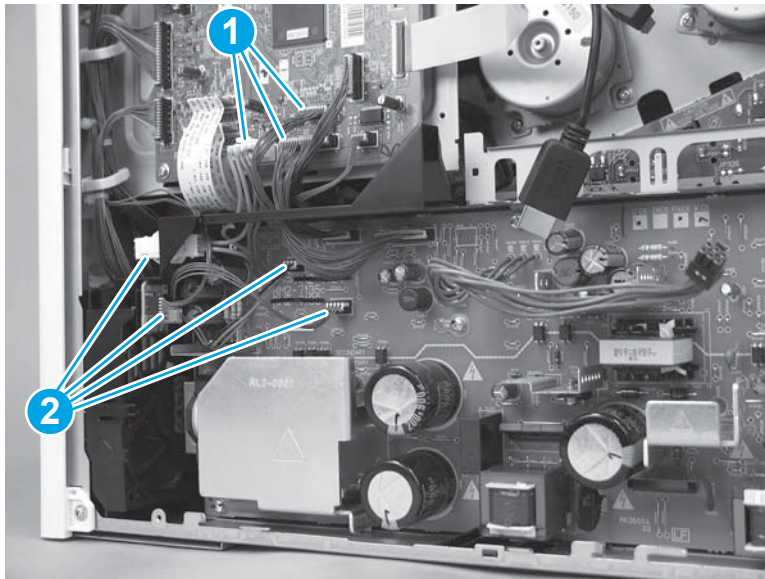

5. Pass the wire harness through the opening (callout 1) in the chassis, and then connect one wire harness (callout 2).

Figure 1-2286 Connect one wire harness

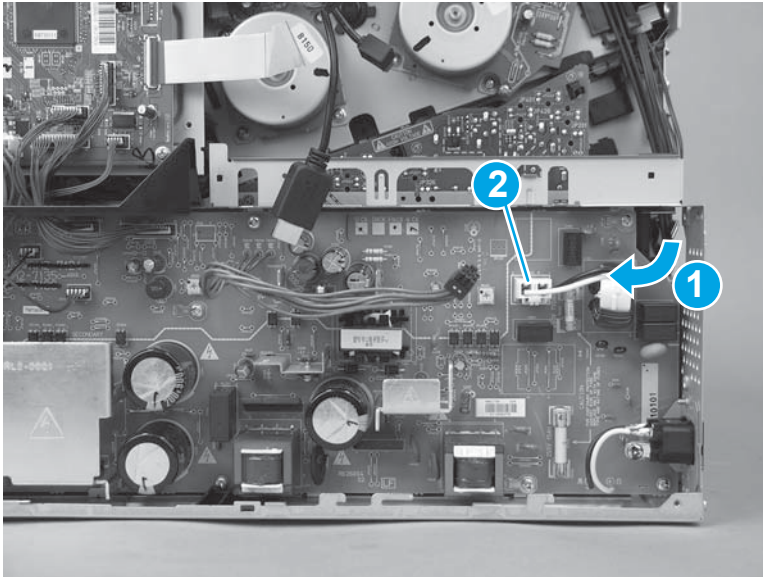

Step 20: Install the formatter case

1. Pass the wire harnesses through the opening in the formatter case.

Figure 1-2287 Pass the wire harnesses through the opening

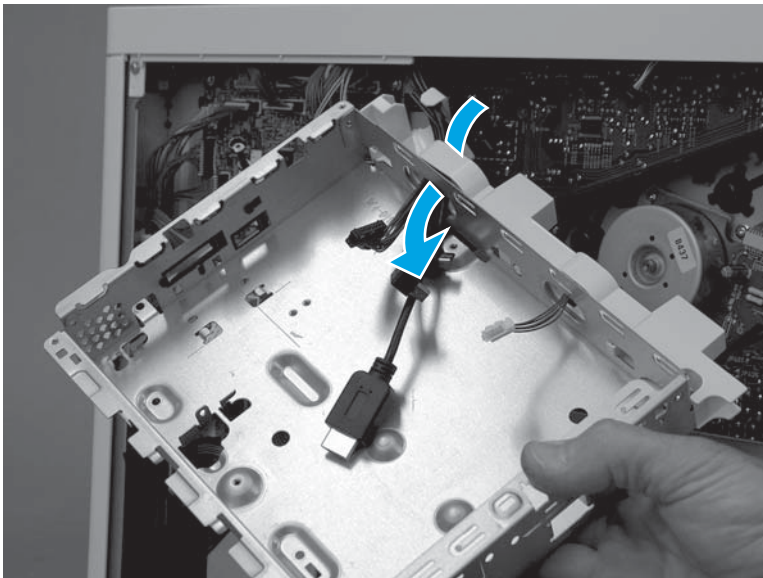

2. Position the top of the formatter case on the printer (callout 1), and then rotate the bottom of the case (callout 2) into the printer.

Figure 1-2288 Install the formatter case

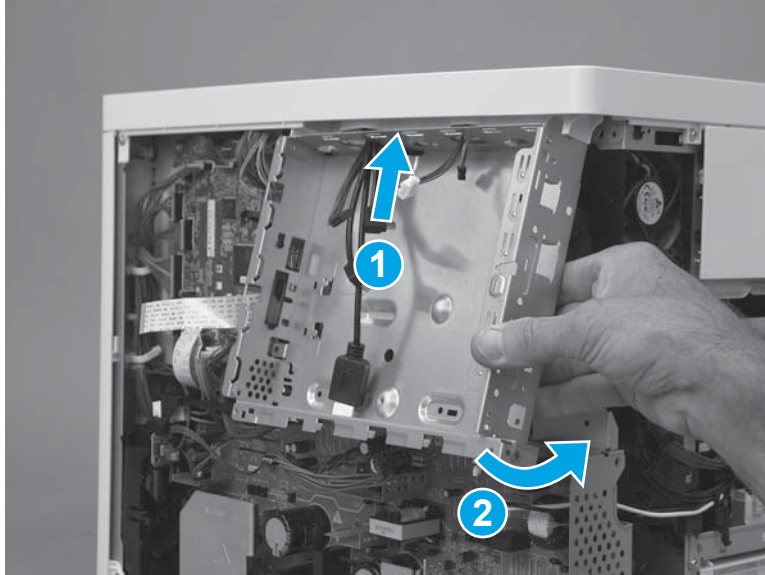

3. Install six screws (callout 1).

Figure 1-2289 Install six screws

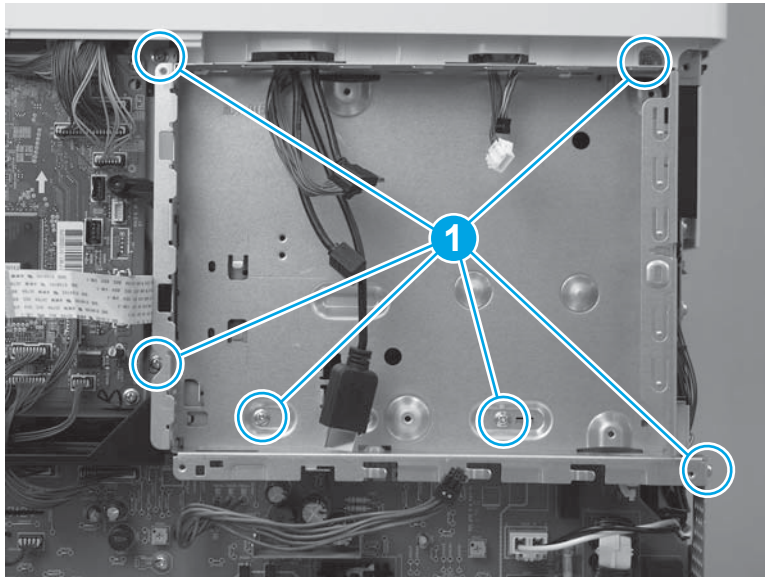

4. Pass two wire harnesses and one flat cable (callout 1) through the opening in the formatter case, and then install one wire harness in the retainer (callout 2).

 **IMPORTANT:** Make sure that the flat cable is securely fastened to the DC controller, and was not dislodged when the formatter case was removed.

Figure 1-2290 Install wire harnesses and flat cable



5. Position the LVPS cover on the printer, slide the cover to the left to install it, and then install two screws (callout 1).

Figure 1-2291 Install the LVPS cover

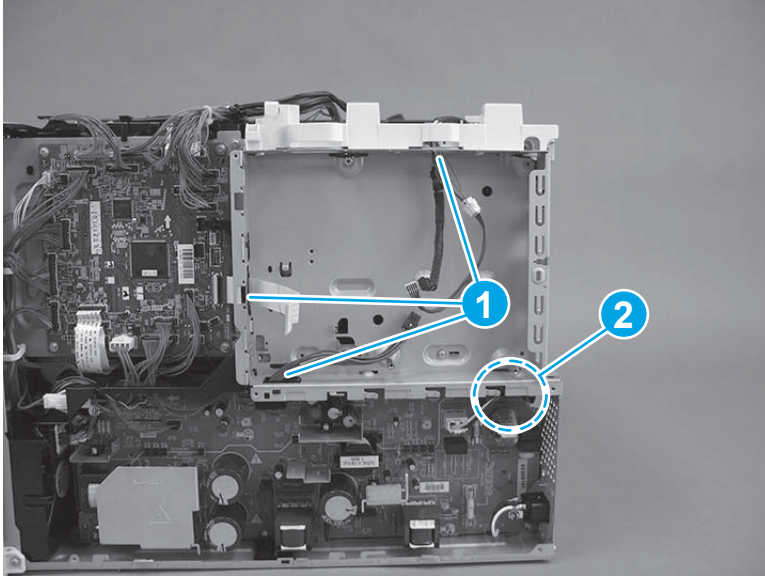
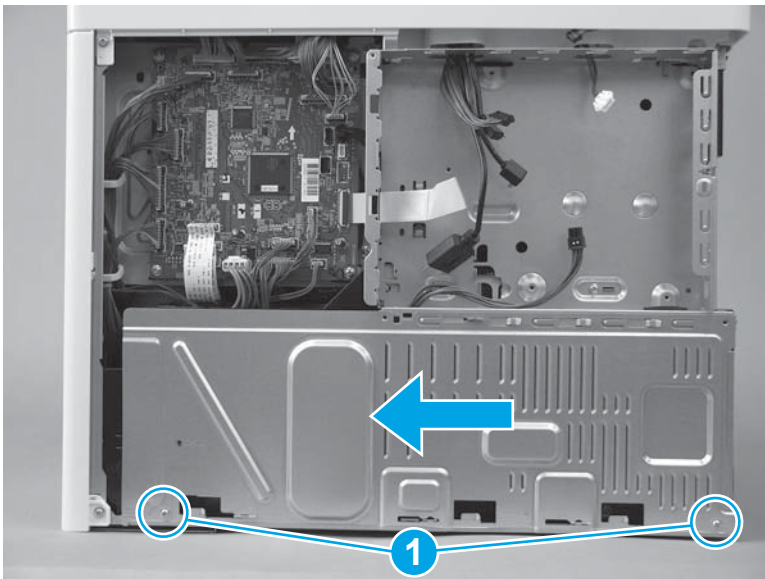

6. If no tape is affixed to the back of the flat cable, skip this step. If double-sided tape is affixed to the back of the flat cable, align the line (callout 1) on the cable with the edge (callout 2) of the opening in the sheet metal. Press to attach the flat cable to the formatter case.

Figure 1-2292 Attach the flat cable

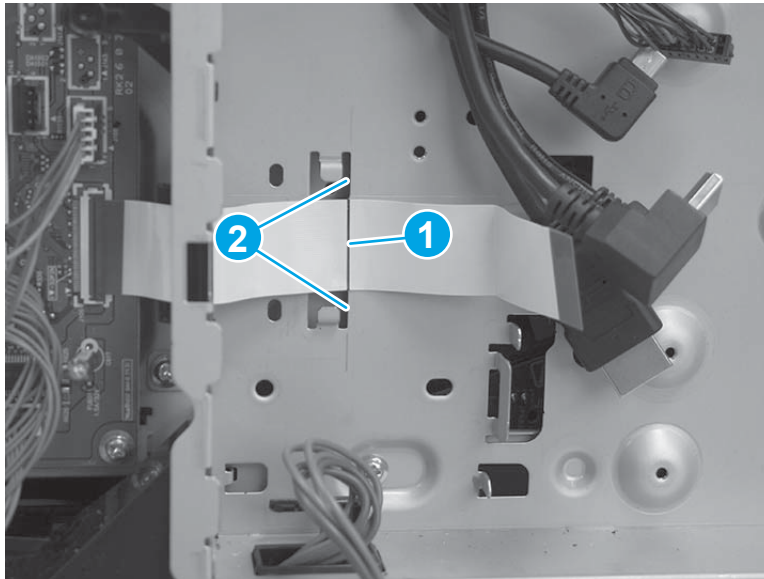

7. Position the bracket over the flat cable, and then slide the bracket to the left to install it. Make sure that the edges of the bracket fit under the sheet metal tabs (callout 1) on the formatter case and that the tabs (callout 2) snap into place.

Figure 1-2293 Position the bracket

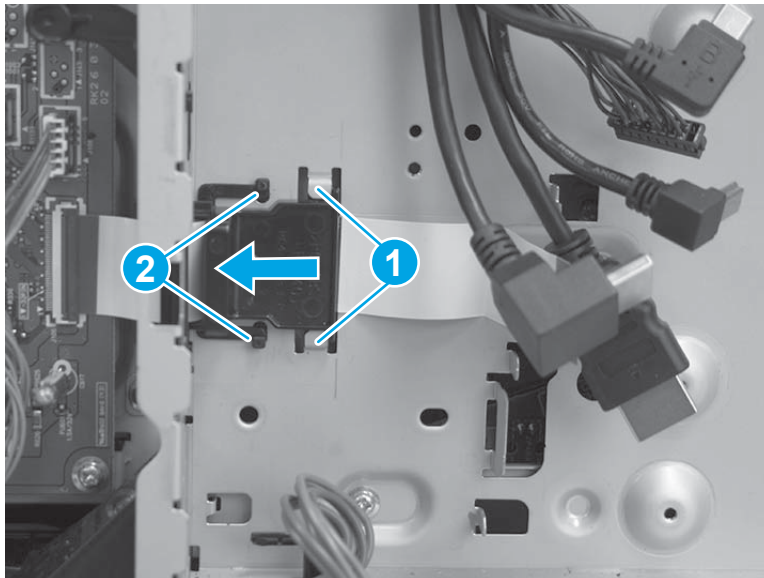

- 8. M577 only:** Pass the wire harness (callout 1) through the openings in the formatter case (callout 2), and then connect one connector (callout 3).

Figure 1-2294 Connect one connector

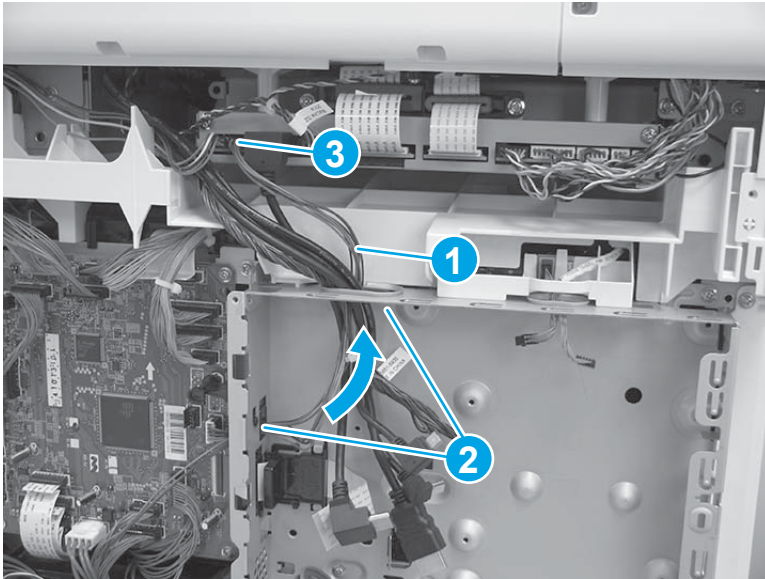

Step 21: Install the left cover

1. Position the cover on the printer.

 **NOTE:** Slightly offset the cover toward the rear of the printer.

Figure 1-2295 Install the cover

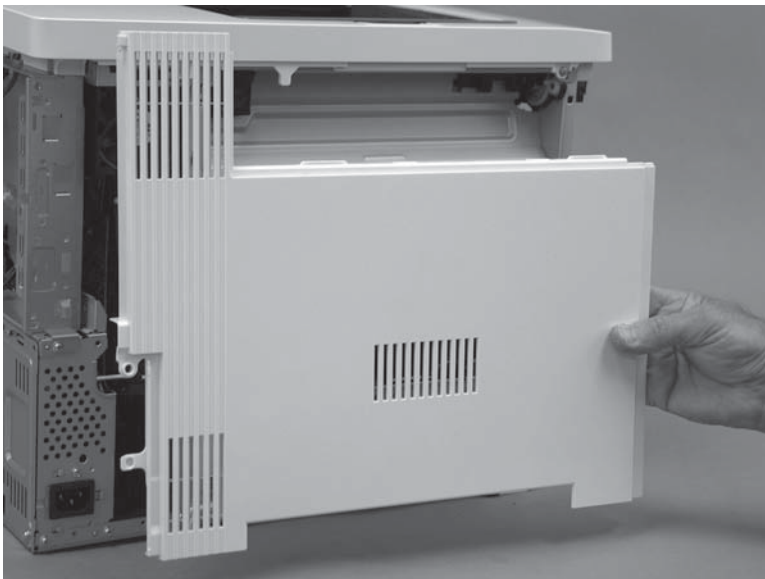

- Slide the cover (callout 1) toward the front of the printer to engage it. Make sure that the tab (callout 2) snaps into place.

 **NOTE:** Locate the alignment pin (callout 3) on the cover from the front door side of the printer, and then make sure that it is fully engaged in the slot in the chassis.

 **TIP:** While sliding the cover into place, push in on the center of the cover (callout 1) to make sure that the hooks on the back of the cover engage with the slots in the chassis.

Figure 1-2296 Engage the cover



- At the left side of the printer, install one screw (callout 1).

Figure 1-2297 Install one screw

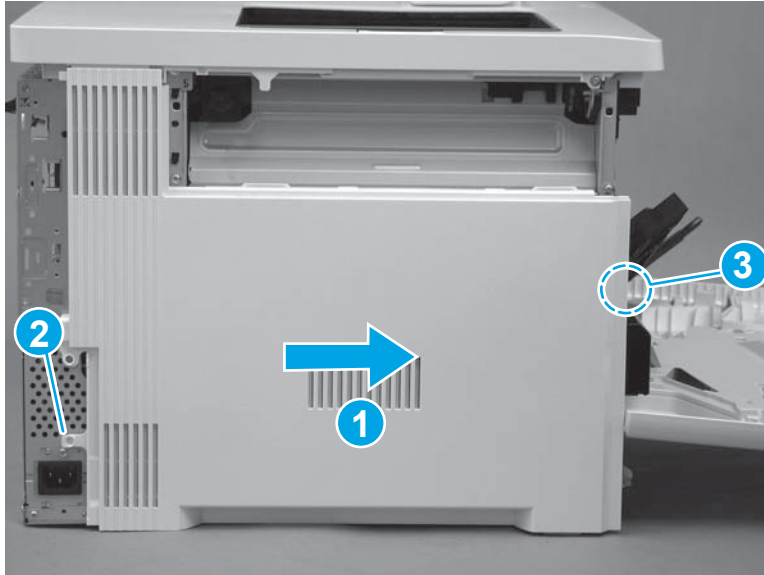

Step 22: Install the rear cover (M577)

 **NOTE:** This step is for the M577 models. For the M552 and M553 models, skip this step and go to [Step 24: Install the rear cover \(M552 and M553\) on page 1311](#).

1. Position the hooks (callout 1) on the cover in the slots (callout 2) in the printer.

Figure 1-2298 Position the hooks

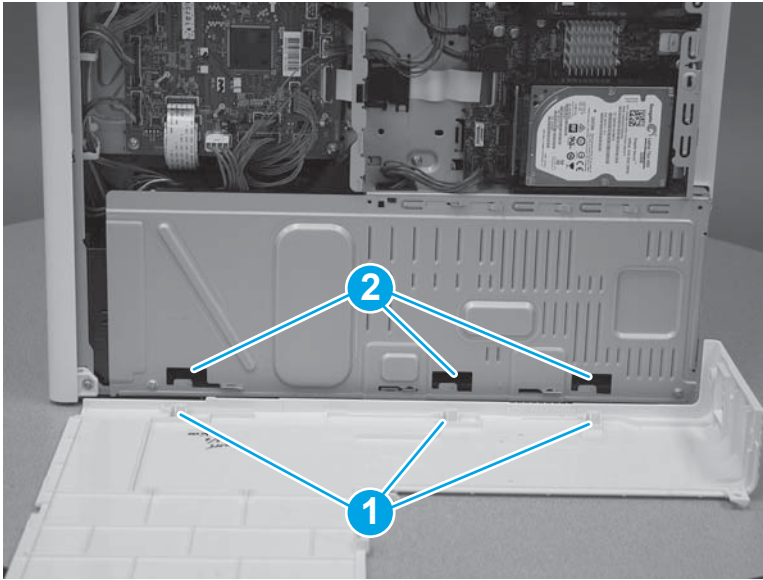

2. Position the back edge (callout 1) of the rear cover behind the edge (callout 2) of the right rear cover. Slide the cover to the left to install it.

Figure 1-2299 Install the cover

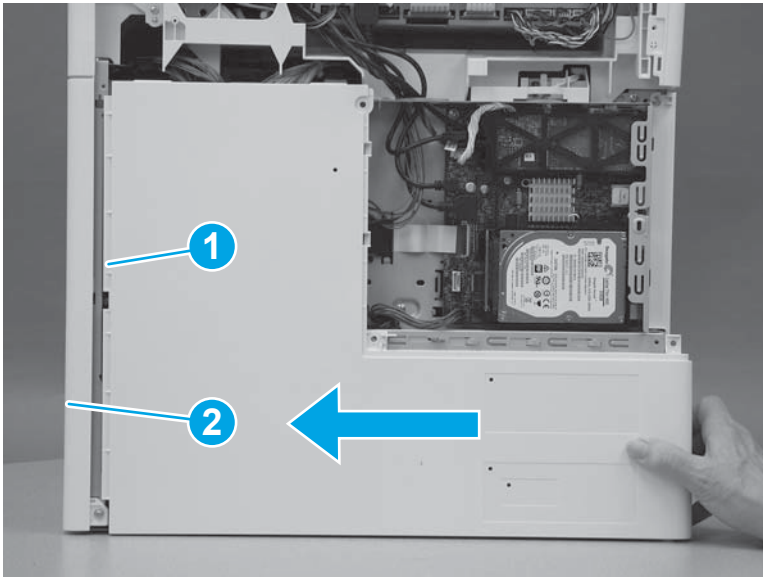

3. Install four screws (callout 1).

Figure 1-2300 Install four screws cover

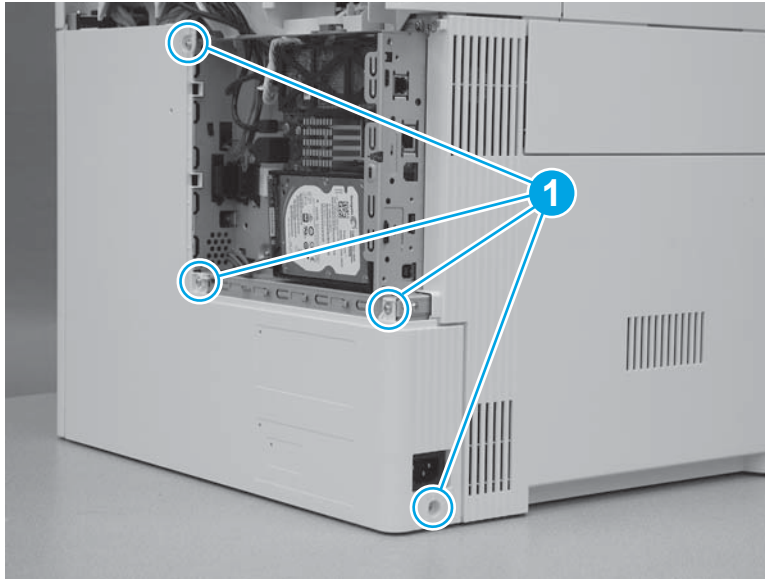

Step 23: Install the rear upper cover (M577)

 **NOTE:** This step is for the M577 models. For the M552 and M553 models, skip this step and go to [Step 24: Install the rear cover \(M552 and M553\) on page 1311](#).

1. Align the ridge (callout 1) on the lower edge of the rear upper cover in front of the tabs (callout 2) on the top edge of the rear cover.

Figure 1-2301 Align the cover

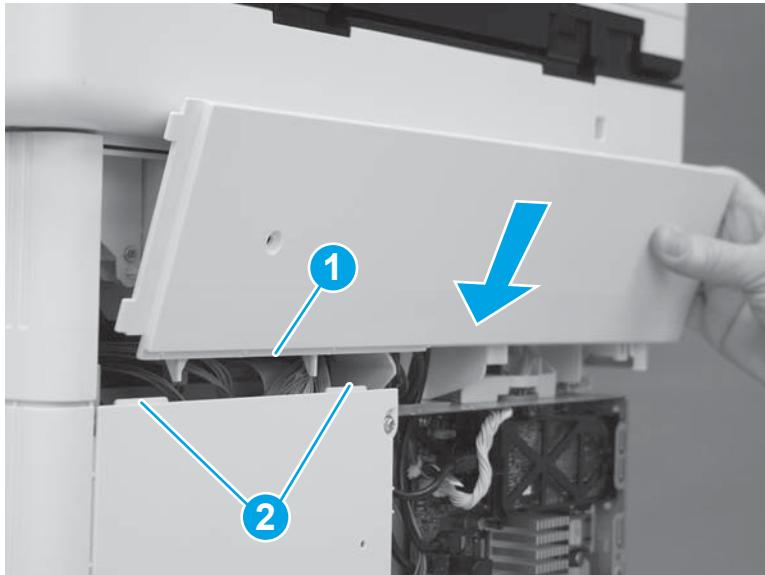

2. Rotate the top of the cover toward the printer.

Figure 1-2302 Rotate the top of the cover

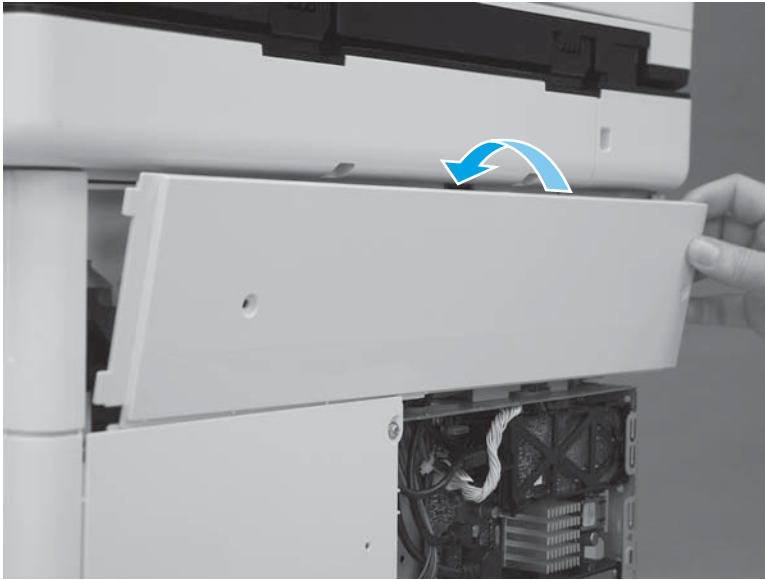

3. Slide the cover to the left (callout 1). Make sure that the tabs (callout 2) on the upper rear cover slide behind the edge (callout 3) of the right upper cover. Make sure that the cover is fully seated.

Figure 1-2303 Slide the cover

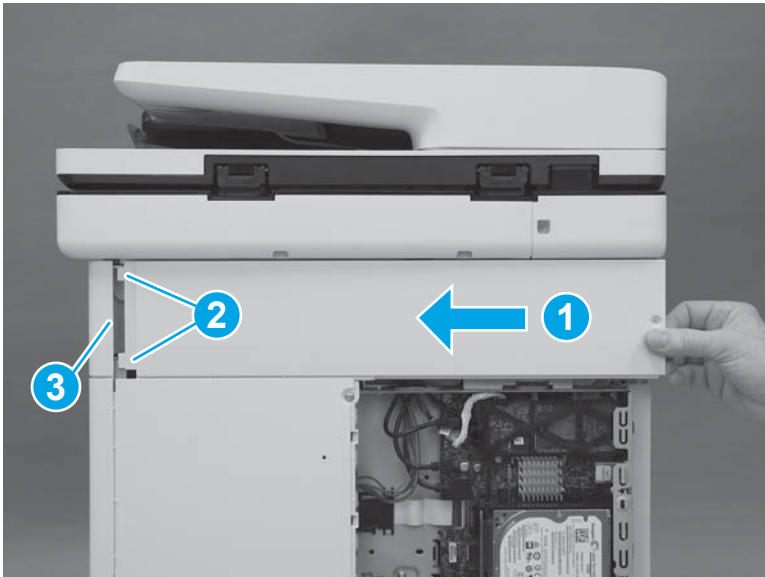

4. Install two screws (callout 1).

 **IMPORTANT:** These two screws are self-tapping screws for plastic. Rotate them counterclockwise to align them with the existing thread pattern, and then carefully turn them clockwise to tighten. Do not overtighten. This will prevent stripping the threads inside the screw holes.

Figure 1-2304 Install two screws



Step 24: Install the rear cover (M552 and M553)

 **NOTE:** This step is for the M552 and M553 models. For the M577 models, skip this step and go to [Step 25: Install the formatter \(M577\) on page 1312](#).

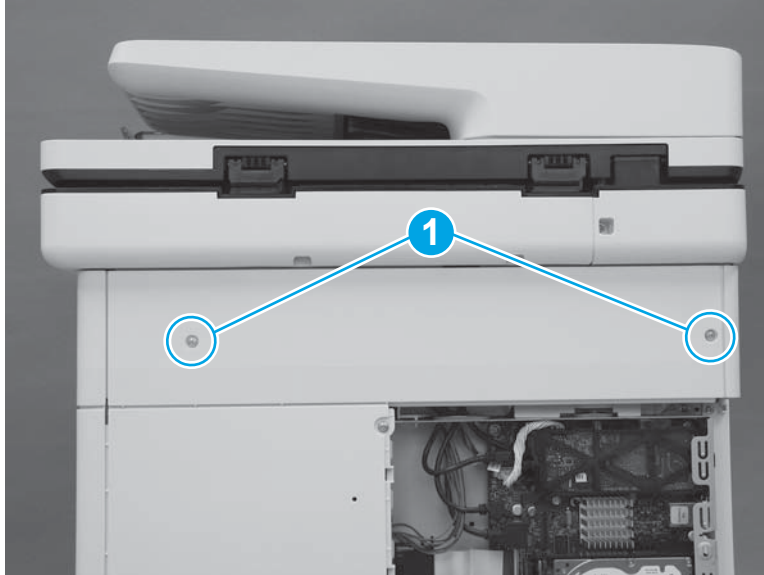
1. Position the top of the cover under the upper cover (callout 1), rotate the bottom of the cover onto the chassis (callout 2), and then slide the cover to the left (callout 3) to install it.

Figure 1-2305 Install the cover

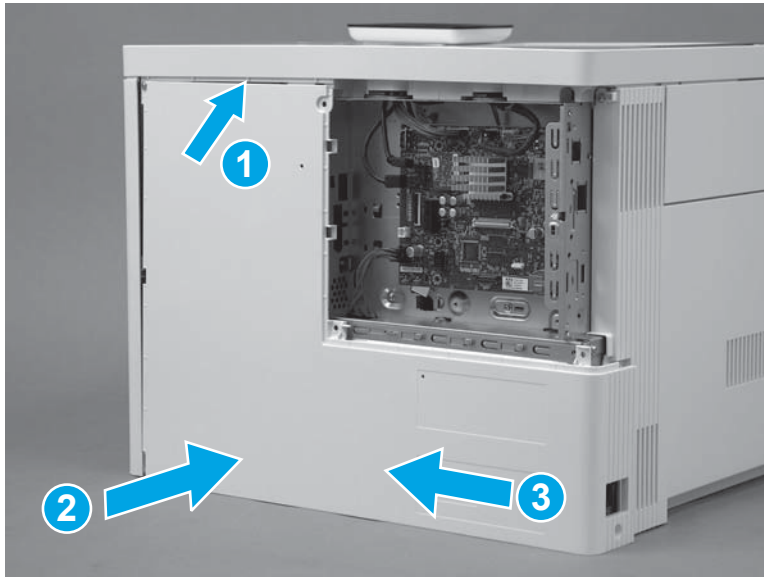

2. Install four screws (callout 1).

Figure 1-2306 Install four screws cover

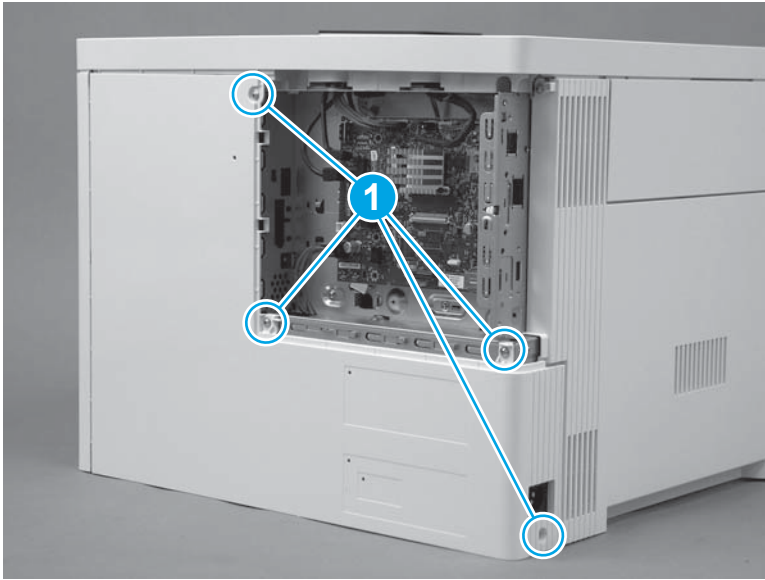

Step 25: Install the formatter (M577)



NOTE: This step is for the M577 models. For the M552 and M553 models, skip this step and to go [Step 28: Install the formatter \(M552 and M553\)](#) on page 1317.



CAUTION:  ESD-sensitive part.

1. Position the formatter in the printer. Make sure that the network port (callout 1) fits through the opening (callout 2) in the formatter case.

Figure 1-2307 Install the formatter

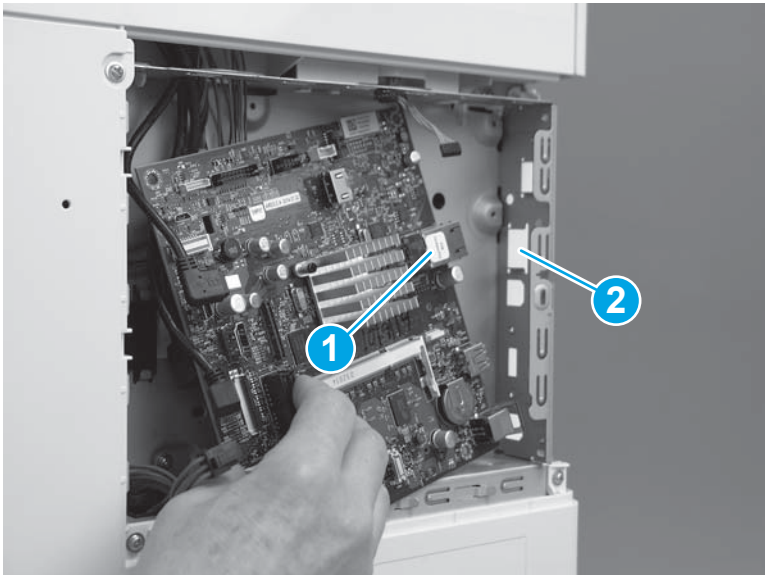

2. Install four screws (callout 1).

Figure 1-2308 Install four screws

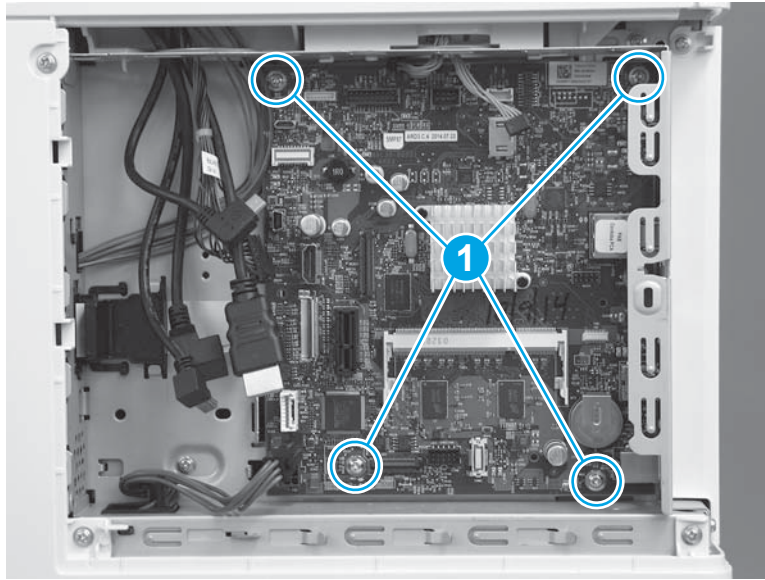

3. Connect all of the connectors on the formatter.

The following connectors are empty:

- All models: J1 (this connector is empty unless the optional DIMM is installed)
- All models: J3
- M577dn: J15 (this is the fax connector for the M577f/z/c models)
- All models: J21 (this connector is empty unless the optional internal USB ports component is installed)
- All models: J23
- All models: J24
- All models: J51
- All models: J57
- All models: J97
- All models: J98 (this connector is empty unless the optional trusted platform module (TPM) is installed)

 **IMPORTANT:** The flat-cable connector (callout 1) is a Zero Insertion Force (ZIF) connector that uses a hinged retainer to secure the flat cable. The hinged retainer must be opened to install the flat cable, and then closed after the cable is installed.

Figure 1-2309 Connect all connectors



Step 26: Install the fax PCA (M577c/f/z)

 **NOTE:** This step is for the M577c/f/z models. For the M577n model, skip this step and go to [Step 27: Install the HDD \(M577\) on page 1315](#).

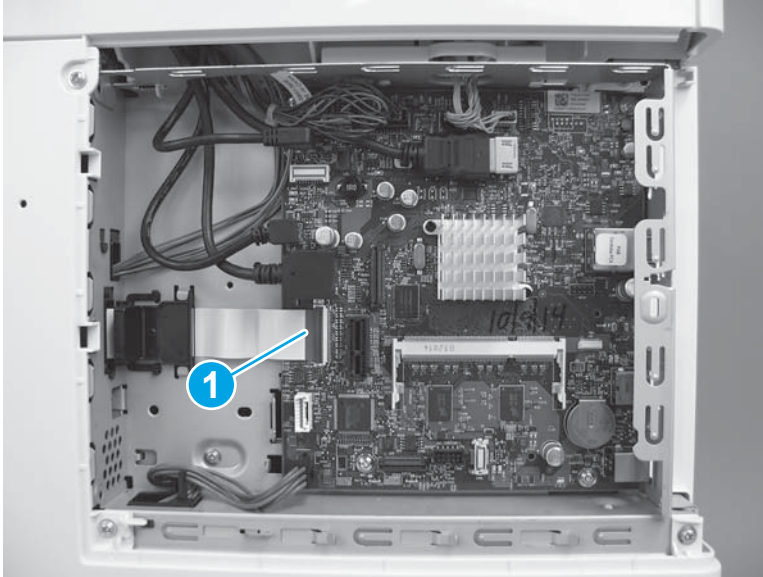
For the M552 and M553 models, skip this step and go to [Step 28: Install the formatter \(M552 and M553\) on page 1317](#).

 **CAUTION:**  ESD-sensitive part.

1. Position the tab and telephone port (callout 1) on the fax PCA in the slots (callout 2) in the formatter case.

Figure 1-2310 Position the fax PCA

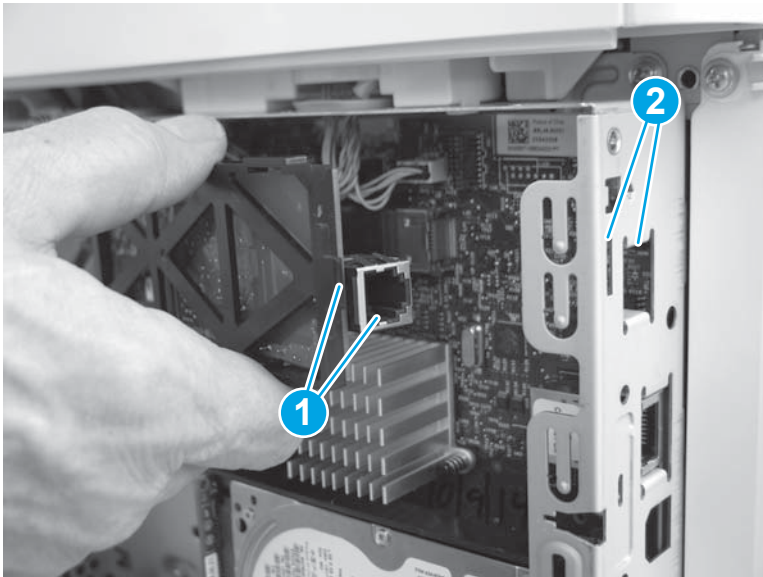

2. Slide the fax PCA to the right (callout 1) until the tab and telephone port described in the previous step and seated in the formatter case. Position the retainer (callout 2) in the slot (callout 3) in the formatter. Rotate the end of the fax PCA toward the formatter (callout 4) until the retainer snaps into place.

Figure 1-2311 Install the fax PCA

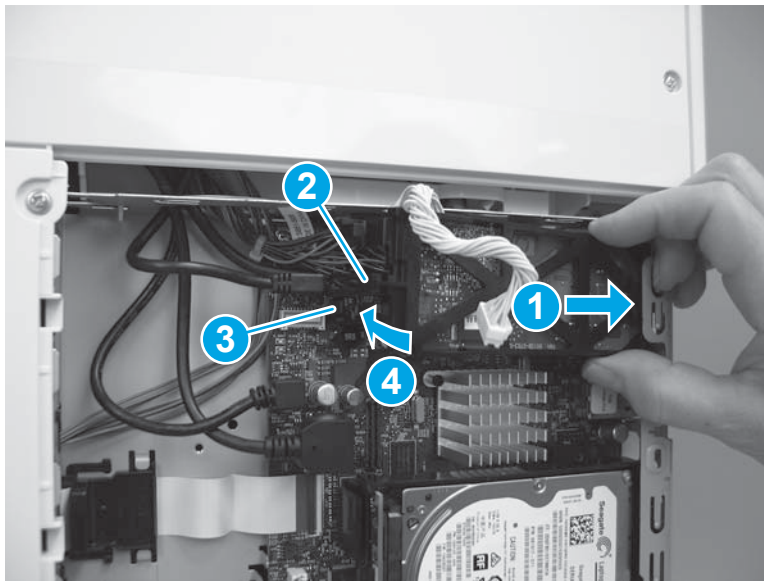

3. Position the cable (callout 1) in the guide (callout 2), and then connect one connector (callout 3).

Figure 1-2312 Connect the connector

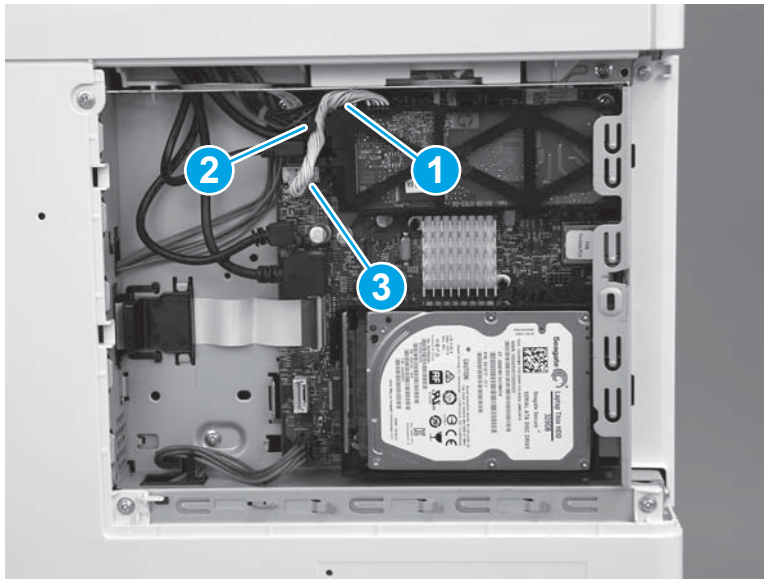

Step 27: Install the HDD (M577)

 **NOTE:** This step is for the M577 models. For the M552 and M553 models, skip this step and go to [Step 28: Install the formatter \(M552 and M553\) on page 1317.](#)

 **CAUTION:**  ESD-sensitive part.

1. Align the end of the bracket (callout 1) with the slot in the chassis (callout 2), and then slide the HDD into the printer (callout 3) to engage the bracket with the chassis.

Figure 1-2313 Install the holder

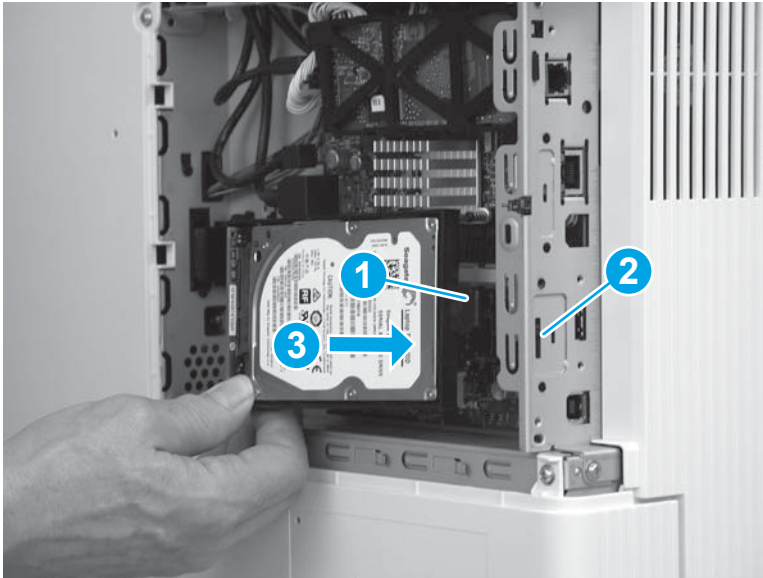

2. Hold the HDD connector latch (callout 1) in the released position, and then rotate the HDD down and into the connector on the formatter to install it.

 **NOTE:** Make sure that the tab (callout 2) snaps into place, and that the HDD is securely installed.

Figure 1-2314 Release the HDD

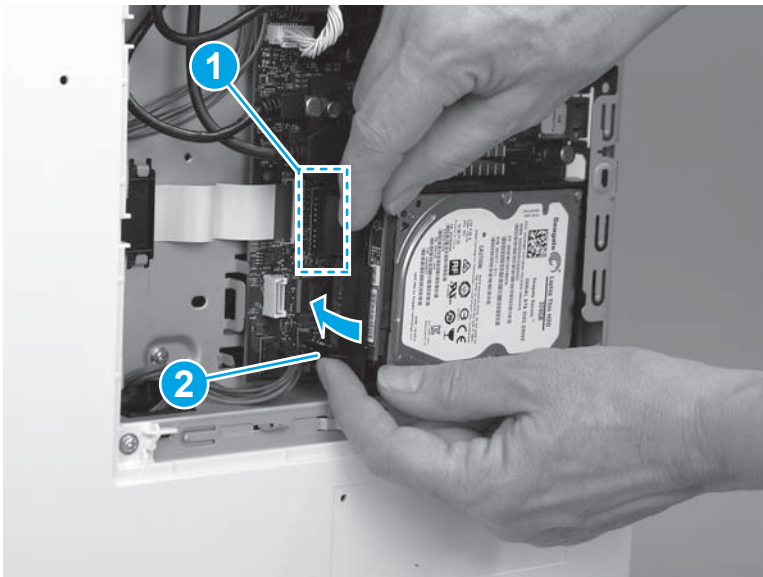

Step 28: Install the formatter (M552 and M553)

 **NOTE:** This step is for the M552 and M553 models. For the M577 models, skip this step and go to [Step 29: Install the formatter cover on page 1318](#).

If the optional hard-disk drive (HDD) was removed, do not forget to reinstall it after the formatter is reinstalled.

Engage the HDD holder with the chassis, rotate the HDD connector down and into the connector on the formatter. Make sure that the tabs snap into place.

 **CAUTION:**  ESD-sensitive part.

1. Position the formatter in the printer, and then install four screws (callout 1).

Figure 1-2315 Install the formatter

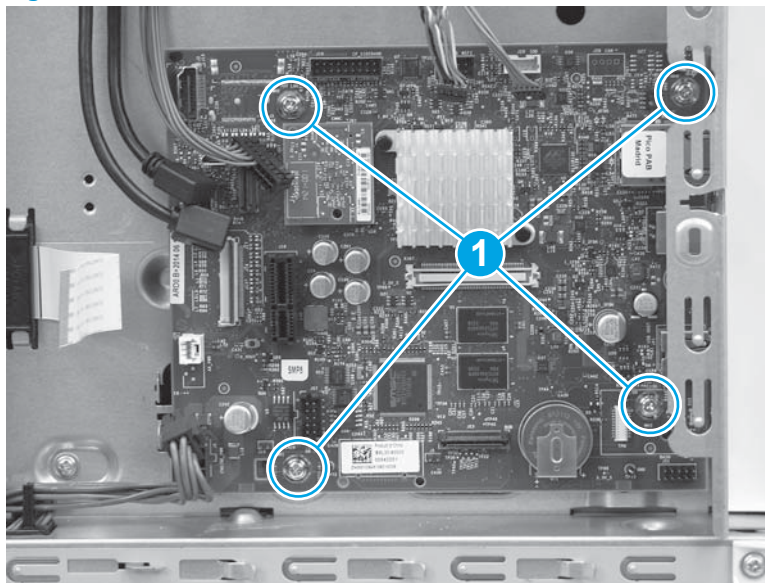

2. Connect all of the connectors on the formatter.

The following connectors are empty:

- All models: J1 (this connector is empty unless the optional DIMM is installed)
- M553n/dn and M552dn: J2 (callout 1; this is the touchscreen connector for the M553x model)
- All models: J9 (this connector is empty unless the optional internal USB ports component is installed)
- All models: J18 (this connector is empty unless the optional hard-disk-drive (HDD) is installed)
- All models: J23
- All models: J24
- M553n/dn and M552dn: J25 (this is the wireless connector for the M553x model)

- All models: J57
- All models: J98 (this connector is empty unless the optional trusted platform module (TPM) is installed)



 **IMPORTANT:** The flat-cable connector (callout 2) is a Zero Insertion Force (ZIF) connector that uses a hinged retainer to secure the flat cable. The hinged retainer must be opened to install the flat cable.

Figure 1-2316 Connect all connectors

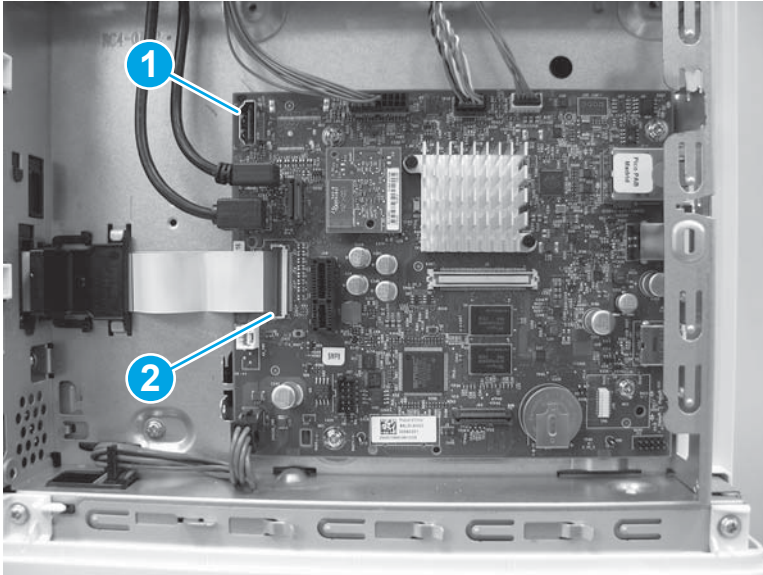

Step 29: Install the formatter cover

- ▲ Slide the cover onto the printer (callout 1) to install it.

 **NOTE:** Make sure that the tabs on the formatter cover align with the slots provided in the printer (callout 2). Tighten the two thumbscrews (callout 3).



 **TIP:** If needed, use the edge of a coin to turn the thumbscrews.

Figure 1-2317 Install the cover

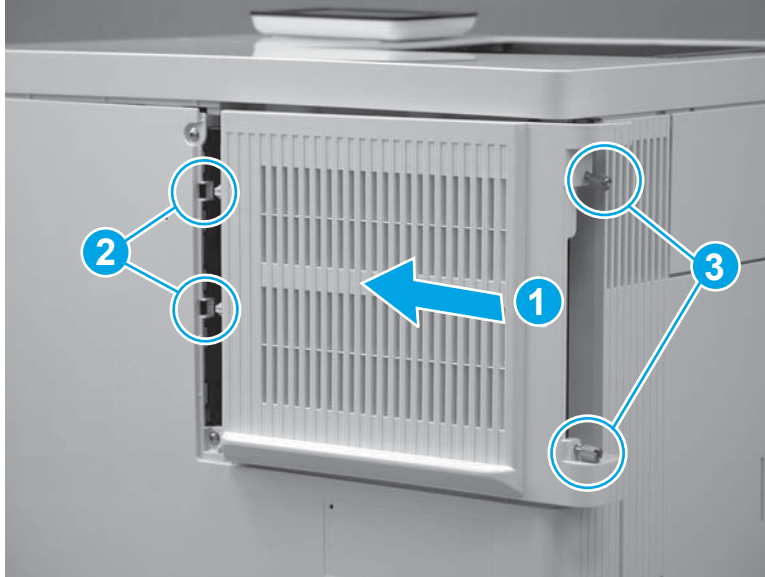

Step 30: Install the toner cartridges

- ▲ Support the toner cartridge underneath with one hand while holding the cartridge handle with the other. Align the toner cartridge with its slot on the shelf, and then insert the toner cartridge into the printer. Repeat this step for the remaining toner cartridges.

 **NOTE:** Avoid touching the green imaging drum. Fingerprints on the imaging drum can cause print defects.

 **TIP:** Leave the front door open until the TCU is reinstalled.

Figure 1-2318 Install a toner cartridge



Step 31: Install the TCU

1. Verify that the toner collection hatch cover is in the closed position on the TCU.

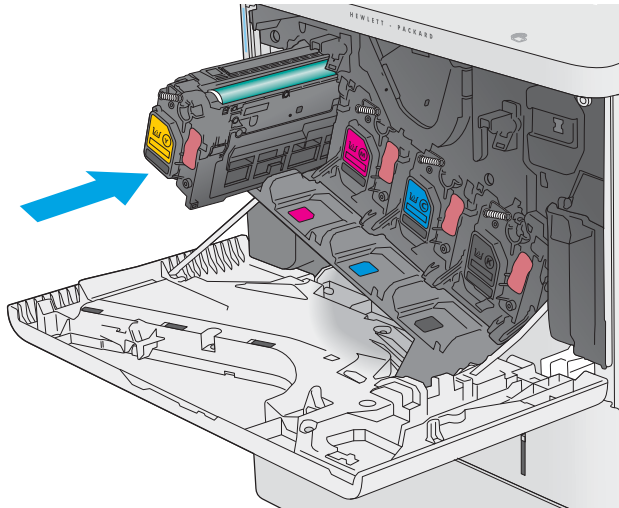
Figure 1-2319 Verify that the toner collection hatch cover is closed

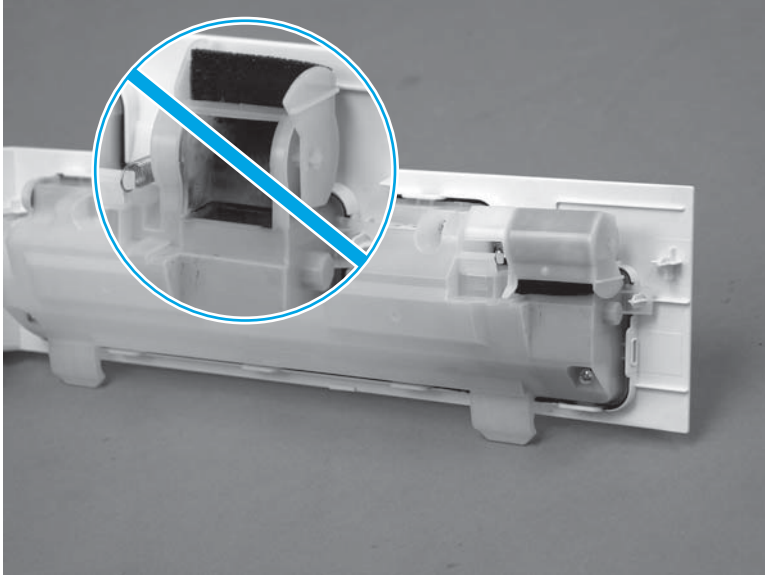

2. Position the TCU with the hinges in the slots provided in the printer (callout 1), and then rotate the TCU up and into the closed position.



NOTE: The toner collection hatch cover automatically opens when the TCU is closed.

Figure 1-2320 Install the TCU

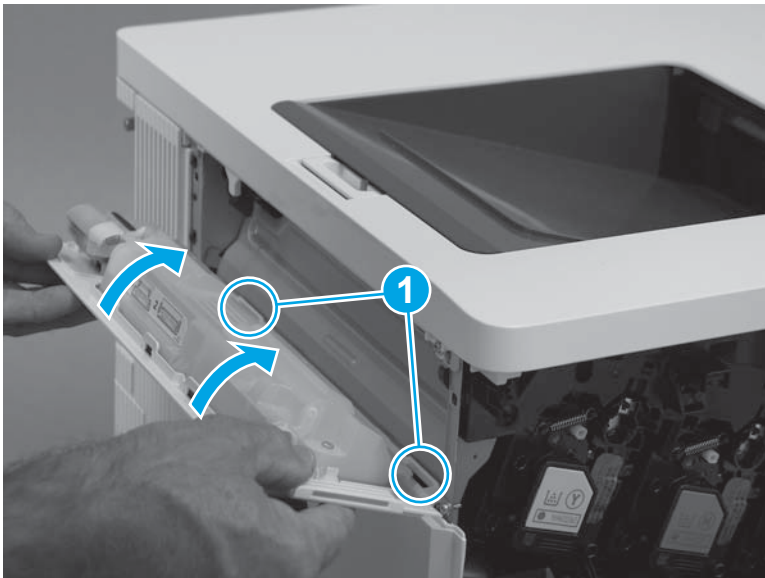

3. Close the front door.

Figure 1-2321 Close the front door



Removal and replacement: Delivery fan (FM3)

- [Introduction](#)
- [Step 1: Remove the USB cover \(M552 and M553\)](#)
- [Step 2: Remove the control panel \(M553x only\)](#)
- [Step 3: Remove the tray](#)
- [Step 4: Remove the toner collection unit \(TCU\)](#)
- [Step 5: Remove the formatter cover](#)
- [Step 6: Remove the formatter \(M552 and M553\)](#)
- [Step 7: Remove the hard-disk drive \(HDD\) \(M577\)](#)
- [Step 8: Remove the fax PCA \(M577c/f/z\)](#)
- [Step 9: Remove the formatter \(M577\)](#)
- [Step 10: Remove the rear cover \(M552 and M553\)](#)
- [Step 11: Remove the rear upper cover \(M577\)](#)
- [Step 12: Remove the rear cover \(M577\)](#)
- [Step 13: Remove the left upper cover \(M577\)](#)
- [Step 14: Remove the right front upper cover \(M577dn\)](#)
- [Step 15: Remove the stapler cover assembly \(M577c/f/z\)](#)
- [Step 16: Remove the integrated scanner assembly \(ISA\) \(M577\)](#)
- [Step 17: Remove the right upper cover \(M577\)](#)
- [Step 18: Remove the top rear cover \(M577\)](#)
- [Step 19: Remove the left cover](#)
- [Step 20: Remove the upper cover \(M552 and M553\)](#)
- [Step 21: Remove the formatter case](#)
- [Step 22: Remove the delivery fan \(FM3\)](#)
- [Step 23: Unpack the replacement assembly](#)
- [Step 24: Install the delivery fan \(FM3\)](#)
- [Step 25: Install the formatter case](#)
- [Step 26: Install the upper cover \(M552 and M553\)](#)
- [Step 27: Install the left cover](#)
- [Step 28: Install the top rear cover \(M577\)](#)
- [Step 29: Install the right upper cover \(M577\)](#)

- [Step 30: Install the integrated scanner assembly \(ISA\) \(M577\)](#)
- [Step 31: Install the stapler cover assembly \(M577c/f/z\)](#)
- [Step 32: Install the right front upper cover \(M577dn\)](#)
- [Step 33: Install the left upper cover \(M577\)](#)
- [Step 34: Install the rear cover \(M577\)](#)
- [Step 35: Install the rear upper cover \(M577\)](#)
- [Step 36: Install the rear cover \(M552 and M553\)](#)
- [Step 37: Install the formatter \(M577\)](#)
- [Step 38: Install the fax PCA \(M577c/f/z\)](#)
- [Step 39: Install the HDD \(M577\)](#)
- [Step 40: Install the formatter \(M552 and M553\)](#)
- [Step 41: Install the formatter cover](#)
- [Step 42: Install the TCU](#)
- [Step 43: Install the tray](#)
- [Step 44: Install the control-panel assembly \(M553x only\)](#)
- [Step 45: Install the USB cover \(M552 and M553\)](#)

Introduction

This document provides the procedures to remove and replace the delivery fan (FM3).

Before performing service

Turn the printer power off

- Disconnect the power cable.

⚠ WARNING! To avoid damage to the printer, turn the printer off, wait 30 seconds, and then remove the power cord before attempting to service the printer.

Use the table below to identify the correct part number for your printer, and then go to <http://h20141.www2.hp.com/hpparts> to order the part.

Delivery fan (FM3) part number	
RK2-2728-000CN	Delivery fan (FM3)

Required tools

- #2 Phillips screwdriver with a magnetic tip

After performing service

Make sure that all of the connectors on the formatter are fully seated.

Make sure that the formatter cover is fully seated, and that the thumbscrews are finger tight after replacing it.

Turn the printer power on

- Connect the power cable.
- Use the power switch to turn the power on.

Step 1: Remove the USB cover (M552 and M553)



NOTE: This step is for the M552 and M553 models. For the M577 models, skip this step and go to [Step 3: Remove the tray on page 1329](#).

1. Locate the USB cover.

Figure 1-2322 Locate the USB cover

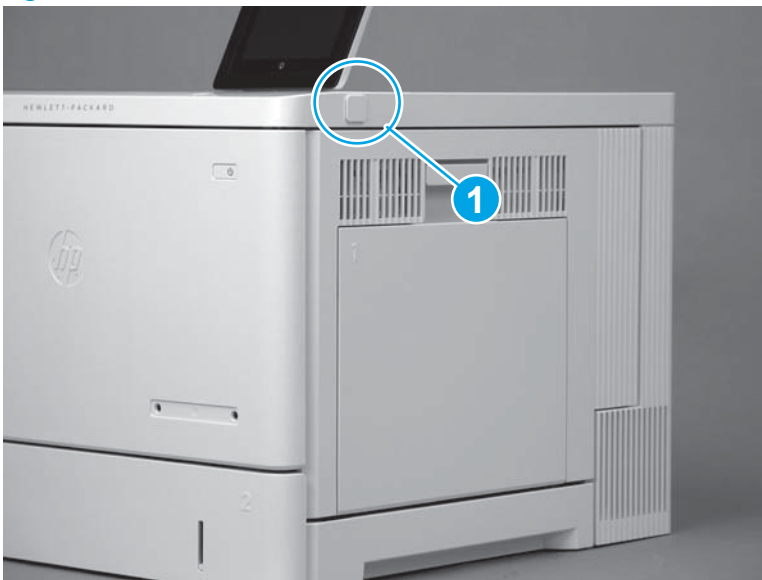

2. Pull the cover off of the printer to remove it.

Figure 1-2323 Remove the cover



Step 2: Remove the control panel (M553x only)

 **NOTE:** This step is for the M553x model. For the M553n/dn, M552dn, and M577 models, skip this step and go to [Step 3: Remove the tray on page 1329](#).

1. Tilt the control panel up.

Figure 1-2324 Tilt the control panel up



2. Use a small flat-blade screwdriver to release the control-panel screws cover tabs.

Figure 1-2325 Release the control-panel screws cover tabs



3. Rotate the cover up to remove it.

Figure 1-2326 Remove the cover



4. Use a small Phillips screwdriver to remove two screws (callout 1).

 **IMPORTANT:** Store the screws in a secure place where they cannot fall down into the printer.

Figure 1-2327 Remove two screws



5. Rotate the control-panel base toward the front of the printer.

Figure 1-2328 Rotate the control-panel base up

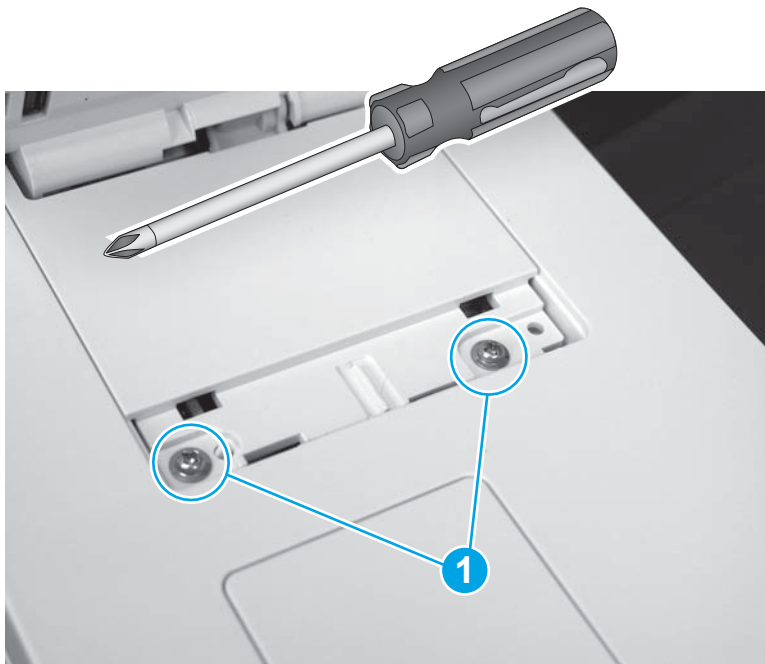

6. Slightly slide the control-panel base toward the rear of the printer (callout 1) to release it, and then turn the control panel over (callout 2) to access the bottom side.

CAUTION: The control panel is still attached to the printer. Do not attempt to completely remove the control panel.

Figure 1-2329 Turn the control panel over

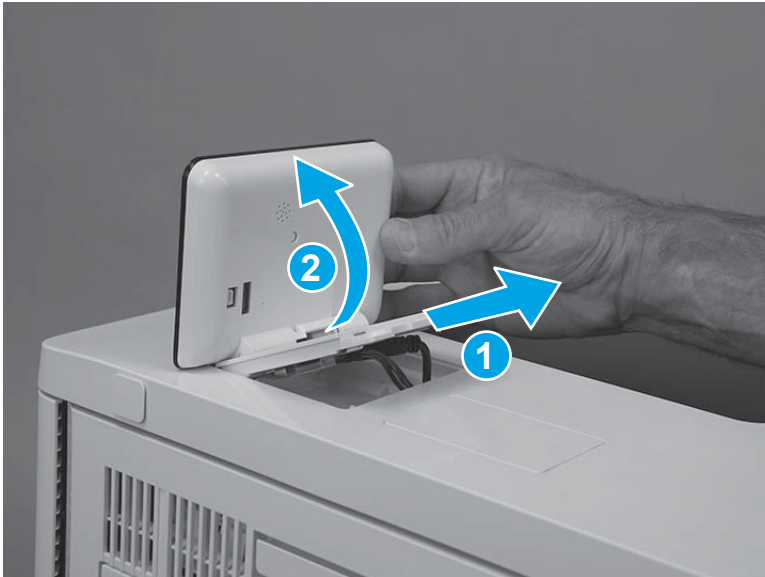

7. Disconnect one USB cable (callout 1), one connector (callout 2), and then remove the control panel.

Figure 1-2330 Disconnect two connectors

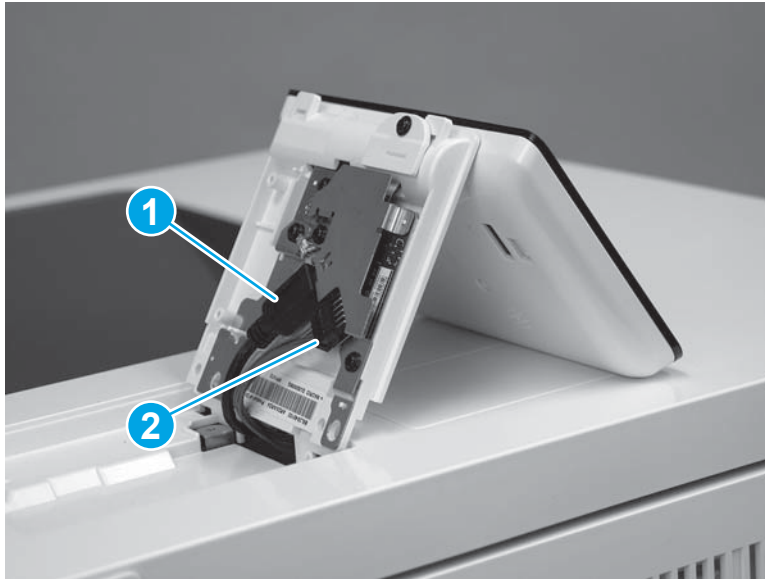

Step 3: Remove the tray

1. Pull the tray out until it stops.

Figure 1-2331 Pull the tray out



2. Lift the front of the tray, and then pull it out of the printer to remove it.

Figure 1-2332 Remove the tray

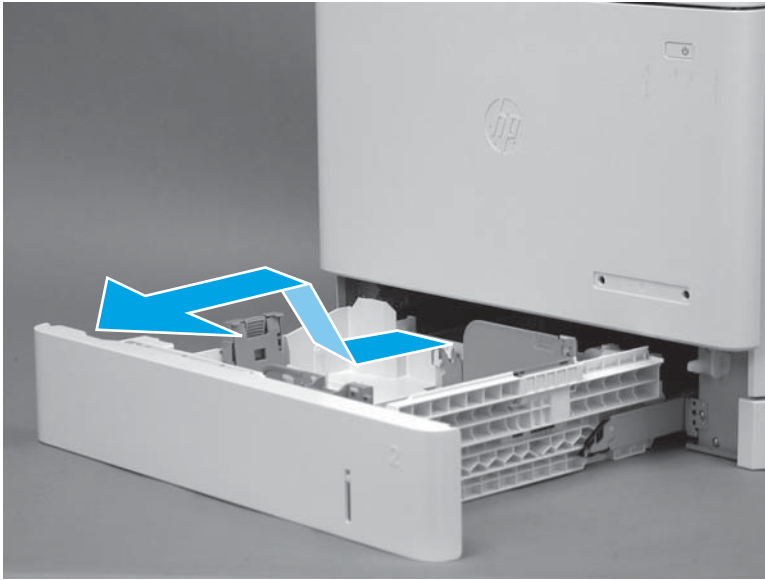

Step 4: Remove the toner collection unit (TCU)

1. Open the front door.

Figure 1-2333 Open the front door



2. Open the TCU.



NOTE: The toner collection hatch cover automatically closes when the TCU is opened.

Figure 1-2334 Open the TCU



3. Pull the TCU away from the printer at an angle to remove it.

⚠ CAUTION: Do not open the toner collection hatch cover when handling the TCU. If toner gets on clothing, wipe it off by using a dry cloth and wash the clothes in cold water. Hot water sets toner into fabric.

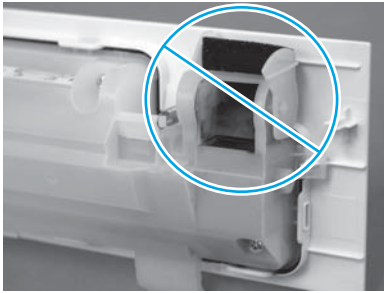
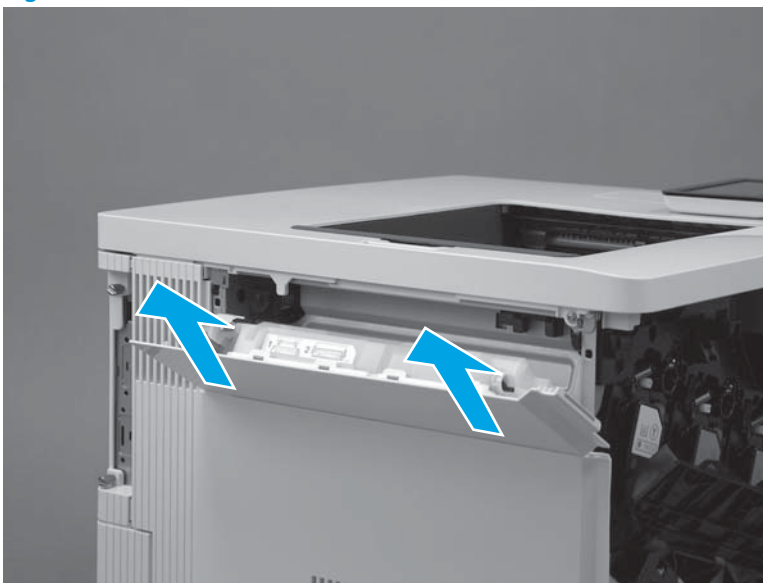

Figure 1-2335 Remove the TCU



Step 5: Remove the formatter cover

1. Locate the formatter cover.

Figure 1-2336 Locate the formatter cover

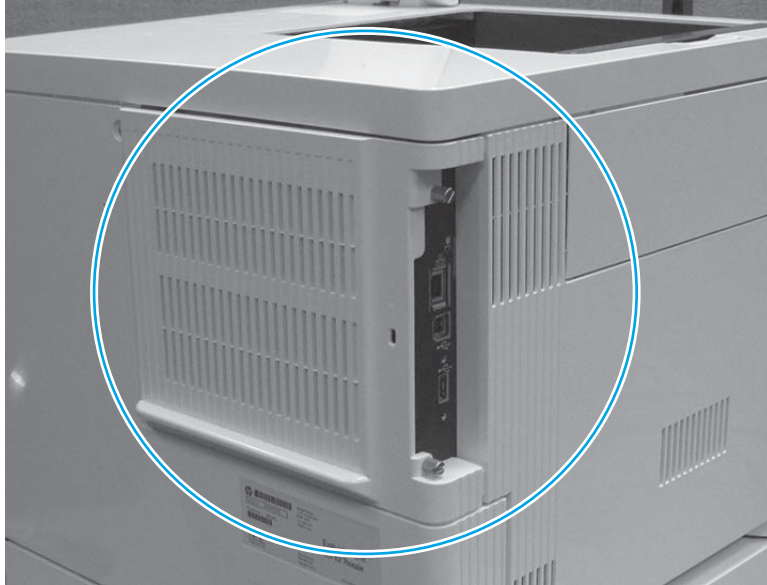

2. Loosen the two thumbscrews (callout 1). Grasp the two thumbscrews, and then slide the cover away from the printer (callout 2) to remove it.

 **TIP:** If needed, use the edge of a coin to turn the thumbscrews.

Figure 1-2337 Loosen the thumbscrews



Step 6: Remove the formatter (M552 and M553)

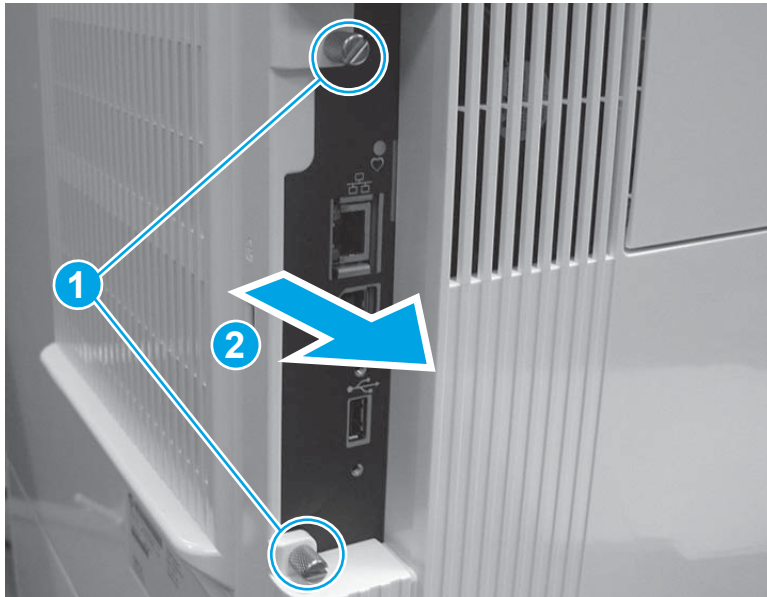

NOTE: This step is for the M552 and M553 models. For the M577 models, skip this step and go to [Step 7: Remove the hard-disk drive \(HDD\) \(M577\) on page 1335](#).

If the optional hard-disk drive (HDD) is installed, it must be removed to gain access to the formatter mounting screws.

Release two tabs along the left edge of the HDD, rotate the left edge away from the product, and then slide the HDD to the left to remove it.



CAUTION:  ESD-sensitive part.

1. Disconnect all of the connectors on the formatter.

The following connectors are empty:

- All models: J1 (this connector is empty unless the optional DIMM is installed)
- M553n/dn and M552dn: J2 (callout 1; this is the touchscreen connector for the M553x model)
- All models: J9 (this connector is empty unless the optional internal USB ports component is installed)
- All models: J18 (this connector is empty unless the optional hard-disk-drive (HDD) is installed)
- All models: J23
- All models: J24
- M553n/dn and M552dn: J25 (this is the wireless connector for the M553x model)
- All models: J57
- All models: J98 (this connector is empty unless the optional trusted platform module (TPM) is installed)



IMPORTANT: The flat-cable connector (callout 2) is a Zero Insertion Force (ZIF) connector that uses a hinged retainer to secure the flat cable. The hinged retainer must be opened to release the flat cable.

Figure 1-2338 Disconnect all connectors

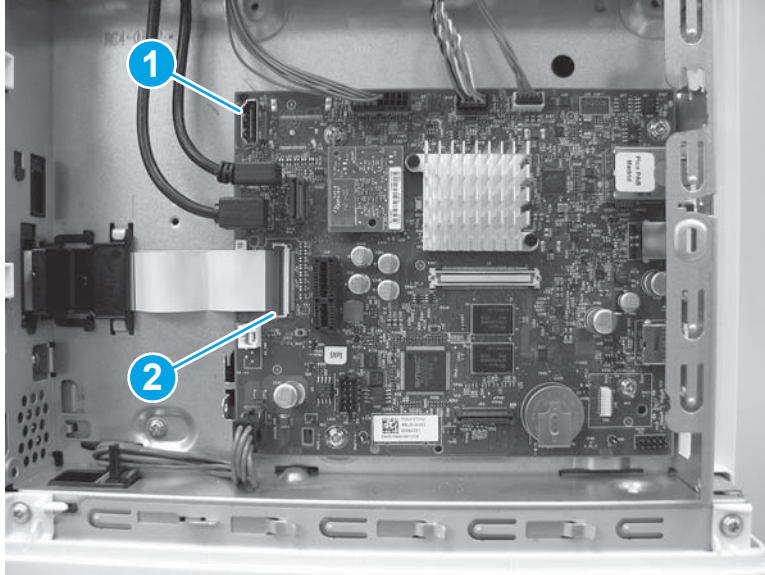

2. Remove four screws (callout 1), and then remove the formatter.

Figure 1-2339 Remove the formatter

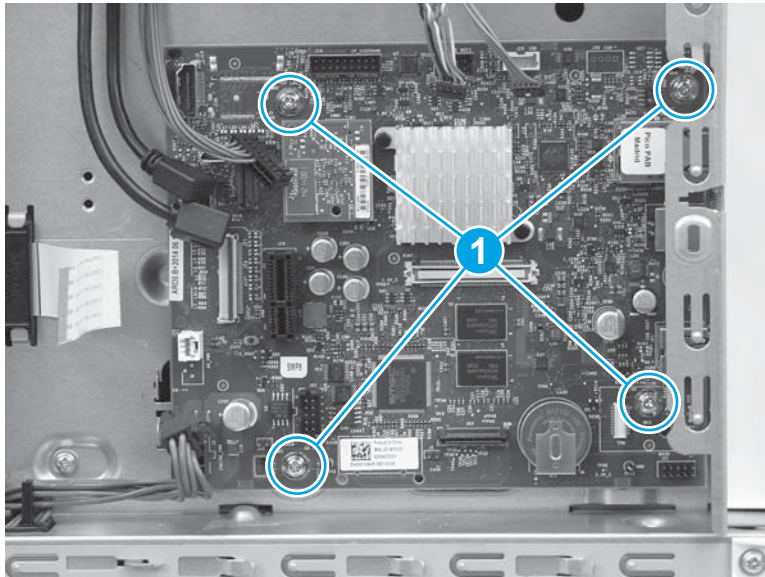

Step 7: Remove the hard-disk drive (HDD) (M577)

 **NOTE:** This step is for the M577 models. For the M552 and M553 models, skip this step and go to [Step 10: Remove the rear cover \(M552 and M553\) on page 1340](#).

 **CAUTION:**  ESD-sensitive part.

1. Release two tabs (callout 1). Hold the tabs in the released position, and then rotate the hard disk drive (HDD) up (callout 2) to release the connector from the formatter.

Figure 1-2340 Release the HDD

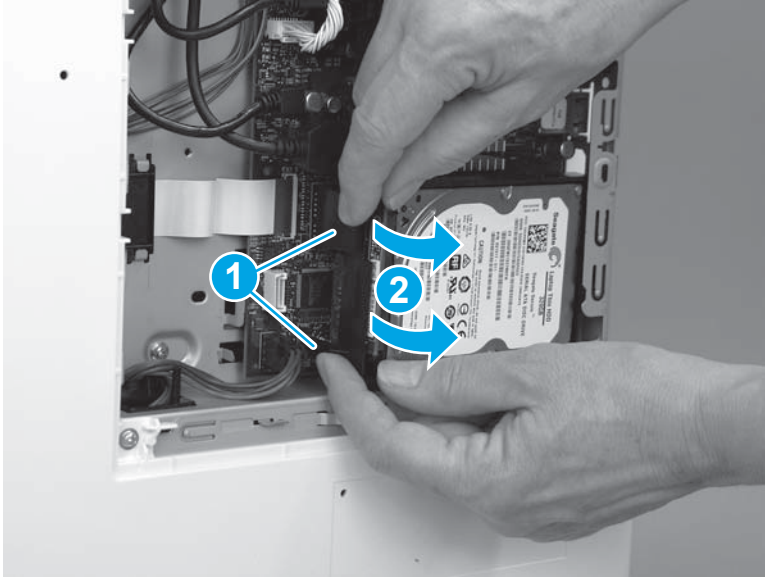

2. Slide the HDD away from the printer to remove it.

Figure 1-2341 Remove the HDD



Step 8: Remove the fax PCA (M577c/f/z)



NOTE: This step is for the M577c/f/z models. For the M577n model, skip this step and go to [Step 9: Remove the formatter \(M577\) on page 1338](#).

For the M552 and M553 models, skip this step and go to [Step 10: Remove the rear cover \(M552 and M553\) on page 1340](#).



CAUTION:  ESD-sensitive part.

1. Locate the fax PCA component on the formatter.

Figure 1-2342 Locate the fax PCA

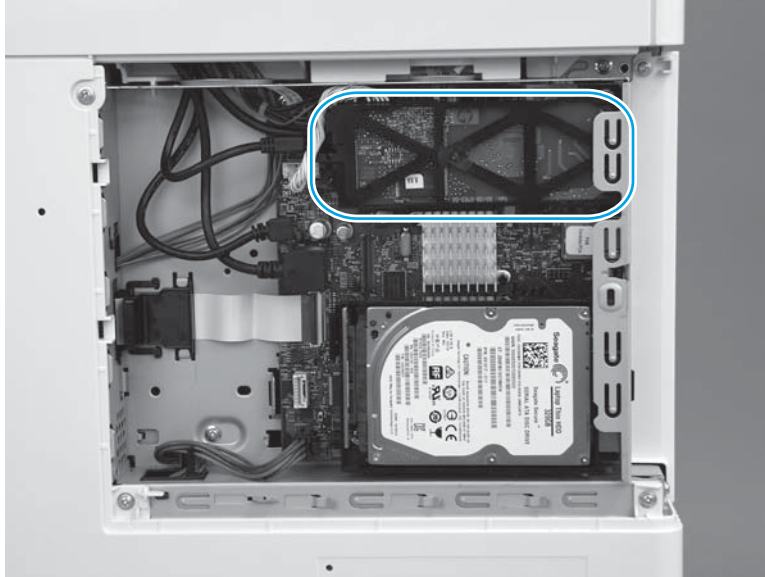

2. Release the connector latch (callout 1), and then pull the connector away from the formatter (callout 2) to disconnect it.

Figure 1-2343 Disconnect one connector

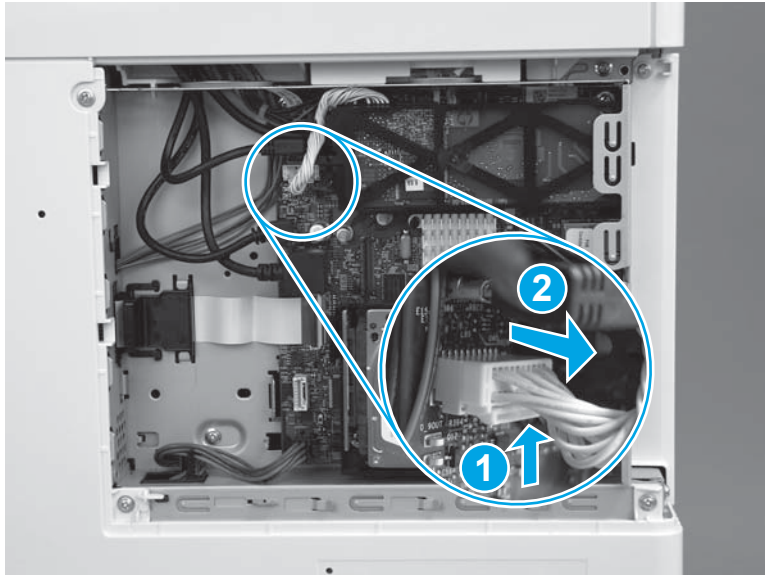

3. Release one retainer (callout 1) by pressing the bracket arms together.

Figure 1-2344 Release one latch

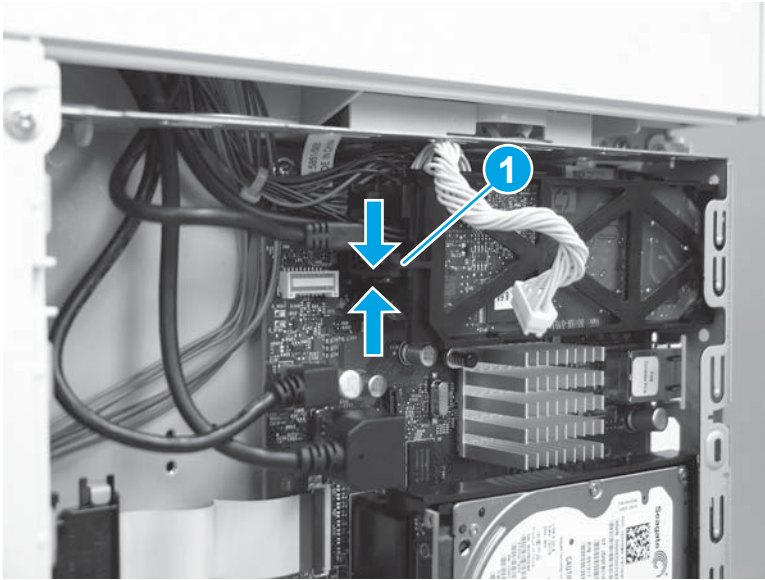

4. Rotate the end of the fax PCA (callout 1) away from the formatter, and then slide the PCA left (callout 2) to remove it.

Figure 1-2345 Remove the fax PCA

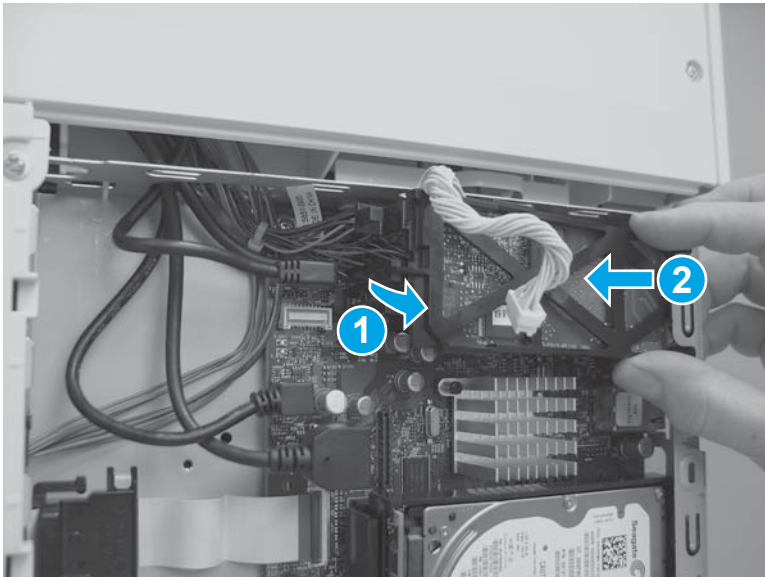

Step 9: Remove the formatter (M577)

 **NOTE:** This step is for the M577 models. For the M552 and M553 models, skip this step and go to [Step 10: Remove the rear cover \(M552 and M553\) on page 1340.](#)

 **CAUTION:**  ESD-sensitive part.

1. Disconnect all of the connectors on the formatter.

The following connectors are empty:

- All models: J1 (this connector is empty unless the optional DIMM is installed)
- All models: J3
- M577dn: J15 (this is the fax connector for the M577f/z/c models)
- All models: J21 (this connector is empty unless the optional internal USB ports component is installed)
- All models: J23
- All models: J24
- All models: J51
- All models: J57
- All models: J97
- All models: J98 (this connector is empty unless the optional trusted platform module (TPM) is installed)

 **IMPORTANT:** The flat-cable connector (callout 1) is a Zero Insertion Force (ZIF) connector that uses a hinged retainer to secure the flat cable. The hinged retainer must be opened to release the flat cable.

Figure 1-2346 Disconnect all connectors



2. Remove four screws (callout 1).

Figure 1-2347 Remove four screws

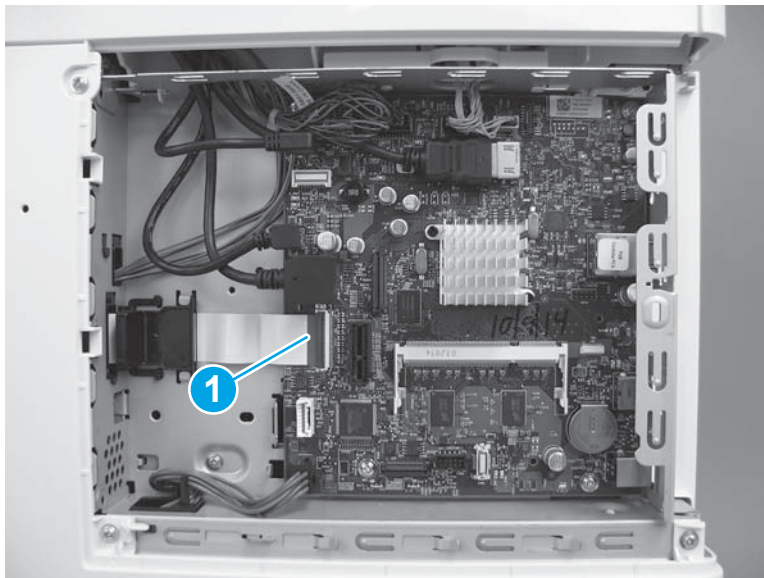
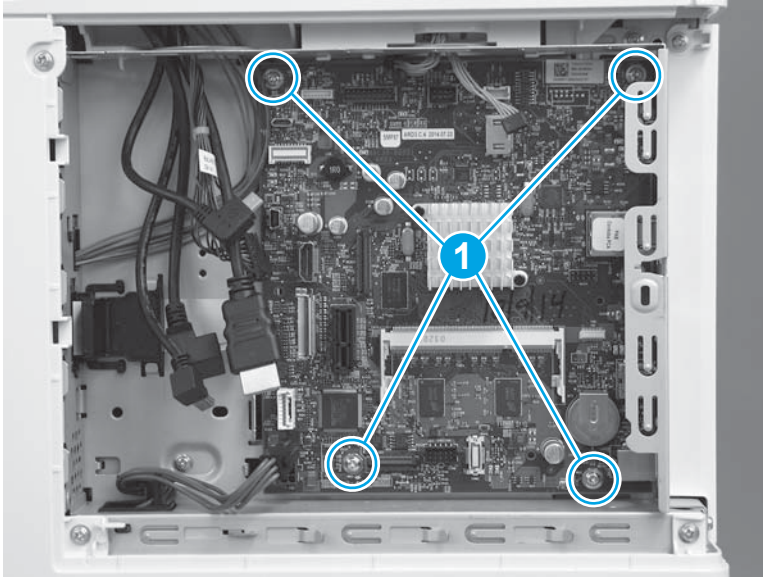

3. Remove the formatter.

Figure 1-2348 Remove the formatter

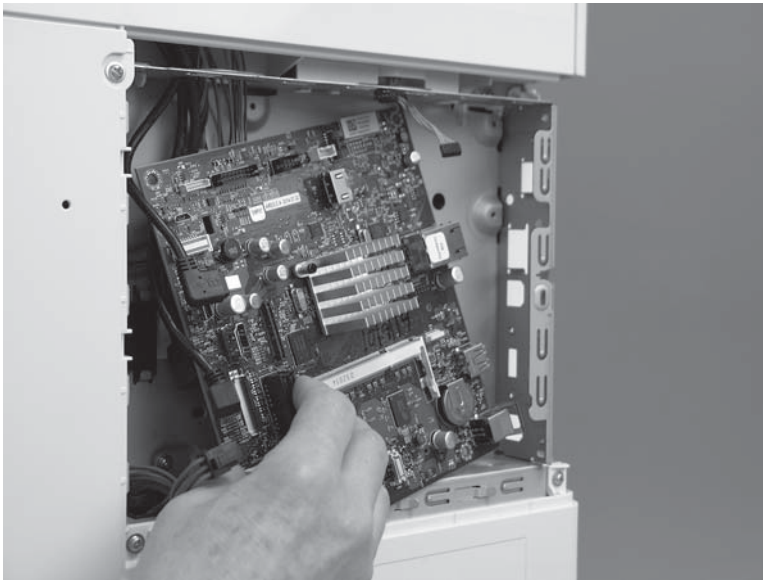

Step 10: Remove the rear cover (M552 and M553)



NOTE: This step is for the M552 and M553 models. For the M577 models, skip this step and go to [Step 11: Remove the rear upper cover \(M577\) on page 1341.](#)

1. Remove four screws (callout 1).

Figure 1-2349 Remove four screws

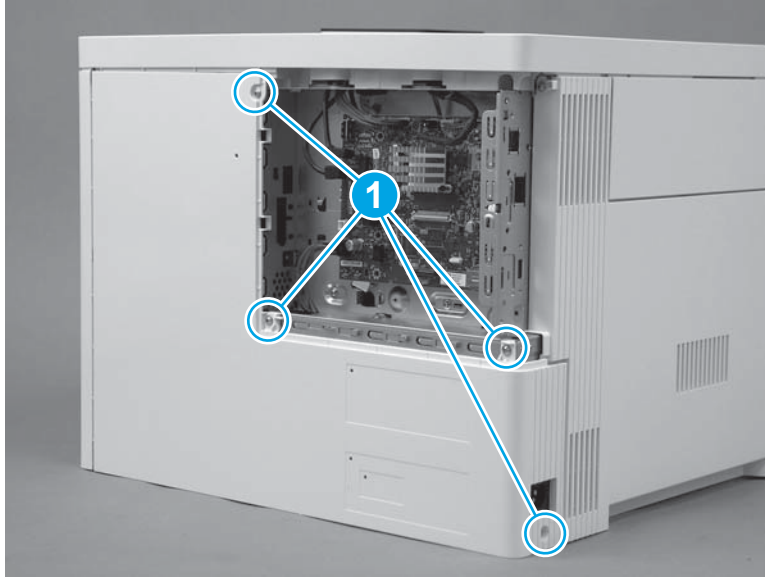

2. Slightly slide the cover to the right (callout 1), rotate the bottom of the cover away from the printer (callout 2), and then pull the top of the cover away from the printer (callout 3) to remove the cover.

Figure 1-2350 Remove the cover

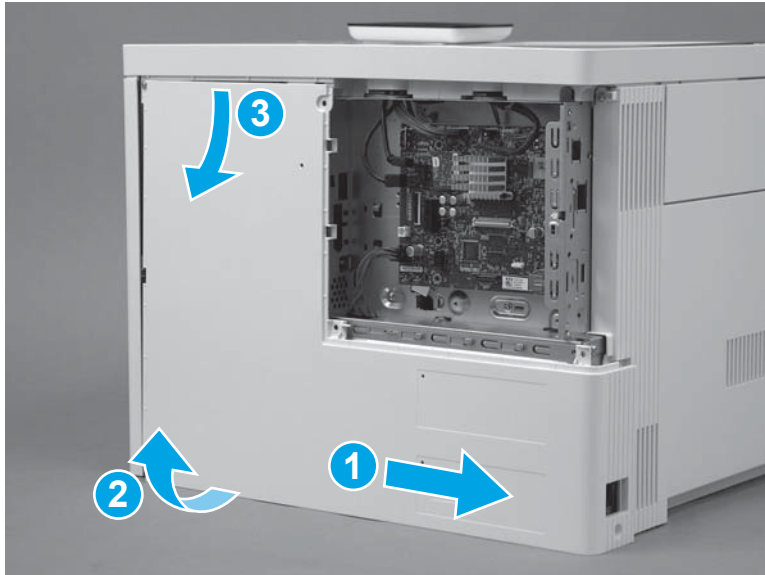

Step 11: Remove the rear upper cover (M577)



NOTE: This step is for the M577 models. For the M552 and M553 models, skip this step and go to [Step 19: Remove the left cover on page 1356](#).

1. Remove two screws (callout 1).



Reinstallation tip: These two screws are self-tapping screws for plastic. When reinstalling them, rotate the screws counterclockwise to align them with the existing thread pattern, and then carefully turn them clockwise to tighten. Do not overtighten. This will prevent stripping the threads inside the screw holes.

Figure 1-2351 Remove two screws

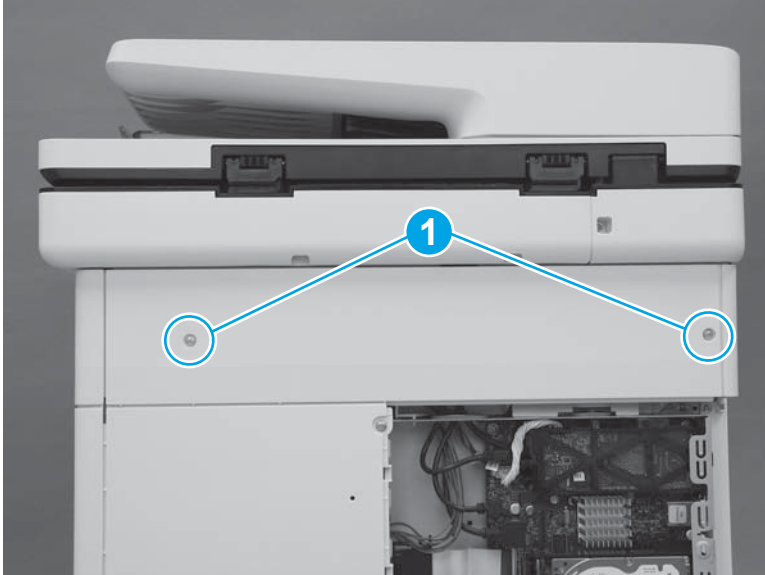

2. Use a small, flat blade screwdriver to release the right edge of the cover.

Figure 1-2352 Release the right edge

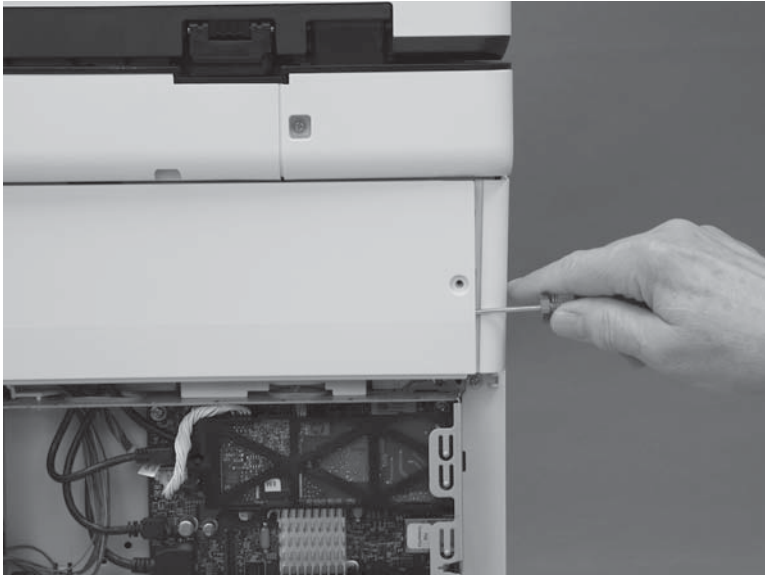

3. Pull the right edge of the cover (callout 1) away from the printer, and then slide the cover to the right (callout 2).

Figure 1-2353 Slide the cover right

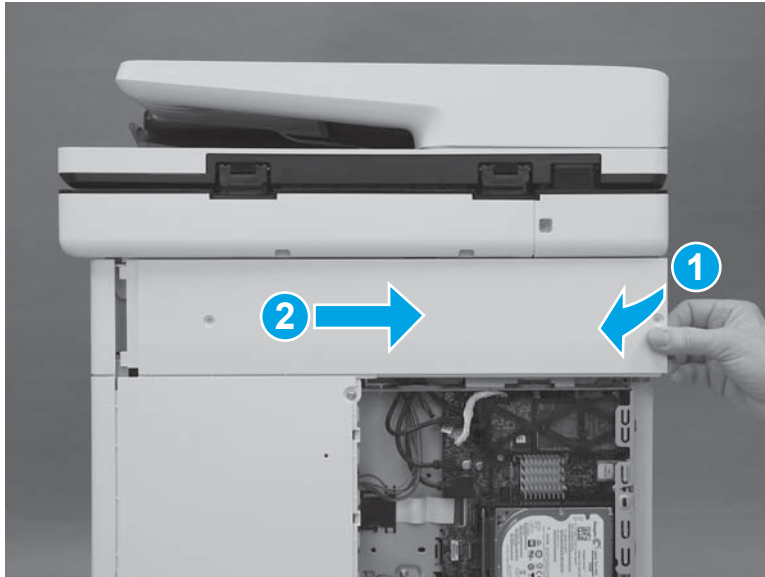

4. Remove the cover.

Figure 1-2354 Remove the cover

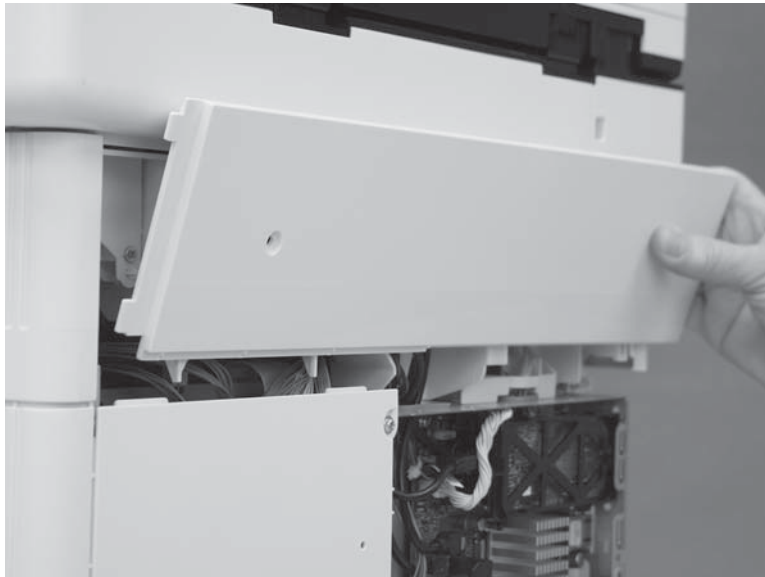

Step 12: Remove the rear cover (M577)

 **NOTE:** This step is for the M577 models. For the M552 and M553 models, skip this step and go to [Step 19: Remove the left cover on page 1356.](#)

1. Remove four screws (callout 1).

Figure 1-2355 Remove four screws

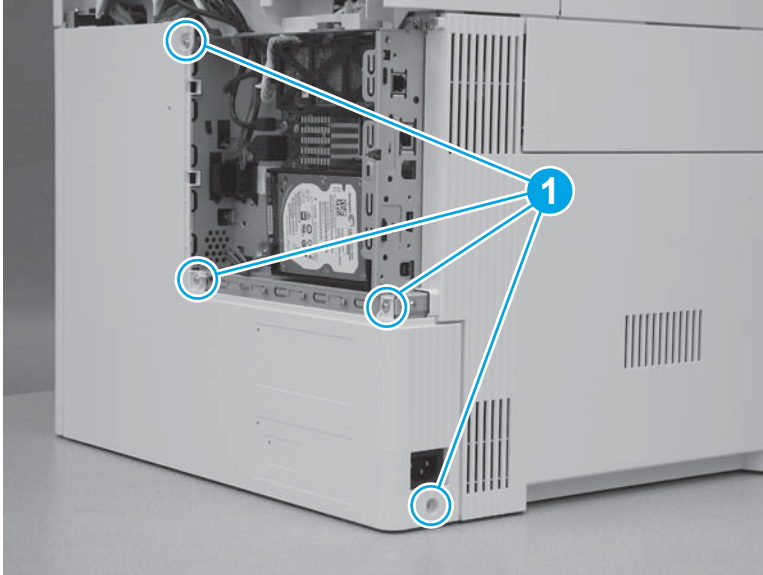

2. Slide the cover to the right to remove it.

Figure 1-2356 Remove the cover

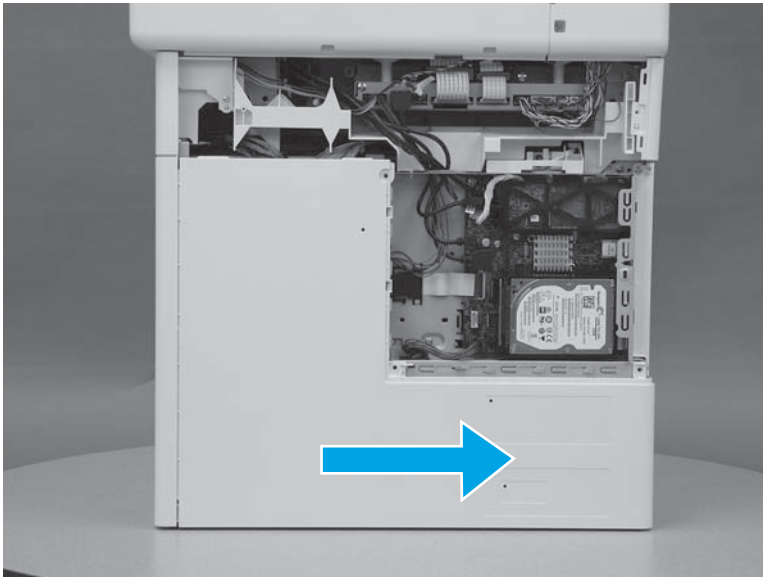

Step 13: Remove the left upper cover (M577)



NOTE: This step is for the M577 models. For the M552 and M553 models, skip this step and go to [Step 19: Remove the left cover on page 1356](#).

1. At the left side of the printer, release one tab (callout 1).

Figure 1-2357 Release one tab

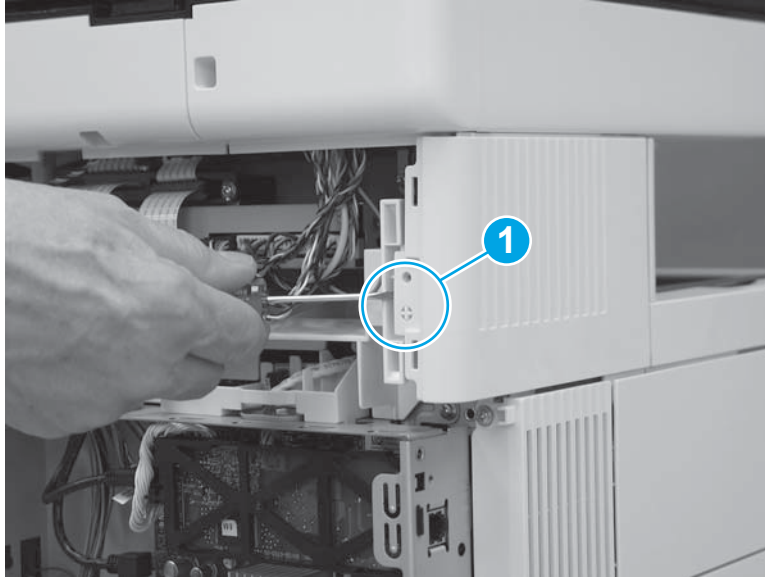

2. Slide the left upper cover toward the back of the printer.

Figure 1-2358 Slide the cover back

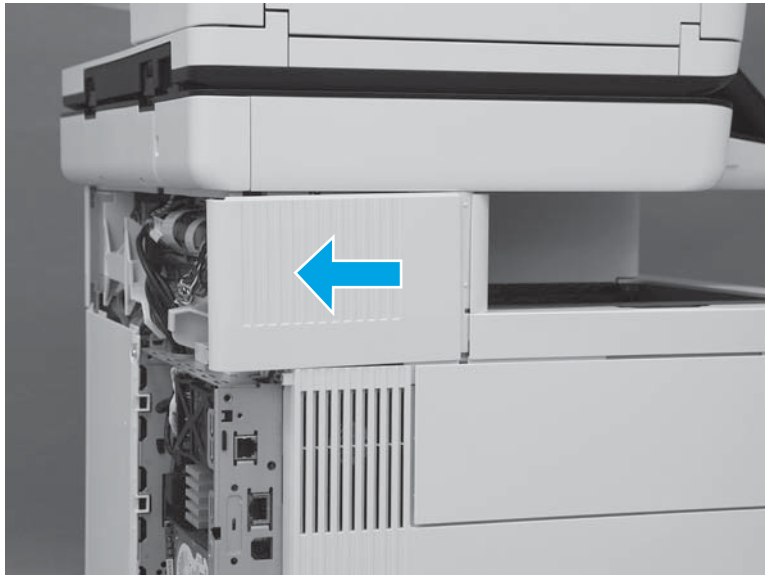

3. Rotate the cover up to remove it.

Figure 1-2359 Remove the left upper cover



Step 14: Remove the right front upper cover (M577dn)



NOTE: This step is for the M577dn model. For the M577c/f/z models, skip this step and to go [Step 15: Remove the stapler cover assembly \(M577c/f/z\) on page 1347.](#)

For the M552 and M553 models, skip this step and go to [Step 19: Remove the left cover on page 1356.](#)

1. Remove one screw (callout 1).

Figure 1-2360 Remove one screw

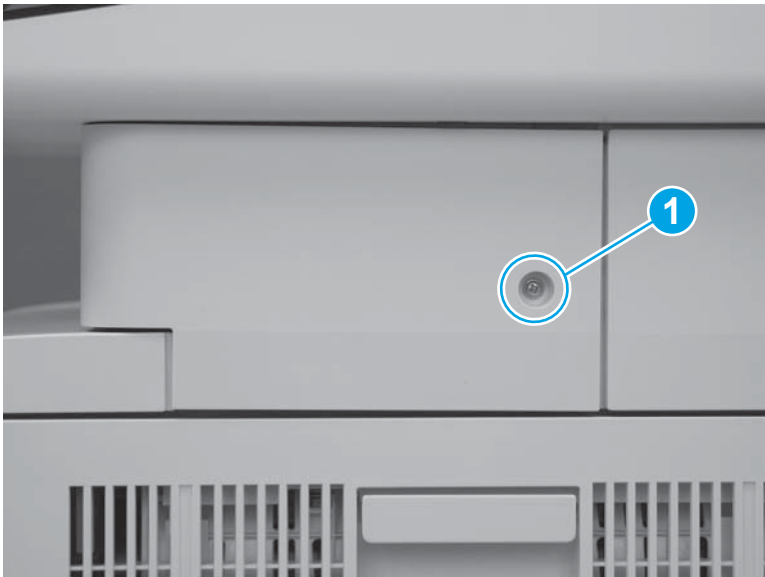

2. Release two tabs at the front edge of the cover (callout 1).

Figure 1-2361 Release two tabs



3. Rotate the front of the cover to the right to remove it.

Figure 1-2362 Rotate the cover



Step 15: Remove the stapler cover assembly (M577c/f/z)

 **NOTE:** This step is for the M577c/f/z models. For the M577dn model, skip this step and to go [Step 17: Remove the right upper cover \(M577\) on page 1352.](#)

For the M552 and M553 models, skip this step and go to [Step 19: Remove the left cover on page 1356.](#)

1. Remove one screw (callout 1).

 **Reinstallation tip:** This is a self-tapping screw for plastic. When reinstalling, rotate the screw counterclockwise to align it with the existing thread pattern, and then carefully turn it clockwise to tighten. Do not overtighten. This will prevent stripping the threads inside the screw hole.

Figure 1-2363 Remove one screw



2. Release two tabs at the front edge of the cover (callout 1).

Figure 1-2364 Release two tabs

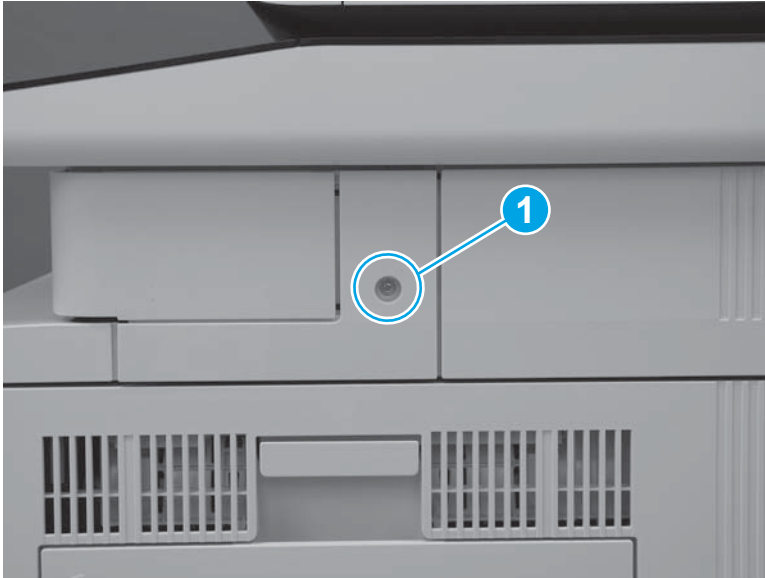

3. Release the back edge of the cover.

Figure 1-2365 Release the back edge of the cover

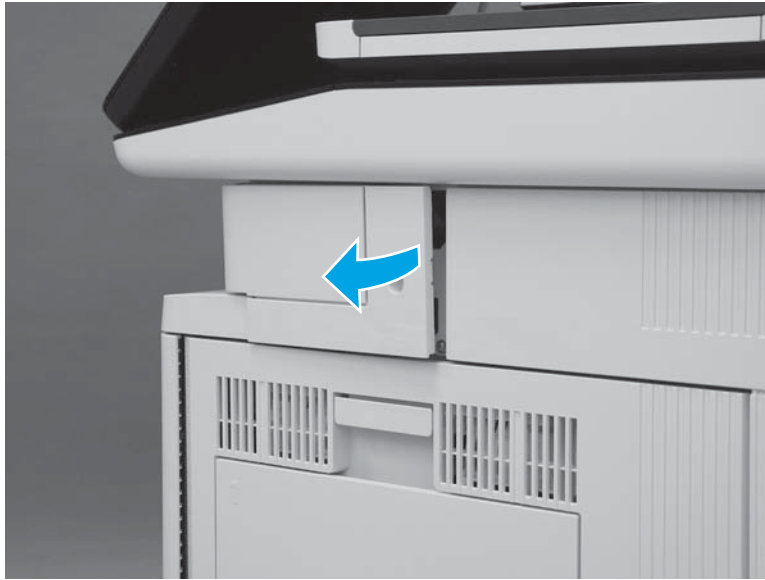



4. Rotate the cover away from the printer to remove it.

Figure 1-2366 Remove the cover



Step 16: Remove the integrated scanner assembly (ISA) (M577)

 **NOTE:** This step is for the M577 models. For the M552 and M553 models, skip this step and go to [Step 19: Remove the left cover on page 1356](#).

 **NOTE:** The ISA includes the document feeder, image scanner, scanner control board (SCB), control panel, keyboard (M577c/z) and NFC PCA (M577z).

1. At the left side of the printer, remove one screw (callout 1).

Figure 1-2367 Remove one screw

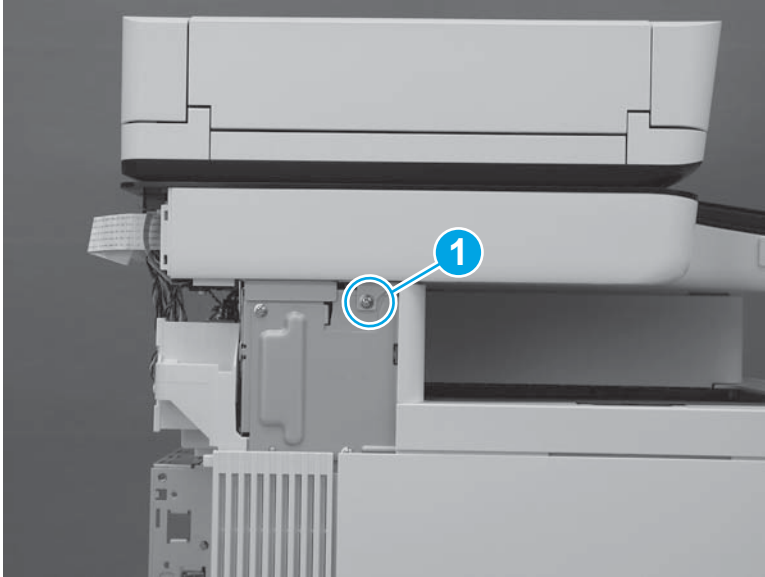

2. At the back side of the printer, remove two screws (callout 1).

Figure 1-2368 Remove two screws

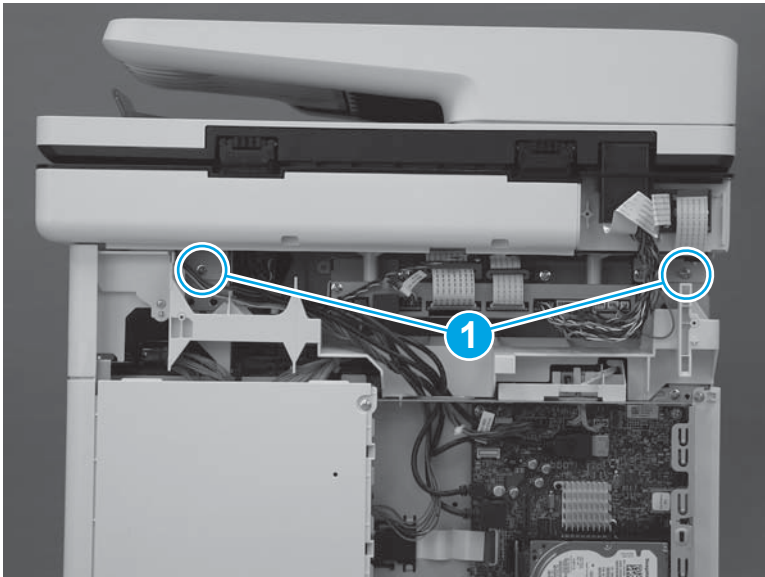

3. At the right side of the printer, remove one screw (callout 1).

Figure 1-2369 Remove one screw

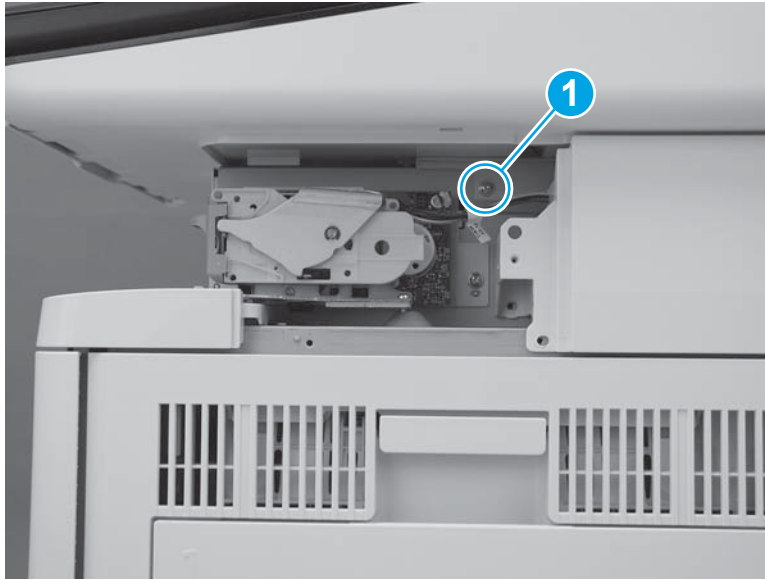

4. Disconnect two connectors on the scanner control board (callout 1).

M577c/f/z only: Disconnect one connector for the stapler on the scanner control board (callout 2).

Figure 1-2370 Disconnect connectors

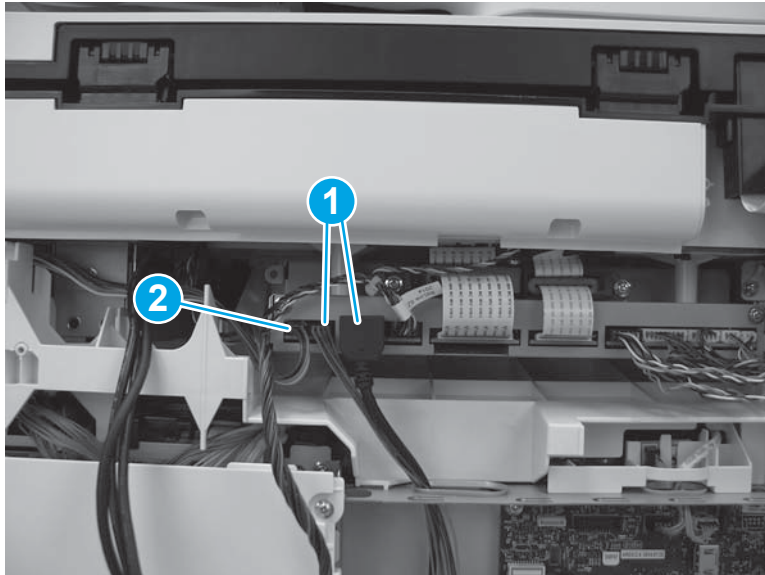

5. Slightly slide the ISA towards the back of the printer to release it.

Figure 1-2371 Slide the ISA towards the back of the printer

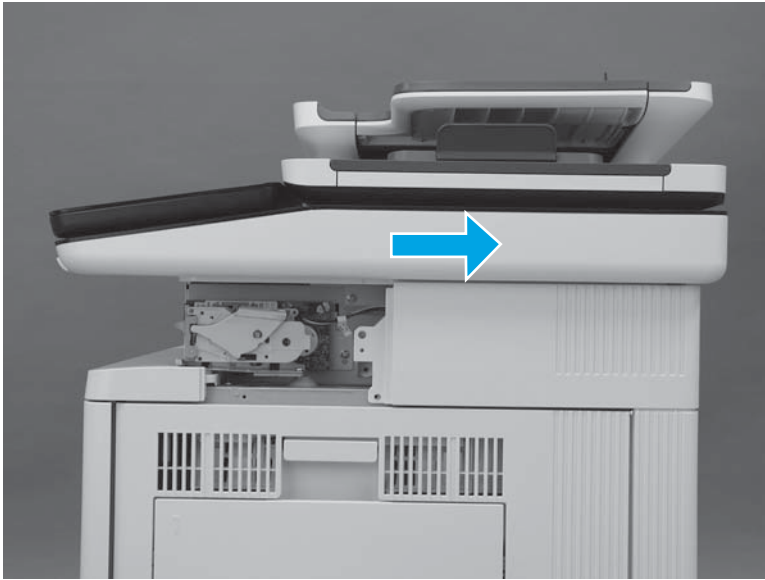

6. Lift the ISA up to remove it.



 **NOTE:** When lifting the ISA, carefully pass the cables through the opening in the top of the formatter case.

Figure 1-2372 Remove the ISA



Step 17: Remove the right upper cover (M577)

 **NOTE:** This step is for the M577 models. For the M552 and M553 models, skip this step and go to [Step 19: Remove the left cover on page 1356](#).

 **NOTE:** The figures below show the image scanner installed. The procedures for removing and installing the right upper cover are the same whether the image scanner is installed or removed."

1. At the right side of the printer, remove two screws (callout 1).

M577c/f/z only: Disconnect one connector (callout 2), if it was not already disconnected in a previous step.

Figure 1-2373 Remove two screws and one connector

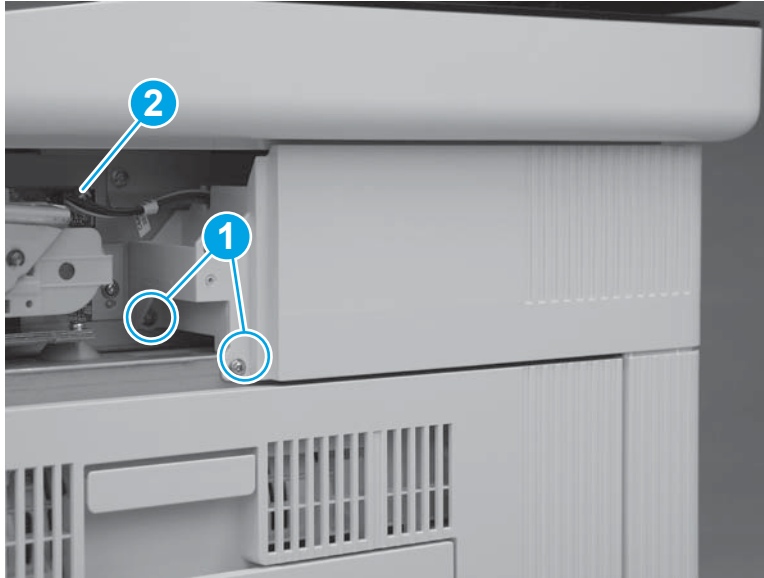

2. At the back of the printer, remove one screw (callout 1).

M577c/f/z only: Disconnect one connector (callout 2), if it was not already disconnected in a previous step.

 **Reinstallation tip:** This screw is smaller than the screws removed in the previous step. When reinstalling the right upper cover, make sure that this screw is installed in the correct position.

Figure 1-2374 Remove one screw and connector



3. Slide the cover toward the back of the printer.

Figure 1-2375 Slide the cover

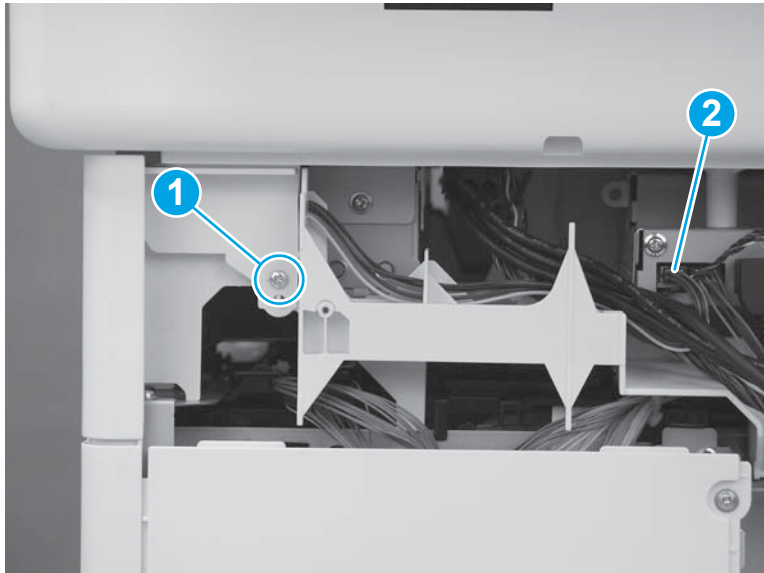
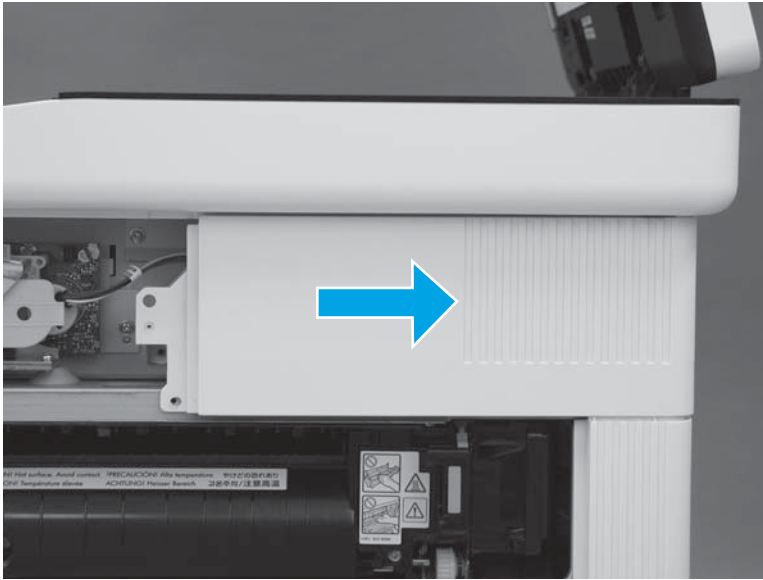

4. Lift the cover away from the printer to remove it.

M577c/f/z only: Release the cables (callout 1) through the slot (callout 2) in the printer.

Figure 1-2376 Remove the cover

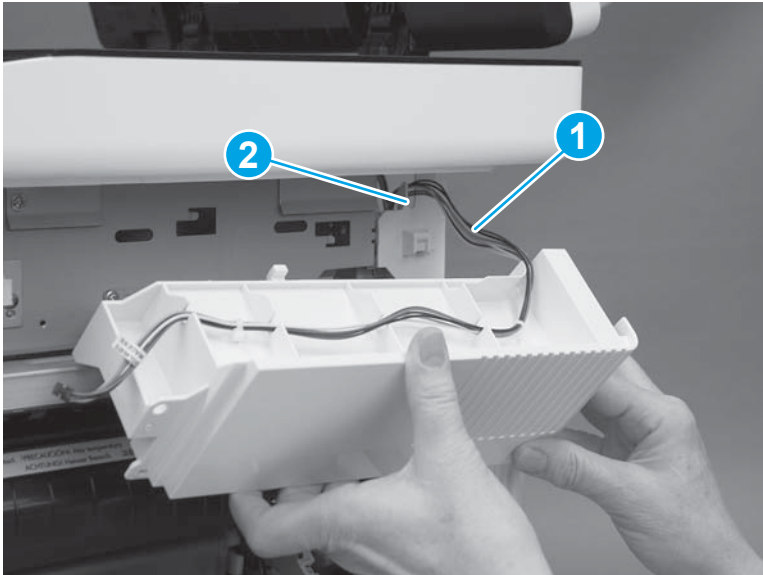

Step 18: Remove the top rear cover (M577)

 **NOTE:** This step is for the M577 models. For the M552 and M553 models, skip this step and go to [Step 19: Remove the left cover on page 1356](#).

1. At the front of the printer, remove one screw (callout 1).

 **Reinstallation tip:** This screw is longer and a different type of screw than the screw removed in the next step. When reinstalling the top cover, make sure that this screw is installed in the correct position.

Figure 1-2377 Remove one screw



2. At the left side of the printer, remove one screw (callout 1).

Figure 1-2378 Remove one screw

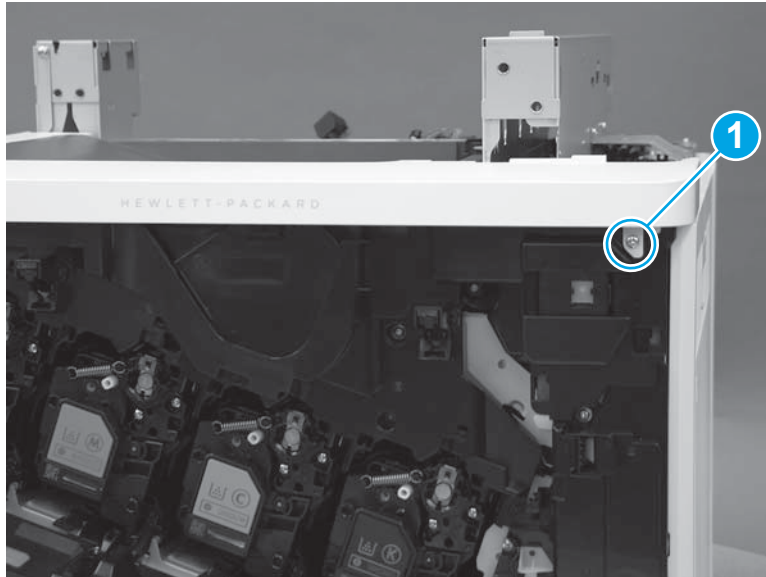
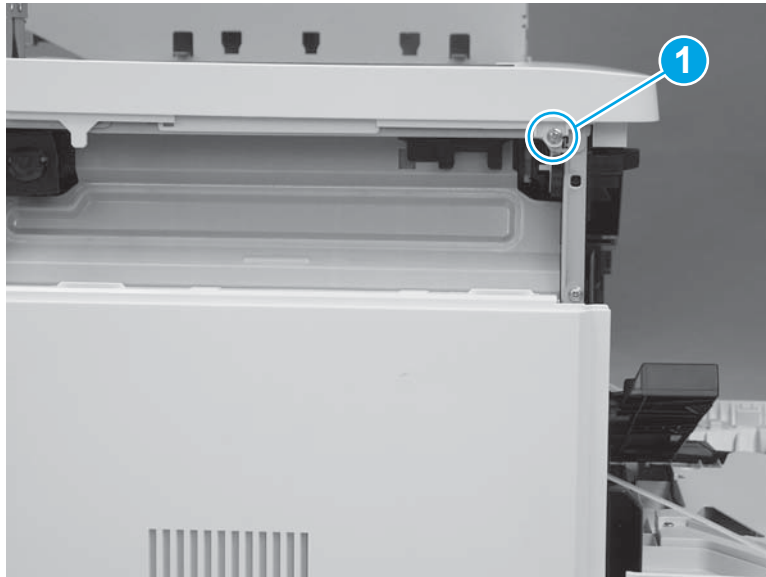

3. At the front of the printer, release one tab (callout 1).

Figure 1-2379 Release one tab

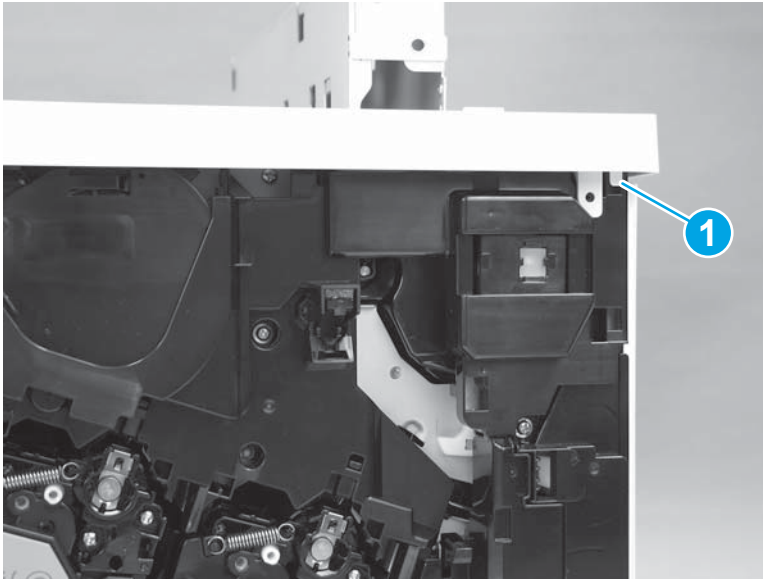

4. At the top of the printer, release two tabs (callout 1) next to the output bin, and then remove the top cover.

Figure 1-2380 Release two tabs

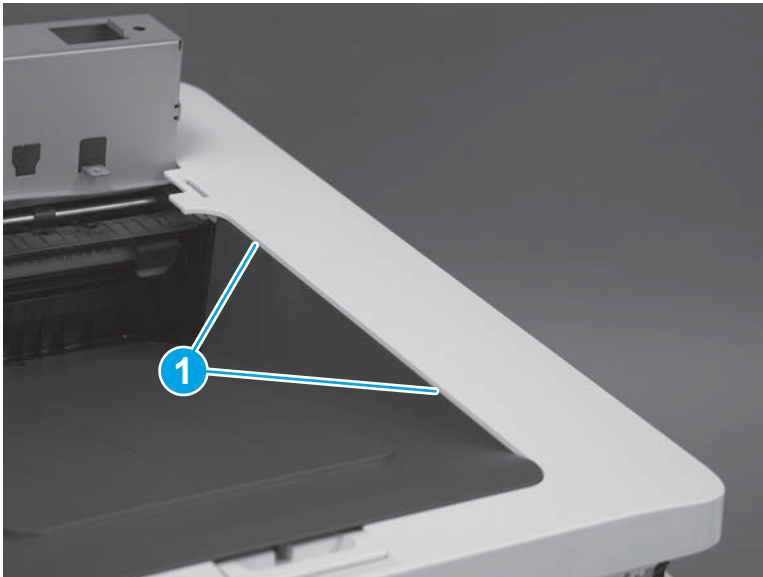

Step 19: Remove the left cover

1. At the left side of the printer, remove one screw (callout 1).

Figure 1-2381 Remove one screw



2. Release one tab (callout 1), rotate the front edge of the cover away from the printer (callout 2), and then slide the cover (callout 3) toward the rear of the printer to release it.

Figure 1-2382 Release the cover

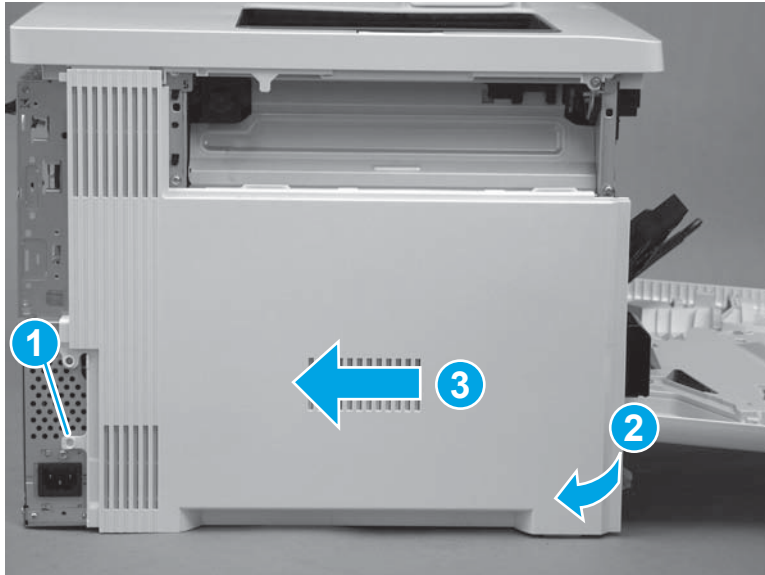

3. Remove the cover.

Figure 1-2383 Remove the cover

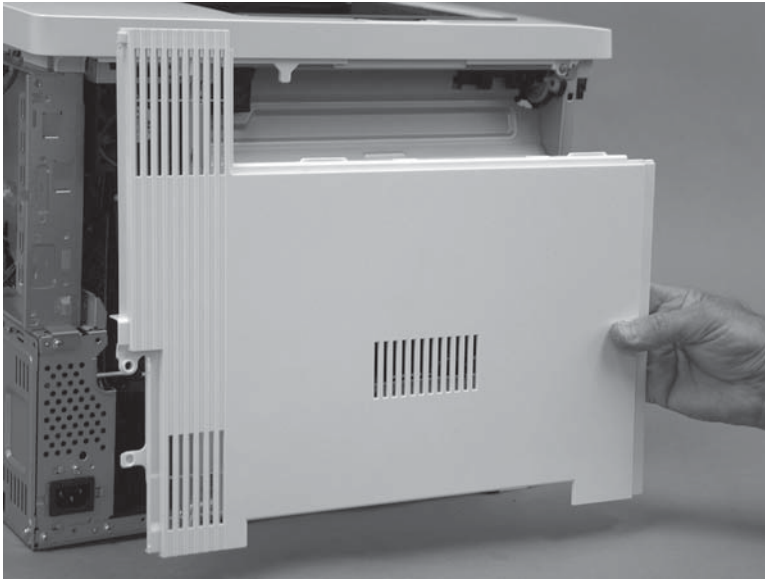

Step 20: Remove the upper cover (M552 and M553)



NOTE: This step is for the M552 and M553 models. For the M577 models, skip this step and go to [Step 21: Remove the formatter case on page 1360](#).

1. Remove three screws (callout 1).

Figure 1-2384 Remove three screws

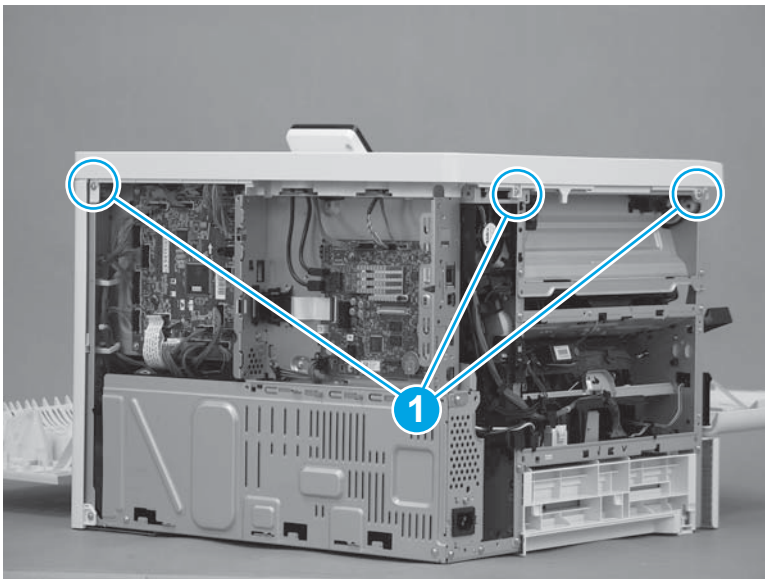

2. Remove one screw (callout 1), release one tab (callout 2), and then slightly separate the corner of the cover from the chassis.

 **NOTE:** This is a self-tapping plastic-thread screw. Make sure that this screw is used in this location when it is reinstalled.

Figure 1-2385 Remove one screw and release one tab



3. Release one tab (callout 1), and then lift up on the cover to release it.

 **NOTE:** If the cover does not release, check for additional tabs by locating the triangles embossed in the cover at tab locations.

Figure 1-2386 Release the cover



4. Remove the cover.

Figure 1-2387 Remove the cover

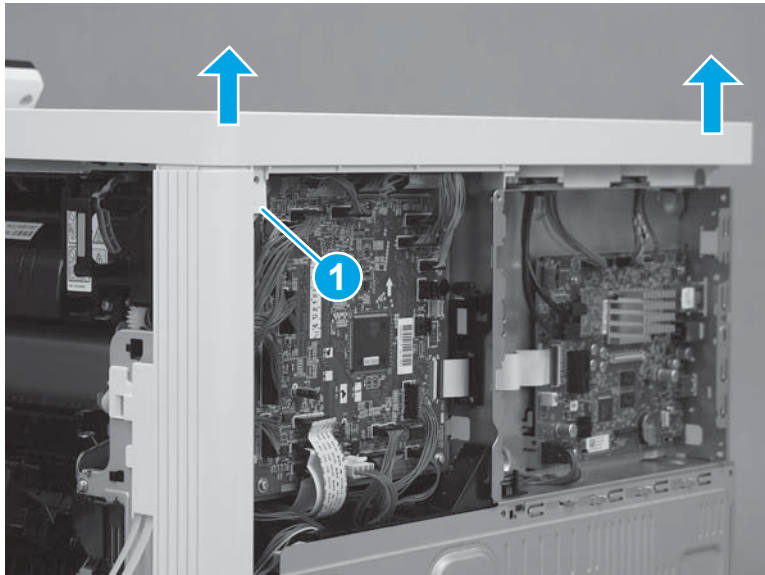
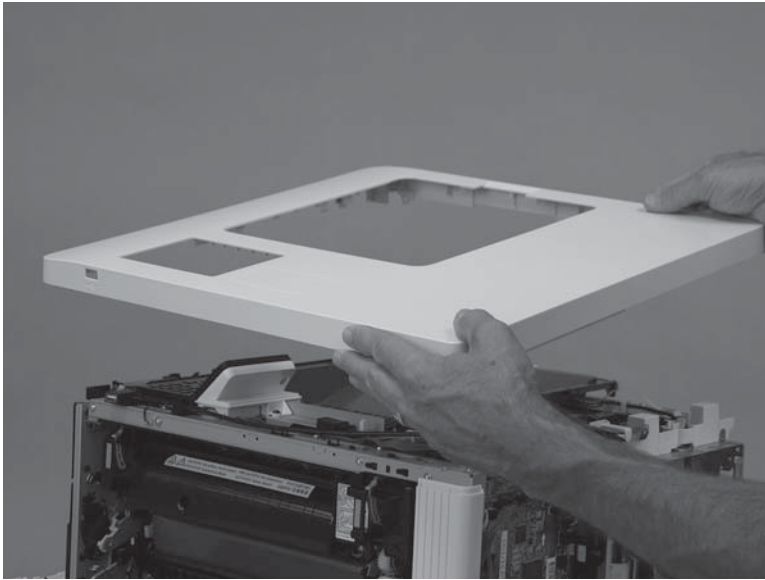

Step 21: Remove the formatter case

1. **M577 only:** Disconnect one connector (callout 1), and then pass the wire harness (callout 2) through two openings in the formatter case (callout 3).

Figure 1-2388 Disconnect one connector

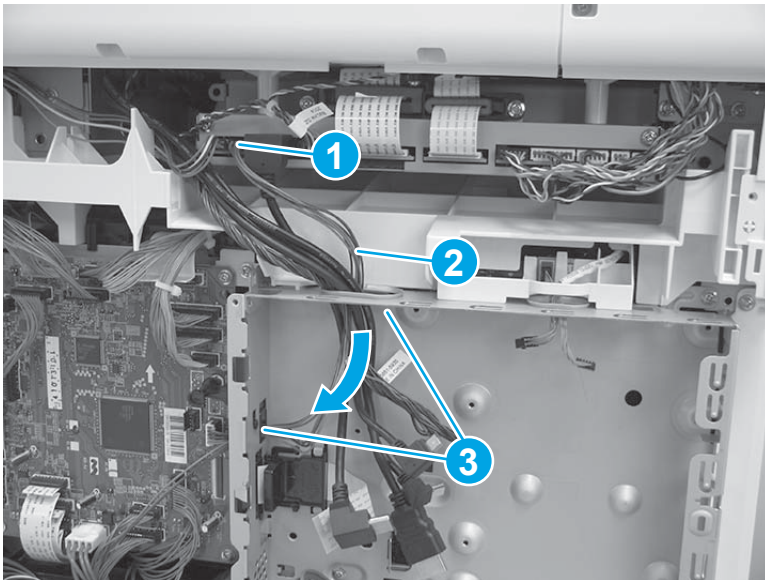

2. Release two tabs (callout 1) on the black plastic bracket. Hold the tabs in the released position, and then slide the bracket (callout 2) to the right to remove it from the formatter case.

Figure 1-2389 Remove the bracket

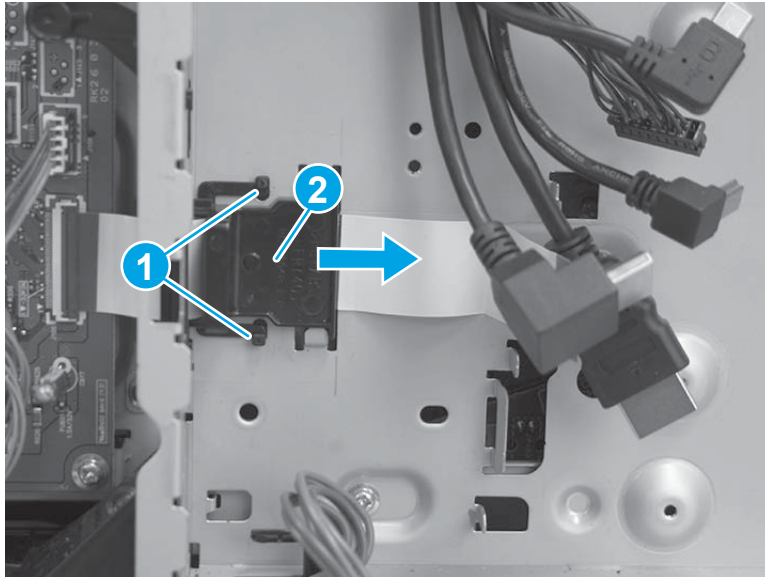

3. Remove two screws (callout 1), and then slide the low-voltage power supply (LVPS) cover to the right to remove it.

Figure 1-2390 Remove the LVPS cover

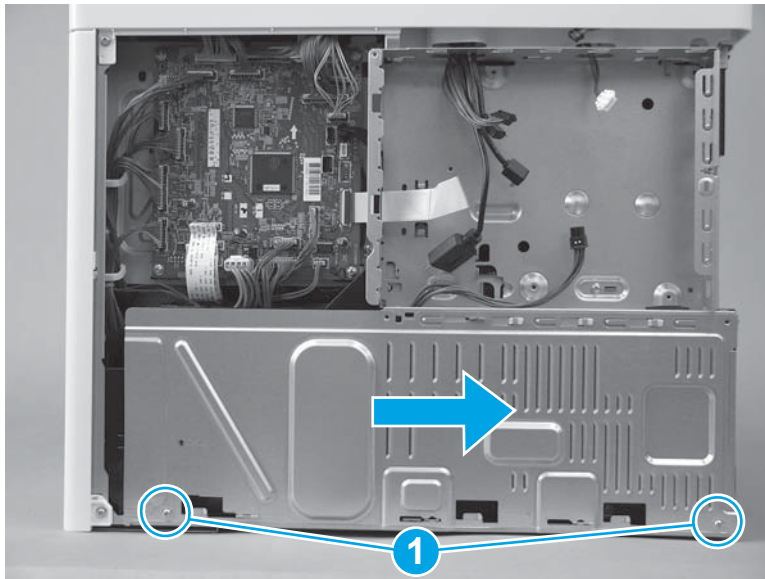

4. Pass two wire harnesses and one flat cable (callout 1) through the opening in the formatter case, and then release one wire harness from the retainer (callout 2).

⚠ CAUTION: The flat cable might be attached to the formatter case with double-sided tape. Make sure that this tape is released, so that the flat cable is not damaged when the formatter case is removed.

Figure 1-2391 Release wire harnesses and flat cable

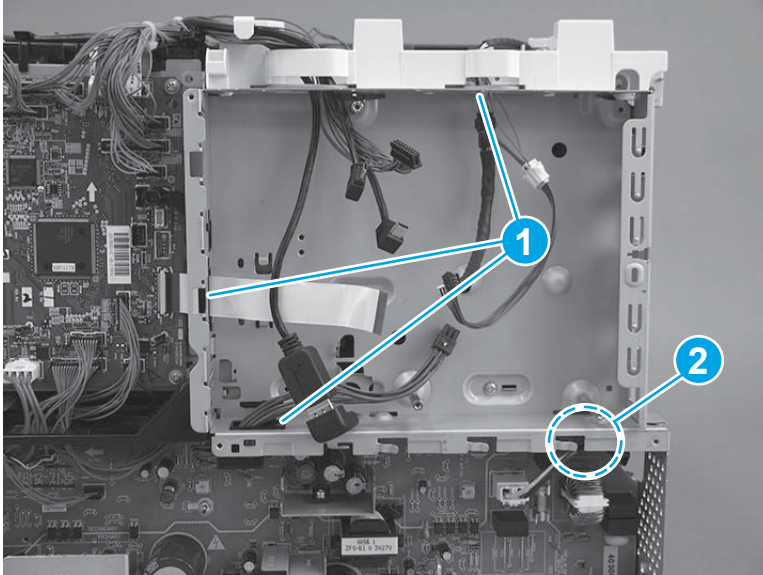

5. Remove six screws (callout 1).

Figure 1-2392 Remove six screws

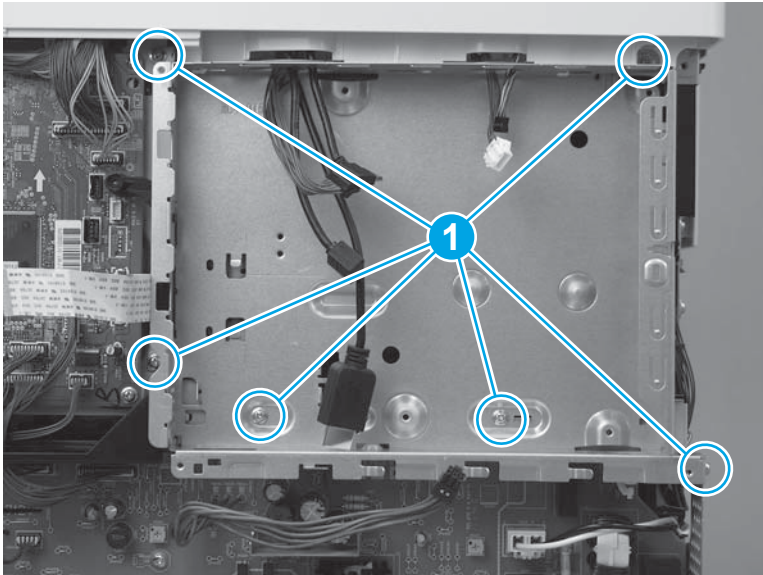

6. Rotate the bottom of the formatter case away from the printer (callout 1), and then pull it down (callout 2) to release it.

Figure 1-2393 Release the formatter case

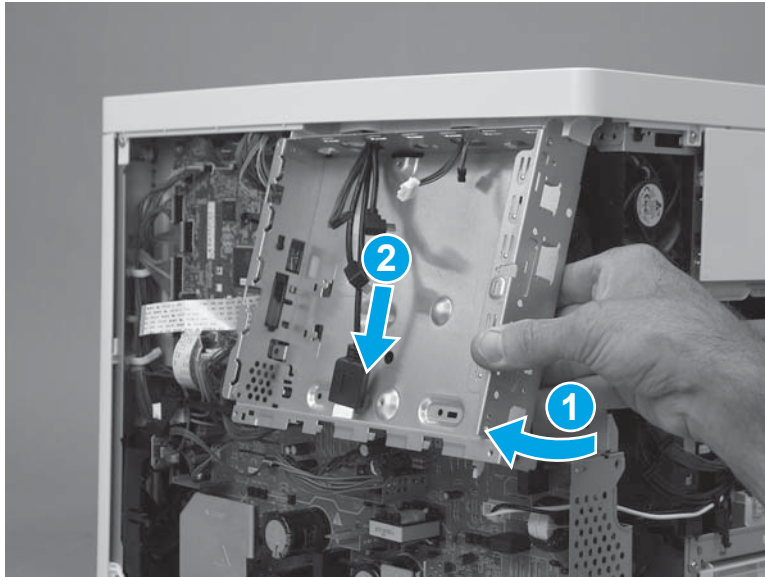

7. Pass the wire harnesses through the opening in the formatter case to remove it.

 **IMPORTANT:** If the formatter case is removed so that it can be replaced, make sure to transfer the memory PCA (island of data) and plastic bracket (callout 1) to the replacement case.

Figure 1-2394 Remove the formatter case



Step 22: Remove the delivery fan (FM3)

1. Disconnect one connector (callout 1).

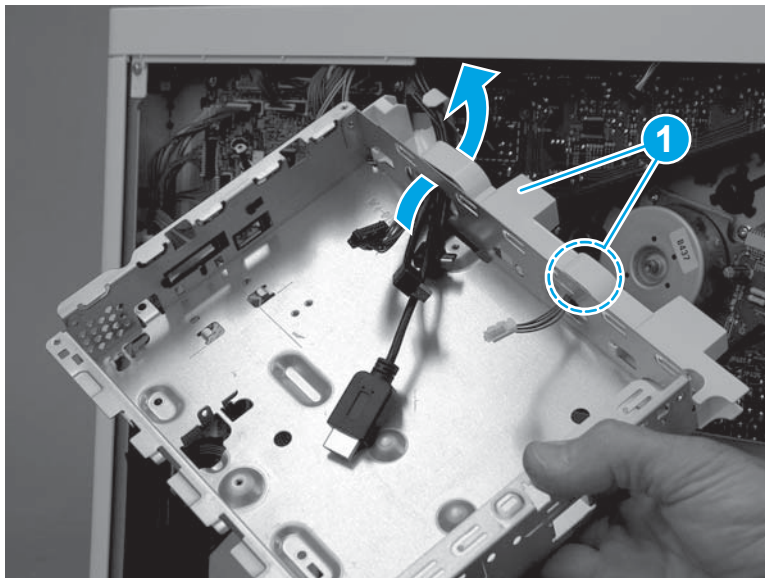
Figure 1-2395 Disconnect one connector

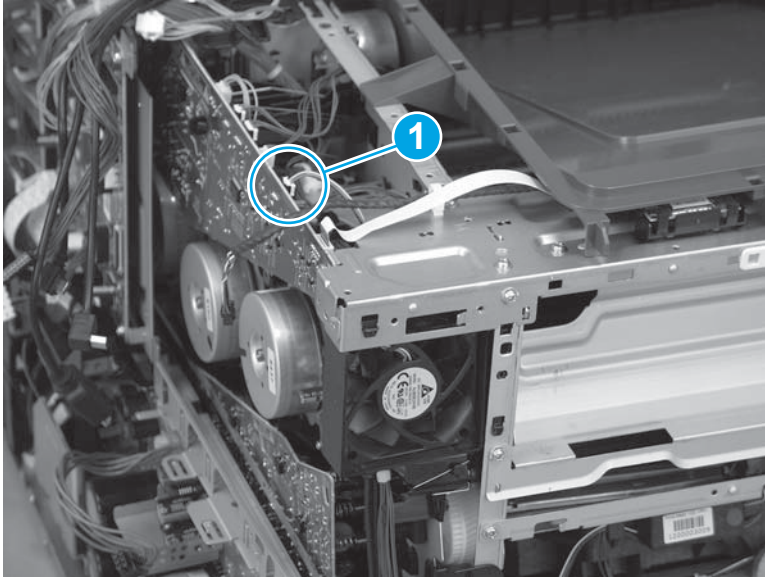

2. Remove one screw (callout 1).

 **NOTE:** This screw does not secure the fan to the chassis. However it is necessary to remove it so that the corner of the high-voltage power supply T (HVPST) can be moved out of the way to remove the fan.

Figure 1-2396 Remove one screw



3. Slide the fan up to release it.

Figure 1-2397 Release the fan

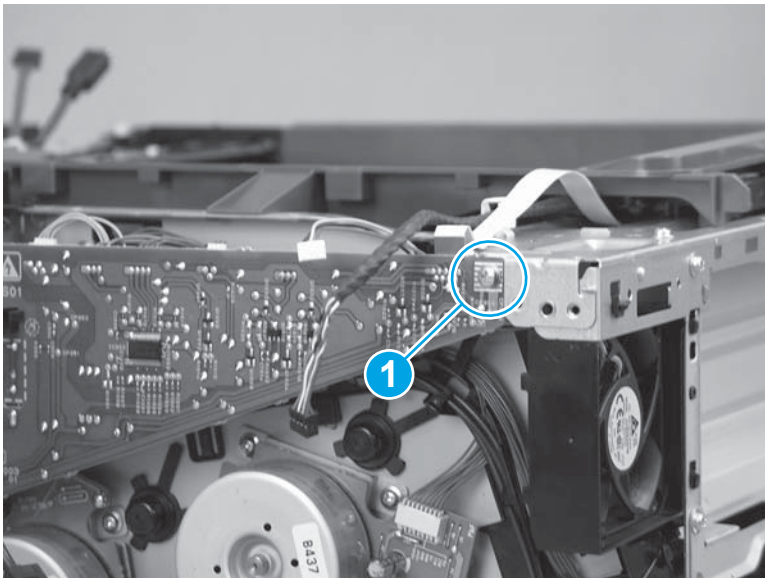
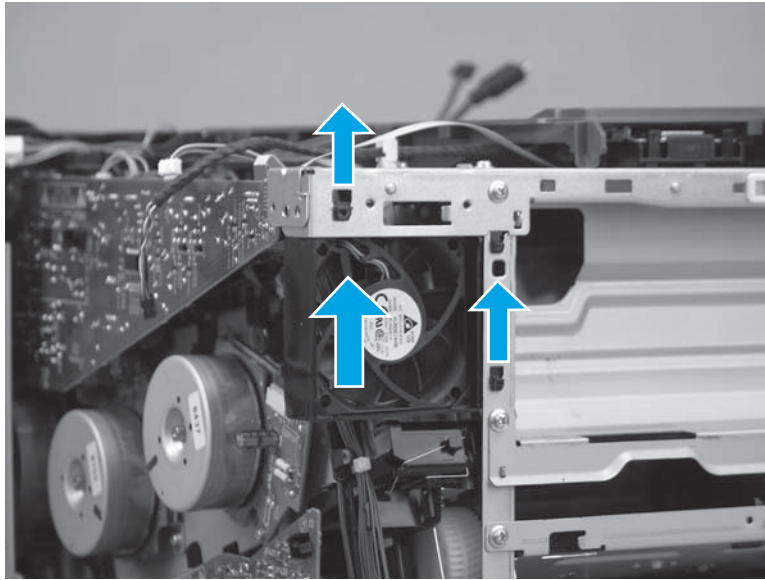

4. Slightly flex the corner of the HVPST out of the way (callout 1), and then remove the fan.

CAUTION: Do not over flex the HVPST and damage it.

NOTE: Look at the arrows embossed on the fan or the holder. When a replacement fan is installed, make sure that the embossed arrows face the correct direction.

Figure 1-2398 Remove the fan

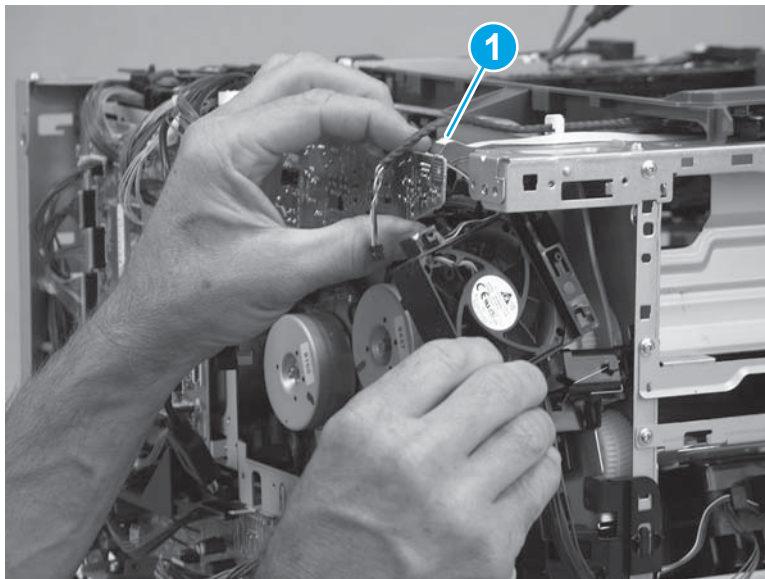

Step 23: Unpack the replacement assembly

Unpack the replacement assembly from the packaging.

For complete information on HP's recycling programs, go to [Product return and recycling](#).

 **NOTE:** HP recommends responsible disposal of the defective assembly.

Figure 1-2399 Recycle and unpack

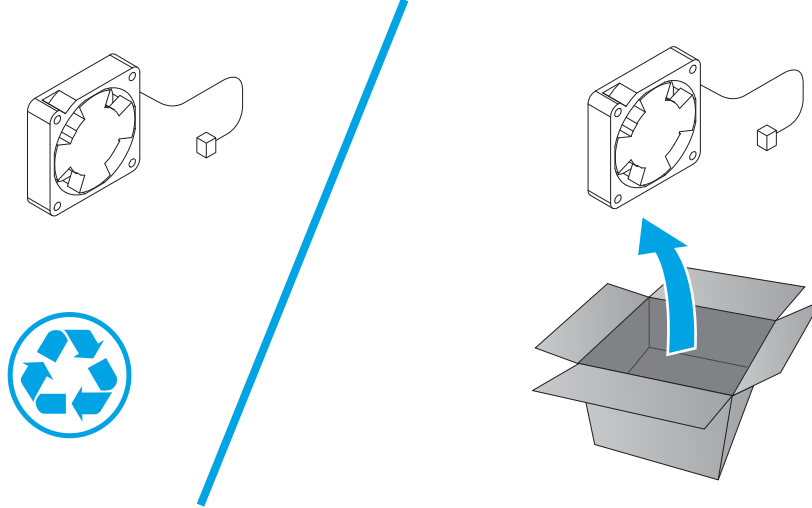

Step 24: Install the delivery fan (FM3)

1. Slightly flex the corner of the HVPST out of the way (callout 1), and then install the fan.

 **CAUTION:** Do not over flex the HVPST and damage it.

 **NOTE:** Make sure that the arrows embossed on the fan face the correct direction.

Figure 1-2400 Install the fan



2. Slide the fan down to engage it with the chassis.

Figure 1-2401 Engage the fan with the chassis

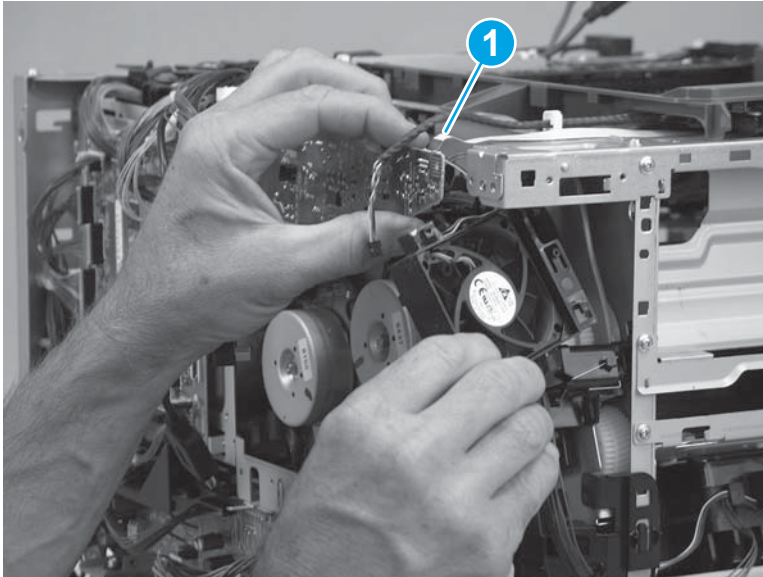
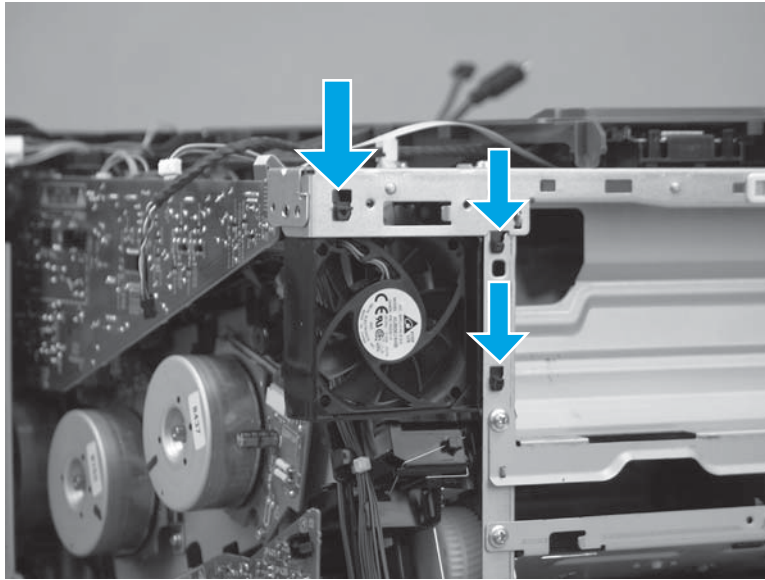

3. Install one screw (callout 1).

Figure 1-2402 Install one screw

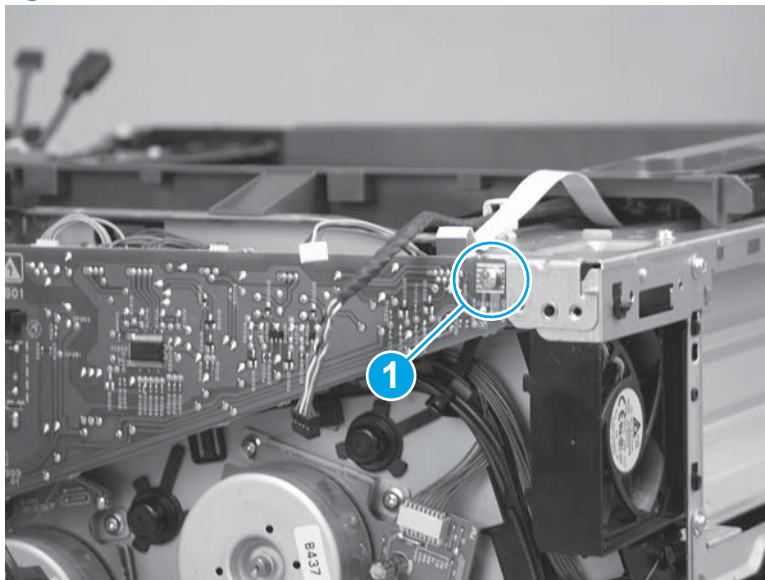

4. Connect one connector (callout 1).

Figure 1-2403 Connect one connector

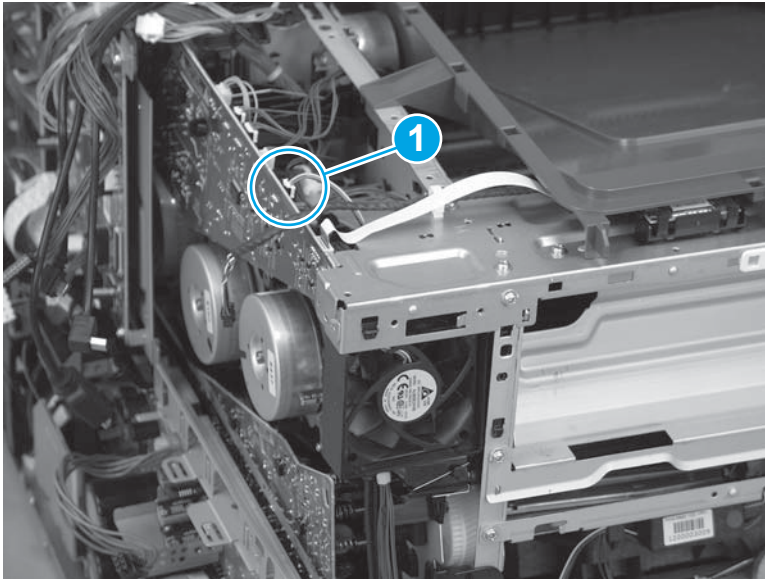

Step 25: Install the formatter case

1. Pass the wire harnesses through the opening in the formatter case.

Figure 1-2404 Pass the wire harnesses through the opening

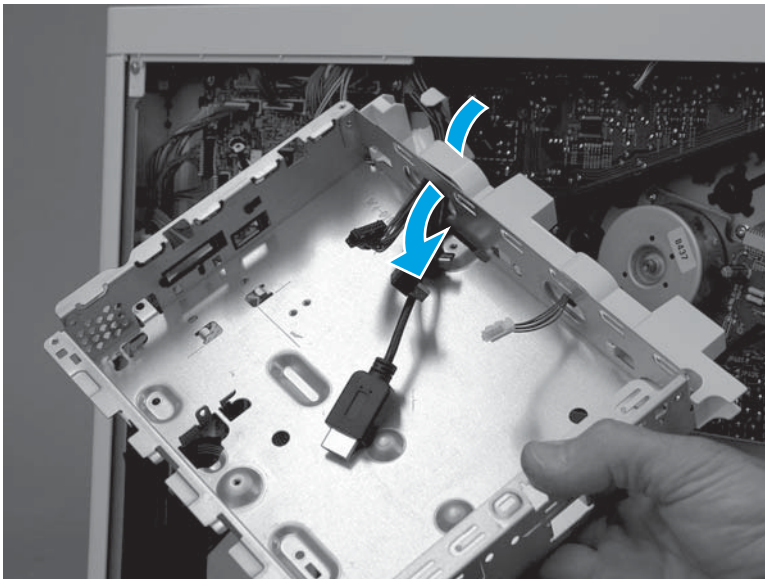

2. Position the top of the formatter case on the printer (callout 1), and then rotate the bottom of the case (callout 2) into the printer.

Figure 1-2405 Install the formatter case

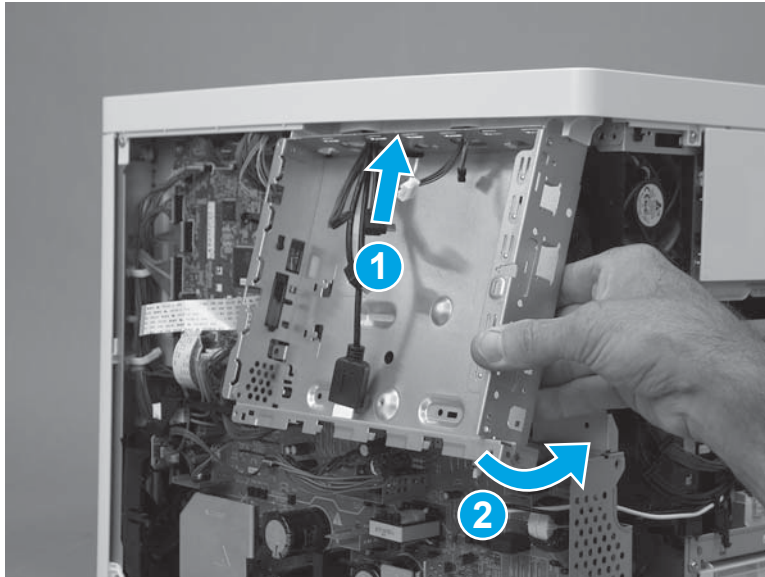

3. Install six screws (callout 1).

Figure 1-2406 Install six screws

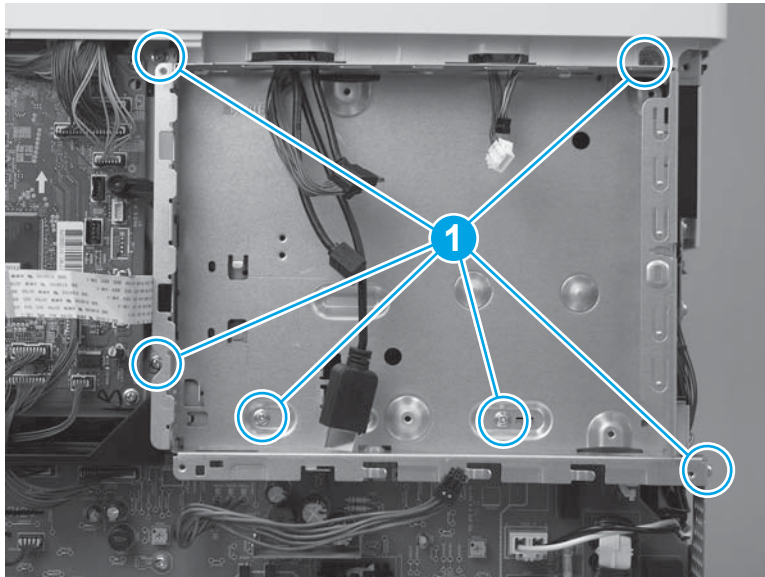

4. Pass two wire harnesses and one flat cable (callout 1) through the opening in the formatter case, and then install one wire harness in the retainer (callout 2).

 **IMPORTANT:** Make sure that the flat cable is securely fastened to the DC controller, and was not dislodged when the formatter case was removed.

Figure 1-2407 Install wire harnesses and flat cable



5. Position the LVPS cover on the printer, slide the cover to the left to install it, and then install two screws (callout 1).

Figure 1-2408 Install the LVPS cover

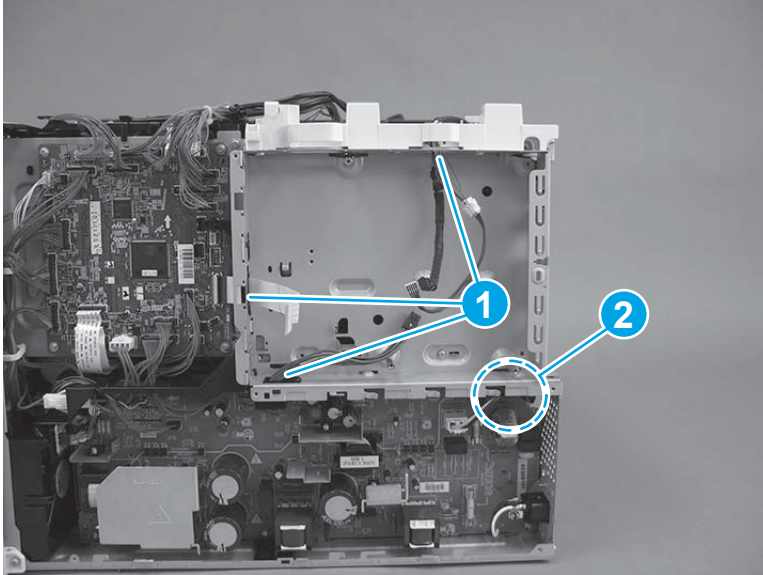
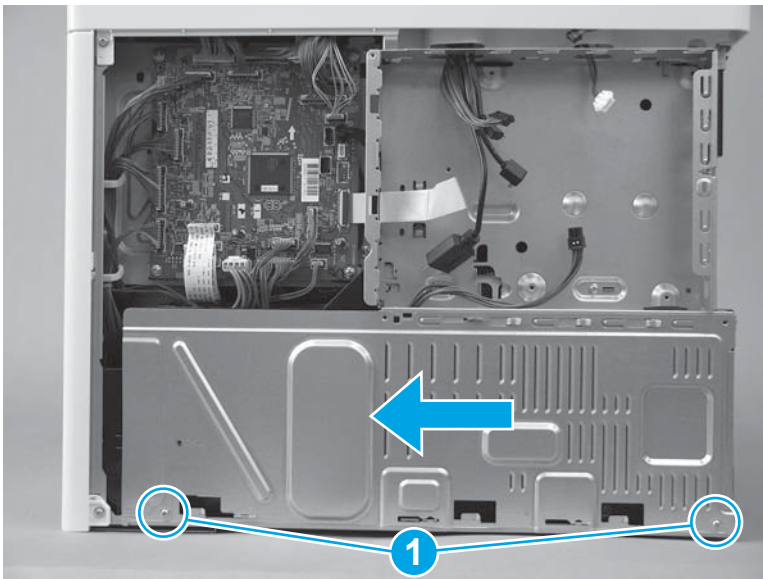

6. If no tape is affixed to the back of the flat cable, skip this step. If double-sided tape is affixed to the back of the flat cable, align the line (callout 1) on the cable with the edge (callout 2) of the opening in the sheet metal. Press to attach the flat cable to the formatter case.

Figure 1-2409 Attach the flat cable

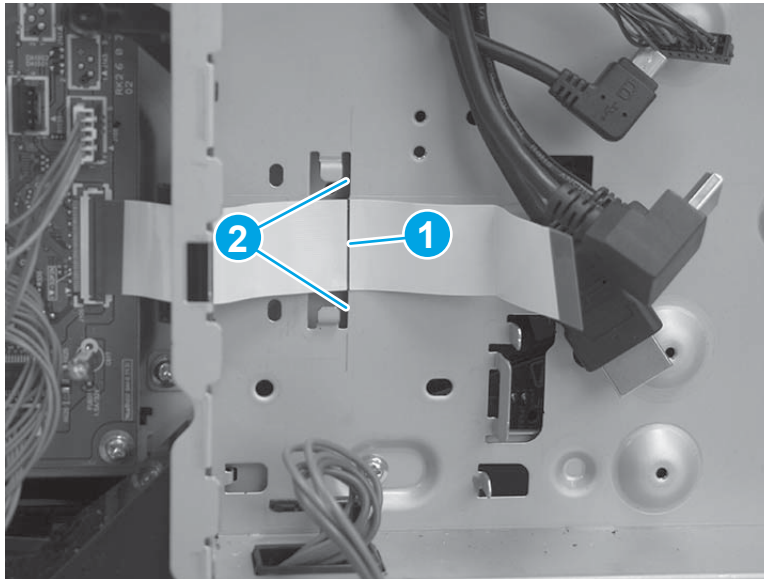

7. Position the bracket over the flat cable, and then slide the bracket to the left to install it. Make sure that the edges of the bracket fit under the sheet metal tabs (callout 1) on the formatter case and that the tabs (callout 2) snap into place.

Figure 1-2410 Position the bracket

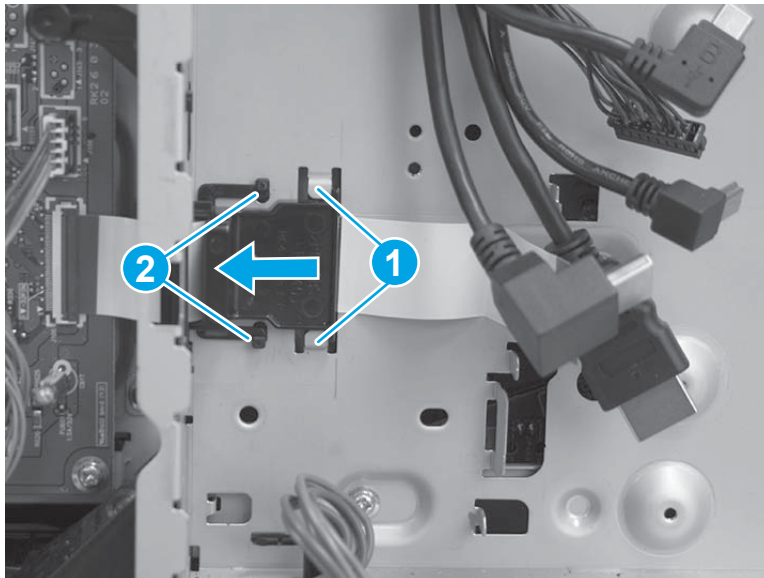

- 8. M577 only:** Pass the wire harness (callout 1) through the openings in the formatter case (callout 2), and then connect one connector (callout 3).

Figure 1-2411 Connect one connector

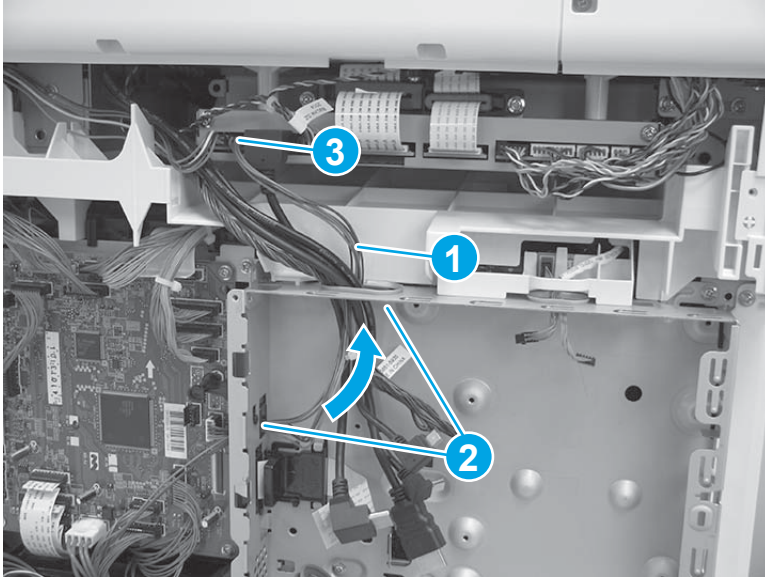

Step 26: Install the upper cover (M552 and M553)

 **NOTE:** This step is for the M552 and M553 models. For the M577 models, skip this step and go to [Step 27: Install the left cover on page 1374](#).

1. Position the cover on the printer.

 **NOTE:** For the M553x model, do not forget to pass the control-panel wire harness and USB cable through the opening in the cover.

Figure 1-2412 Install the cover



2. Push down on the rear corner of the cover to engage one tab (callout 1).

Figure 1-2413 Engage one tab

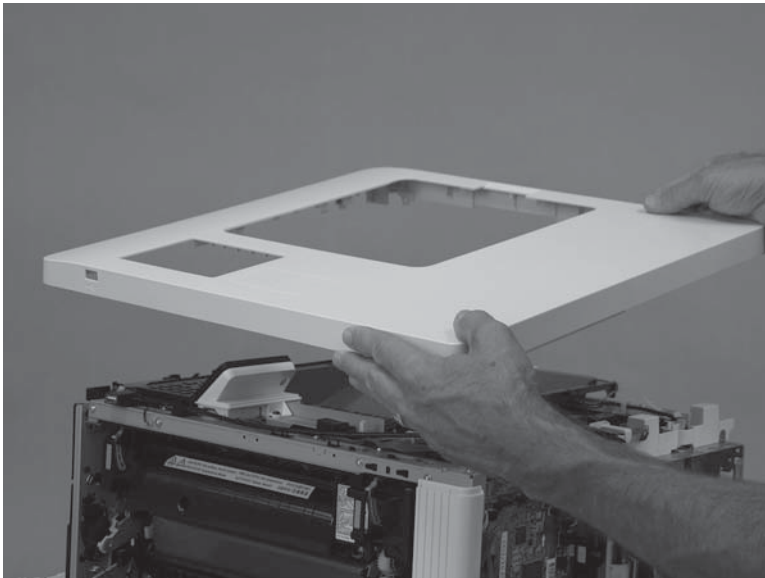
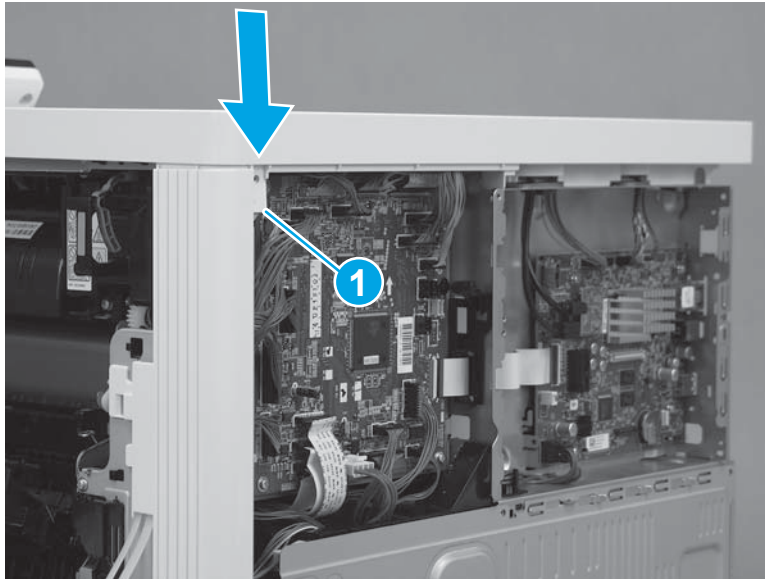

3. Push down on the front corner of the cover to engage one tab (callout 1), and then install one screw (callout 2).

 **NOTE:** This is a self-tapping plastic-thread screw. Make sure that this screw is used in this location when it is reinstalled.

Figure 1-2414 Engage one tab and install one screw



4. Install three screws (callout 1).

Figure 1-2415 Install three screws

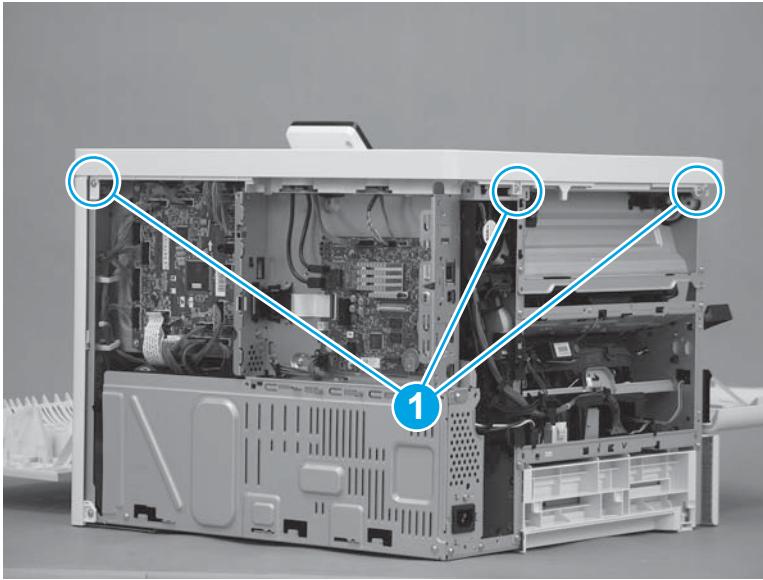

Step 27: Install the left cover

1. Position the cover on the printer.

 **NOTE:** Slightly offset the cover toward the rear of the printer.

Figure 1-2416 Install the cover

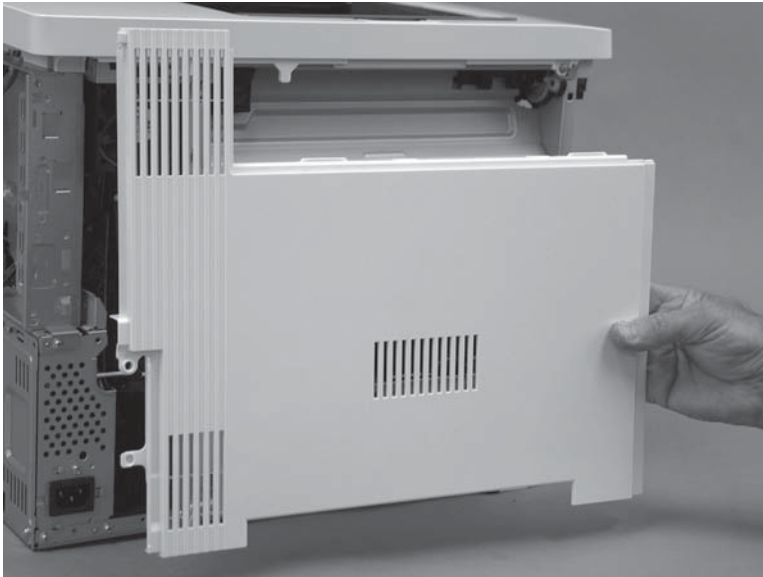

- Slide the cover (callout 1) toward the front of the printer to engage it. Make sure that the tab (callout 2) snaps into place.

 **NOTE:** Locate the alignment pin (callout 3) on the cover from the front door side of the printer, and then make sure that it is fully engaged in the slot in the chassis.

 **TIP:** While sliding the cover into place, push in on the center of the cover (callout 1) to make sure that the hooks on the back of the cover engage with the slots in the chassis.

Figure 1-2417 Engage the cover



- At the left side of the printer, install one screw (callout 1).

Figure 1-2418 Install one screw

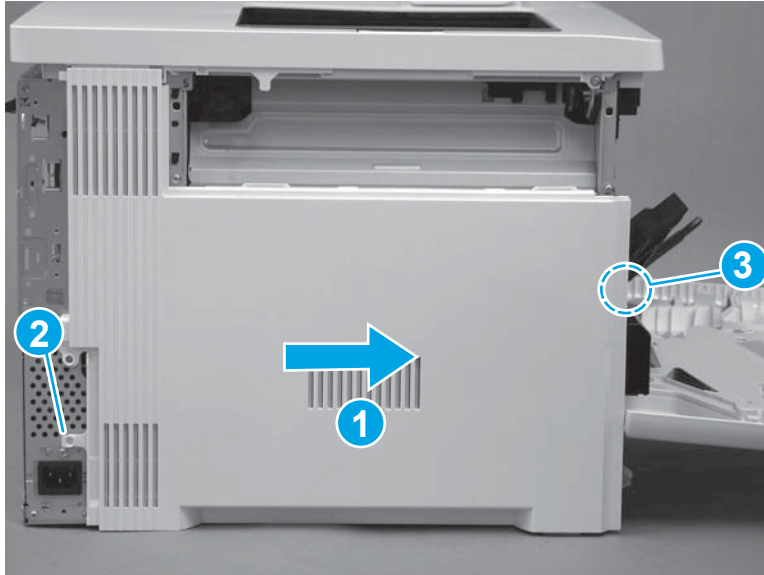
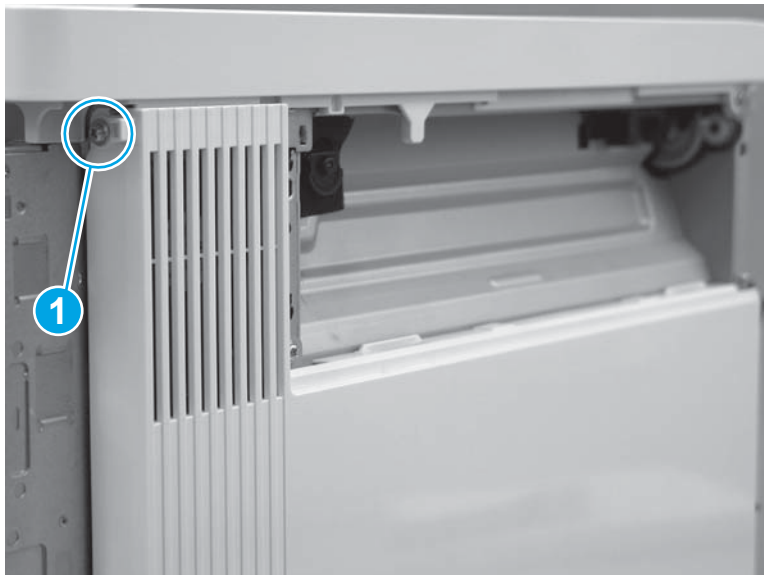

Step 28: Install the top rear cover (M577)

 **NOTE:** This step is for the M577 models. For the M552 and M553 models, skip this step and go to [Step 36: Install the rear cover \(M552 and M553\) on page 1392](#).

1. Position the locator pins (callout 1) on the cover in the slots (callout 2) in the printer.

Figure 1-2419 Position the locator pins

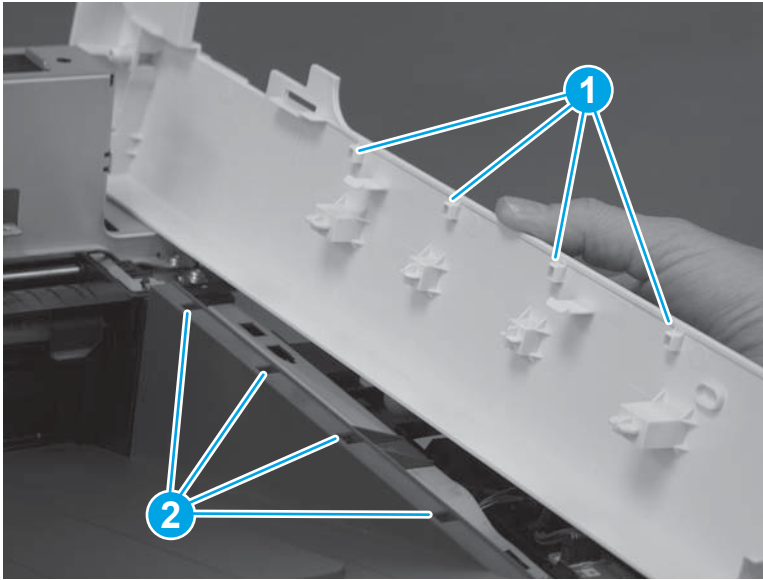

2. Press down on the cover to install it. Make sure that the tabs (callout 1) snap into place.

Figure 1-2420 Press down on the cover

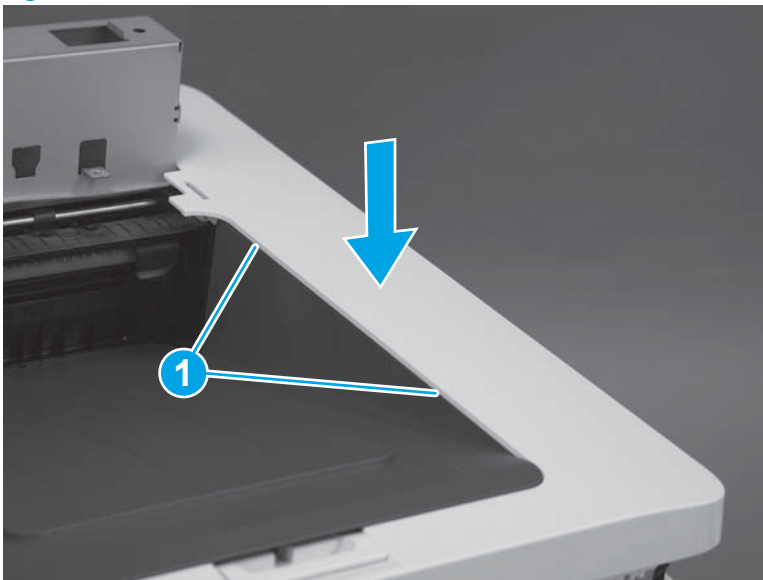

3. At the front of the printer, install one screw (callout 1).

 **Reinstallation tip:** This screw is longer and a different type of screw than the screw installed in the next step. Make sure that this screw is installed in the correct position.

Figure 1-2421 Install one screw



4. At the left side of the printer, install one screw (callout 1).

Figure 1-2422 Install one screw

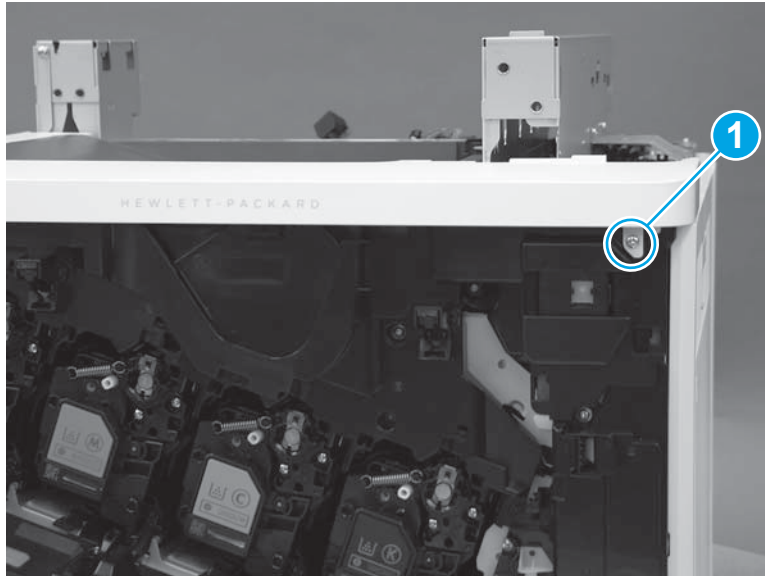
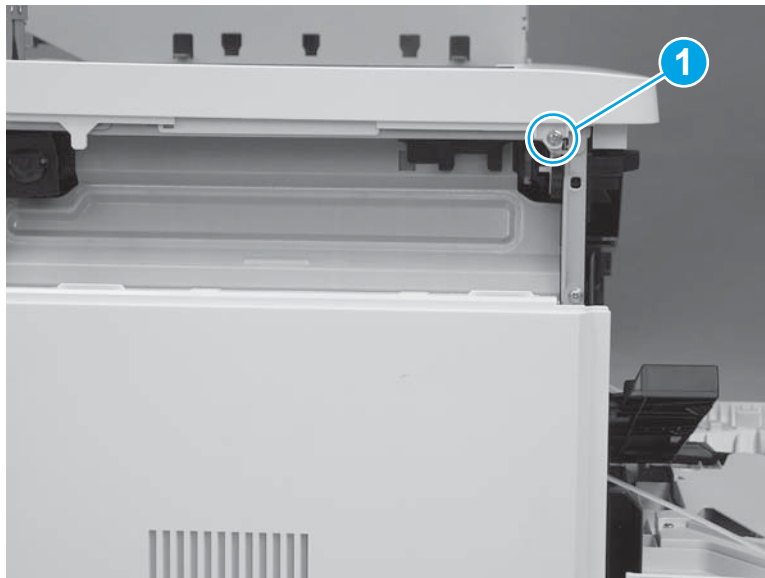

Step 29: Install the right upper cover (M577)

 **NOTE:** This step is for the M577 models. For the M552 and M553 models, skip this step and go to [Step 36: Install the rear cover \(M552 and M553\) on page 1392.](#)



NOTE: The figures below show the image scanner installed. The procedures for removing and installing the right upper cover are the same whether the image scanner is installed or removed."

1. **M577c/f/z only:** Install the cables (callout 1) through the slot (callout 2) in the printer.

Figure 1-2423 Install the cables

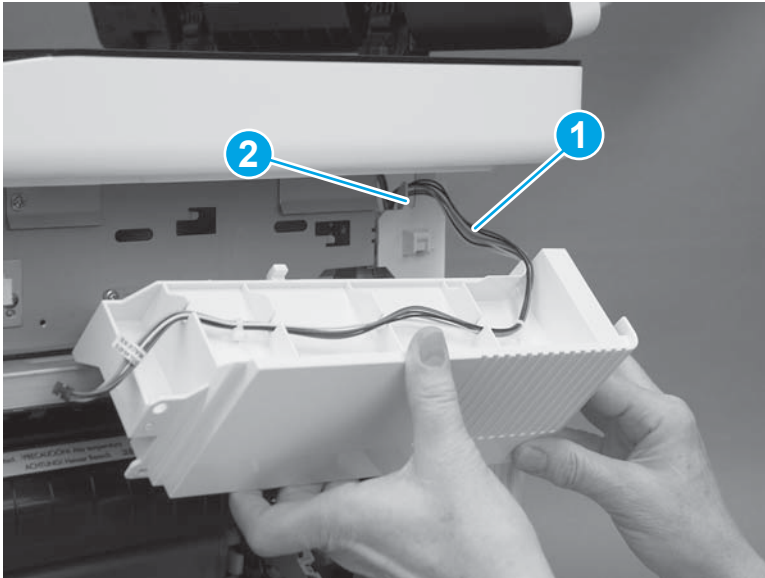

2. Position the hooks (callout 1) on the cover in the slots (callout 2) in the printer.

Figure 1-2424 Position the hooks

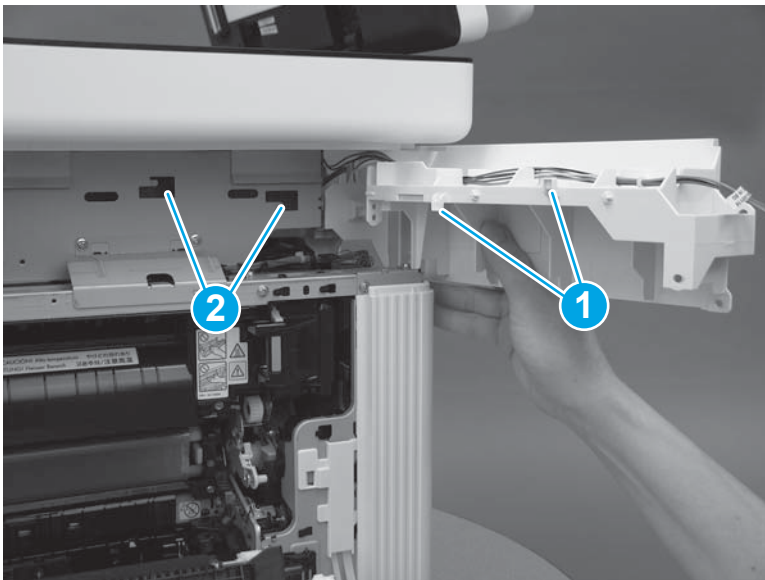

3. Slide the cover toward the front of the printer to install it.

Figure 1-2425 Install the cover

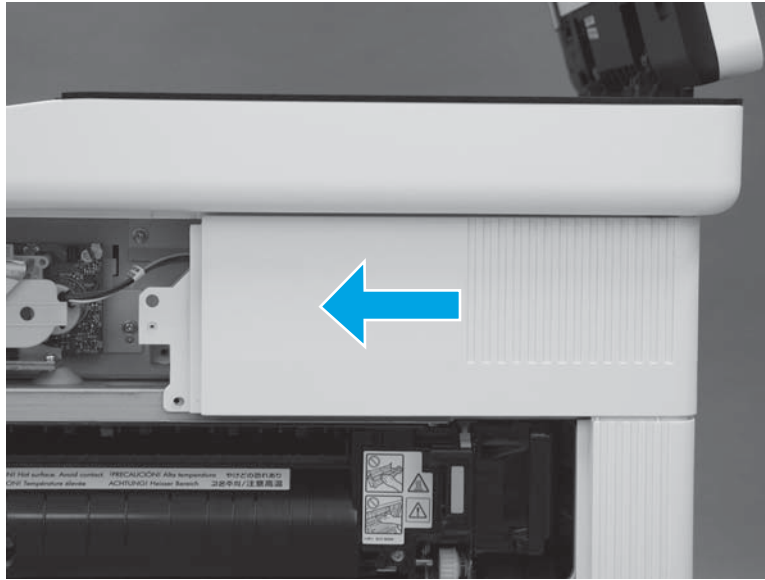

4. At the back of the printer, install one screw (callout 1).

M577c/f/z only: Connect one connector (callout 2), if the integrated scanner assembly is installed.

 **TIP:** This screw is smaller than the screws installed in the next step. Make sure that this screw is installed in the correct position.

Figure 1-2426 Install one screw and connector



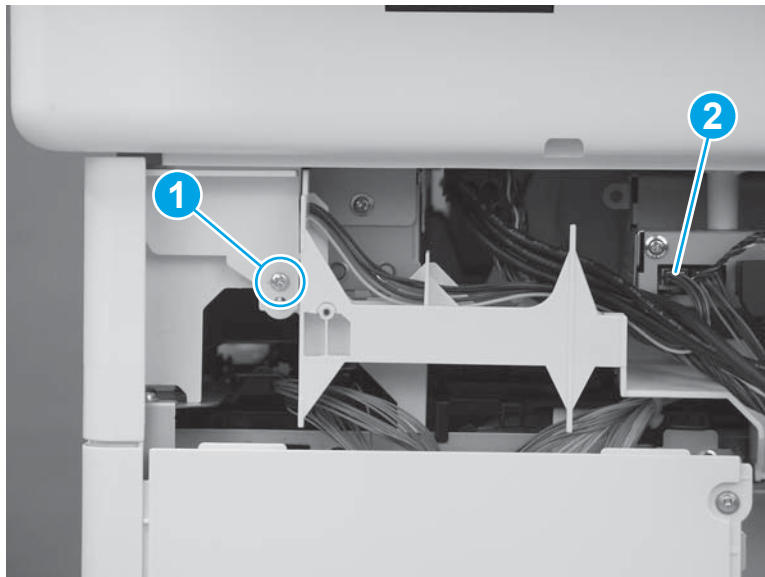
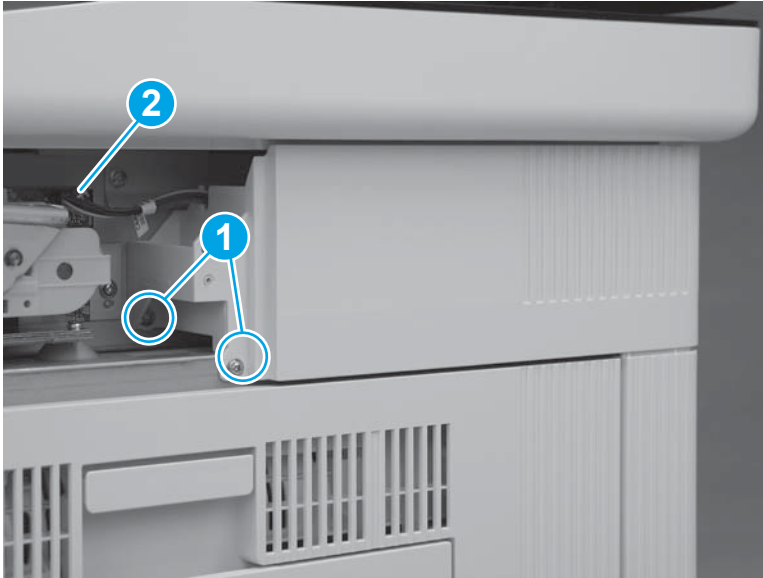

5. At the right side of the printer, install two screws (callout 1).
M577c/f/z only: Connect one connector (callout 2), if the stapler is installed.

Figure 1-2427 Install one screw and connector



Step 30: Install the integrated scanner assembly (ISA) (M577)

-
-  **NOTE:** This step is for the M577 models. For the M552 and M553 models, skip this step and go to [Step 36: Install the rear cover \(M552 and M553\) on page 1392](#).
-
-  **NOTE:** The ISA includes the document feeder, image scanner, scanner control board (SCB), control panel, keyboard (M577c/z) and NFC PCA (M577z).
-

1. Before proceeding, locate the mounting pins (callout 1) on the bottom of the ISA and the slots (callout 2) on the printer base.

Figure 1-2428 Locate the ISA mounting pins and slots

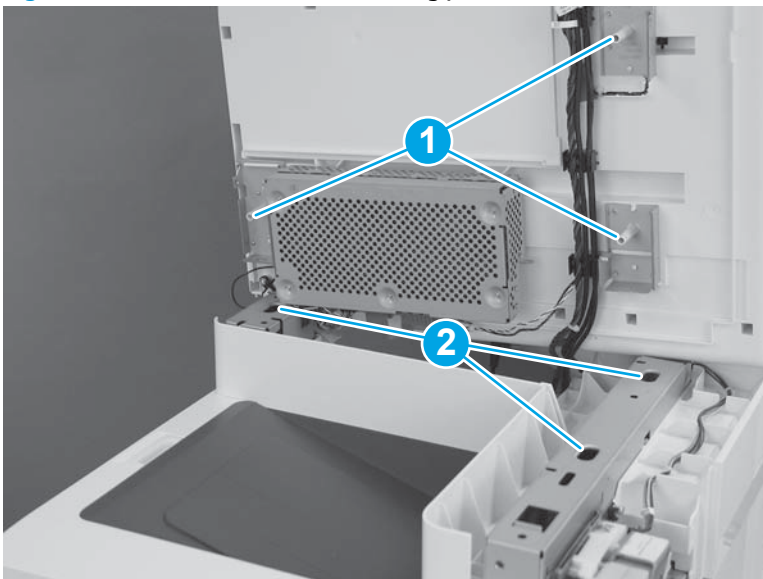

2. Position the ISA on the printer base with the pins in the slots.

 **NOTE:** To locate the pins and slots, see [Figure 1-395 Locate the ISA mounting pins and slots on page 250](#).

When installing the ISA, carefully pass the cables through the opening in the top of the formatter case.

Figure 1-2429 Install the ISA



3. Slightly slide the ISA towards the front of the printer to engage it.

Figure 1-2430 Slide the ISA towards the front of the printer

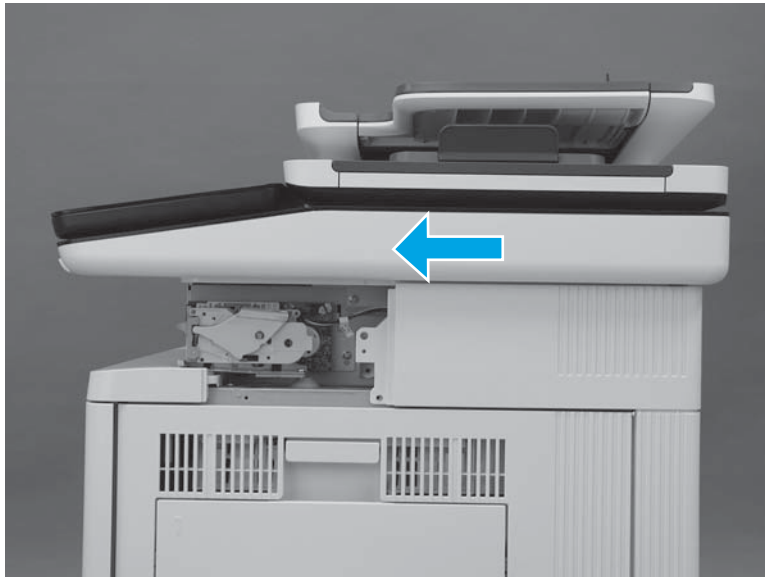

4. At the left side of the printer, install one screw (callout 1).

Figure 1-2431 Install one screw

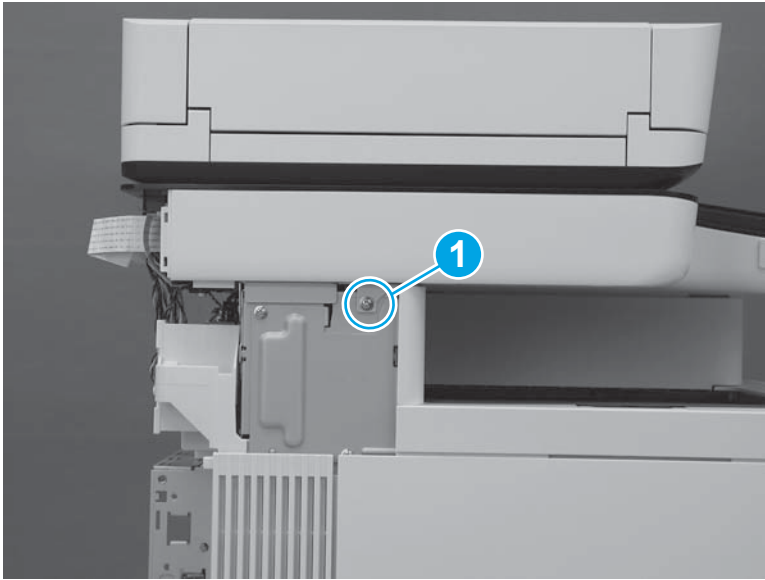

5. At the back of the printer, install two screws (callout 1).

Figure 1-2432 Install two screws

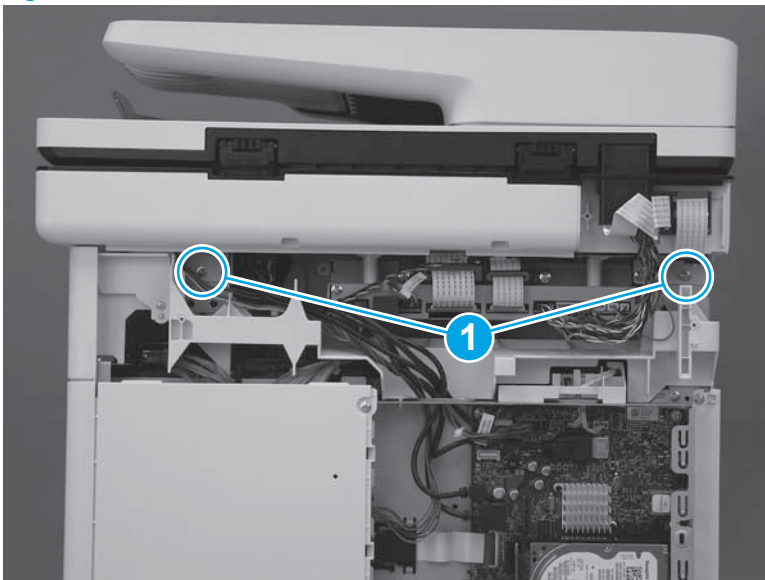

6. At the right side of the printer, install one screw (callout 1).

Figure 1-2433 Install one screw

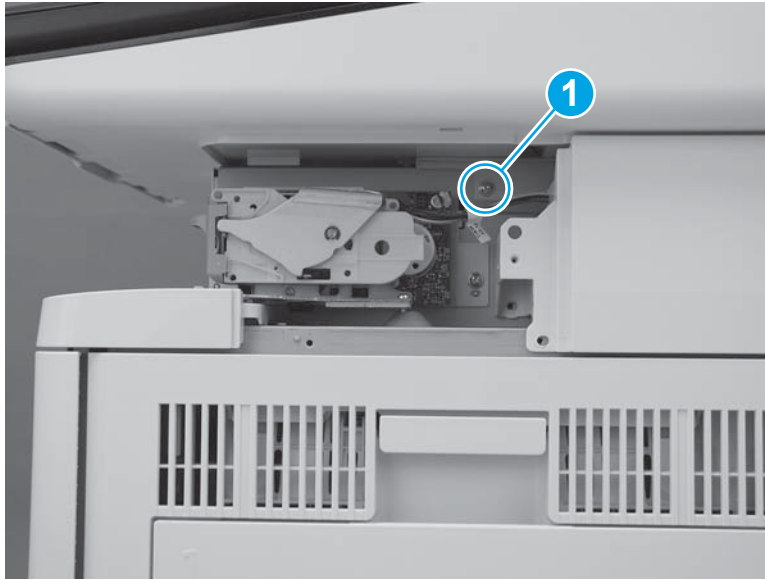

7. Connect two connectors on the scanner control board (callout 1).

M577c/f/z only: Connect one connector for the stapler on the scanner control board (callout 2).

Figure 1-2434 Connect connectors

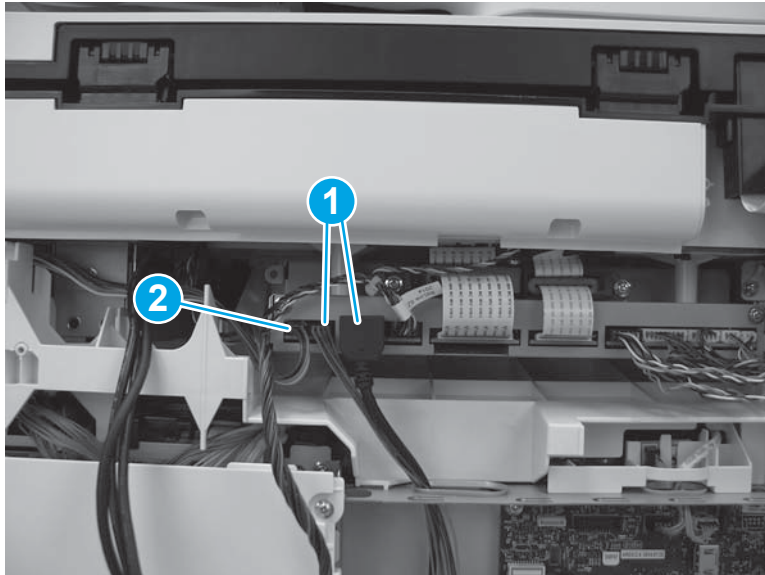

Step 31: Install the stapler cover assembly (M577c/f/z)



NOTE: This step is for the M577c/f/z models only. For the M577dn model, skip this step and go to [Step 32: Install the right front upper cover \(M577dn\) on page 1385](#).

For the M552 and M553 models, skip this step and go to [Step 36: Install the rear cover \(M552 and M553\) on page 1392](#).

1. Install the tabs (callout 1) on the cover in the slots (callout 2) in the printer.

Figure 1-2435 Install two tabs



2. Press the cover toward the left side of the printer until it snaps into place.

Figure 1-2436 Install the cover assembly



3. Install one screw (callout 1).



 **IMPORTANT:** This is a self-tapping screw for plastic. Rotate it counterclockwise to align it with the existing thread pattern, and then carefully turn it clockwise to tighten. Do not overtighten. This will prevent stripping the threads inside the screw hole.

Figure 1-2437 Install one screw

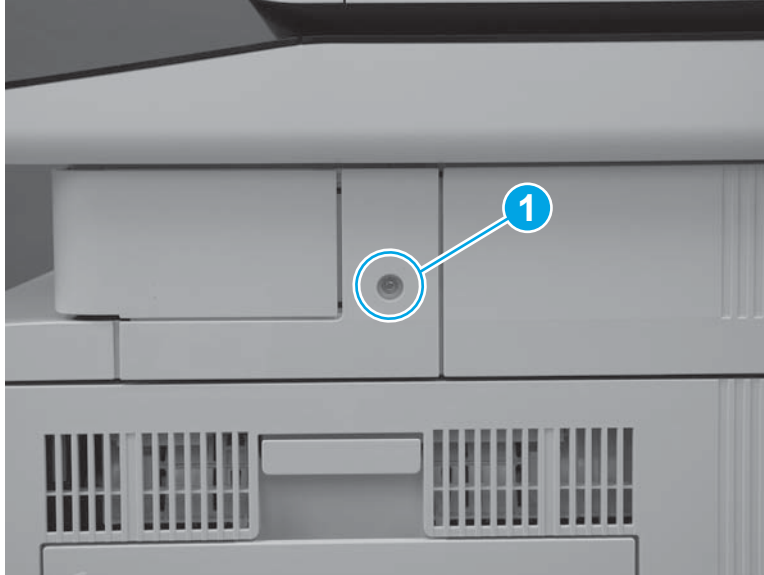

Step 32: Install the right front upper cover (M577dn)

 **NOTE:** This step is for the M577dn model only. For the M577c/f/z models, skip this step and go to [Step 33: Install the left upper cover \(M577\) on page 1387](#).

For the M552 and M553 models, skip this step and go to [Step 36: Install the rear cover \(M552 and M553\) on page 1392](#).

1. Slide the cover toward the left side of the printer to install it. Make sure that the slots (callout 1) in the cover fit over the tabs (callout 2) on the inside of the paper feeder cover.

Figure 1-2438 Install the cover



2. Press the right front upper cover (callout 1) and the paper feeder cover (callout 2) together until the tabs on the inside of the covers snap into place.

Figure 1-2439 Press the cover



3. Install one screw (callout 1).

Figure 1-2440 Install one screw

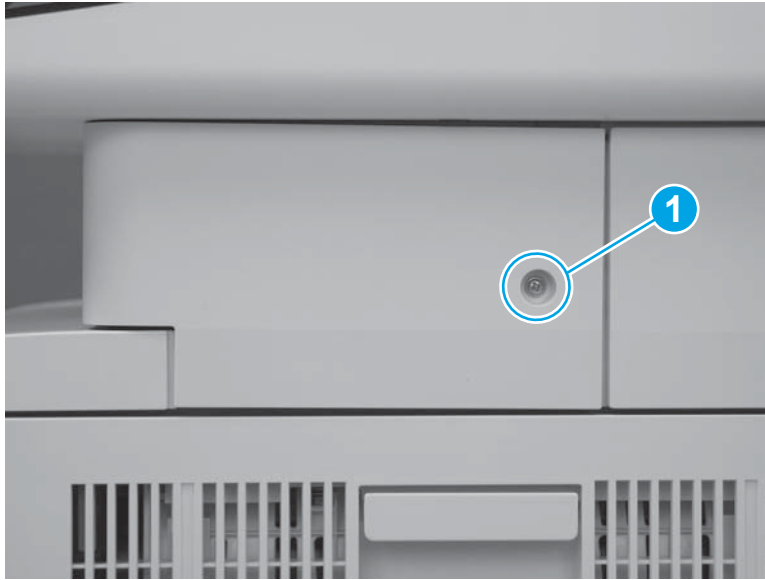

Step 33: Install the left upper cover (M577)

 **NOTE:** This step is for the M577 models. For the M552 and M553 models, skip this step and go to [Step 36: Install the rear cover \(M552 and M553\) on page 1392](#).

1. Position the tab (callout 1) on the lower edge of the cover behind the left cover (callout 2).

Figure 1-2441 Position the tab

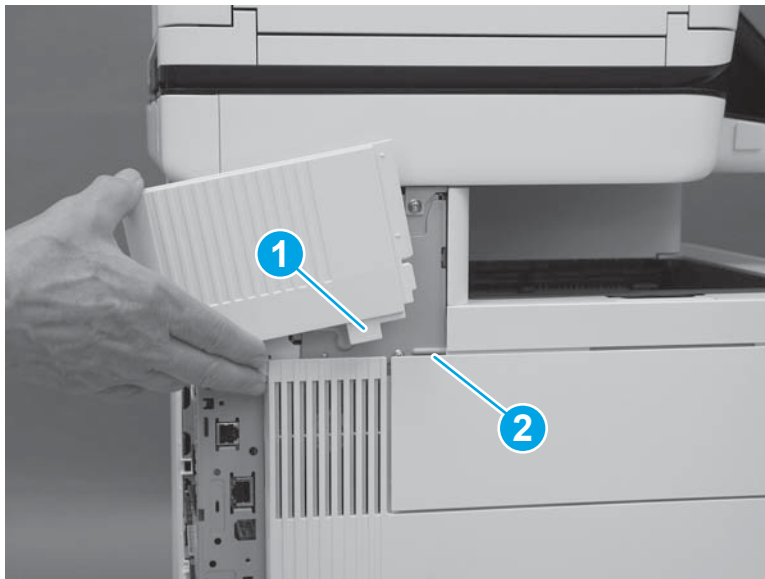

2. Slide the cover toward the front of the printer to install it. Make sure that the edge (callout 1) of the cover fits behind the edge (callout 2) of the top rear cover.

Figure 1-2442 Slide the cover

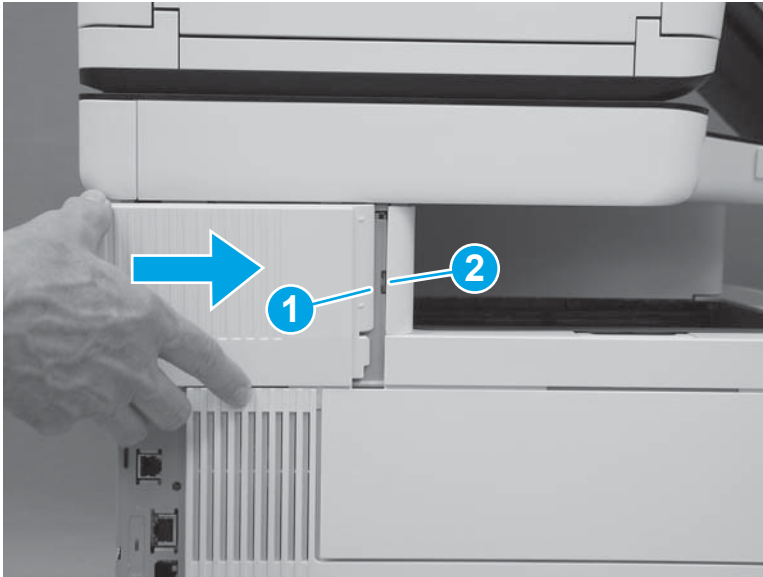

3. Make sure that the tab (callout 1) is fully installed.

Figure 1-2443 Check the tab

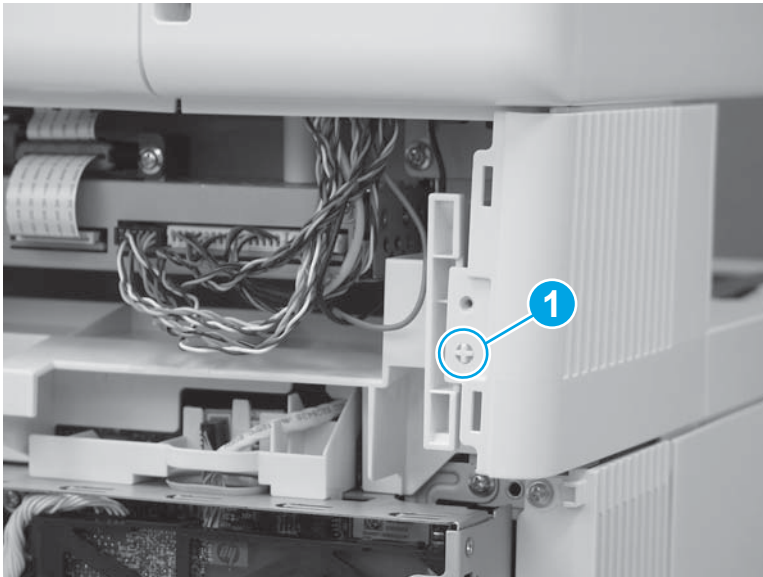

Step 34: Install the rear cover (M577)



NOTE: This step is for the M577 models. For the M552 and M553 models, skip this step and go to [Step 36: Install the rear cover \(M552 and M553\) on page 1392.](#)

1. Position the hooks (callout 1) on the cover in the slots (callout 2) in the printer.

Figure 1-2444 Position the hooks

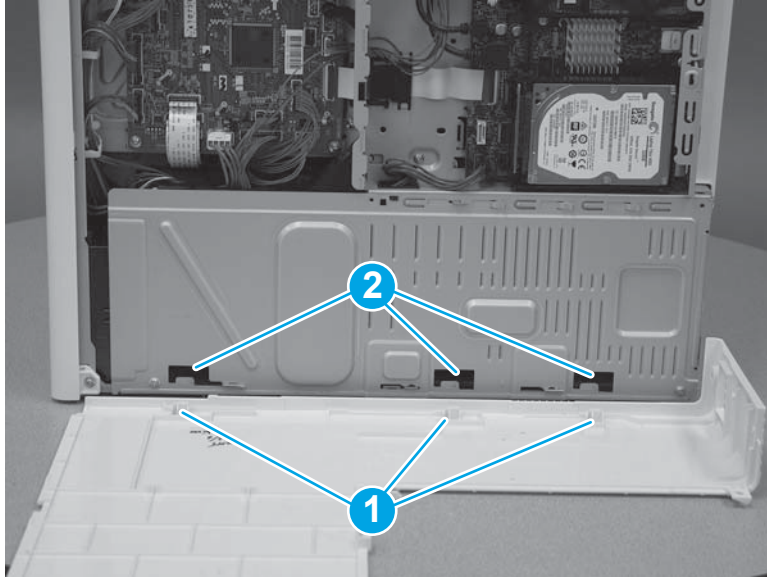

2. Position the back edge (callout 1) of the rear cover behind the edge (callout 2) of the right rear cover. Slide the cover to the left to install it.

Figure 1-2445 Install the cover

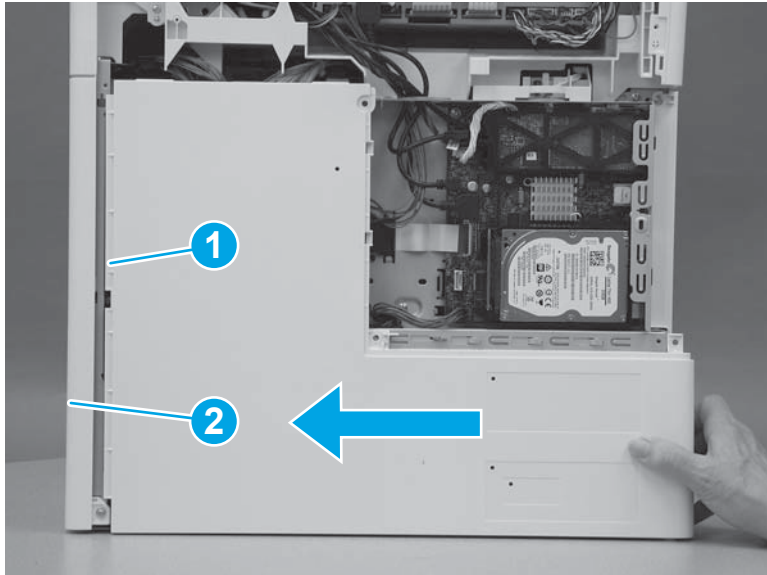

3. Install four screws (callout 1).

Figure 1-2446 Install four screws cover

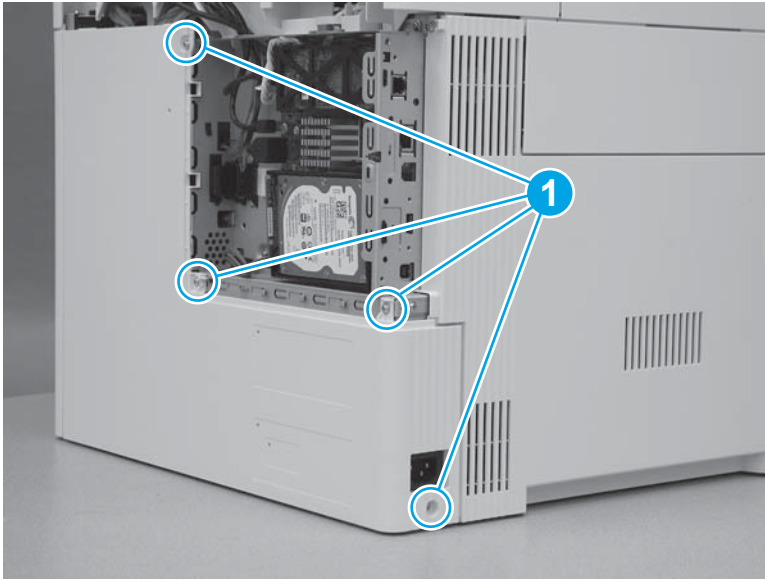

Step 35: Install the rear upper cover (M577)



NOTE: This step is for the M577 models. For the M552 and M553 models, skip this step and go to [Step 36: Install the rear cover \(M552 and M553\) on page 1392](#).

1. Align the ridge (callout 1) on the lower edge of the rear upper cover in front of the tabs (callout 2) on the top edge of the rear cover.

Figure 1-2447 Align the cover

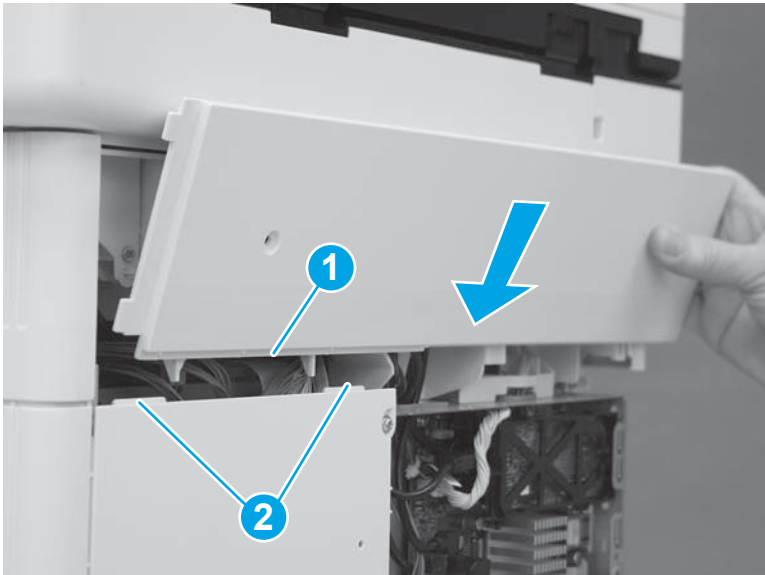

2. Rotate the top of the cover toward the printer.

Figure 1-2448 Rotate the top of the cover



3. Slide the cover to the left (callout 1). Make sure that the tabs (callout 2) on the upper rear cover slide behind the edge (callout 3) of the right upper cover. Make sure that the cover is fully seated.

Figure 1-2449 Slide the cover

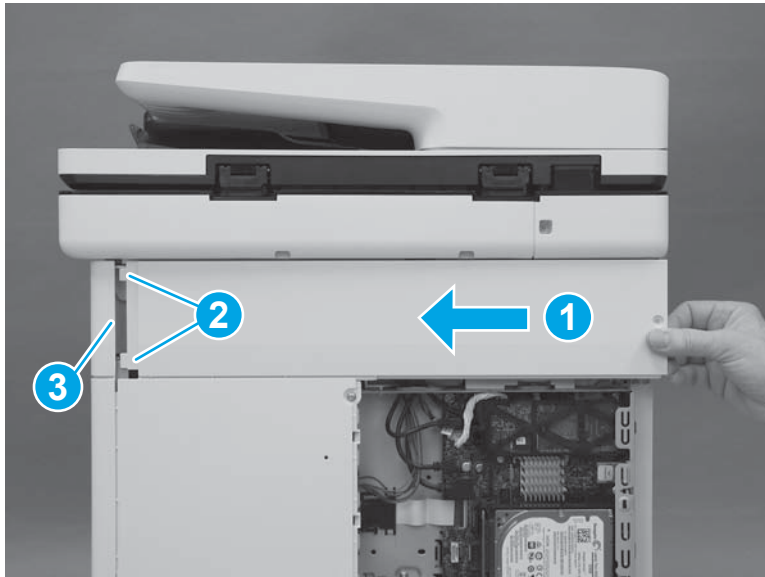

4. Install two screws (callout 1).



 **IMPORTANT:** These two screws are self-tapping screws for plastic. Rotate them counterclockwise to align them with the existing thread pattern, and then carefully turn them clockwise to tighten. Do not overtighten. This will prevent stripping the threads inside the screw holes.

Figure 1-2450 Install two screws

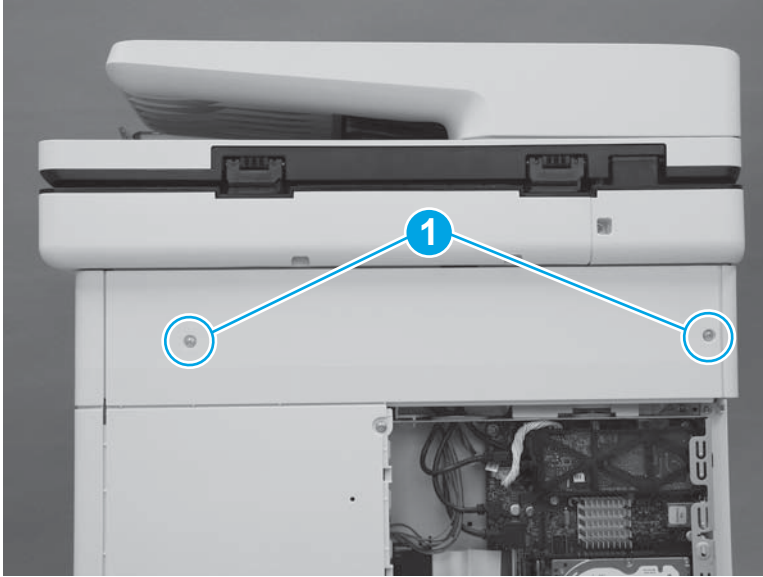

Step 36: Install the rear cover (M552 and M553)

 **NOTE:** This step is for the M552 and M553 models. For the M577 models, skip this step and go to [Step 37: Install the formatter \(M577\) on page 1393](#).

1. Position the top of the cover under the upper cover (callout 1), rotate the bottom of the cover onto the chassis (callout 2), and then slide the cover to the left (callout 3) to install it.

Figure 1-2451 Install the cover

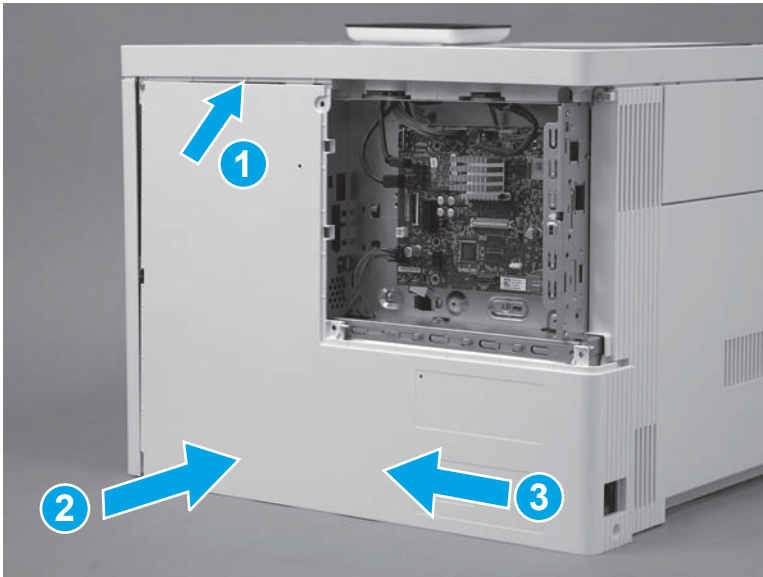

2. Install four screws (callout 1).

Figure 1-2452 Install four screws cover

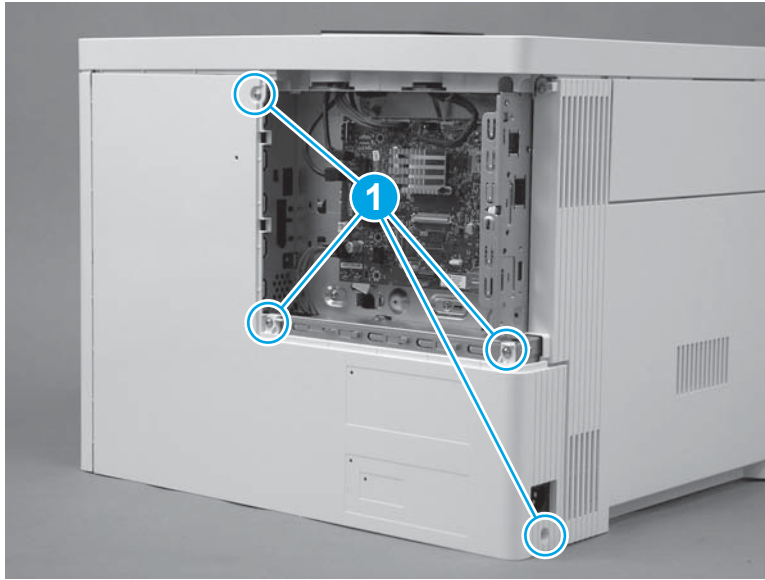

Step 37: Install the formatter (M577)

 **NOTE:** This step is for the M577 models. For the M552 and M553 models, skip this step and to go [Step 40: Install the formatter \(M552 and M553\)](#) on page 1398.

 **CAUTION:**  ESD-sensitive part.

1. Position the formatter in the printer. Make sure that the network port (callout 1) fits through the opening (callout 2) in the formatter case.

Figure 1-2453 Install the formatter

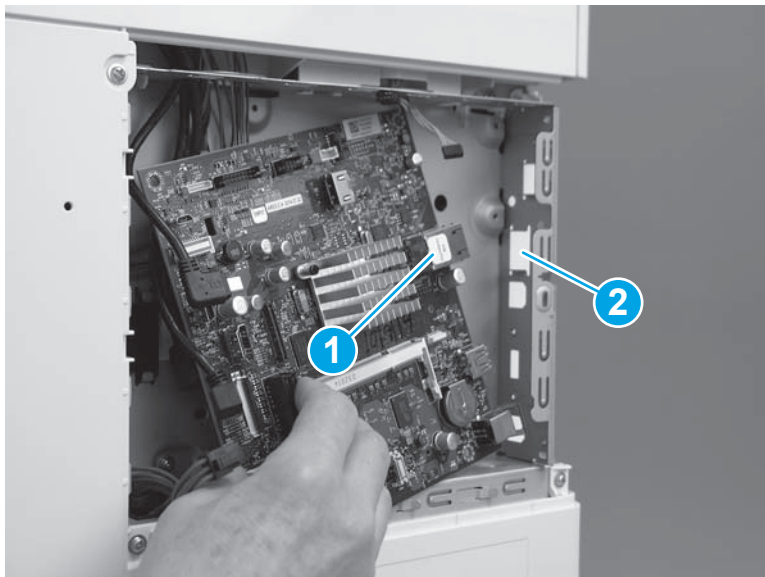

2. Install four screws (callout 1).

Figure 1-2454 Install four screws

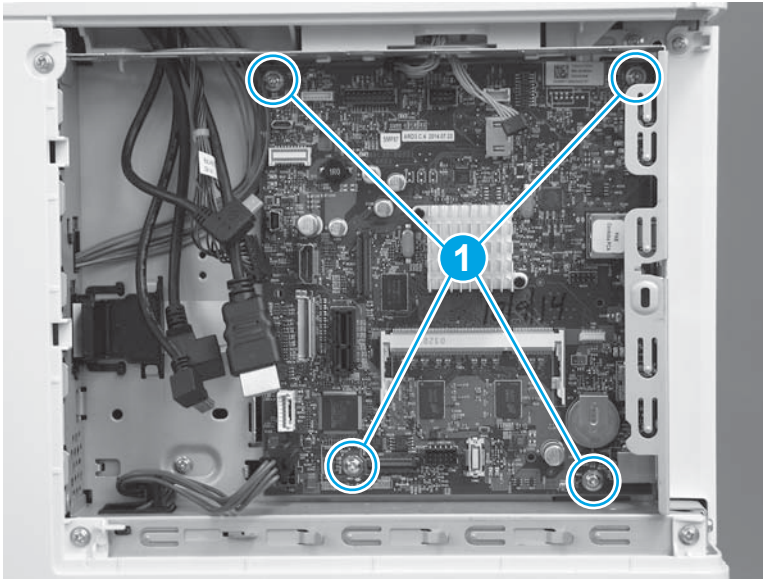

3. Connect all of the connectors on the formatter.

The following connectors are empty:

- All models: J1 (this connector is empty unless the optional DIMM is installed)
- All models: J3
- M577dn: J15 (this is the fax connector for the M577f/z/c models)
- All models: J21 (this connector is empty unless the optional internal USB ports component is installed)
- All models: J23
- All models: J24
- All models: J51
- All models: J57
- All models: J97
- All models: J98 (this connector is empty unless the optional trusted platform module (TPM) is installed)

 **IMPORTANT:** The flat-cable connector (callout 1) is a Zero Insertion Force (ZIF) connector that uses a hinged retainer to secure the flat cable. The hinged retainer must be opened to install the flat cable, and then closed after the cable is installed.

Figure 1-2455 Connect all connectors



Step 38: Install the fax PCA (M577c/f/z)

 **NOTE:** This step is for the M577c/f/z models. For the M577n model, skip this step and go to [Step 39: Install the HDD \(M577\) on page 1396](#).

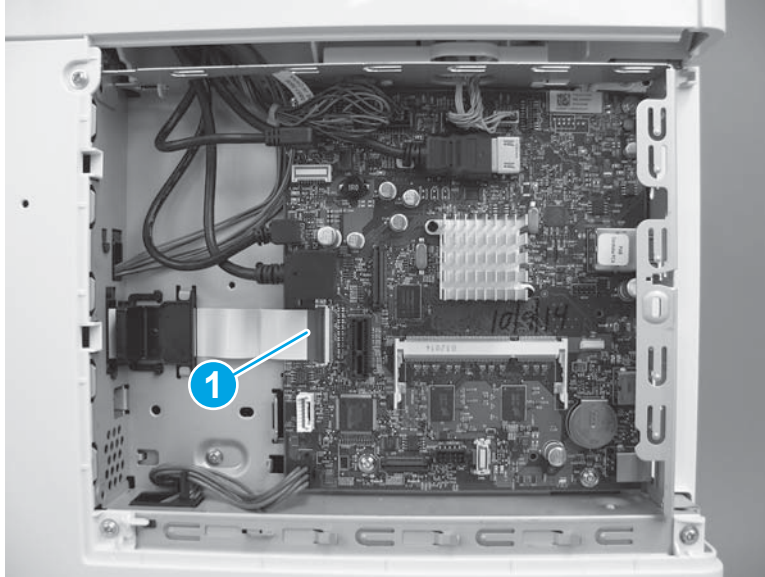
For the M552 and M553 models, skip this step and go to [Step 40: Install the formatter \(M552 and M553\) on page 1398](#).

 **CAUTION:**  ESD-sensitive part.

1. Position the tab and telephone port (callout 1) on the fax PCA in the slots (callout 2) in the formatter case.

Figure 1-2456 Position the fax PCA

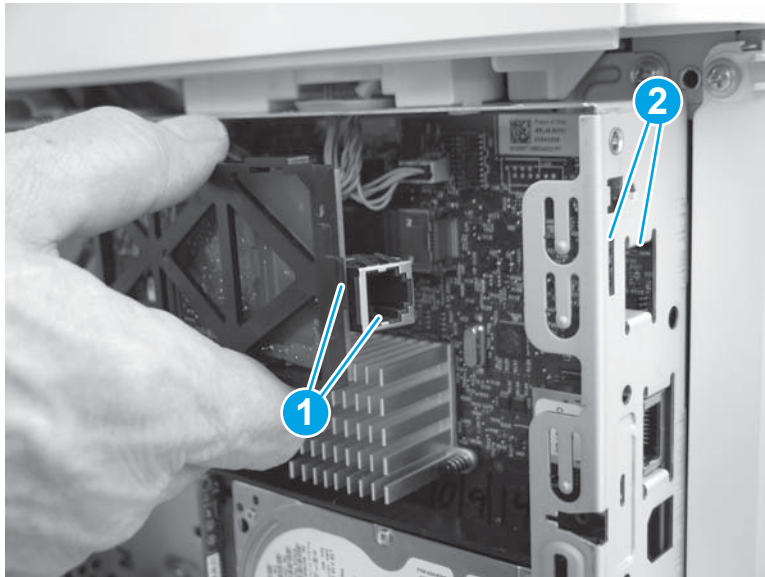

2. Slide the fax PCA to the right (callout 1) until the tab and telephone port described in the previous step and seated in the formatter case. Position the retainer (callout 2) in the slot (callout 3) in the formatter. Rotate the end of the fax PCA toward the formatter (callout 4) until the retainer snaps into place.

Figure 1-2457 Install the fax PCA

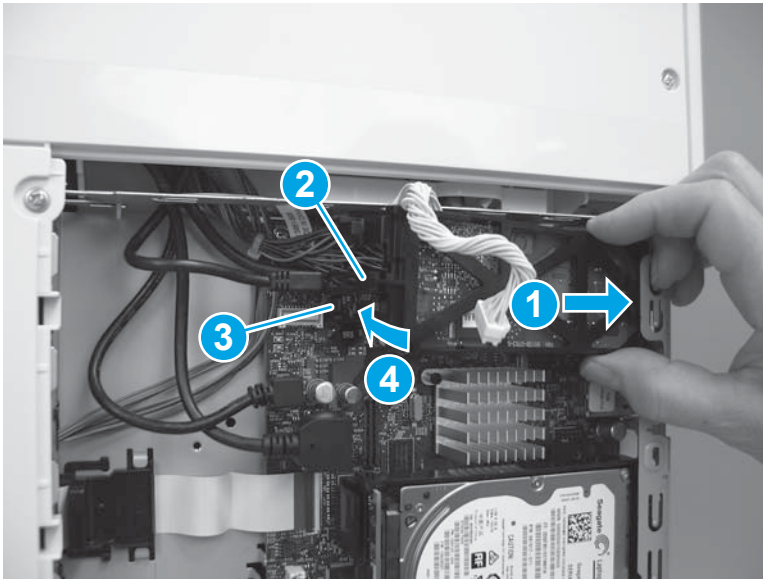

3. Position the cable (callout 1) in the guide (callout 2), and then connect one connector (callout 3).

Figure 1-2458 Connect the connector

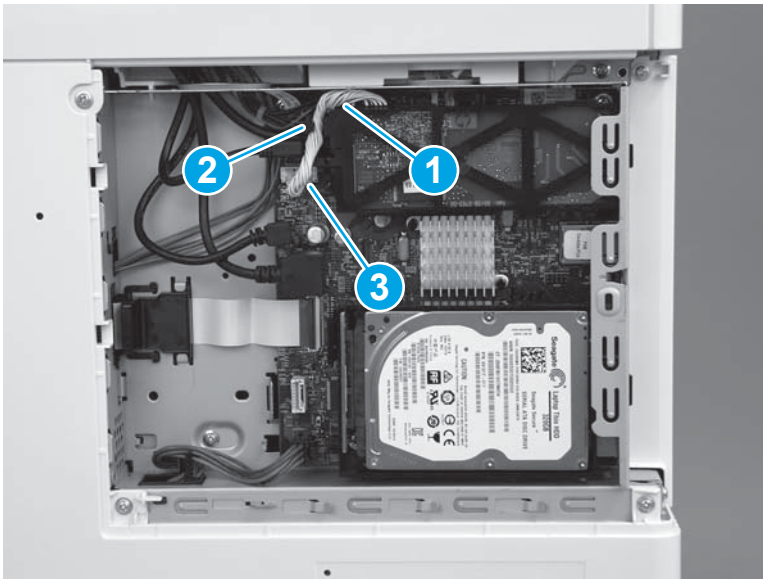

Step 39: Install the HDD (M577)



NOTE: This step is for the M577 models. For the M552 and M553 models, skip this step and go to [Step 40: Install the formatter \(M552 and M553\) on page 1398](#).

 **CAUTION:**  ESD-sensitive part.

1. Align the end of the bracket (callout 1) with the slot in the chassis (callout 2), and then slide the HDD into the printer (callout 3) to engage the bracket with the chassis.

Figure 1-2459 Install the holder

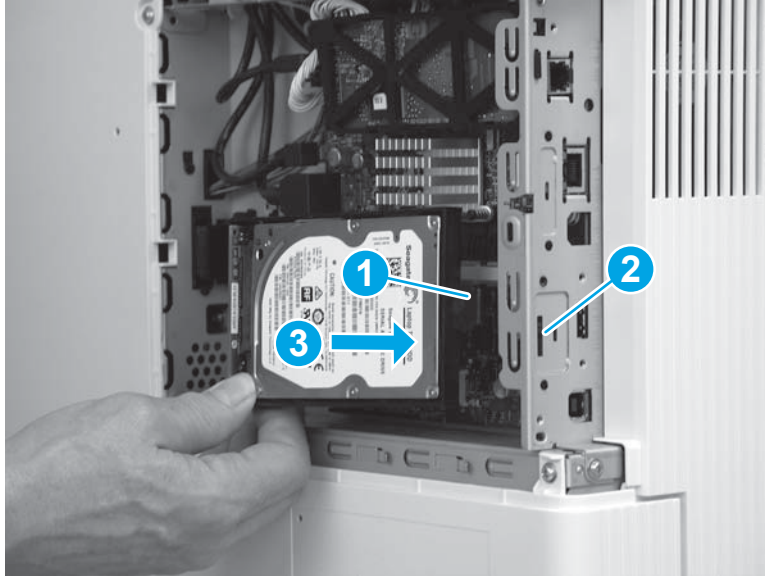

2. Hold the HDD connector latch (callout 1) in the released position, and then rotate the HDD down and into the connector on the formatter to install it.

 **NOTE:** Make sure that the tab (callout 2) snaps into place, and that the HDD is securely installed.

Figure 1-2460 Release the HDD

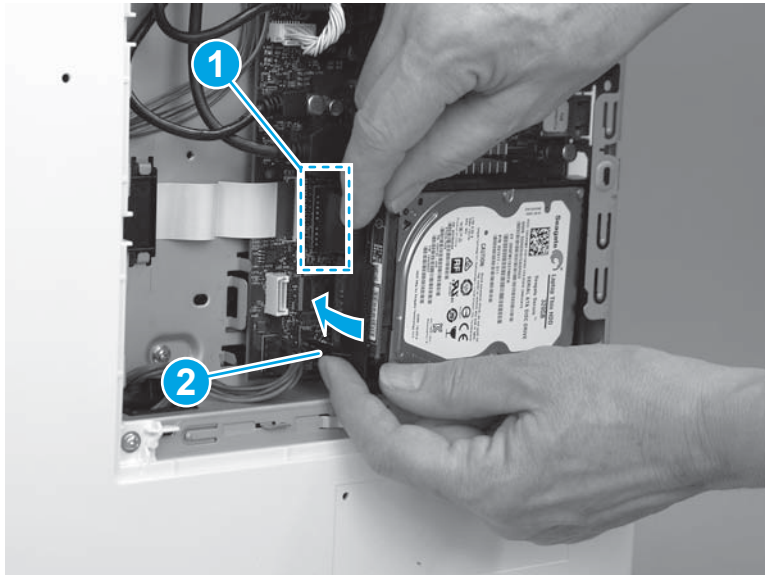

Step 40: Install the formatter (M552 and M553)

 **NOTE:** This step is for the M552 and M553 models. For the M577 models, skip this step and go to [Step 41: Install the formatter cover on page 1399](#).

If the optional hard-disk drive (HDD) was removed, do not forget to reinstall it after the formatter is reinstalled.

Engage the HDD holder with the chassis, rotate the HDD connector down and into the connector on the formatter. Make sure that the tabs snap into place.

 **CAUTION:**  ESD-sensitive part.

1. Position the formatter in the printer, and then install four screws (callout 1).

Figure 1-2461 Install the formatter

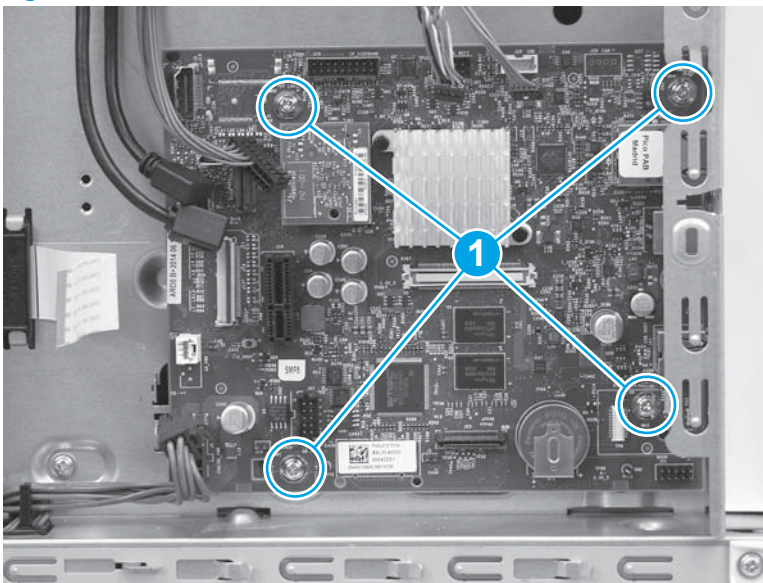

2. Connect all of the connectors on the formatter.

The following connectors are empty:

- All models: J1 (this connector is empty unless the optional DIMM is installed)
- M553n/dn and M552dn: J2 (callout 1; this is the touchscreen connector for the M553x model)
- All models: J9 (this connector is empty unless the optional internal USB ports component is installed)
- All models: J18 (this connector is empty unless the optional hard-disk-drive (HDD) is installed)
- All models: J23
- All models: J24
- M553n/dn and M552dn: J25 (this is the wireless connector for the M553x model)

- All models: J57
- All models: J98 (this connector is empty unless the optional trusted platform module (TPM) is installed)



 **IMPORTANT:** The flat-cable connector (callout 2) is a Zero Insertion Force (ZIF) connector that uses a hinged retainer to secure the flat cable. The hinged retainer must be opened to install the flat cable.

Figure 1-2462 Connect all connectors

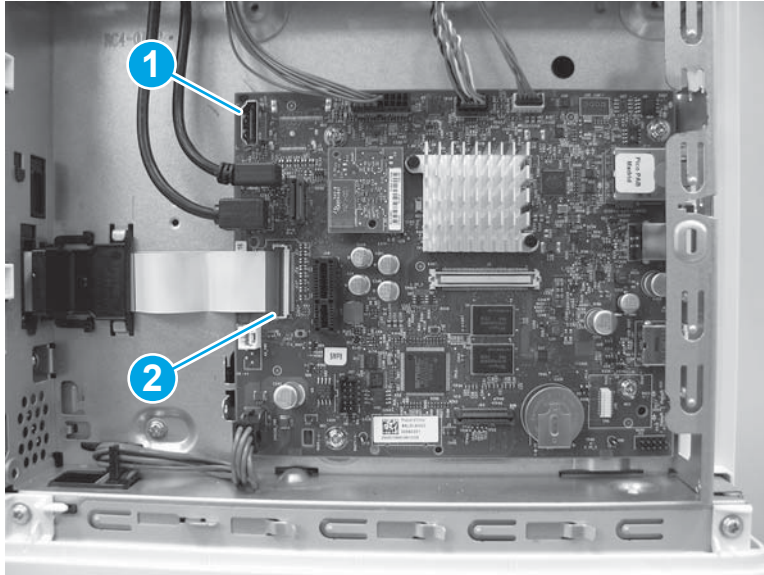

Step 41: Install the formatter cover

- ▲ Slide the cover onto the printer (callout 1) to install it.

 **NOTE:** Make sure that the tabs on the formatter cover align with the slots provided in the printer (callout 2). Tighten the two thumbscrews (callout 3).

 **TIP:** If needed, use the edge of a coin to turn the thumbscrews.

Figure 1-2463 Install the cover



Step 42: Install the TCU

1. Verify that the toner collection hatch cover is in the closed position on the TCU.

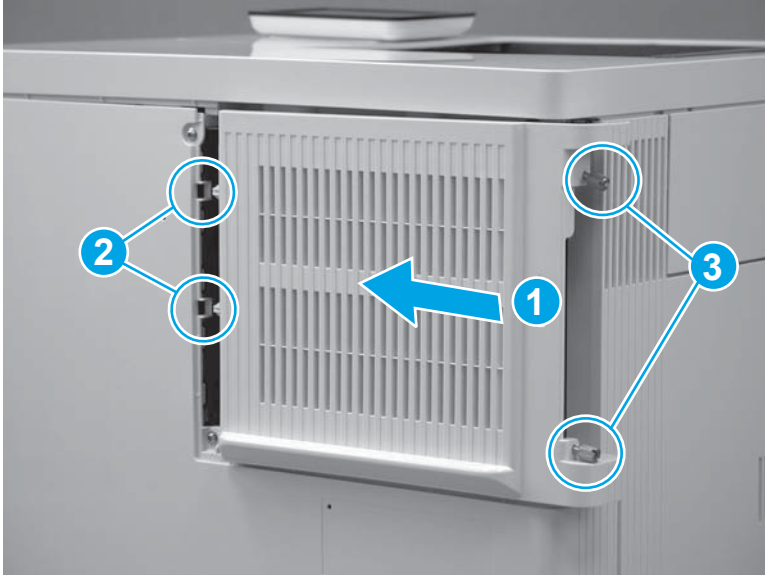
Figure 1-2464 Verify that the toner collection hatch cover is closed

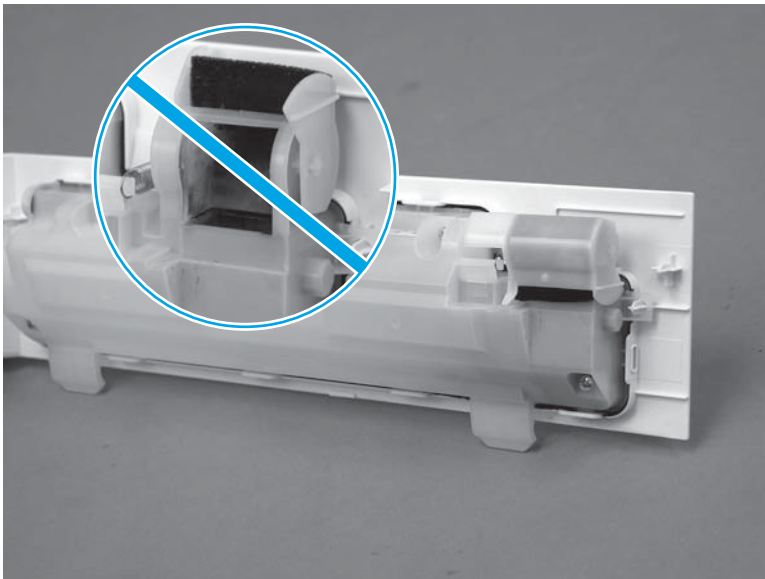

2. Position the TCU with the hinges in the slots provided in the printer (callout 1), and then rotate the TCU up and into the closed position.

 **NOTE:** The toner collection hatch cover automatically opens when the TCU is closed.

Figure 1-2465 Install the TCU



3. Close the front door.

Figure 1-2466 Close the front door

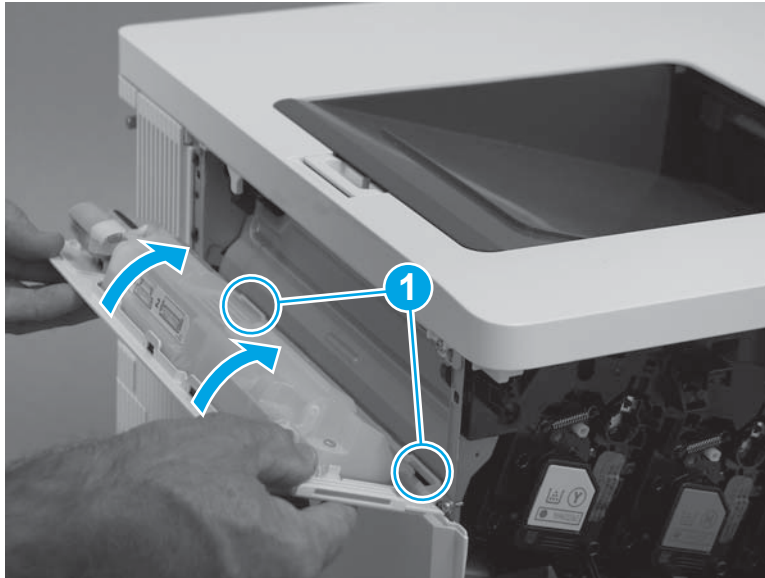

Step 43: Install the tray

1. With the front of the tray slightly lifted, align the sides of the tray with the rails in the printer, and then carefully slide the tray into the printer.

 **TIP:** As the tray slides into the printer, lower the front of it.

Figure 1-2467 Install the tray



2. Close the tray.

Figure 1-2468 Close the tray



Step 44: Install the control-panel assembly (M553x only)

 **NOTE:** For the M553n/dn and M552dn models, skip this step and go to [Step 45: Install the USB cover \(M552 and M553\) on page 1405](#).

For the M577 models, skip this step.

1. Place the control panel on the printer as shown.

Figure 1-2469 Place the control panel on the product

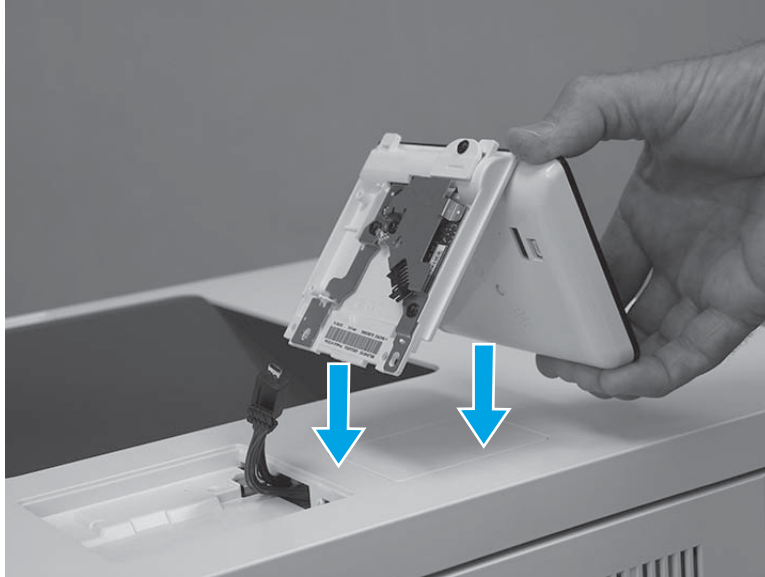

2. Connect one USB cable (callout 1), and one connector (callout 2).

 **IMPORTANT:** Take note of the location of the two mounting tabs (callout 3) on the control-panel assembly.

Figure 1-2470 Connect two connectors



3. Turn the control panel over, and then position the front edge tabs in the slots in the top cover.

Figure 1-2471 Turn the control panel over

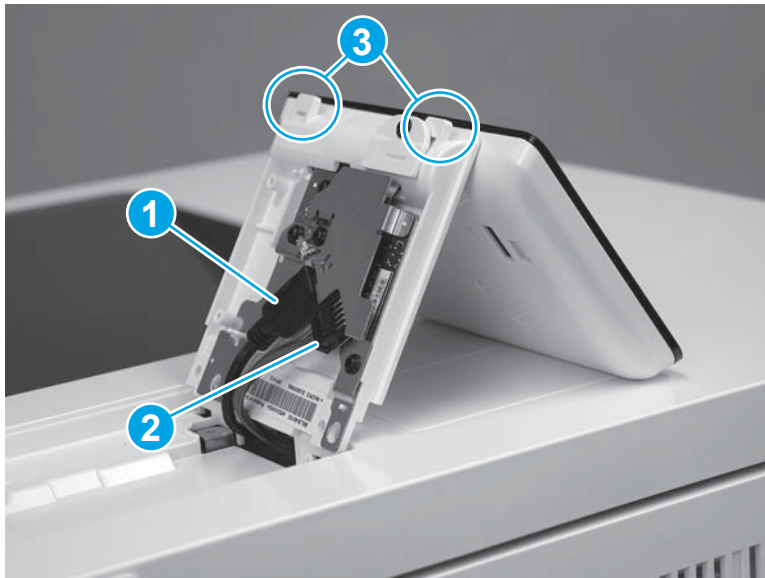
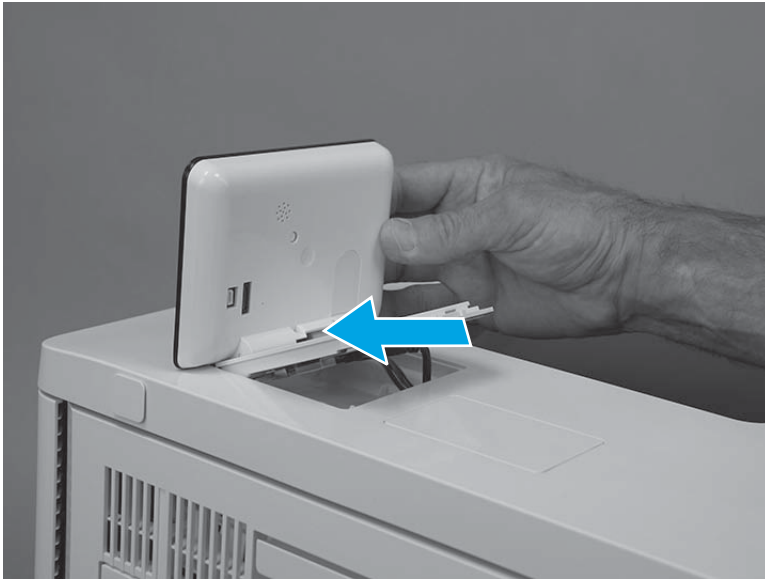

4. Rotate the control-panel base down onto the printer.

Figure 1-2472 Rotate the control-panel base down



5. Use a small Phillips screwdriver to install two screws (callout 1).

Figure 1-2473 Install two screws

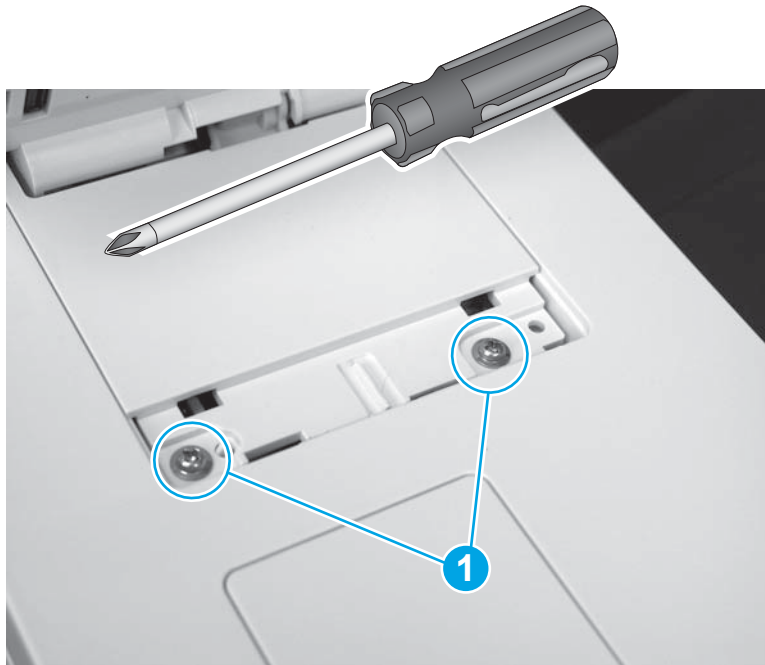

6. Position the screw cover mounting feet into the slots in the top cover (callout 1), and then rotate the cover down (callout 2) to install it.



 **NOTE:** Press down on the cover firmly to make sure that the tabs on the cover (callout 3) snap into place.

Figure 1-2474 Install the cover

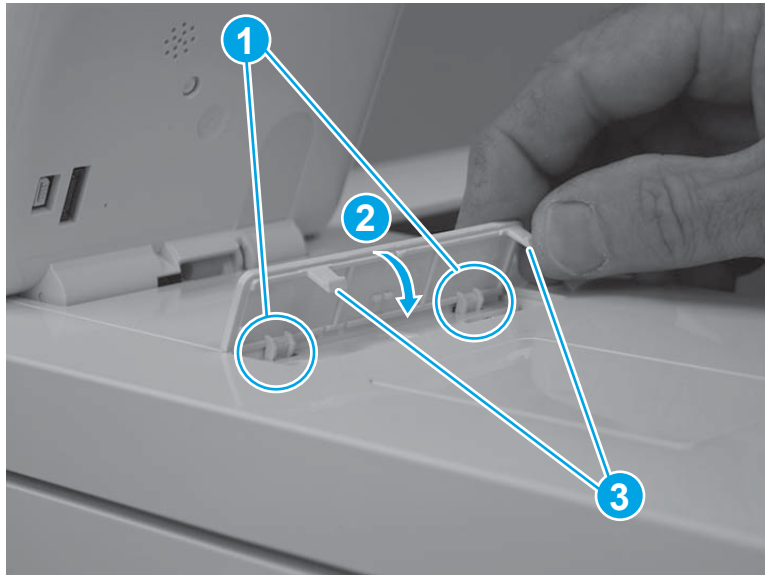

Step 45: Install the USB cover (M552 and M553)

 **NOTE:** This step is for the M552 and M553 models. For the M577 models, skip this step.

1. Push the cover into the USB port to install it.

Figure 1-2475 Install the cover



2. Make sure that the USB cover is fully seated after installing it.

Figure 1-2476 Check the installation

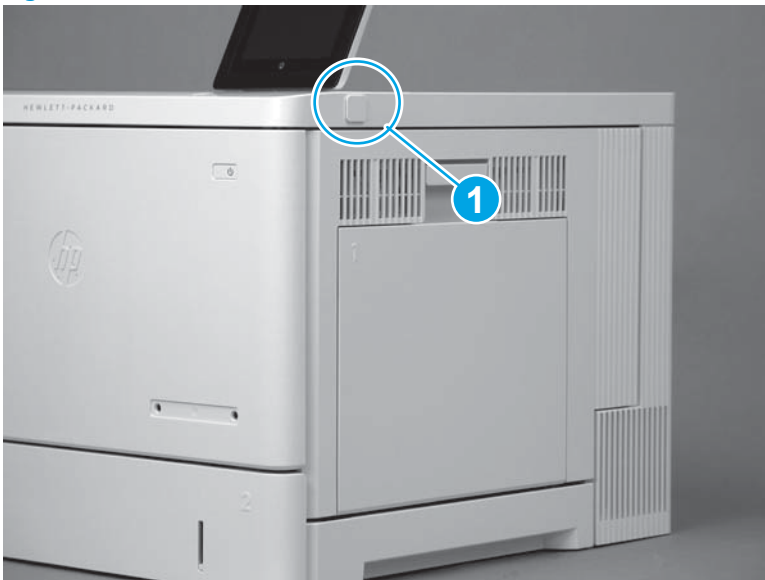

Removal and replacement: High-voltage power supply T (HVPST)

- [Introduction](#)
- [Step 1: Remove the USB cover \(M552 and M553\)](#)
- [Step 2: Remove the control panel \(M553x only\)](#)
- [Step 3: Remove the tray](#)
- [Step 4: Remove the toner collection unit \(TCU\)](#)
- [Step 5: Remove the formatter cover](#)
- [Step 6: Remove the formatter \(M552 and M553\)](#)
- [Step 7: Remove the hard-disk drive \(HDD\) \(M577\)](#)
- [Step 8: Remove the fax PCA \(M577c/f/z\)](#)
- [Step 9: Remove the formatter \(M577\)](#)
- [Step 10: Remove the rear cover \(M552 and M553\)](#)
- [Step 11: Remove the rear upper cover \(M577\)](#)
- [Step 12: Remove the rear cover \(M577\)](#)
- [Step 13: Remove the left upper cover \(M577\)](#)
- [Step 14: Remove the right front upper cover \(M577dn\)](#)
- [Step 15: Remove the stapler cover assembly \(M577c/f/z\)](#)
- [Step 16: Remove the integrated scanner assembly \(ISA\) \(M577\)](#)
- [Step 17: Remove the right upper cover \(M577\)](#)
- [Step 18: Remove the top rear cover \(M577\)](#)
- [Step 19: Remove the left cover](#)
- [Step 20: Remove the upper cover \(M552 and M553\)](#)
- [Step 21: Remove the formatter case](#)
- [Step 22: Remove the right rear cover](#)
- [Step 23: Remove the DC controller and sheet-metal bracket](#)
- [Step 24: Remove the high-voltage power supply T \(HVPST\)](#)
- [Step 25: Unpack the replacement assembly](#)
- [Step 26: Install the HVPST](#)
- [Step 27: Install the DC controller and sheet-metal bracket](#)
- [Step 28: Install the right rear cover](#)
- [Step 29: Install the formatter case](#)

- [Step 30: Install the upper cover \(M552 and M553\)](#)
- [Step 31: Install the left cover](#)
- [Step 32: Install the top rear cover \(M577\)](#)
- [Step 33: Install the right upper cover \(M577\)](#)
- [Step 34: Install the integrated scanner assembly \(ISA\) \(M577\)](#)
- [Step 35: Install the stapler cover assembly \(M577c/f/z\)](#)
- [Step 36: Install the right front upper cover \(M577dn\)](#)
- [Step 37: Install the left upper cover \(M577\)](#)
- [Step 38: Install the rear cover \(M577\)](#)
- [Step 39: Install the rear upper cover \(M577\)](#)
- [Step 40: Install the rear cover \(M552 and M553\)](#)
- [Step 41: Install the formatter \(M577\)](#)
- [Step 42: Install the fax PCA \(M577c/f/z\)](#)
- [Step 43: Install the HDD \(M577\)](#)
- [Step 44: Install the formatter \(M552 and M553\)](#)
- [Step 45: Install the formatter cover](#)
- [Step 46: Install the TCU](#)
- [Step 47: Install the tray](#)
- [Step 48: Install the control-panel assembly \(M553x only\)](#)
- [Step 49: Install the USB cover \(M552 and M553\)](#)

Introduction



This document provides the procedures to remove and replace the high-voltage power supply T (HVPST).

Before performing service

Turn the printer power off

- Disconnect the power cable.

 **WARNING!** To avoid damage to the printer, turn the printer off, wait 30 seconds, and then remove the power cord before attempting to service the printer.

 **CAUTION:**  This part contains components that are electrostatic discharge (ESD) sensitive. To reduce the possibility of ESD damage, always touch the sheet-metal chassis to ground yourself before touching an ESD sensitive part.

Use the table below to identify the correct part number for your printer, and then go to <http://h20141.www2.hp.com/hpparts> to order the part.

High-voltage power supply T (HVPST) part number	
RM2-7123-000CN	High-voltage power supply T (HVPST) M552dn, M553dn, M553x, M577)
RM2-7134-000CN	High-voltage power supply T (HVPST) (M553n)

Required tools

- #2 Phillips screwdriver with a magnetic tip

After performing service

Make sure that all of the connectors on the HVPST are fully seated.

Make sure that all of the connectors on the DC controller are fully seated.

Make sure that all of the connectors on the formatter are fully seated.

Make sure that the formatter cover is fully seated, and that the thumbscrews are finger tight after replacing it.

Turn the printer power on

- Connect the power cable.
- Use the power switch to turn the power on.

Post service test

Print a configuration page to make sure that the printer is functioning correctly.

Step 1: Remove the USB cover (M552 and M553)



NOTE: This step is for the M552 and M553 models. For the M577 models, skip this step and go to [Step 3: Remove the tray on page 1414](#).

1. Locate the USB cover.

Figure 1-2477 Locate the USB cover



2. Pull the cover off of the printer to remove it.

Figure 1-2478 Remove the cover



Step 2: Remove the control panel (M553x only)

 **NOTE:** This step is for the M553x model. For the M553n/dn, M552dn, and M577 models, skip this step and go to [Step 3: Remove the tray on page 1414](#).

1. Tilt the control panel up.

Figure 1-2479 Tilt the control panel up



2. Use a small flat-blade screwdriver to release the control-panel screws cover tabs.

Figure 1-2480 Release the control-panel screws cover tabs



3. Rotate the cover up to remove it.

Figure 1-2481 Remove the cover



4. Use a small Phillips screwdriver to remove two screws (callout 1).

 **IMPORTANT:** Store the screws in a secure place where they cannot fall down into the printer.

Figure 1-2482 Remove two screws

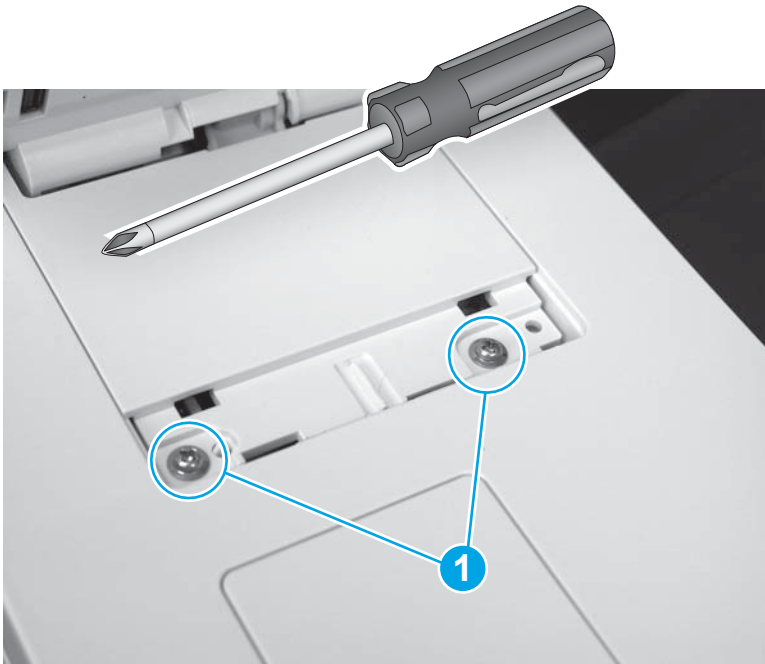

5. Rotate the control-panel base toward the front of the printer.

Figure 1-2483 Rotate the control-panel base up



6. Slightly slide the control-panel base toward the rear of the printer (callout 1) to release it, and then turn the control panel over (callout 2) to access the bottom side.

⚠ CAUTION: The control panel is still attached to the printer. Do not attempt to completely remove the control panel.

Figure 1-2484 Turn the control panel over

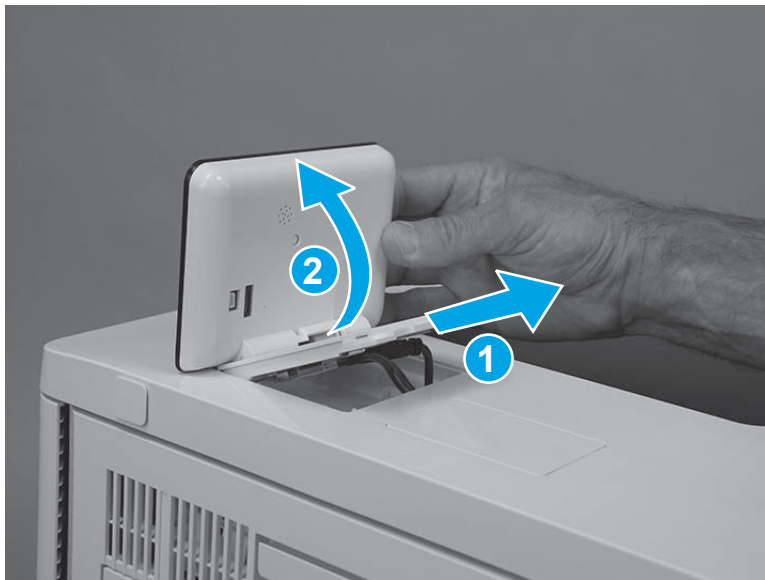

7. Disconnect one USB cable (callout 1), one connector (callout 2), and then remove the control panel.

Figure 1-2485 Disconnect two connectors

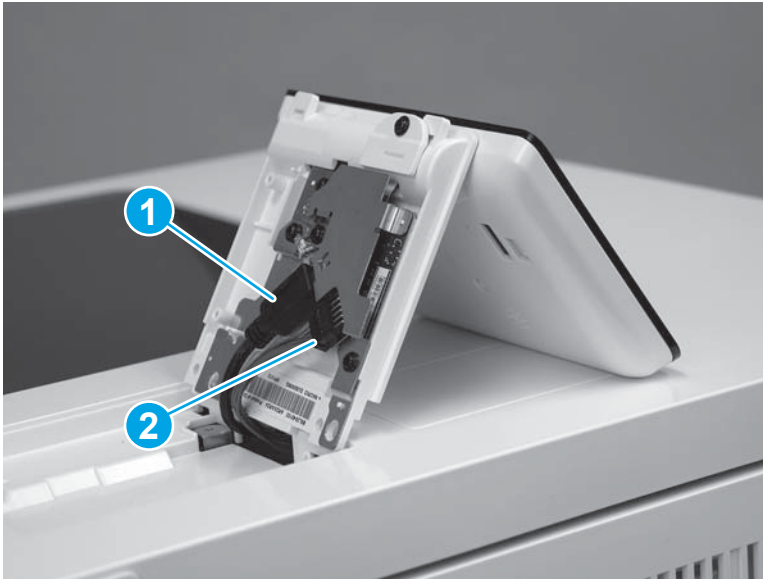

Step 3: Remove the tray

1. Pull the tray out until it stops.

Figure 1-2486 Pull the tray out



2. Lift the front of the tray, and then pull it out of the printer to remove it.

Figure 1-2487 Remove the tray

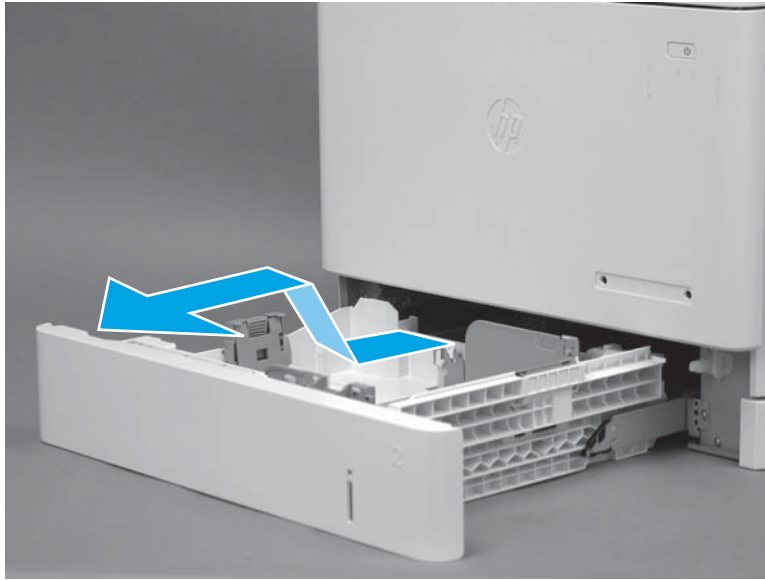

Step 4: Remove the toner collection unit (TCU)

1. Open the front door.

Figure 1-2488 Open the front door



2. Open the TCU.

 **NOTE:** The toner collection hatch cover automatically closes when the TCU is opened.

Figure 1-2489 Open the TCU



3. Pull the TCU away from the printer at an angle to remove it.

⚠ CAUTION: Do not open the toner collection hatch cover when handling the TCU. If toner gets on clothing, wipe it off by using a dry cloth and wash the clothes in cold water. Hot water sets toner into fabric.

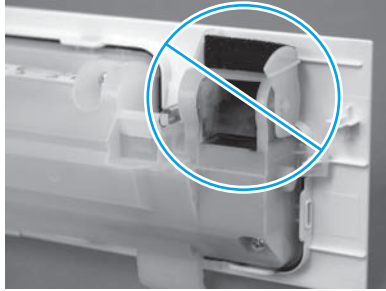
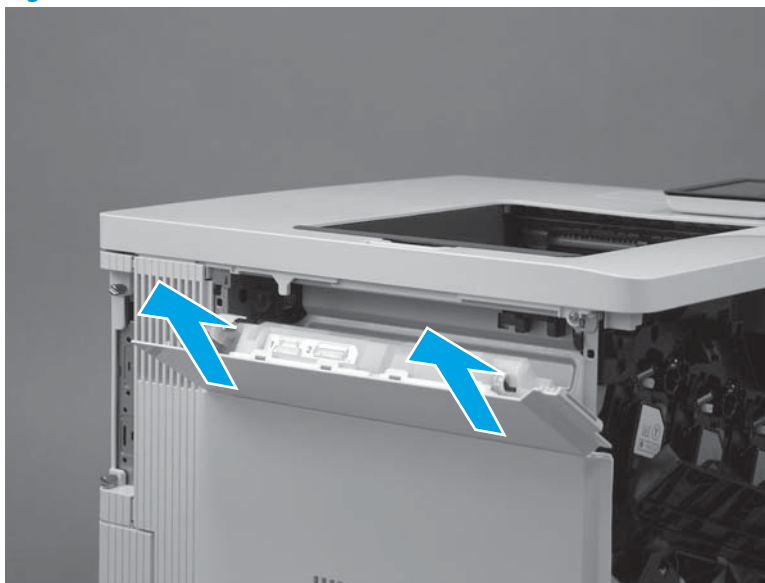

Figure 1-2490 Remove the TCU



Step 5: Remove the formatter cover

1. Locate the formatter cover.

Figure 1-2491 Locate the formatter cover

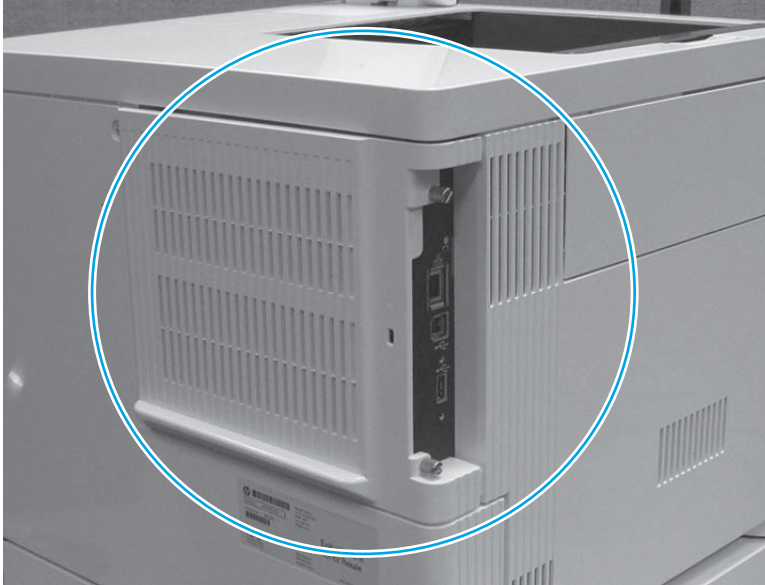

2. Loosen the two thumbscrews (callout 1). Grasp the two thumbscrews, and then slide the cover away from the printer (callout 2) to remove it.

 **TIP:** If needed, use the edge of a coin to turn the thumbscrews.

Figure 1-2492 Loosen the thumbscrews



Step 6: Remove the formatter (M552 and M553)

 **NOTE:** This step is for the M552 and M553 models. For the M577 models, skip this step and go to [Step 7: Remove the hard-disk drive \(HDD\) \(M577\) on page 1420](#).

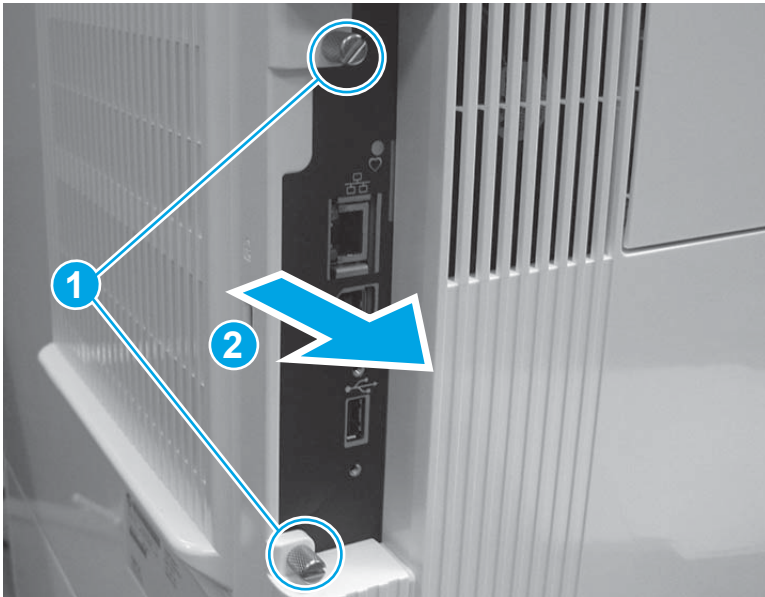
If the optional hard-disk drive (HDD) is installed, it must be removed to gain access to the formatter mounting screws.

Release two tabs along the left edge of the HDD, rotate the left edge away from the product, and then slide the HDD to the left to remove it.

 **CAUTION:**  ESD-sensitive part.

1. Disconnect all of the connectors on the formatter.

The following connectors are empty:

- All models: J1 (this connector is empty unless the optional DIMM is installed)
- M553n/dn and M552dn: J2 (callout 1; this is the touchscreen connector for the M553x model)
- All models: J9 (this connector is empty unless the optional internal USB ports component is installed)
- All models: J18 (this connector is empty unless the optional hard-disk-drive (HDD) is installed)
- All models: J23
- All models: J24
- M553n/dn and M552dn: J25 (this is the wireless connector for the M553x model)
- All models: J57
- All models: J98 (this connector is empty unless the optional trusted platform module (TPM) is installed)

 **IMPORTANT:** The flat-cable connector (callout 2) is a Zero Insertion Force (ZIF) connector that uses a hinged retainer to secure the flat cable. The hinged retainer must be opened to release the flat cable.

Figure 1-2493 Disconnect all connectors



2. Remove four screws (callout 1), and then remove the formatter.

Figure 1-2494 Remove the formatter

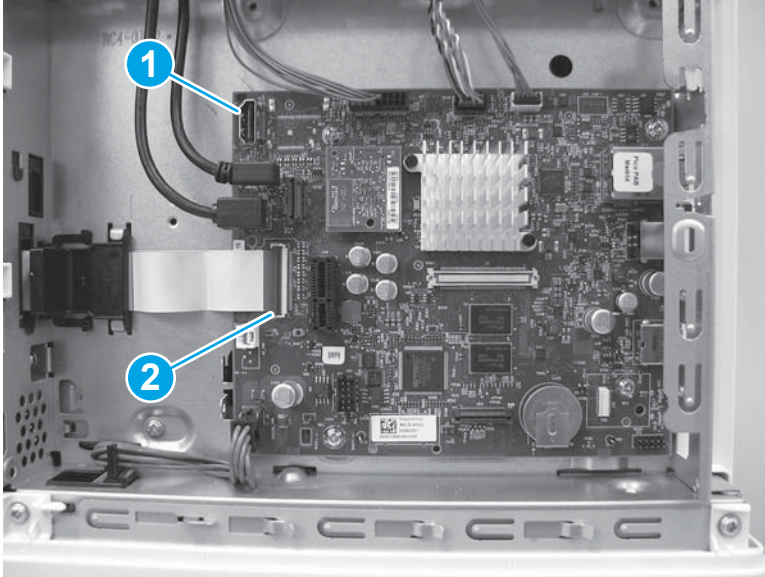
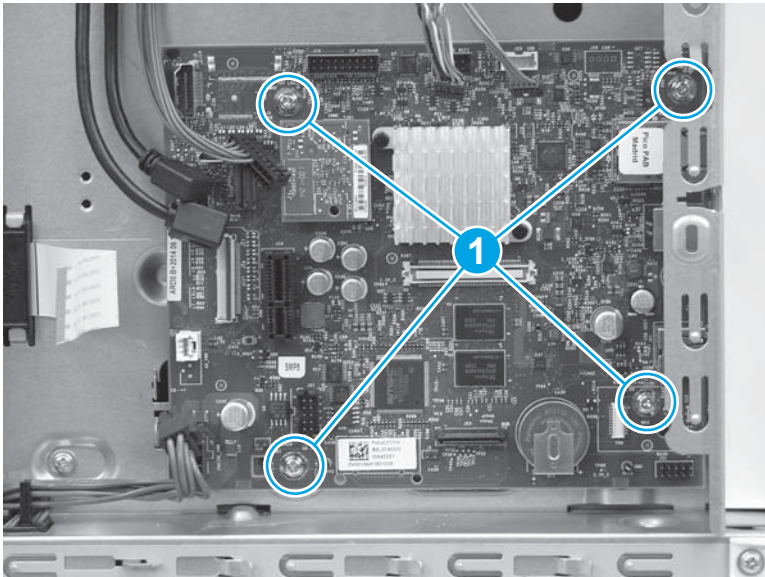

Step 7: Remove the hard-disk drive (HDD) (M577)



NOTE: This step is for the M577 models. For the M552 and M553 models, skip this step and go to [Step 10: Remove the rear cover \(M552 and M553\)](#) on page 1425.



CAUTION:  ESD-sensitive part.

1. Release two tabs (callout 1). Hold the tabs in the released position, and then rotate the hard disk drive (HDD) up (callout 2) to release the connector from the formatter.

Figure 1-2495 Release the HDD

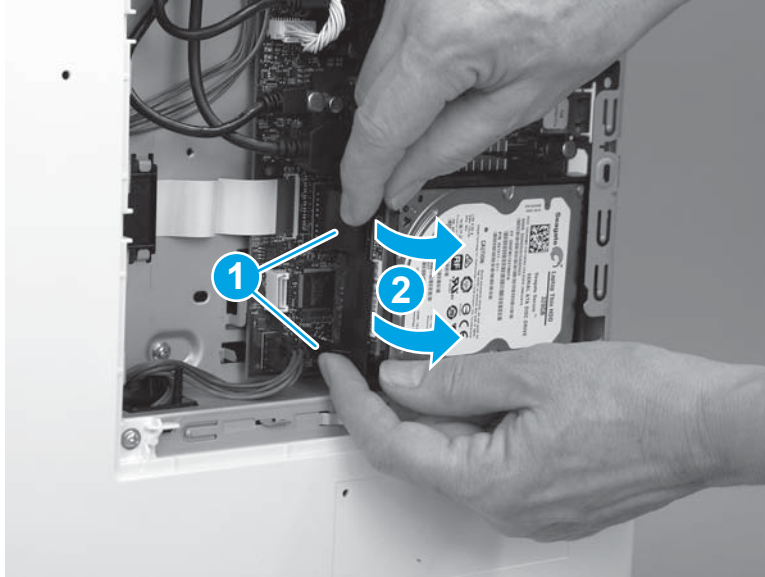

2. Slide the HDD away from the printer to remove it.

Figure 1-2496 Remove the HDD

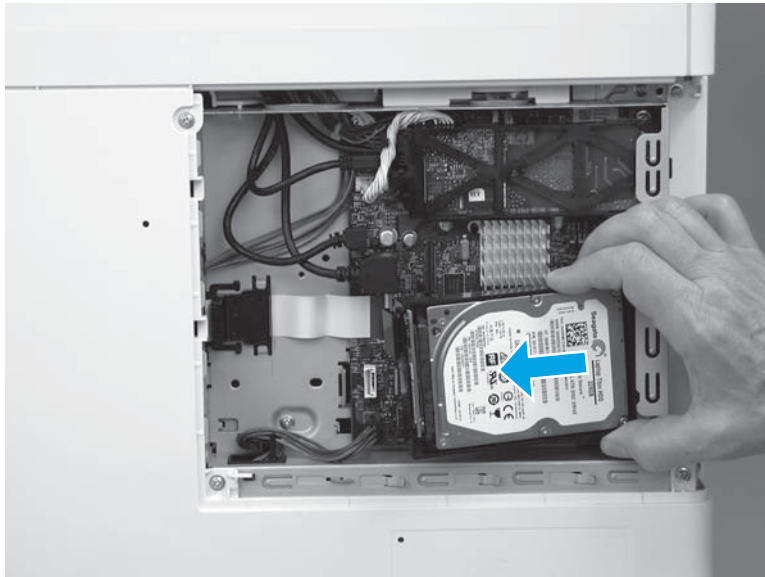

Step 8: Remove the fax PCA (M577c/f/z)

 **NOTE:** This step is for the M577c/f/z models. For the M577n model, skip this step and go to [Step 9: Remove the formatter \(M577\) on page 1423](#).

For the M552 and M553 models, skip this step and go to [Step 10: Remove the rear cover \(M552 and M553\) on page 1425](#).

 **CAUTION:**  ESD-sensitive part.

1. Locate the fax PCA component on the formatter.

Figure 1-2497 Locate the fax PCA

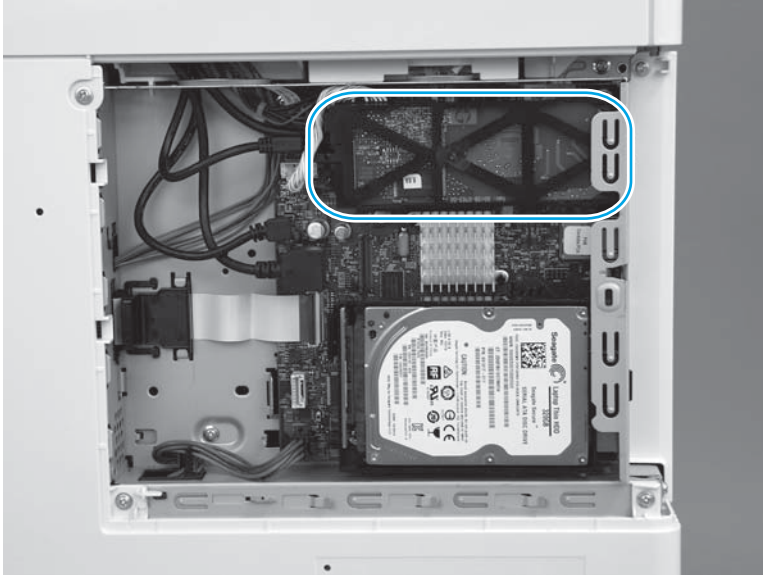

2. Release the connector latch (callout 1), and then pull the connector away from the formatter (callout 2) to disconnect it.

Figure 1-2498 Disconnect one connector

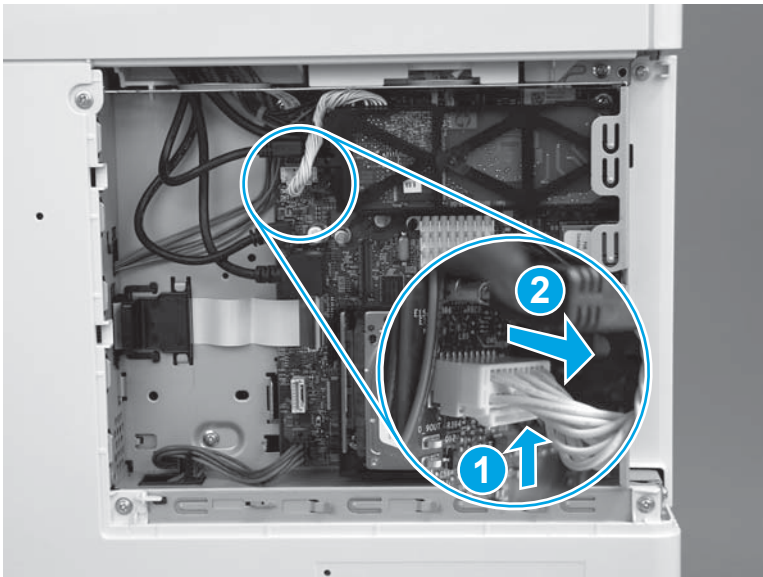

3. Release one retainer (callout 1) by pressing the bracket arms together.

Figure 1-2499 Release one latch

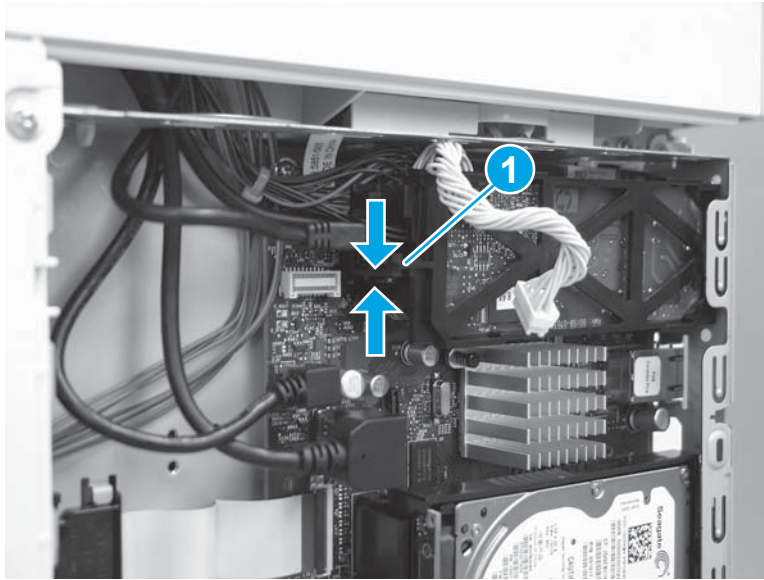

4. Rotate the end of the fax PCA (callout 1) away from the formatter, and then slide the PCA left (callout 2) to remove it.

Figure 1-2500 Remove the fax PCA

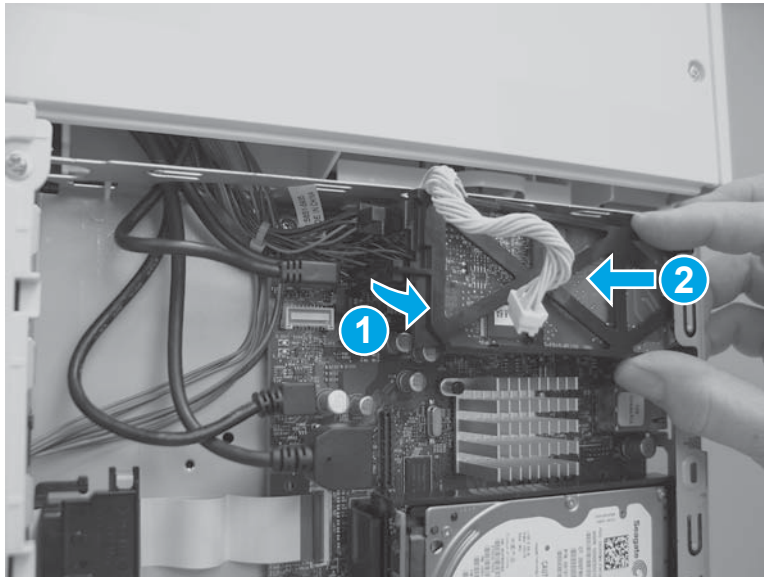

Step 9: Remove the formatter (M577)

 **NOTE:** This step is for the M577 models. For the M552 and M553 models, skip this step and go to [Step 10: Remove the rear cover \(M552 and M553\) on page 1425.](#)

 **CAUTION:**  ESD-sensitive part.

1. Disconnect all of the connectors on the formatter.

The following connectors are empty:

- All models: J1 (this connector is empty unless the optional DIMM is installed)
- All models: J3
- M577dn: J15 (this is the fax connector for the M577f/z/c models)
- All models: J21 (this connector is empty unless the optional internal USB ports component is installed)
- All models: J23
- All models: J24
- All models: J51
- All models: J57
- All models: J97
- All models: J98 (this connector is empty unless the optional trusted platform module (TPM) is installed)

 **IMPORTANT:** The flat-cable connector (callout 1) is a Zero Insertion Force (ZIF) connector that uses a hinged retainer to secure the flat cable. The hinged retainer must be opened to release the flat cable.

Figure 1-2501 Disconnect all connectors



2. Remove four screws (callout 1).

Figure 1-2502 Remove four screws

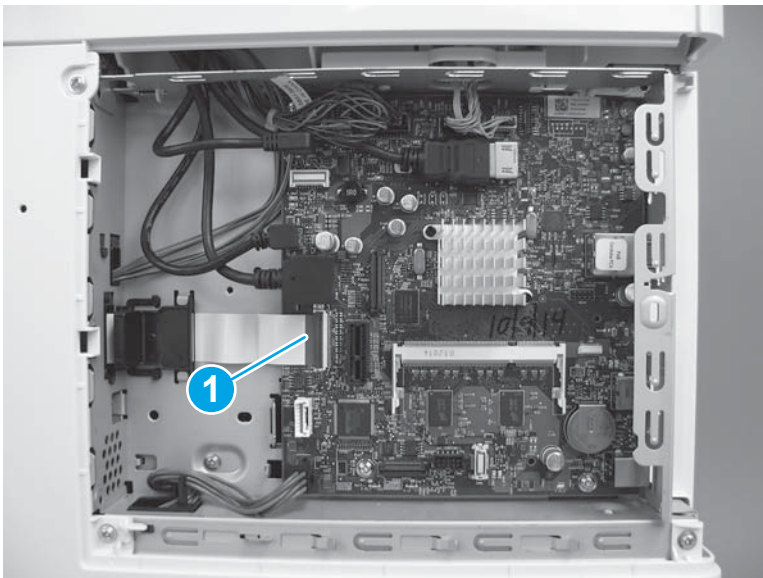
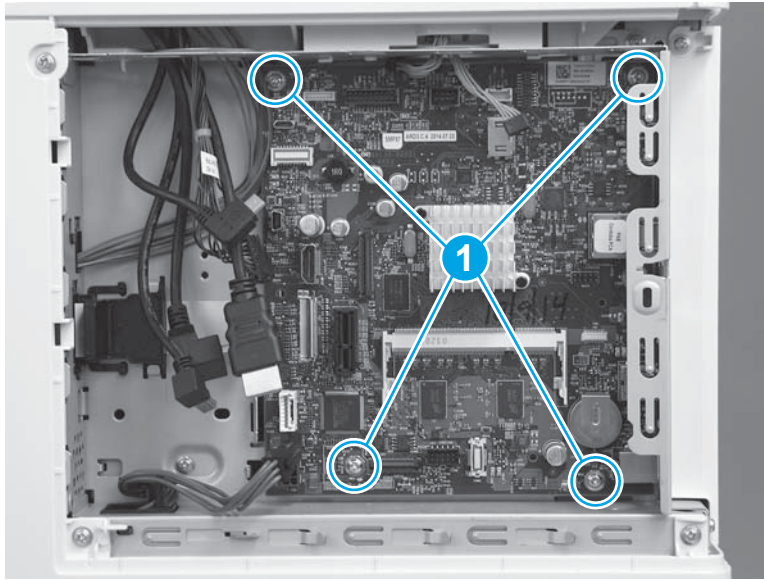

3. Remove the formatter.

Figure 1-2503 Remove the formatter

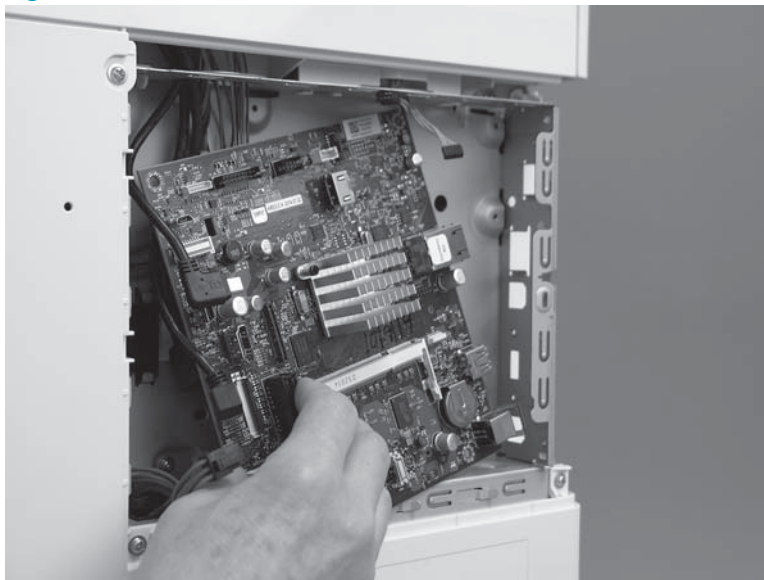

Step 10: Remove the rear cover (M552 and M553)

 **NOTE:** This step is for the M552 and M553 models. For the M577 models, skip this step and go to [Step 11: Remove the rear upper cover \(M577\) on page 1426.](#)

1. Remove four screws (callout 1).

Figure 1-2504 Remove four screws

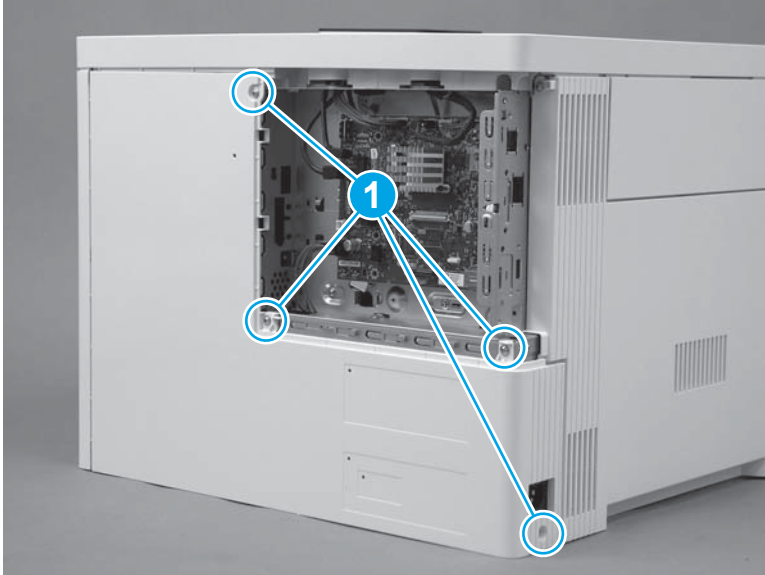

2. Slightly slide the cover to the right (callout 1), rotate the bottom of the cover away from the printer (callout 2), and then pull the top of the cover away from the printer (callout 3) to remove the cover.

Figure 1-2505 Remove the cover

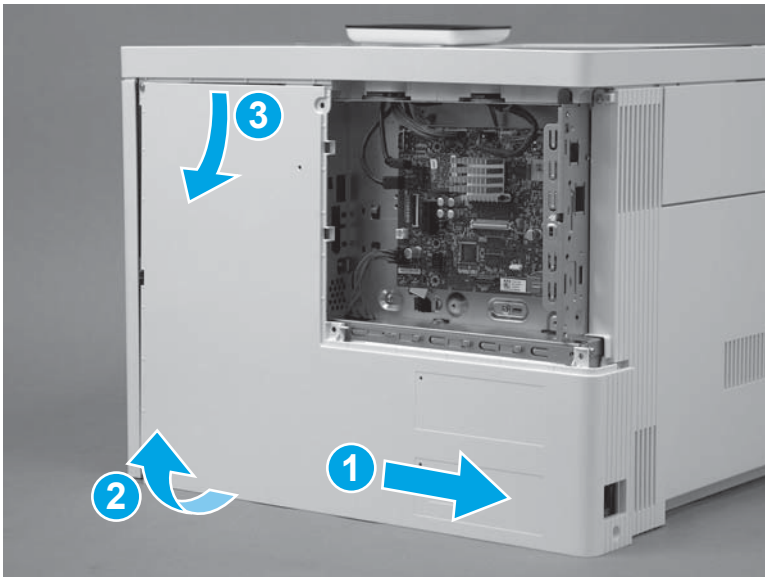

Step 11: Remove the rear upper cover (M577)



NOTE: This step is for the M577 models. For the M552 and M553 models, skip this step and go to [Step 19: Remove the left cover on page 1441](#).

1. Remove two screws (callout 1).



Reinstallation tip: These two screws are self-tapping screws for plastic. When reinstalling them, rotate the screws counterclockwise to align them with the existing thread pattern, and then carefully turn them clockwise to tighten. Do not overtighten. This will prevent stripping the threads inside the screw holes.

Figure 1-2506 Remove two screws

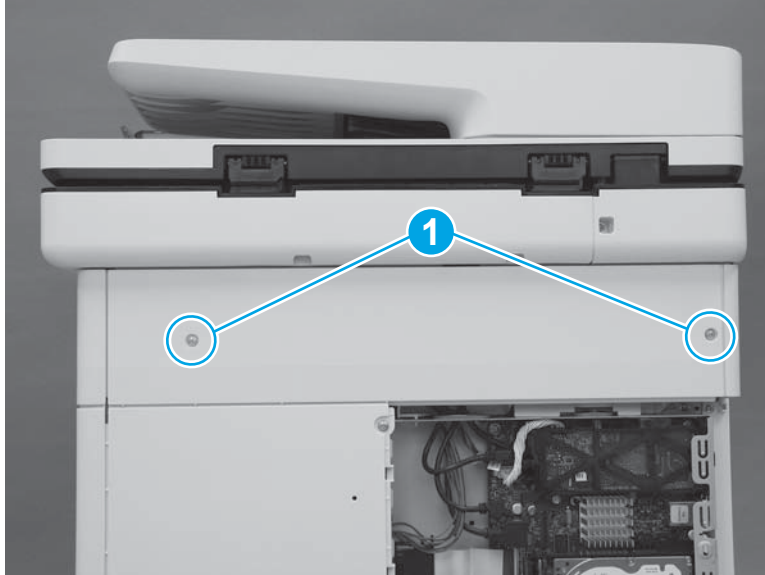

2. Use a small, flat blade screwdriver to release the right edge of the cover.

Figure 1-2507 Release the right edge

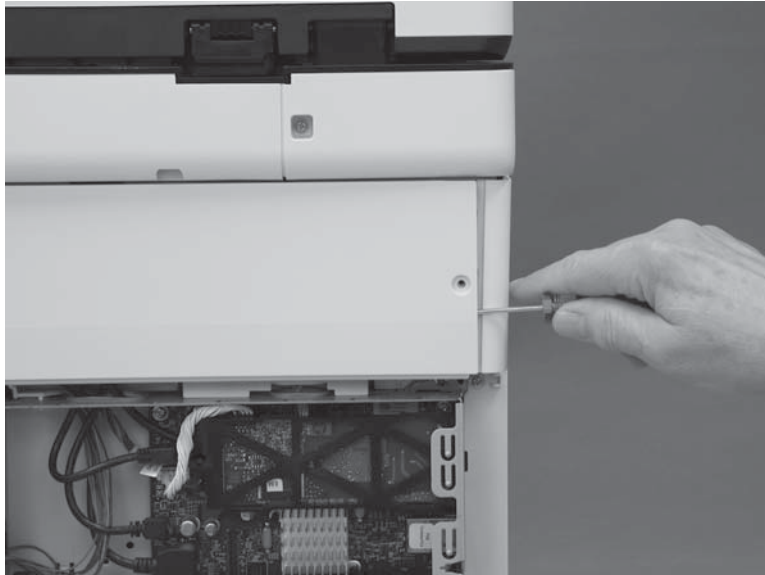

3. Pull the right edge of the cover (callout 1) away from the printer, and then slide the cover to the right (callout 2).

Figure 1-2508 Slide the cover right

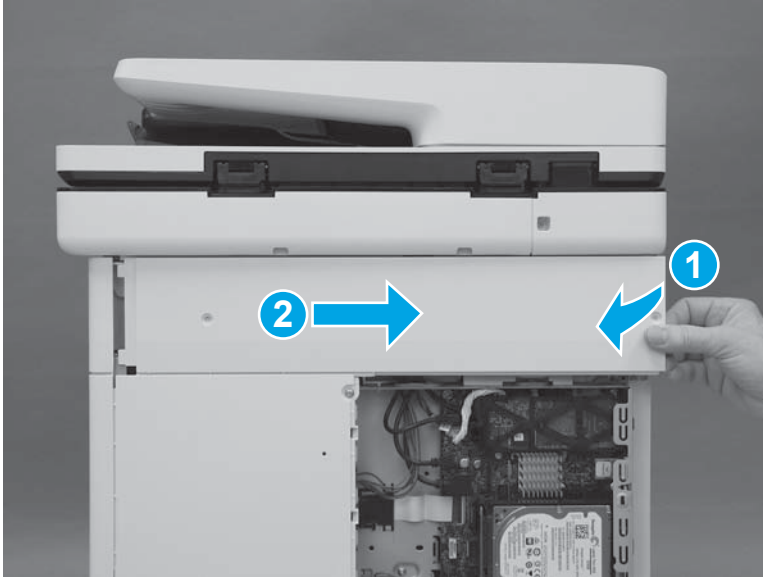

4. Remove the cover.

Figure 1-2509 Remove the cover

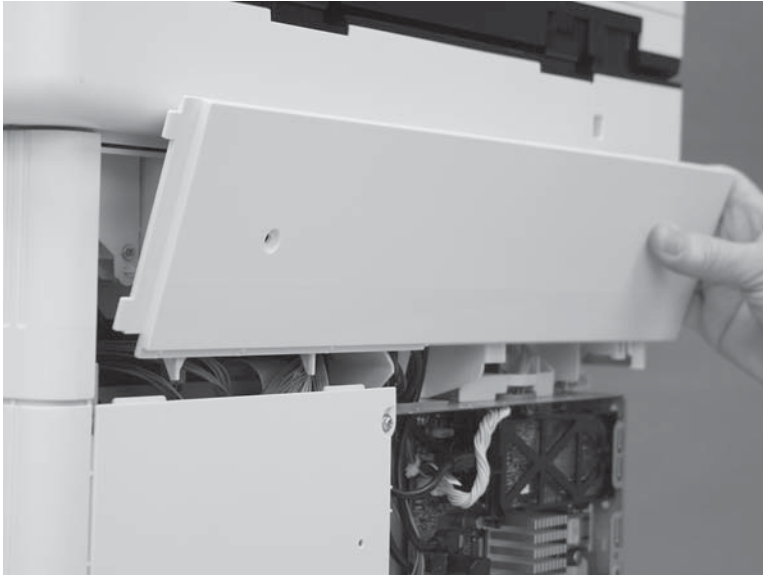

Step 12: Remove the rear cover (M577)



NOTE: This step is for the M577 models. For the M552 and M553 models, skip this step and go to [Step 19: Remove the left cover on page 1441](#).

1. Remove four screws (callout 1).

Figure 1-2510 Remove four screws

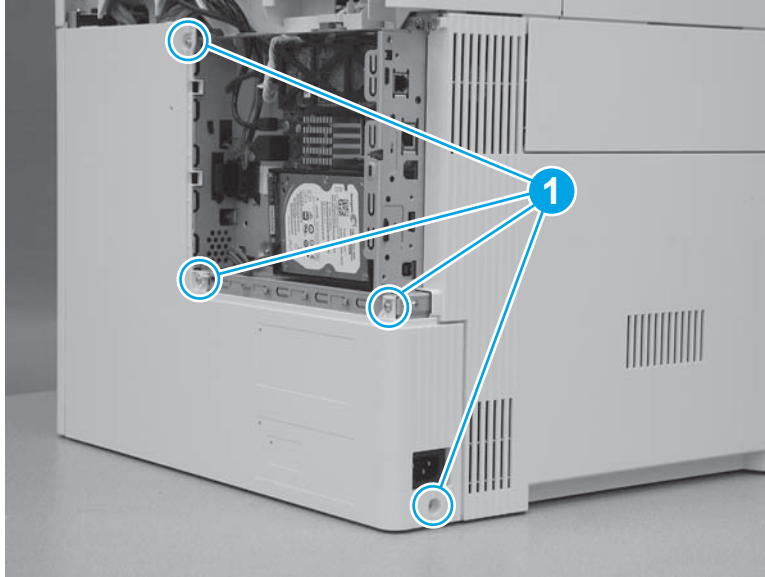

2. Slide the cover to the right to remove it.

Figure 1-2511 Remove the cover

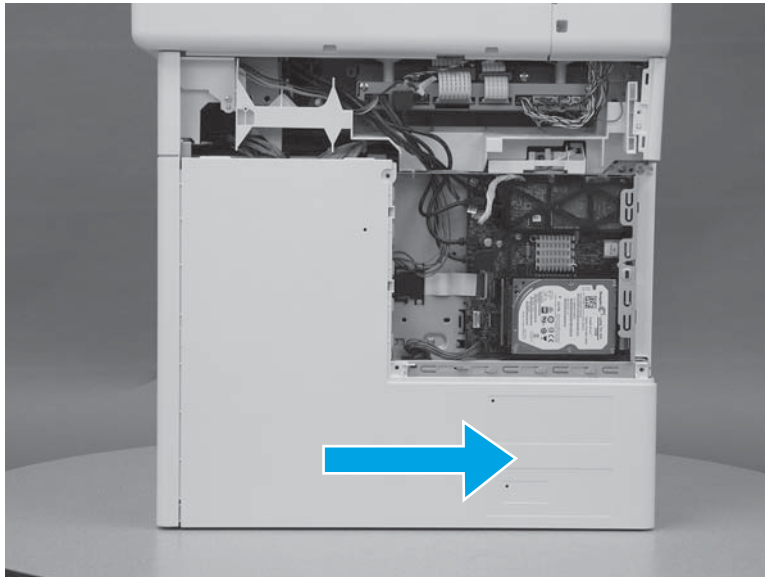

Step 13: Remove the left upper cover (M577)



NOTE: This step is for the M577 models. For the M552 and M553 models, skip this step and go to [Step 19: Remove the left cover on page 1441](#).

1. At the left side of the printer, release one tab (callout 1).

Figure 1-2512 Release one tab

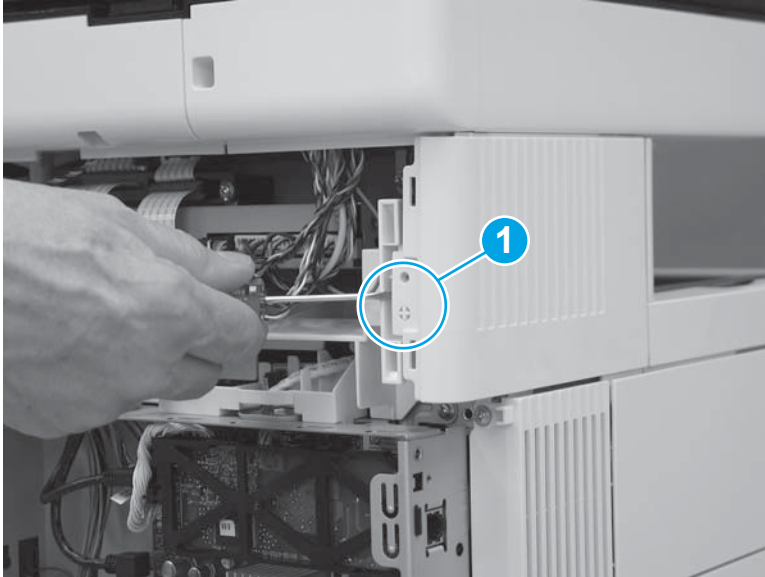

2. Slide the left upper cover toward the back of the printer.

Figure 1-2513 Slide the cover back

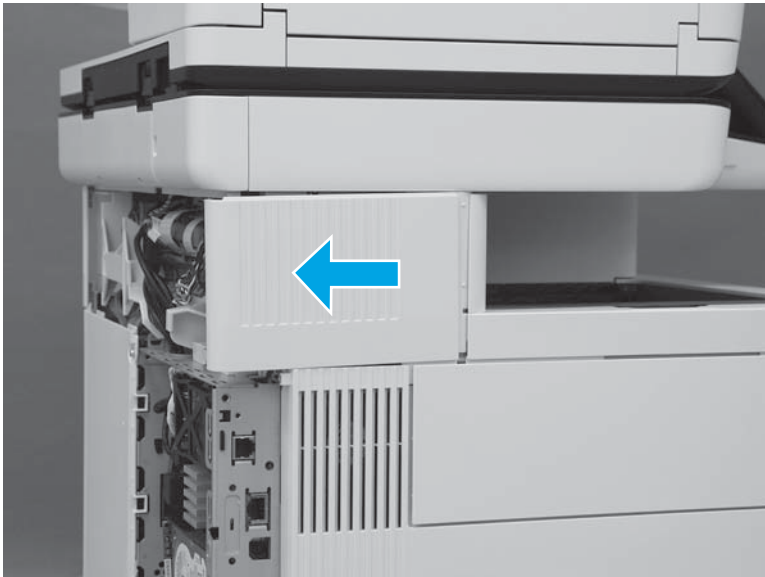

3. Rotate the cover up to remove it.

Figure 1-2514 Remove the left upper cover



Step 14: Remove the right front upper cover (M577dn)

 **NOTE:** This step is for the M577dn model. For the M577c/f/z models, skip this step and go to [Step 15: Remove the stapler cover assembly \(M577c/f/z\) on page 1432.](#)

For the M552 and M553 models, skip this step and go to [Step 19: Remove the left cover on page 1441.](#)

1. Remove one screw (callout 1).

Figure 1-2515 Remove one screw

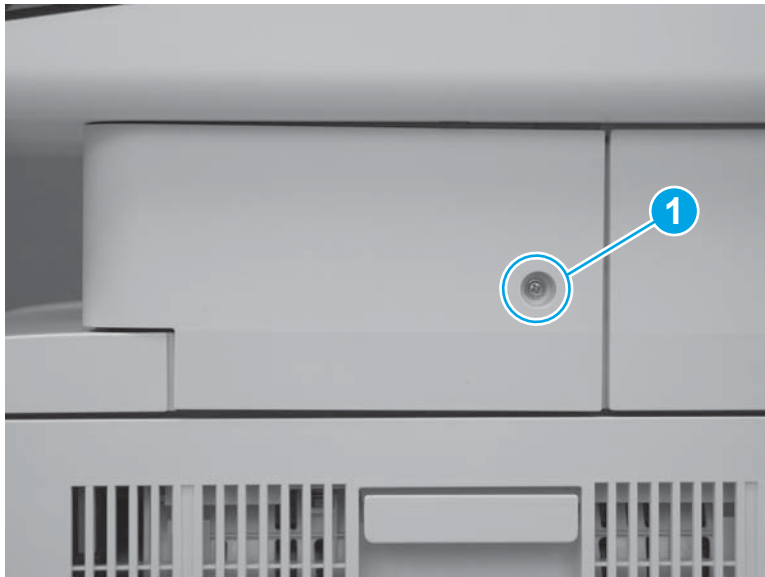

2. Release two tabs at the front edge of the cover (callout 1).

Figure 1-2516 Release two tabs



3. Rotate the front of the cover to the right to remove it.

Figure 1-2517 Rotate the cover



Step 15: Remove the stapler cover assembly (M577c/f/z)



NOTE: This step is for the M577c/f/z models. For the M577dn model, skip this step and go to [Step 17: Remove the right upper cover \(M577\) on page 1437](#).

For the M552 and M553 models, skip this step and go to [Step 19: Remove the left cover on page 1441](#).

1. Remove one screw (callout 1).

 **Reinstallation tip:** This is a self-tapping screw for plastic. When reinstalling, rotate the screw counterclockwise to align it with the existing thread pattern, and then carefully turn it clockwise to tighten. Do not overtighten. This will prevent stripping the threads inside the screw hole.

Figure 1-2518 Remove one screw



2. Release two tabs at the front edge of the cover (callout 1).

Figure 1-2519 Release two tabs

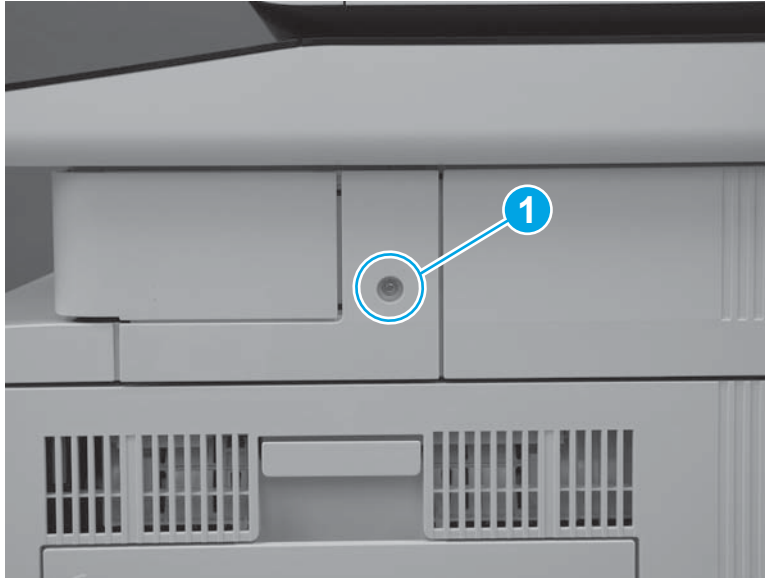

3. Release the back edge of the cover.

Figure 1-2520 Release the back edge of the cover

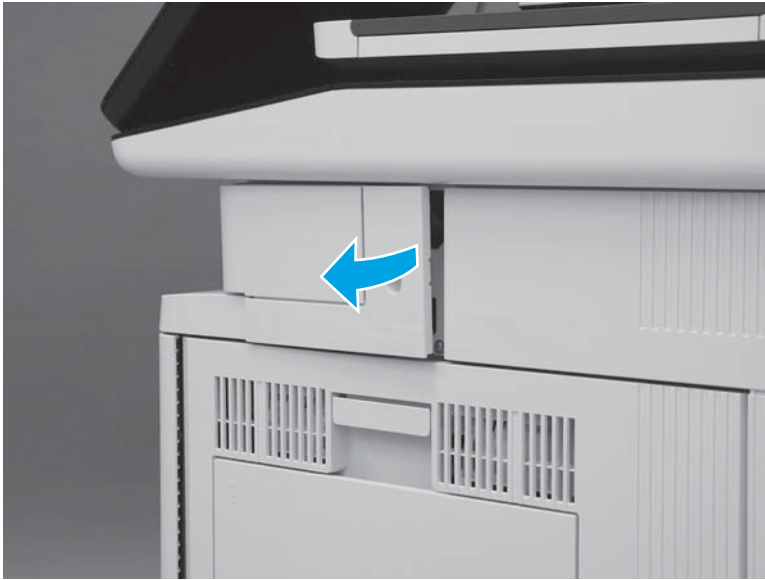



4. Rotate the cover away from the printer to remove it.

Figure 1-2521 Remove the cover



Step 16: Remove the integrated scanner assembly (ISA) (M577)

 **NOTE:** This step is for the M577 models. For the M552 and M553 models, skip this step and go to [Step 19: Remove the left cover on page 1441](#).

 **NOTE:** The ISA includes the document feeder, image scanner, scanner control board (SCB), control panel, keyboard (M577c/z) and NFC PCA (M577z).

1. At the left side of the printer, remove one screw (callout 1).

Figure 1-2522 Remove one screw

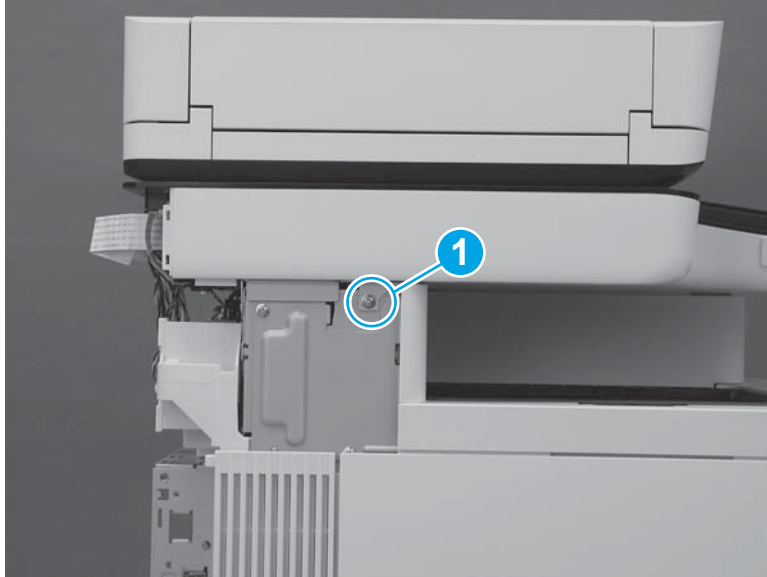

2. At the back side of the printer, remove two screws (callout 1).

Figure 1-2523 Remove two screws

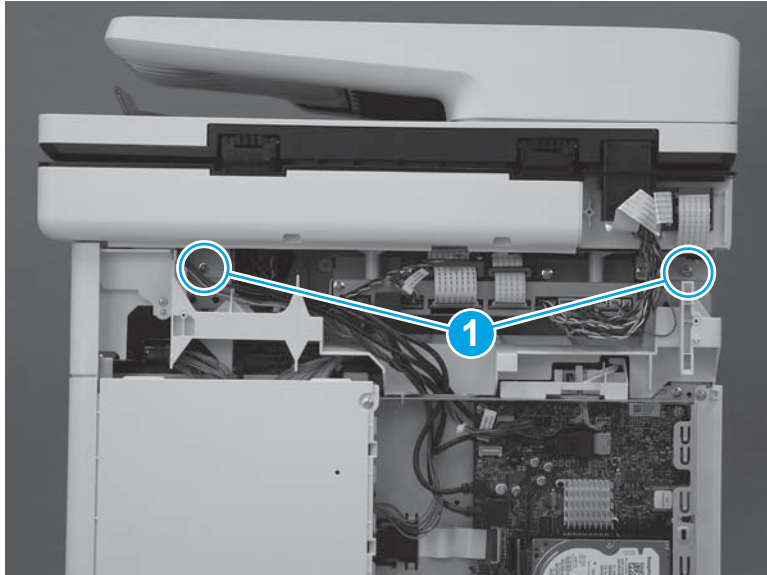

3. At the right side of the printer, remove one screw (callout 1).

Figure 1-2524 Remove one screw

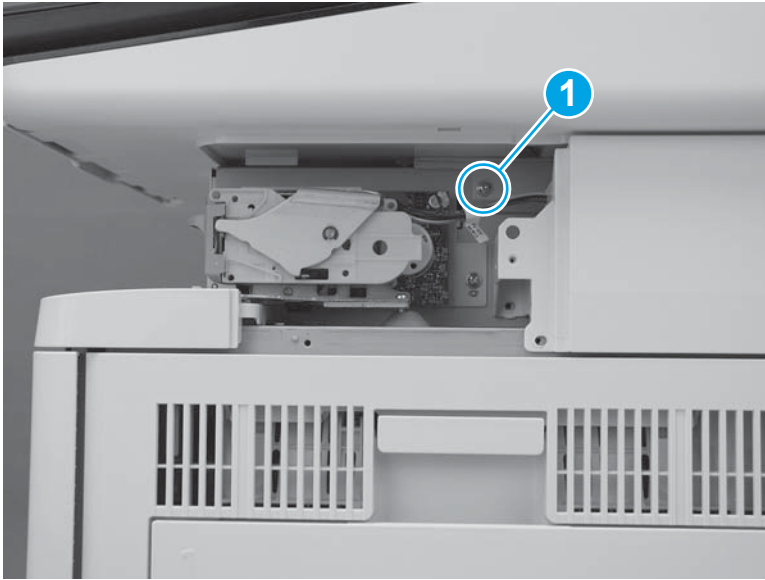

4. Disconnect two connectors on the scanner control board (callout 1).

M577c/f/z only: Disconnect one connector for the stapler on the scanner control board (callout 2).

Figure 1-2525 Disconnect connectors

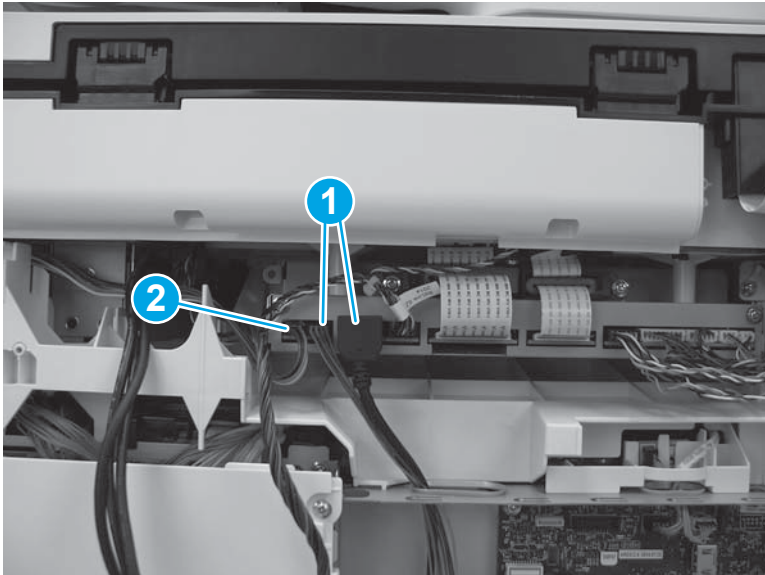

5. Slightly slide the ISA towards the back of the printer to release it.

Figure 1-2526 Slide the ISA towards the back of the printer

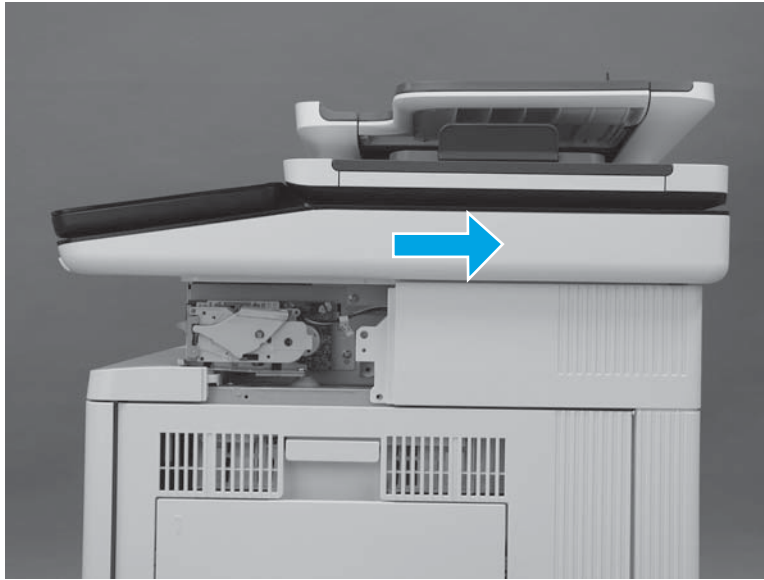

6. Lift the ISA up to remove it.



NOTE: When lifting the ISA, carefully pass the cables through the opening in the top of the formatter case.

Figure 1-2527 Remove the ISA

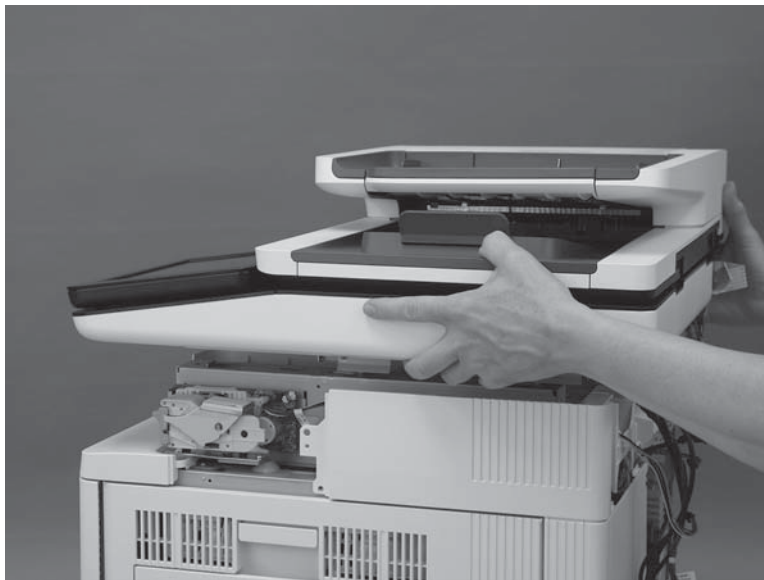

Step 17: Remove the right upper cover (M577)



NOTE: This step is for the M577 models. For the M552 and M553 models, skip this step and go to [Step 19: Remove the left cover on page 1441](#).

 **NOTE:** The figures below show the image scanner installed. The procedures for removing and installing the right upper cover are the same whether the image scanner is installed or removed."

1. At the right side of the printer, remove two screws (callout 1).

M577c/f/z only: Disconnect one connector (callout 2), if it was not already disconnected in a previous step.

Figure 1-2528 Remove two screws and one connector

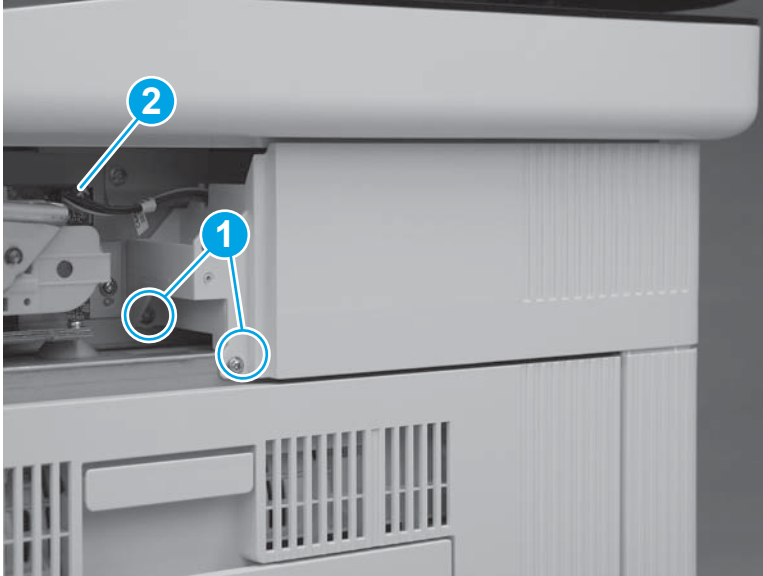

2. At the back of the printer, remove one screw (callout 1).

M577c/f/z only: Disconnect one connector (callout 2), if it was not already disconnected in a previous step.

 **Reinstallation tip:** This screw is smaller than the screws removed in the previous step. When reinstalling the right upper cover, make sure that this screw is installed in the correct position.

Figure 1-2529 Remove one screw and connector



3. Slide the cover toward the back of the printer.

Figure 1-2530 Slide the cover

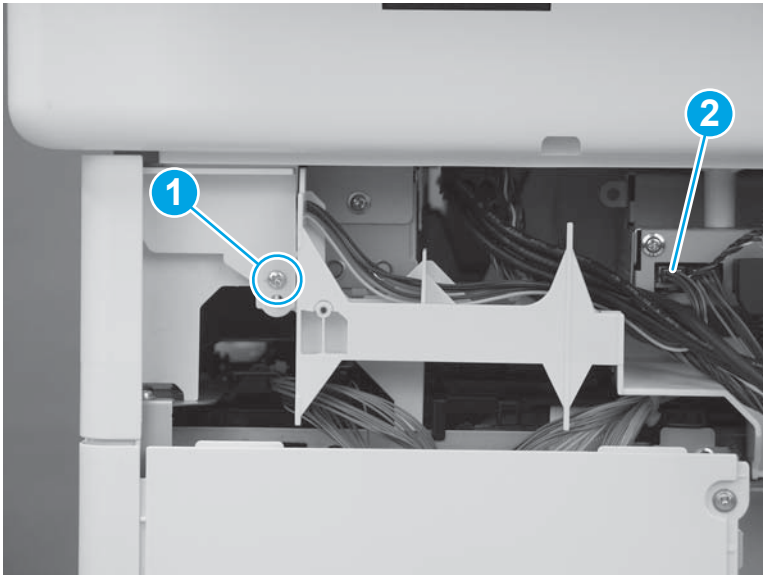
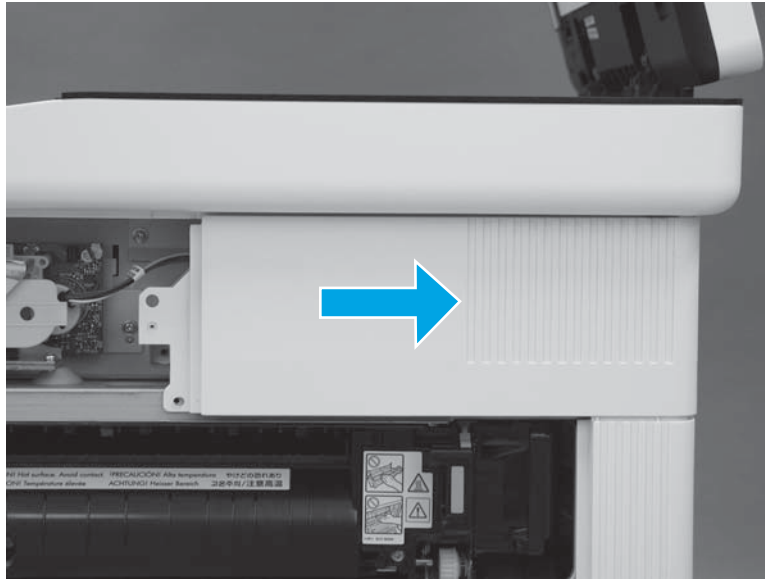

4. Lift the cover away from the printer to remove it.

M577c/f/z only: Release the cables (callout 1) through the slot (callout 2) in the printer.

Figure 1-2531 Remove the cover

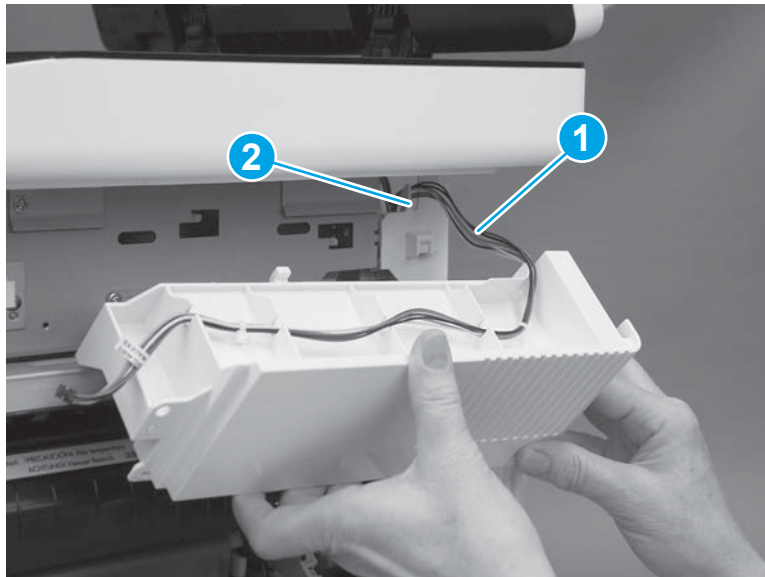

Step 18: Remove the top rear cover (M577)

 **NOTE:** This step is for the M577 models. For the M552 and M553 models, skip this step and go to [Step 19: Remove the left cover on page 1441](#).

1. At the top of the printer, remove five screws (callout 1).

Figure 1-2532 Remove five screws

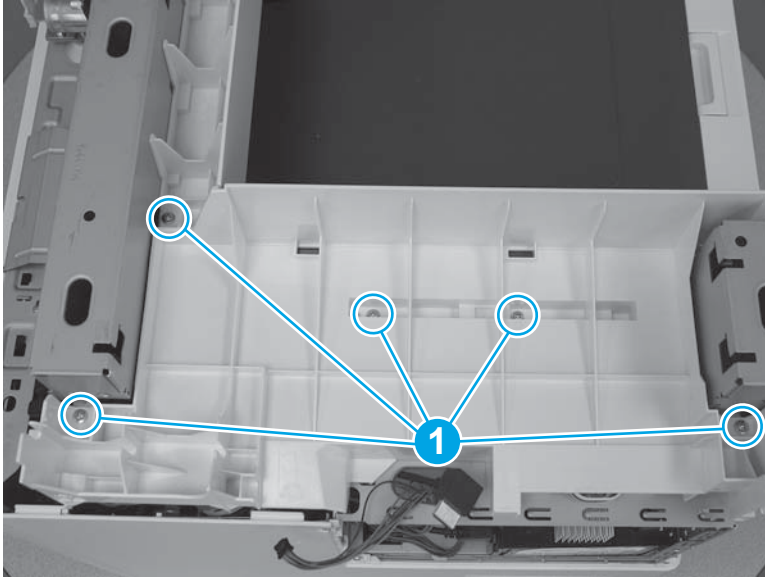

2. Release two tabs (callout 1) on the front edge of the cover.

Figure 1-2533 Release two tabs

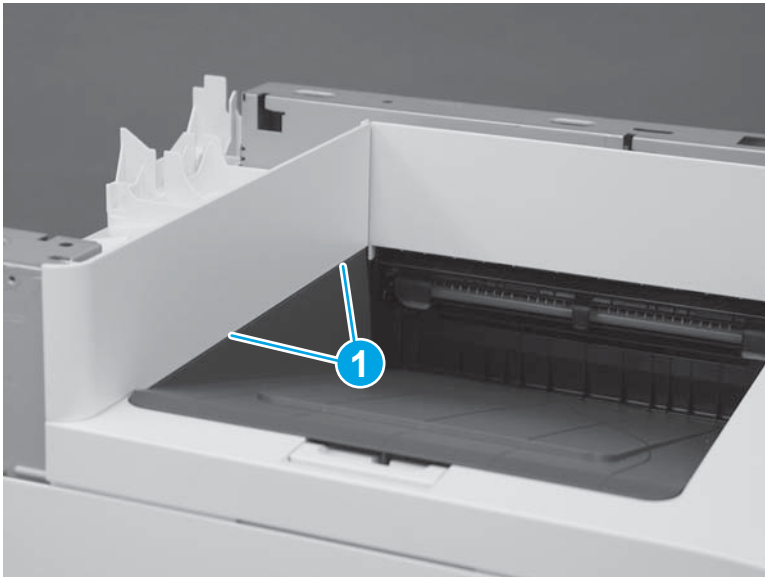

3. Remove the top rear cover.

Figure 1-2534 Remove the top rear cover

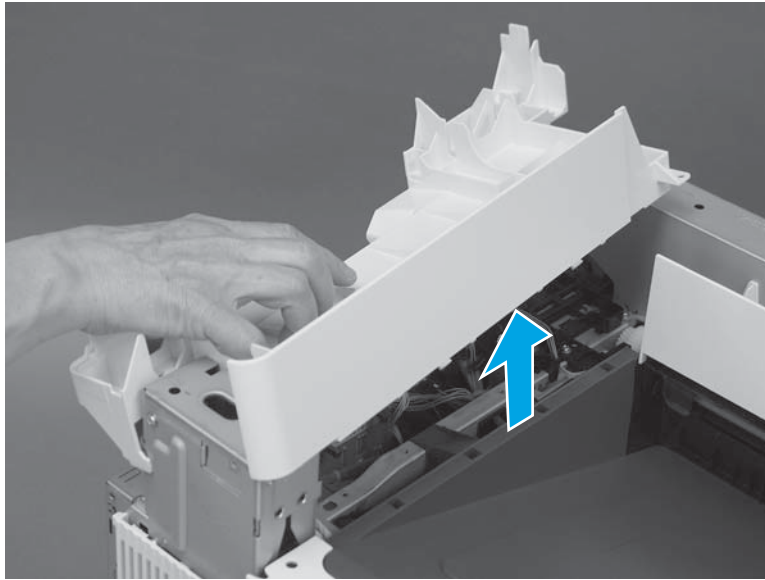

Step 19: Remove the left cover

1. At the left side of the printer, remove one screw (callout 1).

Figure 1-2535 Remove one screw



2. Release one tab (callout 1), rotate the front edge of the cover away from the printer (callout 2), and then slide the cover (callout 3) toward the rear of the printer to release it.

Figure 1-2536 Release the cover

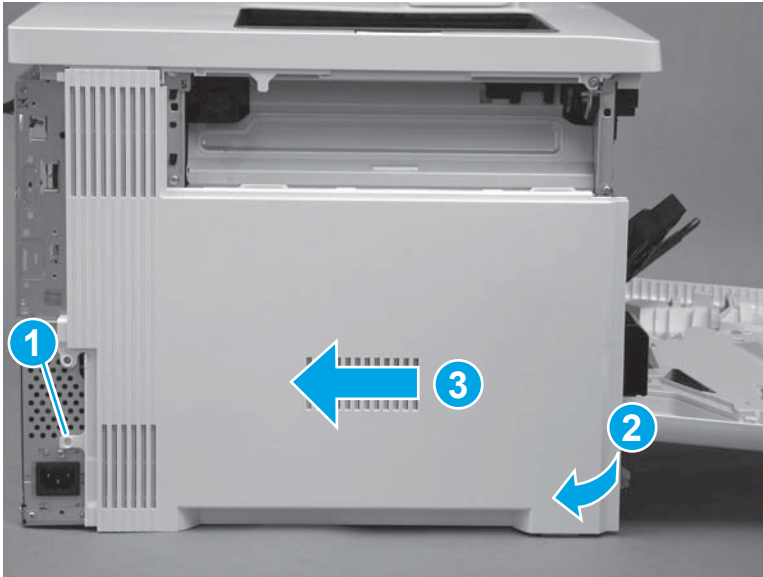

3. Remove the cover.

Figure 1-2537 Remove the cover

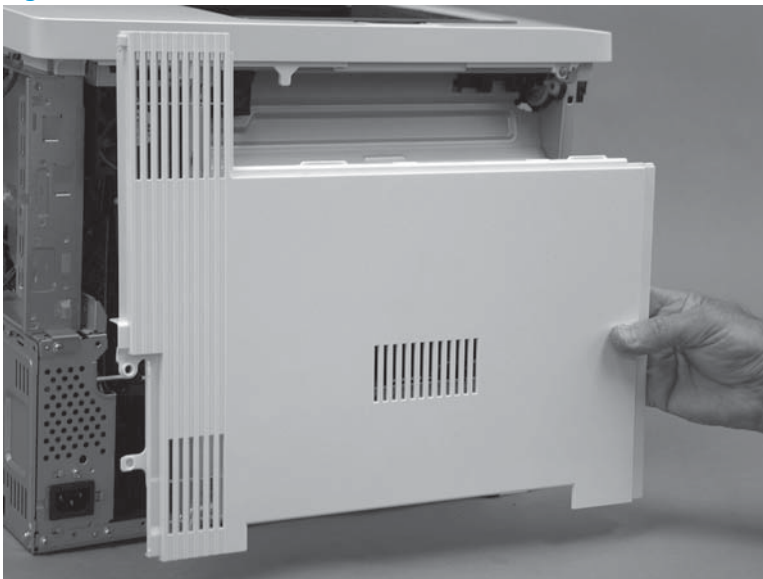

Step 20: Remove the upper cover (M552 and M553)



NOTE: This step is for the M552 and M553 models. For the M577 models, skip this step and go to [Step 21: Remove the formatter case on page 1444](#).

1. Remove three screws (callout 1).

Figure 1-2538 Remove three screws

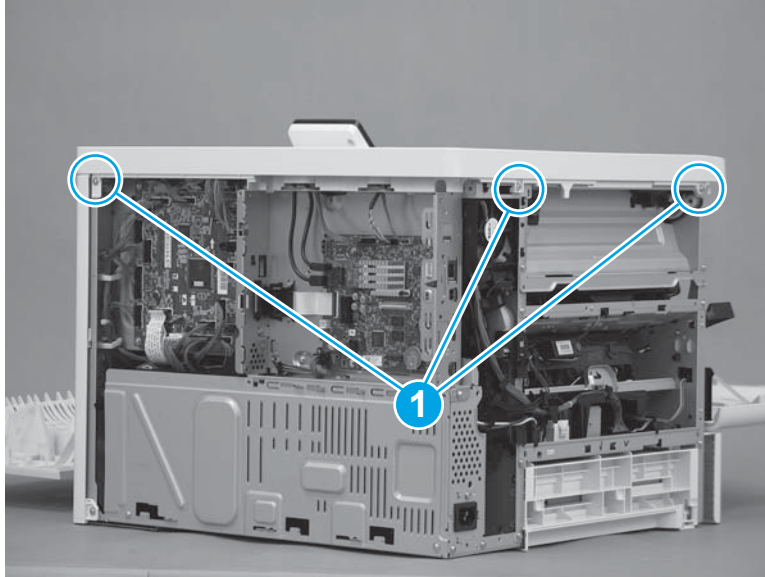

2. Remove one screw (callout 1), release one tab (callout 2), and then slightly separate the corner of the cover from the chassis.

 **NOTE:** This is a self-tapping plastic-thread screw. Make sure that this screw is used in this location when it is reinstalled.

Figure 1-2539 Remove one screw and release one tab



3. Release one tab (callout 1), and then lift up on the cover to release it.

 **NOTE:** If the cover does not release, check for additional tabs by locating the triangles embossed in the cover at tab locations.

Figure 1-2540 Release the cover



4. Remove the cover.

Figure 1-2541 Remove the cover

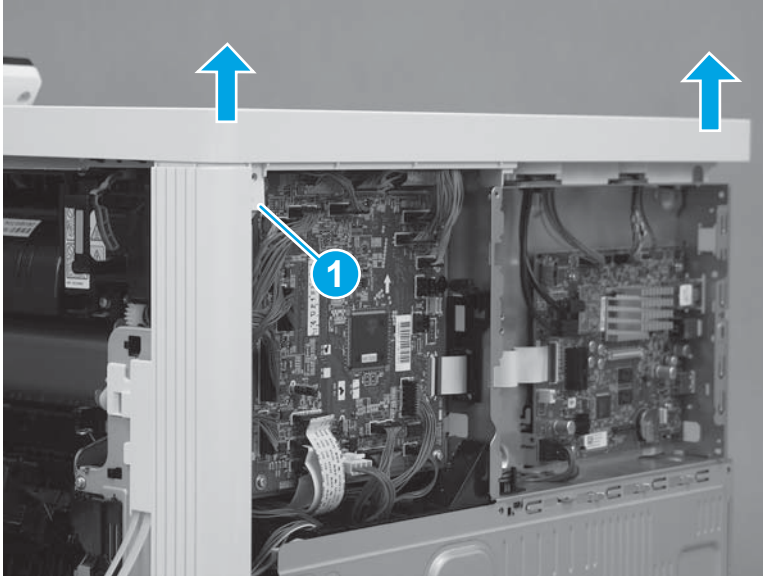
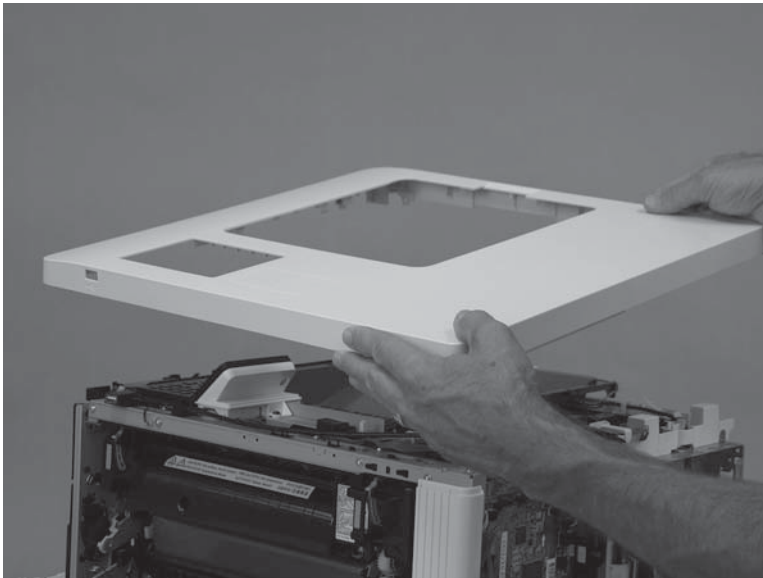

Step 21: Remove the formatter case

1. **M577 only:** Disconnect one connector (callout 1), and then pass the wire harness (callout 2) through two openings in the formatter case (callout 3).

Figure 1-2542 Disconnect one connector

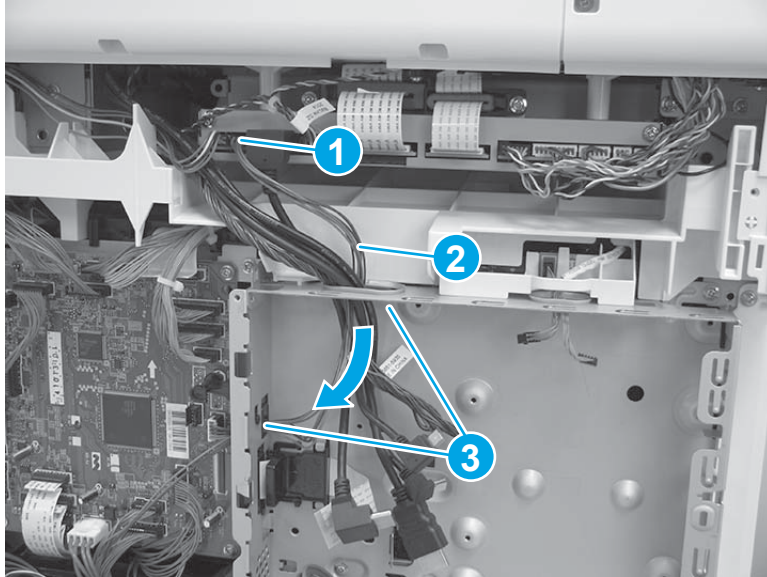

2. Release two tabs (callout 1) on the black plastic bracket. Hold the tabs in the released position, and then slide the bracket (callout 2) to the right to remove it from the formatter case.

Figure 1-2543 Remove the bracket

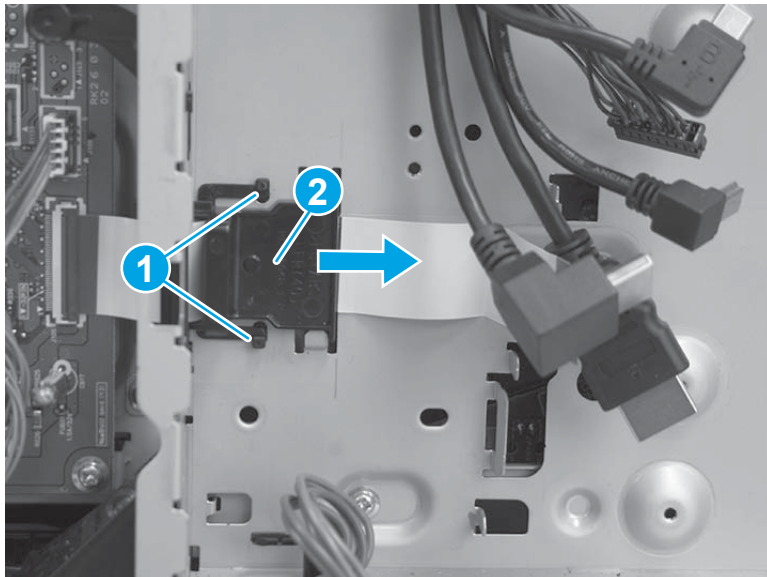

3. Remove two screws (callout 1), and then slide the low-voltage power supply (LVPS) cover to the right to remove it.

Figure 1-2544 Remove the LVPS cover

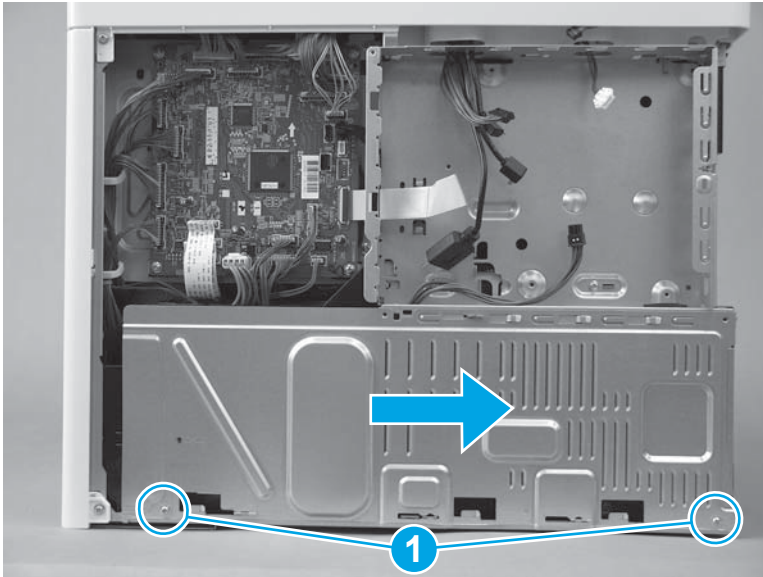

4. Pass two wire harnesses and one flat cable (callout 1) through the opening in the formatter case, and then release one wire harness from the retainer (callout 2).

CAUTION: The flat cable might be attached to the formatter case with double-sided tape. Make sure that this tape is released, so that the flat cable is not damaged when the formatter case is removed.

Figure 1-2545 Release wire harnesses and flat cable

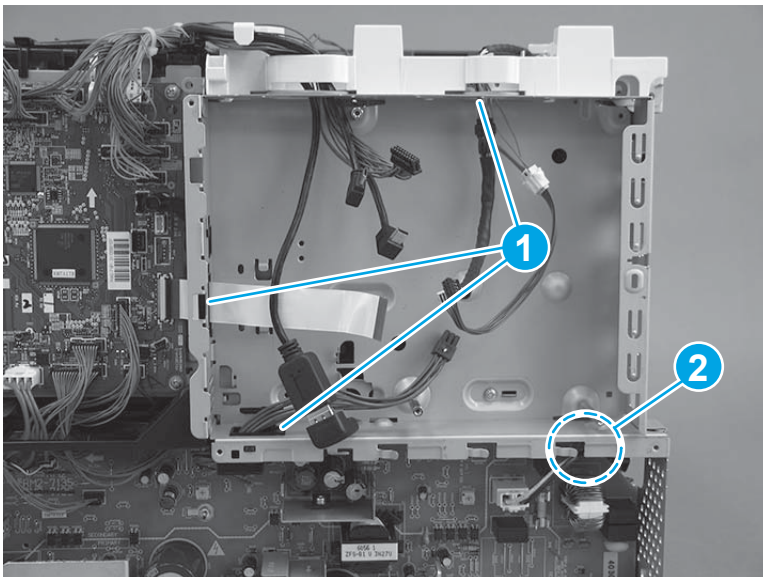

5. Remove six screws (callout 1).

Figure 1-2546 Remove six screws

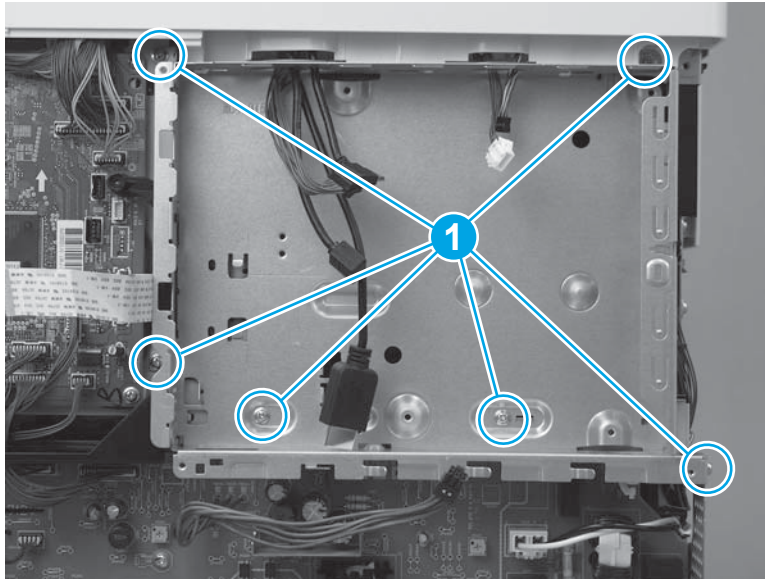

6. Rotate the bottom of the formatter case away from the printer (callout 1), and then pull it down (callout 2) to release it.

Figure 1-2547 Release the formatter case

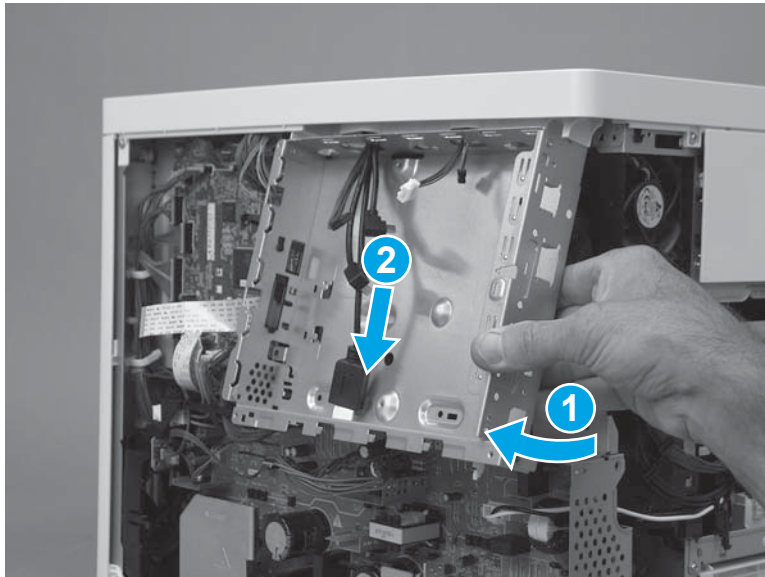

7. Pass the wire harnesses through the opening in the formatter case to remove it.

 **IMPORTANT:** If the formatter case is removed so that it can be replaced, make sure to transfer the memory PCA (island of data) and plastic bracket (callout 1) to the replacement case.

Figure 1-2548 Remove the formatter case



Step 22: Remove the right rear cover

1. Remove one screw (callout 1), and then slide the cover toward the rear of the printer (callout 2) to release it.

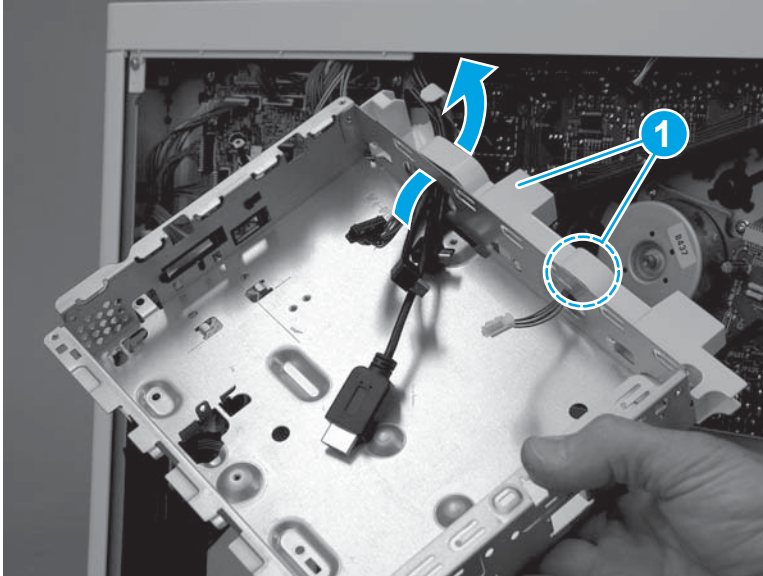
 **TIP:** If the right door is closed, open it now.

Figure 1-2549 Release the cover

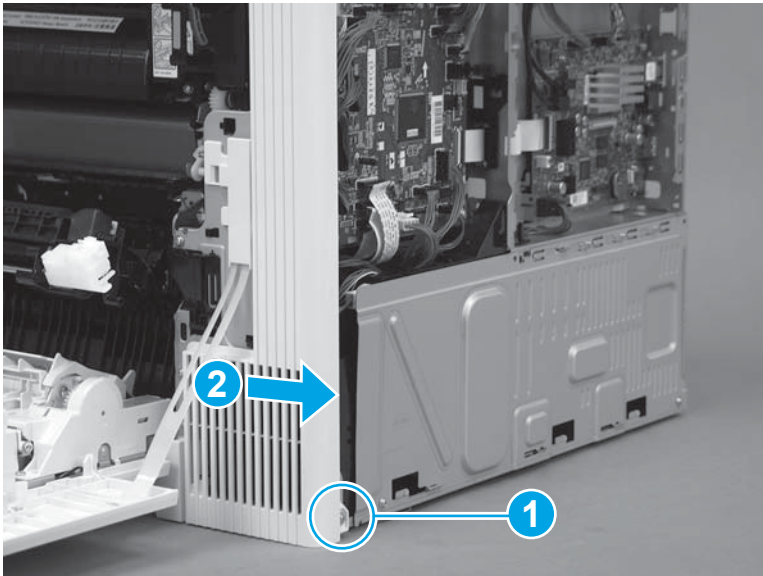

2. Remove the cover.

Figure 1-2550 Remove the cover

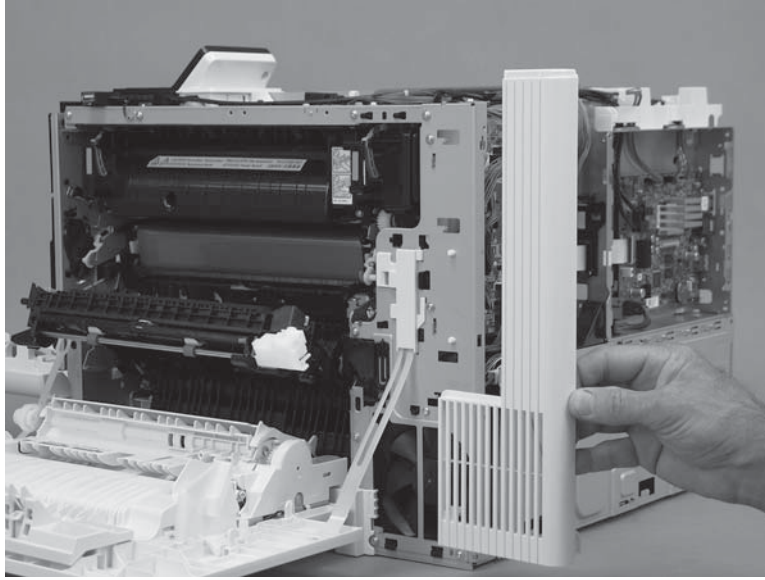

Step 23: Remove the DC controller and sheet-metal bracket

CAUTION:  ESD sensitive part.

1. Disconnect all of the connectors, and then remove two screws (callout 1).

The following connectors are empty:

- J140, J141, and J143

Figure 1-2551 Remove two screws

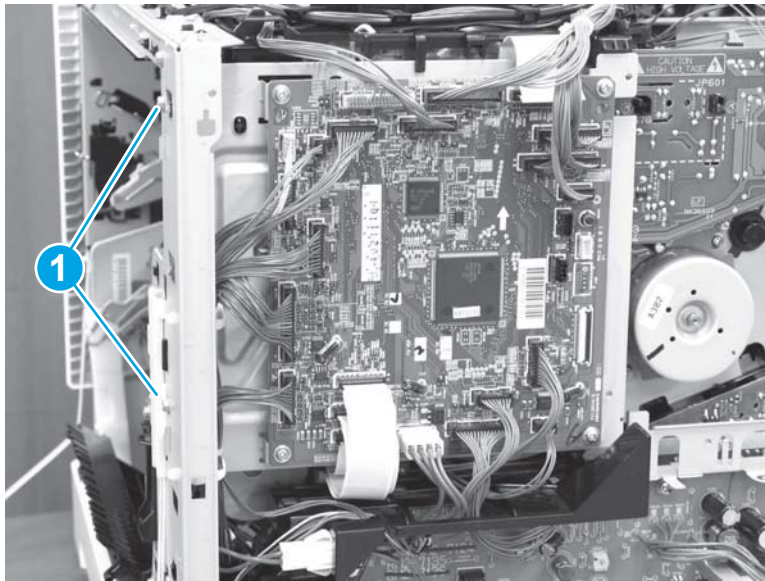

2. Lift up on the DC controller and sheet-metal plate to remove it.

Figure 1-2552 Remove the plate

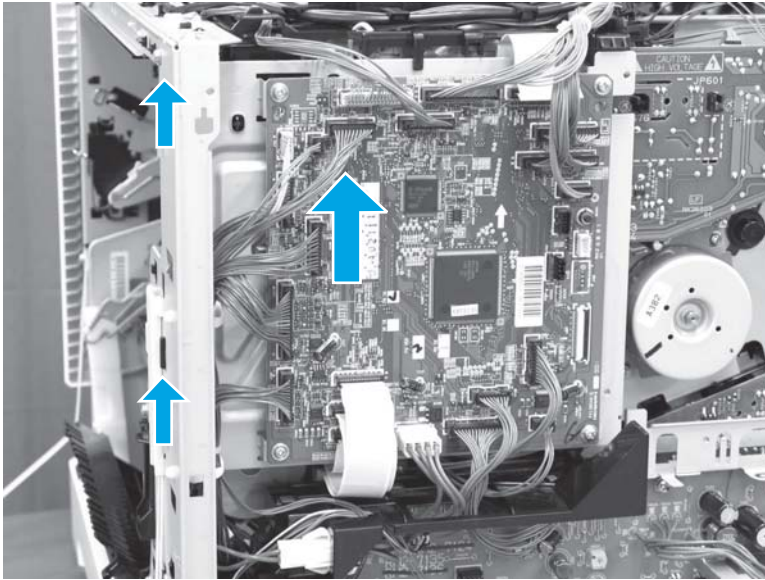

Step 24: Remove the high-voltage power supply T (HVPST)

 **CAUTION:**  ESD-sensitive part.

1. Disconnect five connectors (callout 1), and then disconnect one flat cable (callout 2).

Figure 1-2553 Disconnect five connectors and one flat cable

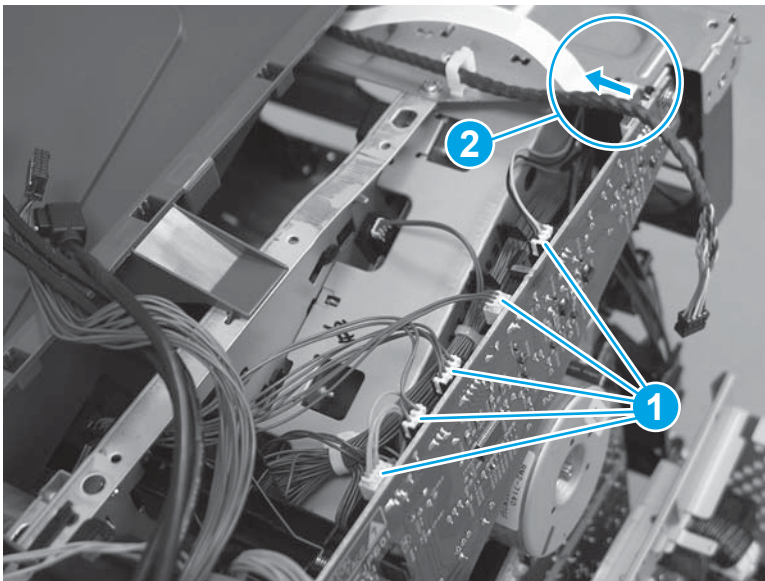

2. Remove one screw (callout 1).

Figure 1-2554 Remove one screw

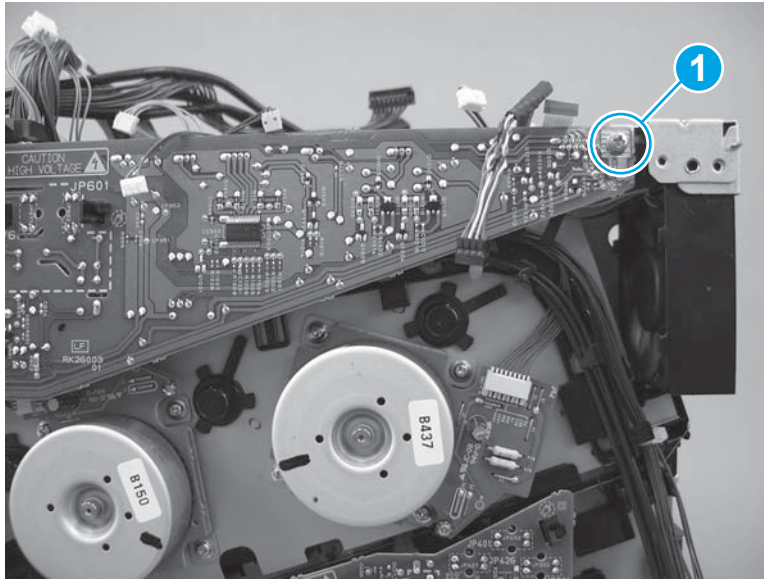

3. Release two tabs (callout 1), and then separate the HVPST from the printer.

⚠ CAUTION: Do not attempt to completely remove the HVPST. It is still connected to the printer by ground wire harness.

Figure 1-2555 Release the HVPST

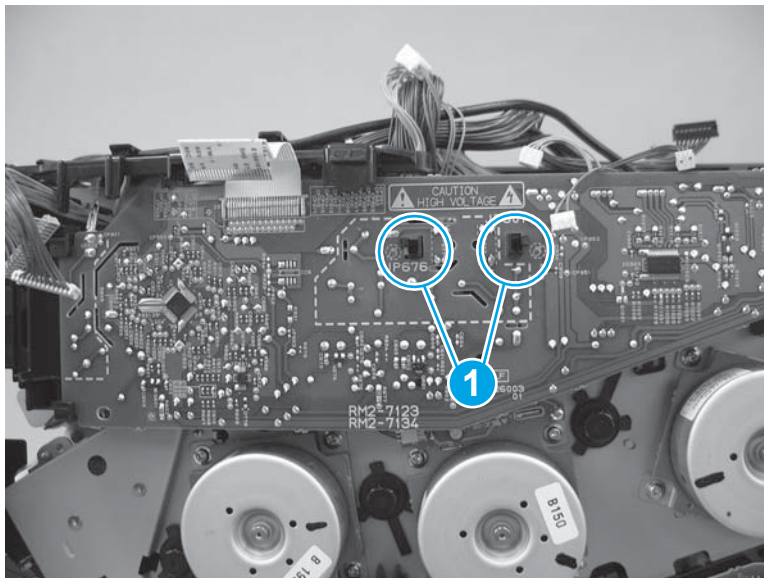

4. Release one ground wire connector (callout 1), and then remove the HVPST.

Figure 1-2556 Remove the HVPST

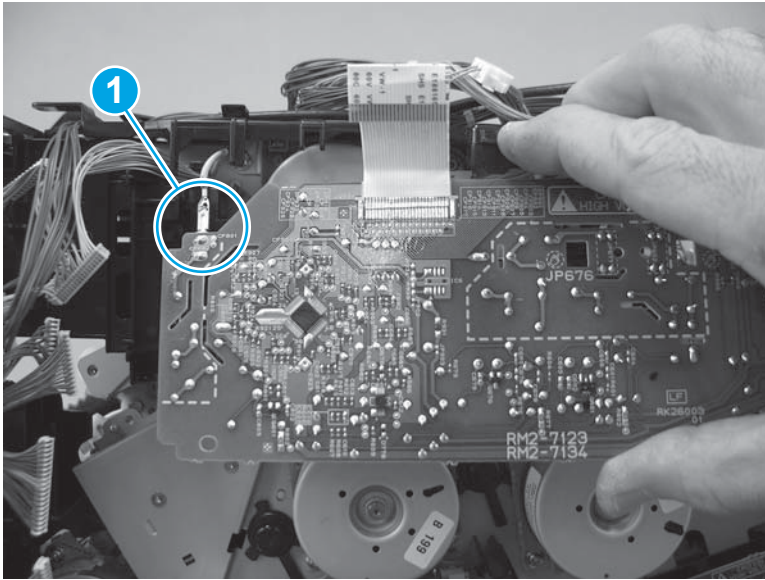

Step 25: Unpack the replacement assembly

Unpack the replacement assembly from the packaging.

CAUTION:  ESD-sensitive part.

For complete information on HP's recycling programs, go to [Product return and recycling](#).

NOTE:  HP recommends responsible disposal of the defective assembly.

Figure 1-2557 Recycle and unpack



Step 26: Install the HVPST

 **CAUTION:**  ESD-sensitive part.

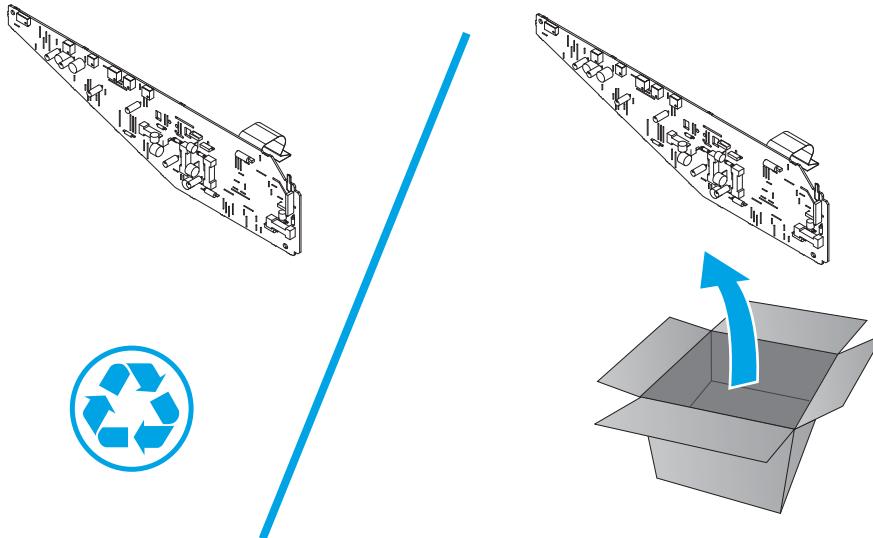
1. Connect one ground wire connector (callout 1).

Figure 1-2558 Connect one ground wire

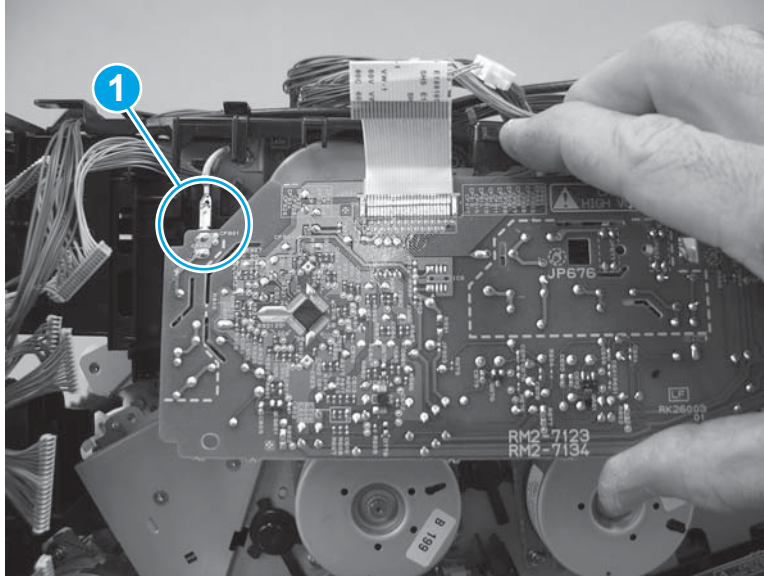

2. Position the HVPST on the printer, and then push in to engage two tabs (callout 1).

 **NOTE:** Make sure that the tabs snap into place.

Figure 1-2559 Install the HVPST



3. Install one screw (callout 1).

Figure 1-2560 Install one screw

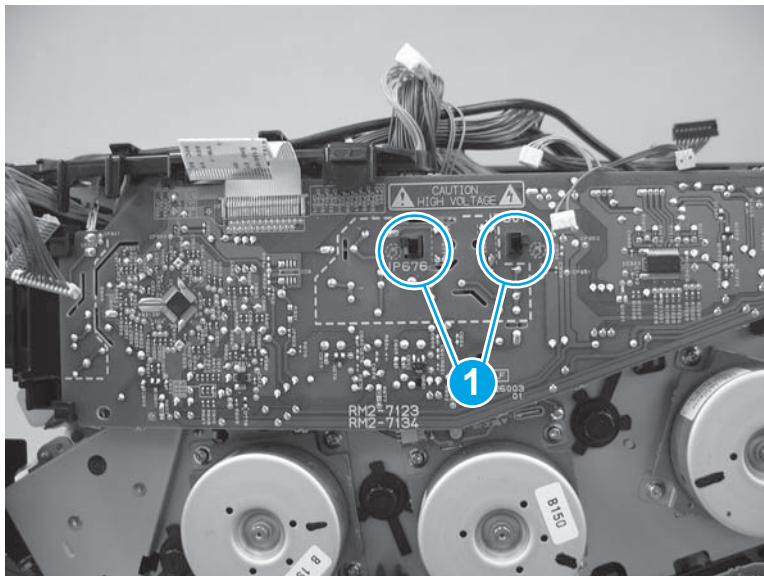
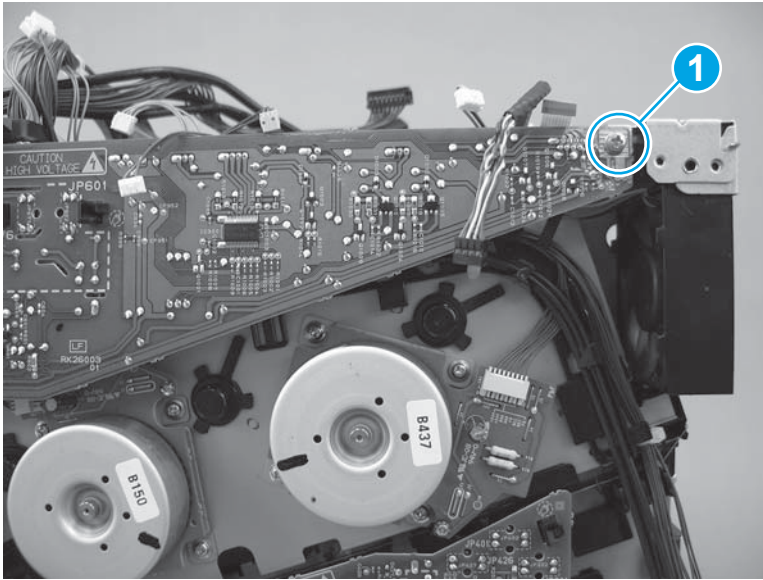

4. Connect five connectors (callout 1), and then connect one flat cable (callout 2).

Figure 1-2561 Connect five connectors and one flat cable

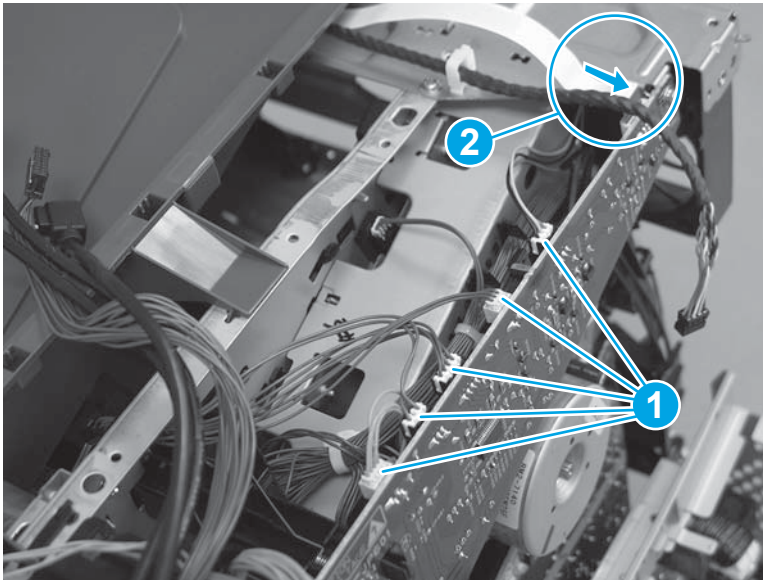

Step 27: Install the DC controller and sheet-metal bracket

 **CAUTION:**  ESD-sensitive part.

1. Position the DC controller and sheet-metal plate on the printer, and then push down to engage the plate with the chassis.

Figure 1-2562 Install the plate

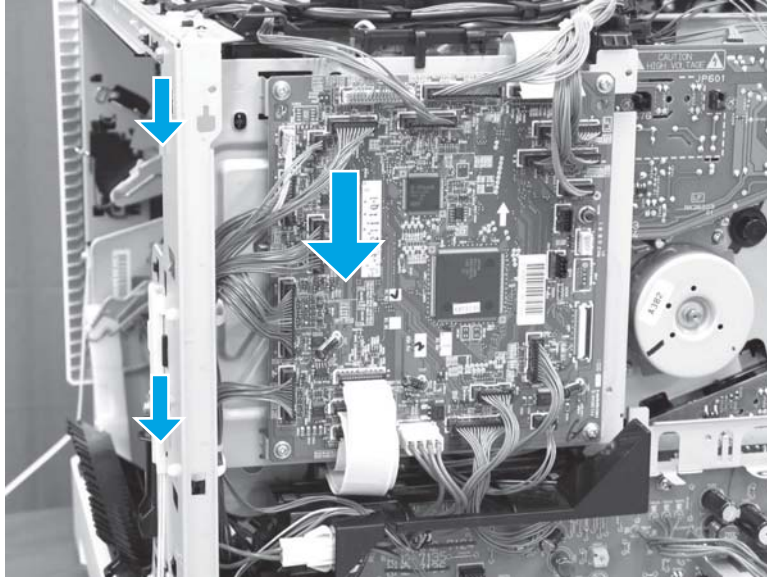

2. Install two screws (callout 1), and then connect all of the connectors.

The following connectors are empty:

- J140, J141, and J143

Figure 1-2563 Install two screws

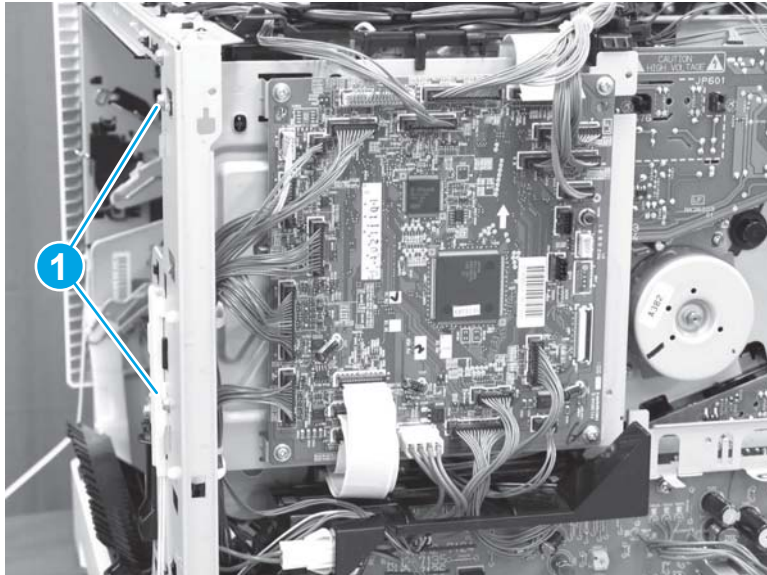

Step 28: Install the right rear cover

1. Position the cover on the printer.

Figure 1-2564 Install the cover

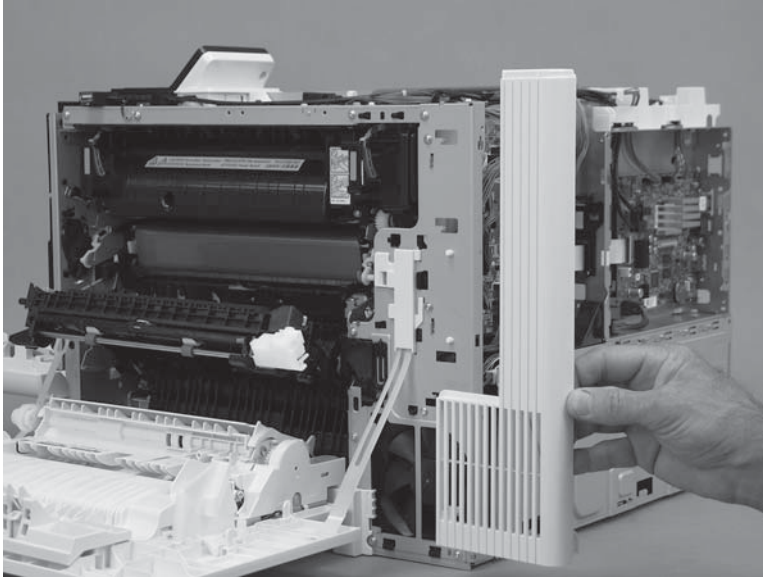

2. Slide the cover toward the right door (callout 1) to engage it with the printer, and then install one screw (callout 2).

Figure 1-2565 Install one screw

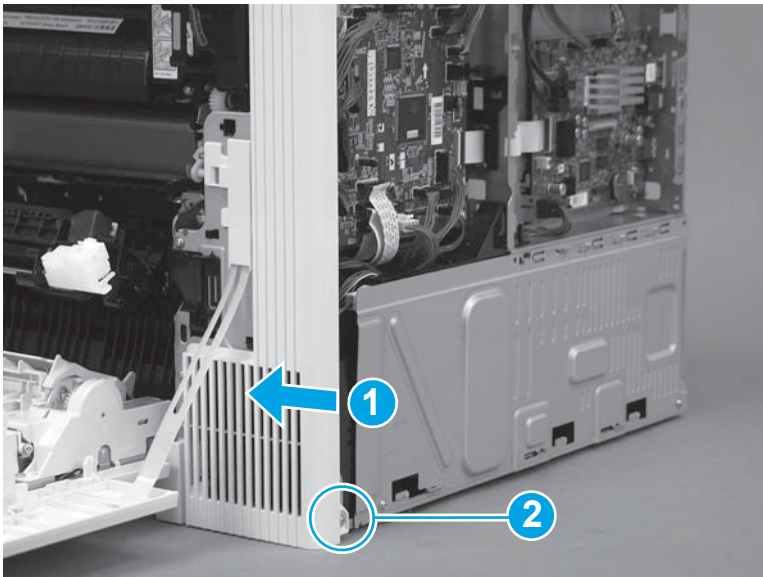

Step 29: Install the formatter case

1. Pass the wire harnesses through the opening in the formatter case.

Figure 1-2566 Pass the wire harnesses through the opening

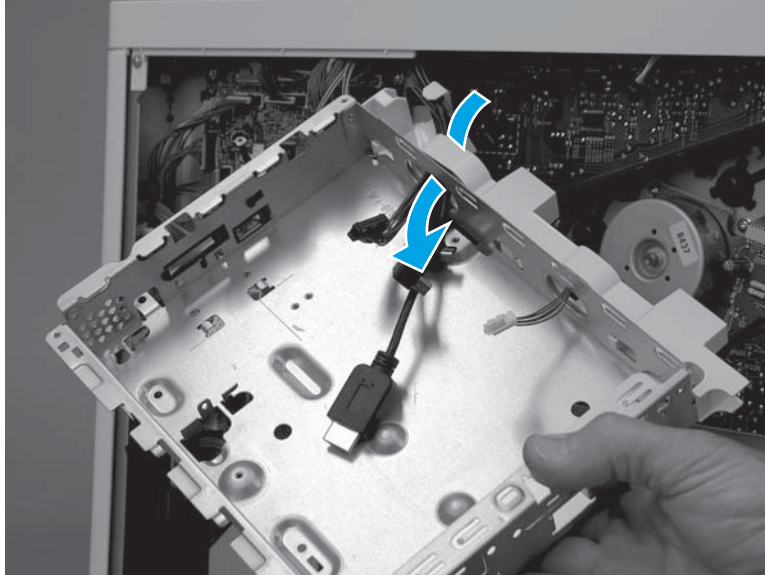

2. Position the top of the formatter case on the printer (callout 1), and then rotate the bottom of the case (callout 2) into the printer.

Figure 1-2567 Install the formatter case

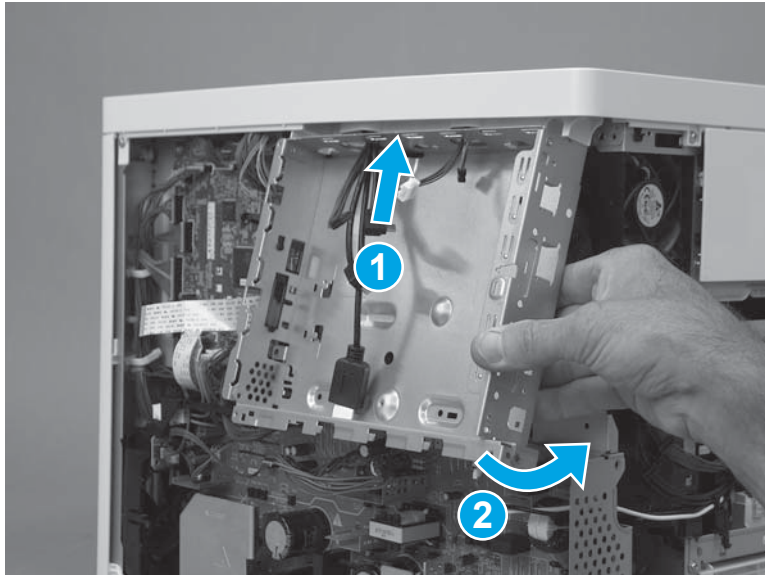

3. Install six screws (callout 1).

Figure 1-2568 Install six screws

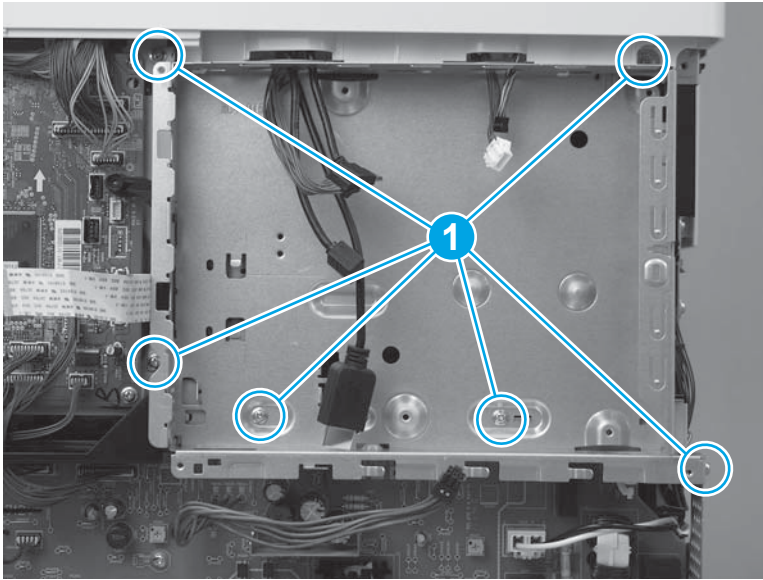

4. Pass two wire harnesses and one flat cable (callout 1) through the opening in the formatter case, and then install one wire harness in the retainer (callout 2).

 **IMPORTANT:** Make sure that the flat cable is securely fastened to the DC controller, and was not dislodged when the formatter case was removed.

Figure 1-2569 Install wire harnesses and flat cable



5. Position the LVPS cover on the printer, slide the cover to the left to install it, and then install two screws (callout 1).

Figure 1-2570 Install the LVPS cover

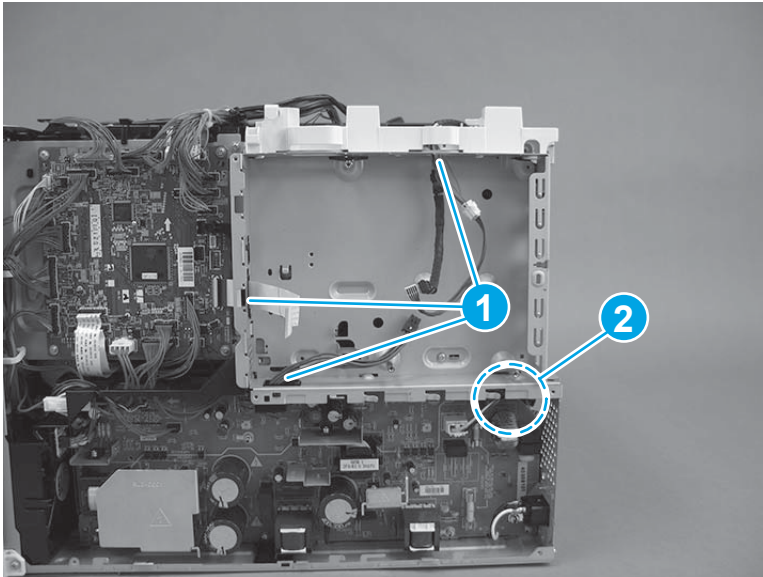
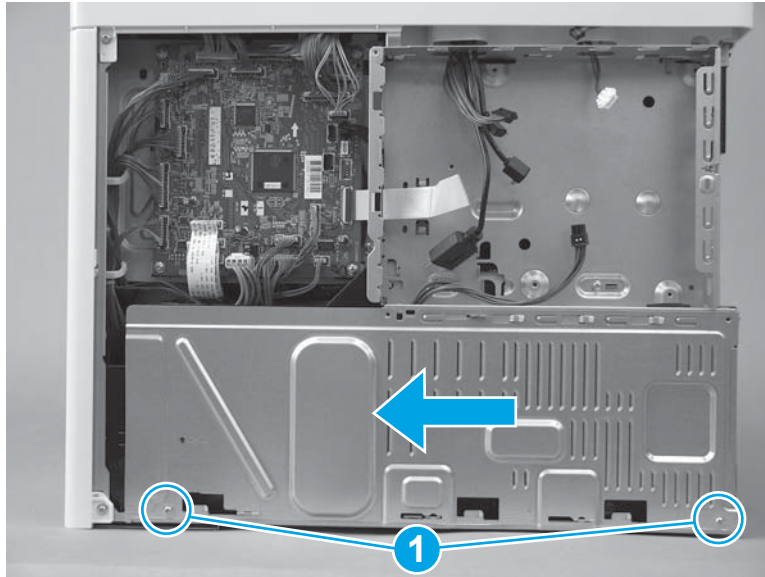

6. If no tape is affixed to the back of the flat cable, skip this step. If double-sided tape is affixed to the back of the flat cable, align the line (callout 1) on the cable with the edge (callout 2) of the opening in the sheet metal. Press to attach the flat cable to the formatter case.

Figure 1-2571 Attach the flat cable

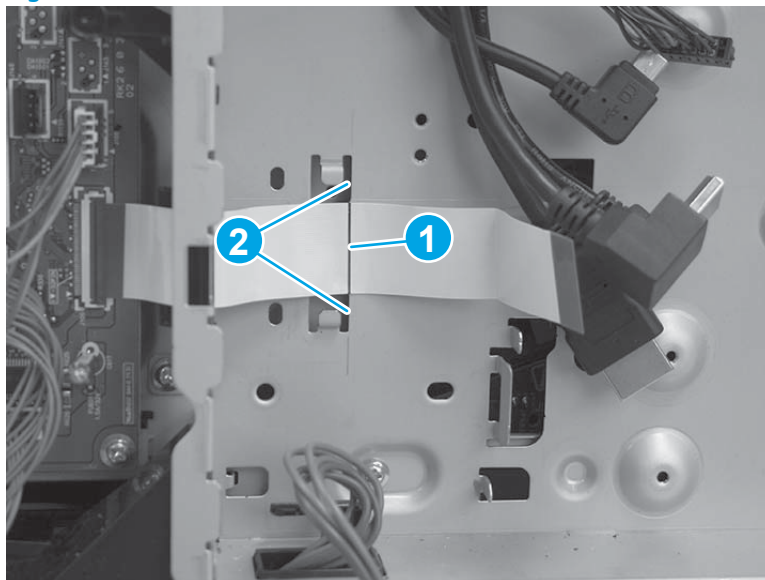

7. Position the bracket over the flat cable, and then slide the bracket to the left to install it. Make sure that the edges of the bracket fit under the sheet metal tabs (callout 1) on the formatter case and that the tabs (callout 2) snap into place.

Figure 1-2572 Position the bracket

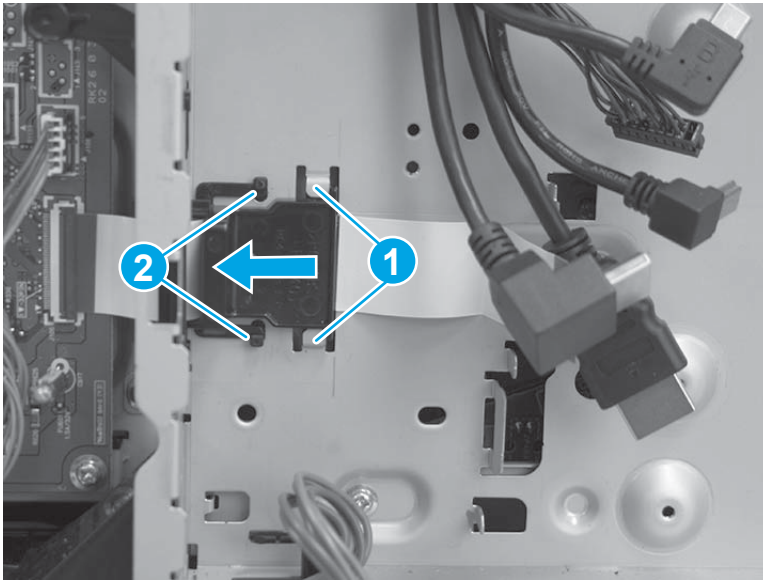

8. **M577 only:** Pass the wire harness (callout 1) through the openings in the formatter case (callout 2), and then connect one connector (callout 3).

Figure 1-2573 Connect one connector

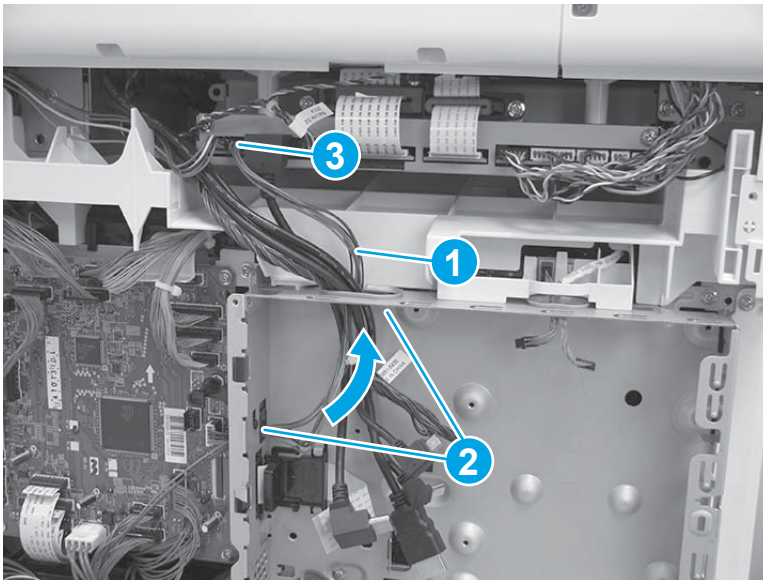

Step 30: Install the upper cover (M552 and M553)

 **NOTE:** This step is for the M552 and M553 models. For the M577 models, skip this step and go to [Step 31: Install the left cover on page 1462](#).

1. Position the cover on the printer.

 **NOTE:** For the M553x model, do not forget to pass the control-panel wire harness and USB cable through the opening in the cover.

Figure 1-2574 Install the cover



2. Push down on the rear corner of the cover to engage one tab (callout 1).

Figure 1-2575 Engage one tab

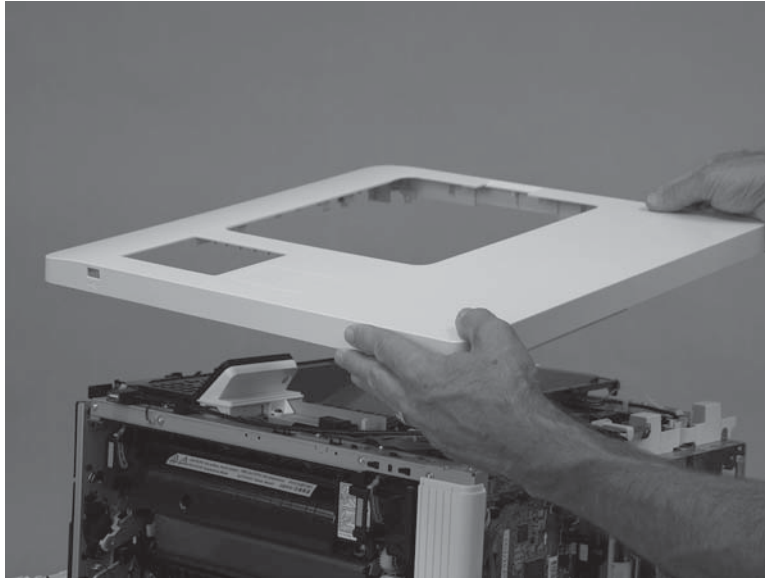
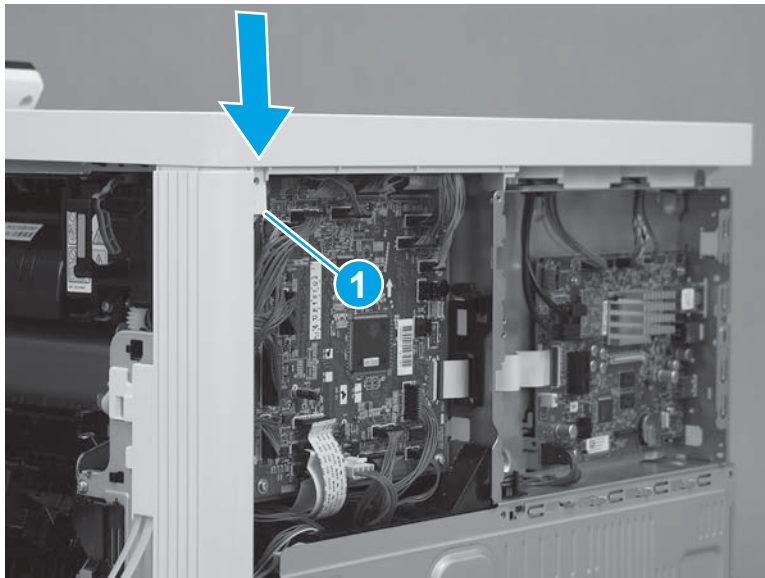

3. Push down on the front corner of the cover to engage one tab (callout 1), and then install one screw (callout 2).

 **NOTE:** This is a self-tapping plastic-thread screw. Make sure that this screw is used in this location when it is reinstalled.

Figure 1-2576 Engage one tab and install one screw



4. Install three screws (callout 1).

Figure 1-2577 Install three screws

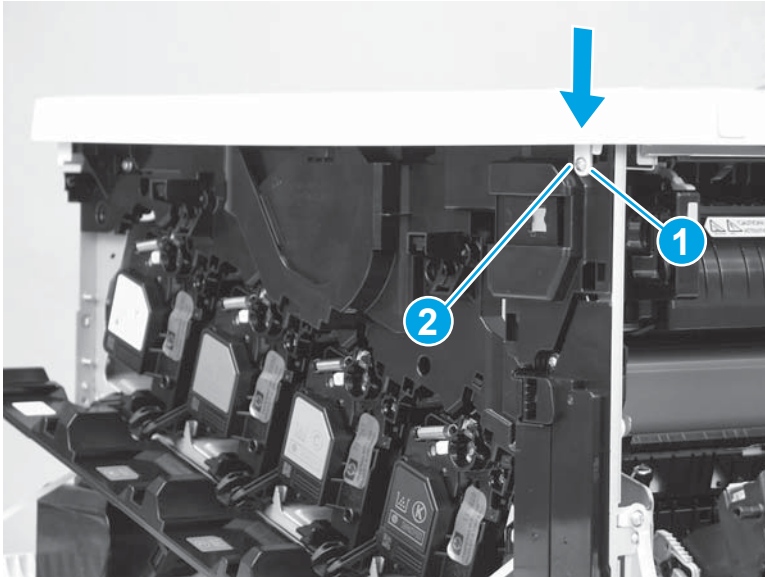
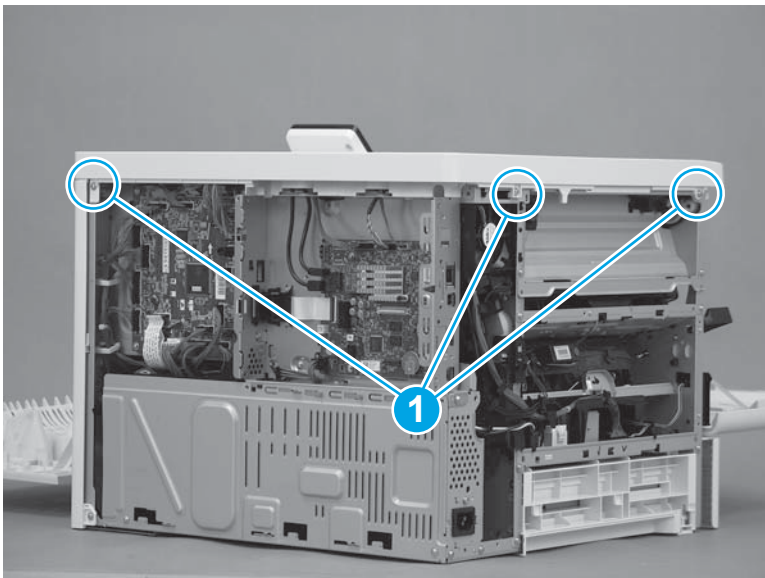

Step 31: Install the left cover

1. Position the cover on the printer.

 **NOTE:** Slightly offset the cover toward the rear of the printer.

Figure 1-2578 Install the cover

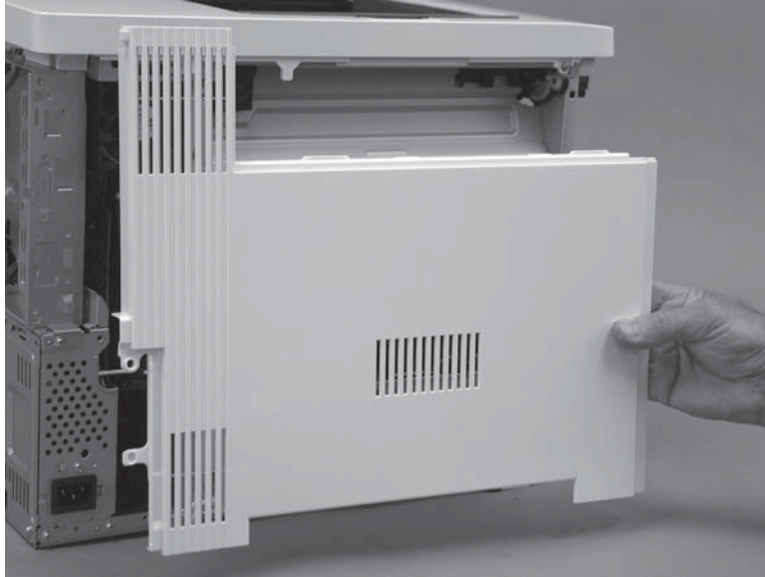

2. Slide the cover (callout 1) toward the front of the printer to engage it. Make sure that the tab (callout 2) snaps into place.

 **NOTE:** Locate the alignment pin (callout 3) on the cover from the front door side of the printer, and then make sure that it is fully engaged in the slot in the chassis.

 **TIP:** While sliding the cover into place, push in on the center of the cover (callout 1) to make sure that the hooks on the back of the cover engage with the slots in the chassis.

Figure 1-2579 Engage the cover



3. At the left side of the printer, install one screw (callout 1).

Figure 1-2580 Install one screw

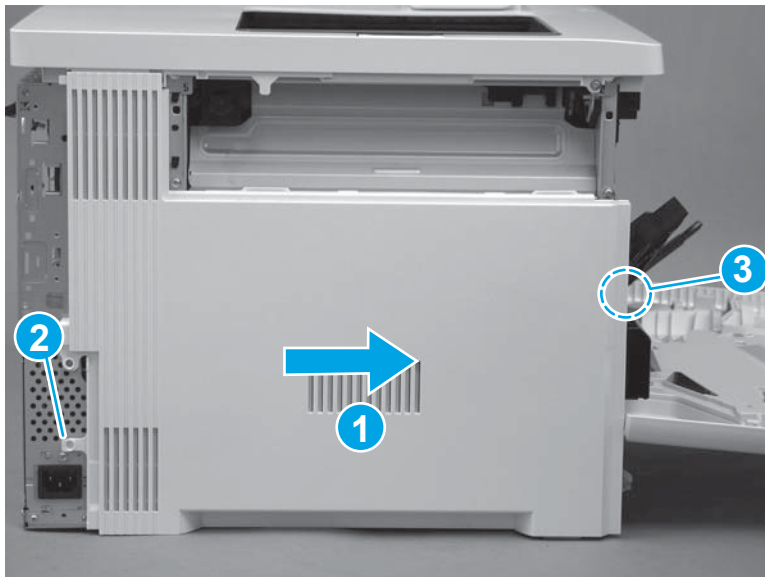

Step 32: Install the top rear cover (M577)



NOTE: This step is for the M577 models. For the M552 and M553 models, skip this step and go to [Step 40: Install the rear cover \(M552 and M553\) on page 1480](#).

1. Align the locator tabs (callout 1) on the cover with the slots (callout 2) in the printer.

Figure 1-2581 Align the locator tabs

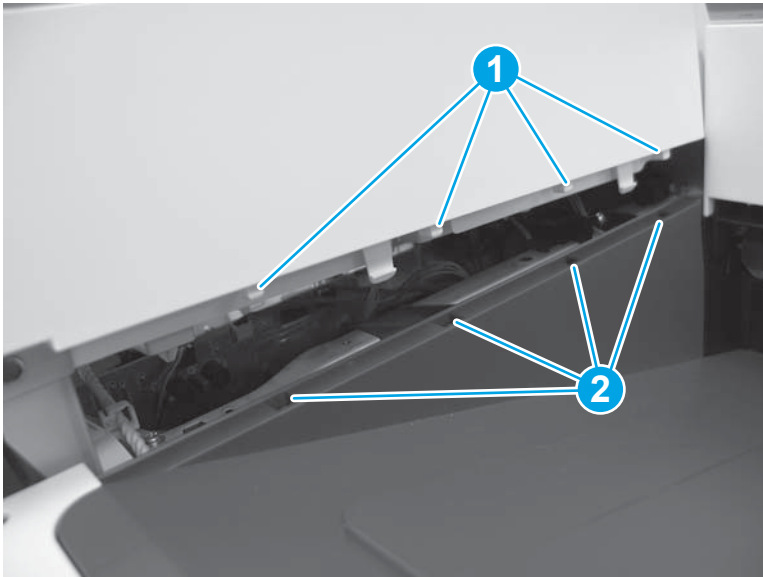

2. Press down to install the cover. Make sure that the tabs snap into place.

Figure 1-2582 Install the cover

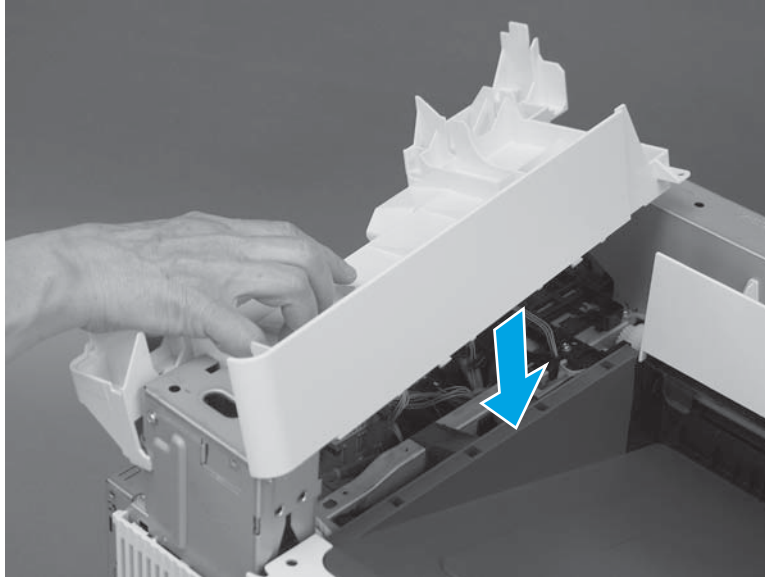

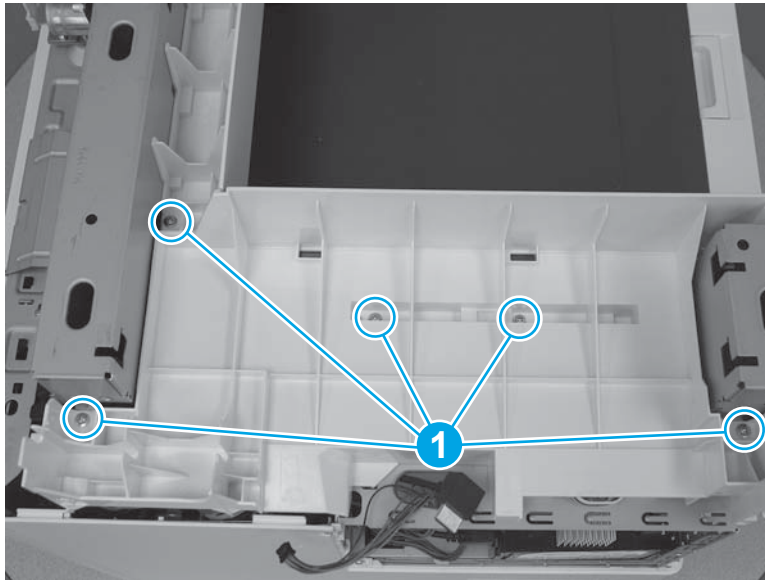

3. At the top of the printer, install five screws (callout 1).

Figure 1-2583 Install five screws



Step 33: Install the right upper cover (M577)

 **NOTE:** This step is for the M577 models. For the M552 and M553 models, skip this step and go to [Step 40: Install the rear cover \(M552 and M553\) on page 1480.](#)

 **NOTE:** The figures below show the image scanner installed. The procedures for removing and installing the right upper cover are the same whether the image scanner is installed or removed."

1. **M577c/f/z only:** Install the cables (callout 1) through the slot (callout 2) in the printer.

Figure 1-2584 Install the cables

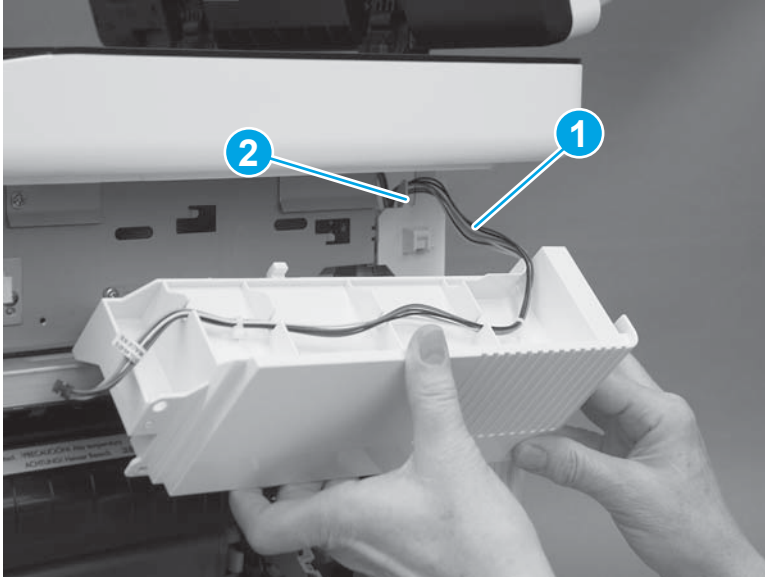

2. Position the hooks (callout 1) on the cover in the slots (callout 2) in the printer.

Figure 1-2585 Position the hooks

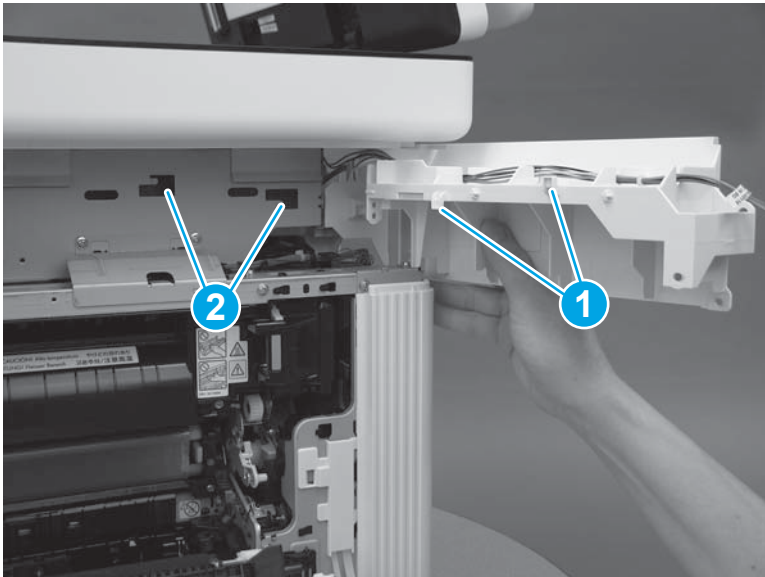

3. Slide the cover toward the front of the printer to install it.

Figure 1-2586 Install the cover

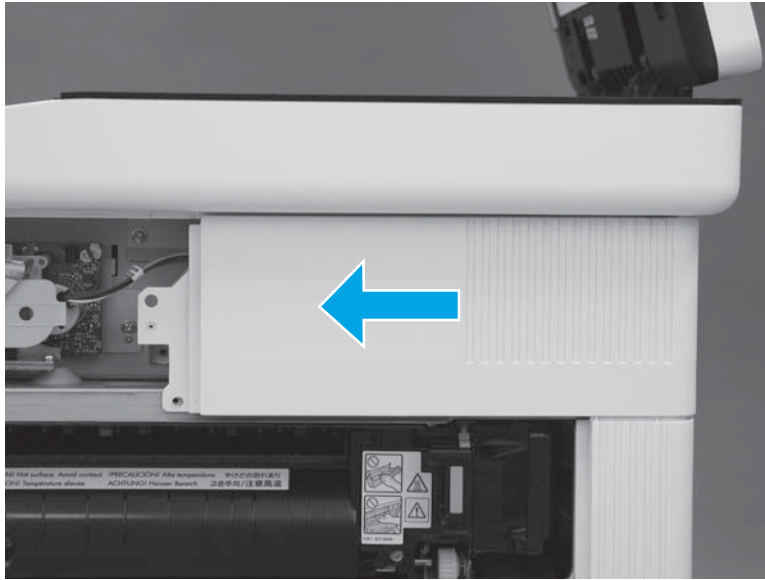

4. At the back of the printer, install one screw (callout 1).

M577c/f/z only: Connect one connector (callout 2), if the integrated scanner assembly is installed.

 **TIP:** This screw is smaller than the screws installed in the next step. Make sure that this screw is installed in the correct position.

Figure 1-2587 Install one screw and connector



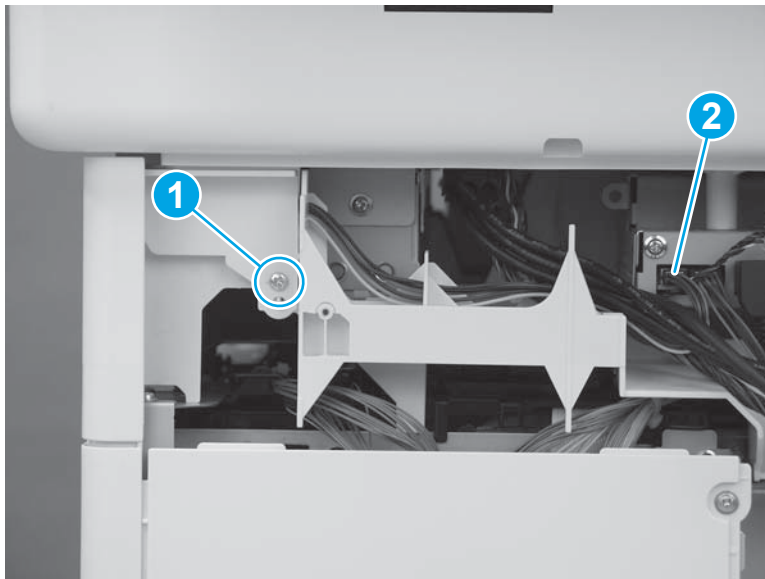
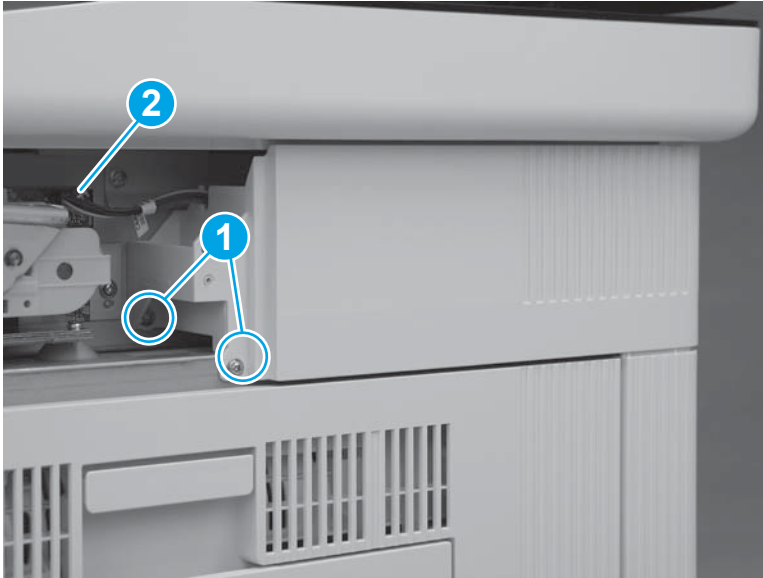

5. At the right side of the printer, install two screws (callout 1).
M577c/f/z only: Connect one connector (callout 2), if the stapler is installed.

Figure 1-2588 Install one screw and connector



Step 34: Install the integrated scanner assembly (ISA) (M577)

-
-  **NOTE:** This step is for the M577 models. For the M552 and M553 models, skip this step and go to [Step 40: Install the rear cover \(M552 and M553\) on page 1480](#).
-
-  **NOTE:** The ISA includes the document feeder, image scanner, scanner control board (SCB), control panel, keyboard (M577c/z) and NFC PCA (M577z).
-

1. Before proceeding, locate the mounting pins (callout 1) on the bottom of the ISA and the slots (callout 2) on the printer base.

Figure 1-2589 Locate the ISA mounting pins and slots

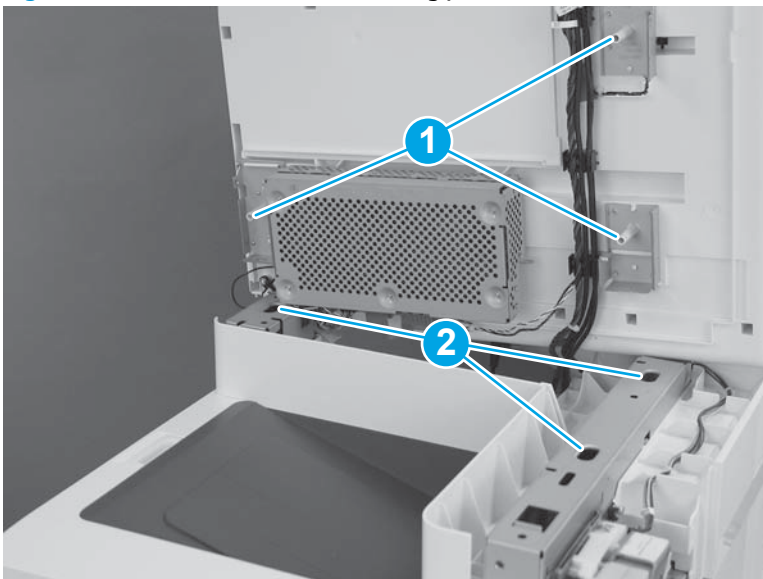

2. Position the ISA on the printer base with the pins in the slots.



NOTE: To locate the pins and slots, see [Figure 1-395 Locate the ISA mounting pins and slots on page 250](#).

When installing the ISA, carefully pass the cables through the opening in the top of the formatter case.

Figure 1-2590 Install the ISA



3. Slightly slide the ISA towards the front of the printer to engage it.

Figure 1-2591 Slide the ISA towards the front of the printer

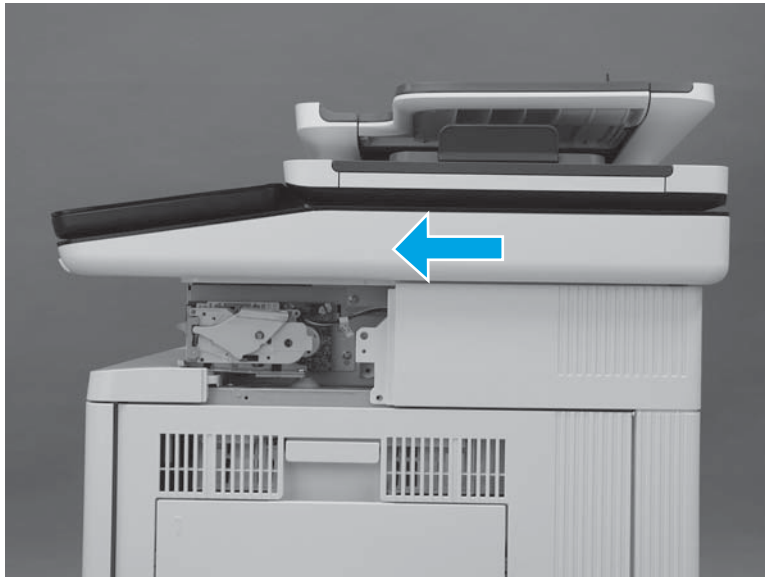

4. At the left side of the printer, install one screw (callout 1).

Figure 1-2592 Install one screw

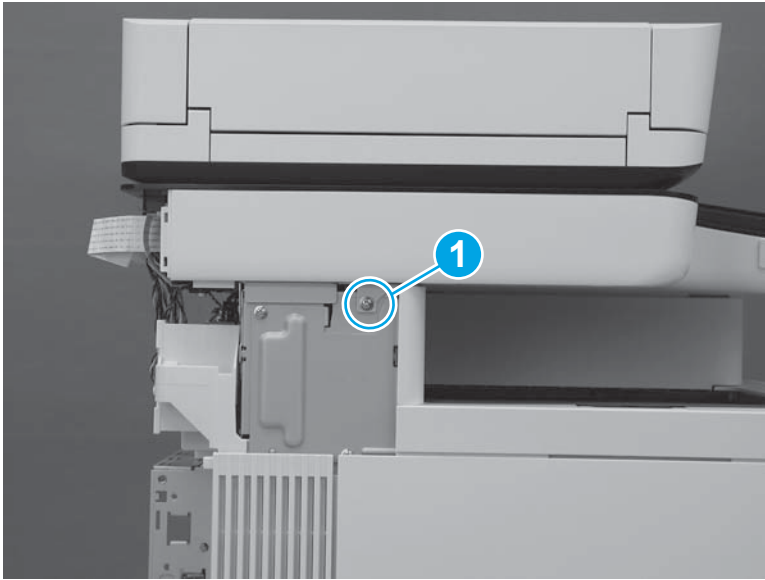

5. At the back of the printer, install two screws (callout 1).

Figure 1-2593 Install two screws

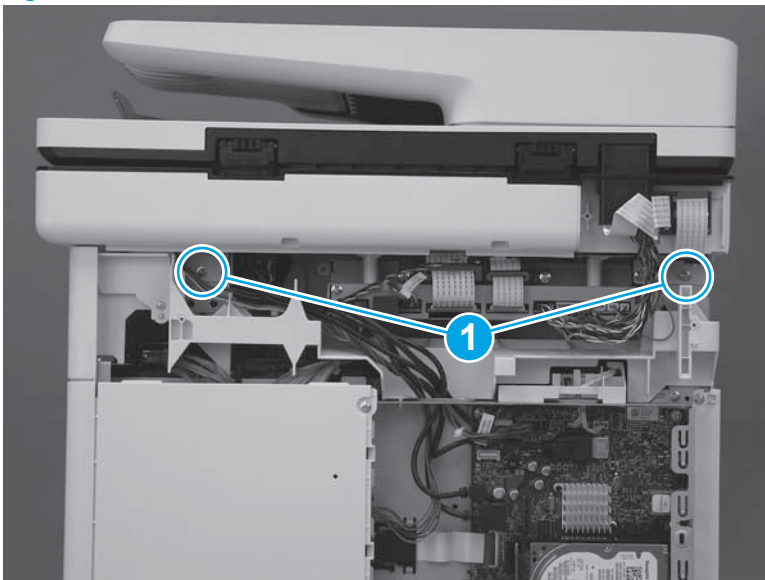

6. At the right side of the printer, install one screw (callout 1).

Figure 1-2594 Install one screw

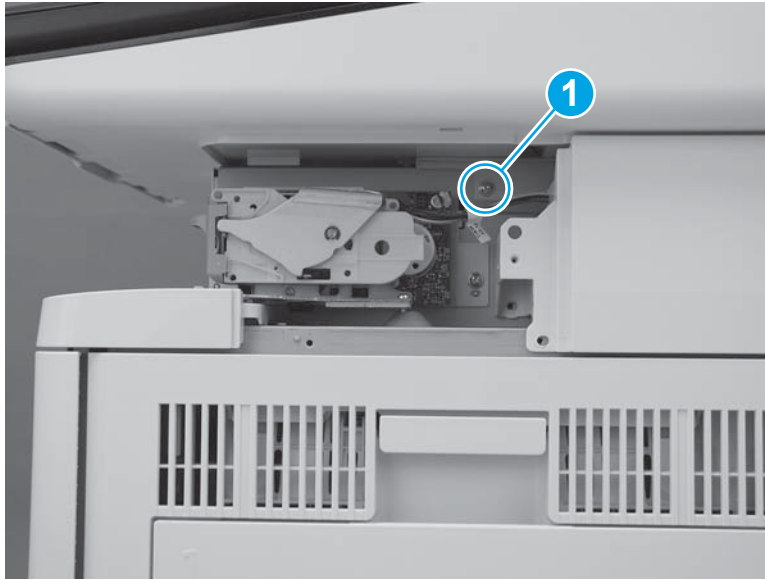

7. Connect two connectors on the scanner control board (callout 1).

M577c/f/z only: Connect one connector for the stapler on the scanner control board (callout 2).

Figure 1-2595 Connect connectors

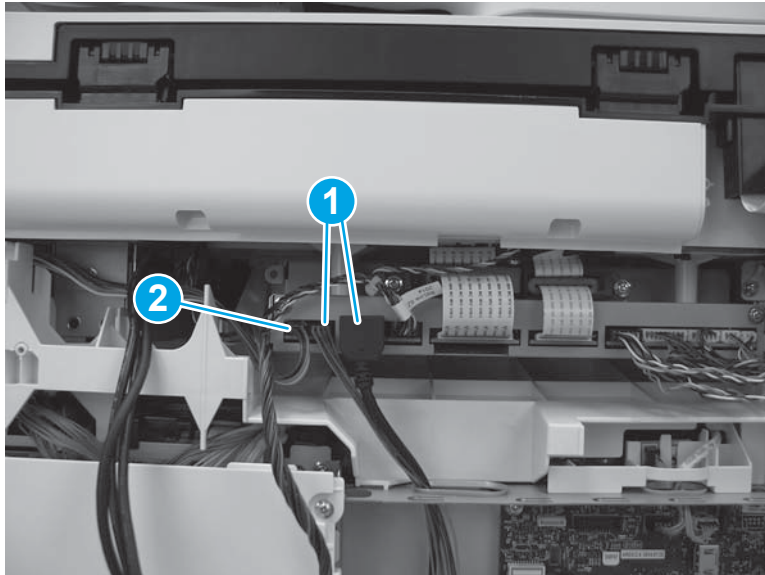

Step 35: Install the stapler cover assembly (M577c/f/z)

 **NOTE:** This step is for the M577c/f/z models only. For the M577dn model, skip this step and go to [Step 36: Install the right front upper cover \(M577dn\) on page 1473](#).

For the M552 and M553 models, skip this step and go to [Step 40: Install the rear cover \(M552 and M553\) on page 1480](#).

1. Install the tabs (callout 1) on the cover in the slots (callout 2) in the printer.

Figure 1-2596 Install two tabs



2. Press the cover toward the left side of the printer until it snaps into place.

Figure 1-2597 Install the cover assembly



3. Install one screw (callout 1).



 **IMPORTANT:** This is a self-tapping screw for plastic. Rotate it counterclockwise to align it with the existing thread pattern, and then carefully turn it clockwise to tighten. Do not overtighten. This will prevent stripping the threads inside the screw hole.

Figure 1-2598 Install one screw

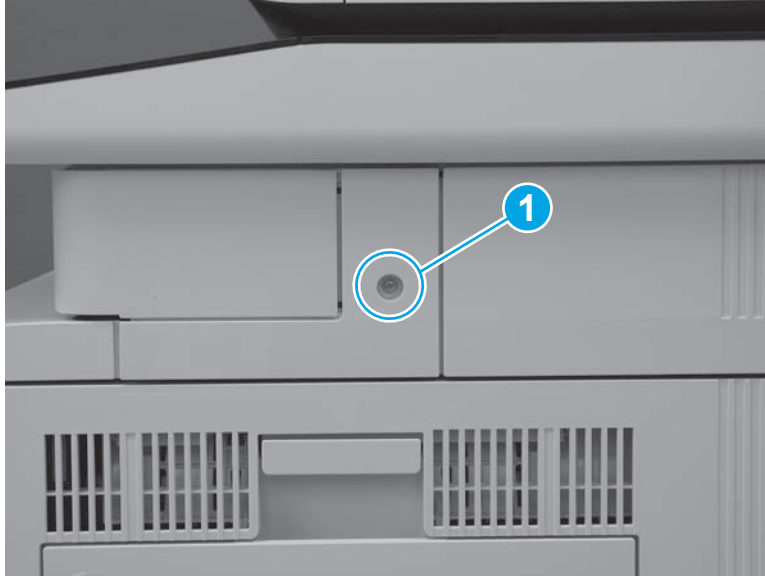

Step 36: Install the right front upper cover (M577dn)

 **NOTE:** This step is for the M577dn model only. For the M577c/f/z models, skip this step and go to [Step 37: Install the left upper cover \(M577\) on page 1475](#).

For the M552 and M553 models, skip this step and go to [Step 40: Install the rear cover \(M552 and M553\) on page 1480](#).

1. Slide the cover toward the left side of the printer to install it. Make sure that the slots (callout 1) in the cover fit over the tabs (callout 2) on the inside of the paper feeder cover.

Figure 1-2599 Install the cover



2. Press the right front upper cover (callout 1) and the paper feeder cover (callout 2) together until the tabs on the inside of the covers snap into place.

Figure 1-2600 Press the cover



3. Install one screw (callout 1).

Figure 1-2601 Install one screw

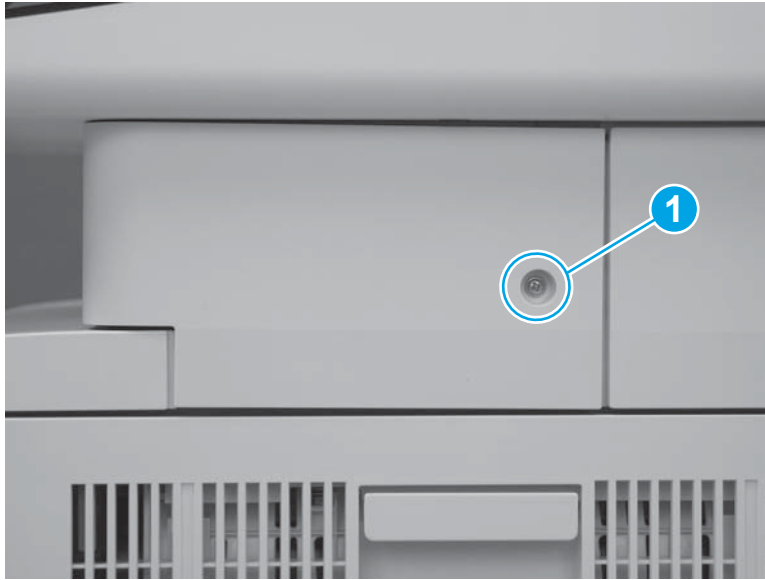

Step 37: Install the left upper cover (M577)

 **NOTE:** This step is for the M577 models. For the M552 and M553 models, skip this step and go to [Step 40: Install the rear cover \(M552 and M553\) on page 1480](#).

1. Position the tab (callout 1) on the lower edge of the cover behind the left cover (callout 2).

Figure 1-2602 Position the tab

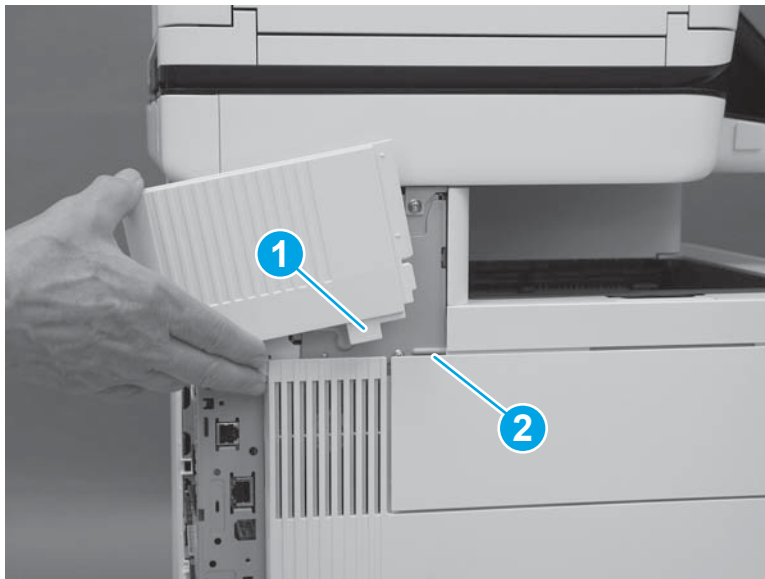

2. Slide the cover toward the front of the printer to install it. Make sure that the edge (callout 1) of the cover fits behind the edge (callout 2) of the top rear cover.

Figure 1-2603 Slide the cover

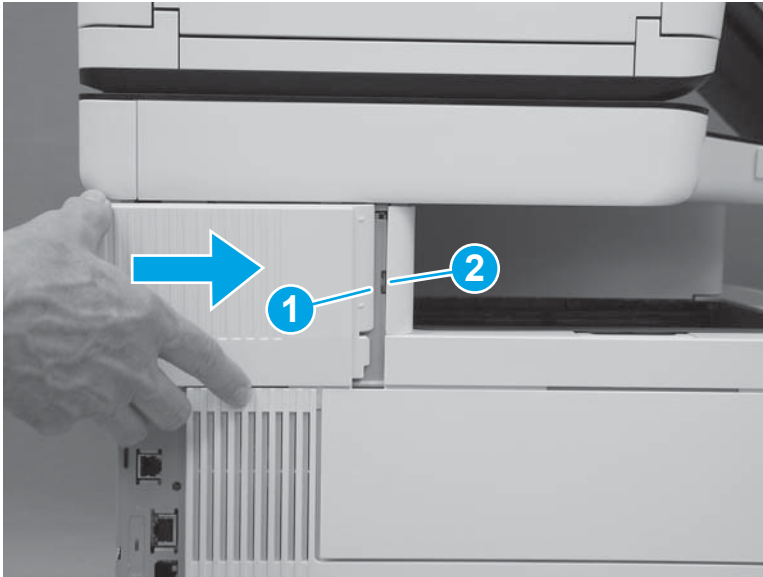

3. Make sure that the tab (callout 1) is fully installed.

Figure 1-2604 Check the tab

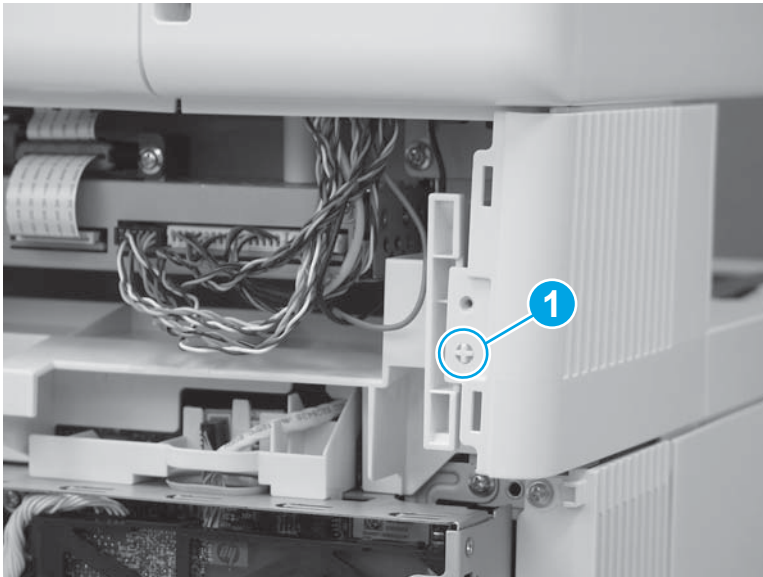

Step 38: Install the rear cover (M577)



NOTE: This step is for the M577 models. For the M552 and M553 models, skip this step and go to [Step 40: Install the rear cover \(M552 and M553\) on page 1480](#).

1. Position the hooks (callout 1) on the cover in the slots (callout 2) in the printer.

Figure 1-2605 Position the hooks

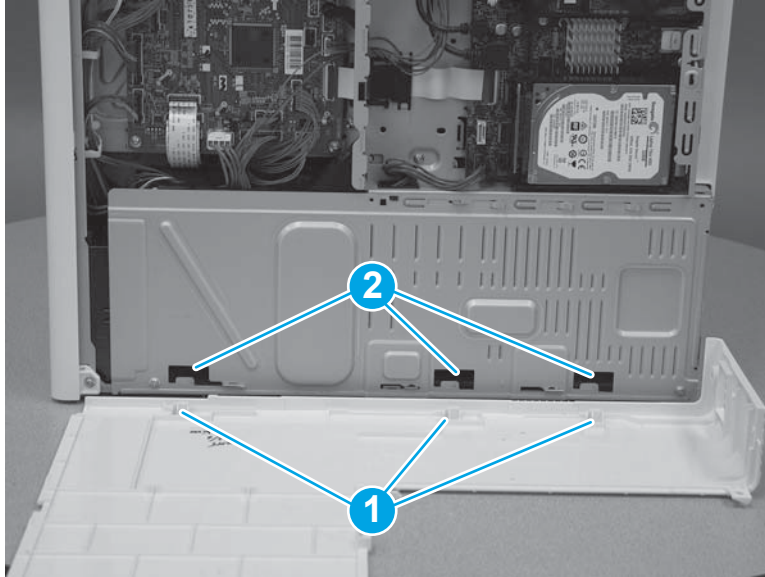

2. Position the back edge (callout 1) of the rear cover behind the edge (callout 2) of the right rear cover. Slide the cover to the left to install it.

Figure 1-2606 Install the cover

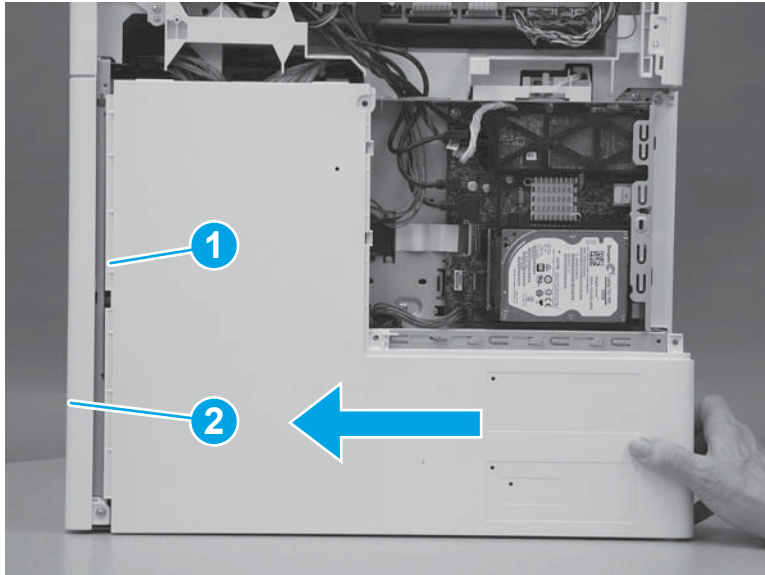

3. Install four screws (callout 1).

Figure 1-2607 Install four screws cover

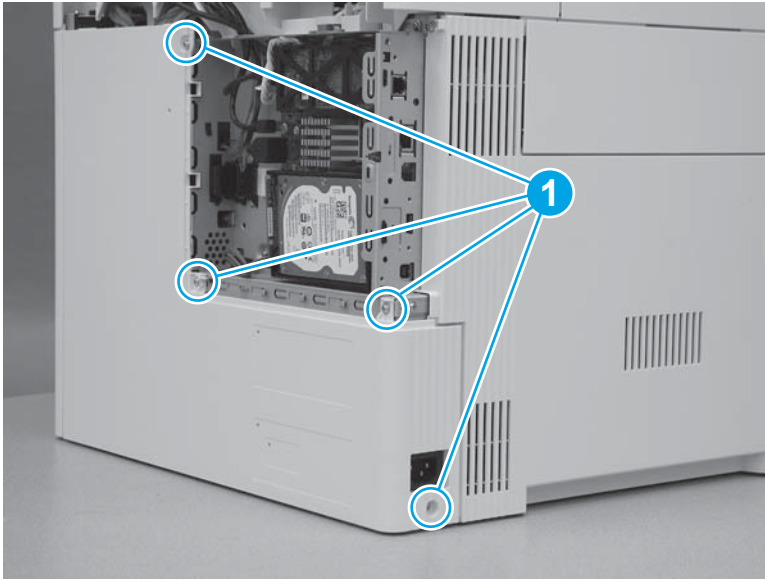

Step 39: Install the rear upper cover (M577)



NOTE: This step is for the M577 models. For the M552 and M553 models, skip this step and go to [Step 40: Install the rear cover \(M552 and M553\) on page 1480](#).

1. Align the ridge (callout 1) on the lower edge of the rear upper cover in front of the tabs (callout 2) on the top edge of the rear cover.

Figure 1-2608 Align the cover

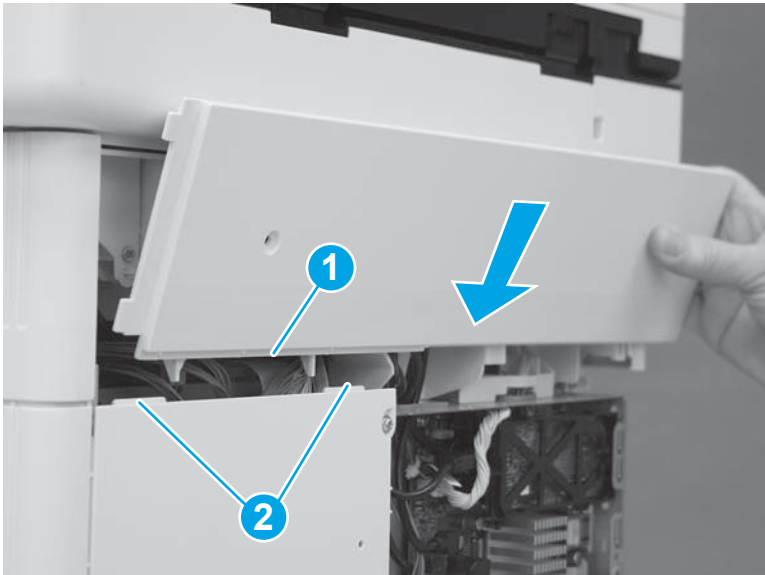

2. Rotate the top of the cover toward the printer.

Figure 1-2609 Rotate the top of the cover

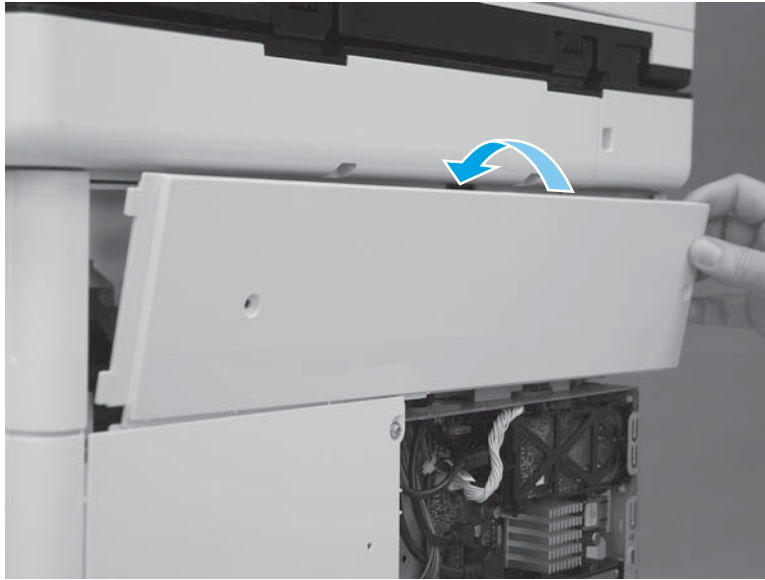

3. Slide the cover to the left (callout 1). Make sure that the tabs (callout 2) on the upper rear cover slide behind the edge (callout 3) of the right upper cover. Make sure that the cover is fully seated.

Figure 1-2610 Slide the cover

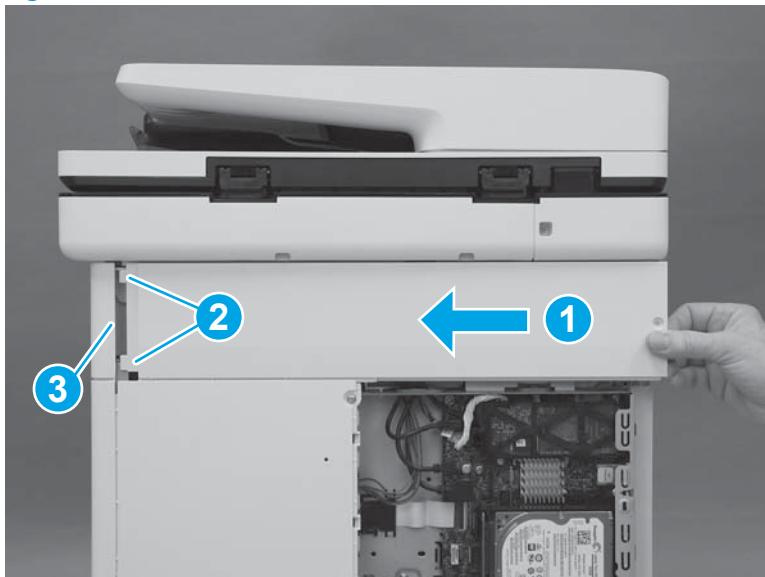

4. Install two screws (callout 1).



 **IMPORTANT:** These two screws are self-tapping screws for plastic. Rotate them counterclockwise to align them with the existing thread pattern, and then carefully turn them clockwise to tighten. Do not overtighten. This will prevent stripping the threads inside the screw holes.

Figure 1-2611 Install two screws

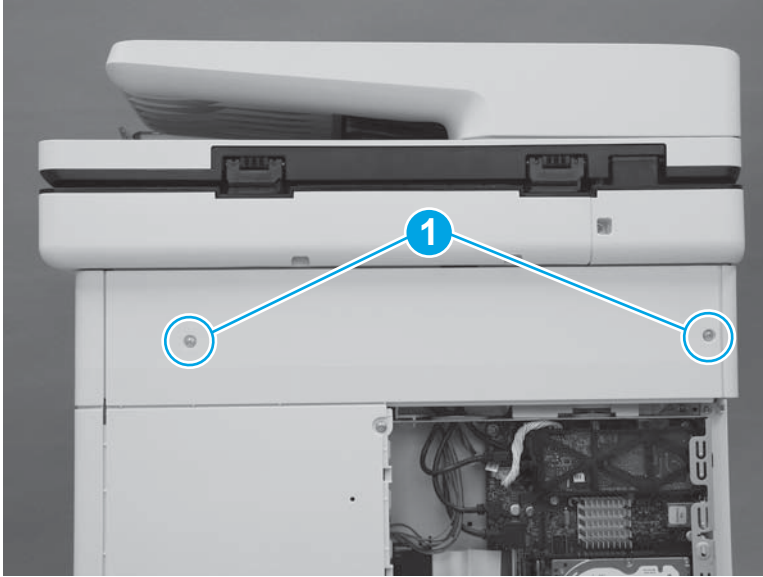

Step 40: Install the rear cover (M552 and M553)

 **NOTE:** This step is for the M552 and M553 models. For the M577 models, skip this step and go to [Step 41: Install the formatter \(M577\) on page 1481](#).

1. Position the top of the cover under the upper cover (callout 1), rotate the bottom of the cover onto the chassis (callout 2), and then slide the cover to the left (callout 3) to install it.

Figure 1-2612 Install the cover

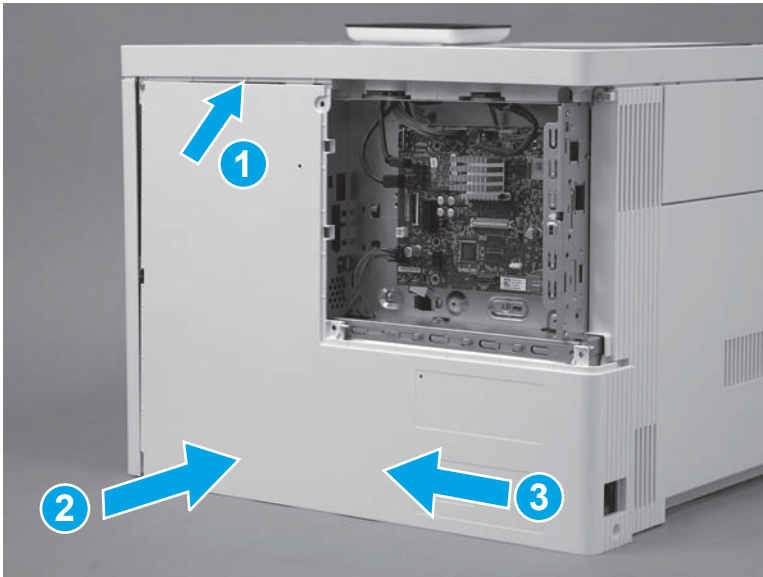

2. Install four screws (callout 1).

Figure 1-2613 Install four screws cover

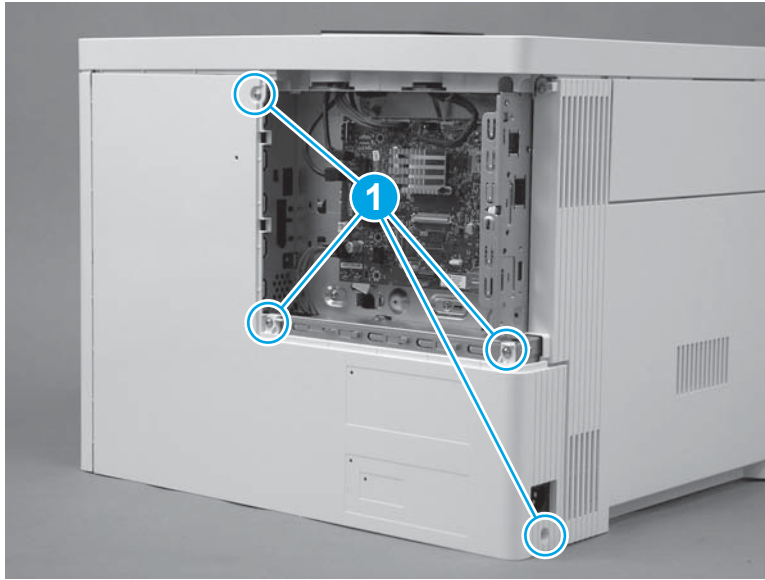

Step 41: Install the formatter (M577)

 **NOTE:** This step is for the M577 models. For the M552 and M553 models, skip this step and to go [Step 44: Install the formatter \(M552 and M553\)](#) on page 1486.

 **CAUTION:**  ESD-sensitive part.

1. Position the formatter in the printer. Make sure that the network port (callout 1) fits through the opening (callout 2) in the formatter case.

Figure 1-2614 Install the formatter

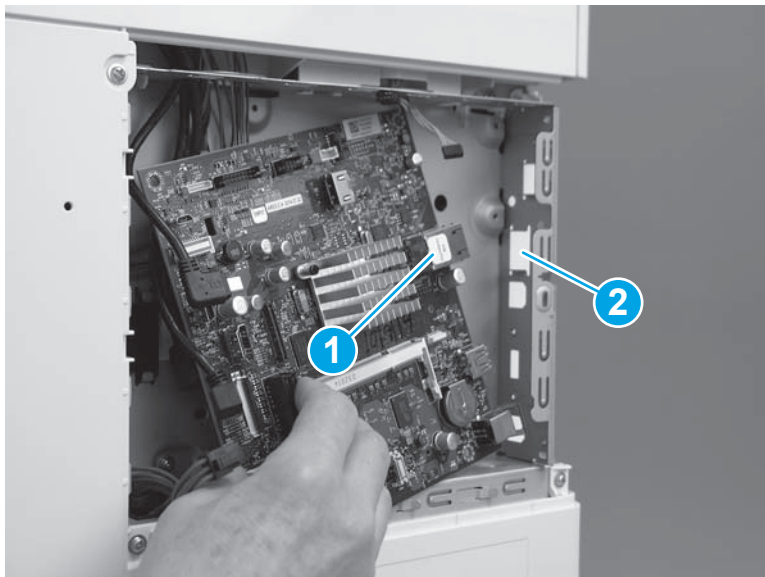

2. Install four screws (callout 1).

Figure 1-2615 Install four screws

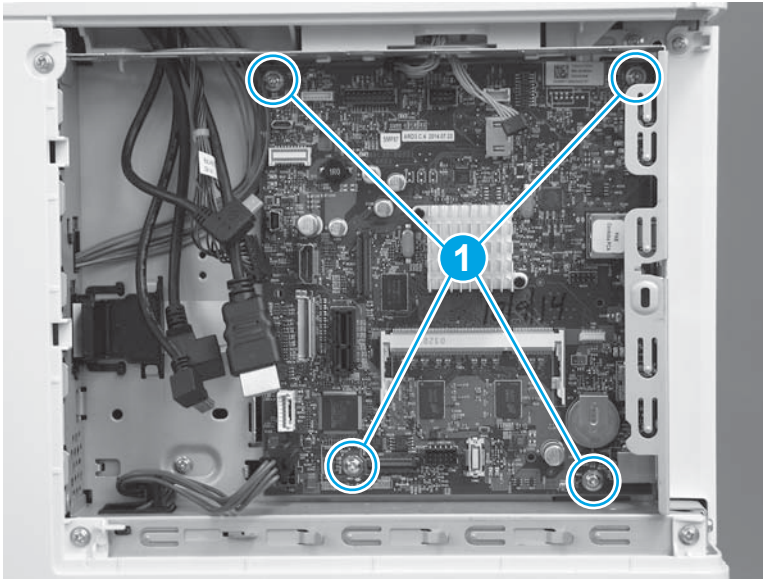

3. Connect all of the connectors on the formatter.

The following connectors are empty:

- All models: J1 (this connector is empty unless the optional DIMM is installed)
- All models: J3
- M577dn: J15 (this is the fax connector for the M577f/z/c models)
- All models: J21 (this connector is empty unless the optional internal USB ports component is installed)
- All models: J23
- All models: J24
- All models: J51
- All models: J57
- All models: J97
- All models: J98 (this connector is empty unless the optional trusted platform module (TPM) is installed)

 **IMPORTANT:** The flat-cable connector (callout 1) is a Zero Insertion Force (ZIF) connector that uses a hinged retainer to secure the flat cable. The hinged retainer must be opened to install the flat cable, and then closed after the cable is installed.

Figure 1-2616 Connect all connectors



Step 42: Install the fax PCA (M577c/f/z)

 **NOTE:** This step is for the M577c/f/z models. For the M577n model, skip this step and go to [Step 43: Install the HDD \(M577\) on page 1484](#).

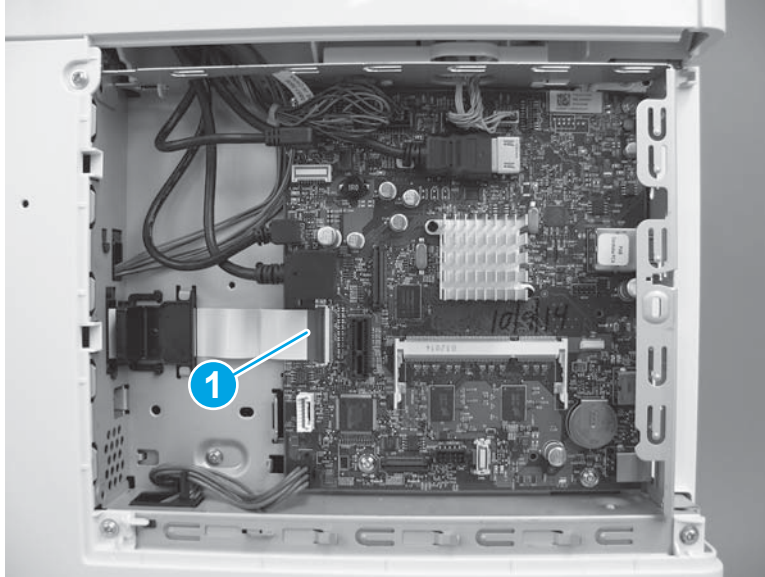
For the M552 and M553 models, skip this step and go to [Step 44: Install the formatter \(M552 and M553\) on page 1486](#).

 **CAUTION:**  ESD-sensitive part.

1. Position the tab and telephone port (callout 1) on the fax PCA in the slots (callout 2) in the formatter case.

Figure 1-2617 Position the fax PCA

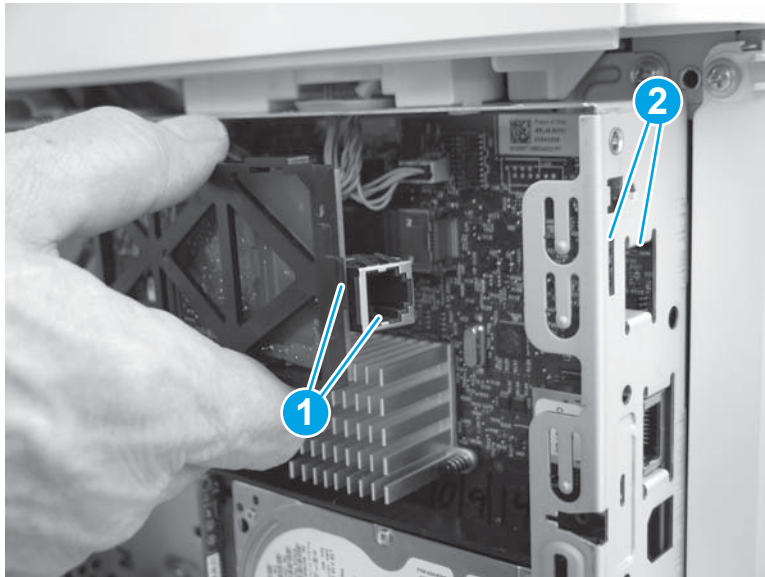

2. Slide the fax PCA to the right (callout 1) until the tab and telephone port described in the previous step and seated in the formatter case. Position the retainer (callout 2) in the slot (callout 3) in the formatter. Rotate the end of the fax PCA toward the formatter (callout 4) until the retainer snaps into place.

Figure 1-2618 Install the fax PCA

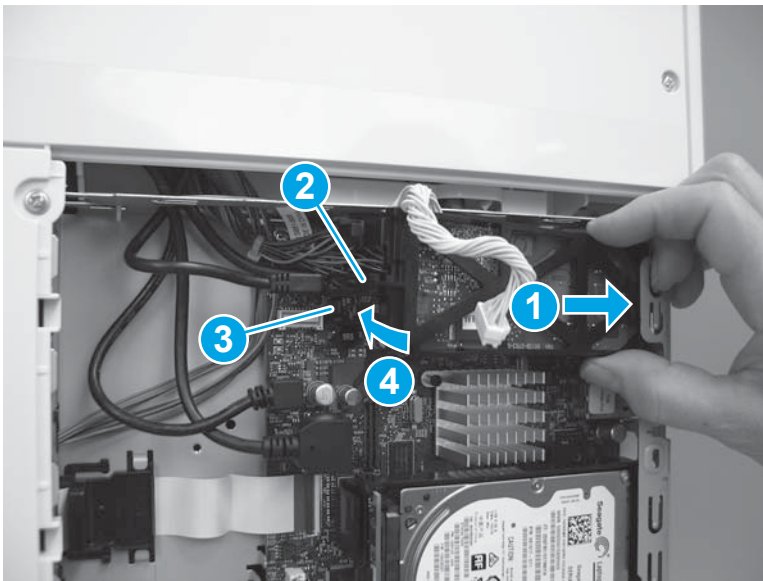

3. Position the cable (callout 1) in the guide (callout 2), and then connect one connector (callout 3).

Figure 1-2619 Connect the connector

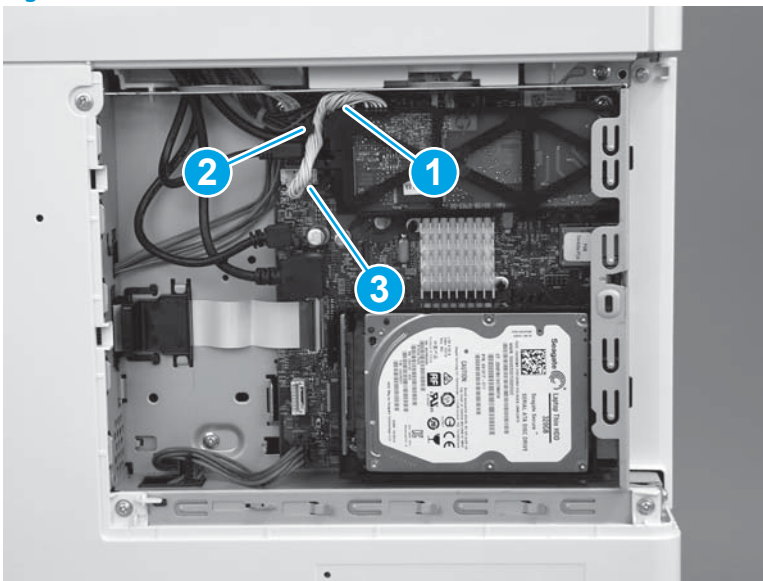

Step 43: Install the HDD (M577)



NOTE: This step is for the M577 models. For the M552 and M553 models, skip this step and go to [Step 44: Install the formatter \(M552 and M553\) on page 1486](#).

 **CAUTION:**  ESD-sensitive part.

1. Align the end of the bracket (callout 1) with the slot in the chassis (callout 2), and then slide the HDD into the printer (callout 3) to engage the bracket with the chassis.

Figure 1-2620 Install the holder

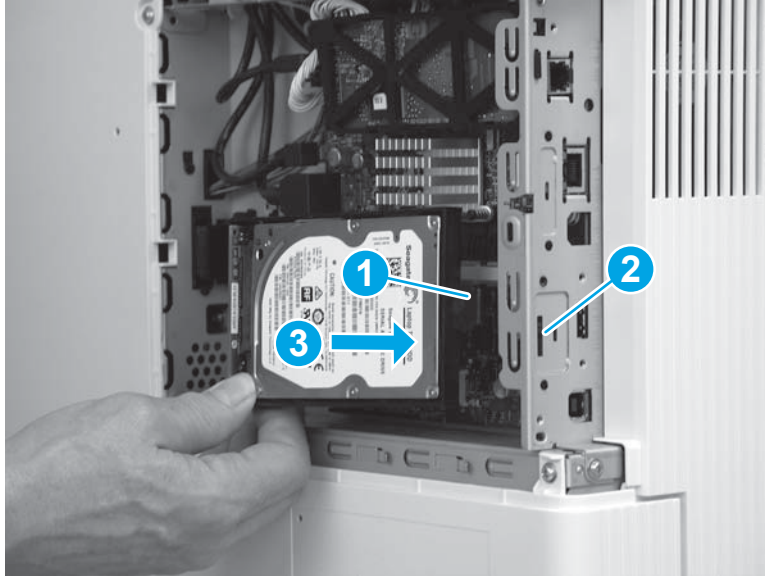

2. Hold the HDD connector latch (callout 1) in the released position, and then rotate the HDD down and into the connector on the formatter to install it.

 **NOTE:** Make sure that the tab (callout 2) snaps into place, and that the HDD is securely installed.

Figure 1-2621 Release the HDD

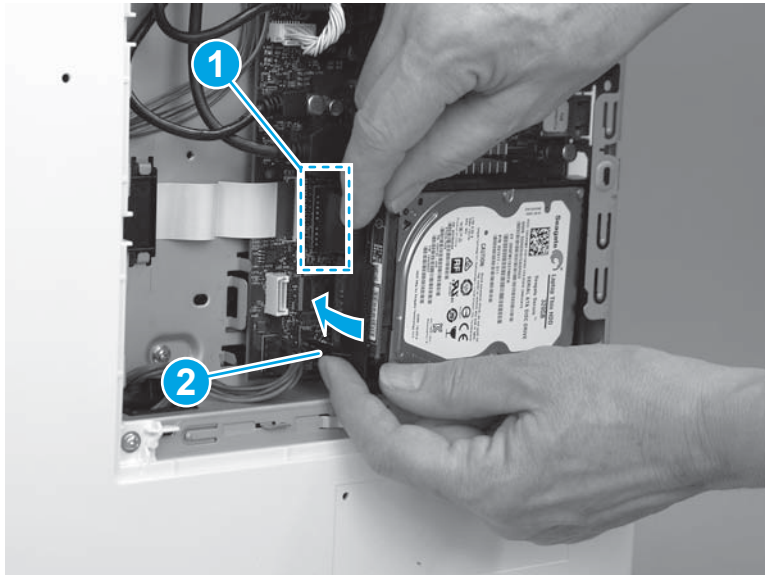

Step 44: Install the formatter (M552 and M553)

 **NOTE:** This step is for the M552 and M553 models. For the M577 models, skip this step and go to [Step 45: Install the formatter cover on page 1487](#).

If the optional hard-disk drive (HDD) was removed, do not forget to reinstall it after the formatter is reinstalled.

Engage the HDD holder with the chassis, rotate the HDD connector down and into the connector on the formatter. Make sure that the tabs snap into place.

 **CAUTION:**  ESD-sensitive part.

1. Position the formatter in the printer, and then install four screws (callout 1).

Figure 1-2622 Install the formatter

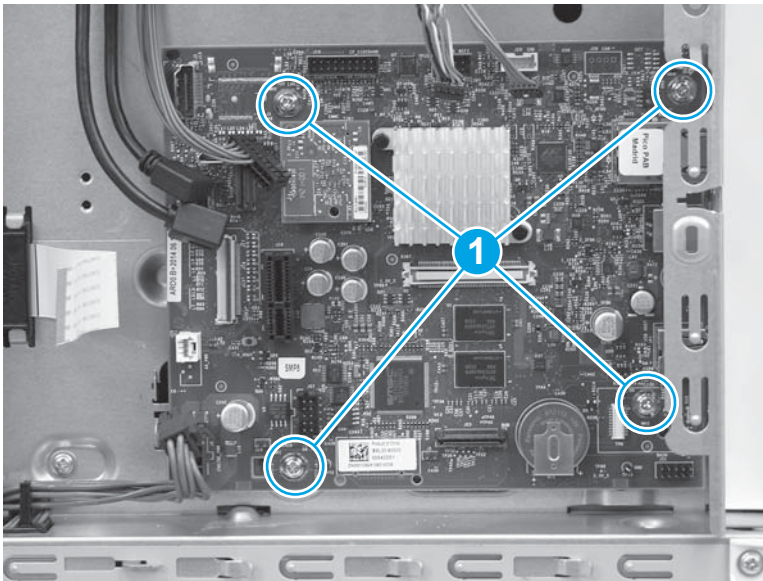

2. Connect all of the connectors on the formatter.

The following connectors are empty:

- All models: J1 (this connector is empty unless the optional DIMM is installed)
- M553n/dn and M552dn: J2 (callout 1; this is the touchscreen connector for the M553x model)
- All models: J9 (this connector is empty unless the optional internal USB ports component is installed)
- All models: J18 (this connector is empty unless the optional hard-disk-drive (HDD) is installed)
- All models: J23
- All models: J24
- M553n/dn and M552dn: J25 (this is the wireless connector for the M553x model)

- All models: J57
- All models: J98 (this connector is empty unless the optional trusted platform module (TPM) is installed)



 **IMPORTANT:** The flat-cable connector (callout 2) is a Zero Insertion Force (ZIF) connector that uses a hinged retainer to secure the flat cable. The hinged retainer must be opened to install the flat cable.

Figure 1-2623 Connect all connectors

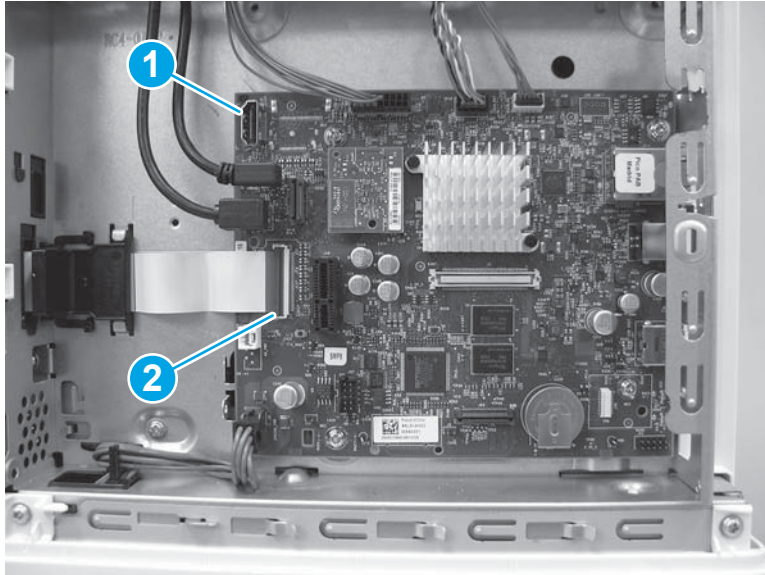

Step 45: Install the formatter cover

- ▲ Slide the cover onto the printer (callout 1) to install it.

 **NOTE:** Make sure that the tabs on the formatter cover align with the slots provided in the printer (callout 2). Tighten the two thumbscrews (callout 3).

 **TIP:** If needed, use the edge of a coin to turn the thumbscrews.

Figure 1-2624 Install the cover



Step 46: Install the TCU

1. Verify that the toner collection hatch cover is in the closed position on the TCU.

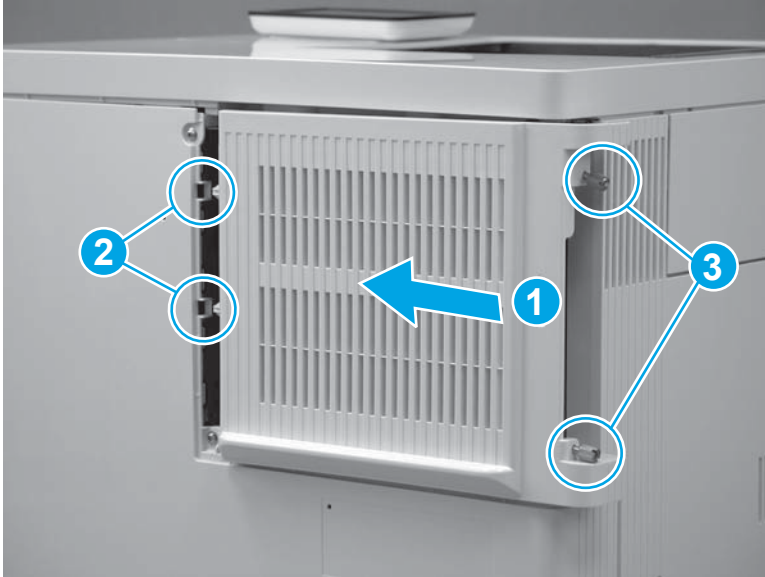
Figure 1-2625 Verify that the toner collection hatch cover is closed

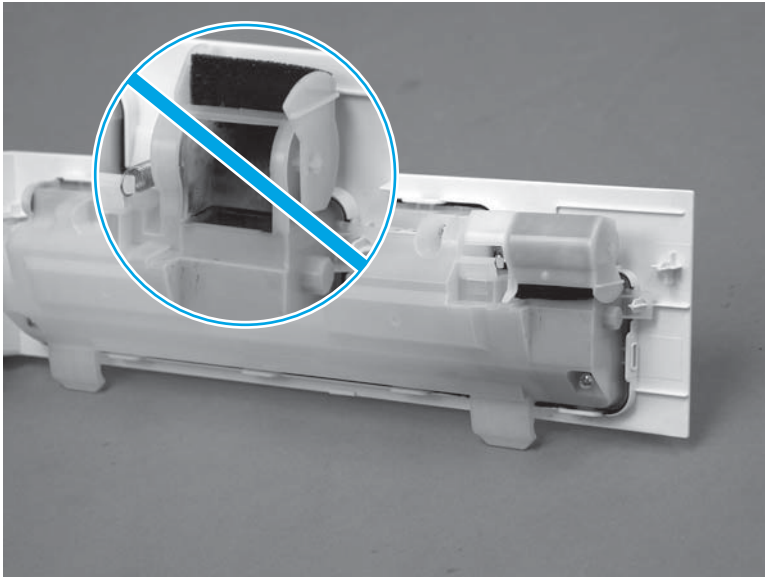

2. Position the TCU with the hinges in the slots provided in the printer (callout 1), and then rotate the TCU up and into the closed position.

 **NOTE:** The toner collection hatch cover automatically opens when the TCU is closed.

Figure 1-2626 Install the TCU



3. Close the front door.

Figure 1-2627 Close the front door

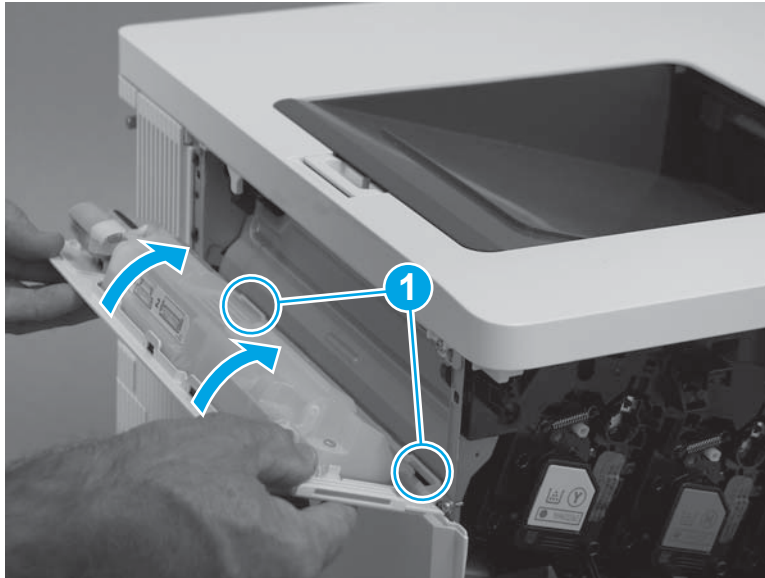

Step 47: Install the tray

1. With the front of the tray slightly lifted, align the sides of the tray with the rails in the printer, and then carefully slide the tray into the printer.

 **TIP:** As the tray slides into the printer, lower the front of it.

Figure 1-2628 Install the tray



2. Close the tray.

Figure 1-2629 Close the tray



Step 48: Install the control-panel assembly (M553x only)

 **NOTE:** For the M553n/dn and M552dn models, skip this step and go to [Step 49: Install the USB cover \(M552 and M553\) on page 1493](#).

For the M577 models, skip this step.

1. Place the control panel on the printer as shown.

Figure 1-2630 Place the control panel on the product

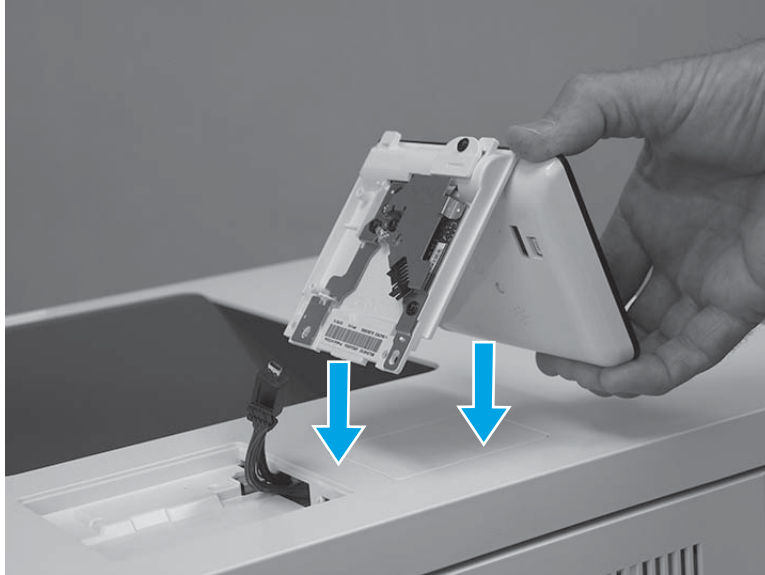

2. Connect one USB cable (callout 1), and one connector (callout 2).

 **IMPORTANT:** Take note of the location of the two mounting tabs (callout 3) on the control-panel assembly.

Figure 1-2631 Connect two connectors



3. Turn the control panel over, and then position the front edge tabs in the slots in the top cover.

Figure 1-2632 Turn the control panel over

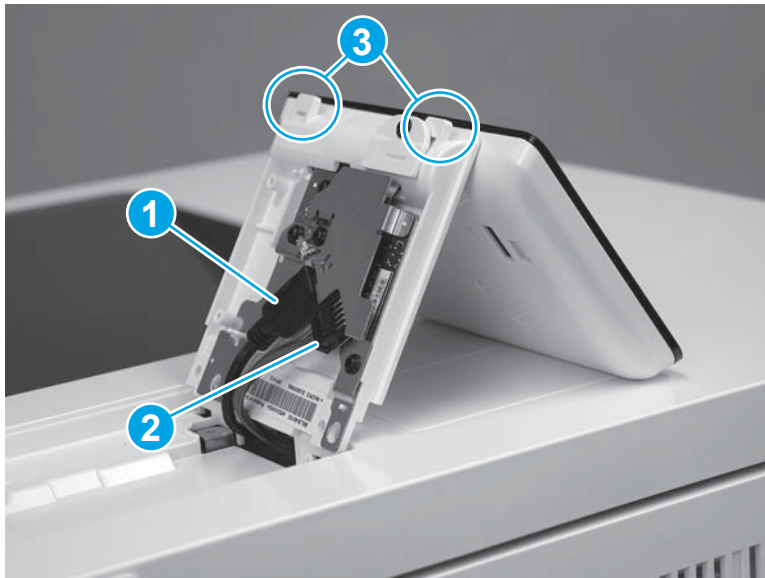
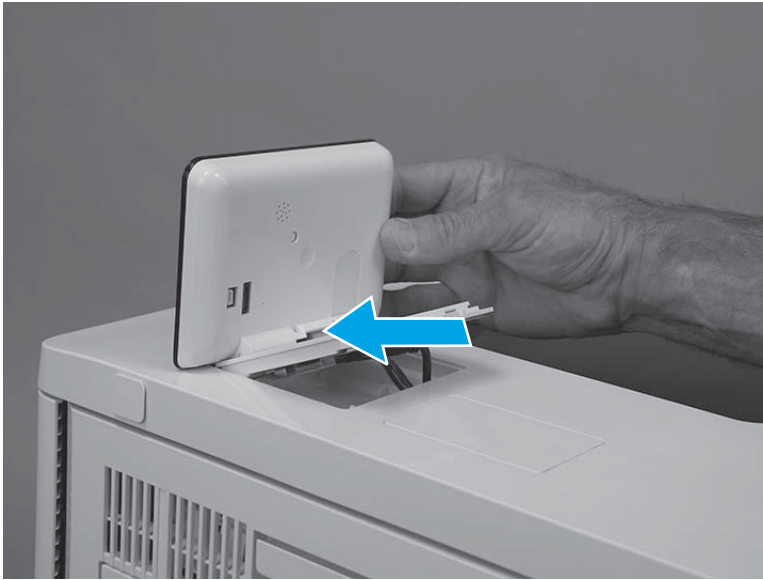

4. Rotate the control-panel base down onto the printer.

Figure 1-2633 Rotate the control-panel base down



5. Use a small Phillips screwdriver to install two screws (callout 1).

Figure 1-2634 Install two screws

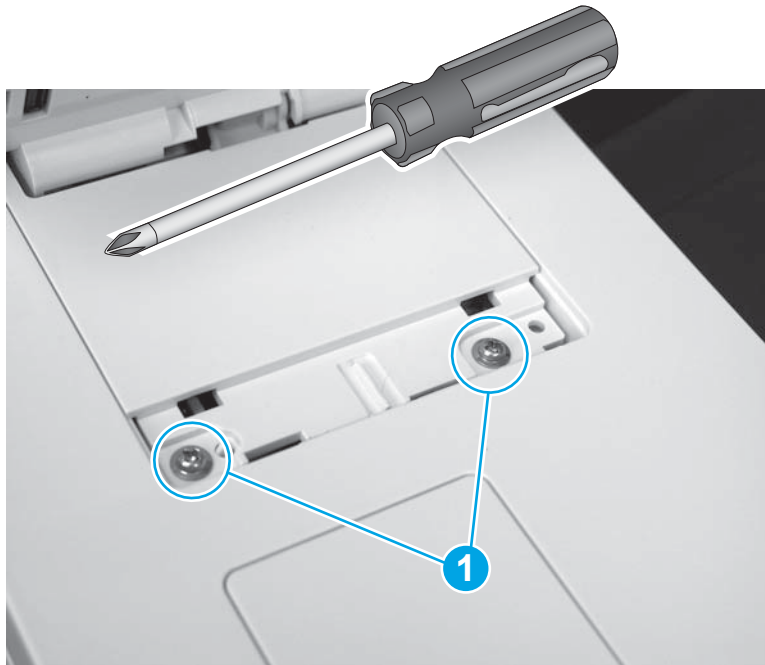

6. Position the screw cover mounting feet into the slots in the top cover (callout 1), and then rotate the cover down (callout 2) to install it.



 **NOTE:** Press down on the cover firmly to make sure that the tabs on the cover (callout 3) snap into place.

Figure 1-2635 Install the cover

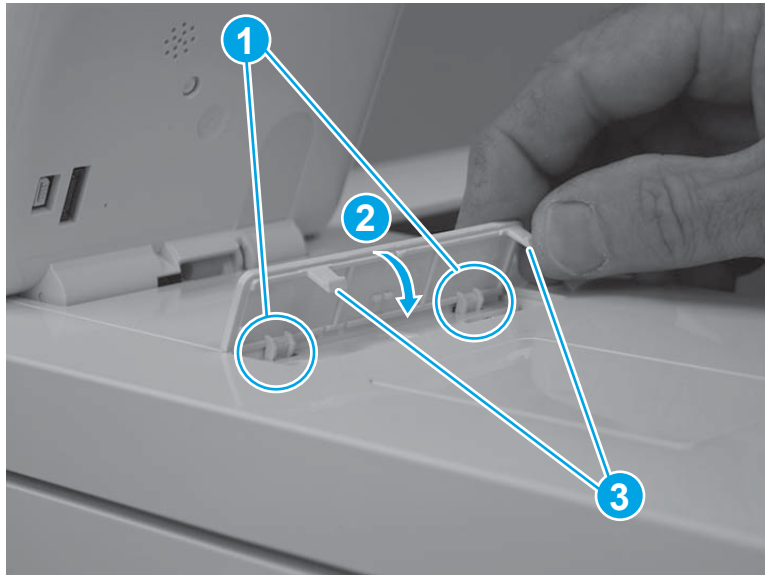

Step 49: Install the USB cover (M552 and M553)

 **NOTE:** This step is for the M552 and M553 models. For the M577 models, skip this step.

1. Push the cover into the USB port to install it.

Figure 1-2636 Install the cover



2. Make sure that the USB cover is fully seated after installing it.

Figure 1-2637 Check the installation

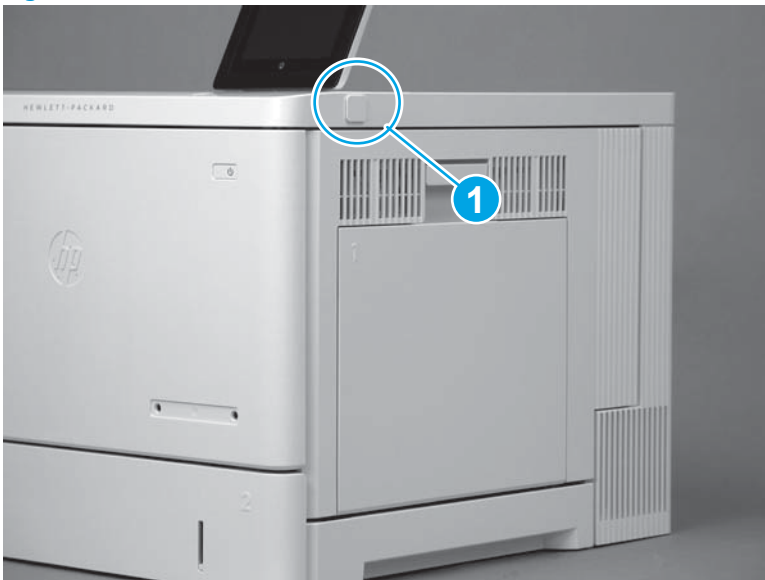

Removal and replacement: Drum motor 2 (M2)

- [Introduction](#)
- [Step 1: Remove the USB cover \(M552 and M553\)](#)
- [Step 2: Remove the control panel \(M553x only\)](#)
- [Step 3: Remove the tray](#)
- [Step 4: Remove the toner collection unit \(TCU\)](#)
- [Step 5: Remove the formatter cover](#)
- [Step 6: Remove the formatter \(M552 and M553\)](#)
- [Step 7: Remove the hard-disk drive \(HDD\) \(M577\)](#)
- [Step 8: Remove the fax PCA \(M577c/f/z\)](#)
- [Step 9: Remove the formatter \(M577\)](#)
- [Step 10: Remove the rear cover \(M552 and M553\)](#)
- [Step 11: Remove the rear upper cover \(M577\)](#)
- [Step 12: Remove the rear cover \(M577\)](#)
- [Step 13: Remove the left upper cover \(M577\)](#)
- [Step 14: Remove the right front upper cover \(M577dn\)](#)
- [Step 15: Remove the stapler cover assembly \(M577c/f/z\)](#)
- [Step 16: Remove the integrated scanner assembly \(ISA\) \(M577\)](#)
- [Step 17: Remove the right upper cover \(M577\)](#)
- [Step 18: Remove the top rear cover \(M577\)](#)
- [Step 19: Remove the left cover](#)
- [Step 20: Remove the upper cover \(M552 and M553\)](#)
- [Step 21: Remove the formatter case](#)
- [Step 22: Remove the right rear cover](#)
- [Step 23: Remove the DC controller and sheet-metal bracket](#)
- [Step 24: Remove the high-voltage power supply T \(HVPST\)](#)
- [Step 25: Remove drum motor 2 \(M2\)](#)
- [Step 26: Unpack the replacement assembly](#)
- [Step 27: Install drum motor 2 \(M2\)](#)
- [Step 28: Install the HVPST](#)
- [Step 29: Install the DC controller and sheet-metal bracket](#)

- [Step 30: Install the right rear cover](#)
- [Step 31: Install the formatter case](#)
- [Step 32: Install the upper cover \(M552 and M553\)](#)
- [Step 33: Install the left cover](#)
- [Step 34: Install the top rear cover \(M577\)](#)
- [Step 35: Install the right upper cover \(M577\)](#)
- [Step 36: Install the integrated scanner assembly \(ISA\) \(M577\)](#)
- [Step 37: Install the stapler cover assembly \(M577c/f/z\)](#)
- [Step 38: Install the right front upper cover \(M577dn\)](#)
- [Step 39: Install the left upper cover \(M577\)](#)
- [Step 40: Install the rear cover \(M577\)](#)
- [Step 41: Install the rear upper cover \(M577\)](#)
- [Step 42: Install the rear cover \(M552 and M553\)](#)
- [Step 43: Install the formatter \(M577\)](#)
- [Step 44: Install the fax PCA \(M577c/f/z\)](#)
- [Step 45: Install the HDD \(M577\)](#)
- [Step 46: Install the formatter \(M552 and M553\)](#)
- [Step 47: Install the formatter cover](#)
- [Step 48: Install the TCU](#)
- [Step 49: Install the tray](#)
- [Step 50: Install the control-panel assembly \(M553x only\)](#)
- [Step 51: Install the USB cover \(M552 and M553\)](#)

Introduction

This document provides the procedures to remove and replace the drum motor 2 (M2).

Before performing service

Turn the printer power off

- Disconnect the power cable.

 **WARNING!** To avoid damage to the printer, turn the printer off, wait 30 seconds, and then remove the power cord before attempting to service the printer.

Use the table below to identify the correct part number for your printer, and then go to <http://h20141.www2.hp.com/hpparts> to order the part.

Drum motor 2 (M2) part number

RM2-0078-000CNDrum motor 2 (M2)

Required tools

- #2 Phillips screwdriver with a magnetic tip

After performing service

Make sure that all of the connectors on the HVPST are fully seated.

Make sure that all of the connectors on the DC controller are fully seated.

Make sure that all of the connectors on the formatter are fully seated.

Make sure that the formatter cover is fully seated, and that the thumbscrews are finger tight after replacing it.

Turn the printer power on

- Connect the power cable.
- Use the power switch to turn the power on.

Post service test

Use the components test to test the motor. For more information, see the printer troubleshooting manual.

Step 1: Remove the USB cover (M552 and M553)

NOTE: This step is for the M552 and M553 models. For the M577 models, skip this step and go to [Step 3: Remove the tray on page 1502](#).

1. Locate the USB cover.

Figure 1-2638 Locate the USB cover



2. Pull the cover off of the printer to remove it.

Figure 1-2639 Remove the cover



Step 2: Remove the control panel (M553x only)

 **NOTE:** This step is for the M553x model. For the M553n/dn, M552dn, and M577 models, skip this step and go to [Step 3: Remove the tray on page 1502](#).

1. Tilt the control panel up.

Figure 1-2640 Tilt the control panel up



2. Use a small flat-blade screwdriver to release the control-panel screws cover tabs.

Figure 1-2641 Release the control-panel screws cover tabs



3. Rotate the cover up to remove it.

Figure 1-2642 Remove the cover

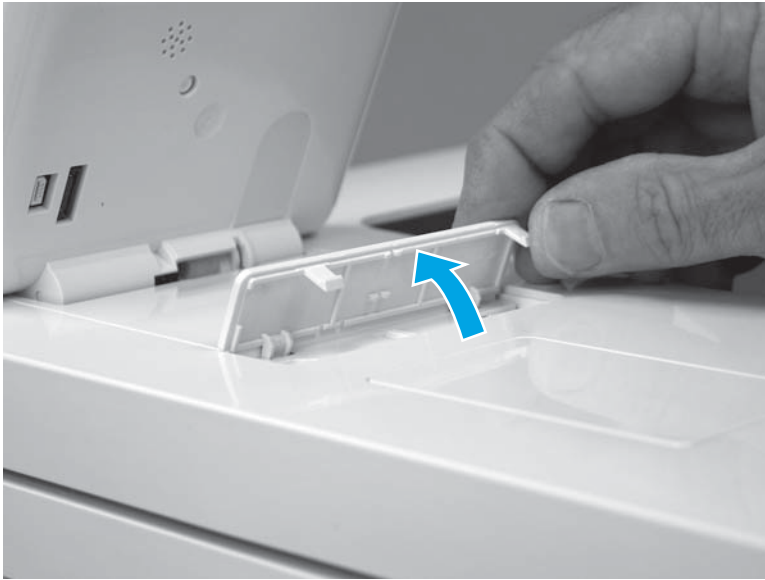

4. Use a small Phillips screwdriver to remove two screws (callout 1).

 **IMPORTANT:** Store the screws in a secure place where they cannot fall down into the printer.

Figure 1-2643 Remove two screws

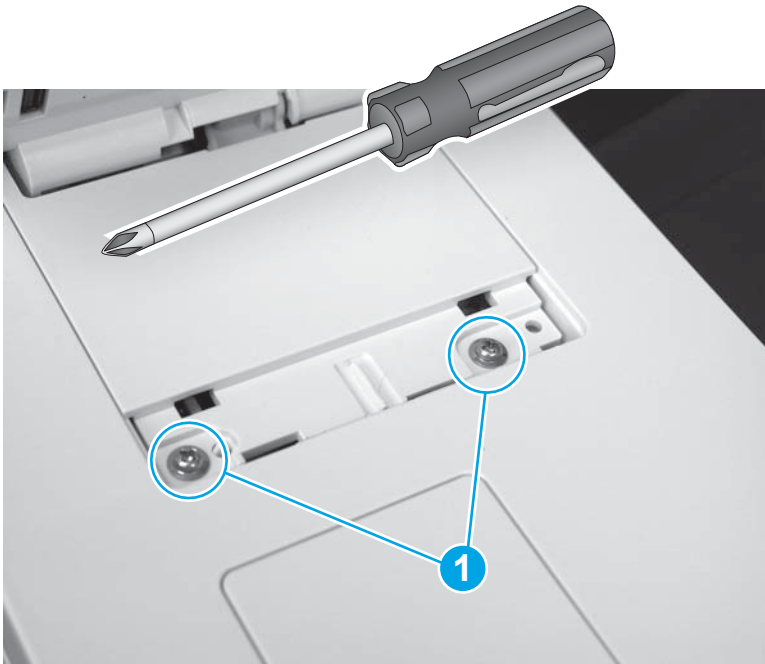

5. Rotate the control-panel base toward the front of the printer.

Figure 1-2644 Rotate the control-panel base up



6. Slightly slide the control-panel base toward the rear of the printer (callout 1) to release it, and then turn the control panel over (callout 2) to access the bottom side.

⚠ CAUTION: The control panel is still attached to the printer. Do not attempt to completely remove the control panel.

Figure 1-2645 Turn the control panel over

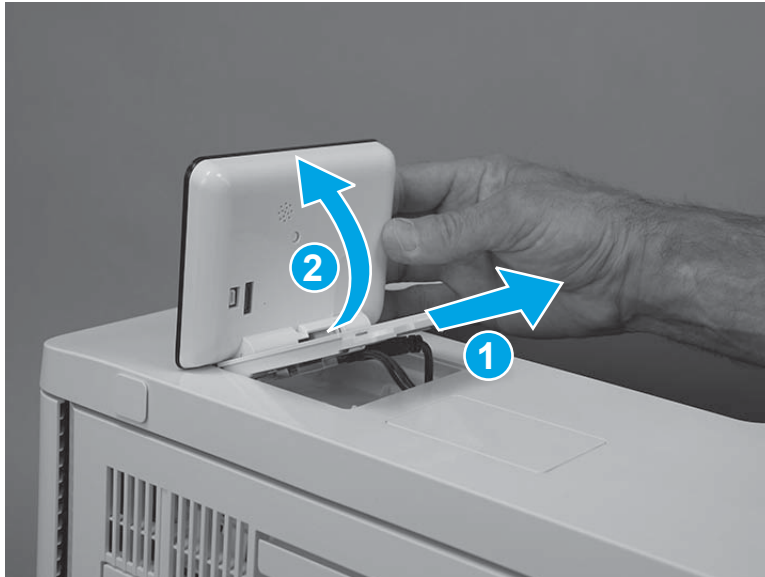

7. Disconnect one USB cable (callout 1), one connector (callout 2), and then remove the control panel.

Figure 1-2646 Disconnect two connectors

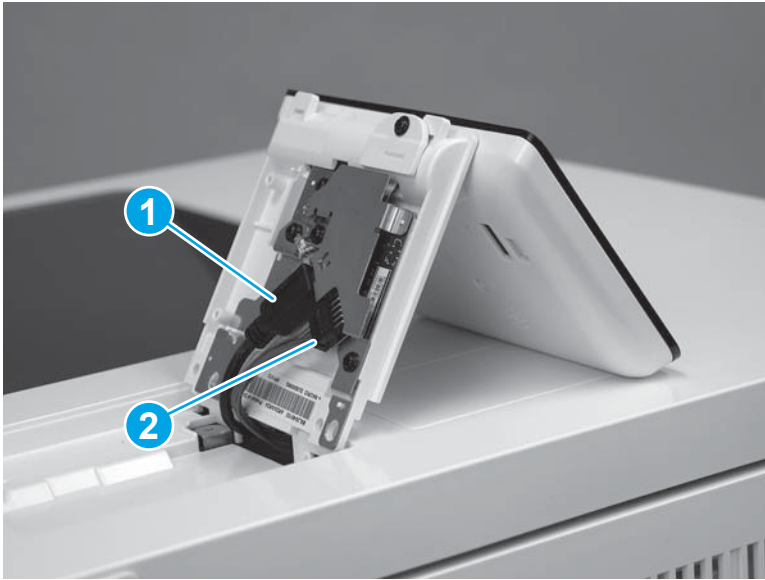

Step 3: Remove the tray

1. Pull the tray out until it stops.

Figure 1-2647 Pull the tray out



2. Lift the front of the tray, and then pull it out of the printer to remove it.

Figure 1-2648 Remove the tray

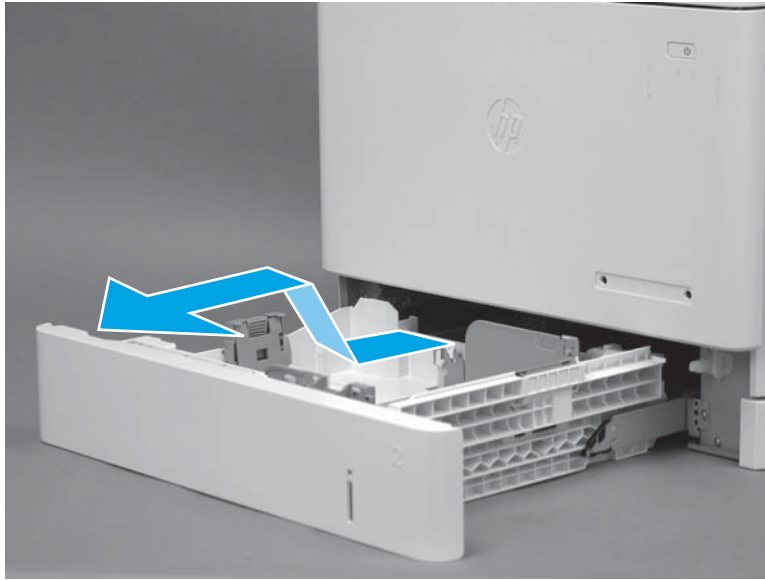

Step 4: Remove the toner collection unit (TCU)

1. Open the front door.

Figure 1-2649 Open the front door



2. Open the TCU.

 **NOTE:** The toner collection hatch cover automatically closes when the TCU is opened.

Figure 1-2650 Open the TCU



3. Pull the TCU away from the printer at an angle to remove it.

⚠ CAUTION: Do not open the toner collection hatch cover when handling the TCU. If toner gets on clothing, wipe it off by using a dry cloth and wash the clothes in cold water. Hot water sets toner into fabric.

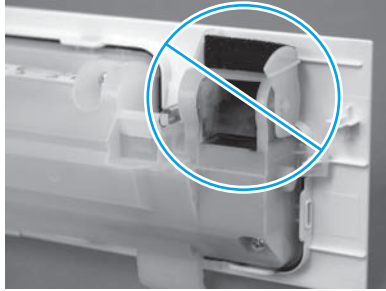
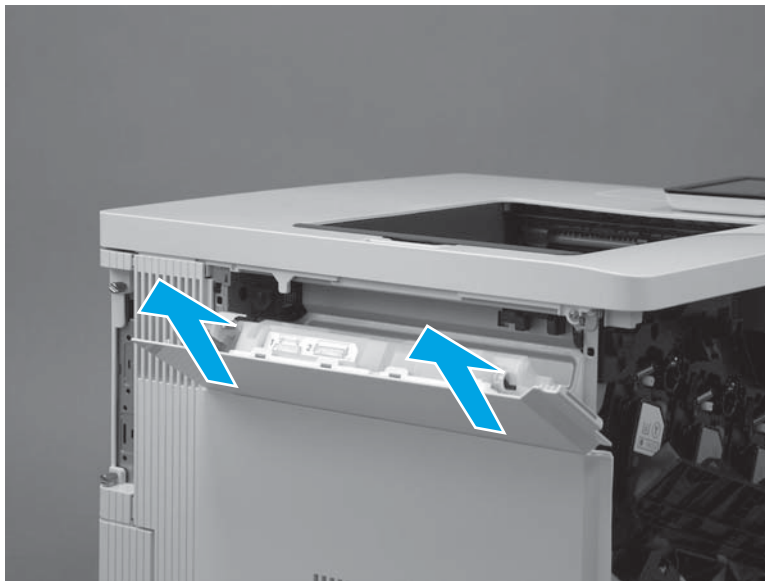

Figure 1-2651 Remove the TCU



Step 5: Remove the formatter cover

1. Locate the formatter cover.

Figure 1-2652 Locate the formatter cover

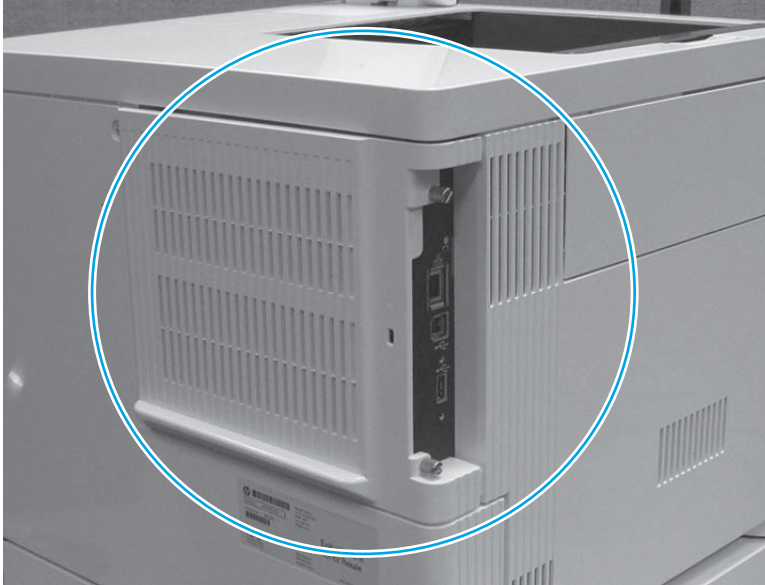

2. Loosen the two thumbscrews (callout 1). Grasp the two thumbscrews, and then slide the cover away from the printer (callout 2) to remove it.

 **TIP:** If needed, use the edge of a coin to turn the thumbscrews.

Figure 1-2653 Loosen the thumbscrews



Step 6: Remove the formatter (M552 and M553)

 **NOTE:** This step is for the M552 and M553 models. For the M577 models, skip this step and go to [Step 7: Remove the hard-disk drive \(HDD\) \(M577\) on page 1508](#).

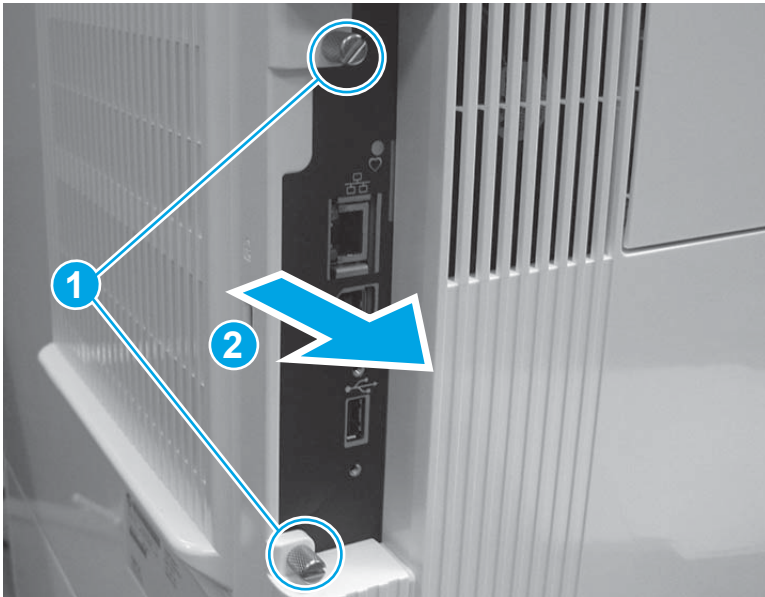
If the optional hard-disk drive (HDD) is installed, it must be removed to gain access to the formatter mounting screws.

Release two tabs along the left edge of the HDD, rotate the left edge away from the product, and then slide the HDD to the left to remove it.

 **CAUTION:**  ESD-sensitive part.

1. Disconnect all of the connectors on the formatter.

The following connectors are empty:

- All models: J1 (this connector is empty unless the optional DIMM is installed)
- M553n/dn and M552dn: J2 (callout 1; this is the touchscreen connector for the M553x model)
- All models: J9 (this connector is empty unless the optional internal USB ports component is installed)
- All models: J18 (this connector is empty unless the optional hard-disk-drive (HDD) is installed)
- All models: J23
- All models: J24
- M553n/dn and M552dn: J25 (this is the wireless connector for the M553x model)
- All models: J57
- All models: J98 (this connector is empty unless the optional trusted platform module (TPM) is installed)

 **IMPORTANT:** The flat-cable connector (callout 2) is a Zero Insertion Force (ZIF) connector that uses a hinged retainer to secure the flat cable. The hinged retainer must be opened to release the flat cable.

Figure 1-2654 Disconnect all connectors



2. Remove four screws (callout 1), and then remove the formatter.

Figure 1-2655 Remove the formatter

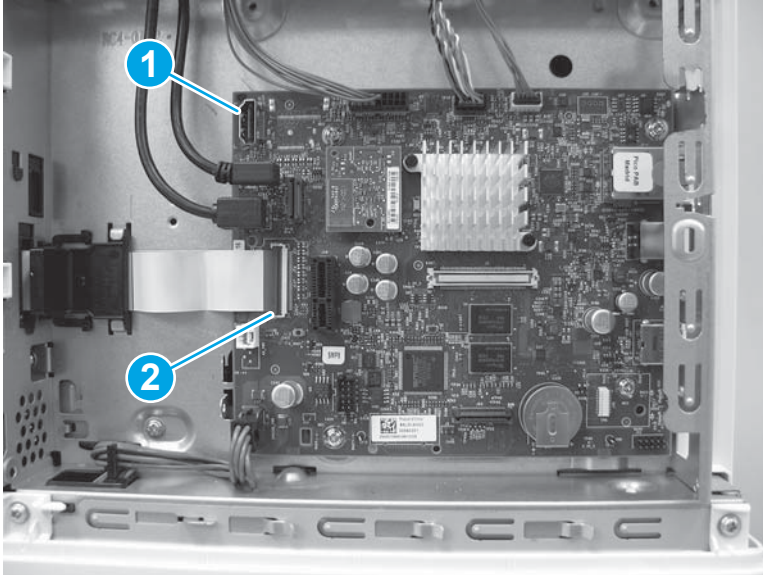
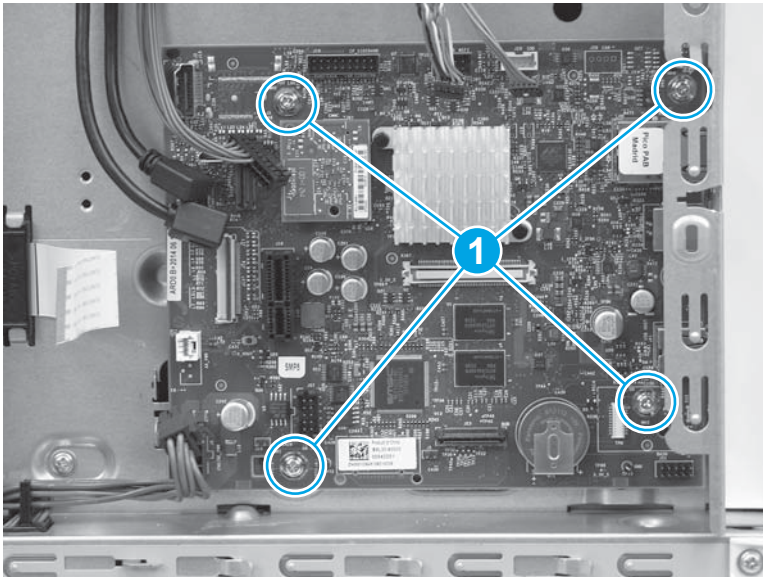

Step 7: Remove the hard-disk drive (HDD) (M577)

 **NOTE:** This step is for the M577 models. For the M552 and M553 models, skip this step and go to [Step 10: Remove the rear cover \(M552 and M553\)](#) on page 1513.

 **CAUTION:**  ESD-sensitive part.

1. Release two tabs (callout 1). Hold the tabs in the released position, and then rotate the hard disk drive (HDD) up (callout 2) to release the connector from the formatter.

Figure 1-2656 Release the HDD

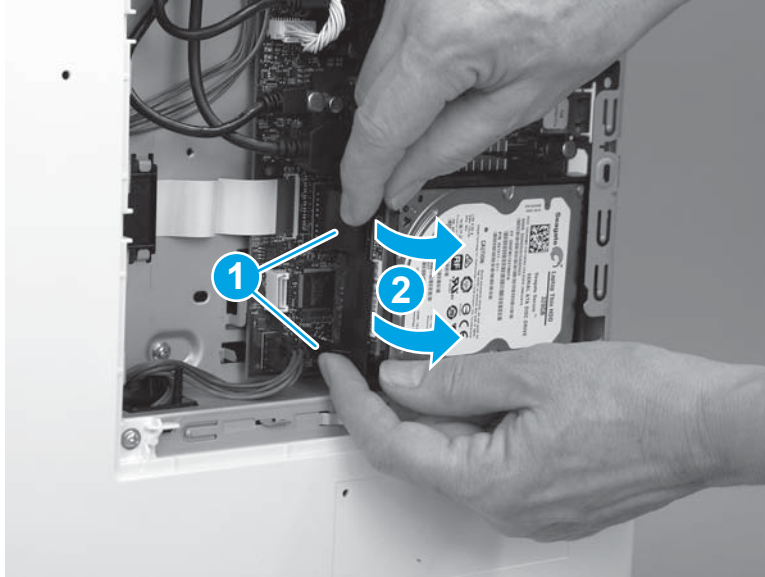

2. Slide the HDD away from the printer to remove it.

Figure 1-2657 Remove the HDD

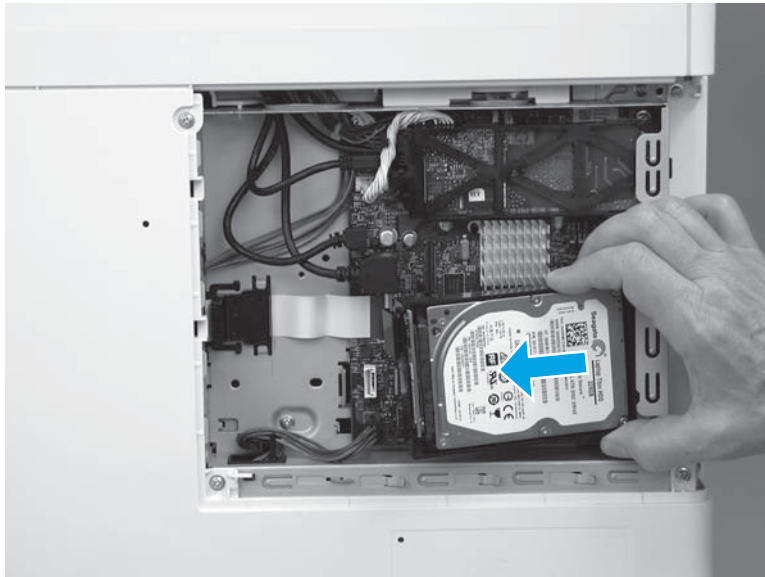

Step 8: Remove the fax PCA (M577c/f/z)

 **NOTE:** This step is for the M577c/f/z models. For the M577n model, skip this step and go to [Step 9: Remove the formatter \(M577\) on page 1511](#).

For the M552 and M553 models, skip this step and go to [Step 10: Remove the rear cover \(M552 and M553\) on page 1513](#).

 **CAUTION:**  ESD-sensitive part.

1. Locate the fax PCA component on the formatter.

Figure 1-2658 Locate the fax PCA

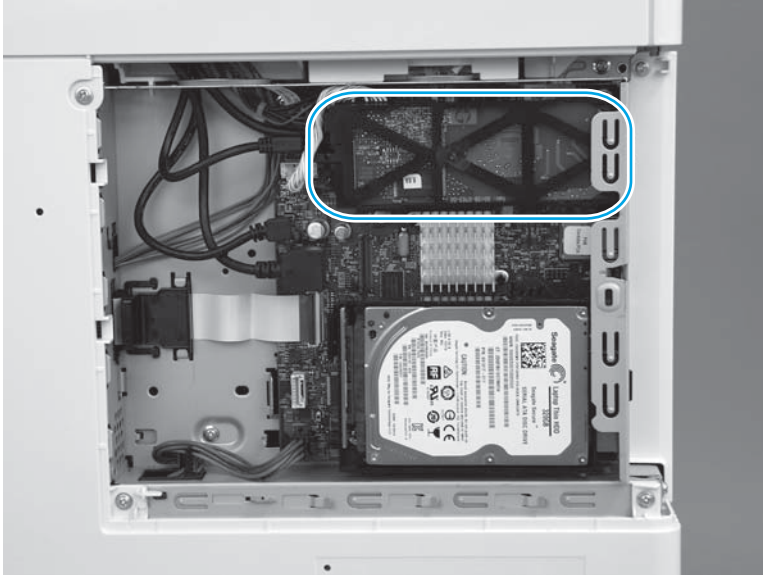

2. Release the connector latch (callout 1), and then pull the connector away from the formatter (callout 2) to disconnect it.

Figure 1-2659 Disconnect one connector

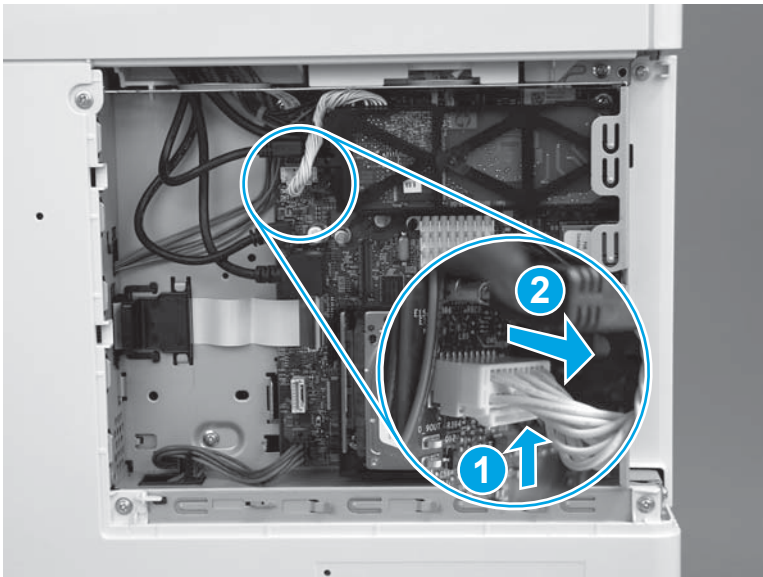

3. Release one retainer (callout 1) by pressing the bracket arms together.

Figure 1-2660 Release one latch

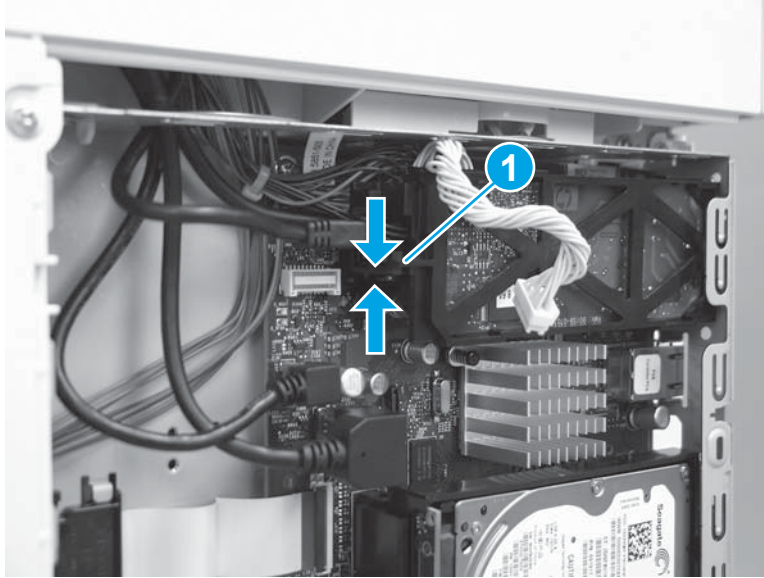

4. Rotate the end of the fax PCA (callout 1) away from the formatter, and then slide the PCA left (callout 2) to remove it.

Figure 1-2661 Remove the fax PCA

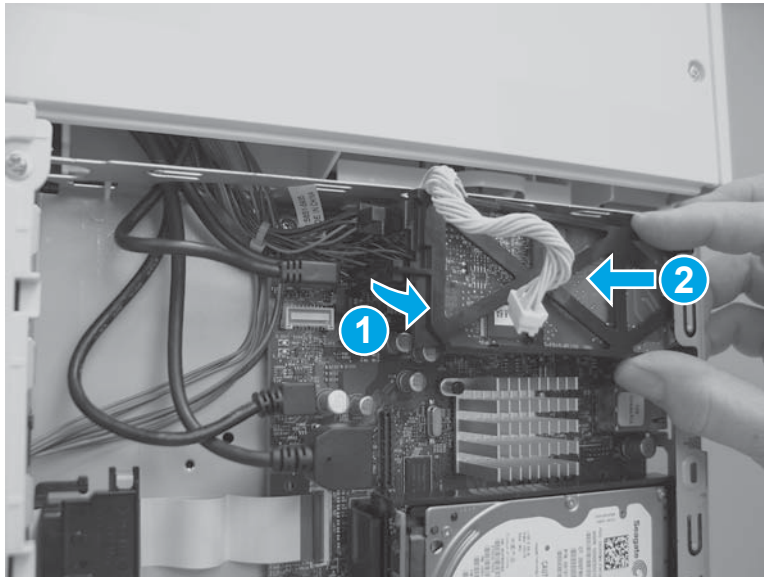

Step 9: Remove the formatter (M577)

 **NOTE:** This step is for the M577 models. For the M552 and M553 models, skip this step and go to [Step 10: Remove the rear cover \(M552 and M553\) on page 1513.](#)

 **CAUTION:**  ESD-sensitive part.

1. Disconnect all of the connectors on the formatter.

The following connectors are empty:

- All models: J1 (this connector is empty unless the optional DIMM is installed)
- All models: J3
- M577dn: J15 (this is the fax connector for the M577f/z/c models)
- All models: J21 (this connector is empty unless the optional internal USB ports component is installed)
- All models: J23
- All models: J24
- All models: J51
- All models: J57
- All models: J97
- All models: J98 (this connector is empty unless the optional trusted platform module (TPM) is installed)

 **IMPORTANT:** The flat-cable connector (callout 1) is a Zero Insertion Force (ZIF) connector that uses a hinged retainer to secure the flat cable. The hinged retainer must be opened to release the flat cable.

Figure 1-2662 Disconnect all connectors



2. Remove four screws (callout 1).

Figure 1-2663 Remove four screws

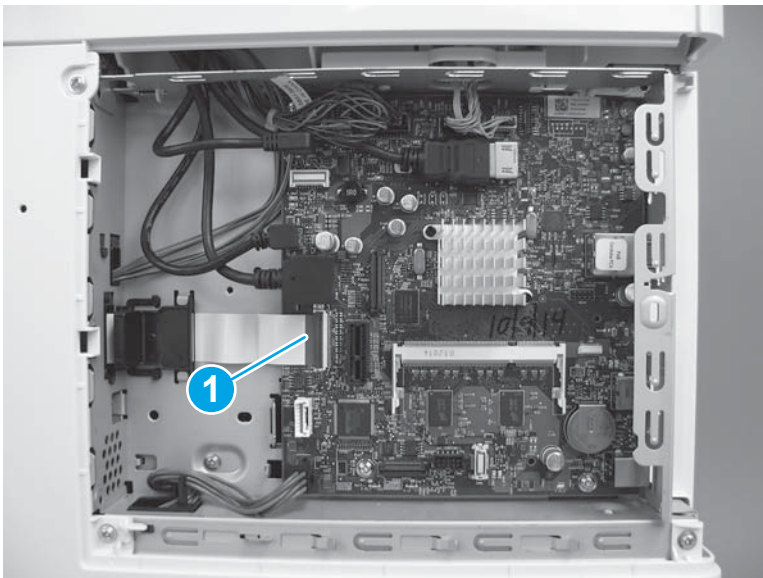
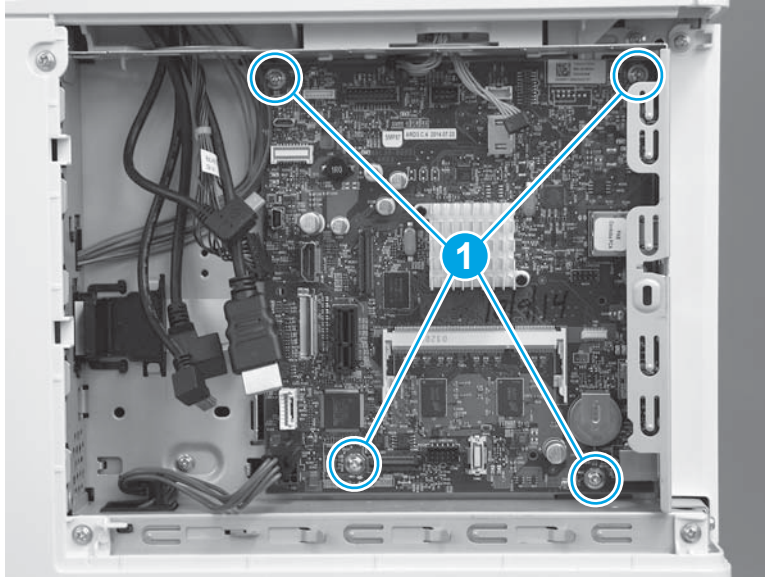

3. Remove the formatter.

Figure 1-2664 Remove the formatter

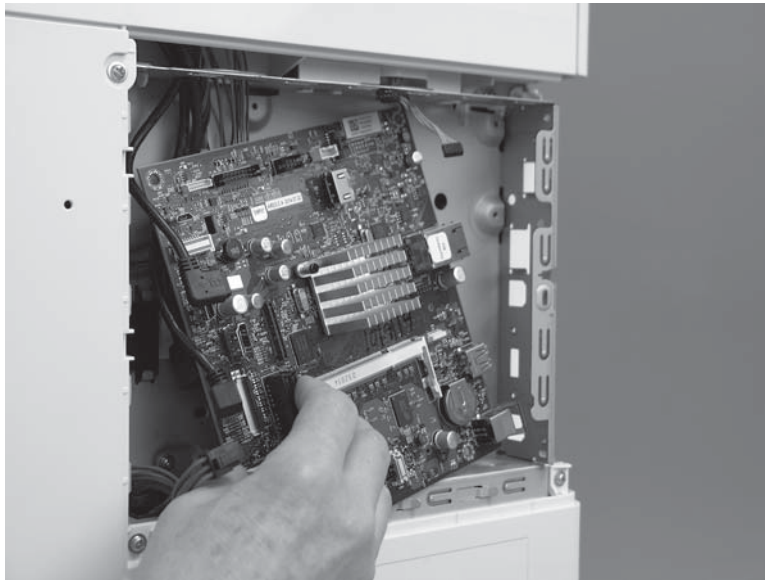

Step 10: Remove the rear cover (M552 and M553)

 **NOTE:** This step is for the M552 and M553 models. For the M577 models, skip this step and go to [Step 11: Remove the rear upper cover \(M577\) on page 1514.](#)

1. Remove four screws (callout 1).

Figure 1-2665 Remove four screws

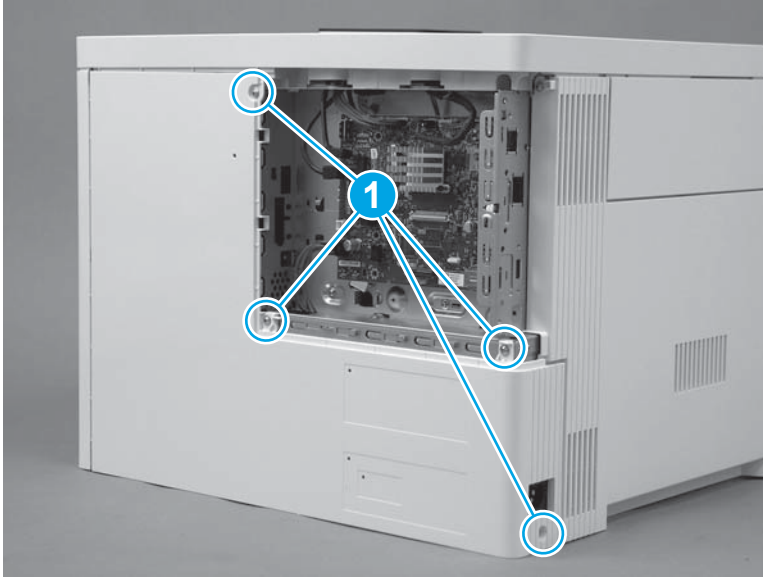

2. Slightly slide the cover to the right (callout 1), rotate the bottom of the cover away from the printer (callout 2), and then pull the top of the cover away from the printer (callout 3) to remove the cover.

Figure 1-2666 Remove the cover

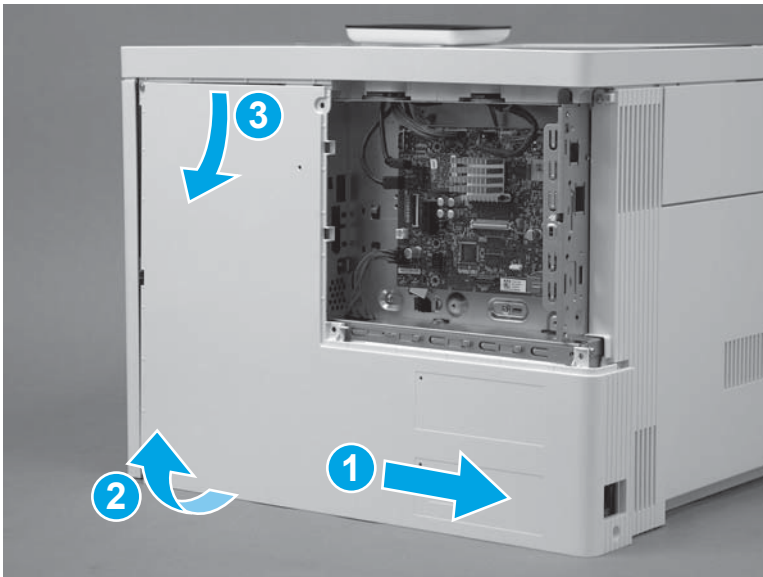

Step 11: Remove the rear upper cover (M577)



NOTE: This step is for the M577 models. For the M552 and M553 models, skip this step and go to [Step 19: Remove the left cover on page 1529](#).

1. Remove two screws (callout 1).



Reinstallation tip: These two screws are self-tapping screws for plastic. When reinstalling them, rotate the screws counterclockwise to align them with the existing thread pattern, and then carefully turn them clockwise to tighten. Do not overtighten. This will prevent stripping the threads inside the screw holes.

Figure 1-2667 Remove two screws

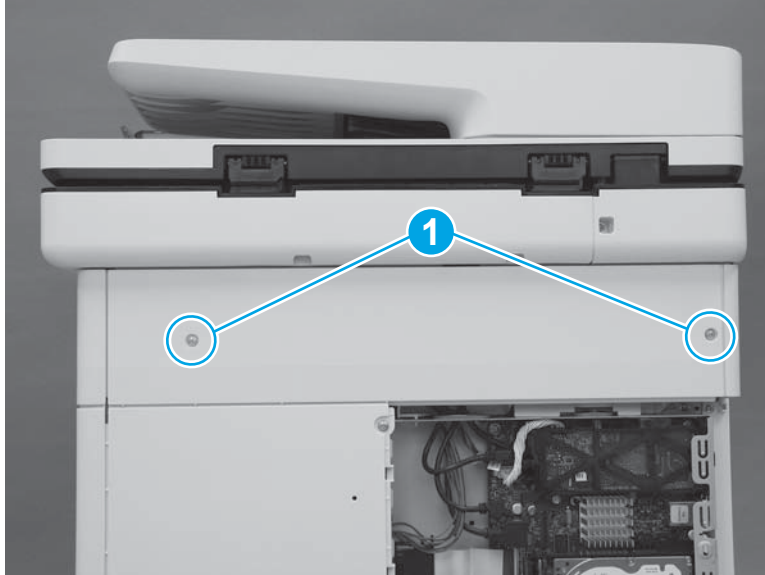

2. Use a small, flat blade screwdriver to release the right edge of the cover.

Figure 1-2668 Release the right edge

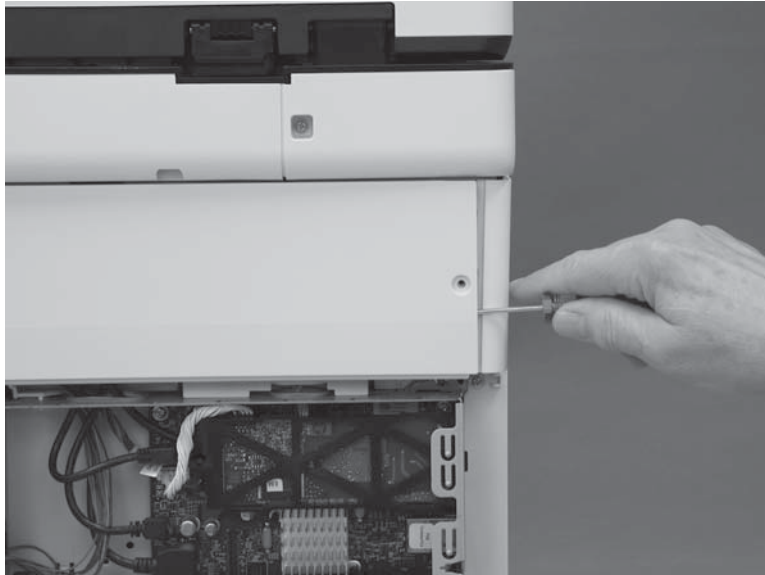

3. Pull the right edge of the cover (callout 1) away from the printer, and then slide the cover to the right (callout 2).

Figure 1-2669 Slide the cover right

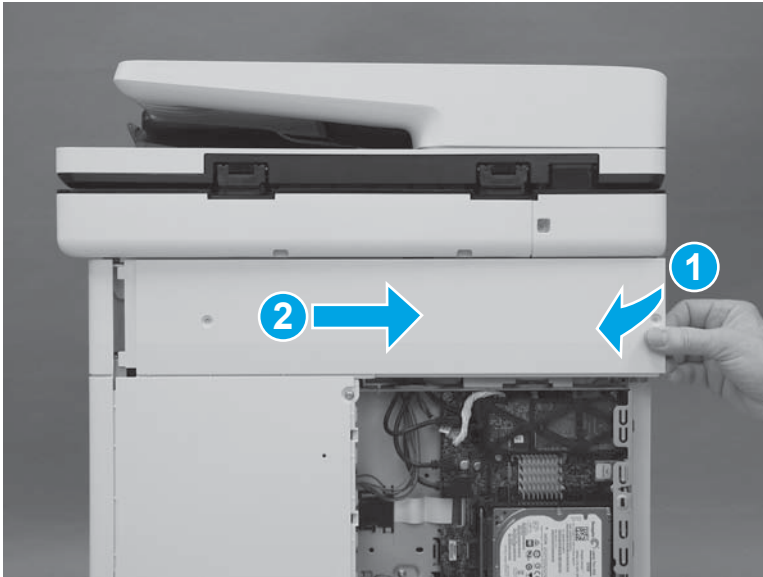

4. Remove the cover.

Figure 1-2670 Remove the cover

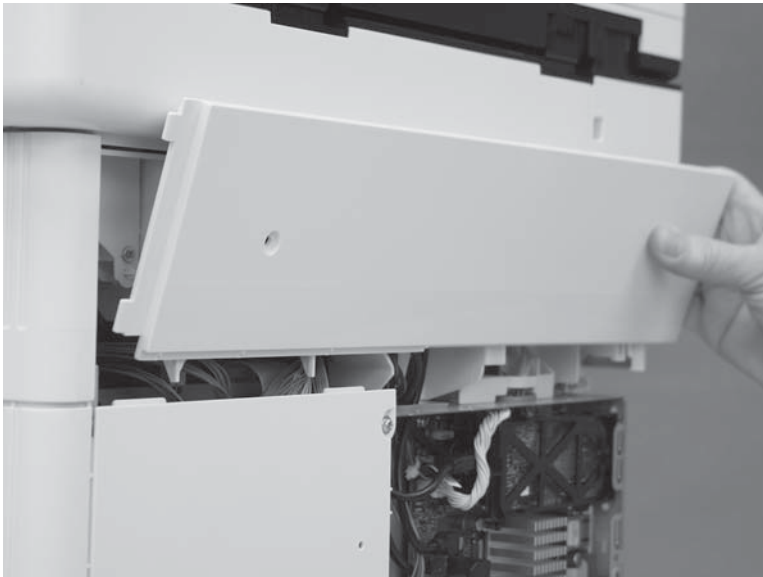

Step 12: Remove the rear cover (M577)



NOTE: This step is for the M577 models. For the M552 and M553 models, skip this step and go to [Step 19: Remove the left cover on page 1529.](#)

1. Remove four screws (callout 1).

Figure 1-2671 Remove four screws

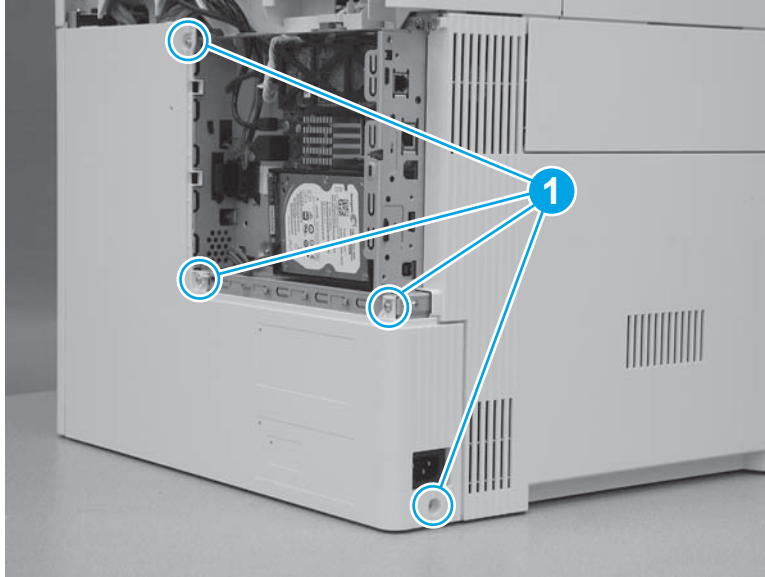

2. Slide the cover to the right to remove it.

Figure 1-2672 Remove the cover

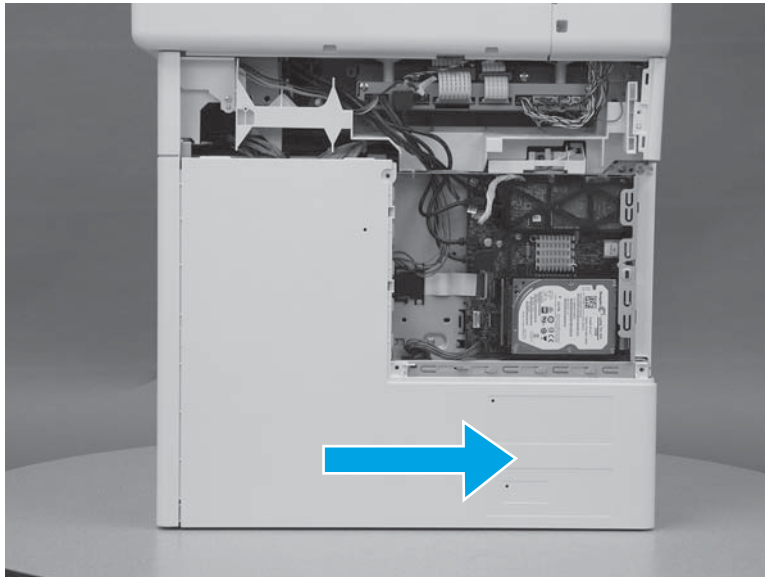

Step 13: Remove the left upper cover (M577)



NOTE: This step is for the M577 models. For the M552 and M553 models, skip this step and go to [Step 19: Remove the left cover on page 1529](#).

1. At the left side of the printer, release one tab (callout 1).

Figure 1-2673 Release one tab

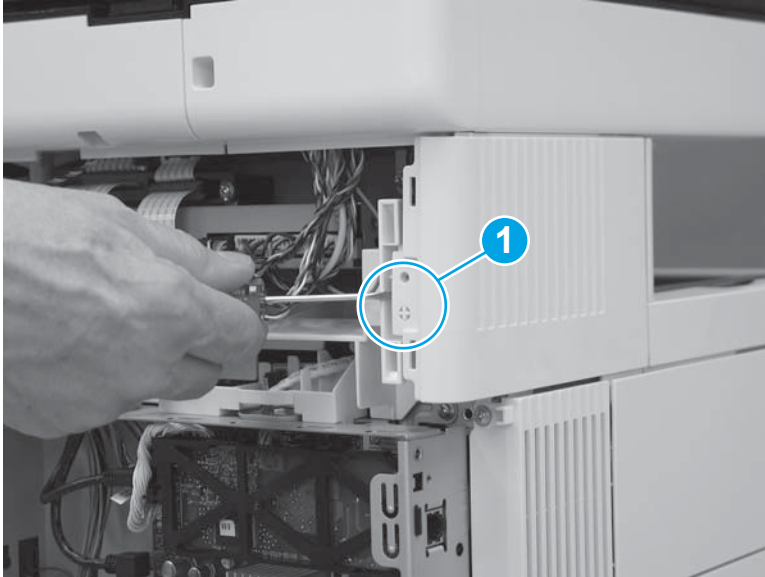

2. Slide the left upper cover toward the back of the printer.

Figure 1-2674 Slide the cover back

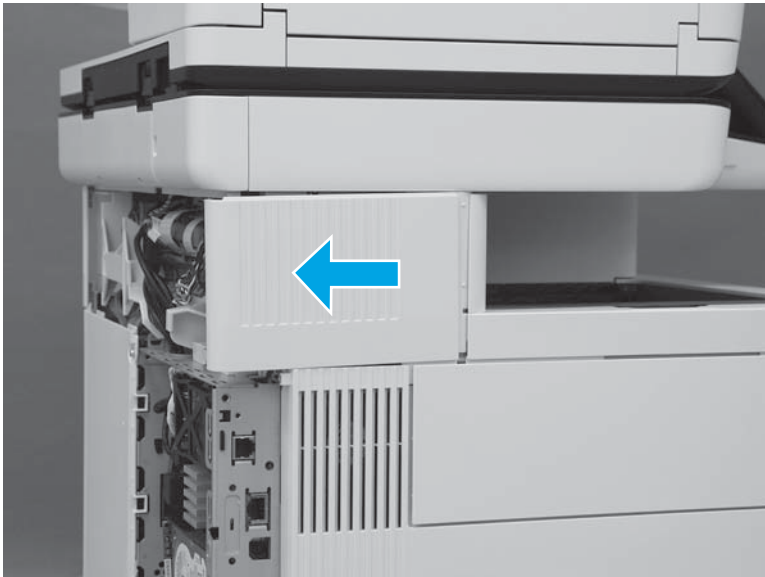

3. Rotate the cover up to remove it.

Figure 1-2675 Remove the left upper cover



Step 14: Remove the right front upper cover (M577dn)

 **NOTE:** This step is for the M577dn model. For the M577c/f/z models, skip this step and go to [Step 15: Remove the stapler cover assembly \(M577c/f/z\) on page 1520](#).

For the M552 and M553 models, skip this step and go to [Step 19: Remove the left cover on page 1529](#).

1. Remove one screw (callout 1).

Figure 1-2676 Remove one screw

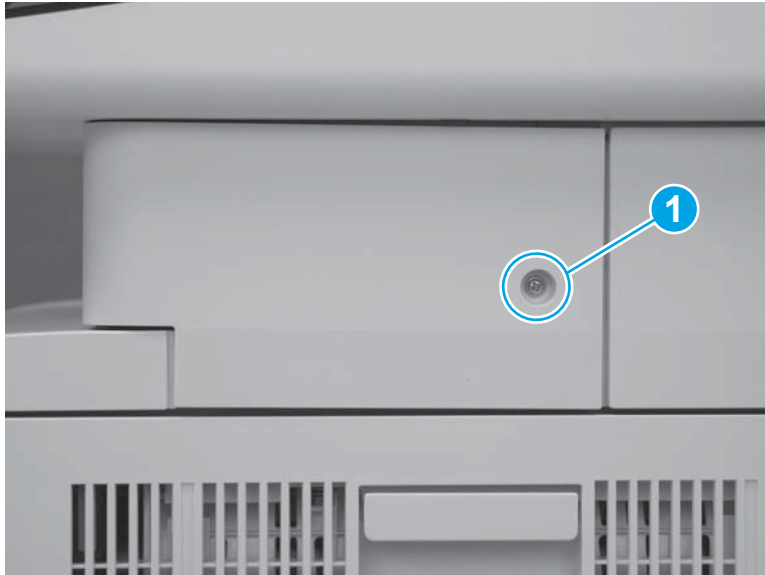

2. Release two tabs at the front edge of the cover (callout 1).

Figure 1-2677 Release two tabs



3. Rotate the front of the cover to the right to remove it.

Figure 1-2678 Rotate the cover



Step 15: Remove the stapler cover assembly (M577c/f/z)



NOTE: This step is for the M577c/f/z models. For the M577dn model, skip this step and go to [Step 17: Remove the right upper cover \(M577\) on page 1525](#).

For the M552 and M553 models, skip this step and go to [Step 19: Remove the left cover on page 1529](#).

1. Remove one screw (callout 1).

 **Reinstallation tip:** This is a self-tapping screw for plastic. When reinstalling, rotate the screw counterclockwise to align it with the existing thread pattern, and then carefully turn it clockwise to tighten. Do not overtighten. This will prevent stripping the threads inside the screw hole.

Figure 1-2679 Remove one screw



2. Release two tabs at the front edge of the cover (callout 1).

Figure 1-2680 Release two tabs

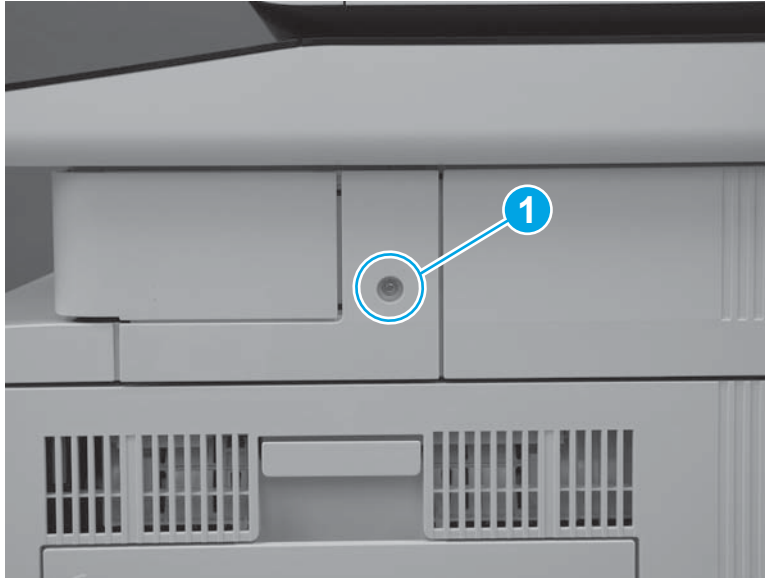

3. Release the back edge of the cover.

Figure 1-2681 Release the back edge of the cover

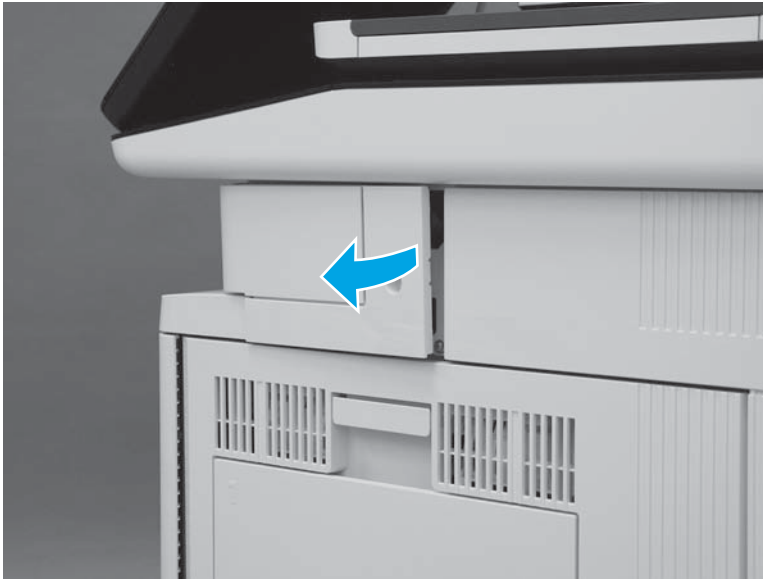



4. Rotate the cover away from the printer to remove it.

Figure 1-2682 Remove the cover



Step 16: Remove the integrated scanner assembly (ISA) (M577)

 **NOTE:** This step is for the M577 models. For the M552 and M553 models, skip this step and go to [Step 19: Remove the left cover on page 1529](#).

 **NOTE:** The ISA includes the document feeder, image scanner, scanner control board (SCB), control panel, keyboard (M577c/z) and NFC PCA (M577z).

1. At the left side of the printer, remove one screw (callout 1).

Figure 1-2683 Remove one screw

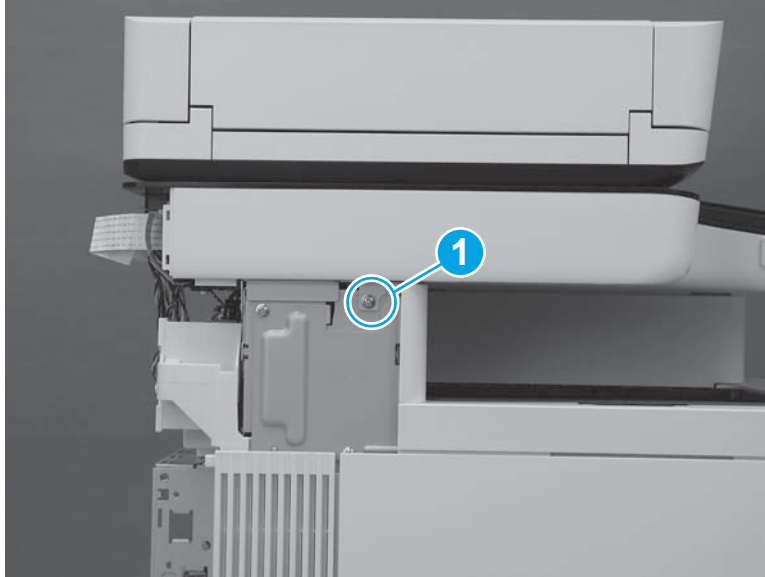

2. At the back side of the printer, remove two screws (callout 1).

Figure 1-2684 Remove two screws

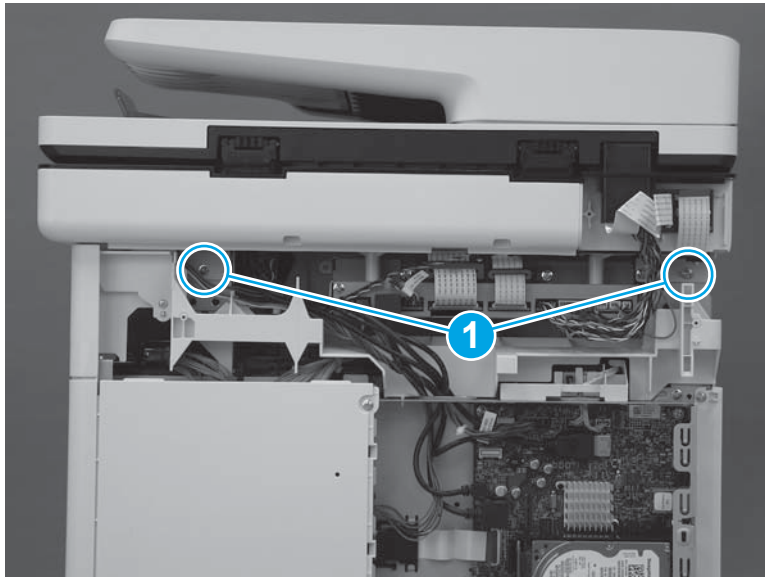

3. At the right side of the printer, remove one screw (callout 1).

Figure 1-2685 Remove one screw

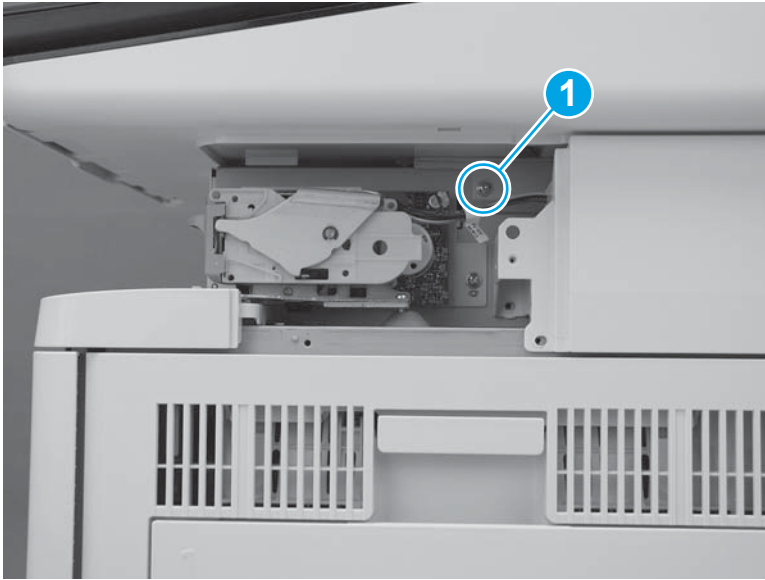

4. Disconnect two connectors on the scanner control board (callout 1).

M577c/f/z only: Disconnect one connector for the stapler on the scanner control board (callout 2).

Figure 1-2686 Disconnect connectors

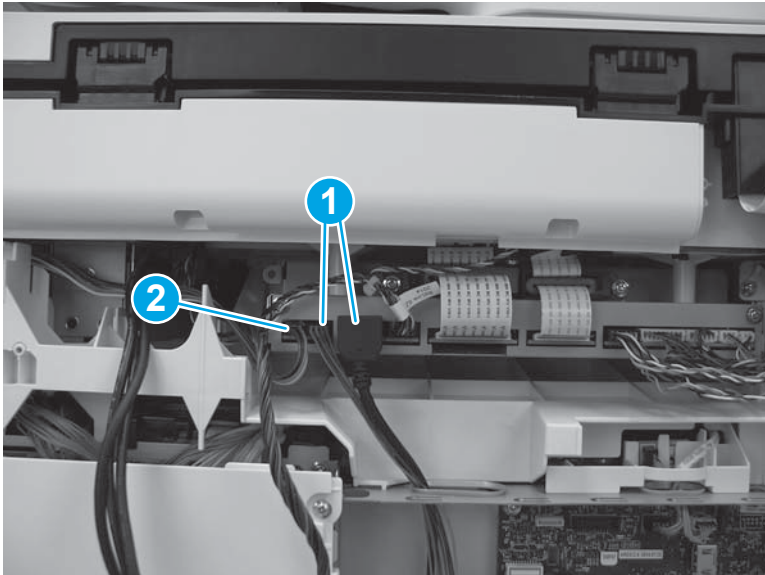

5. Slightly slide the ISA towards the back of the printer to release it.

Figure 1-2687 Slide the ISA towards the back of the printer

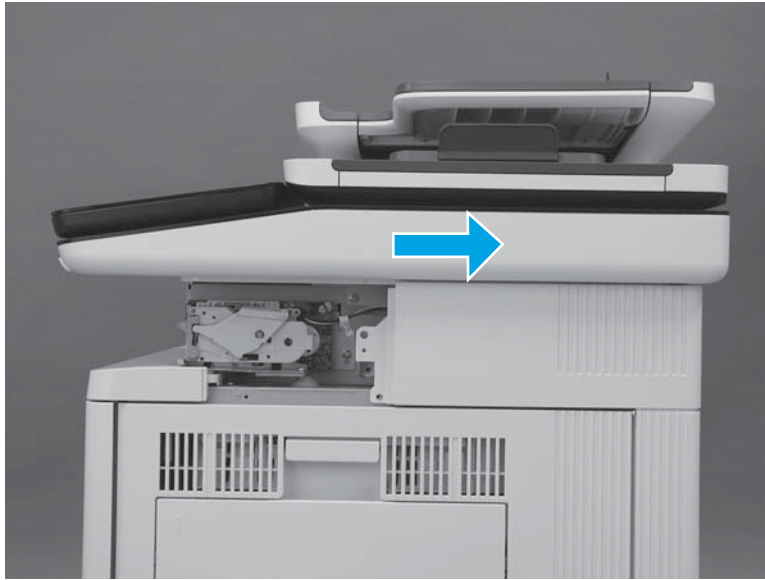

6. Lift the ISA up to remove it.



 **NOTE:** When lifting the ISA, carefully pass the cables through the opening in the top of the formatter case.

Figure 1-2688 Remove the ISA

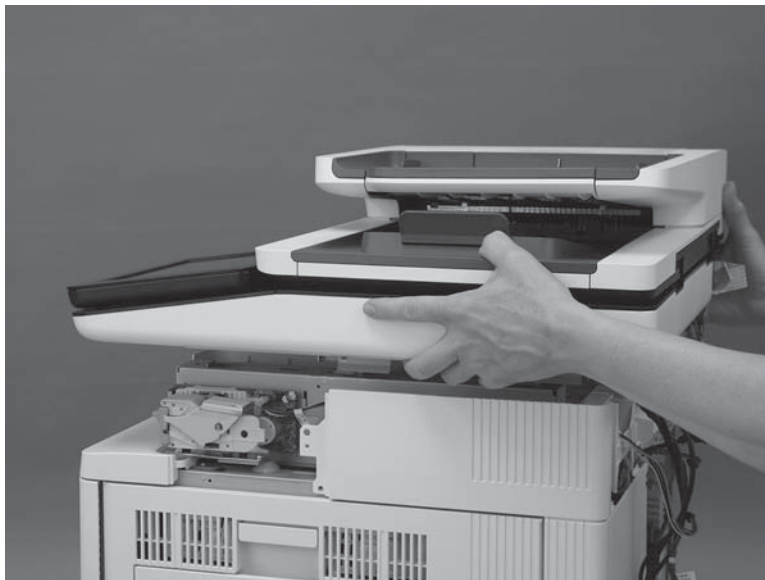

Step 17: Remove the right upper cover (M577)

 **NOTE:** This step is for the M577 models. For the M552 and M553 models, skip this step and go to [Step 19: Remove the left cover on page 1529](#).



NOTE: The figures below show the image scanner installed. The procedures for removing and installing the right upper cover are the same whether the image scanner is installed or removed."

1. At the right side of the printer, remove two screws (callout 1).

M577c/f/z only: Disconnect one connector (callout 2), if it was not already disconnected in a previous step.

Figure 1-2689 Remove two screws and one connector

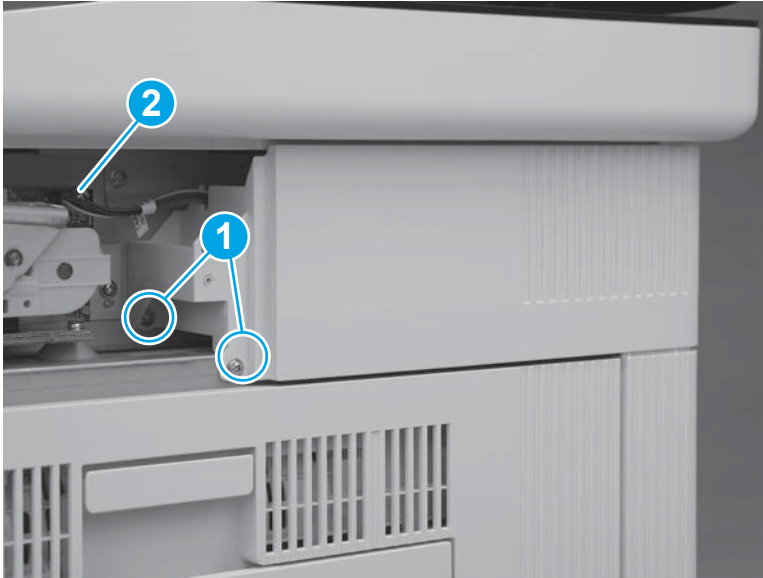

2. At the back of the printer, remove one screw (callout 1).

M577c/f/z only: Disconnect one connector (callout 2), if it was not already disconnected in a previous step.



Reinstallation tip: This screw is smaller than the screws removed in the previous step. When reinstalling the right upper cover, make sure that this screw is installed in the correct position.

Figure 1-2690 Remove one screw and connector

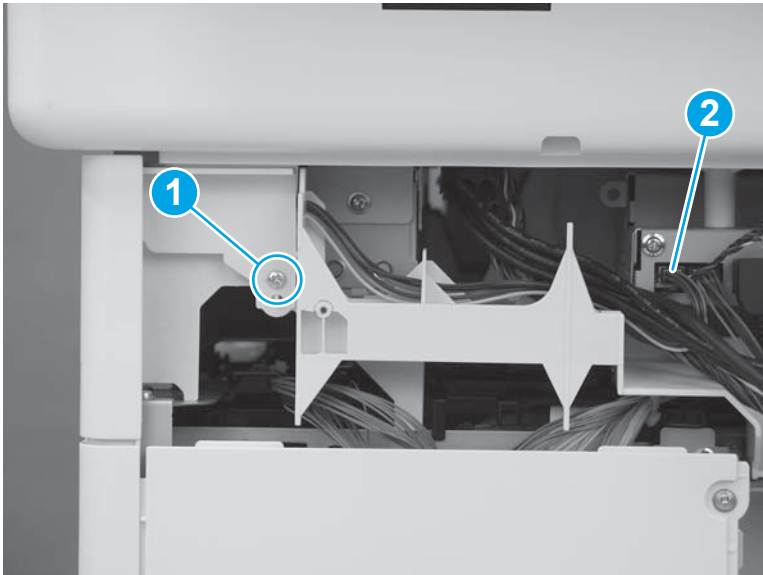

3. Slide the cover toward the back of the printer.

Figure 1-2691 Slide the cover

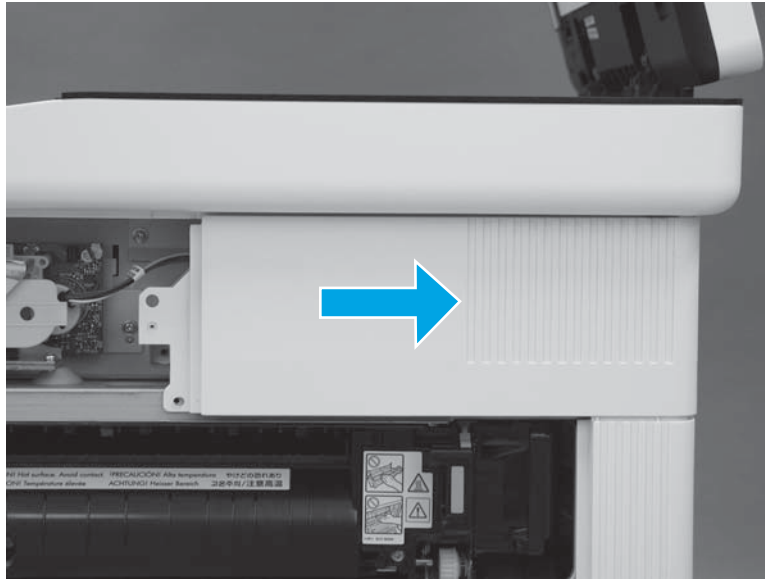

4. Lift the cover away from the printer to remove it.

M577c/f/z only: Release the cables (callout 1) through the slot (callout 2) in the printer.

Figure 1-2692 Remove the cover

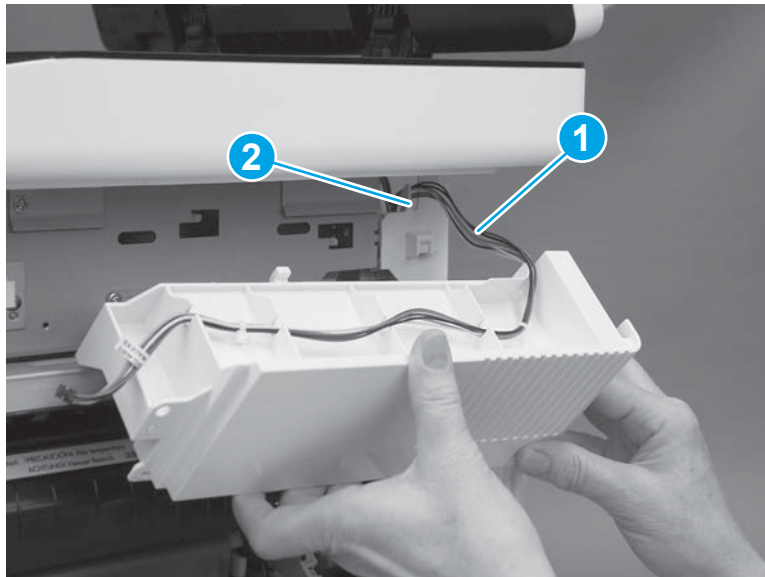

Step 18: Remove the top rear cover (M577)

 **NOTE:** This step is for the M577 models. For the M552 and M553 models, skip this step and go to [Step 19: Remove the left cover on page 1529.](#)

1. At the top of the printer, remove five screws (callout 1).

Figure 1-2693 Remove five screws

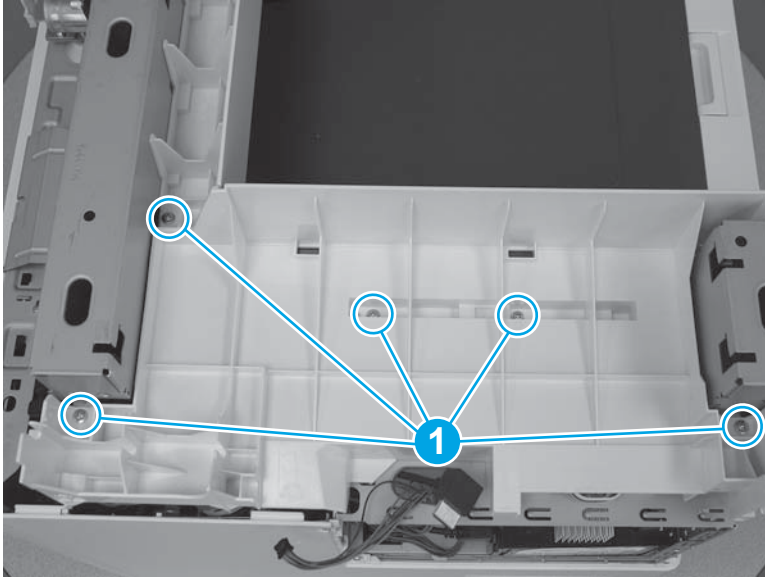

2. Release two tabs (callout 1) on the front edge of the cover.

Figure 1-2694 Release two tabs

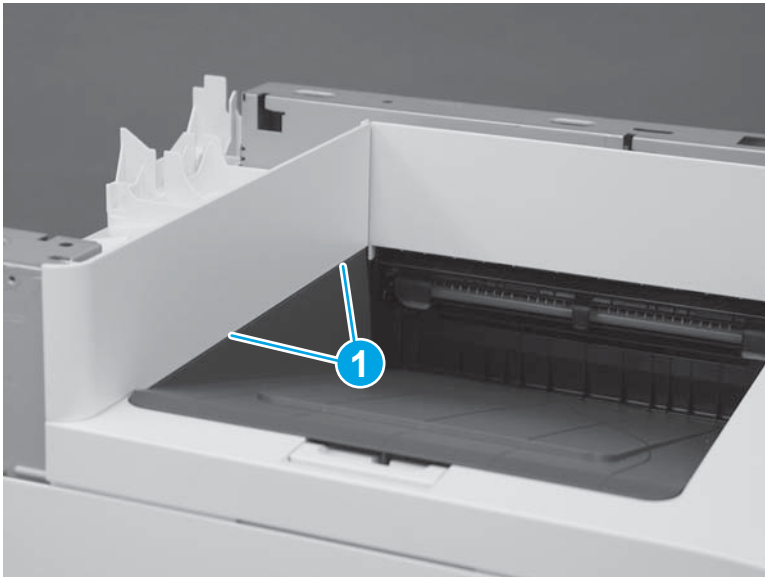

3. Remove the top rear cover.

Figure 1-2695 Remove the top rear cover

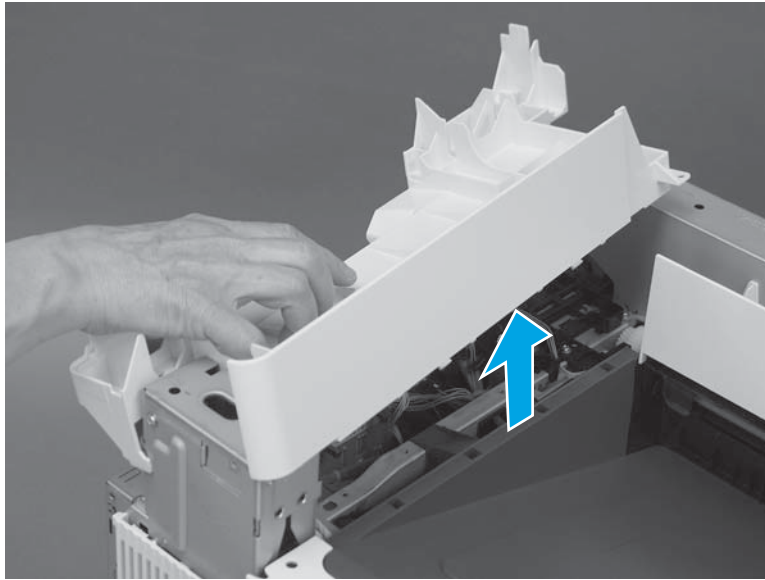

Step 19: Remove the left cover

1. At the left side of the printer, remove one screw (callout 1).

Figure 1-2696 Remove one screw



2. Release one tab (callout 1), rotate the front edge of the cover away from the printer (callout 2), and then slide the cover (callout 3) toward the rear of the printer to release it.

Figure 1-2697 Release the cover

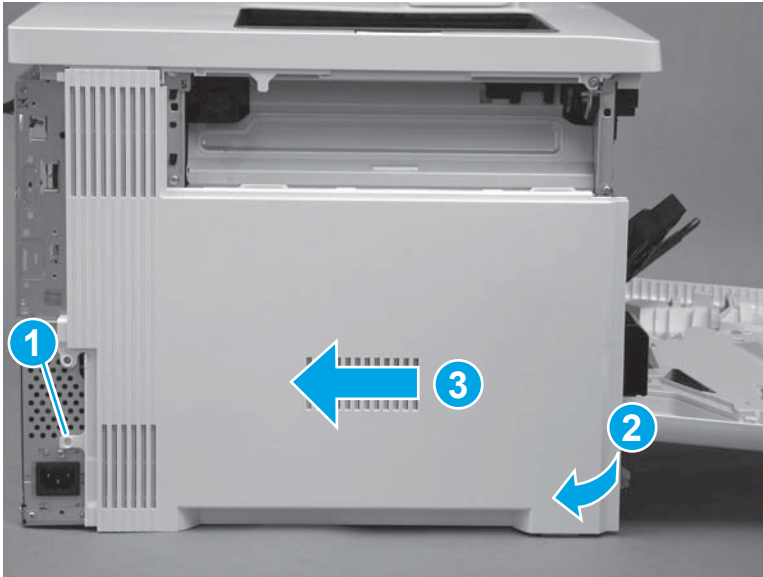

3. Remove the cover.

Figure 1-2698 Remove the cover

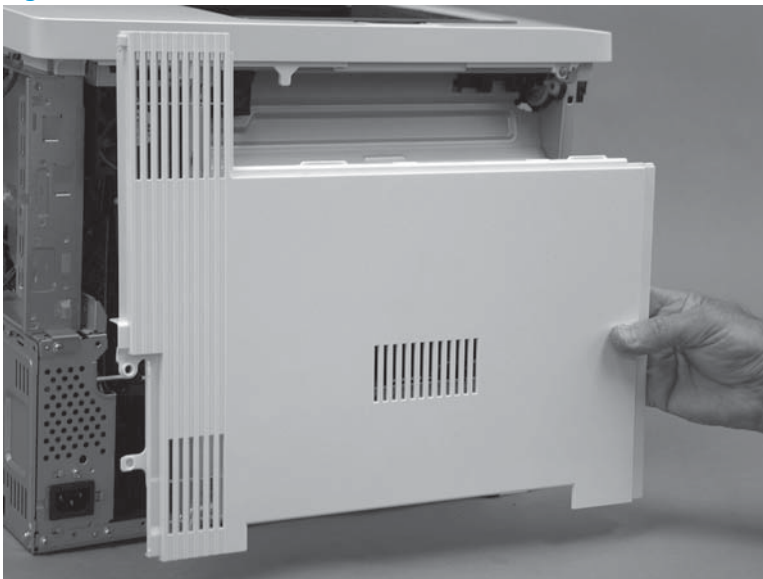

Step 20: Remove the upper cover (M552 and M553)

 **NOTE:** This step is for the M552 and M553 models. For the M577 models, skip this step and go to [Step 21: Remove the formatter case on page 1532.](#)

1. Remove three screws (callout 1).

Figure 1-2699 Remove three screws

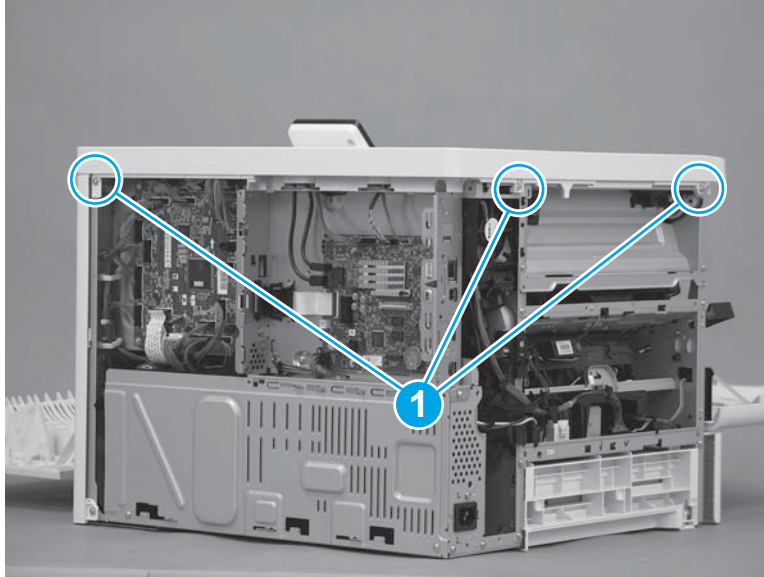

2. Remove one screw (callout 1), release one tab (callout 2), and then slightly separate the corner of the cover from the chassis.

 **NOTE:** This is a self-tapping plastic-thread screw. Make sure that this screw is used in this location when it is reinstalled.

Figure 1-2700 Remove one screw and release one tab



3. Release one tab (callout 1), and then lift up on the cover to release it.

 **NOTE:** If the cover does not release, check for additional tabs by locating the triangles embossed in the cover at tab locations.

Figure 1-2701 Release the cover



4. Remove the cover.

Figure 1-2702 Remove the cover

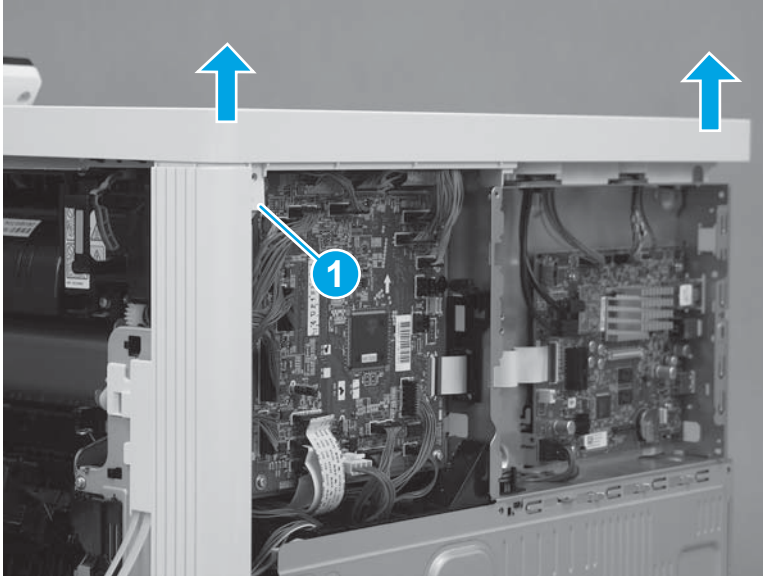
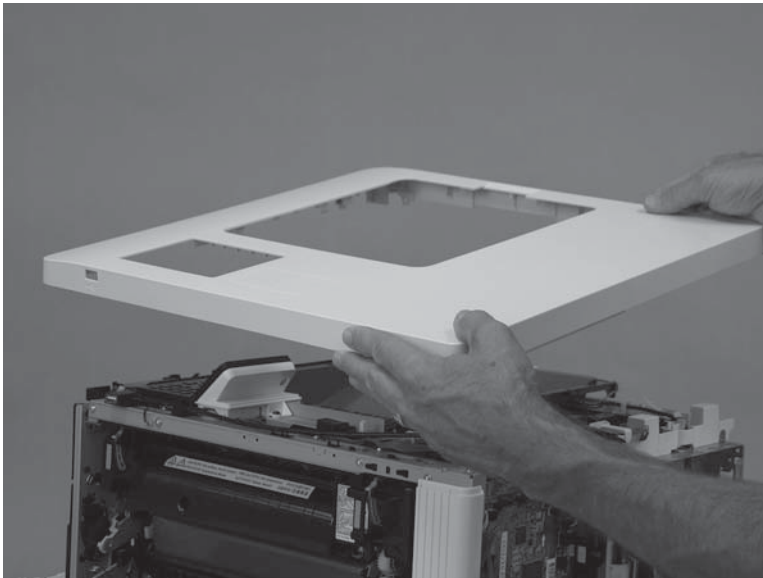

Step 21: Remove the formatter case

1. **M577 only:** Disconnect one connector (callout 1), and then pass the wire harness (callout 2) through two openings in the formatter case (callout 3).

Figure 1-2703 Disconnect one connector

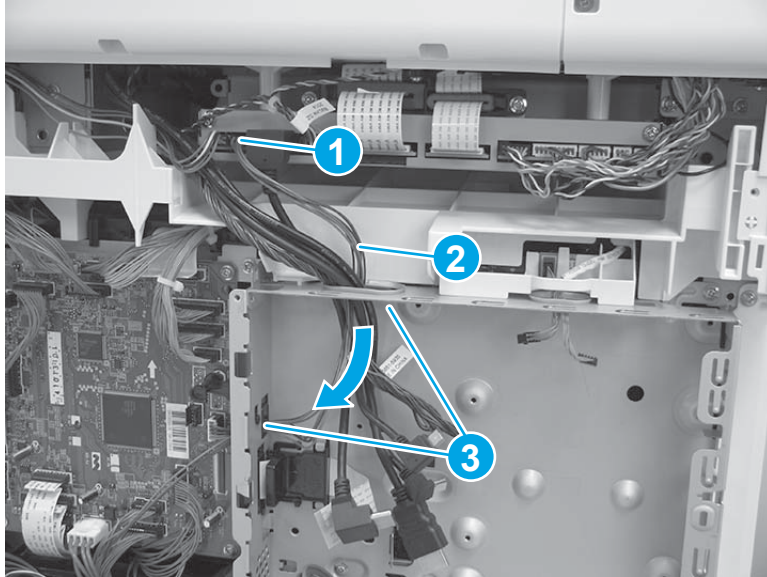

2. Release two tabs (callout 1) on the black plastic bracket. Hold the tabs in the released position, and then slide the bracket (callout 2) to the right to remove it from the formatter case.

Figure 1-2704 Remove the bracket

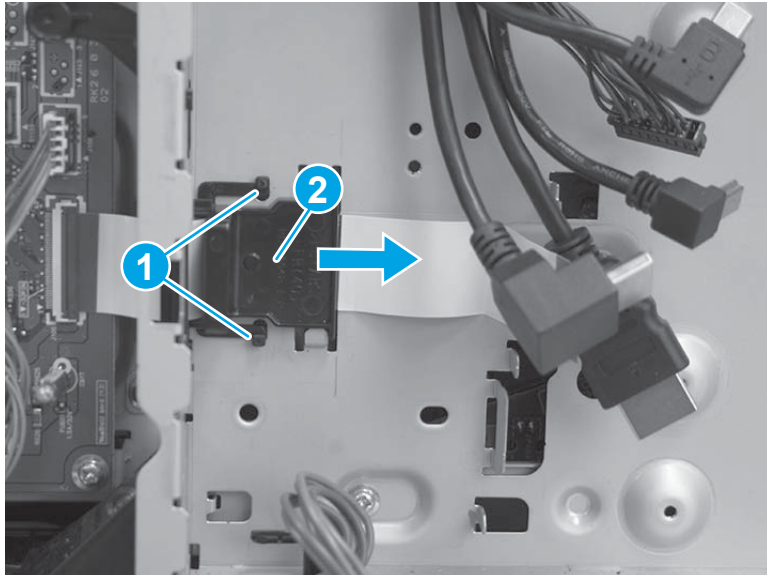

3. Remove two screws (callout 1), and then slide the low-voltage power supply (LVPS) cover to the right to remove it.

Figure 1-2705 Remove the LVPS cover

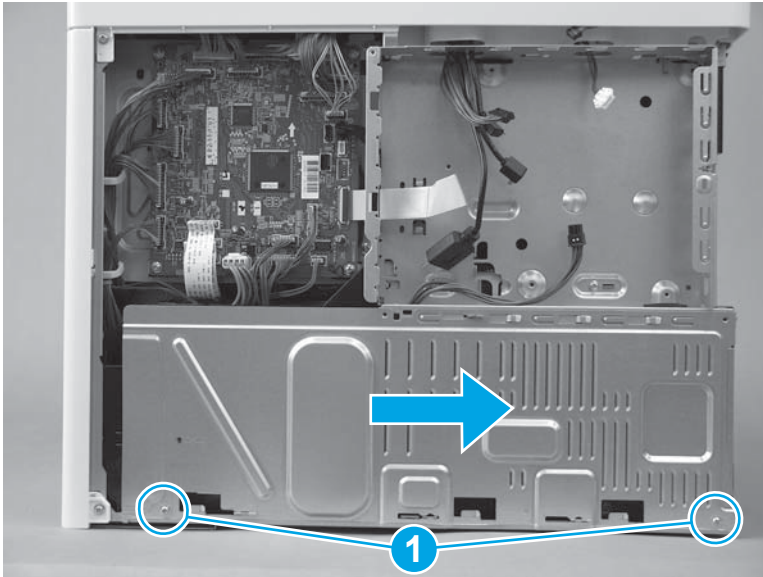

4. Pass two wire harnesses and one flat cable (callout 1) through the opening in the formatter case, and then release one wire harness from the retainer (callout 2).

CAUTION: The flat cable might be attached to the formatter case with double-sided tape. Make sure that this tape is released, so that the flat cable is not damaged when the formatter case is removed.

Figure 1-2706 Release wire harnesses and flat cable

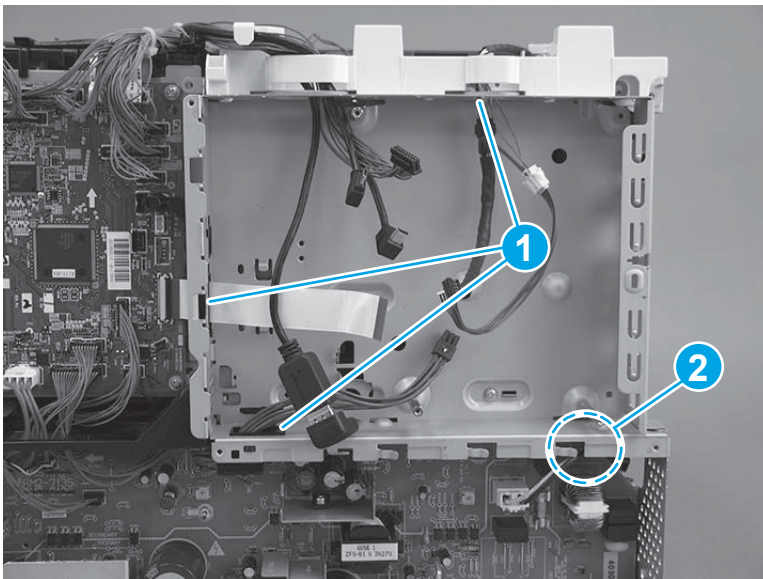

5. Remove six screws (callout 1).

Figure 1-2707 Remove six screws

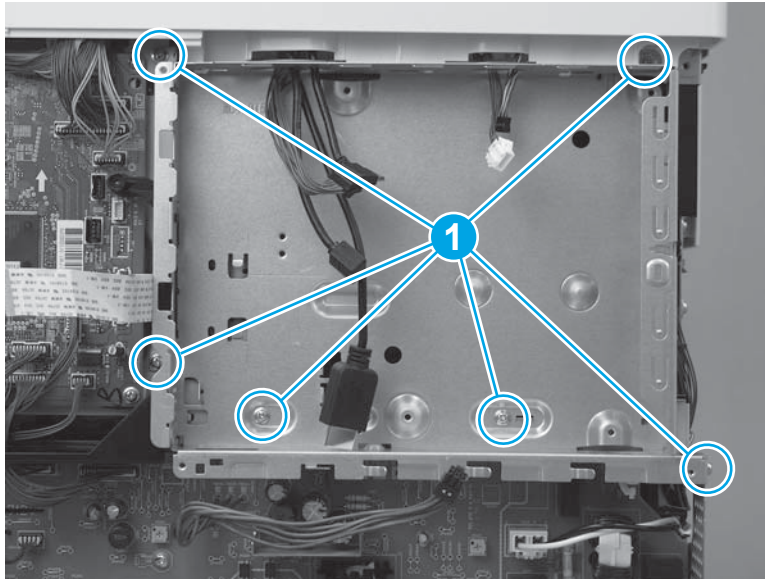

6. Rotate the bottom of the formatter case away from the printer (callout 1), and then pull it down (callout 2) to release it.

Figure 1-2708 Release the formatter case

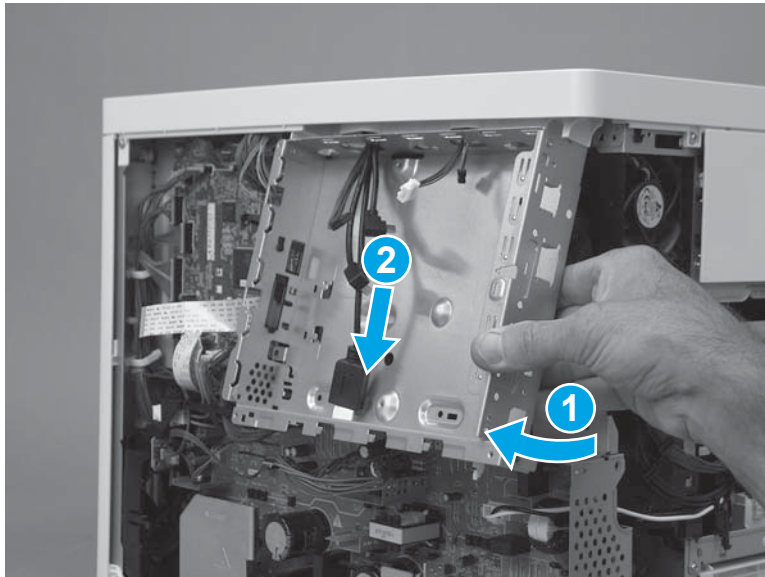

7. Pass the wire harnesses through the opening in the formatter case to remove it.

 **IMPORTANT:** If the formatter case is removed so that it can be replaced, make sure to transfer the memory PCA (island of data) and plastic bracket (callout 1) to the replacement case.

Figure 1-2709 Remove the formatter case



Step 22: Remove the right rear cover

1. Remove one screw (callout 1), and then slide the cover toward the rear of the printer (callout 2) to release it.

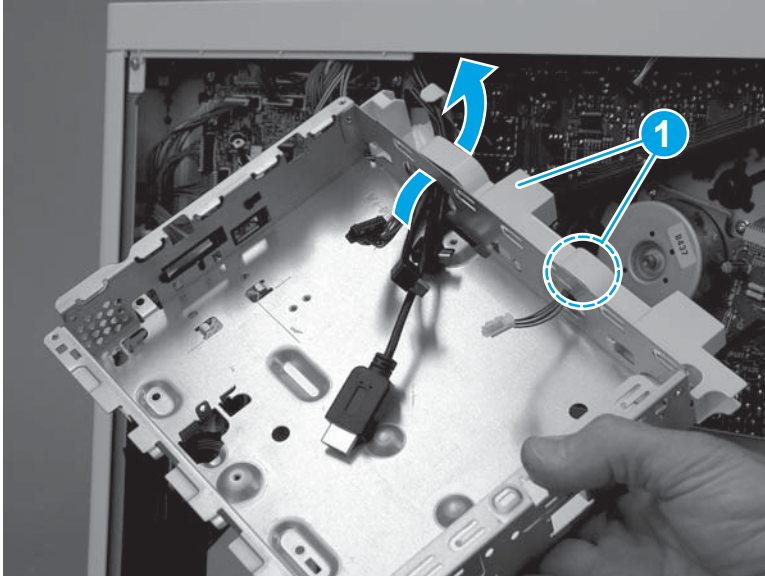
 **TIP:** If the right door is closed, open it now.

Figure 1-2710 Release the cover

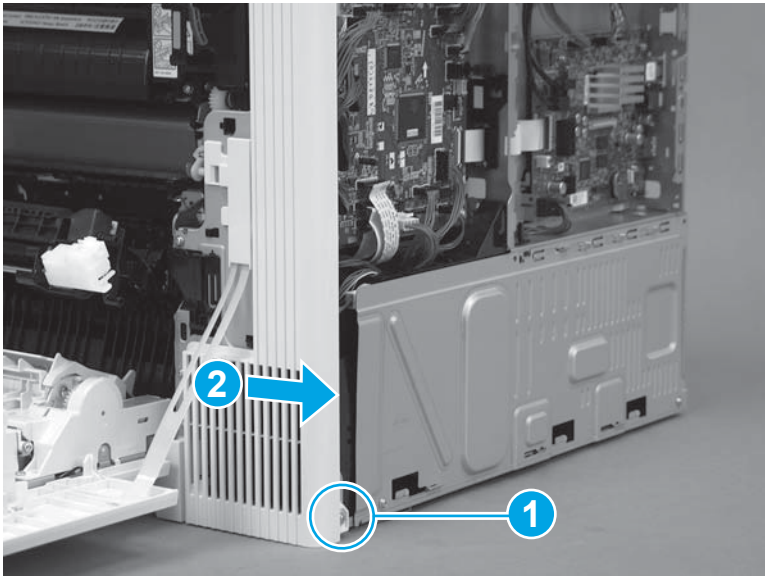

2. Remove the cover.

Figure 1-2711 Remove the cover

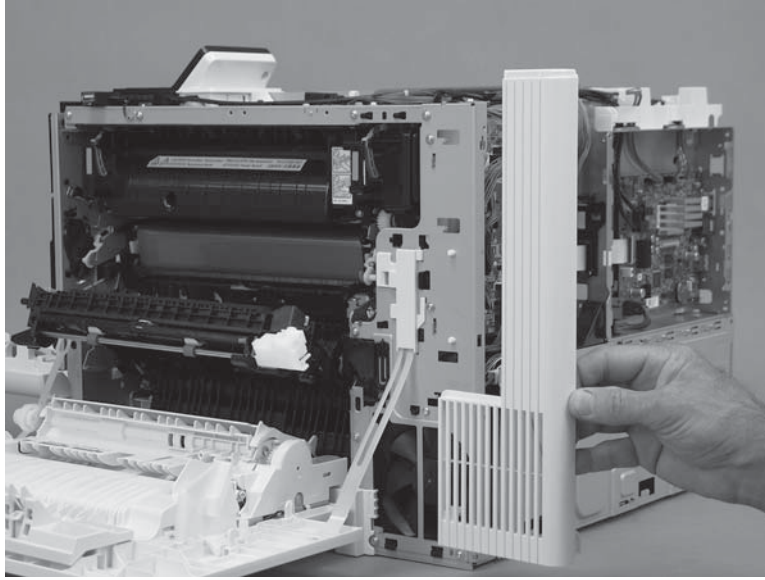

Step 23: Remove the DC controller and sheet-metal bracket

CAUTION:  ESD sensitive part.

1. Disconnect all of the connectors, and then remove two screws (callout 1).

The following connectors are empty:

- J140, J141, and J143

Figure 1-2712 Remove two screws

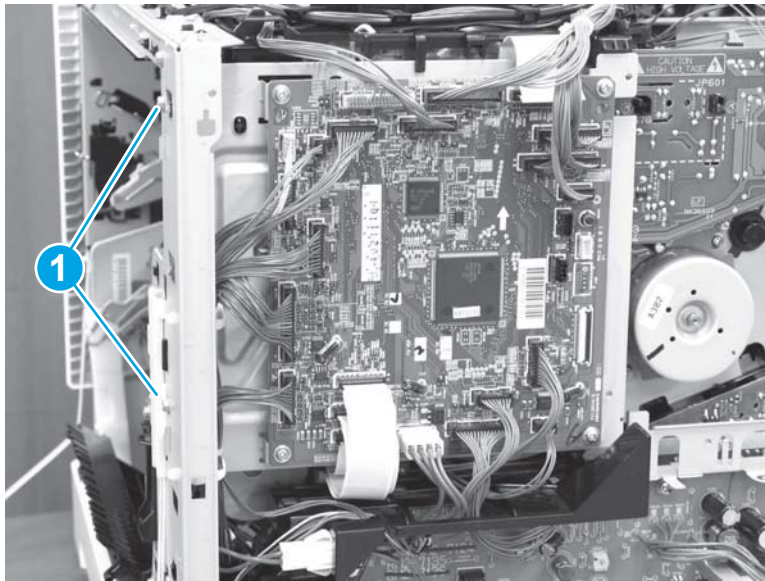

2. Lift up on the DC controller and sheet-metal plate to remove it.

Figure 1-2713 Remove the plate

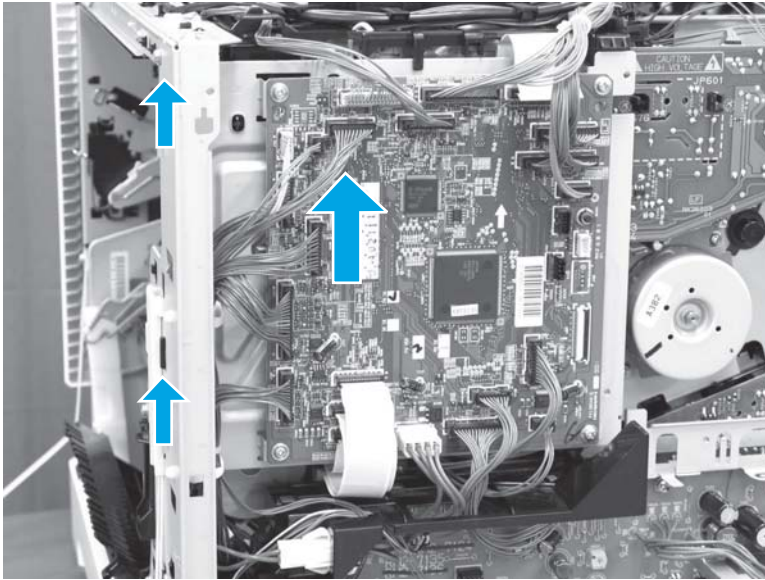

Step 24: Remove the high-voltage power supply T (HVPST)

 **CAUTION:**  ESD-sensitive part.

1. Disconnect five connectors (callout 1), and then disconnect one flat cable (callout 2).

Figure 1-2714 Disconnect five connectors and one flat cable

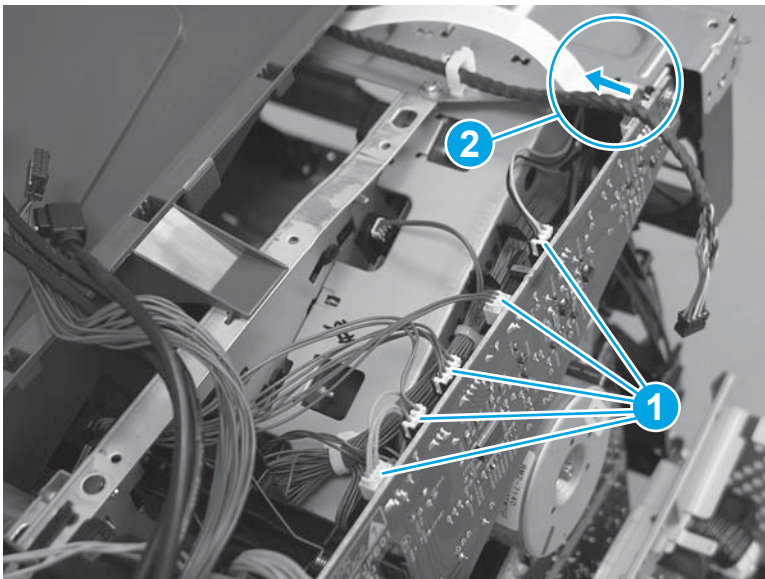

2. Remove one screw (callout 1).

Figure 1-2715 Remove one screw

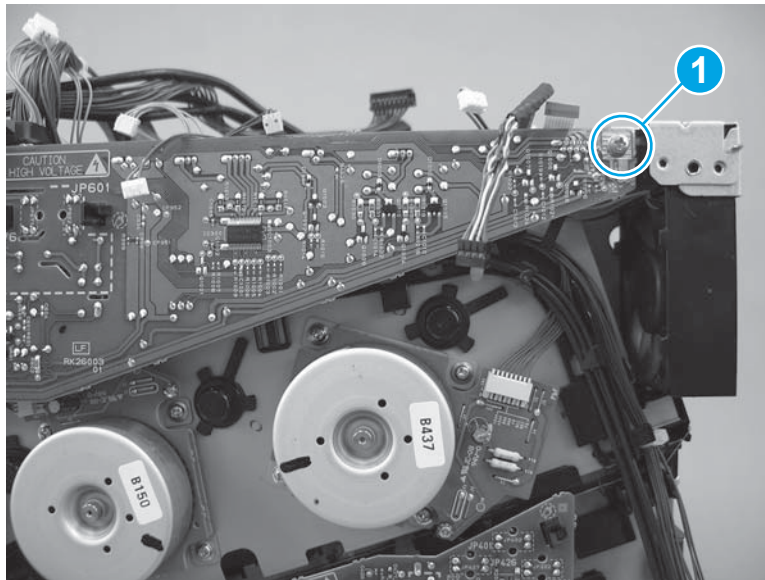

3. Release two tabs (callout 1), and then separate the HVPST from the printer.

⚠ CAUTION: Do not attempt to completely remove the HVPST. It is still connected to the printer by ground wire harness.

Figure 1-2716 Release the HVPST

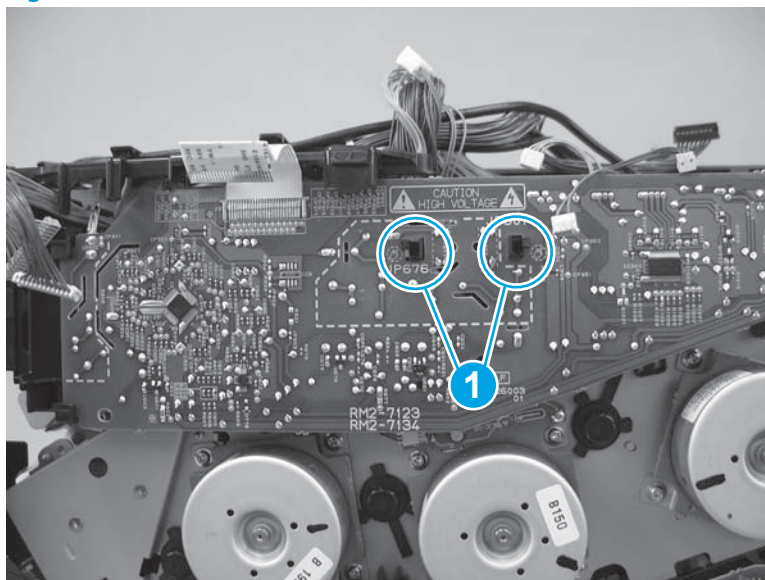

4. Release one ground wire connector (callout 1), and then remove the HVPST.

Figure 1-2717 Remove the HVPST

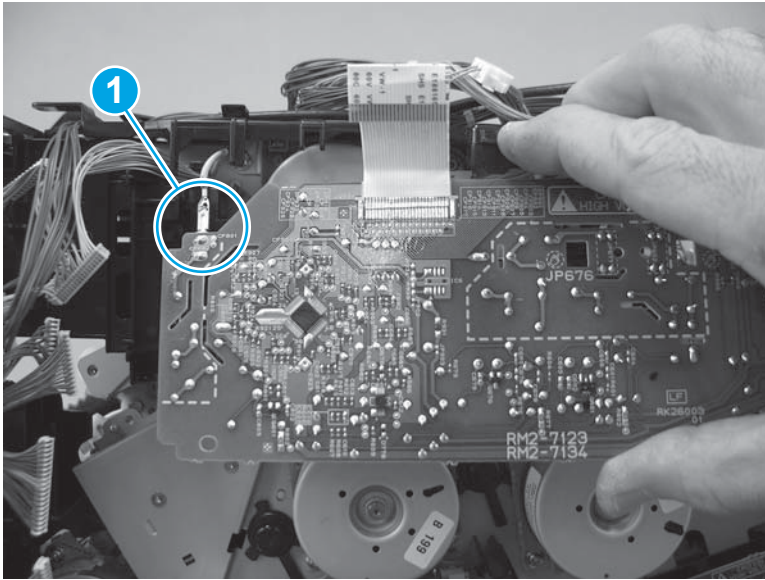

Step 25: Remove drum motor 2 (M2)

- ▲ Disconnect one connector (callout 1), remove four screws (callout 2), and then remove the motor.

Figure 1-2718 Remove the motor

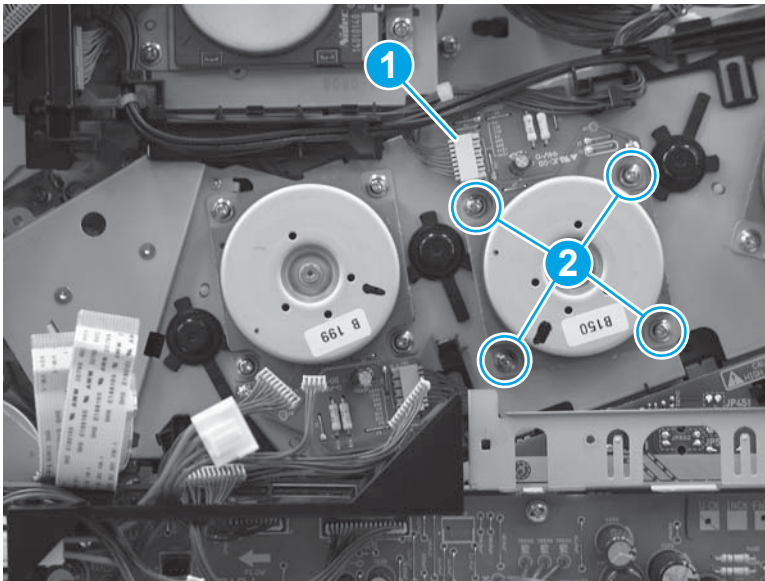

Step 26: Unpack the replacement assembly

Unpack the replacement assembly from the packaging.

For complete information on HP's recycling programs, go to [Product return and recycling](#).



NOTE: HP recommends responsible disposal of the defective assembly.

Figure 1-2719 Recycle and unpack

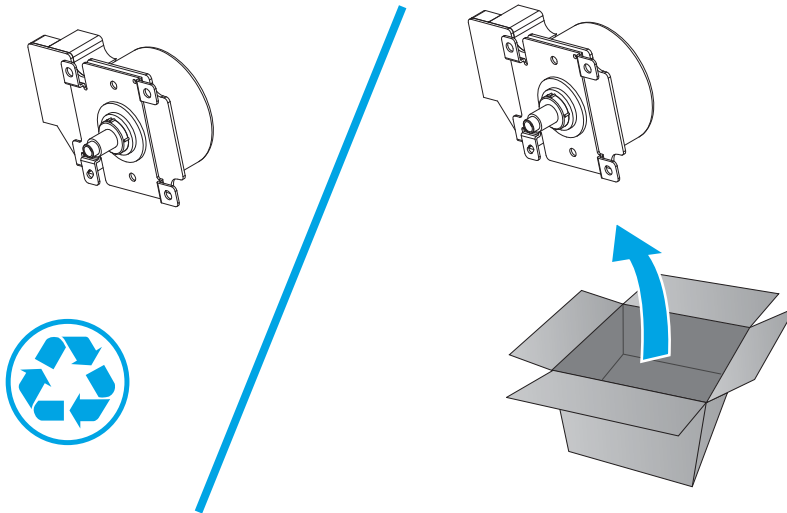

Step 27: Install drum motor 2 (M2)

- ▲ Position the motor on the printer, install four screws (callout 1), and then connect one connector (callout 2).

Figure 1-2720 Install the motor

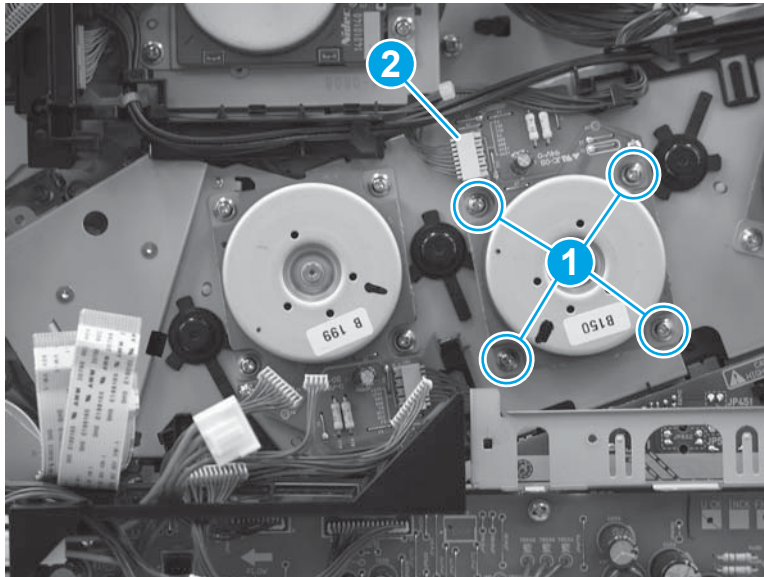

Step 28: Install the HVPST

⚠ **CAUTION:**  ESD-sensitive part.

1. Connect one ground wire connector (callout 1).

Figure 1-2721 Connect one ground wire

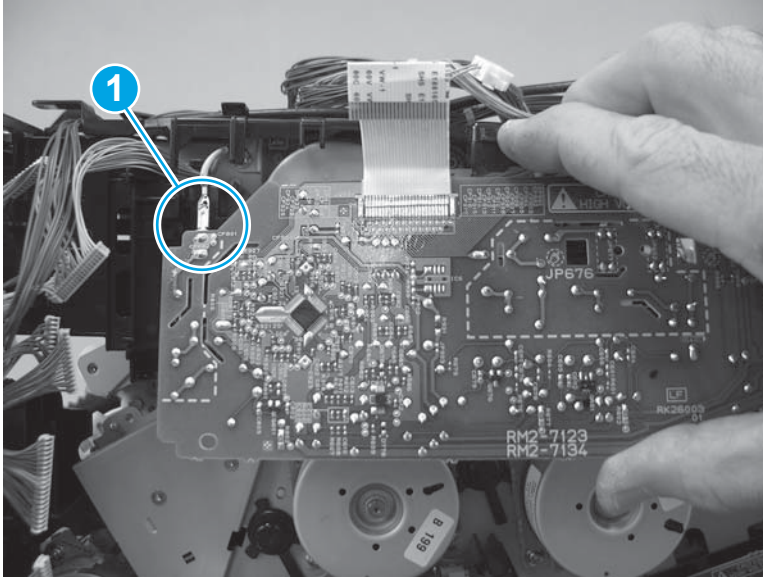

2. Position the HVPST on the printer, and then push in to engage two tabs (callout 1).

 **NOTE:** Make sure that the tabs snap into place.

Figure 1-2722 Install the HVPST



3. Install one screw (callout 1).

Figure 1-2723 Install one screw

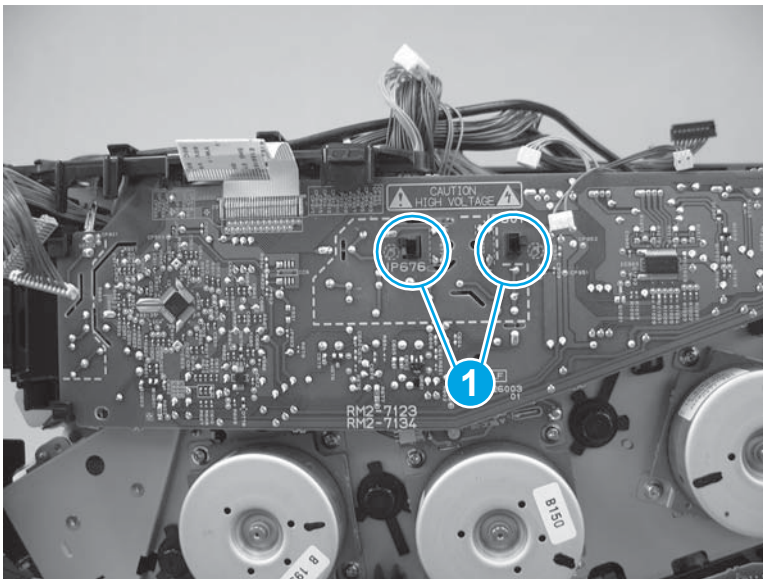
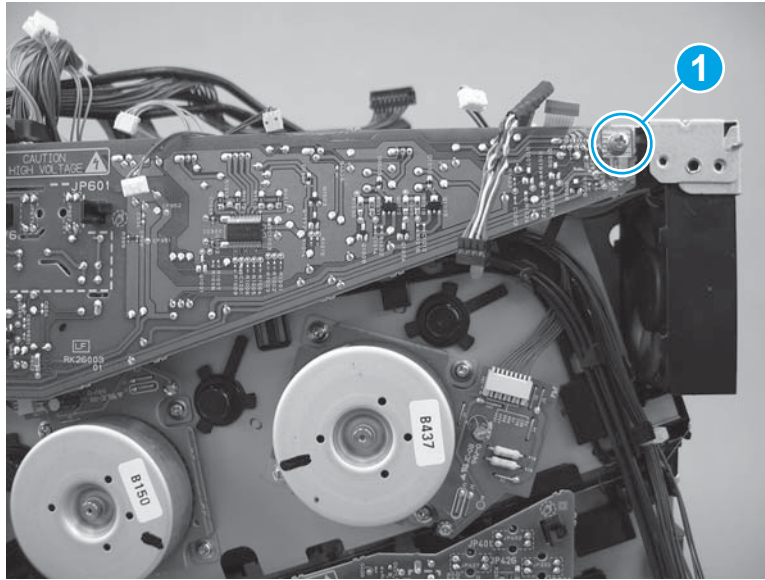

4. Connect five connectors (callout 1), and then connect one flat cable (callout 2).

Figure 1-2724 Connect five connectors and one flat cable

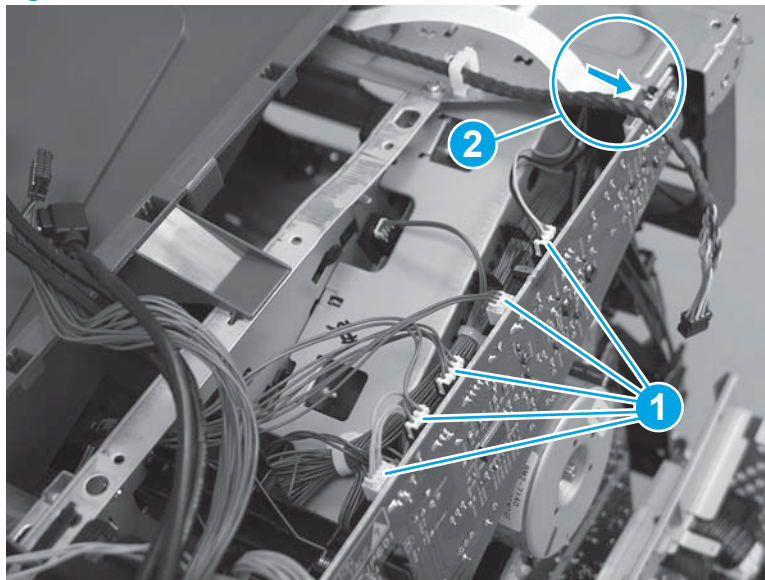

Step 29: Install the DC controller and sheet-metal bracket

 **CAUTION:**  ESD-sensitive part.

1. Position the DC controller and sheet-metal plate on the printer, and then push down to engage the plate with the chassis.

Figure 1-2725 Install the plate

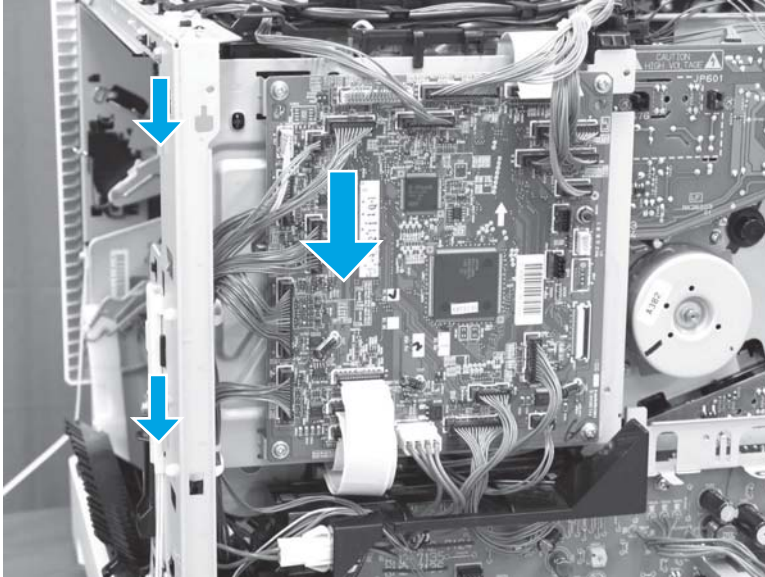

2. Install two screws (callout 1), and then connect all of the connectors.

The following connectors are empty:

- J140, J141, and J143

Figure 1-2726 Install two screws

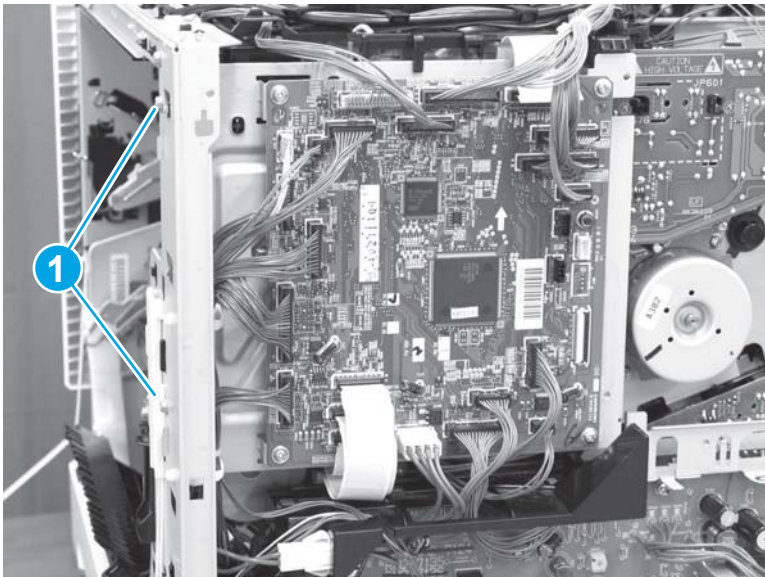

Step 30: Install the right rear cover

1. Position the cover on the printer.

Figure 1-2727 Install the cover

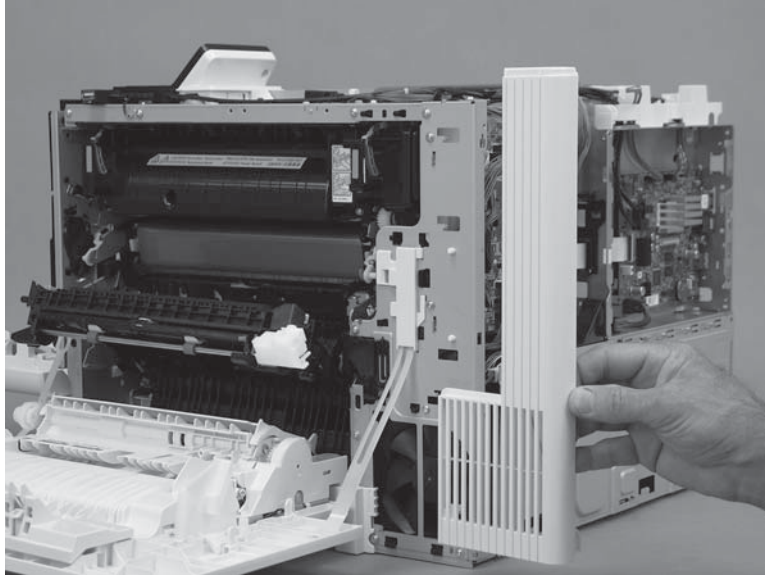

2. Slide the cover toward the right door (callout 1) to engage it with the printer, and then install one screw (callout 2).

Figure 1-2728 Install one screw

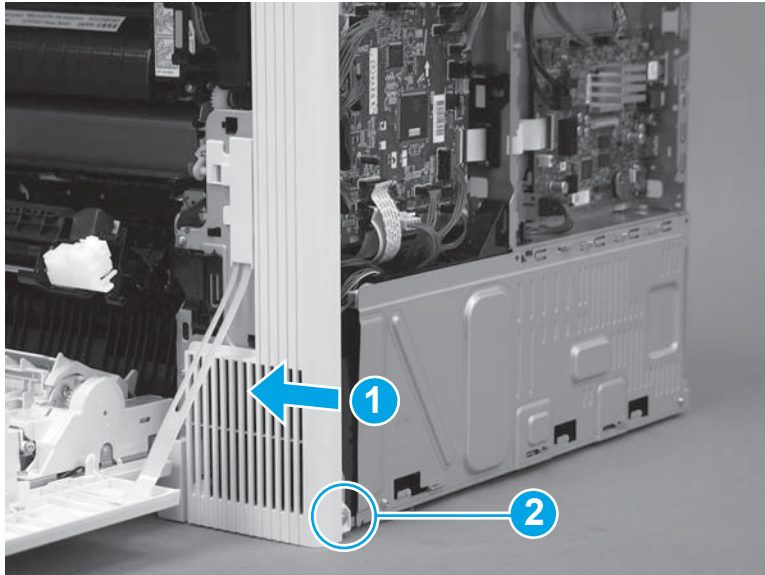

Step 31: Install the formatter case

1. Pass the wire harnesses through the opening in the formatter case.

Figure 1-2729 Pass the wire harness through the opening

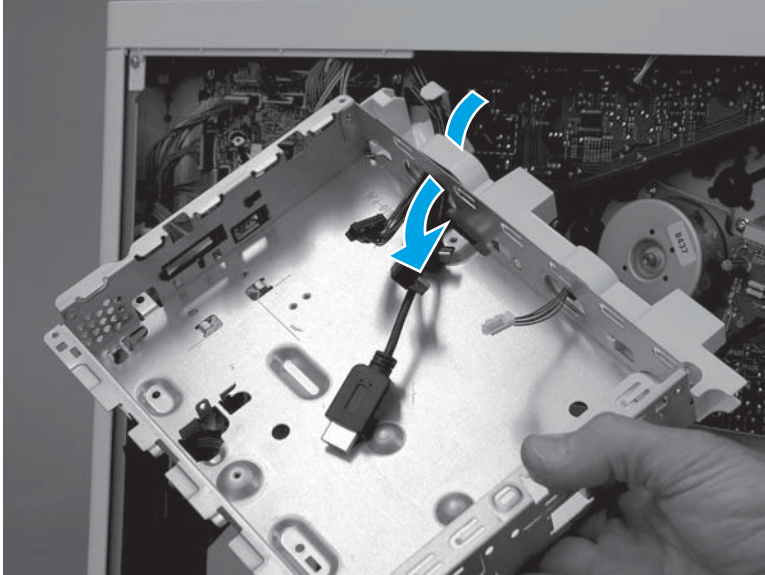

2. Position the top of the formatter case on the printer (callout 1), and then rotate the bottom of the case (callout 2) into the printer.

Figure 1-2730 Install the formatter case

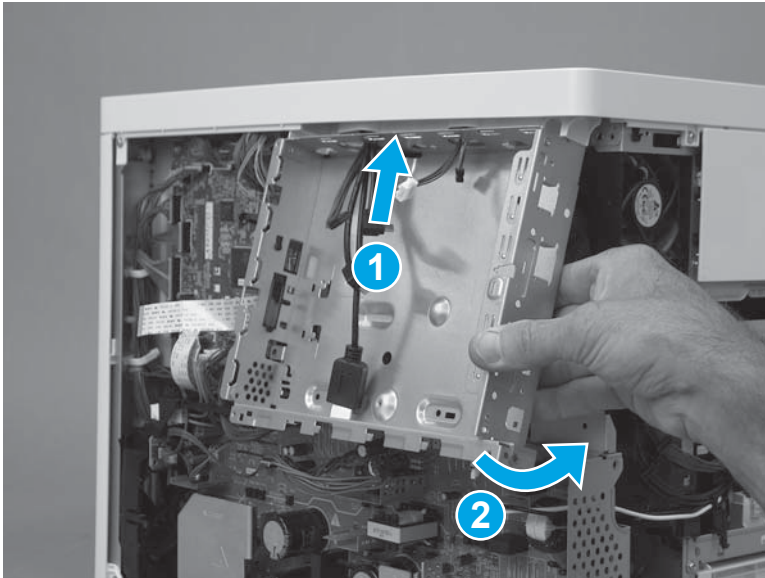

3. Install six screws (callout 1).

Figure 1-2731 Install six screws

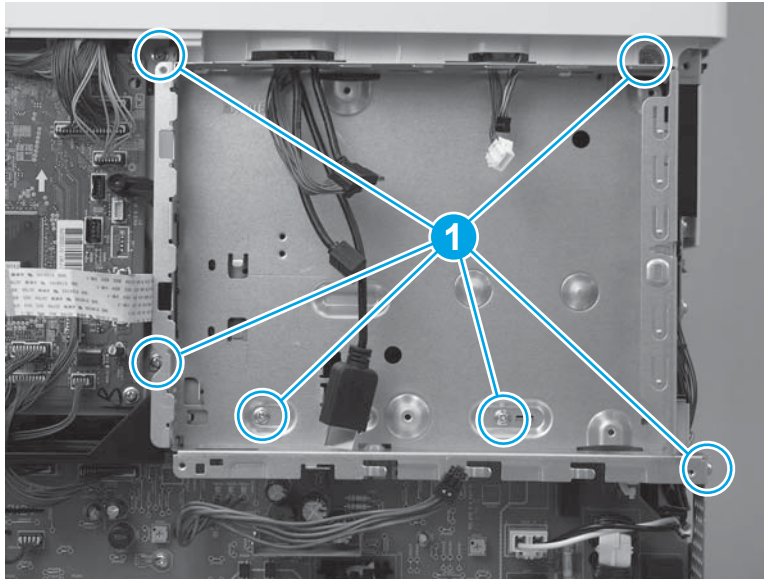

4. Pass two wire harnesses and one flat cable (callout 1) through the opening in the formatter case, and then install one wire harness in the retainer (callout 2).

 **IMPORTANT:** Make sure that the flat cable is securely fastened to the DC controller, and was not dislodged when the formatter case was removed.

Figure 1-2732 Install wire harnesses and flat cable



5. Position the LVPS cover on the printer, slide the cover to the left to install it, and then install two screws (callout 1).

Figure 1-2733 Install the LVPS cover

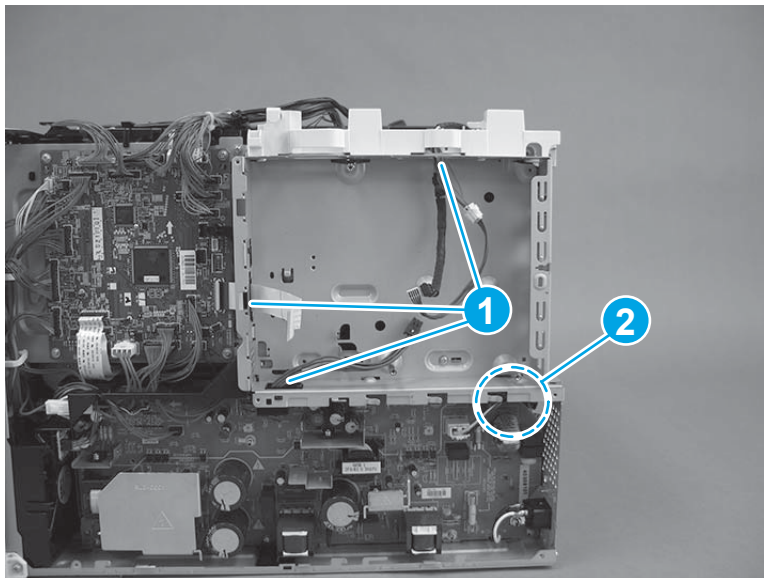
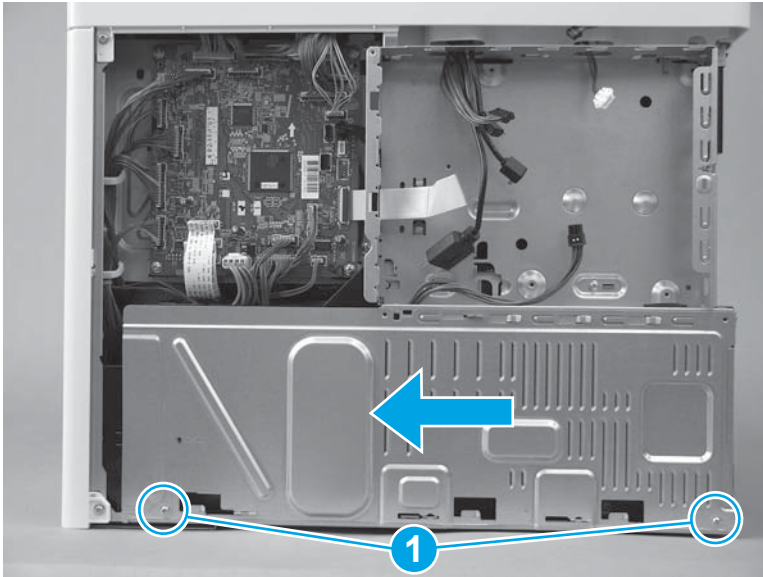

6. If no tape is affixed to the back of the flat cable, skip this step. If double-sided tape is affixed to the back of the flat cable, align the line (callout 1) on the cable with the edge (callout 2) of the opening in the sheet metal. Press to attach the flat cable to the formatter case.

Figure 1-2734 Attach the flat cable

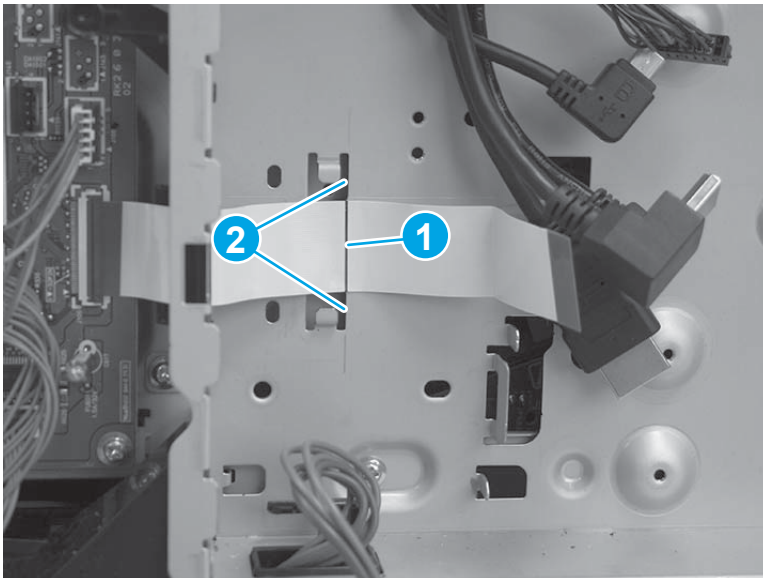

7. Position the bracket over the flat cable, and then slide the bracket to the left to install it. Make sure that the edges of the bracket fit under the sheet metal tabs (callout 1) on the formatter case and that the tabs (callout 2) snap into place.

Figure 1-2735 Position the bracket

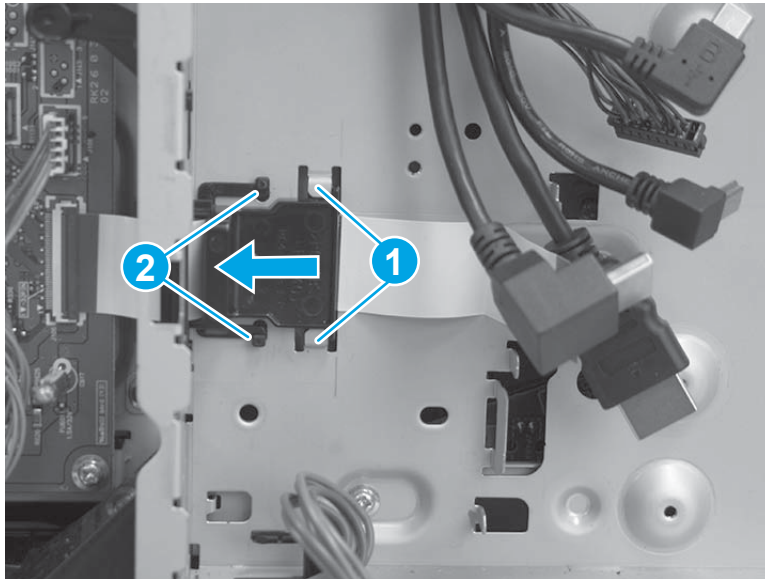

8. **M577 only:** Pass the wire harness (callout 1) through the openings in the formatter case (callout 2), and then connect one connector (callout 3).

Figure 1-2736 Connect one connector

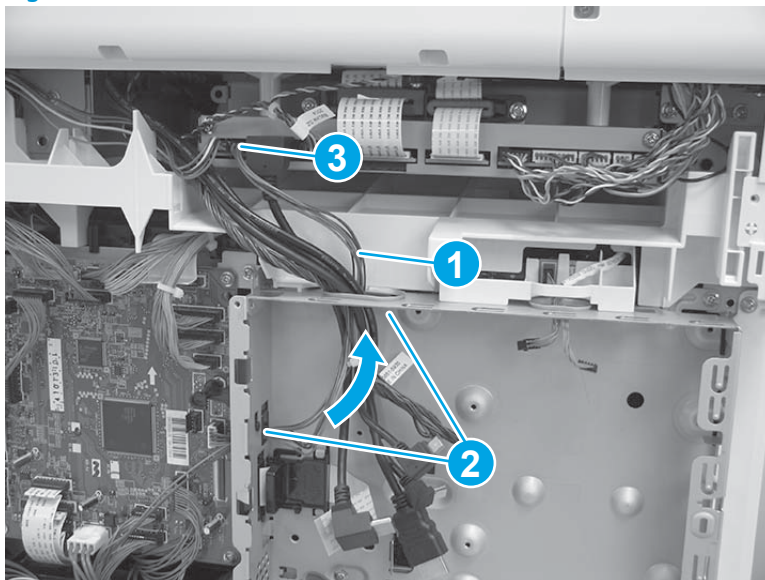

Step 32: Install the upper cover (M552 and M553)

 **NOTE:** This step is for the M552 and M553 models. For the M577 models, skip this step and go to [Step 33: Install the left cover on page 1551](#).

1. Position the cover on the printer.

 **NOTE:** For the M553x model, do not forget to pass the control-panel wire harness and USB cable through the opening in the cover.

Figure 1-2737 Install the cover



2. Push down on the rear corner of the cover to engage one tab (callout 1).

Figure 1-2738 Engage one tab

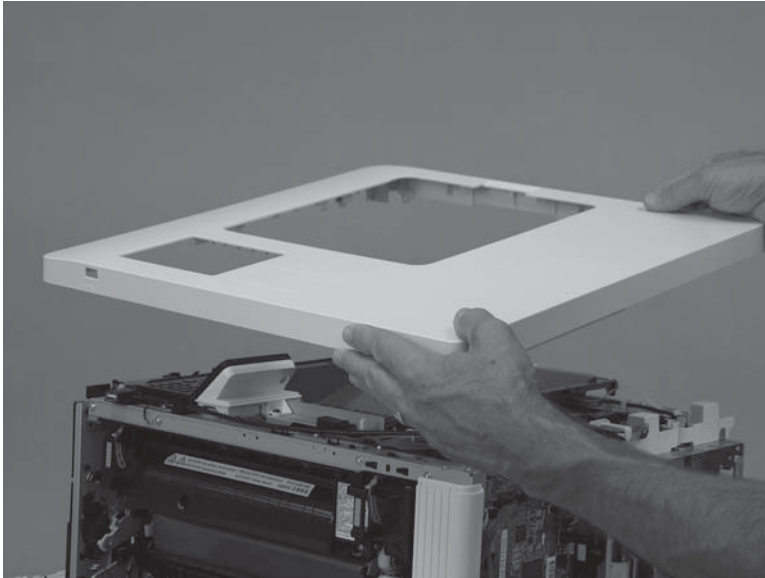
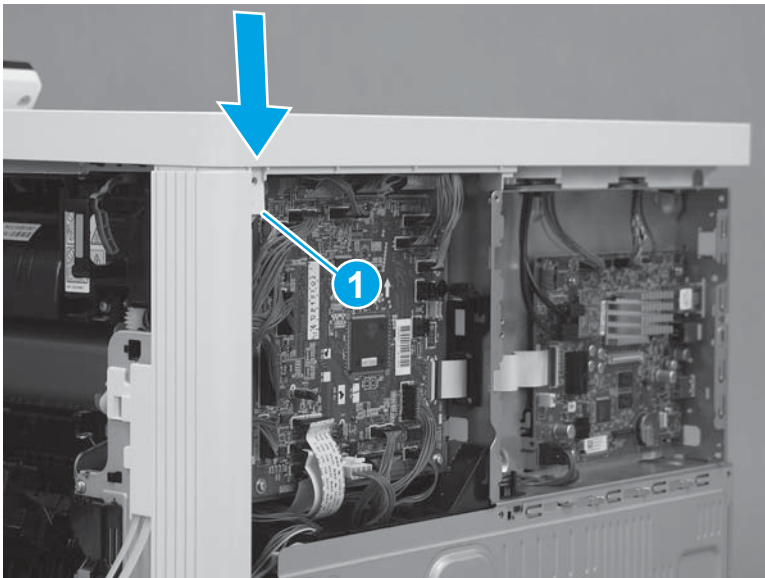

3. Push down on the front corner of the cover to engage one tab (callout 1), and then install one screw (callout 2).

 **NOTE:** This is a self-tapping plastic-thread screw. Make sure that this screw is used in this location when it is reinstalled.

Figure 1-2739 Engage one tab and install one screw



4. Install three screws (callout 1).

Figure 1-2740 Install three screws

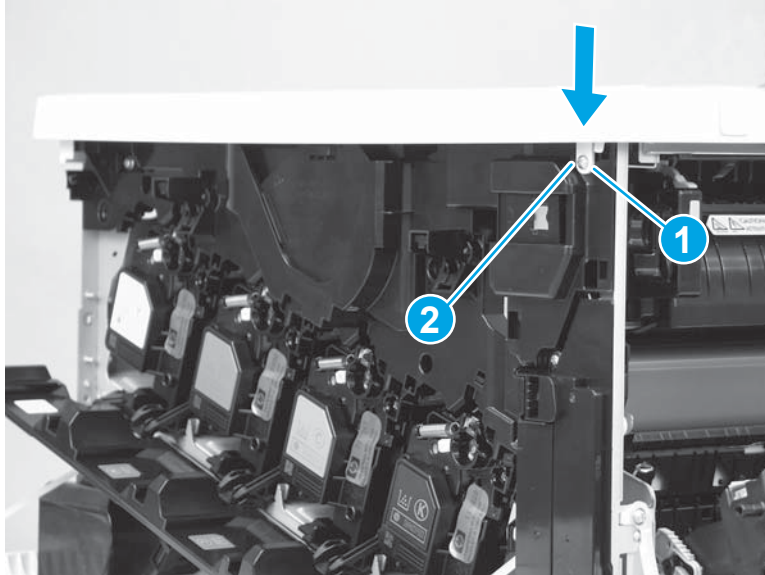
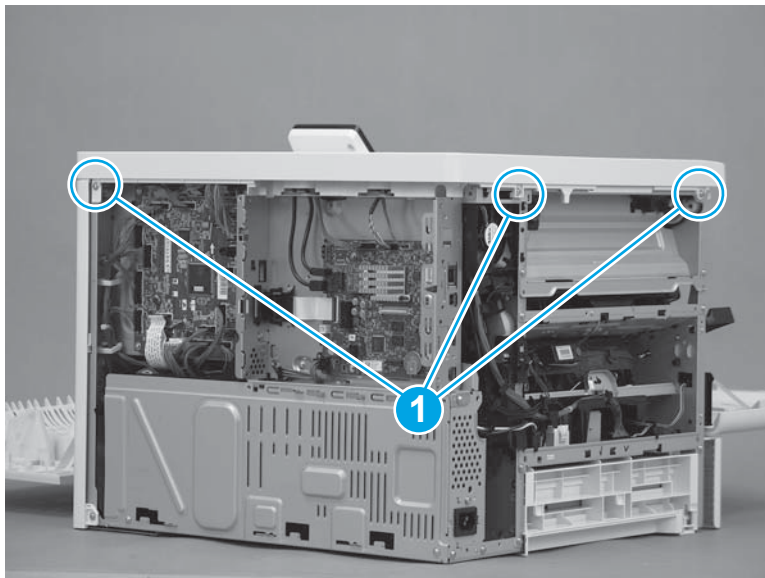

Step 33: Install the left cover

1. Position the cover on the printer.

 **NOTE:** Slightly offset the cover toward the rear of the printer.

Figure 1-2741 Install the cover

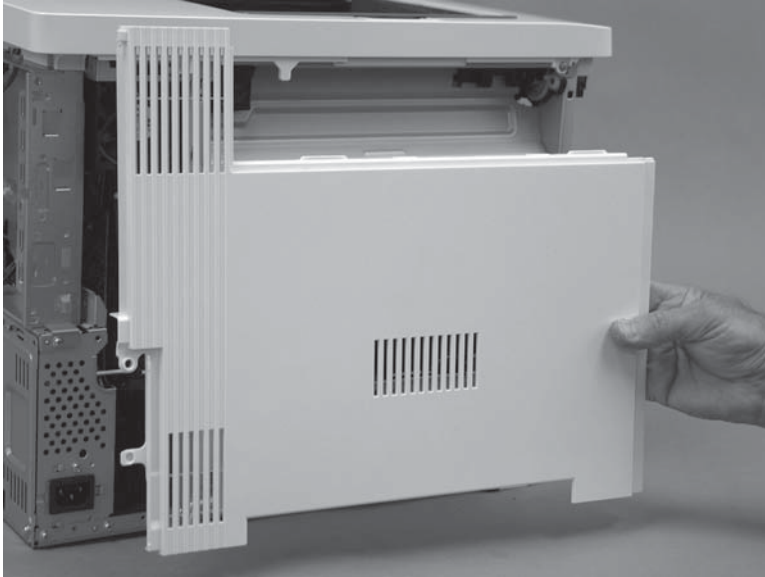

2. Slide the cover (callout 1) toward the front of the printer to engage it. Make sure that the tab (callout 2) snaps into place.

 **NOTE:** Locate the alignment pin (callout 3) on the cover from the front door side of the printer, and then make sure that it is fully engaged in the slot in the chassis.

 **TIP:** While sliding the cover into place, push in on the center of the cover (callout 1) to make sure that the hooks on the back of the cover engage with the slots in the chassis.

Figure 1-2742 Engage the cover



3. At the left side of the printer, install one screw (callout 1).

Figure 1-2743 Install one screw

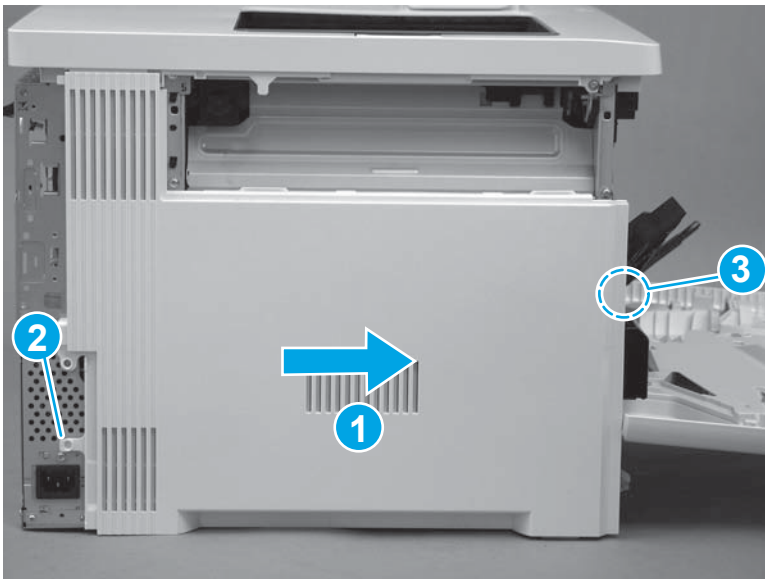

Step 34: Install the top rear cover (M577)

 **NOTE:** This step is for the M577 models. For the M552 and M553 models, skip this step and go to [Step 42: Install the rear cover \(M552 and M553\) on page 1569](#).

1. Align the locator tabs (callout 1) on the cover with the slots (callout 2) in the printer.

Figure 1-2744 Align the locator tabs

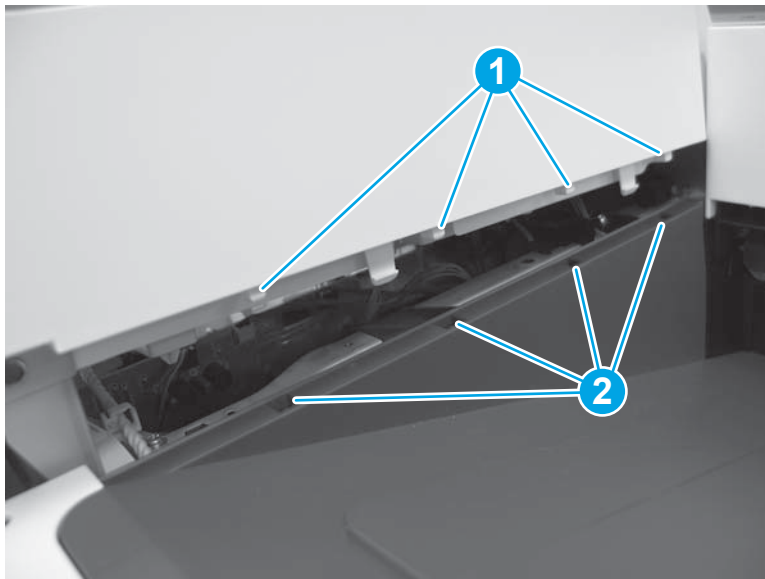

2. Press down to install the cover. Make sure that the tabs snap into place.

Figure 1-2745 Install the cover

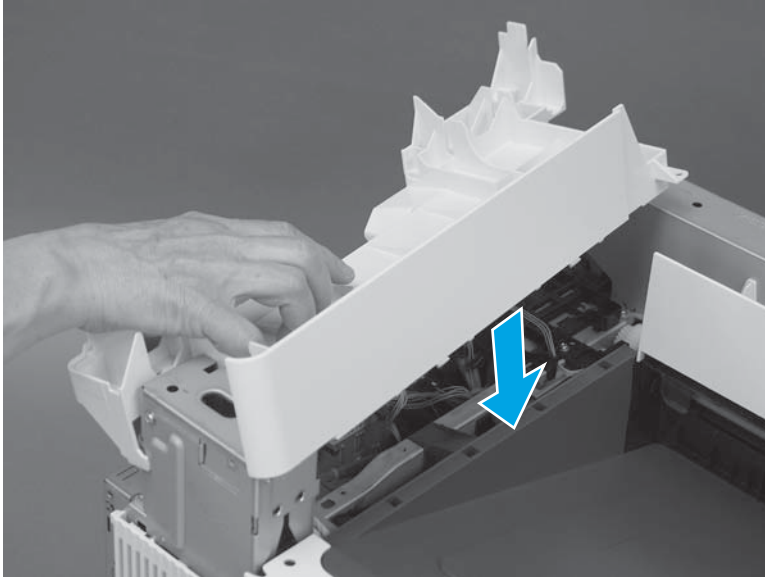

3. At the top of the printer, install five screws (callout 1).

Figure 1-2746 Install five screws

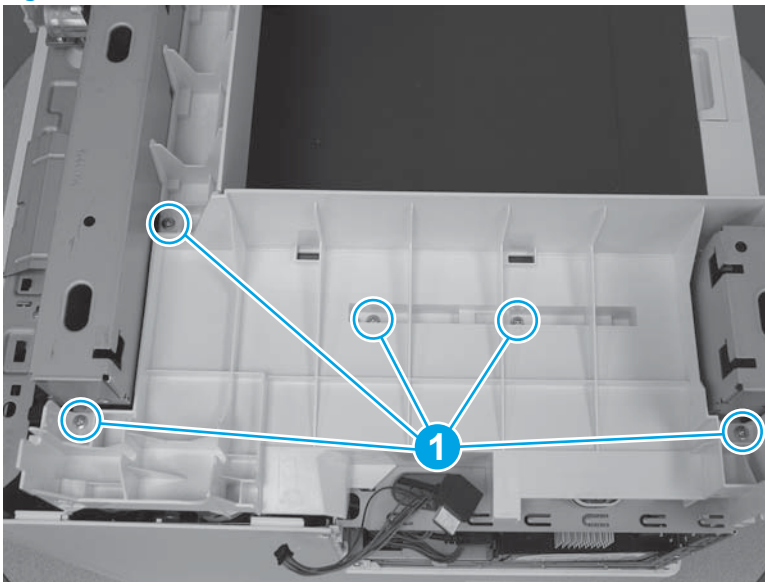

Step 35: Install the right upper cover (M577)



NOTE: This step is for the M577 models. For the M552 and M553 models, skip this step and go to [Step 42: Install the rear cover \(M552 and M553\) on page 1569.](#)



NOTE: The figures below show the image scanner installed. The procedures for removing and installing the right upper cover are the same whether the image scanner is installed or removed."

1. **M577c/f/z only:** Install the cables (callout 1) through the slot (callout 2) in the printer.

Figure 1-2747 Install the cables

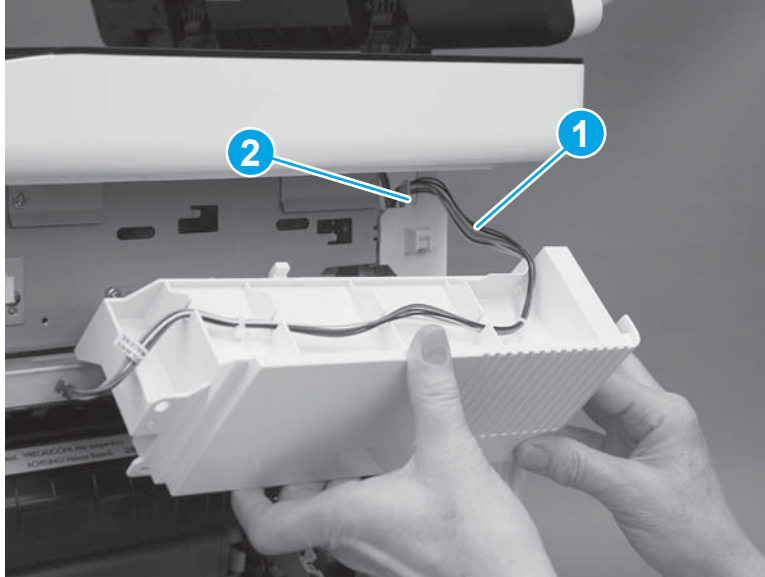

2. Position the hooks (callout 1) on the cover in the slots (callout 2) in the printer.

Figure 1-2748 Position the hooks

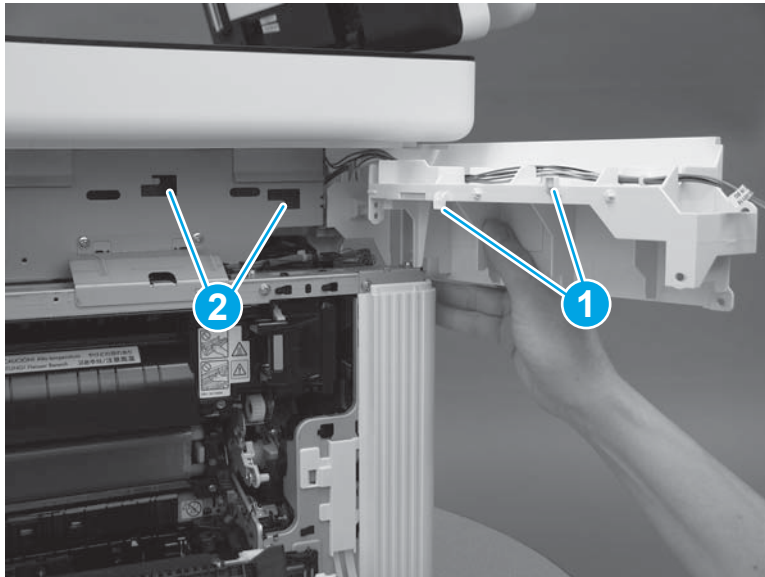

3. Slide the cover toward the front of the printer to install it.

Figure 1-2749 Install the cover

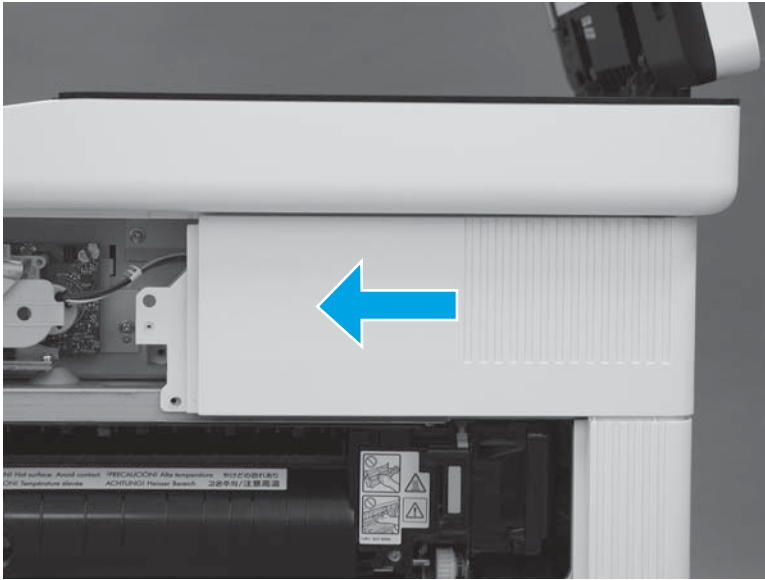

4. At the back of the printer, install one screw (callout 1).

M577c/f/z only: Connect one connector (callout 2), if the integrated scanner assembly is installed.

TIP: This screw is smaller than the screws installed in the next step. Make sure that this screw is installed in the correct position.

Figure 1-2750 Install one screw and connector

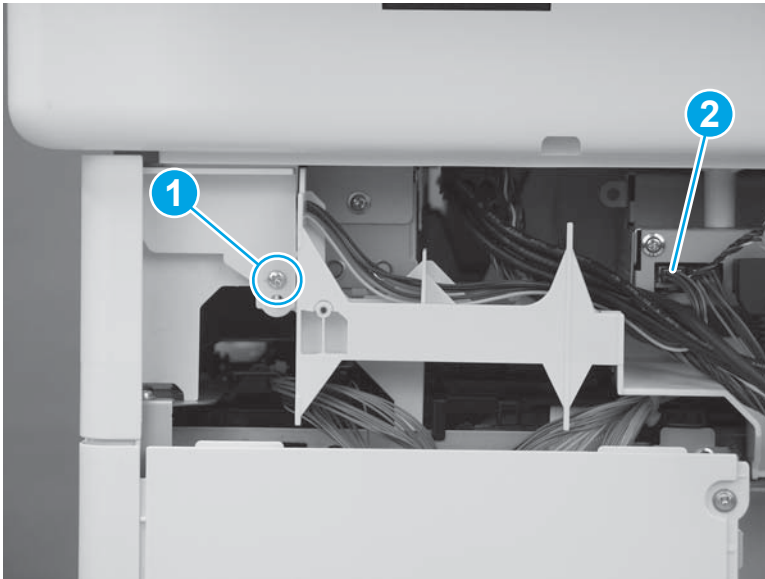

5. At the right side of the printer, install two screws (callout 1).

M577c/f/z only: Connect one connector (callout 2), if the stapler is installed.

Figure 1-2751 Install one screw and connector

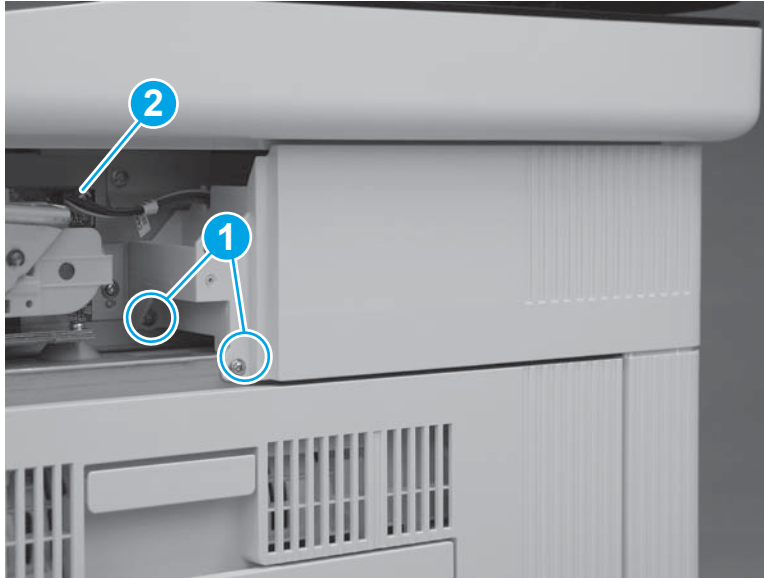

Step 36: Install the integrated scanner assembly (ISA) (M577)

 **NOTE:** This step is for the M577 models. For the M552 and M553 models, skip this step and go to [Step 42: Install the rear cover \(M552 and M553\) on page 1569.](#)

 **NOTE:** The ISA includes the document feeder, image scanner, scanner control board (SCB), control panel, keyboard (M577c/z) and NFC PCA (M577z).

1. Before proceeding, locate the mounting pins (callout 1) on the bottom of the ISA and the slots (callout 2) on the printer base.

Figure 1-2752 Locate the ISA mounting pins and slots

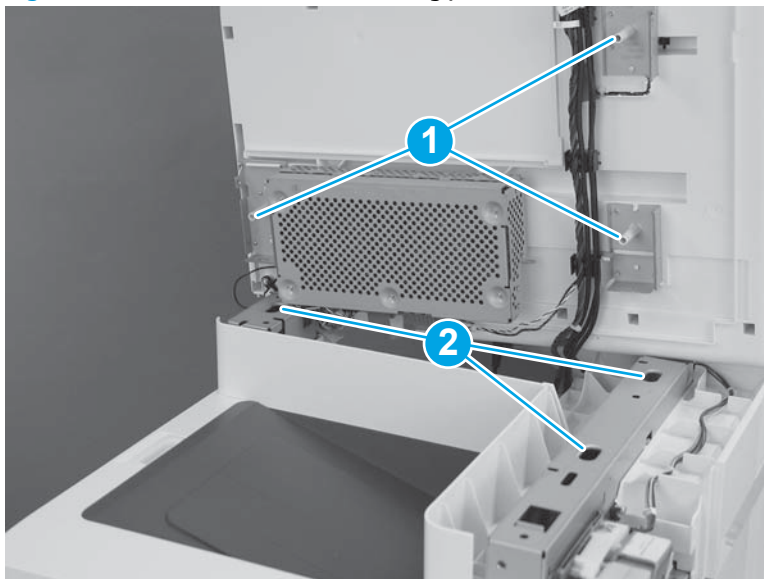

2. Position the ISA on the printer base with the pins in the slots.

 **NOTE:** To locate the pins and slots, see [Figure 1-395 Locate the ISA mounting pins and slots on page 250](#).

When installing the ISA, carefully pass the cables through the opening in the top of the formatter case.

Figure 1-2753 Install the ISA

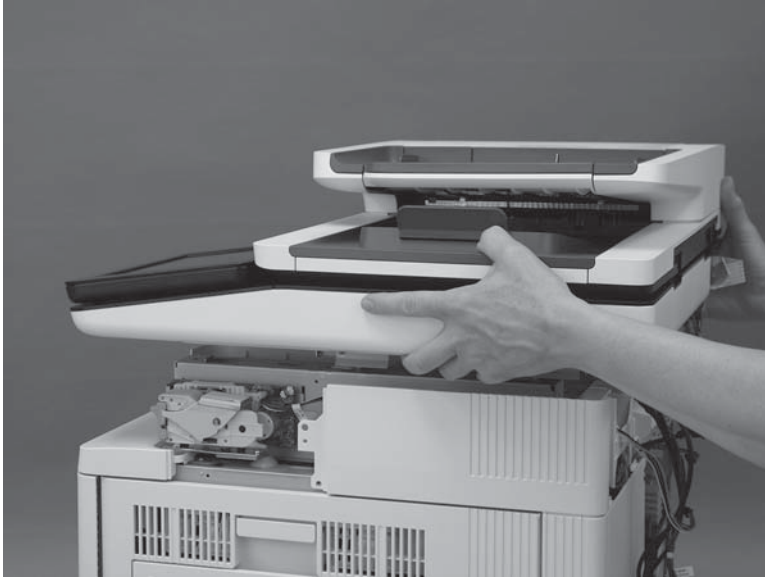

3. Slightly slide the ISA towards the front of the printer to engage it.

Figure 1-2754 Slide the ISA towards the front of the printer

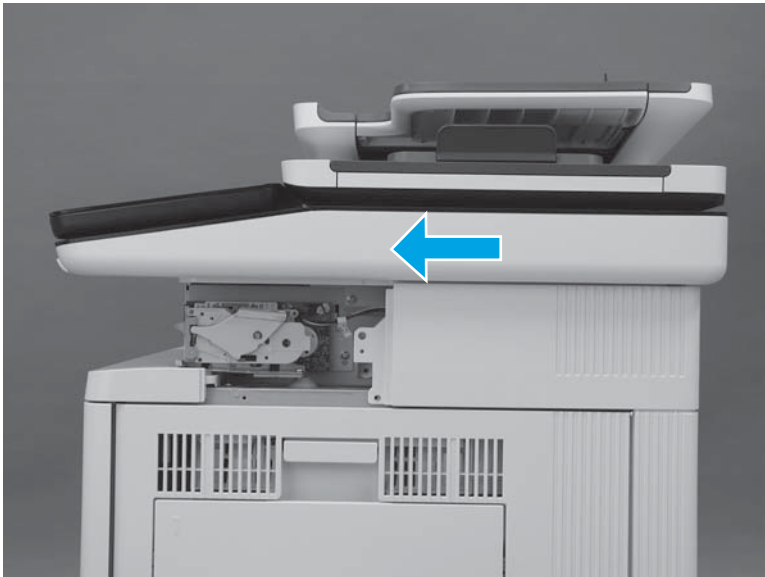

4. At the left side of the printer, install one screw (callout 1).

Figure 1-2755 Install one screw

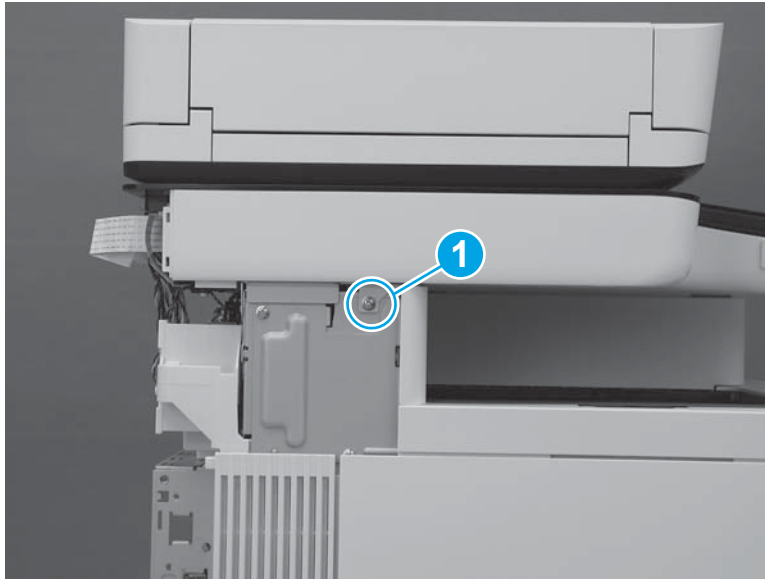

5. At the back of the printer, install two screws (callout 1).

Figure 1-2756 Install two screws

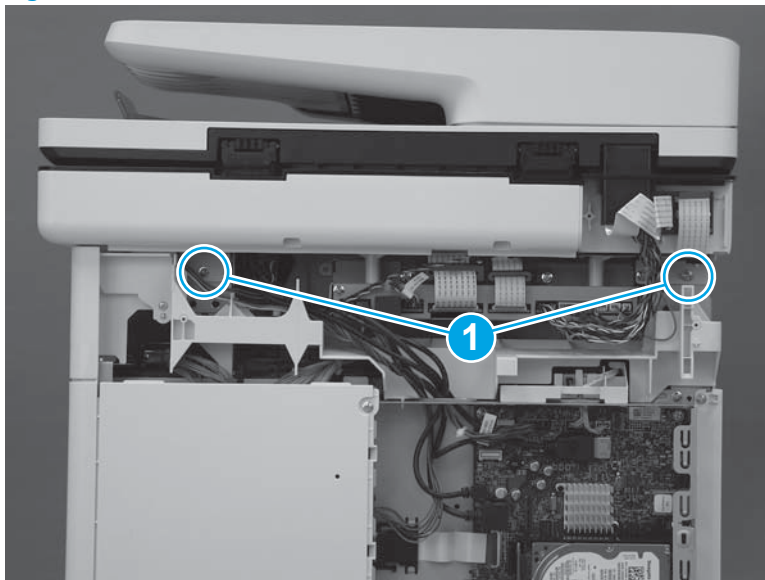

6. At the right side of the printer, install one screw (callout 1).

Figure 1-2757 Install one screw

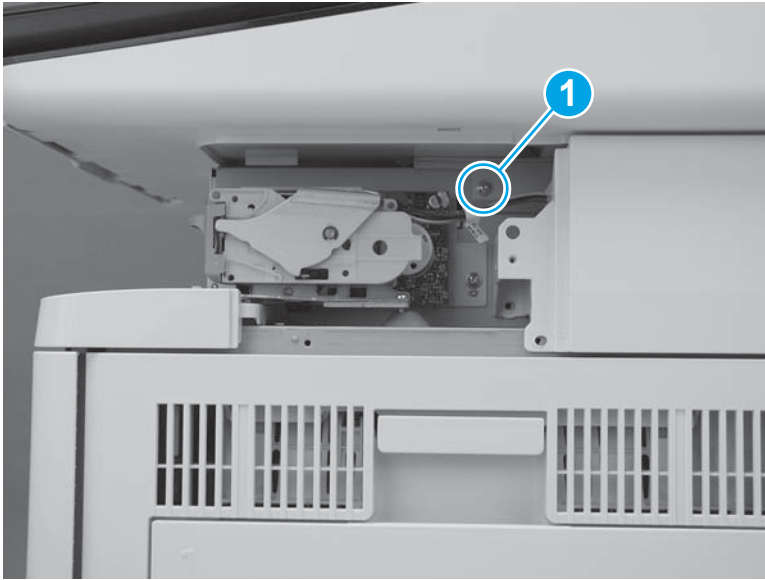

7. Connect two connectors on the scanner control board (callout 1).

M577c/f/z only: Connect one connector for the stapler on the scanner control board (callout 2).

Figure 1-2758 Connect connectors

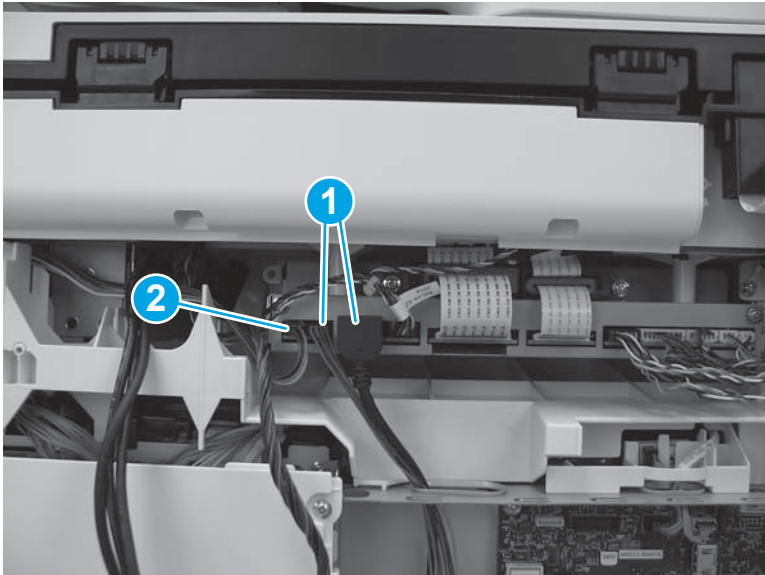

Step 37: Install the stapler cover assembly (M577c/f/z)

 **NOTE:** This step is for the M577c/f/z models only. For the M577dn model, skip this step and go to [Step 38: Install the right front upper cover \(M577dn\) on page 1562](#).

For the M552 and M553 models, skip this step and go to [Step 42: Install the rear cover \(M552 and M553\) on page 1569](#).

1. Install the tabs (callout 1) on the cover in the slots (callout 2) in the printer.

Figure 1-2759 Install two tabs



2. Press the cover toward the left side of the printer until it snaps into place.

Figure 1-2760 Install the cover assembly



3. Install one screw (callout 1).



 **IMPORTANT:** This is a self-tapping screw for plastic. Rotate it counterclockwise to align it with the existing thread pattern, and then carefully turn it clockwise to tighten. Do not overtighten. This will prevent stripping the threads inside the screw hole.

Figure 1-2761 Install one screw

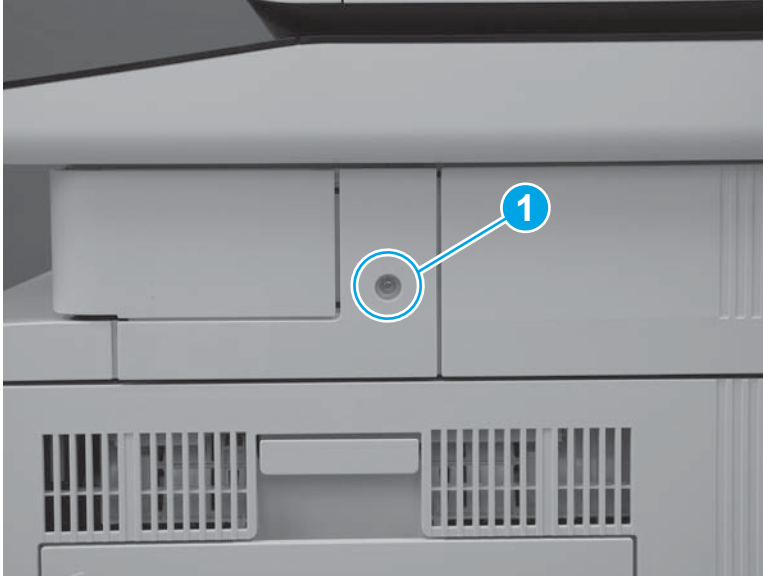

Step 38: Install the right front upper cover (M577dn)

 **NOTE:** This step is for the M577dn model only. For the M577c/f/z models, skip this step and go to [Step 39: Install the left upper cover \(M577\) on page 1564](#).

For the M552 and M553 models, skip this step and go to [Step 42: Install the rear cover \(M552 and M553\) on page 1569](#).

1. Slide the cover toward the left side of the printer to install it. Make sure that the slots (callout 1) in the cover fit over the tabs (callout 2) on the inside of the paper feeder cover.

Figure 1-2762 Install the cover



2. Press the right front upper cover (callout 1) and the paper feeder cover (callout 2) together until the tabs on the inside of the covers snap into place.

Figure 1-2763 Press the cover



3. Install one screw (callout 1).

Figure 1-2764 Install one screw

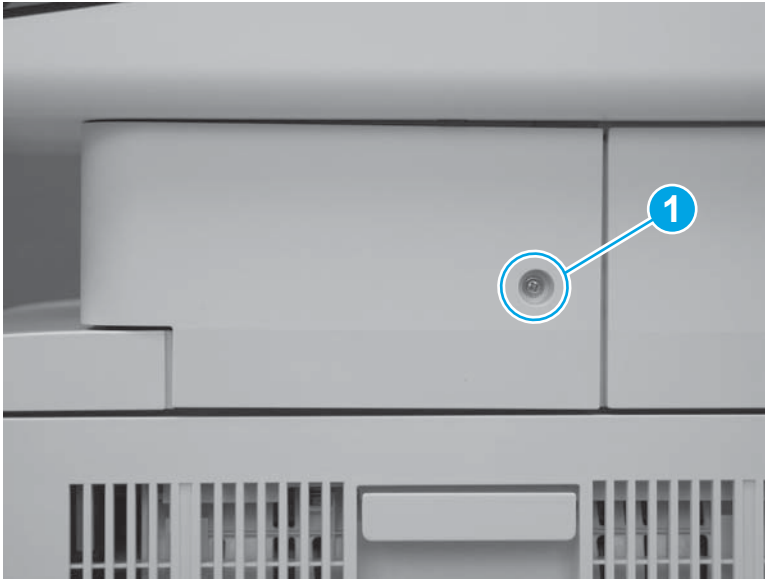

Step 39: Install the left upper cover (M577)



NOTE: This step is for the M577 models. For the M552 and M553 models, skip this step and go to [Step 42: Install the rear cover \(M552 and M553\) on page 1569](#).

1. Position the tab (callout 1) on the lower edge of the cover behind the left cover (callout 2).

Figure 1-2765 Position the tab

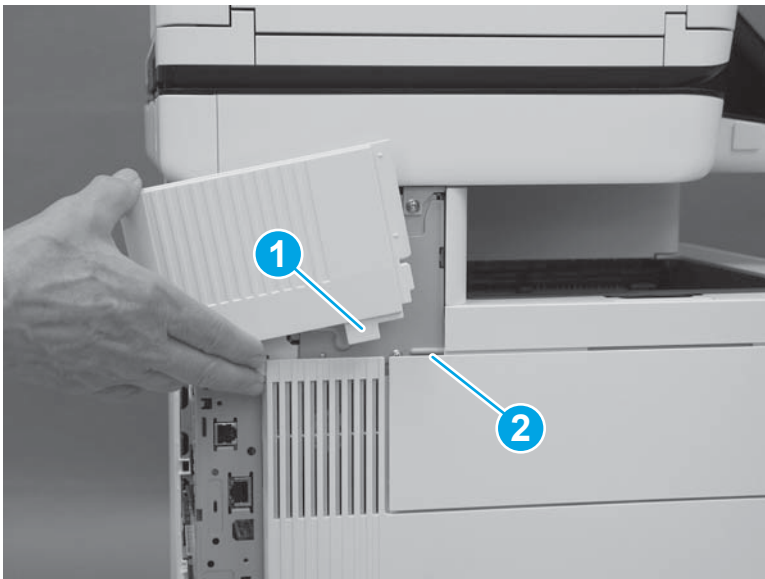

2. Slide the cover toward the front of the printer to install it. Make sure that the edge (callout 1) of the cover fits behind the edge (callout 2) of the top rear cover.

Figure 1-2766 Slide the cover

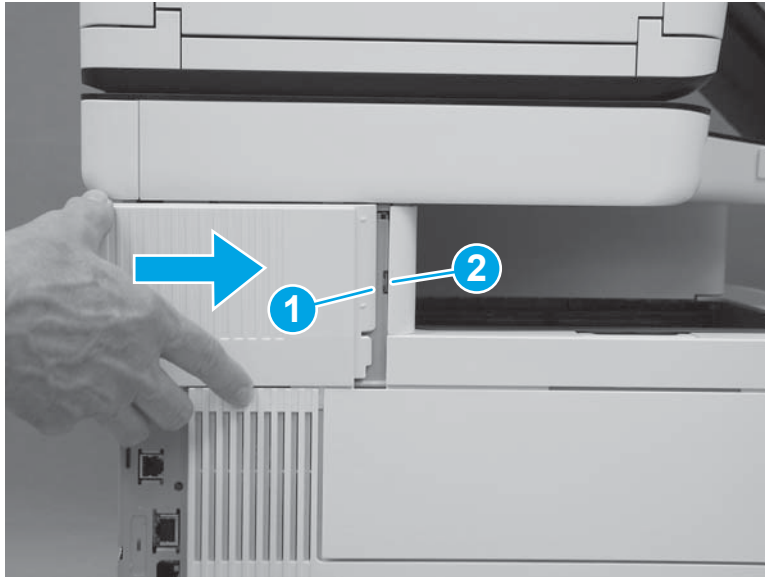

3. Make sure that the tab (callout 1) is fully installed.

Figure 1-2767 Check the tab

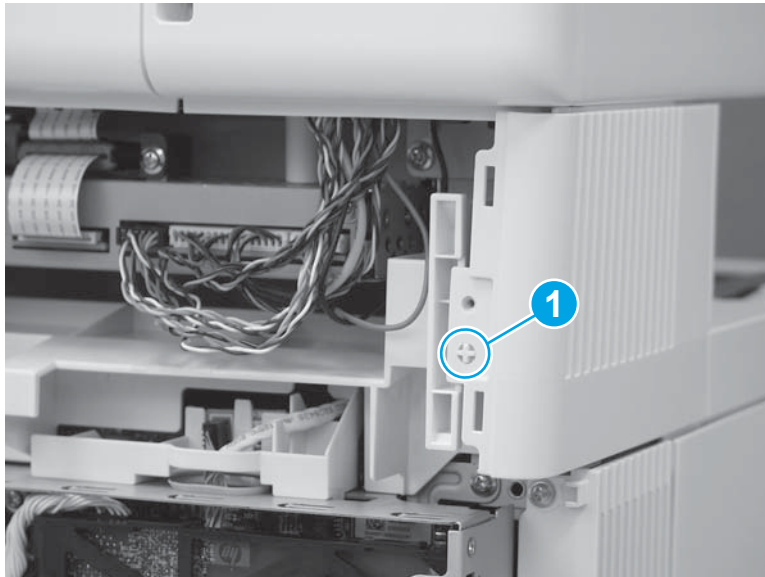

Step 40: Install the rear cover (M577)

 **NOTE:** This step is for the M577 models. For the M552 and M553 models, skip this step and go to [Step 42: Install the rear cover \(M552 and M553\) on page 1569](#).

1. Position the hooks (callout 1) on the cover in the slots (callout 2) in the printer.

Figure 1-2768 Position the hooks

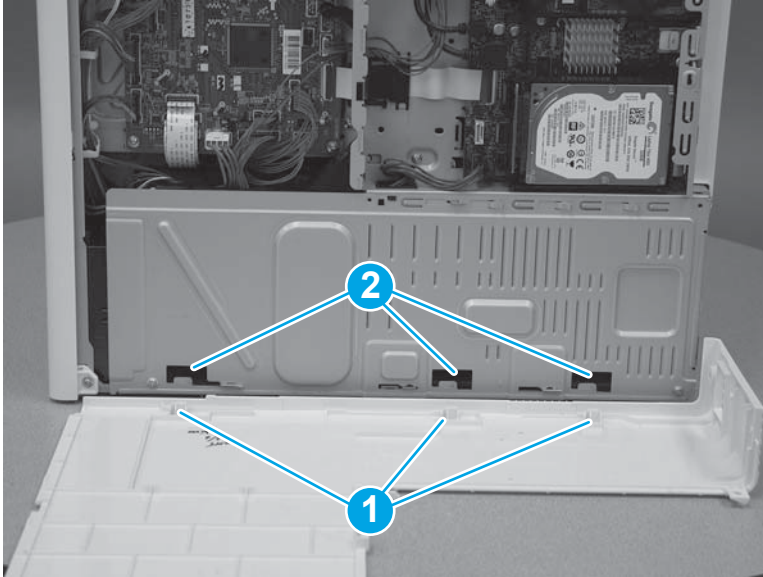

2. Position the back edge (callout 1) of the rear cover behind the edge (callout 2) of the right rear cover. Slide the cover to the left to install it.

Figure 1-2769 Install the cover

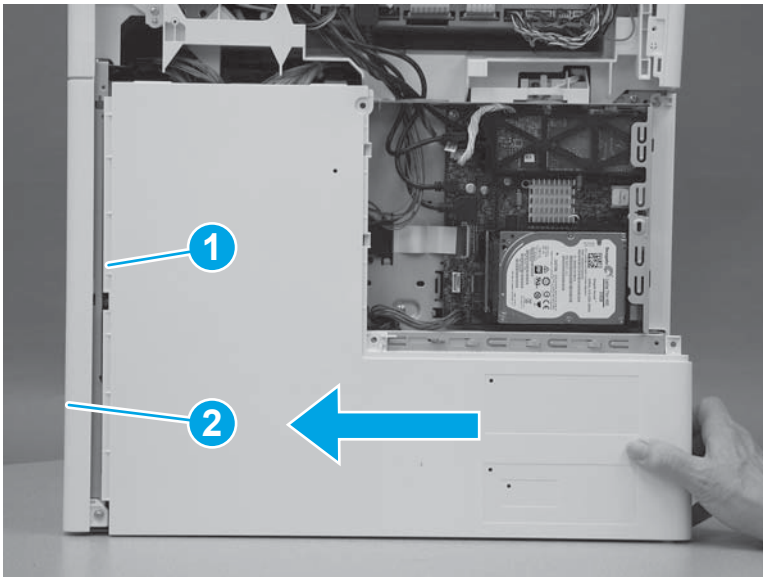

3. Install four screws (callout 1).

Figure 1-2770 Install four screws cover

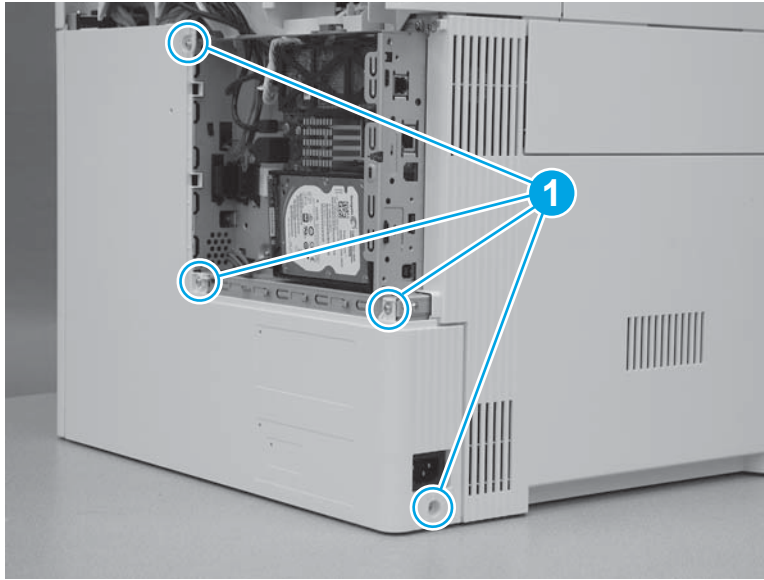

Step 41: Install the rear upper cover (M577)

 **NOTE:** This step is for the M577 models. For the M552 and M553 models, skip this step and go to [Step 42: Install the rear cover \(M552 and M553\) on page 1569](#).

1. Align the ridge (callout 1) on the lower edge of the rear upper cover in front of the tabs (callout 2) on the top edge of the rear cover.

Figure 1-2771 Align the cover

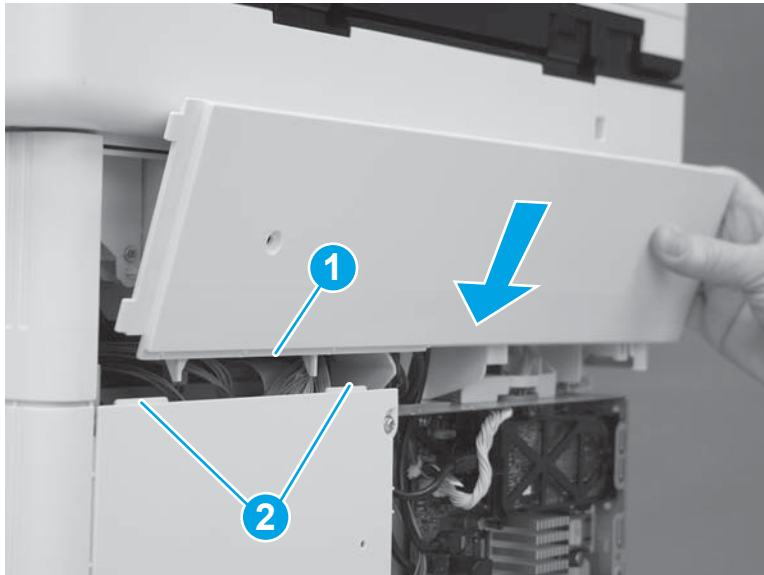

2. Rotate the top of the cover toward the printer.

Figure 1-2772 Rotate the top of the cover

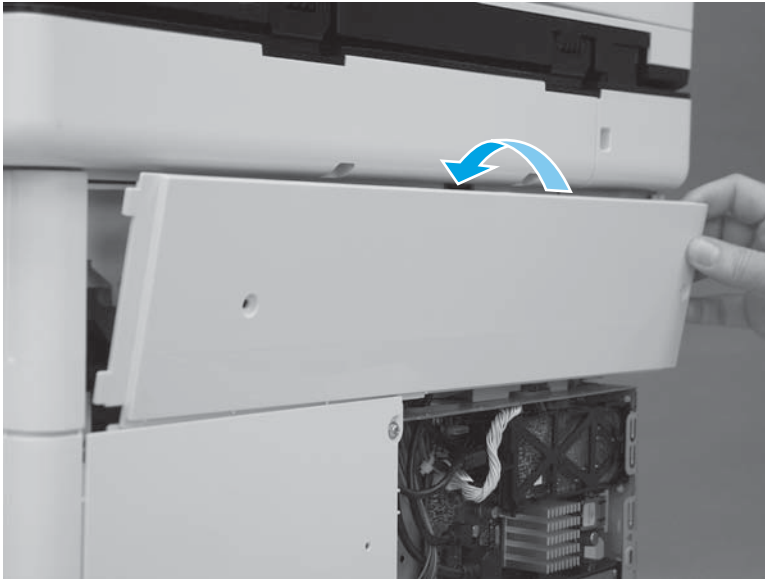

3. Slide the cover to the left (callout 1). Make sure that the tabs (callout 2) on the upper rear cover slide behind the edge (callout 3) of the right upper cover. Make sure that the cover is fully seated.

Figure 1-2773 Slide the cover

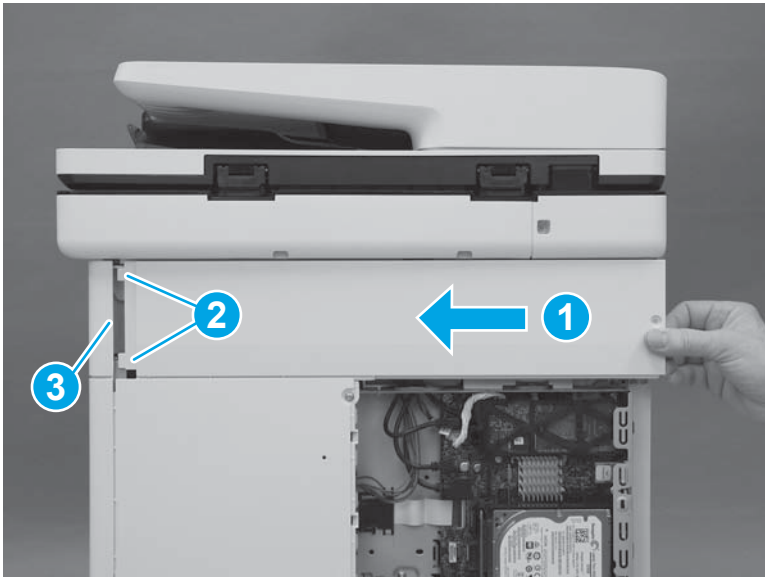

4. Install two screws (callout 1).

 **IMPORTANT:** These two screws are self-tapping screws for plastic. Rotate them counterclockwise to align them with the existing thread pattern, and then carefully turn them clockwise to tighten. Do not overtighten. This will prevent stripping the threads inside the screw holes.

Figure 1-2774 Install two screws



Step 42: Install the rear cover (M552 and M553)

 **NOTE:** This step is for the M552 and M553 models. For the M577 models, skip this step and go to [Step 43: Install the formatter \(M577\) on page 1570](#).

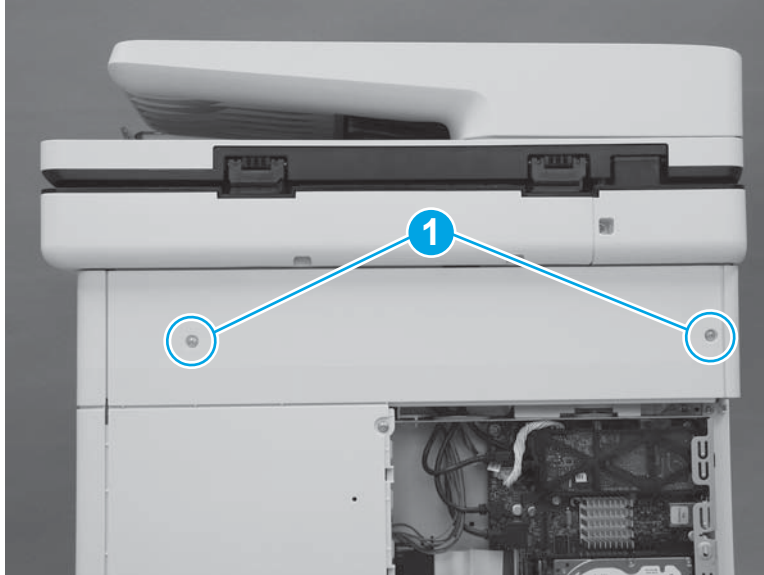
1. Position the top of the cover under the upper cover (callout 1), rotate the bottom of the cover onto the chassis (callout 2), and then slide the cover to the left (callout 3) to install it.

Figure 1-2775 Install the cover

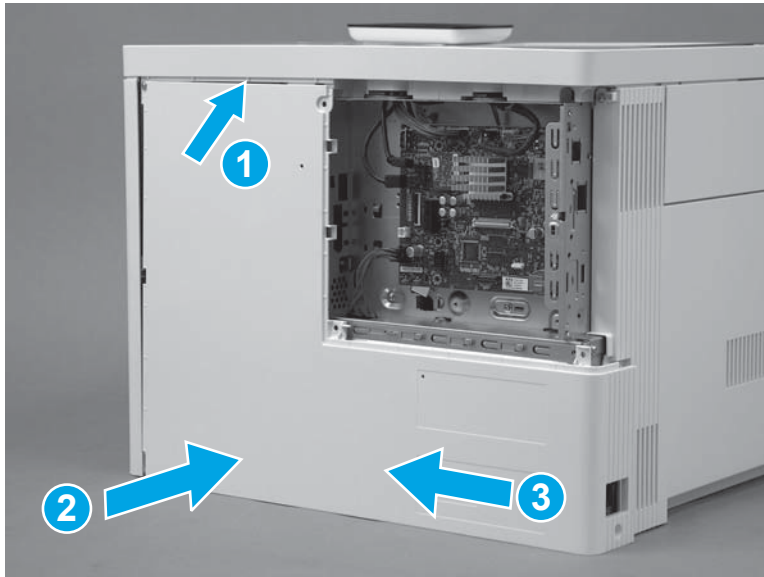

2. Install four screws (callout 1).

Figure 1-2776 Install four screws cover

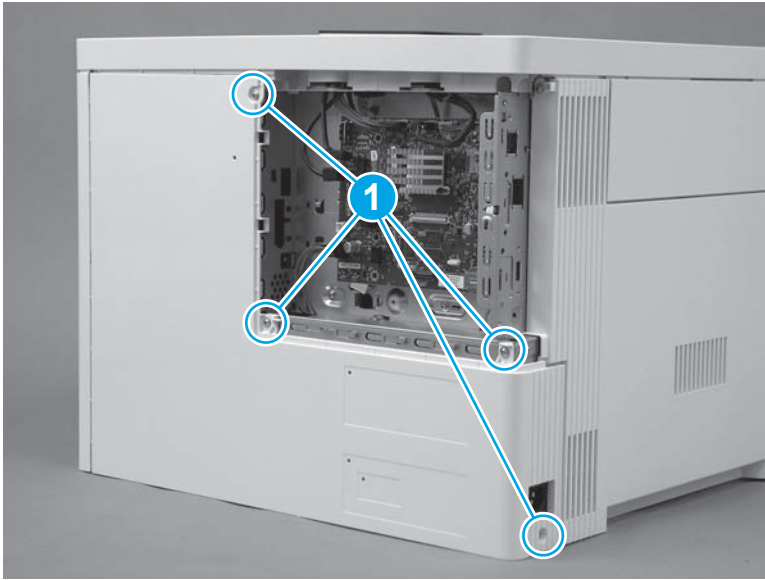

Step 43: Install the formatter (M577)



NOTE: This step is for the M577 models. For the M552 and M553 models, skip this step and to go [Step 46: Install the formatter \(M552 and M553\) on page 1575](#).



CAUTION:  ESD-sensitive part.

1. Position the formatter in the printer. Make sure that the network port (callout 1) fits through the opening (callout 2) in the formatter case.

Figure 1-2777 Install the formatter

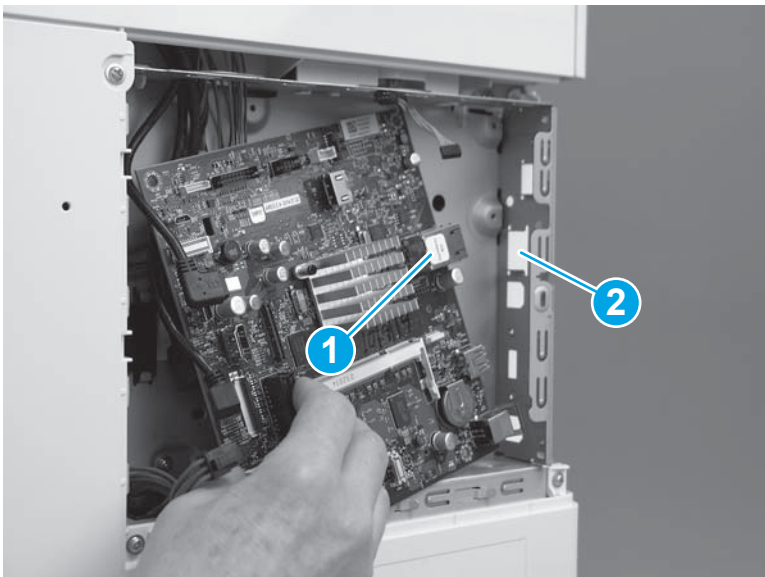

2. Install four screws (callout 1).

Figure 1-2778 Install four screws

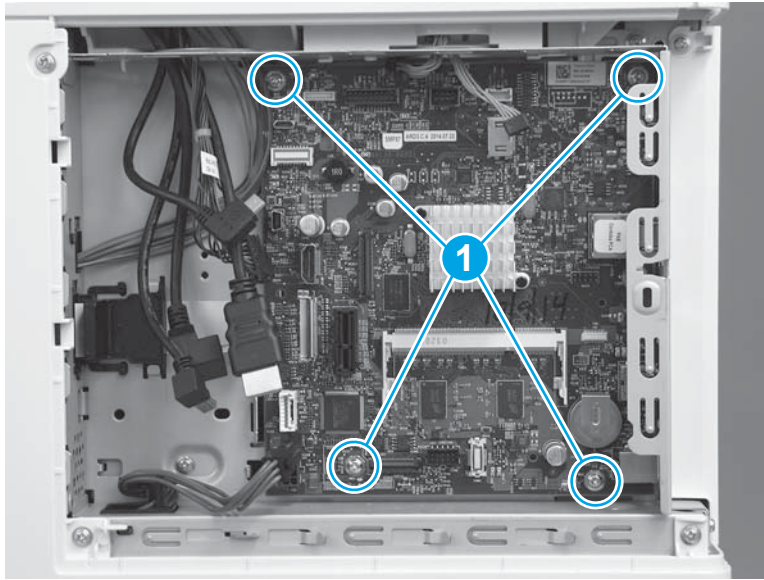

3. Connect all of the connectors on the formatter.

The following connectors are empty:

- All models: J1 (this connector is empty unless the optional DIMM is installed)
- All models: J3
- M577dn: J15 (this is the fax connector for the M577f/z/c models)
- All models: J21 (this connector is empty unless the optional internal USB ports component is installed)
- All models: J23
- All models: J24
- All models: J51
- All models: J57
- All models: J97
- All models: J98 (this connector is empty unless the optional trusted platform module (TPM) is installed)

 **IMPORTANT:** The flat-cable connector (callout 1) is a Zero Insertion Force (ZIF) connector that uses a hinged retainer to secure the flat cable. The hinged retainer must be opened to install the flat cable, and then closed after the cable is installed.

Figure 1-2779 Connect all connectors



Step 44: Install the fax PCA (M577c/f/z)

 **NOTE:** This step is for the M577c/f/z models. For the M577n model, skip this step and go to [Step 45: Install the HDD \(M577\) on page 1573](#).

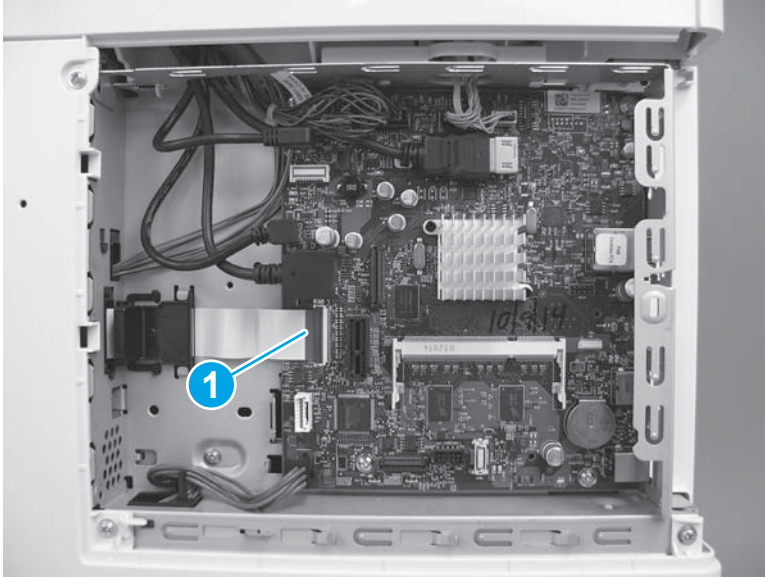
For the M552 and M553 models, skip this step and go to [Step 46: Install the formatter \(M552 and M553\) on page 1575](#).

 **CAUTION:**  ESD-sensitive part.

1. Position the tab and telephone port (callout 1) on the fax PCA in the slots (callout 2) in the formatter case.

Figure 1-2780 Position the fax PCA

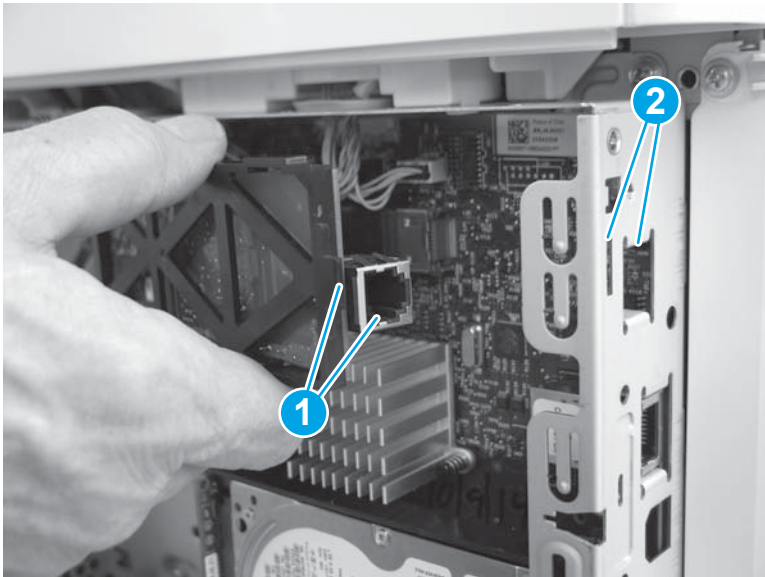

2. Slide the fax PCA to the right (callout 1) until the tab and telephone port described in the previous step and seated in the formatter case. Position the retainer (callout 2) in the slot (callout 3) in the formatter. Rotate the end of the fax PCA toward the formatter (callout 4) until the retainer snaps into place.

Figure 1-2781 Install the fax PCA

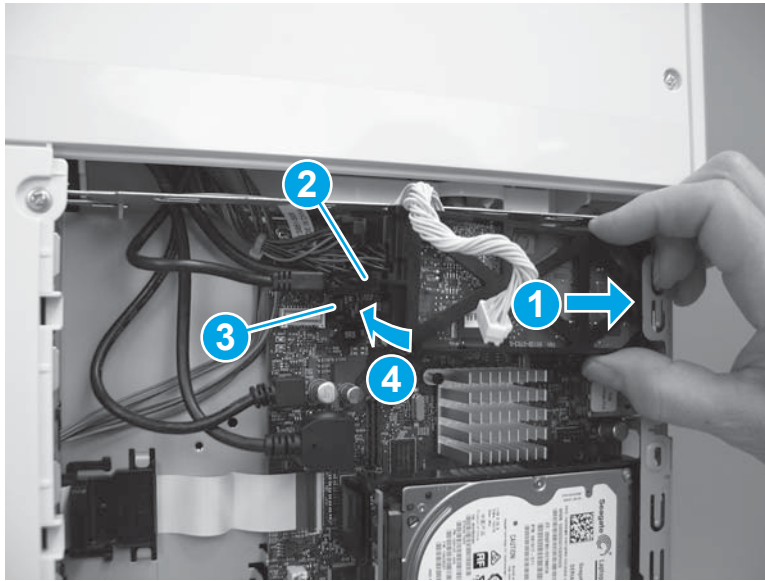

3. Position the cable (callout 1) in the guide (callout 2), and then connect one connector (callout 3).

Figure 1-2782 Connect the connector

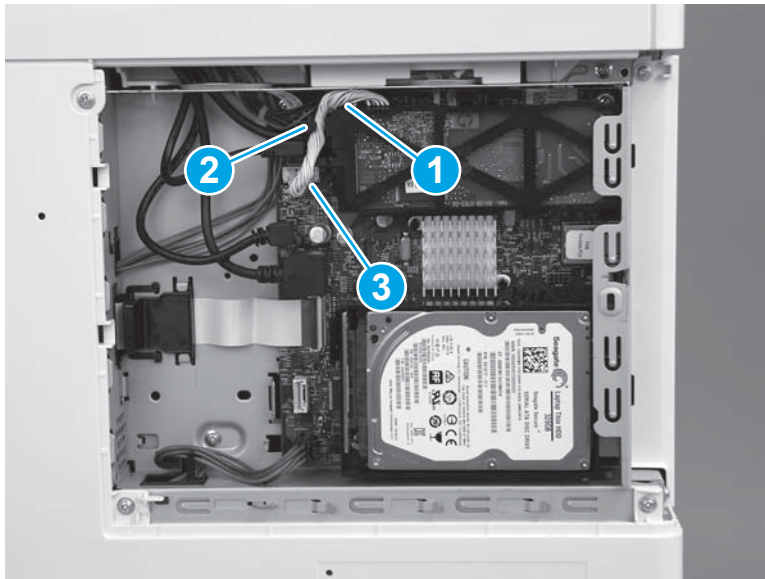

Step 45: Install the HDD (M577)

 **NOTE:** This step is for the M577 models. For the M552 and M553 models, skip this step and go to [Step 46: Install the formatter \(M552 and M553\) on page 1575.](#)

 **CAUTION:**  ESD-sensitive part.

1. Align the end of the bracket (callout 1) with the slot in the chassis (callout 2), and then slide the HDD into the printer (callout 3) to engage the bracket with the chassis.

Figure 1-2783 Install the holder

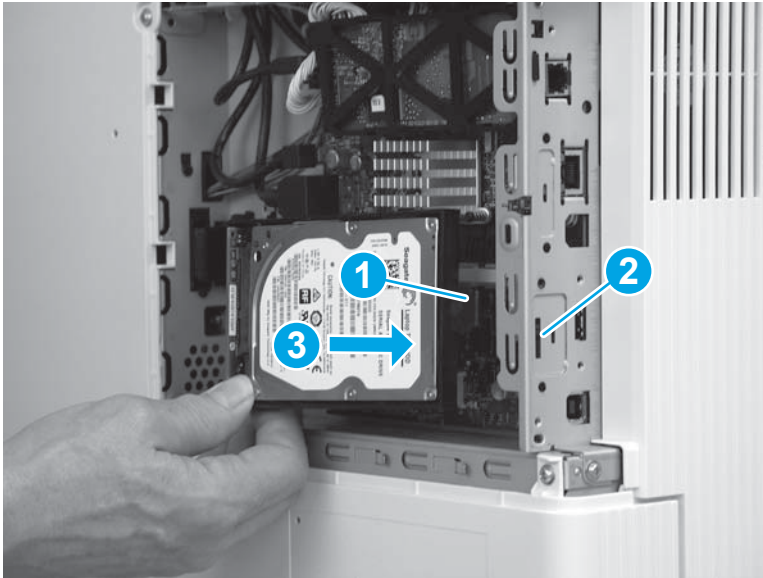

2. Hold the HDD connector latch (callout 1) in the released position, and then rotate the HDD down and into the connector on the formatter to install it.

 **NOTE:** Make sure that the tab (callout 2) snaps into place, and that the HDD is securely installed.

Figure 1-2784 Release the HDD

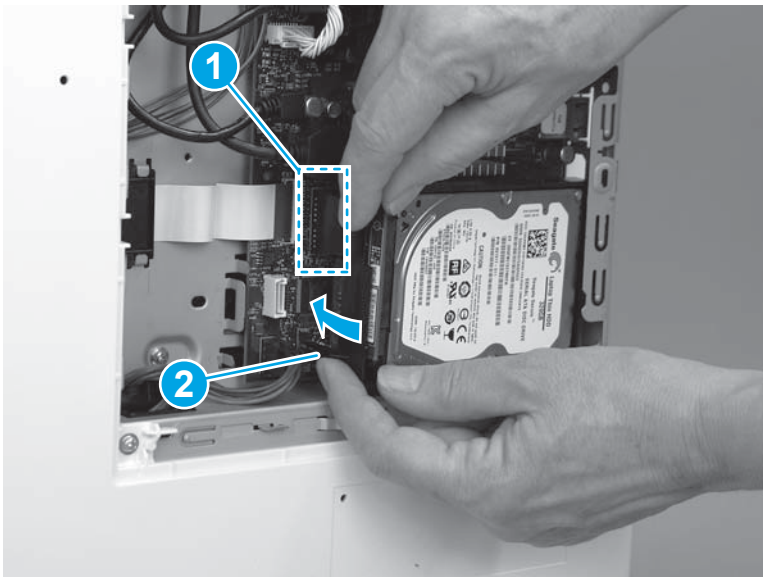

Step 46: Install the formatter (M552 and M553)

 **NOTE:** This step is for the M552 and M553 models. For the M577 models, skip this step and go to [Step 47: Install the formatter cover on page 1576](#).

If the optional hard-disk drive (HDD) was removed, do not forget to reinstall it after the formatter is reinstalled.

Engage the HDD holder with the chassis, rotate the HDD connector down and into the connector on the formatter. Make sure that the tabs snap into place.

 **CAUTION:**  ESD-sensitive part.

1. Position the formatter in the printer, and then install four screws (callout 1).

Figure 1-2785 Install the formatter

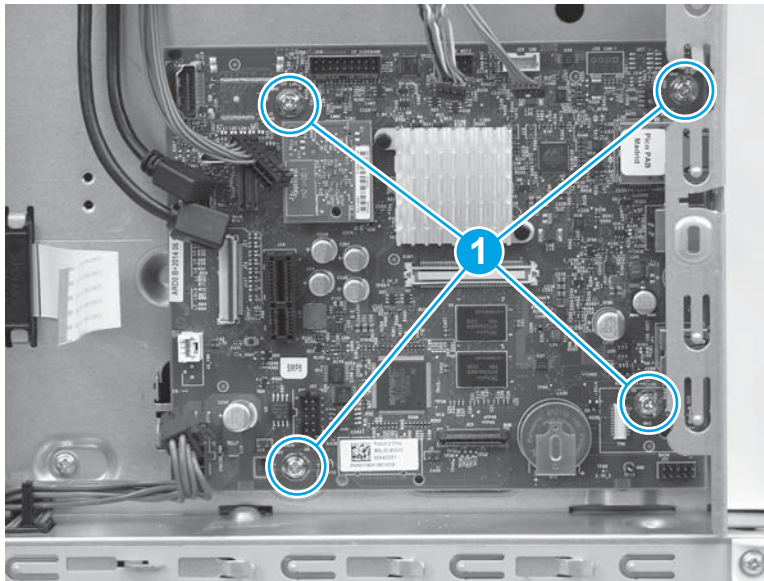

2. Connect all of the connectors on the formatter.

The following connectors are empty:

- All models: J1 (this connector is empty unless the optional DIMM is installed)
- M553n/dn and M552dn: J2 (callout 1; this is the touchscreen connector for the M553x model)
- All models: J9 (this connector is empty unless the optional internal USB ports component is installed)
- All models: J18 (this connector is empty unless the optional hard-disk-drive (HDD) is installed)
- All models: J23
- All models: J24
- M553n/dn and M552dn: J25 (this is the wireless connector for the M553x model)

- All models: J57
- All models: J98 (this connector is empty unless the optional trusted platform module (TPM) is installed)



 **IMPORTANT:** The flat-cable connector (callout 2) is a Zero Insertion Force (ZIF) connector that uses a hinged retainer to secure the flat cable. The hinged retainer must be opened to install the flat cable.

Figure 1-2786 Connect all connectors

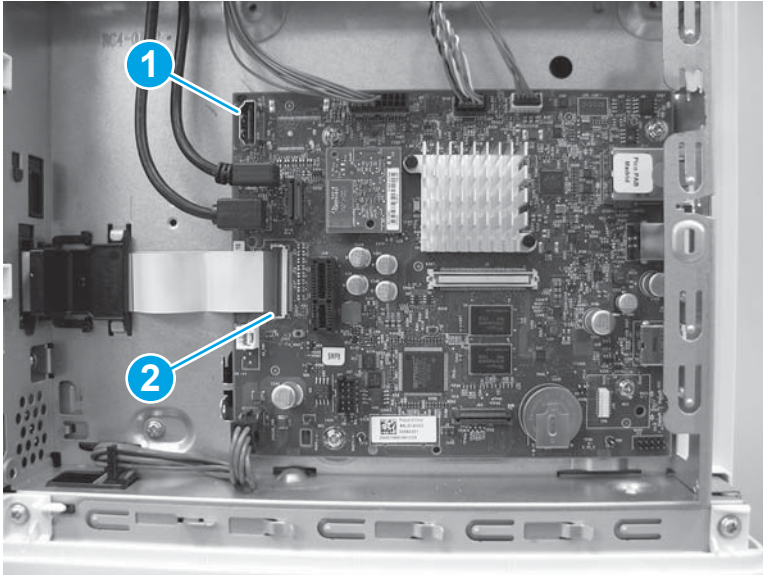

Step 47: Install the formatter cover

- ▲ Slide the cover onto the printer (callout 1) to install it.

 **NOTE:** Make sure that the tabs on the formatter cover align with the slots provided in the printer (callout 2). Tighten the two thumbscrews (callout 3).

 **TIP:** If needed, use the edge of a coin to turn the thumbscrews.

Figure 1-2787 Install the cover



Step 48: Install the TCU

1. Verify that the toner collection hatch cover is in the closed position on the TCU.

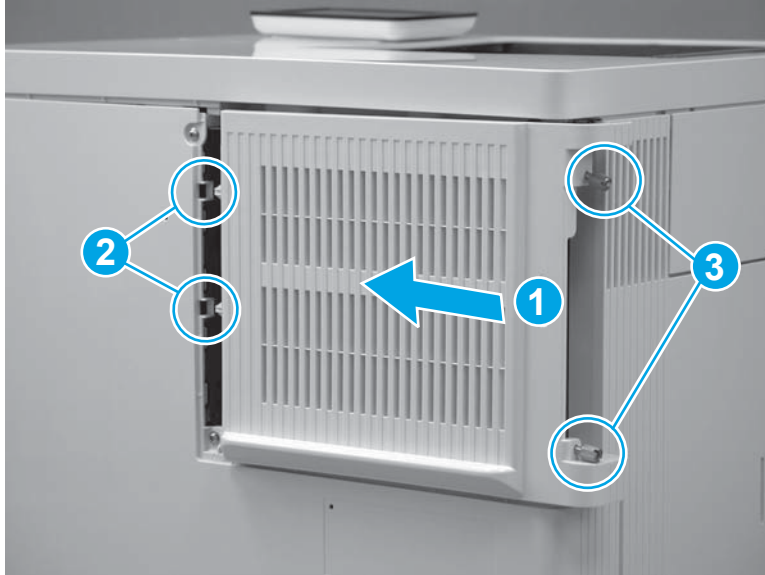
Figure 1-2788 Verify that the toner collection hatch cover is closed

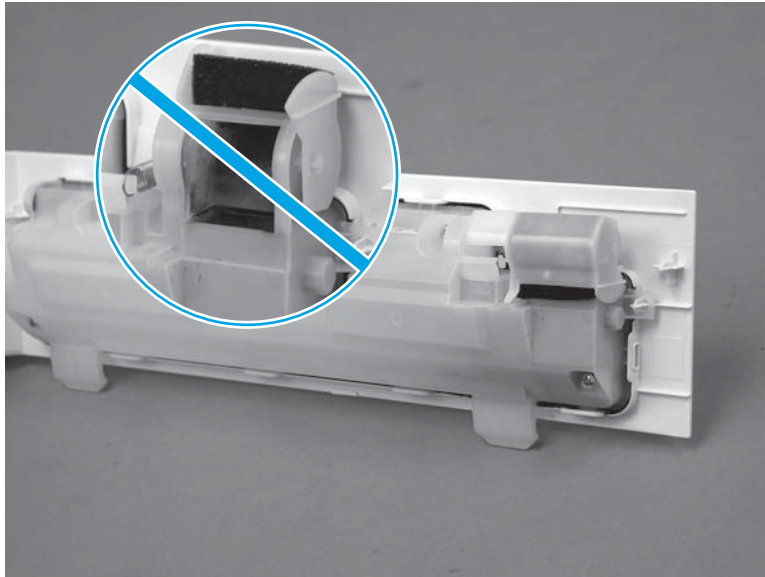

2. Position the TCU with the hinges in the slots provided in the printer (callout 1), and then rotate the TCU up and into the closed position.

 **NOTE:** The toner collection hatch cover automatically opens when the TCU is closed.

Figure 1-2789 Install the TCU



3. Close the front door.

Figure 1-2790 Close the front door

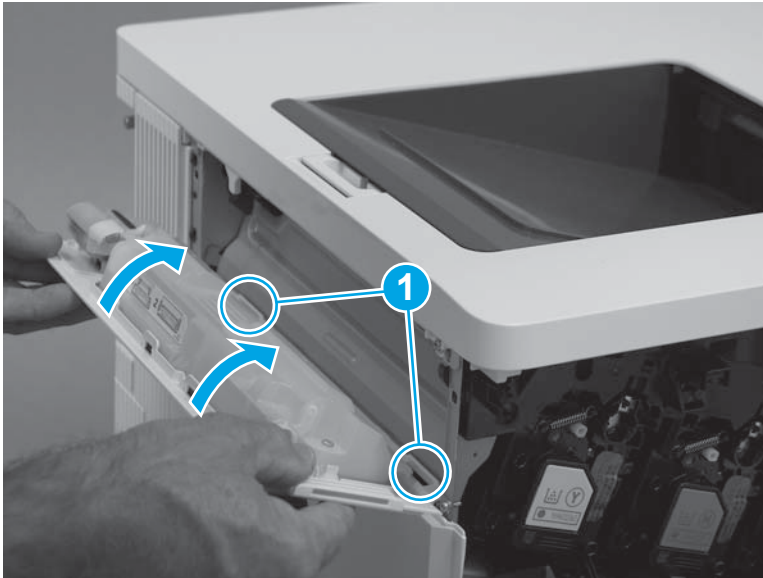

Step 49: Install the tray

1. With the front of the tray slightly lifted, align the sides of the tray with the rails in the printer, and then carefully slide the tray into the printer.

 **TIP:** As the tray slides into the printer, lower the front of it.

Figure 1-2791 Install the tray



2. Close the tray.

Figure 1-2792 Close the tray



Step 50: Install the control-panel assembly (M553x only)

 **NOTE:** For the M553n/dn and M552dn models, skip this step and go to [Step 51: Install the USB cover \(M552 and M553\) on page 1582](#).

For the M577 models, skip this step.

1. Place the control panel on the printer as shown.

Figure 1-2793 Place the control panel on the product

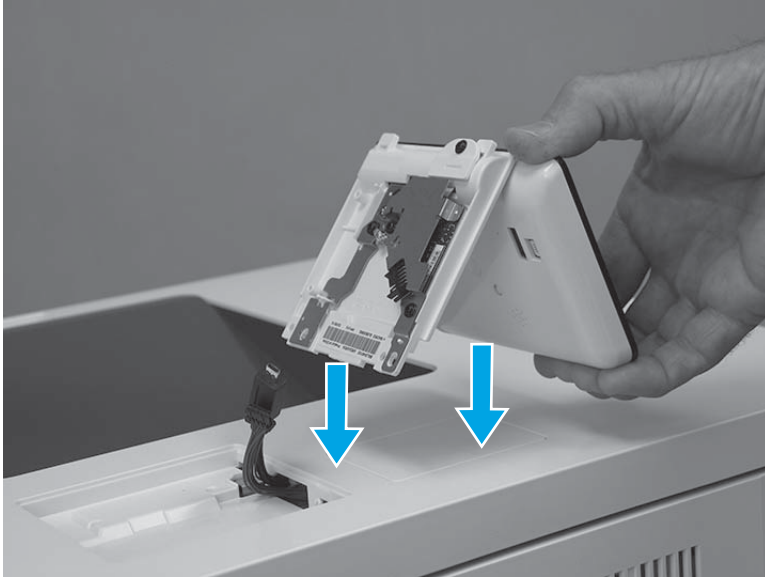

2. Connect one USB cable (callout 1), and one connector (callout 2).

 **IMPORTANT:** Take note of the location of the two mounting tabs (callout 3) on the control-panel assembly.

Figure 1-2794 Connect two connectors



3. Turn the control panel over, and then position the front edge tabs in the slots in the top cover.

Figure 1-2795 Turn the control panel over

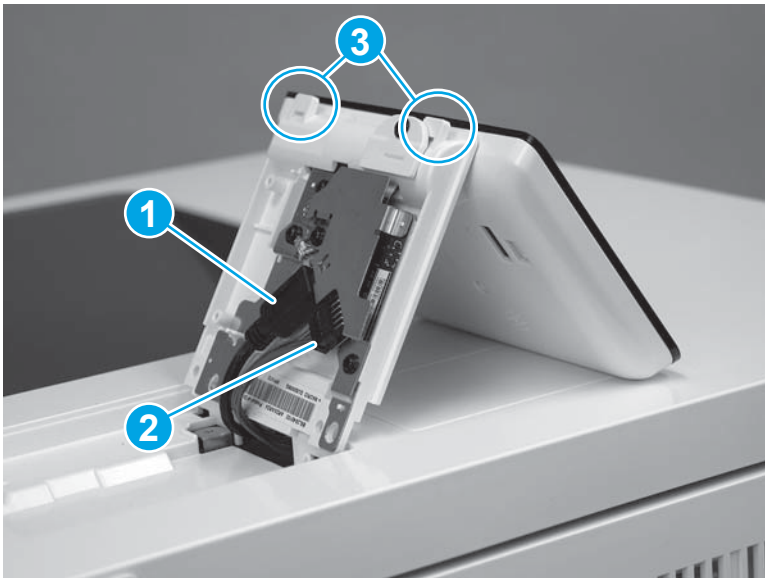
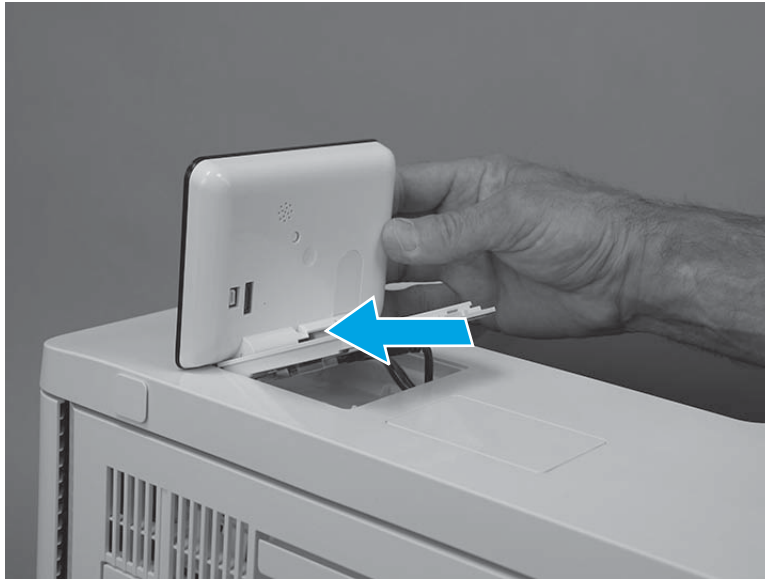

4. Rotate the control-panel base down onto the printer.

Figure 1-2796 Rotate the control-panel base down



5. Use a small Phillips screwdriver to install two screws (callout 1).

Figure 1-2797 Install two screws

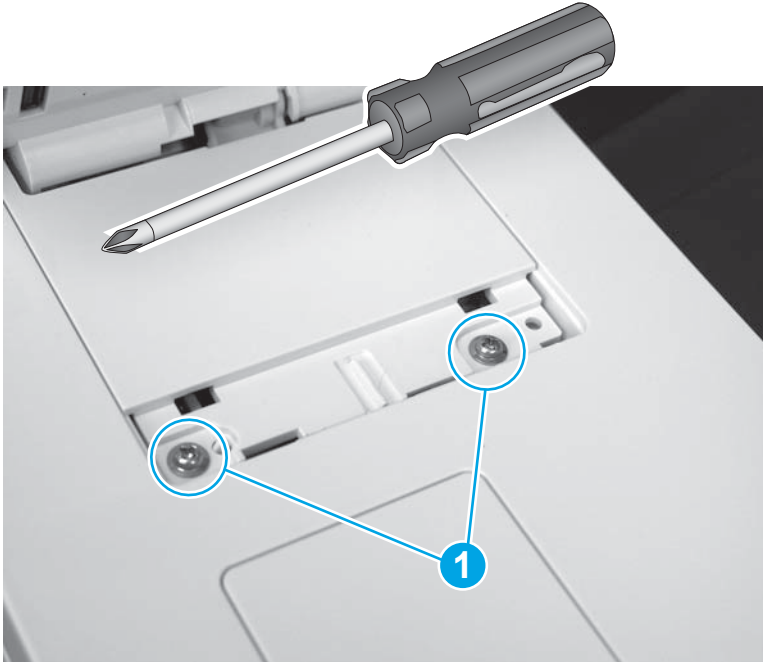

6. Position the screw cover mounting feet into the slots in the top cover (callout 1), and then rotate the cover down (callout 2) to install it.



 **NOTE:** Press down on the cover firmly to make sure that the tabs on the cover (callout 3) snap into place.

Figure 1-2798 Install the cover

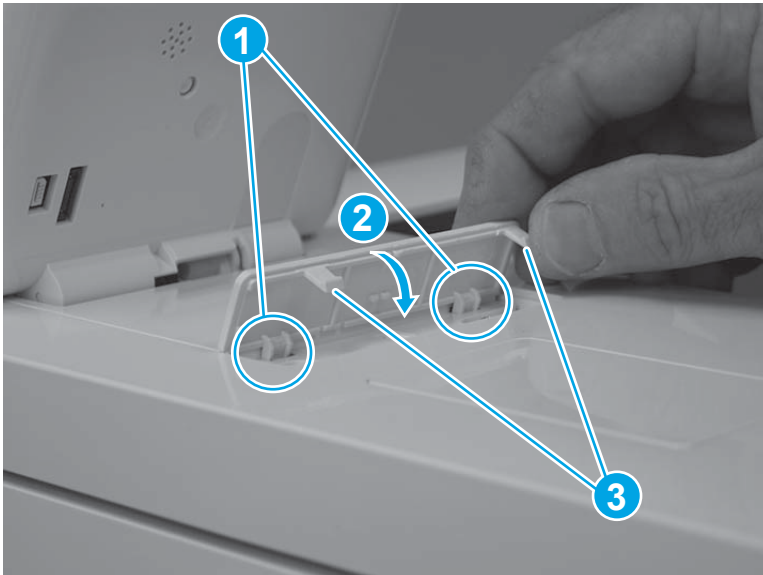

Step 51: Install the USB cover (M552 and M553)

 **NOTE:** This step is for the M552 and M553 models. For the M577 models, skip this step.

1. Push the cover into the USB port to install it.

Figure 1-2799 Install the cover



2. Make sure that the USB cover is fully seated after installing it.

Figure 1-2800 Check the installation



Removal and replacement: Drum motor 3 (M3)

- [Introduction](#)
- [Step 1: Remove the USB cover \(M552 and M553\)](#)
- [Step 2: Remove the control panel \(M553x only\)](#)
- [Step 3: Remove the tray](#)
- [Step 4: Remove the toner collection unit \(TCU\)](#)
- [Step 5: Remove the formatter cover](#)
- [Step 6: Remove the formatter \(M552 and M553\)](#)
- [Step 7: Remove the hard-disk drive \(HDD\) \(M577\)](#)
- [Step 8: Remove the fax PCA \(M577c/f/z\)](#)
- [Step 9: Remove the formatter \(M577\)](#)
- [Step 10: Remove the rear cover \(M552 and M553\)](#)
- [Step 11: Remove the rear upper cover \(M577\)](#)
- [Step 12: Remove the rear cover \(M577\)](#)
- [Step 13: Remove the left upper cover \(M577\)](#)
- [Step 14: Remove the right front upper cover \(M577dn\)](#)
- [Step 15: Remove the stapler cover assembly \(M577c/f/z\)](#)
- [Step 16: Remove the integrated scanner assembly \(ISA\) \(M577\)](#)
- [Step 17: Remove the right upper cover \(M577\)](#)
- [Step 18: Remove the top rear cover \(M577\)](#)
- [Step 19: Remove the left cover](#)
- [Step 20: Remove the upper cover \(M552 and M553\)](#)
- [Step 21: Remove the formatter case](#)
- [Step 22: Remove the right rear cover](#)
- [Step 23: Remove the DC controller and sheet-metal bracket](#)
- [Step 24: Remove the high-voltage power supply T \(HVPST\)](#)
- [Step 25: Remove drum motor 3 \(M3\)](#)
- [Step 26: Unpack the replacement assembly](#)
- [Step 27: Install drum motor 3 \(M3\)](#)
- [Step 28: Install the HVPST](#)
- [Step 29: Install the DC controller and sheet-metal bracket](#)

- [Step 30: Install the right rear cover](#)
- [Step 31: Install the formatter case](#)
- [Step 32: Install the upper cover \(M552 and M553\)](#)
- [Step 33: Install the left cover](#)
- [Step 34: Install the top rear cover \(M577\)](#)
- [Step 35: Install the right upper cover \(M577\)](#)
- [Step 36: Install the integrated scanner assembly \(ISA\) \(M577\)](#)
- [Step 37: Install the stapler cover assembly \(M577c/f/z\)](#)
- [Step 38: Install the right front upper cover \(M577dn\)](#)
- [Step 39: Install the left upper cover \(M577\)](#)
- [Step 40: Install the rear cover \(M577\)](#)
- [Step 41: Install the rear upper cover \(M577\)](#)
- [Step 42: Install the rear cover \(M552 and M553\)](#)
- [Step 43: Install the formatter \(M577\)](#)
- [Step 44: Install the fax PCA \(M577c/f/z\)](#)
- [Step 45: Install the HDD \(M577\)](#)
- [Step 46: Install the formatter \(M552 and M553\)](#)
- [Step 47: Install the formatter cover](#)
- [Step 48: Install the TCU](#)
- [Step 49: Install the tray](#)
- [Step 50: Install the control-panel assembly \(M553x only\)](#)
- [Step 51: Install the USB cover \(M552 and M553\)](#)

Introduction

This document provides the procedures to remove and replace the drum motor 3 (M3).

Before performing service

Turn the printer power off

- Disconnect the power cable.

 **WARNING!** To avoid damage to the printer, turn the printer off, wait 30 seconds, and then remove the power cord before attempting to service the printer.

Use the table below to identify the correct part number for your printer, and then go to <http://h20141.www2.hp.com/hpparts> to order the part.

Drum motor 3 (M3) part number

RM2-0078-000CNDrum motor 3 (M3)

Required tools

- #2 Phillips screwdriver with a magnetic tip

After performing service

Make sure that all of the connectors on the HVPST are fully seated.

Make sure that all of the connectors on the DC controller are fully seated.

Make sure that all of the connectors on the formatter are fully seated.

Make sure that the formatter cover is fully seated, and that the thumbscrews are finger tight after replacing it.

Turn the printer power on

- Connect the power cable.
- Use the power switch to turn the power on.

Post service test

Use the components test to test the motor. For more information, see the printer troubleshooting manual.

Step 1: Remove the USB cover (M552 and M553)

NOTE: This step is for the M552 and M553 models. For the M577 models, skip this step and go to [Step 3: Remove the tray on page 1591](#).

1. Locate the USB cover.

Figure 1-2801 Locate the USB cover

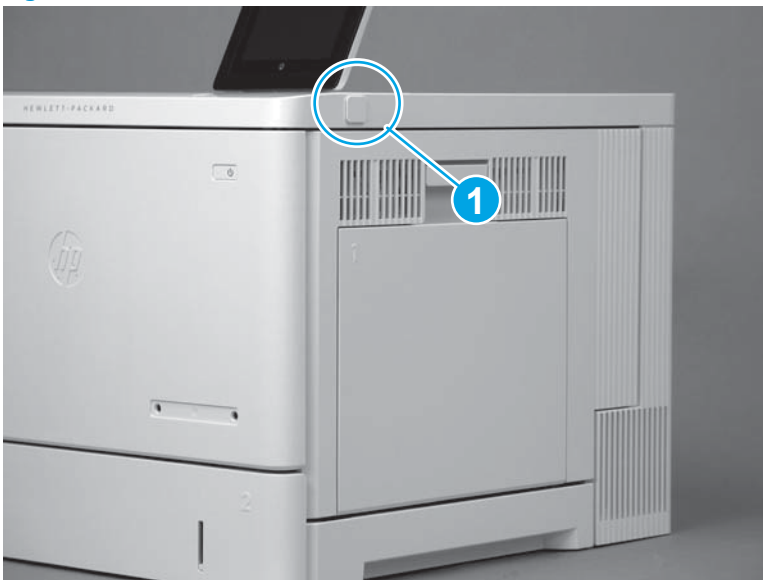

2. Pull the cover off of the printer to remove it.

Figure 1-2802 Remove the cover



Step 2: Remove the control panel (M553x only)

 **NOTE:** This step is for the M553x model. For the M553n/dn, M552dn, and M577 models, skip this step and go to [Step 3: Remove the tray on page 1591](#).

1. Tilt the control panel up.

Figure 1-2803 Tilt the control panel up



2. Use a small flat-blade screwdriver to release the control-panel screws cover tabs.

Figure 1-2804 Release the control-panel screws cover tabs



3. Rotate the cover up to remove it.

Figure 1-2805 Remove the cover



4. Use a small Phillips screwdriver to remove two screws (callout 1).

 **IMPORTANT:** Store the screws in a secure place where they cannot fall down into the printer.

Figure 1-2806 Remove two screws

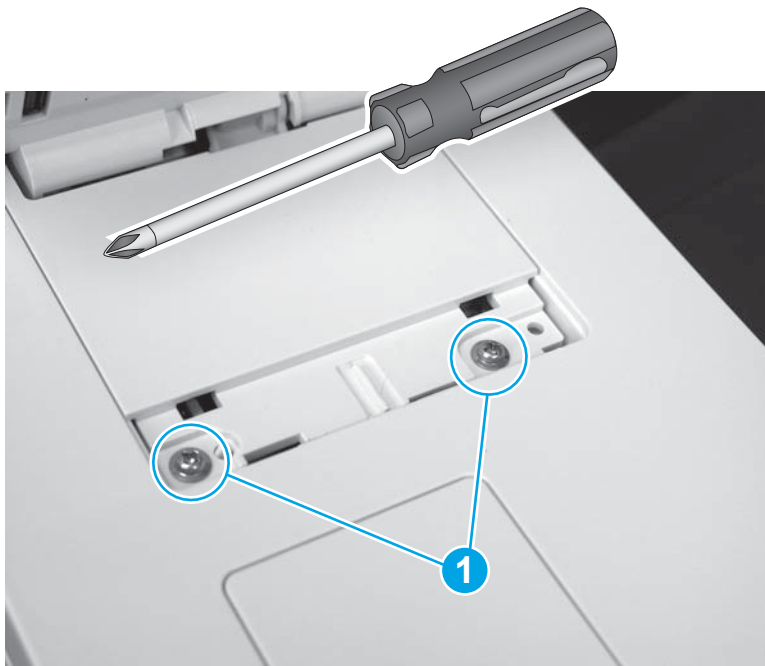

5. Rotate the control-panel base toward the front of the printer.

Figure 1-2807 Rotate the control-panel base up



6. Slightly slide the control-panel base toward the rear of the printer (callout 1) to release it, and then turn the control panel over (callout 2) to access the bottom side.

CAUTION: The control panel is still attached to the printer. Do not attempt to completely remove the control panel.

Figure 1-2808 Turn the control panel over

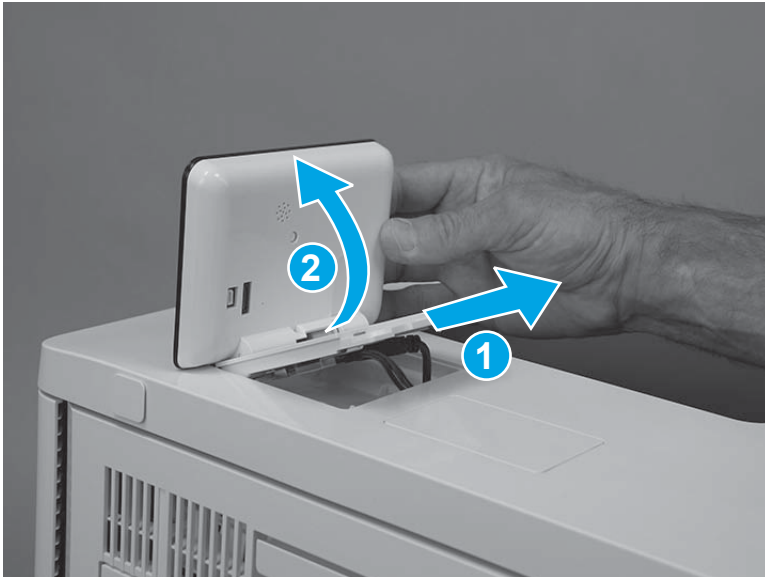

7. Disconnect one USB cable (callout 1), one connector (callout 2), and then remove the control panel.

Figure 1-2809 Disconnect two connectors

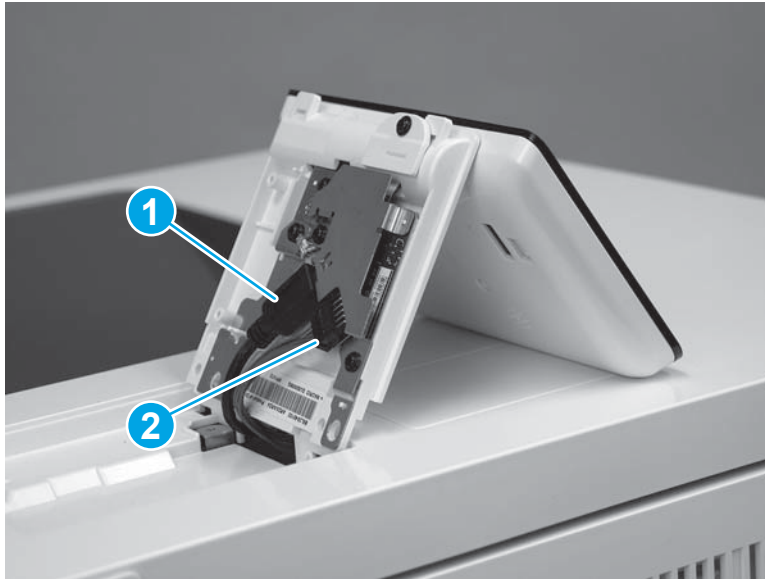

Step 3: Remove the tray

1. Pull the tray out until it stops.

Figure 1-2810 Pull the tray out



2. Lift the front of the tray, and then pull it out of the printer to remove it.

Figure 1-2811 Remove the tray

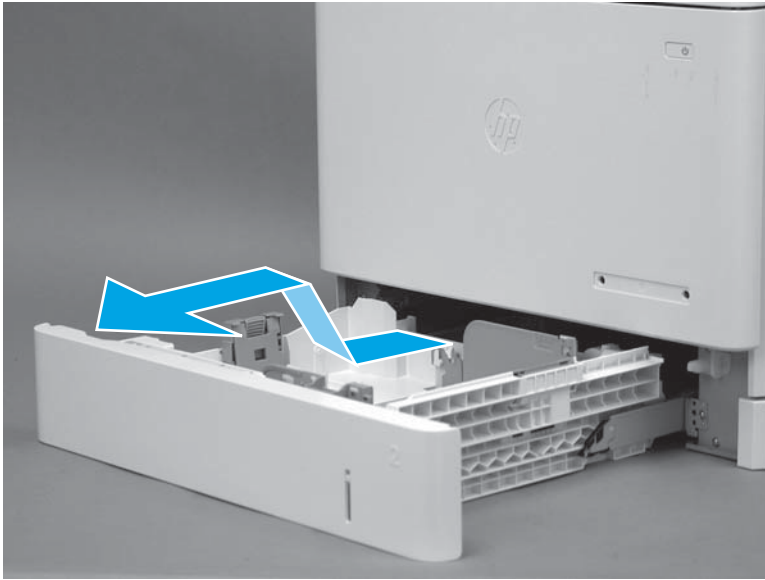

Step 4: Remove the toner collection unit (TCU)

1. Open the front door.

Figure 1-2812 Open the front door



2. Open the TCU.



NOTE: The toner collection hatch cover automatically closes when the TCU is opened.

Figure 1-2813 Open the TCU



3. Pull the TCU away from the printer at an angle to remove it.

⚠ CAUTION: Do not open the toner collection hatch cover when handling the TCU. If toner gets on clothing, wipe it off by using a dry cloth and wash the clothes in cold water. Hot water sets toner into fabric.

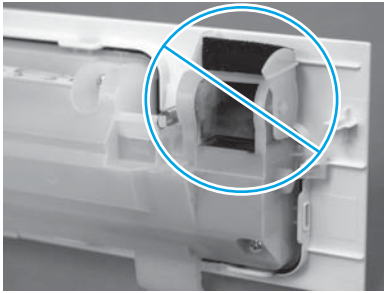
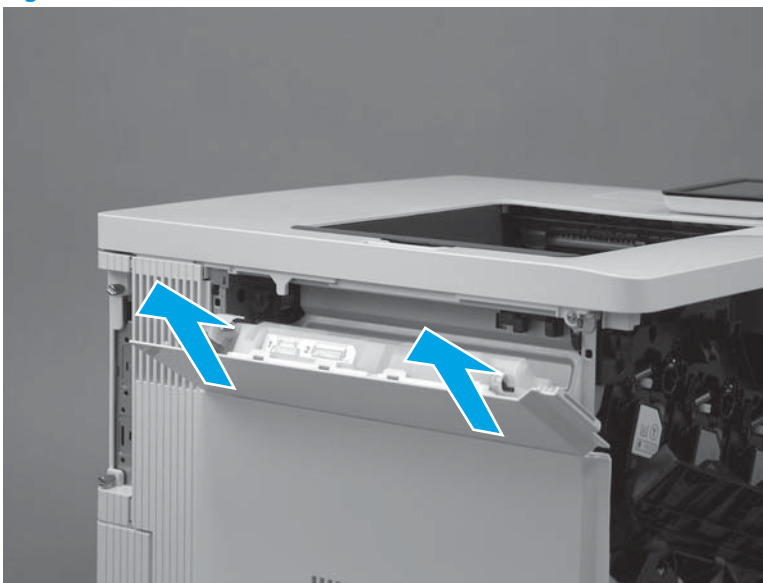

Figure 1-2814 Remove the TCU



Step 5: Remove the formatter cover

1. Locate the formatter cover.

Figure 1-2815 Locate the formatter cover

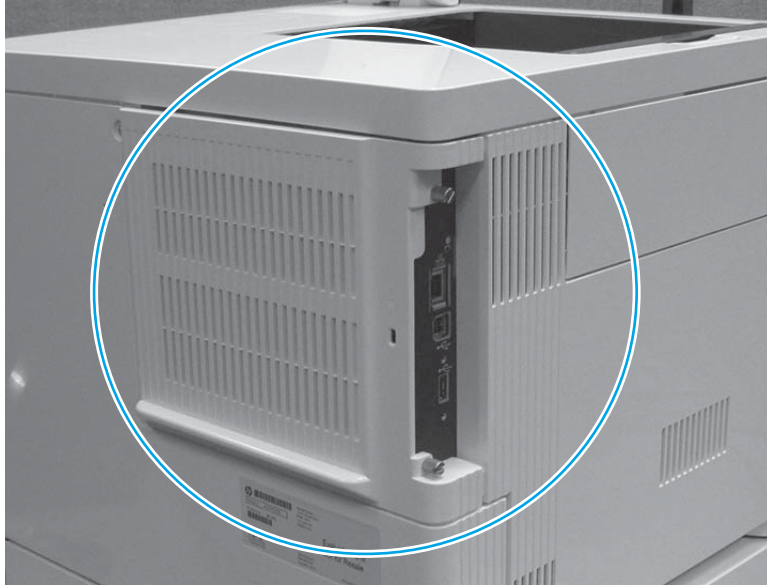

2. Loosen the two thumbscrews (callout 1). Grasp the two thumbscrews, and then slide the cover away from the printer (callout 2) to remove it.

 **TIP:** If needed, use the edge of a coin to turn the thumbscrews.

Figure 1-2816 Loosen the thumbscrews



Step 6: Remove the formatter (M552 and M553)

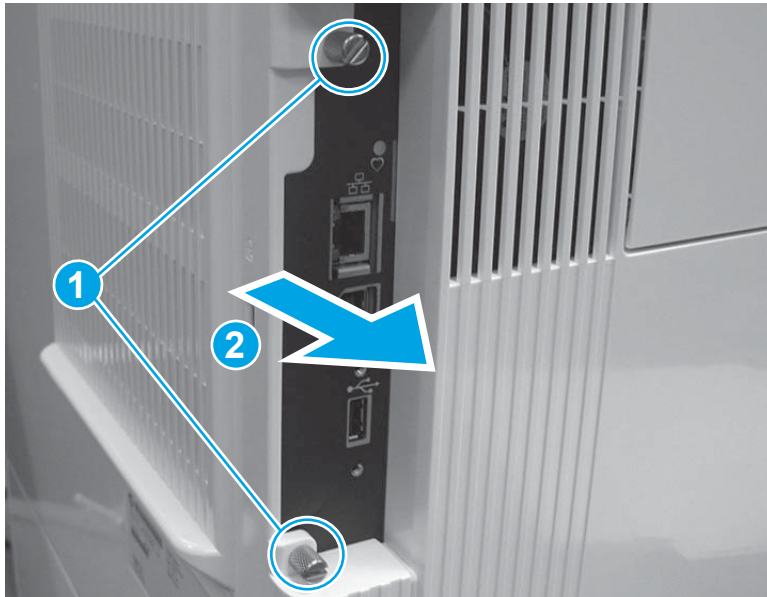

NOTE: This step is for the M552 and M553 models. For the M577 models, skip this step and go to [Step 7: Remove the hard-disk drive \(HDD\) \(M577\) on page 1597](#).

If the optional hard-disk drive (HDD) is installed, it must be removed to gain access to the formatter mounting screws.

Release two tabs along the left edge of the HDD, rotate the left edge away from the product, and then slide the HDD to the left to remove it.



CAUTION:  ESD-sensitive part.

1. Disconnect all of the connectors on the formatter.

The following connectors are empty:

- All models: J1 (this connector is empty unless the optional DIMM is installed)
- M553n/dn and M552dn: J2 (callout 1; this is the touchscreen connector for the M553x model)
- All models: J9 (this connector is empty unless the optional internal USB ports component is installed)
- All models: J18 (this connector is empty unless the optional hard-disk-drive (HDD) is installed)
- All models: J23
- All models: J24
- M553n/dn and M552dn: J25 (this is the wireless connector for the M553x model)
- All models: J57
- All models: J98 (this connector is empty unless the optional trusted platform module (TPM) is installed)



IMPORTANT: The flat-cable connector (callout 2) is a Zero Insertion Force (ZIF) connector that uses a hinged retainer to secure the flat cable. The hinged retainer must be opened to release the flat cable.

Figure 1-2817 Disconnect all connectors

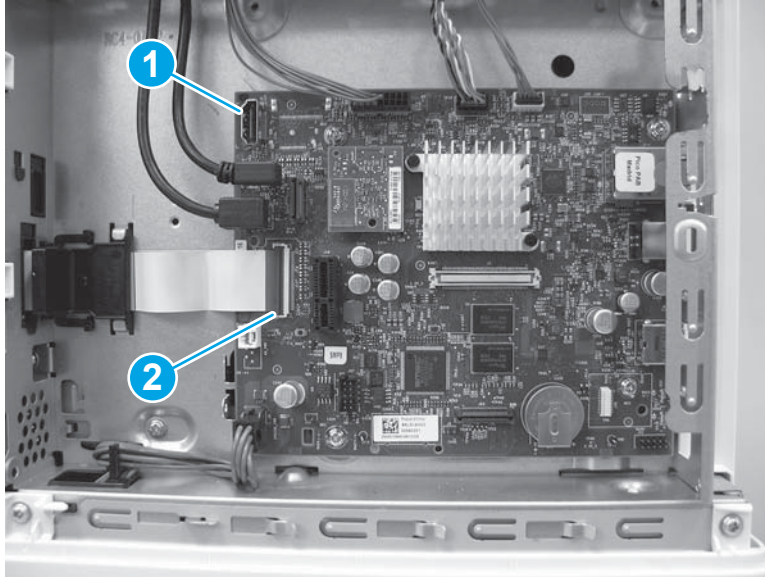

2. Remove four screws (callout 1), and then remove the formatter.

Figure 1-2818 Remove the formatter

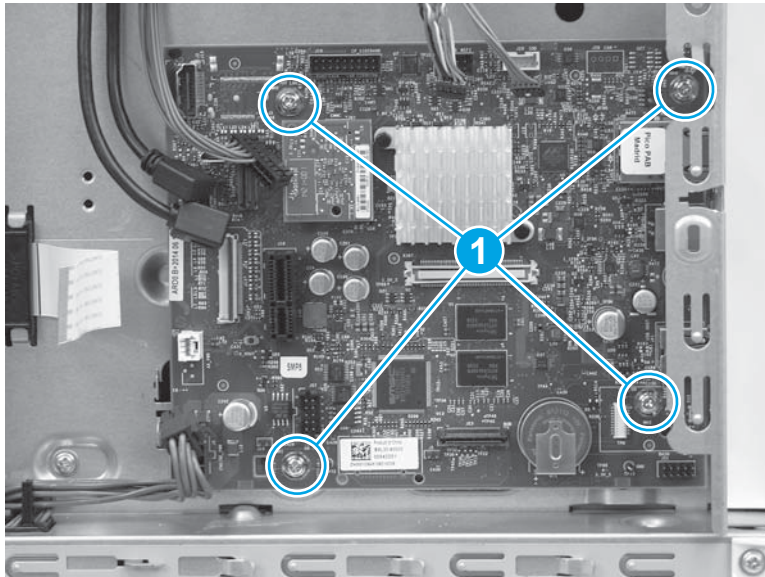

Step 7: Remove the hard-disk drive (HDD) (M577)

 **NOTE:** This step is for the M577 models. For the M552 and M553 models, skip this step and go to [Step 10: Remove the rear cover \(M552 and M553\) on page 1602](#).

 **CAUTION:**  ESD-sensitive part.

1. Release two tabs (callout 1). Hold the tabs in the released position, and then rotate the hard disk drive (HDD) up (callout 2) to release the connector from the formatter.

Figure 1-2819 Release the HDD

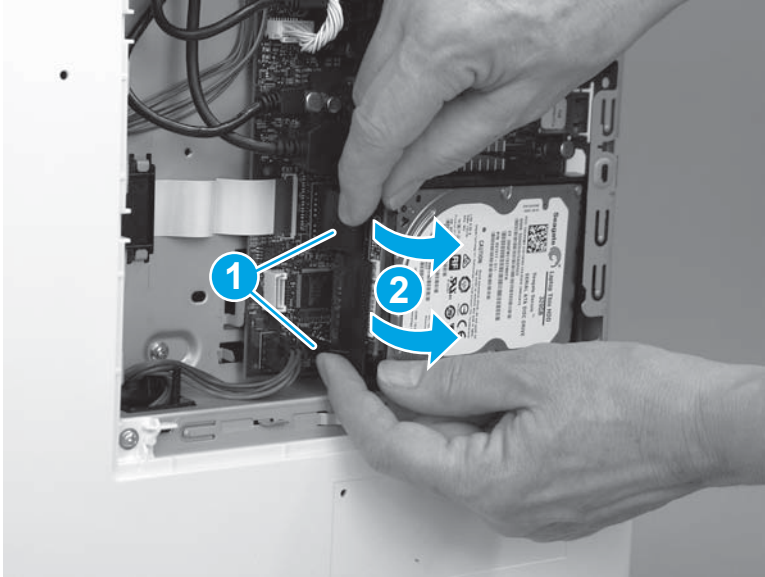

2. Slide the HDD away from the printer to remove it.

Figure 1-2820 Remove the HDD



Step 8: Remove the fax PCA (M577c/f/z)



NOTE: This step is for the M577c/f/z models. For the M577n model, skip this step and go to [Step 9: Remove the formatter \(M577\) on page 1600](#).

For the M552 and M553 models, skip this step and go to [Step 10: Remove the rear cover \(M552 and M553\) on page 1602](#).



CAUTION:  ESD-sensitive part.

1. Locate the fax PCA component on the formatter.

Figure 1-2821 Locate the fax PCA

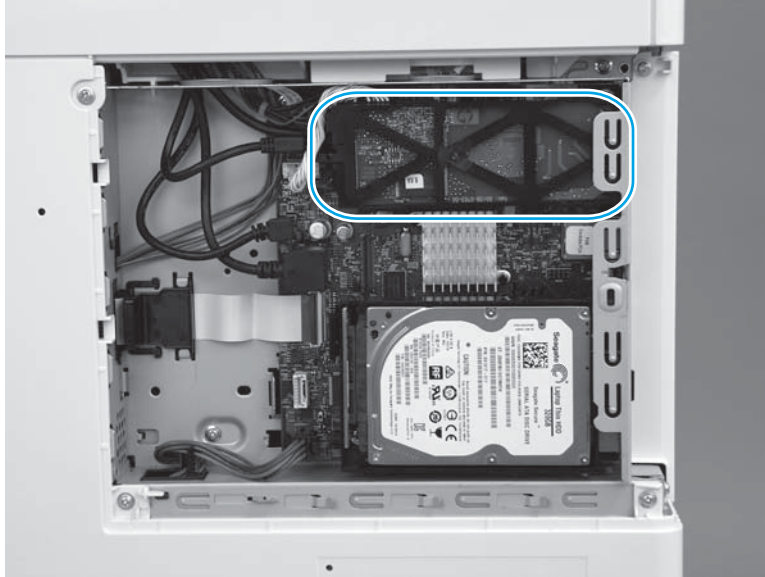

2. Release the connector latch (callout 1), and then pull the connector away from the formatter (callout 2) to disconnect it.

Figure 1-2822 Disconnect one connector

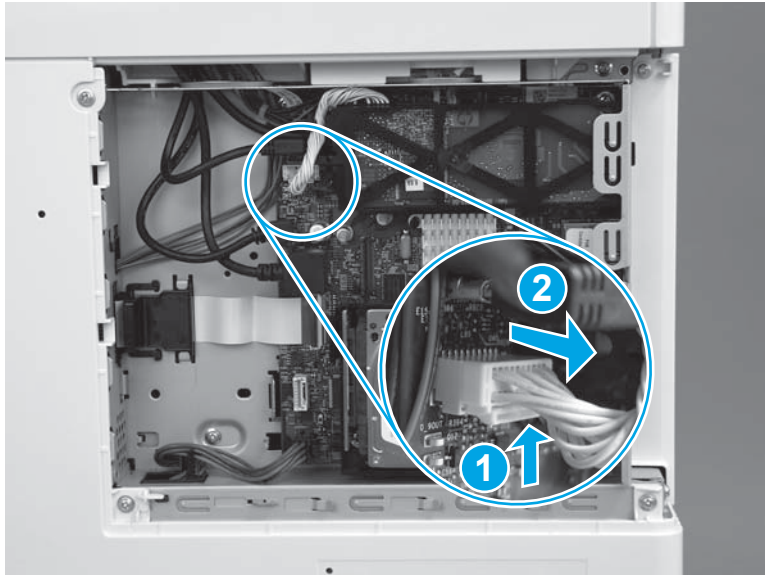

3. Release one retainer (callout 1) by pressing the bracket arms together.

Figure 1-2823 Release one latch

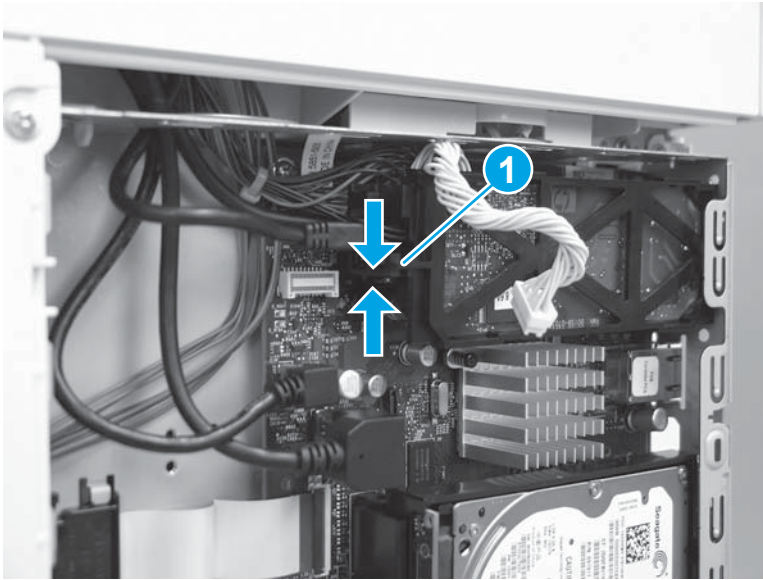

4. Rotate the end of the fax PCA (callout 1) away from the formatter, and then slide the PCA left (callout 2) to remove it.

Figure 1-2824 Remove the fax PCA

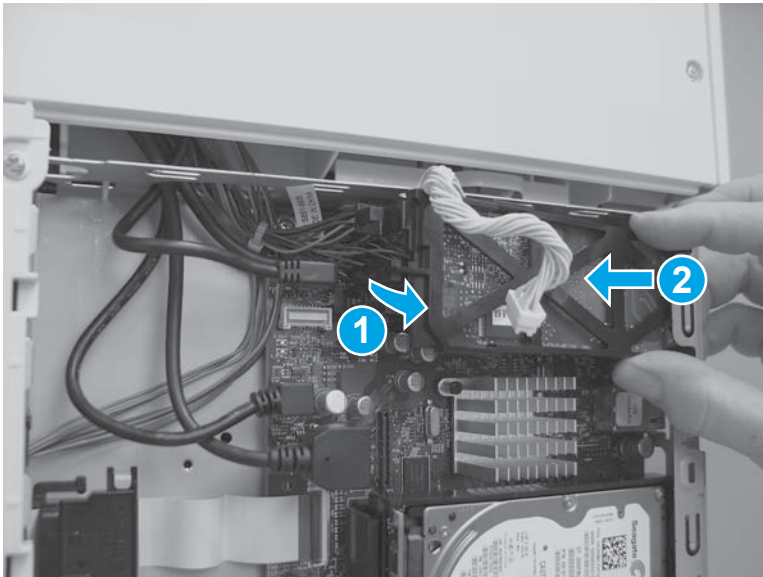

Step 9: Remove the formatter (M577)

 **NOTE:** This step is for the M577 models. For the M552 and M553 models, skip this step and go to [Step 10: Remove the rear cover \(M552 and M553\) on page 1602.](#)

 **CAUTION:**  ESD-sensitive part.

1. Disconnect all of the connectors on the formatter.

The following connectors are empty:

- All models: J1 (this connector is empty unless the optional DIMM is installed)
- All models: J3
- M577dn: J15 (this is the fax connector for the M577f/z/c models)
- All models: J21 (this connector is empty unless the optional internal USB ports component is installed)
- All models: J23
- All models: J24
- All models: J51
- All models: J57
- All models: J97
- All models: J98 (this connector is empty unless the optional trusted platform module (TPM) is installed)

 **IMPORTANT:** The flat-cable connector (callout 1) is a Zero Insertion Force (ZIF) connector that uses a hinged retainer to secure the flat cable. The hinged retainer must be opened to release the flat cable.

Figure 1-2825 Disconnect all connectors



2. Remove four screws (callout 1).

Figure 1-2826 Remove four screws

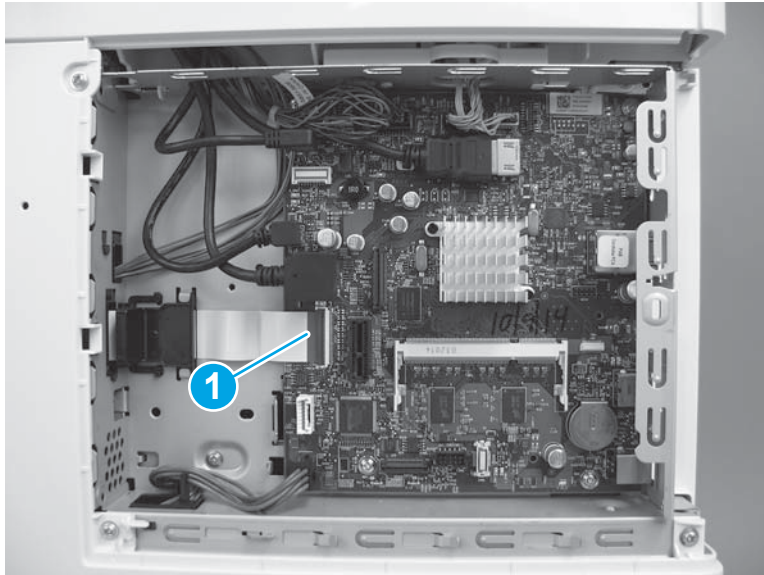
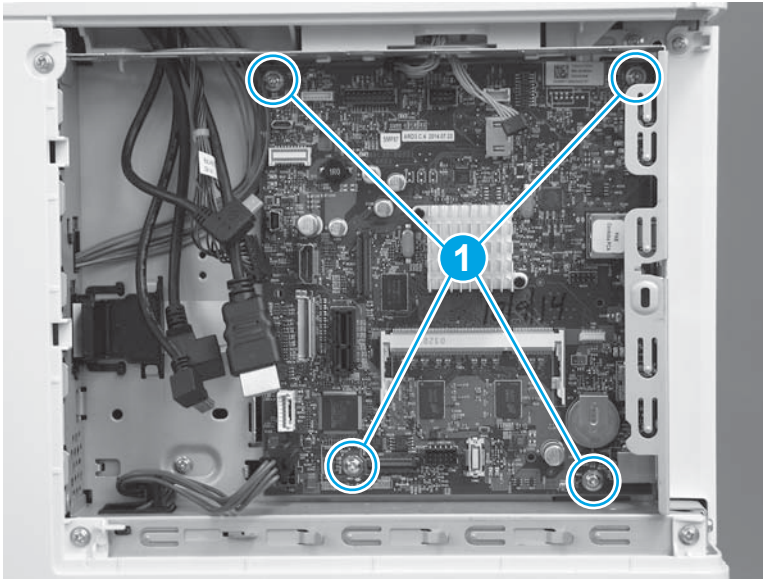

3. Remove the formatter.

Figure 1-2827 Remove the formatter

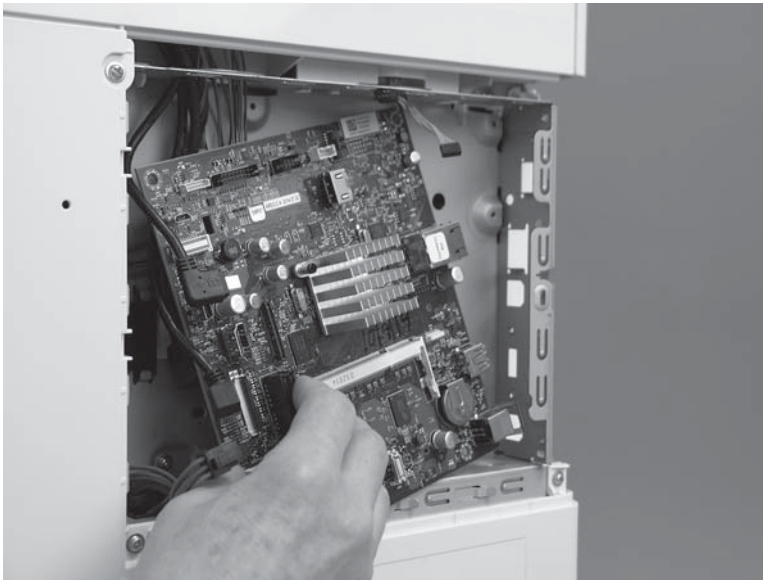

Step 10: Remove the rear cover (M552 and M553)



NOTE: This step is for the M552 and M553 models. For the M577 models, skip this step and go to [Step 11: Remove the rear upper cover \(M577\) on page 1603.](#)

1. Remove four screws (callout 1).

Figure 1-2828 Remove four screws

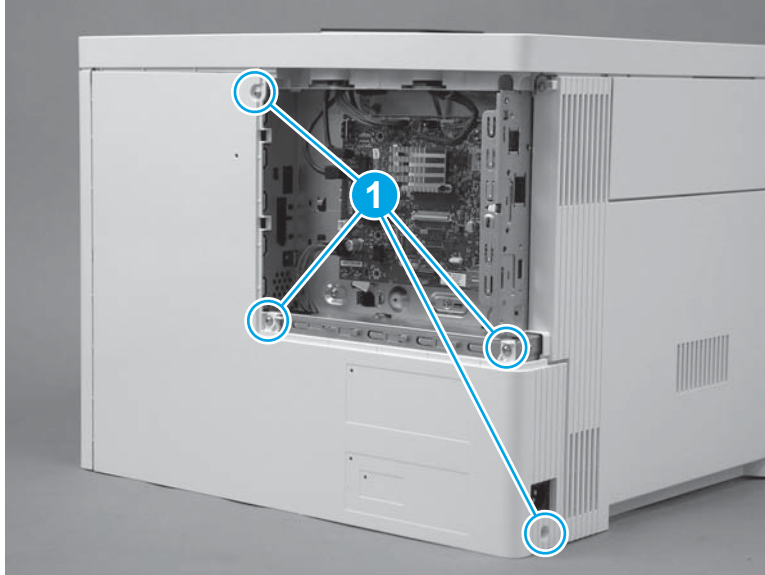

2. Slightly slide the cover to the right (callout 1), rotate the bottom of the cover away from the printer (callout 2), and then pull the top of the cover away from the printer (callout 3) to remove the cover.

Figure 1-2829 Remove the cover

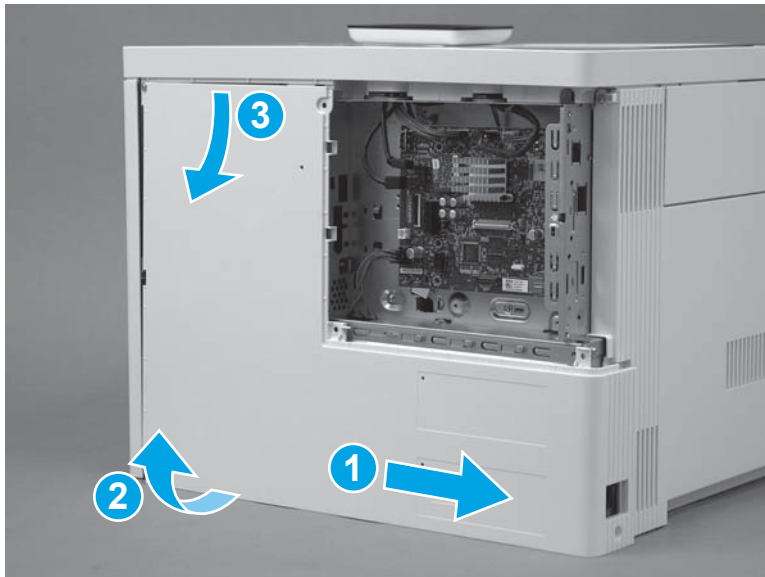

Step 11: Remove the rear upper cover (M577)

 **NOTE:** This step is for the M577 models. For the M552 and M553 models, skip this step and go to [Step 19: Remove the left cover on page 1618](#).

1. Remove two screws (callout 1).

 **Reinstallation tip:** These two screws are self-tapping screws for plastic. When reinstalling them, rotate the screws counterclockwise to align them with the existing thread pattern, and then carefully turn them clockwise to tighten. Do not overtighten. This will prevent stripping the threads inside the screw holes.

Figure 1-2830 Remove two screws



2. Use a small, flat blade screwdriver to release the right edge of the cover.

Figure 1-2831 Release the right edge

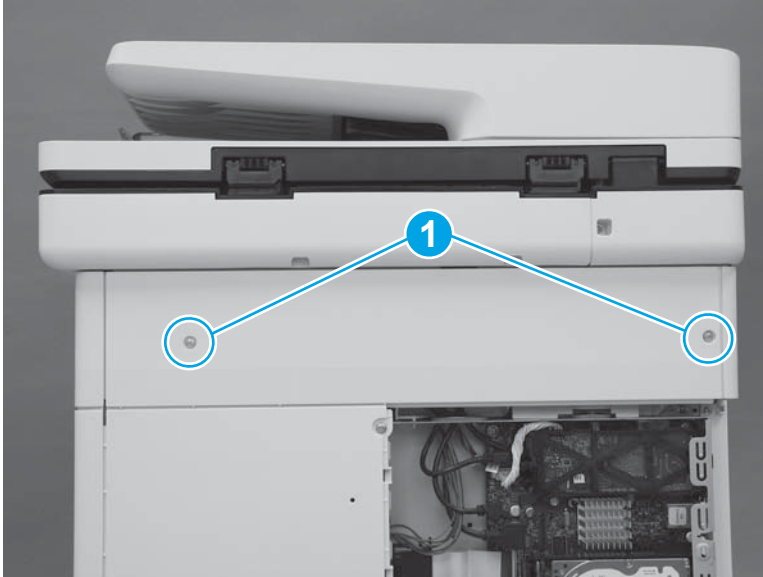
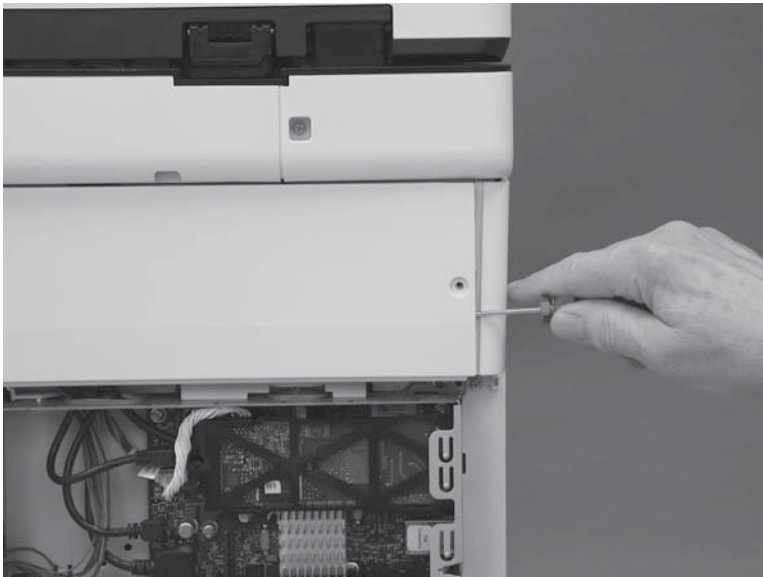

3. Pull the right edge of the cover (callout 1) away from the printer, and then slide the cover to the right (callout 2).

Figure 1-2832 Slide the cover right

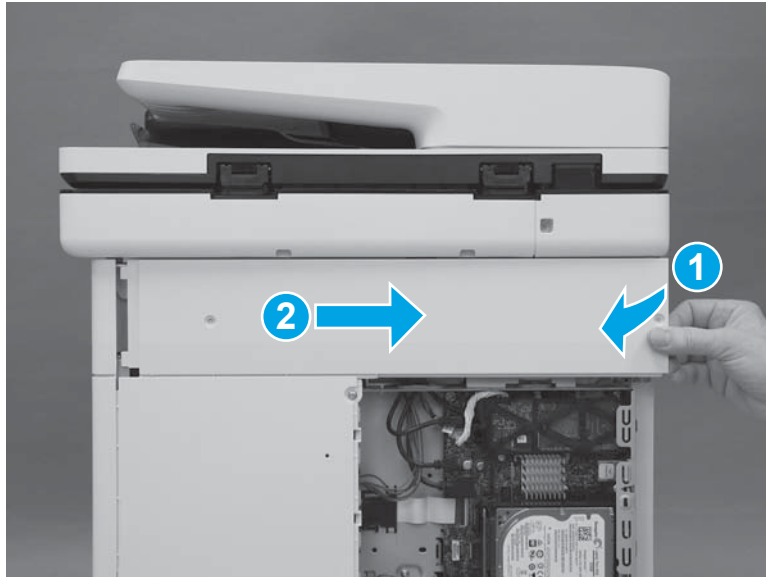

4. Remove the cover.

Figure 1-2833 Remove the cover

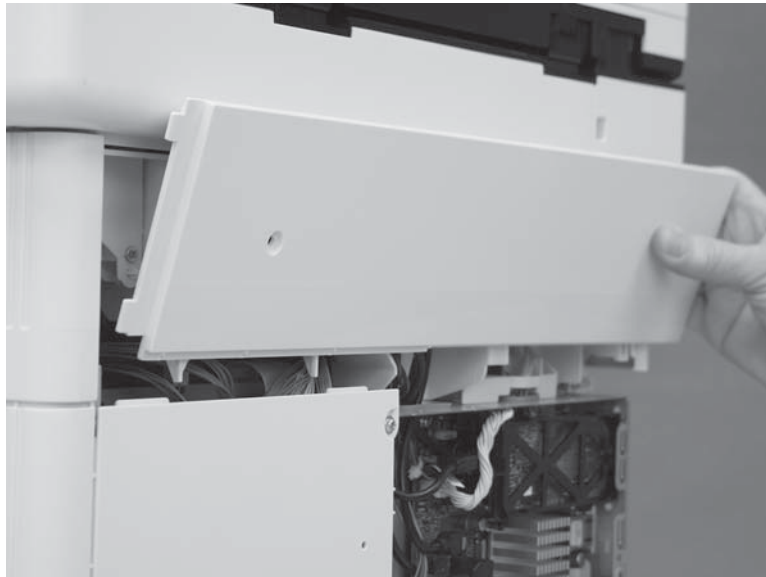

Step 12: Remove the rear cover (M577)

 **NOTE:** This step is for the M577 models. For the M552 and M553 models, skip this step and go to [Step 19: Remove the left cover on page 1618](#).

1. Remove four screws (callout 1).

Figure 1-2834 Remove four screws

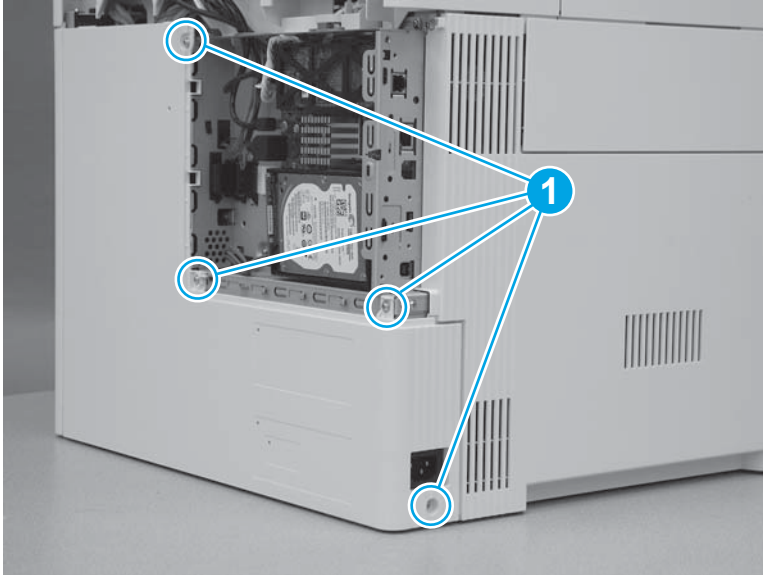

2. Slide the cover to the right to remove it.

Figure 1-2835 Remove the cover

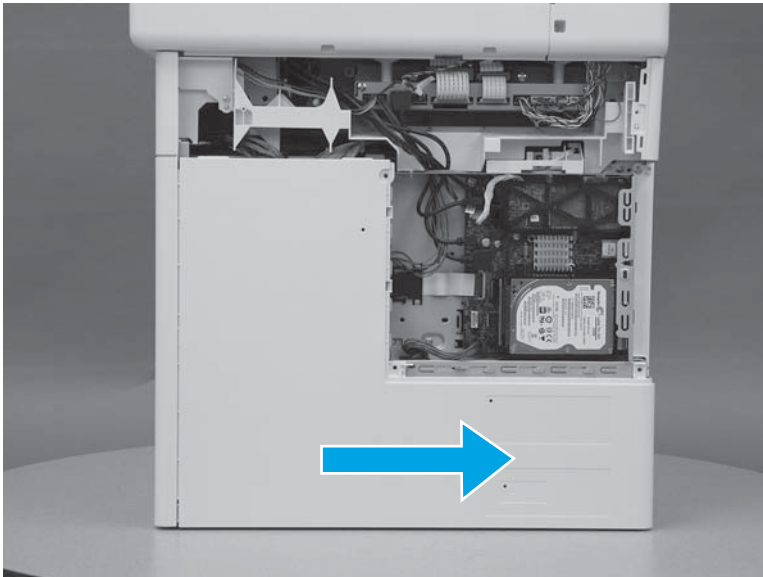

Step 13: Remove the left upper cover (M577)



NOTE: This step is for the M577 models. For the M552 and M553 models, skip this step and go to [Step 19: Remove the left cover on page 1618](#).

1. At the left side of the printer, release one tab (callout 1).

Figure 1-2836 Release one tab

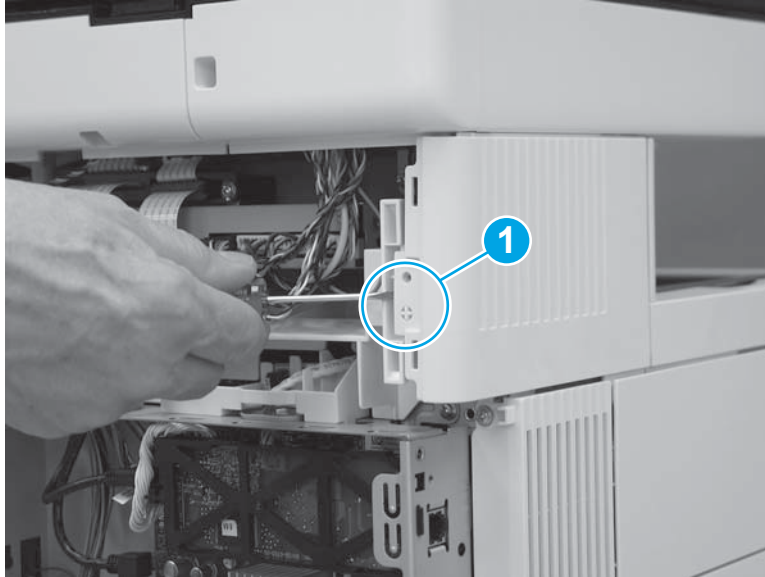

2. Slide the left upper cover toward the back of the printer.

Figure 1-2837 Slide the cover back

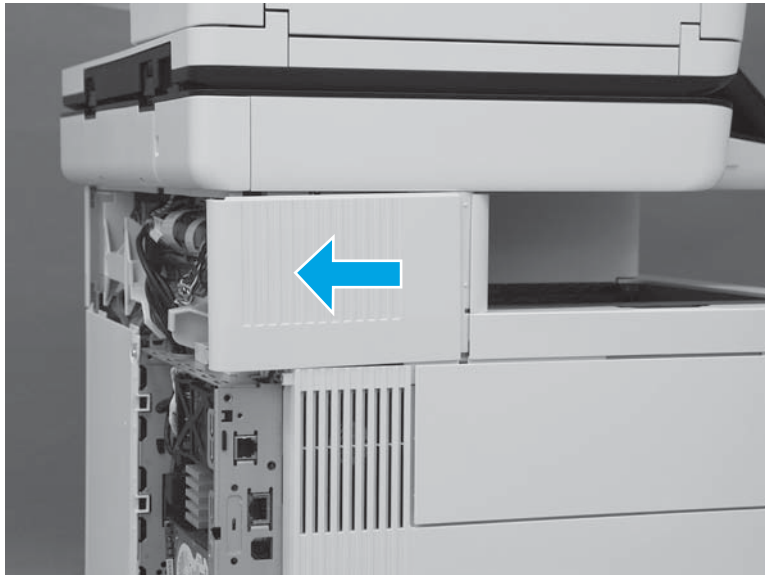

3. Rotate the cover up to remove it.

Figure 1-2838 Remove the left upper cover

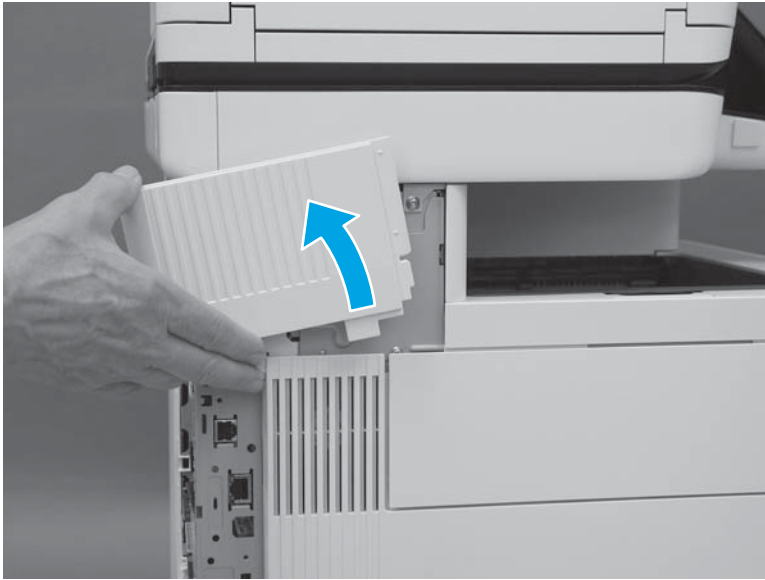

Step 14: Remove the right front upper cover (M577dn)



NOTE: This step is for the M577dn model. For the M577c/f/z models, skip this step and to go [Step 15: Remove the stapler cover assembly \(M577c/f/z\) on page 1609.](#)

For the M552 and M553 models, skip this step and go to [Step 19: Remove the left cover on page 1618.](#)

1. Remove one screw (callout 1).

Figure 1-2839 Remove one screw

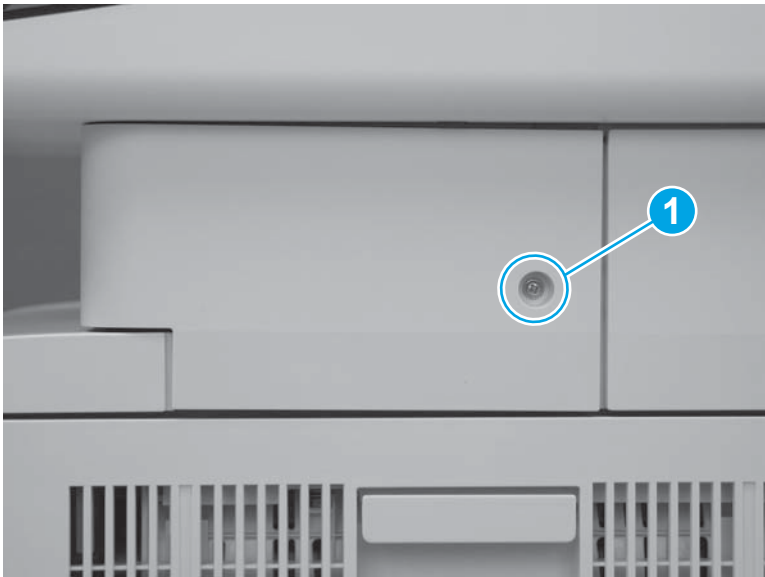

2. Release two tabs at the front edge of the cover (callout 1).

Figure 1-2840 Release two tabs



3. Rotate the front of the cover to the right to remove it.

Figure 1-2841 Rotate the cover



Step 15: Remove the stapler cover assembly (M577c/f/z)

 **NOTE:** This step is for the M577c/f/z models. For the M577dn model, skip this step and to go [Step 17: Remove the right upper cover \(M577\) on page 1614.](#)

For the M552 and M553 models, skip this step and go to [Step 19: Remove the left cover on page 1618.](#)

1. Remove one screw (callout 1).

 **Reinstallation tip:** This is a self-tapping screw for plastic. When reinstalling, rotate the screw counterclockwise to align it with the existing thread pattern, and then carefully turn it clockwise to tighten. Do not overtighten. This will prevent stripping the threads inside the screw hole.

Figure 1-2842 Remove one screw



2. Release two tabs at the front edge of the cover (callout 1).

Figure 1-2843 Release two tabs

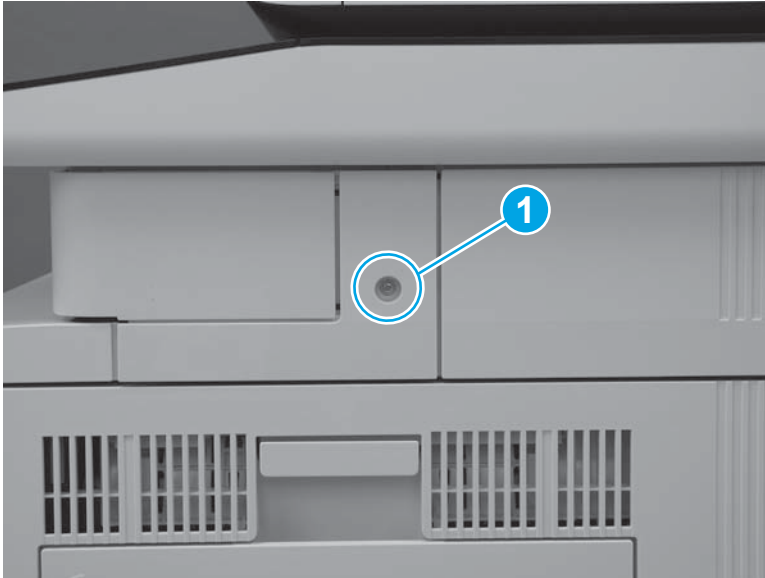

3. Release the back edge of the cover.

Figure 1-2844 Release the back edge of the cover

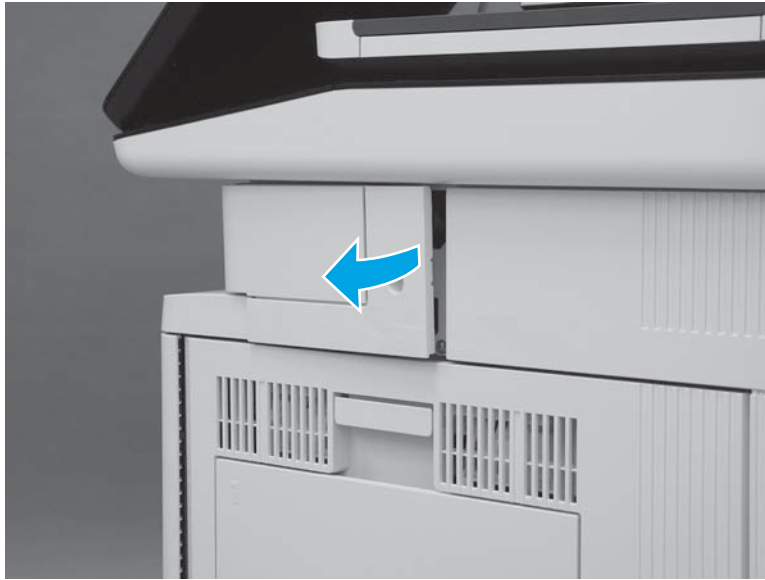



4. Rotate the cover away from the printer to remove it.

Figure 1-2845 Remove the cover



Step 16: Remove the integrated scanner assembly (ISA) (M577)

 **NOTE:** This step is for the M577 models. For the M552 and M553 models, skip this step and go to [Step 19: Remove the left cover on page 1618](#).

 **NOTE:** The ISA includes the document feeder, image scanner, scanner control board (SCB), control panel, keyboard (M577c/z) and NFC PCA (M577z).

1. At the left side of the printer, remove one screw (callout 1).

Figure 1-2846 Remove one screw

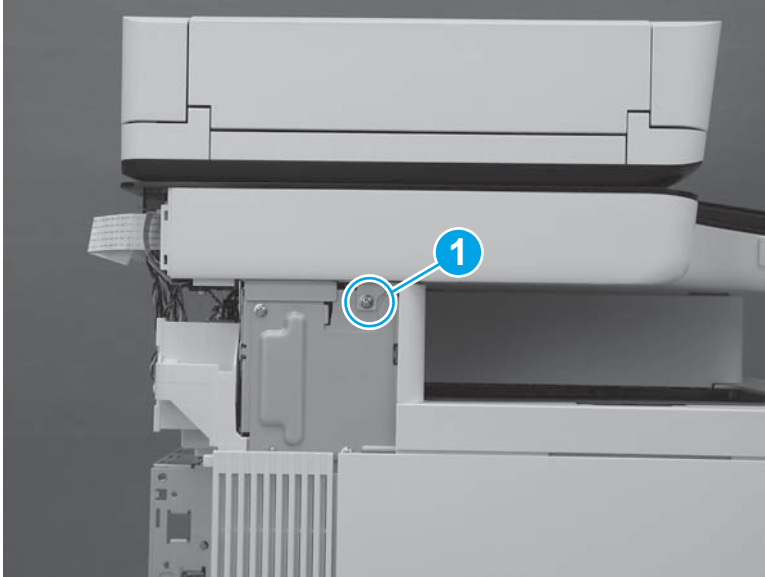

2. At the back side of the printer, remove two screws (callout 1).

Figure 1-2847 Remove two screws

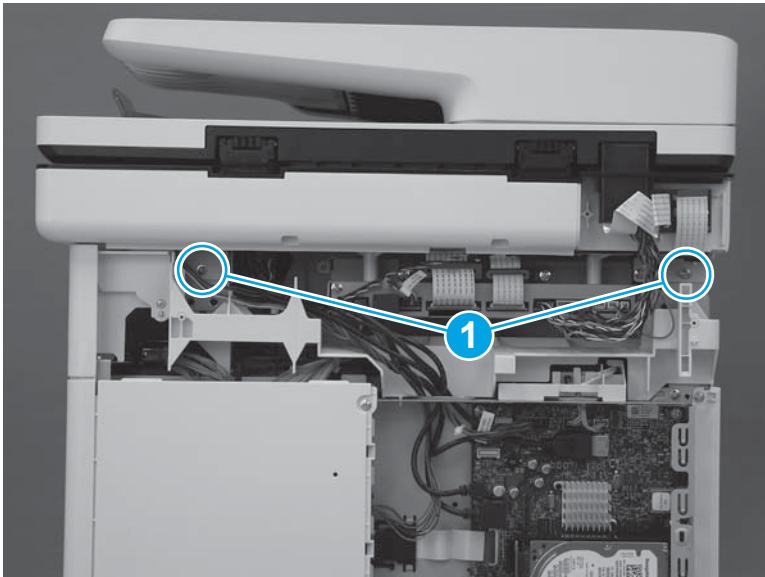

3. At the right side of the printer, remove one screw (callout 1).

Figure 1-2848 Remove one screw

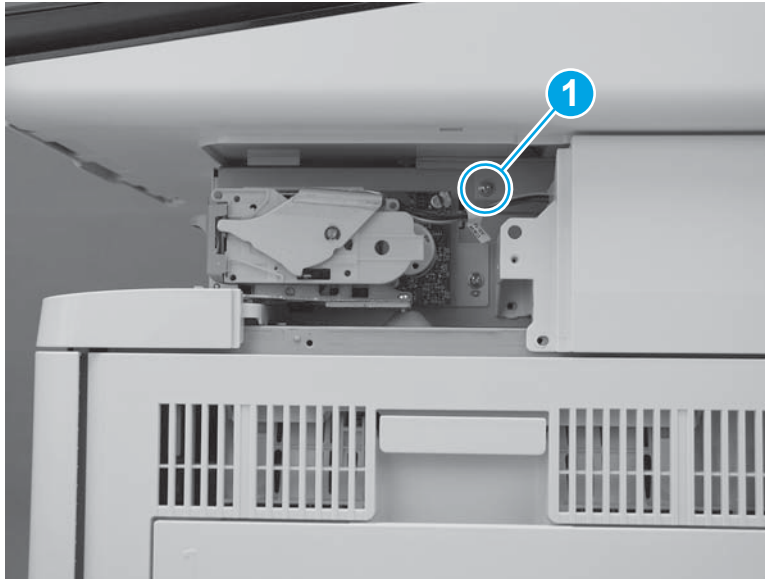

4. Disconnect two connectors on the scanner control board (callout 1).

M577c/f/z only: Disconnect one connector for the stapler on the scanner control board (callout 2).

Figure 1-2849 Disconnect connectors

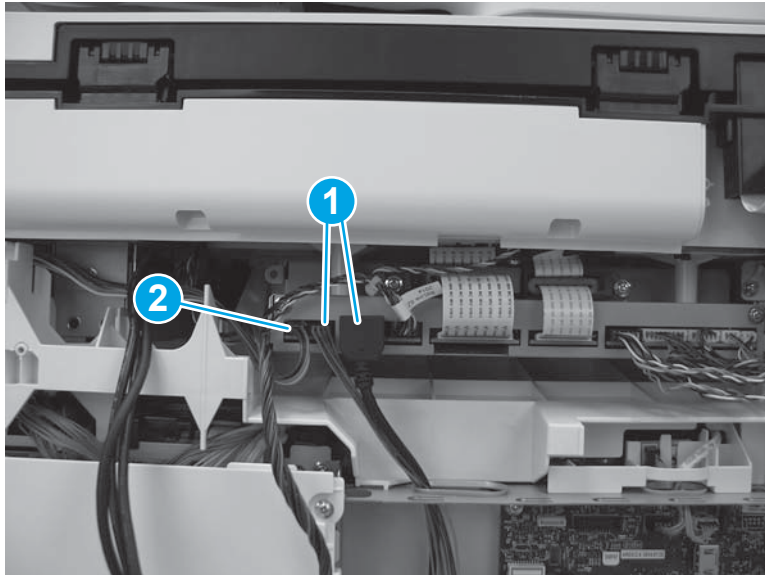

5. Slightly slide the ISA towards the back of the printer to release it.

Figure 1-2850 Slide the ISA towards the back of the printer

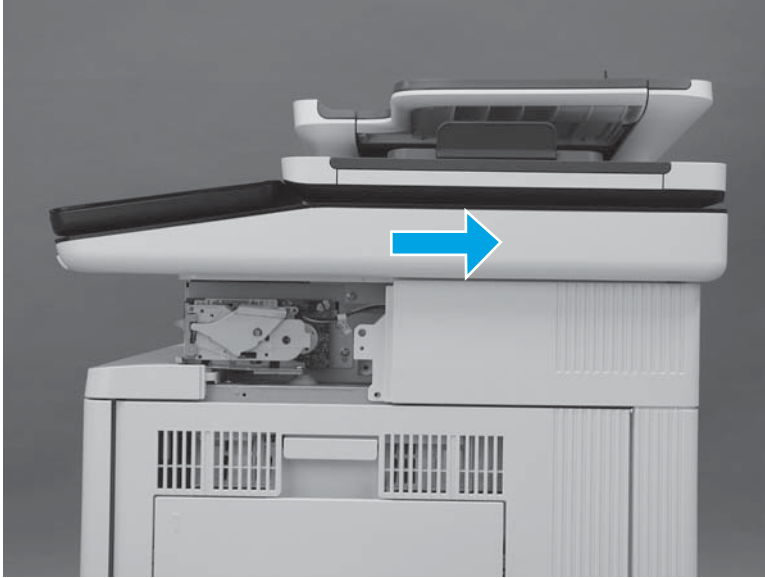

6. Lift the ISA up to remove it.



 **NOTE:** When lifting the ISA, carefully pass the cables through the opening in the top of the formatter case.

Figure 1-2851 Remove the ISA

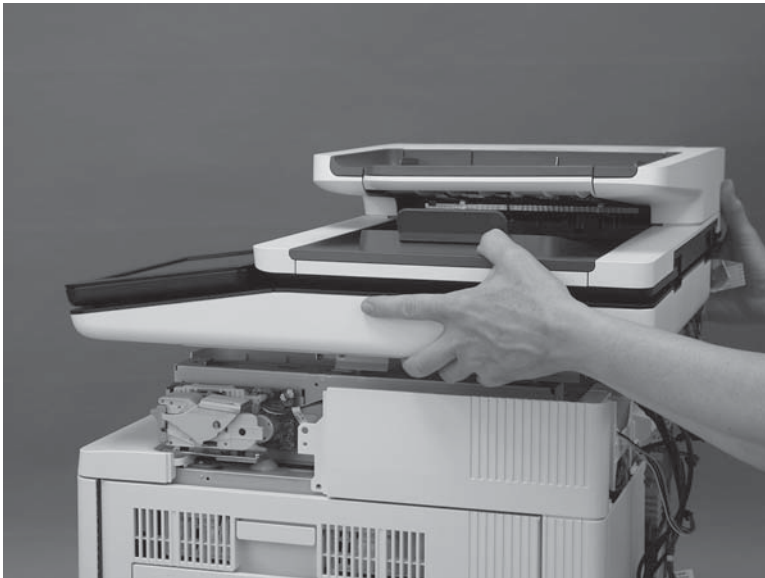

Step 17: Remove the right upper cover (M577)

 **NOTE:** This step is for the M577 models. For the M552 and M553 models, skip this step and go to [Step 19: Remove the left cover on page 1618](#).

 **NOTE:** The figures below show the image scanner installed. The procedures for removing and installing the right upper cover are the same whether the image scanner is installed or removed."

1. At the right side of the printer, remove two screws (callout 1).

M577c/f/z only: Disconnect one connector (callout 2), if it was not already disconnected in a previous step.

Figure 1-2852 Remove two screws and one connector

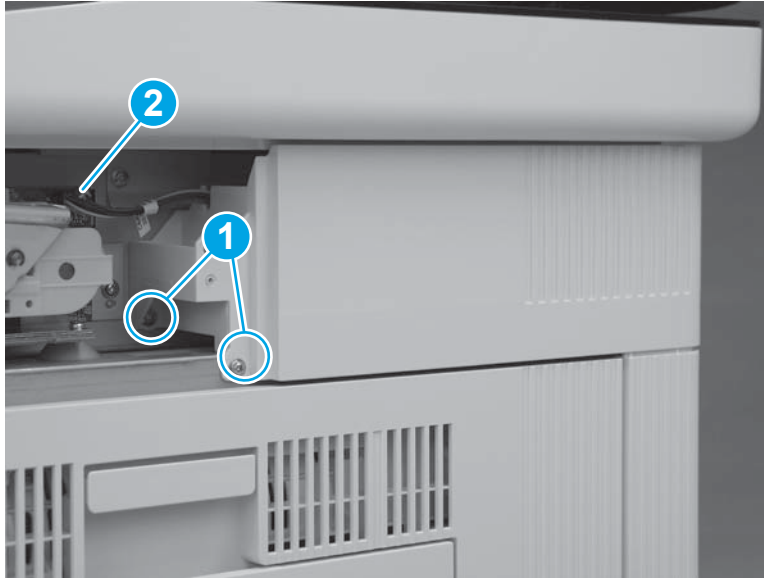

2. At the back of the printer, remove one screw (callout 1).

M577c/f/z only: Disconnect one connector (callout 2), if it was not already disconnected in a previous step.

 **Reinstallation tip:** This screw is smaller than the screws removed in the previous step. When reinstalling the right upper cover, make sure that this screw is installed in the correct position.

Figure 1-2853 Remove one screw and connector



3. Slide the cover toward the back of the printer.

Figure 1-2854 Slide the cover

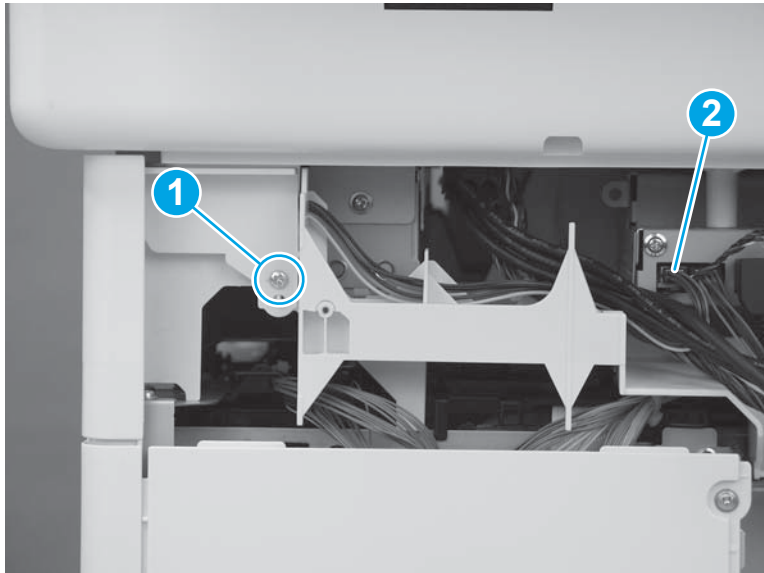
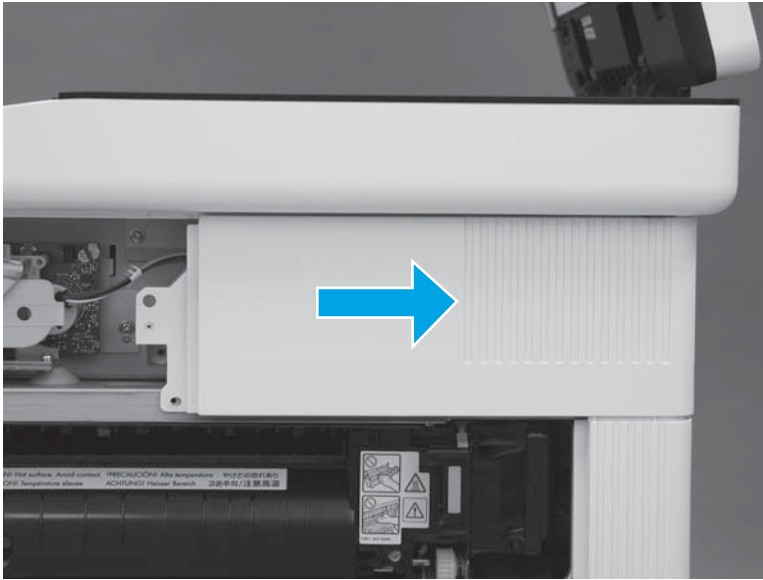

4. Lift the cover away from the printer to remove it.

M577c/f/z only: Release the cables (callout 1) through the slot (callout 2) in the printer.

Figure 1-2855 Remove the cover

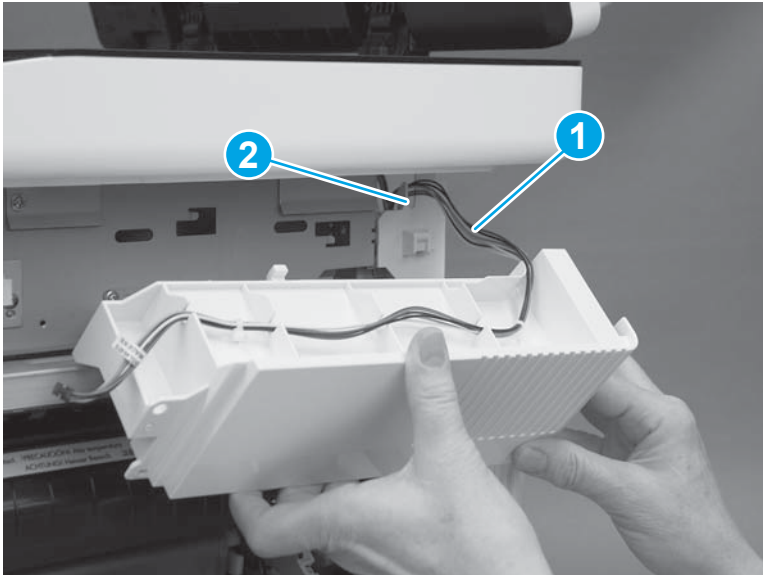

Step 18: Remove the top rear cover (M577)



NOTE: This step is for the M577 models. For the M552 and M553 models, skip this step and go to [Step 19: Remove the left cover on page 1618](#).

1. At the top of the printer, remove five screws (callout 1).

Figure 1-2856 Remove five screws

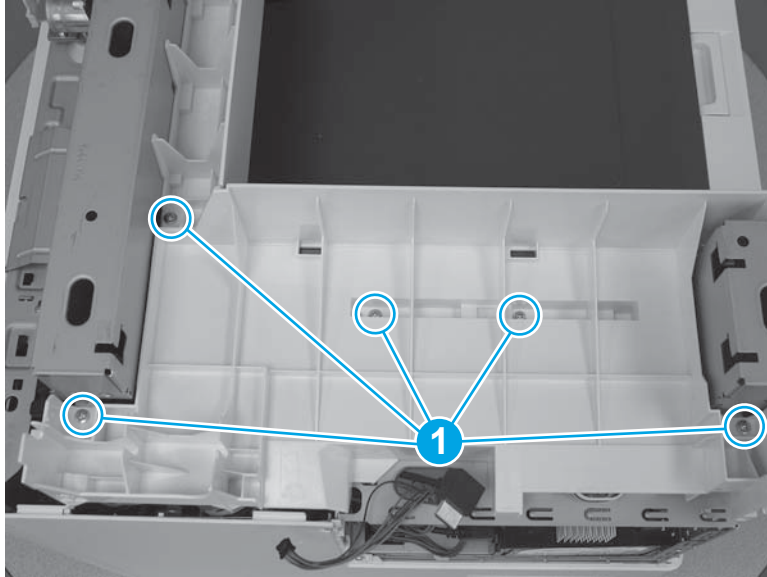

2. Release two tabs (callout 1) on the front edge of the cover.

Figure 1-2857 Release two tabs

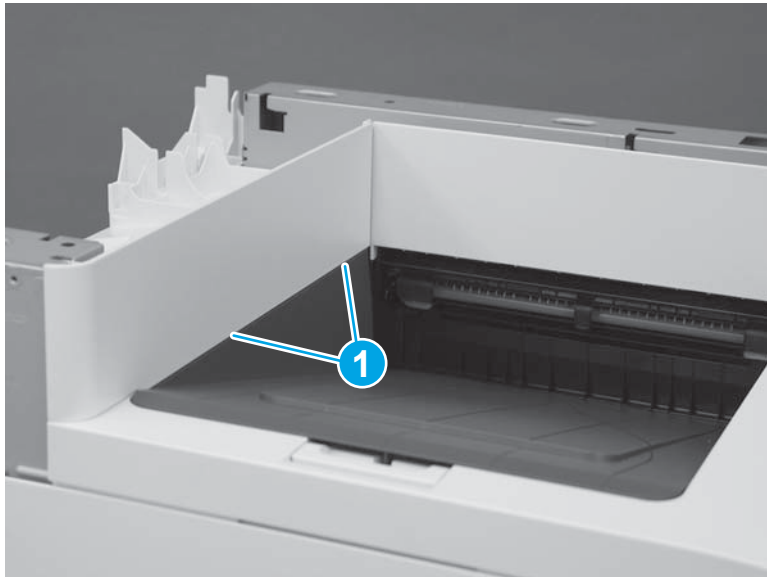

3. Remove the top rear cover.

Figure 1-2858 Remove the top rear cover

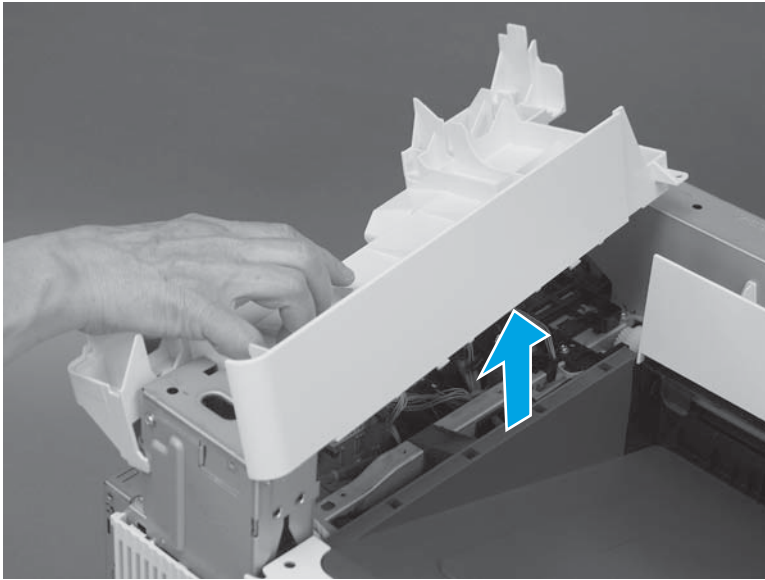

Step 19: Remove the left cover

1. At the left side of the printer, remove one screw (callout 1).

Figure 1-2859 Remove one screw



2. Release one tab (callout 1), rotate the front edge of the cover away from the printer (callout 2), and then slide the cover (callout 3) toward the rear of the printer to release it.

Figure 1-2860 Release the cover

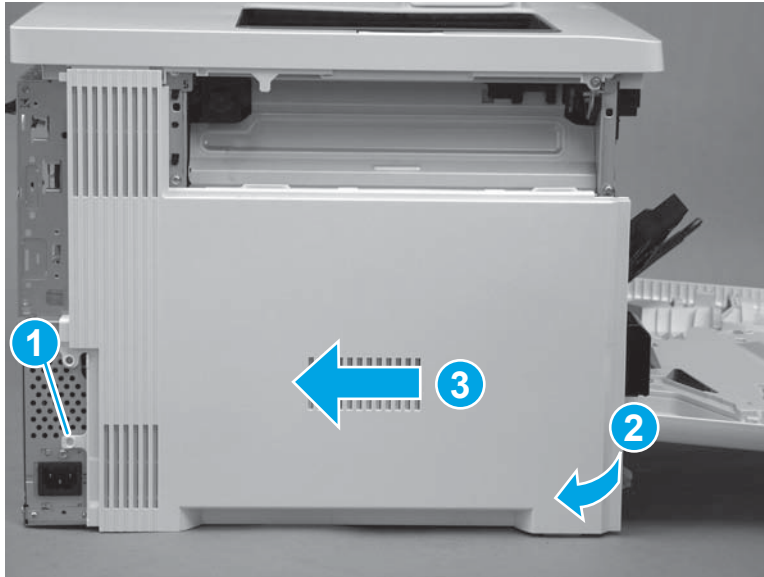

3. Remove the cover.

Figure 1-2861 Remove the cover

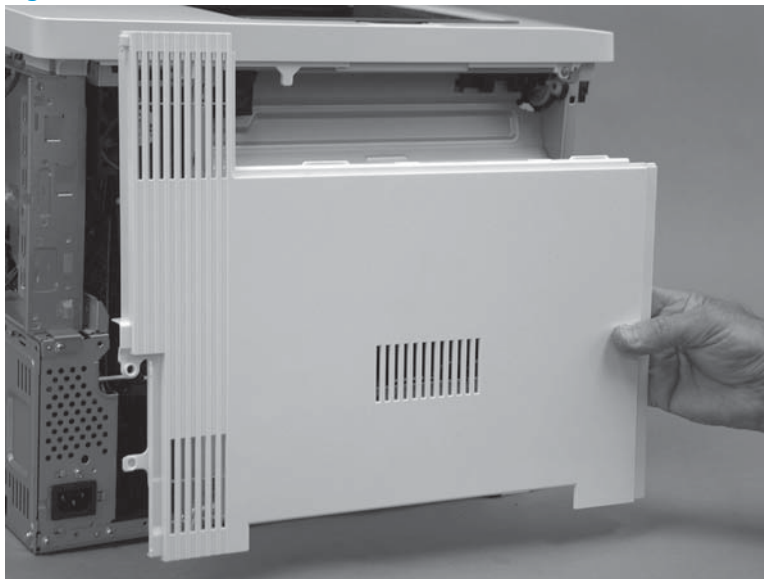

Step 20: Remove the upper cover (M552 and M553)

 **NOTE:** This step is for the M552 and M553 models. For the M577 models, skip this step and go to [Step 21: Remove the formatter case on page 1621.](#)

1. Remove three screws (callout 1).

Figure 1-2862 Remove three screws

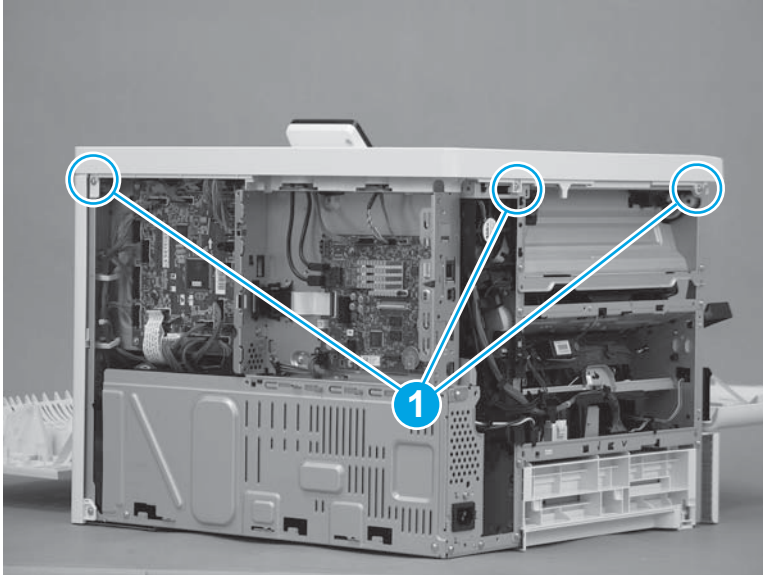

2. Remove one screw (callout 1), release one tab (callout 2), and then slightly separate the corner of the cover from the chassis.

 **NOTE:** This is a self-tapping plastic-thread screw. Make sure that this screw is used in this location when it is reinstalled.

Figure 1-2863 Remove one screw and release one tab



3. Release one tab (callout 1), and then lift up on the cover to release it.

 **NOTE:** If the cover does not release, check for additional tabs by locating the triangles embossed in the cover at tab locations.

Figure 1-2864 Release the cover



4. Remove the cover.

Figure 1-2865 Remove the cover

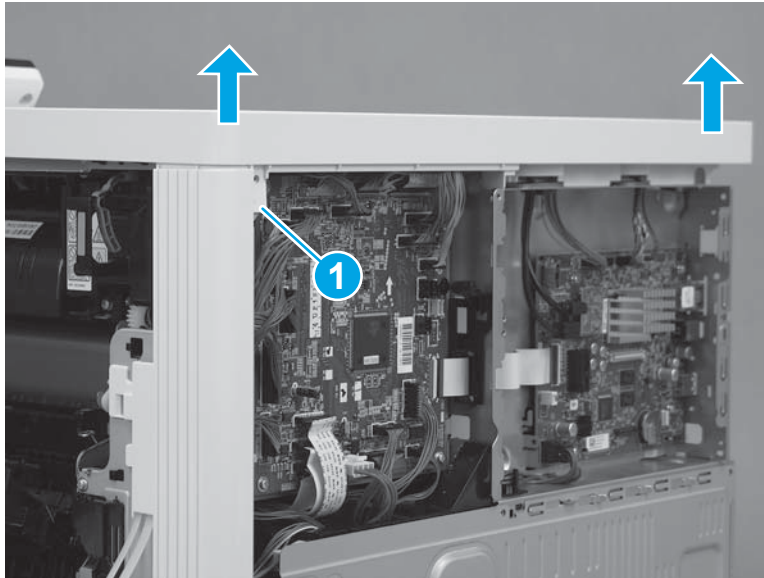
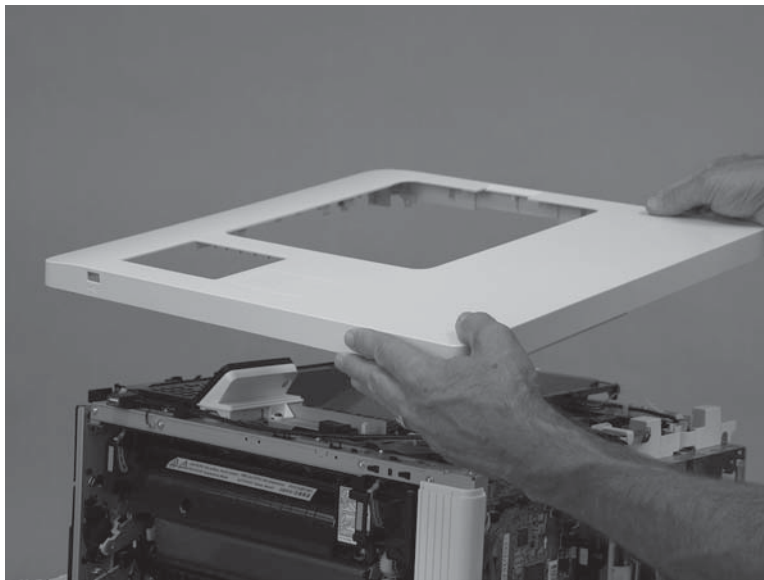

Step 21: Remove the formatter case

1. **M577 only:** Disconnect one connector (callout 1), and then pass the wire harness (callout 2) through two openings in the formatter case (callout 3).

Figure 1-2866 Disconnect one connector

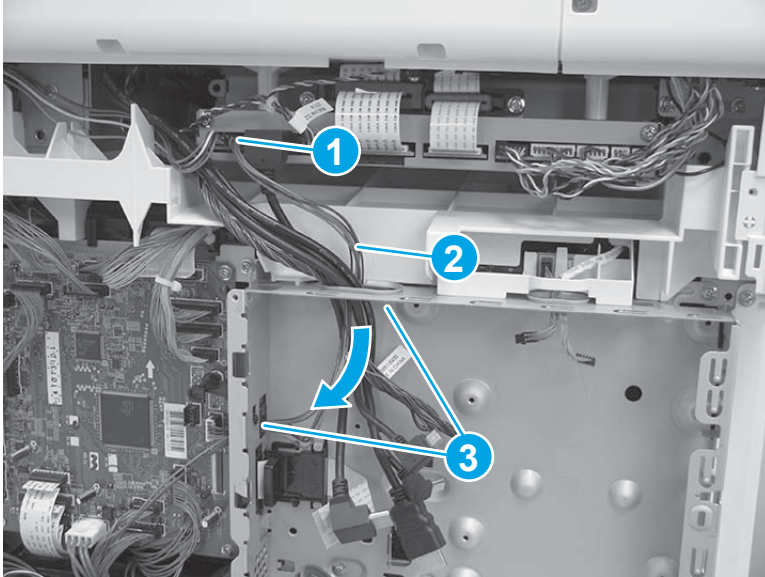

2. Release two tabs (callout 1) on the black plastic bracket. Hold the tabs in the released position, and then slide the bracket (callout 2) to the right to remove it from the formatter case.

Figure 1-2867 Remove the bracket

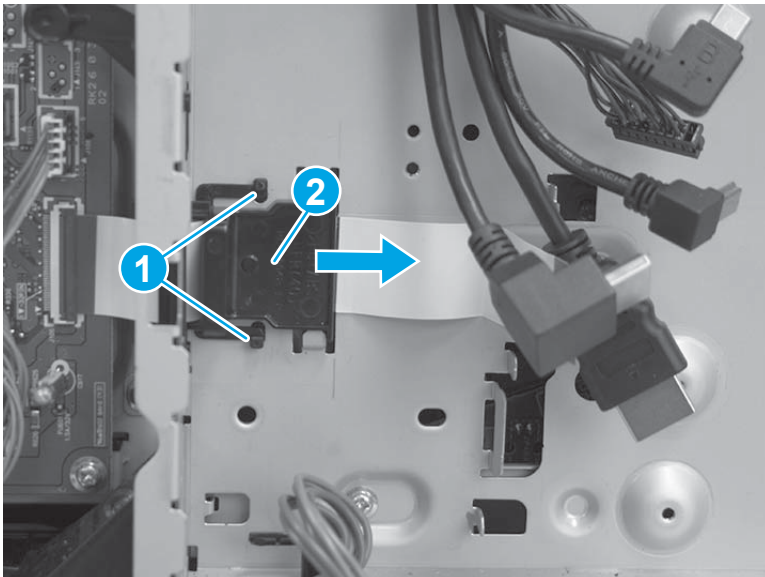

3. Remove two screws (callout 1), and then slide the low-voltage power supply (LVPS) cover to the right to remove it.

Figure 1-2868 Remove the LVPS cover

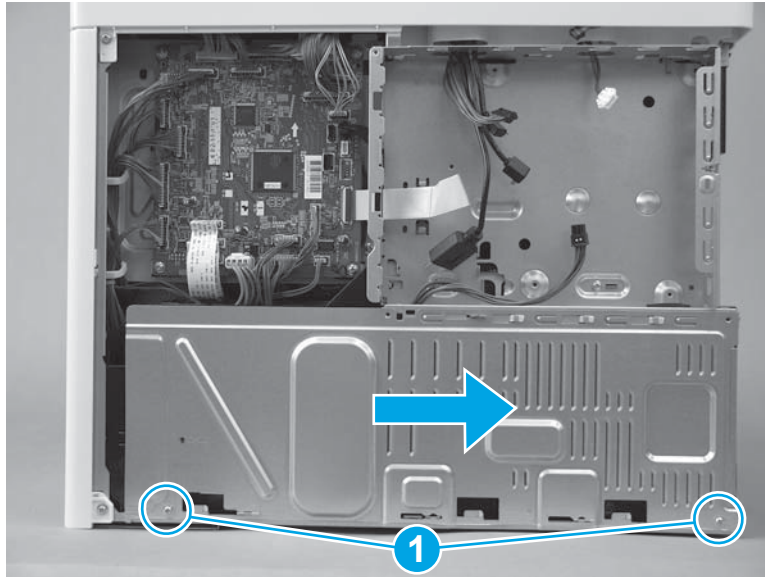

4. Pass two wire harnesses and one flat cable (callout 1) through the opening in the formatter case, and then release one wire harness from the retainer (callout 2).

CAUTION: The flat cable might be attached to the formatter case with double-sided tape. Make sure that this tape is released, so that the flat cable is not damaged when the formatter case is removed.

Figure 1-2869 Release wire harnesses and flat cable

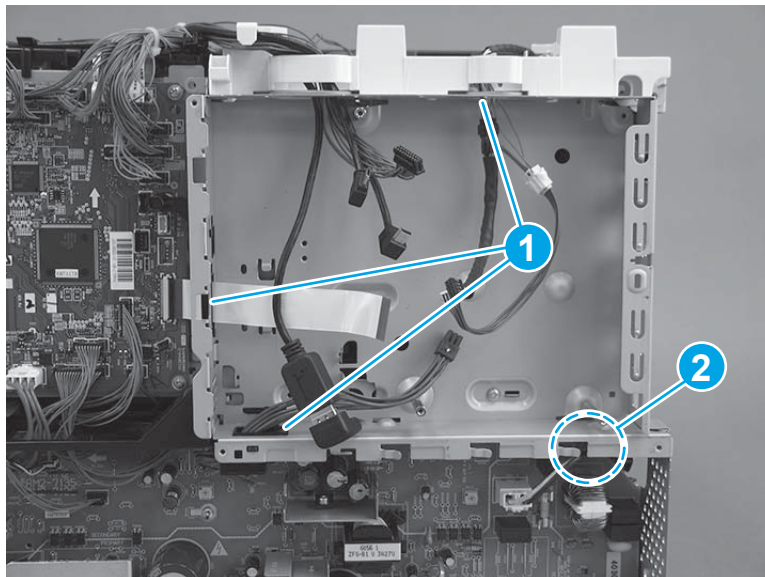

5. Remove six screws (callout 1).

Figure 1-2870 Remove six screws

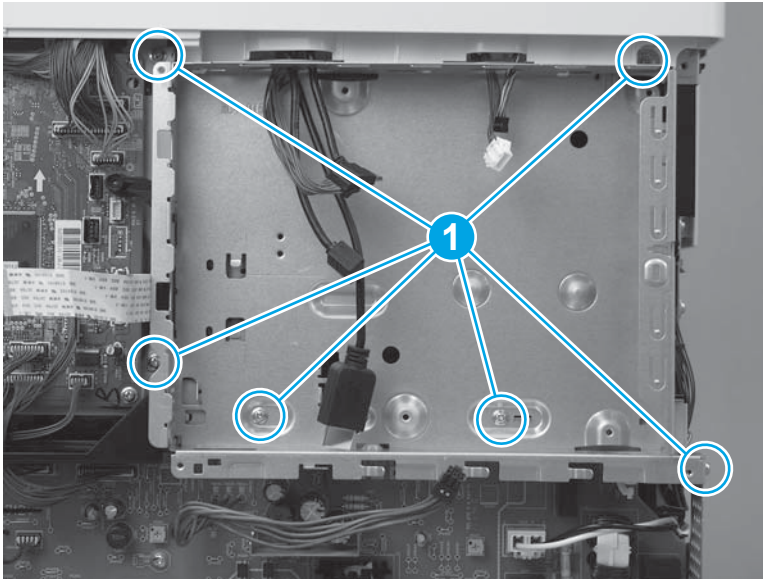

6. Rotate the bottom of the formatter case away from the printer (callout 1), and then pull it down (callout 2) to release it.

Figure 1-2871 Release the formatter case

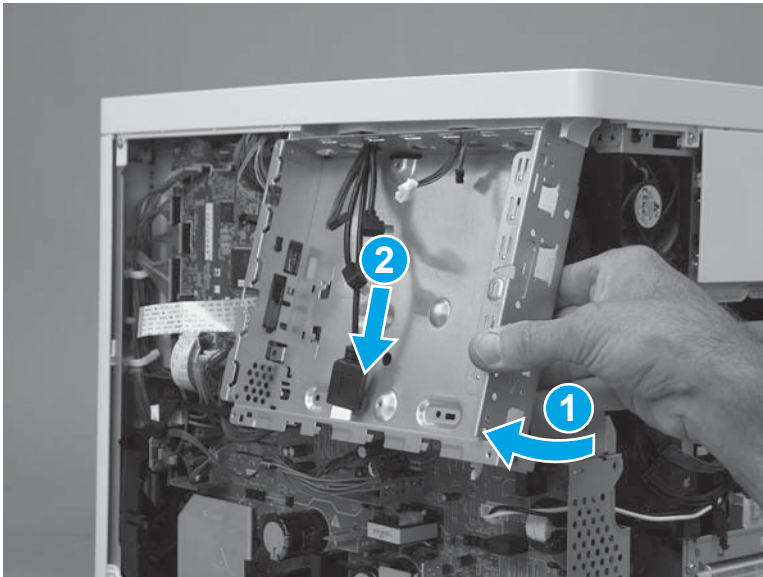

7. Pass the wire harnesses through the opening in the formatter case to remove it.

 **IMPORTANT:** If the formatter case is removed so that it can be replaced, make sure to transfer the memory PCA (island of data) and plastic bracket (callout 1) to the replacement case.

Figure 1-2872 Remove the formatter case



Step 22: Remove the right rear cover

1. Remove one screw (callout 1), and then slide the cover toward the rear of the printer (callout 2) to release it.

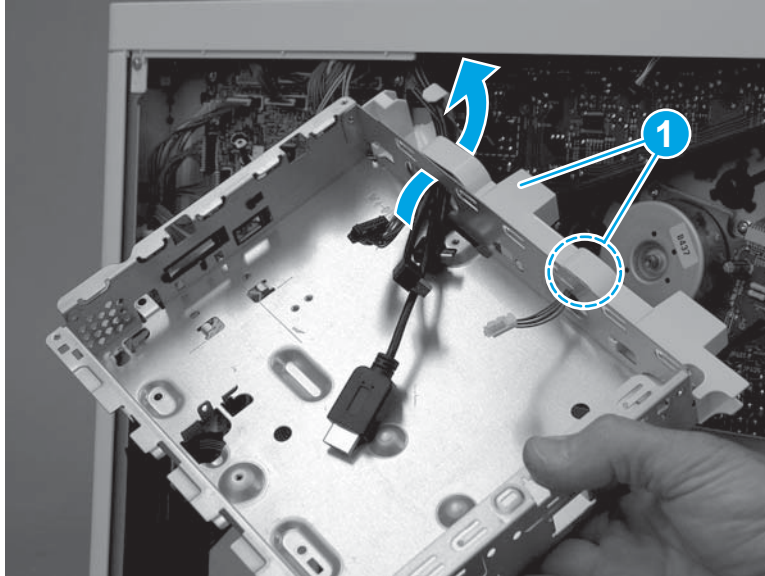
 **TIP:** If the right door is closed, open it now.

Figure 1-2873 Release the cover



2. Remove the cover.

Figure 1-2874 Remove the cover

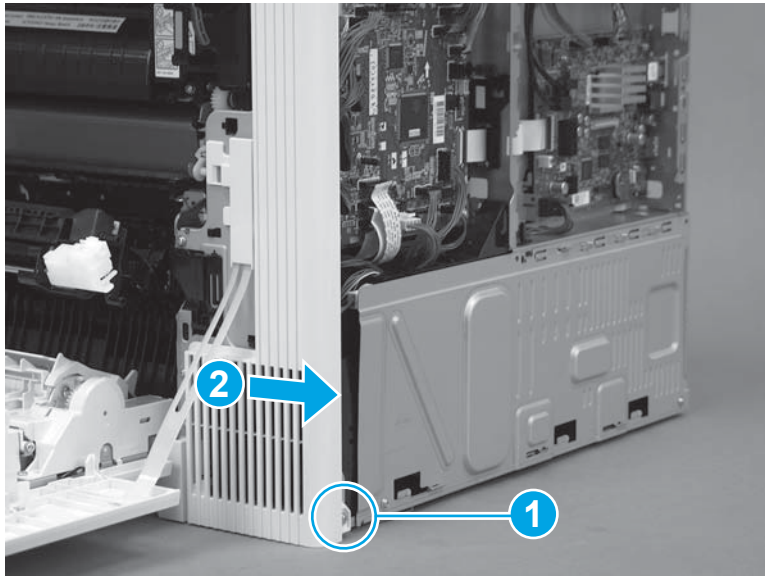
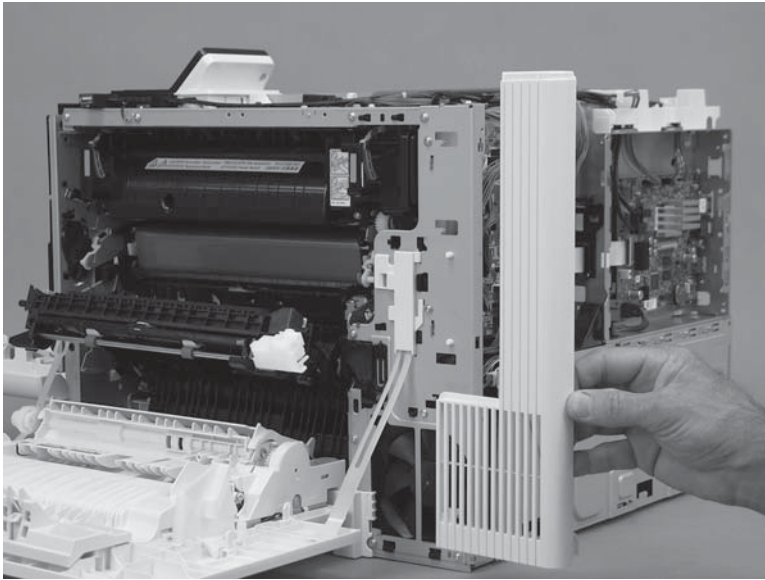

Step 23: Remove the DC controller and sheet-metal bracket

 **CAUTION:**  ESD sensitive part.

1. Disconnect all of the connectors, and then remove two screws (callout 1).

The following connectors are empty:

- J140, J141, and J143

Figure 1-2875 Remove two screws

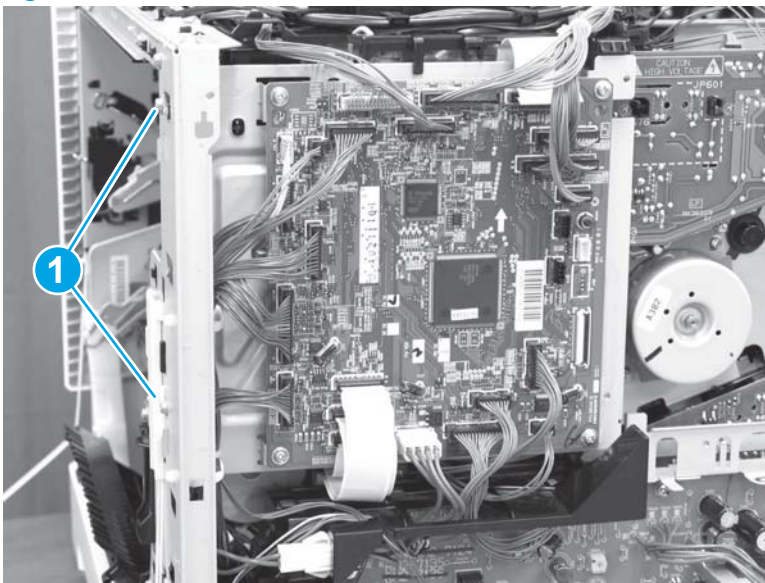

2. Lift up on the DC controller and sheet-metal plate to remove it.

Figure 1-2876 Remove the plate

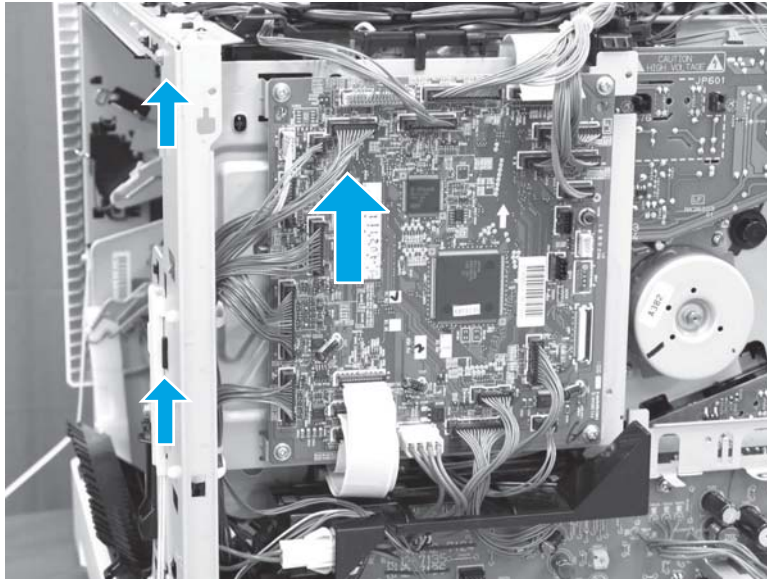

Step 24: Remove the high-voltage power supply T (HVPST)

CAUTION:  ESD-sensitive part.

1. Disconnect five connectors (callout 1), and then disconnect one flat cable (callout 2).

Figure 1-2877 Disconnect five connectors and one flat cable

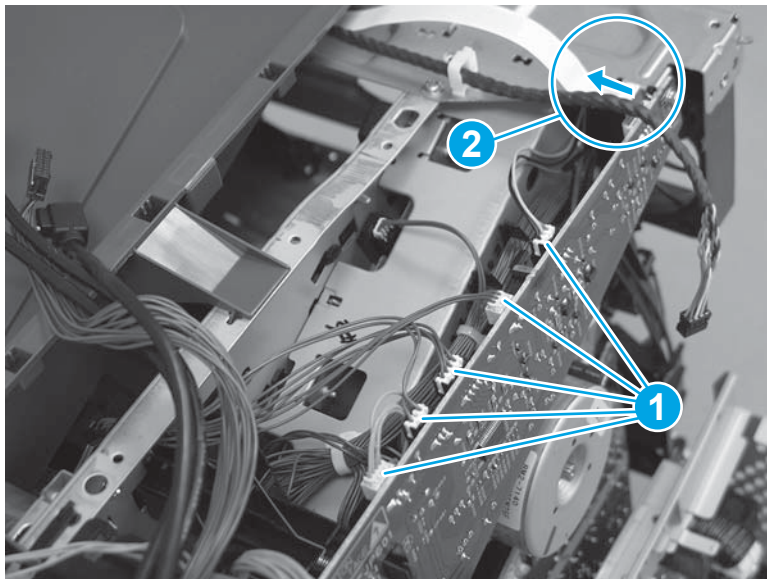

2. Remove one screw (callout 1).

Figure 1-2878 Remove one screw

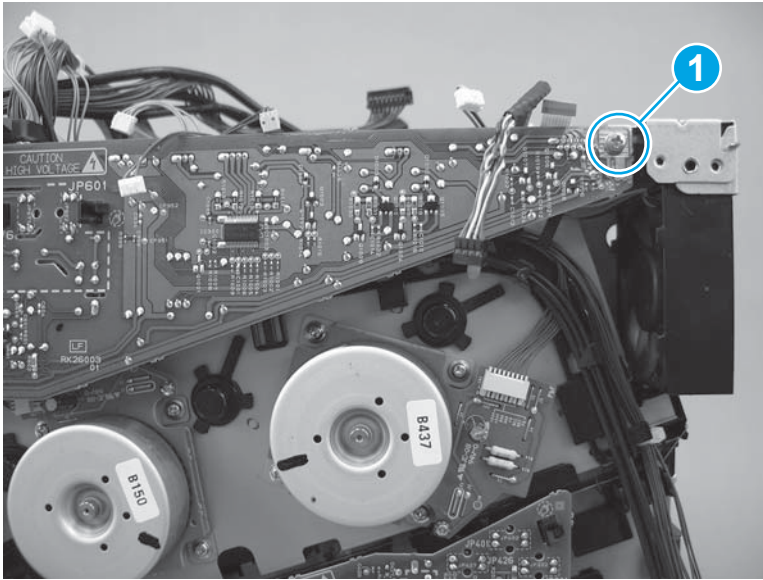

3. Release two tabs (callout 1), and then separate the HVPST from the printer.

⚠ CAUTION: Do not attempt to completely remove the HVPST. It is still connected to the printer by ground wire harness.

Figure 1-2879 Release the HVPST

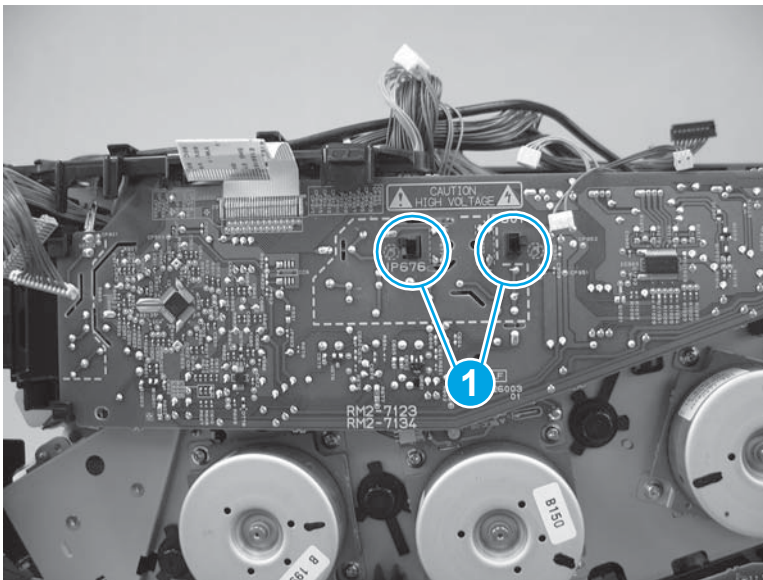

4. Release one ground wire connector (callout 1), and then remove the HVPST.

Figure 1-2880 Remove the HVPST

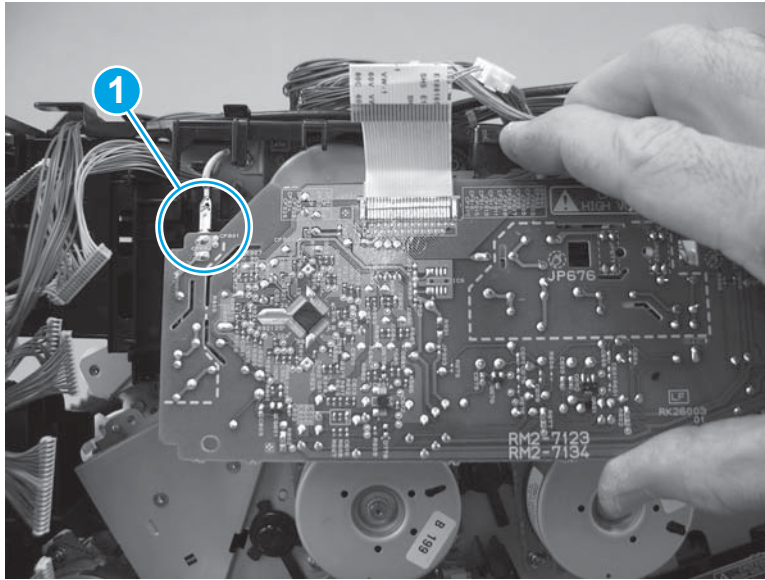

Step 25: Remove drum motor 3 (M3)

- ▲ Disconnect one connector (callout 1), remove four screws (callout 2), and then remove the motor.

Figure 1-2881 Remove the motor

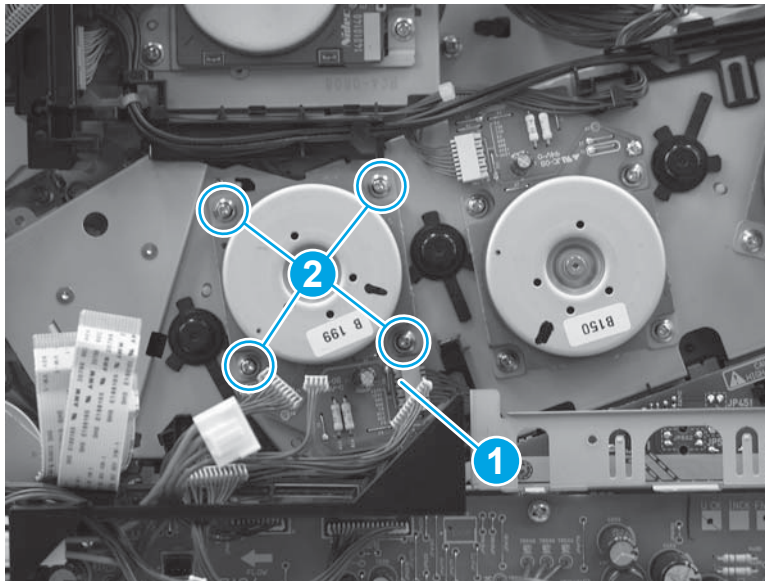

Step 26: Unpack the replacement assembly

Unpack the replacement assembly from the packaging.

For complete information on HP's recycling programs, go to [Product return and recycling](#).

 **NOTE:** HP recommends responsible disposal of the defective assembly.

Figure 1-2882 Recycle and unpack

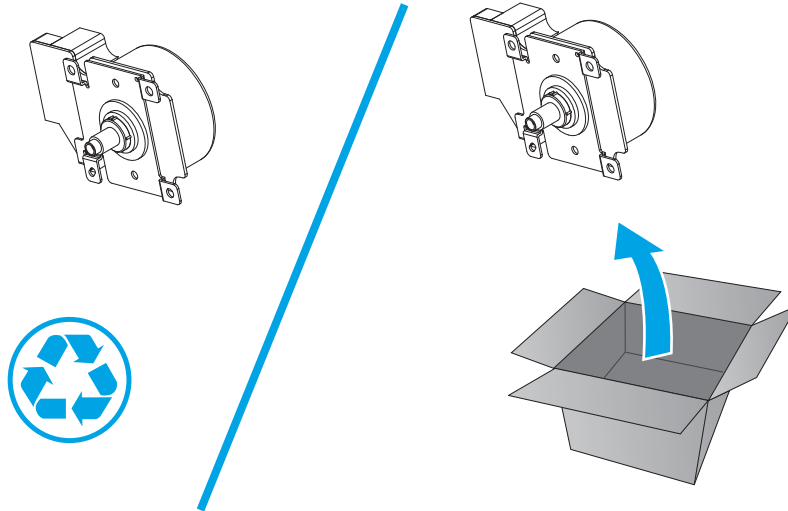

Step 27: Install drum motor 3 (M3)

- ▲ Position the motor on the printer, install four screws (callout 1), and then connect one connector (callout 2).

Figure 1-2883 Install the motor

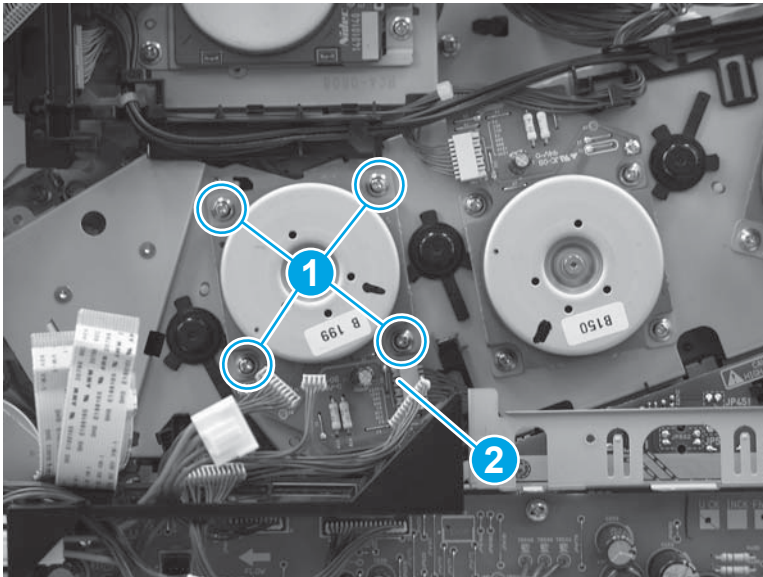

Step 28: Install the HVPST

⚠ **CAUTION:**  ESD-sensitive part.

1. Connect one ground wire connector (callout 1).

Figure 1-2884 Connect one ground wire

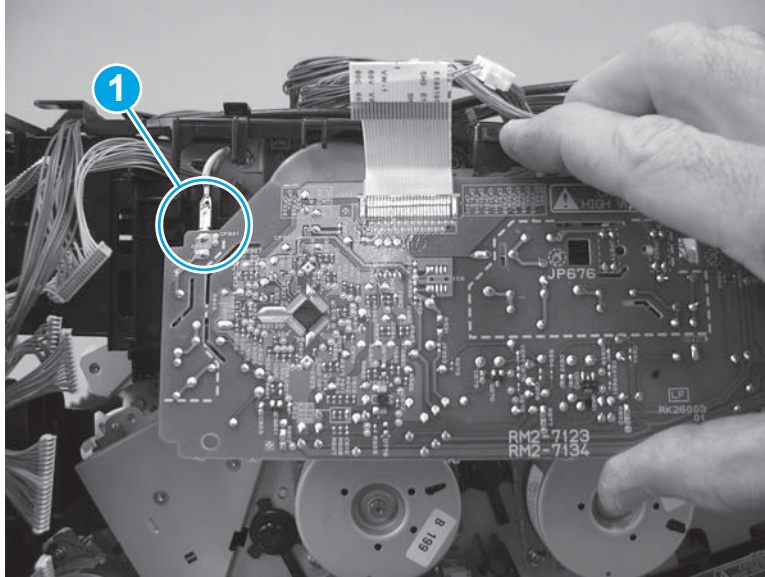

2. Position the HVPST on the printer, and then push in to engage two tabs (callout 1).

 **NOTE:** Make sure that the tabs snap into place.

Figure 1-2885 Install the HVPST

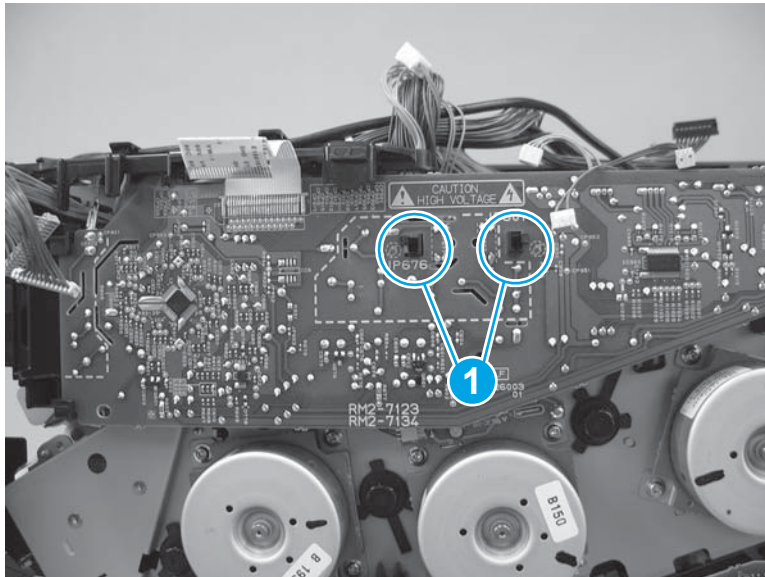

3. Install one screw (callout 1).

Figure 1-2886 Install one screw

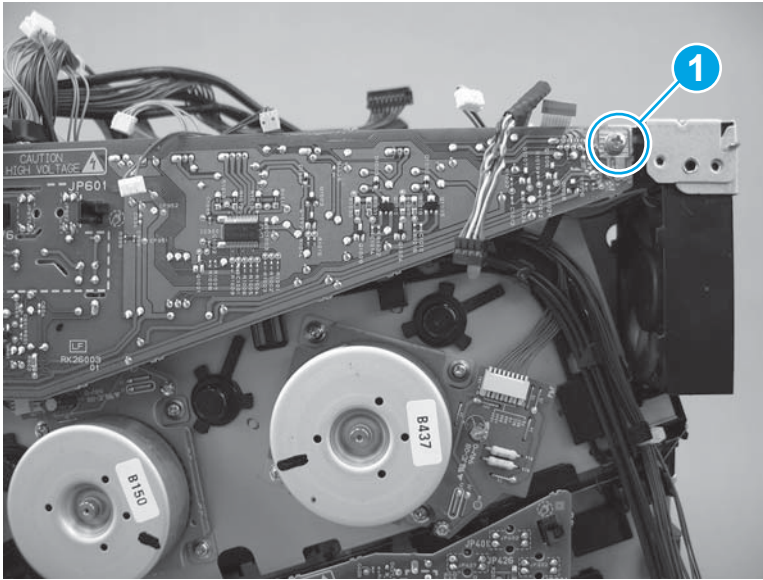

4. Connect five connectors (callout 1), and then connect one flat cable (callout 2).

Figure 1-2887 Connect five connectors and one flat cable

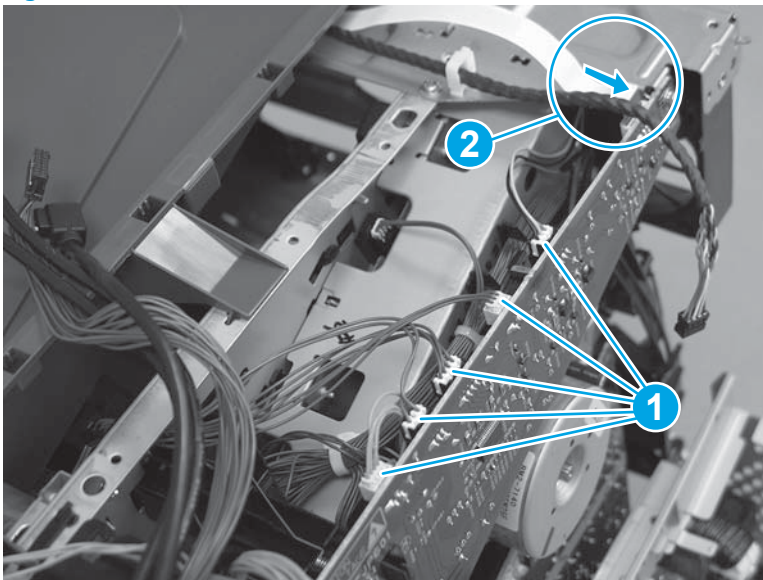

Step 29: Install the DC controller and sheet-metal bracket

 **CAUTION:**  ESD-sensitive part.

1. Position the DC controller and sheet-metal plate on the printer, and then push down to engage the plate with the chassis.

Figure 1-2888 Install the plate

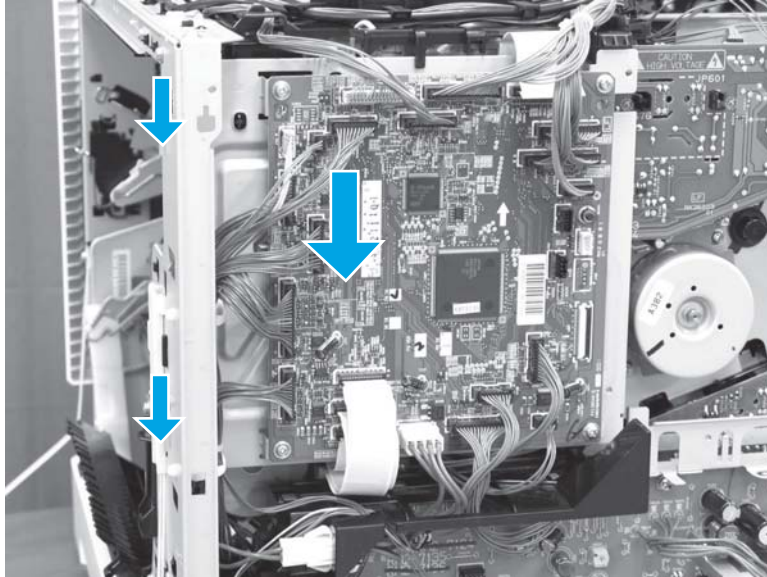

2. Install two screws (callout 1), and then connect all of the connectors.

The following connectors are empty:

- J140, J141, and J143

Figure 1-2889 Install two screws

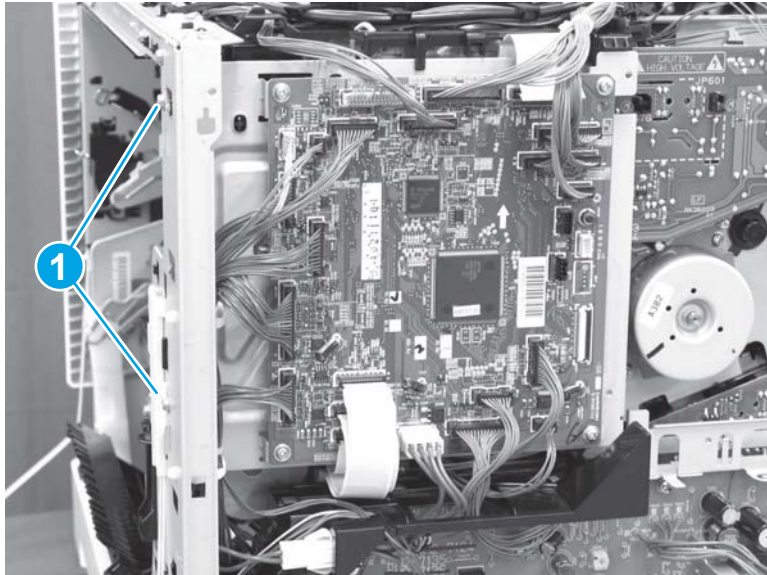

Step 30: Install the right rear cover

1. Position the cover on the printer.

Figure 1-2890 Install the cover

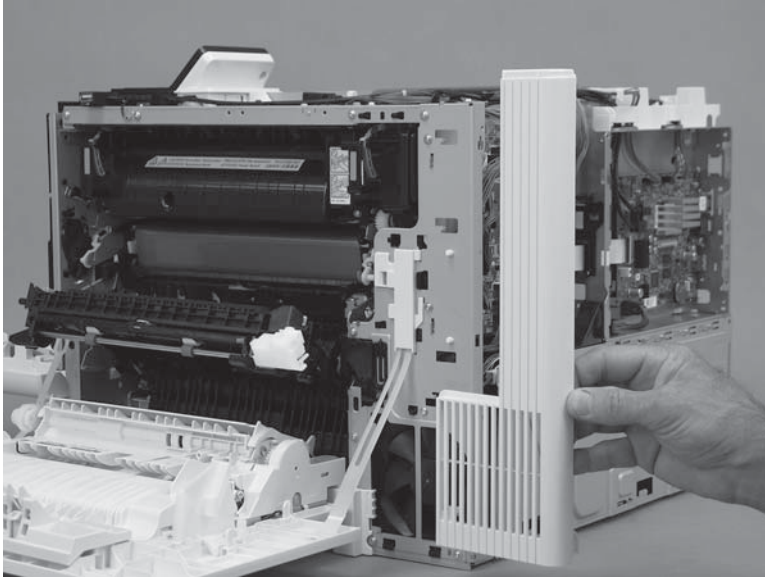

2. Slide the cover toward the right door (callout 1) to engage it with the printer, and then install one screw (callout 2).

Figure 1-2891 Install one screw

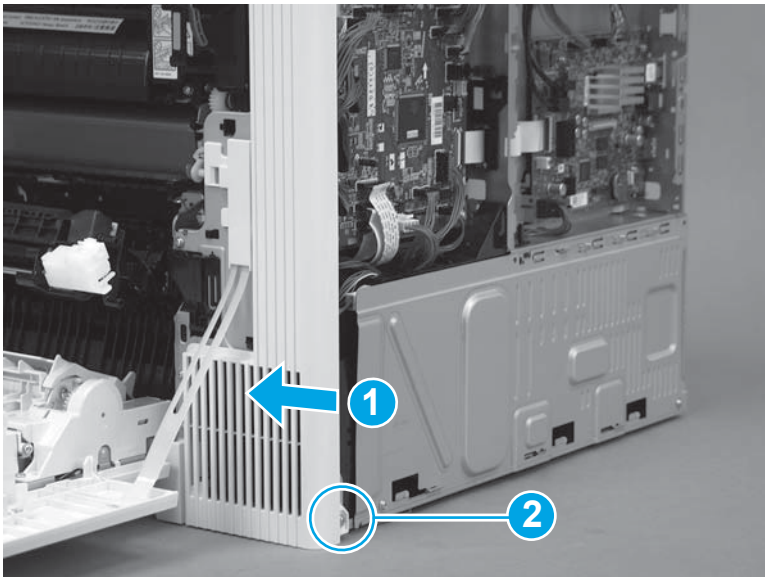

Step 31: Install the formatter case

1. Pass the wire harnesses through the opening in the formatter case.

Figure 1-2892 Pass the wire harnesses through the opening

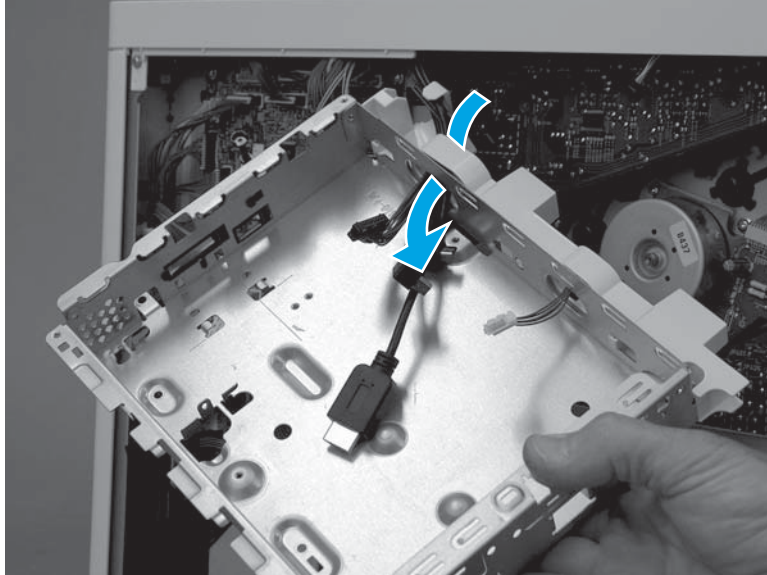

2. Position the top of the formatter case on the printer (callout 1), and then rotate the bottom of the case (callout 2) into the printer.

Figure 1-2893 Install the formatter case

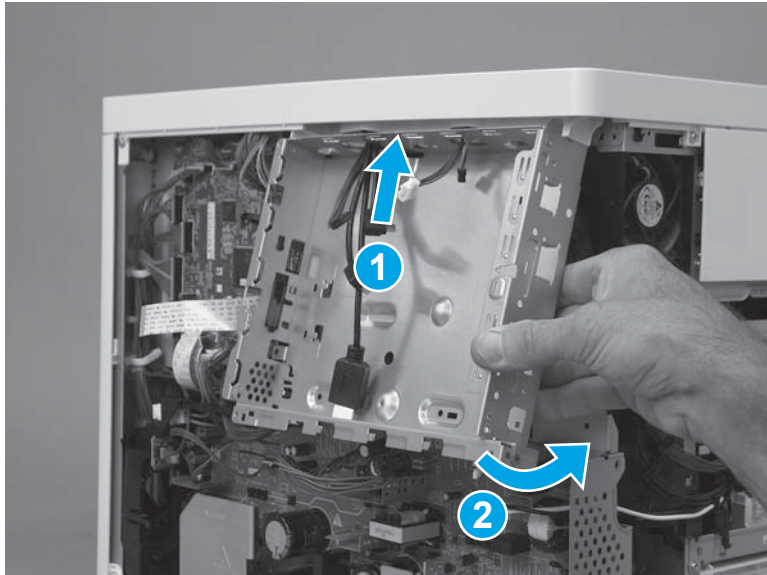

3. Install six screws (callout 1).

Figure 1-2894 Install six screws

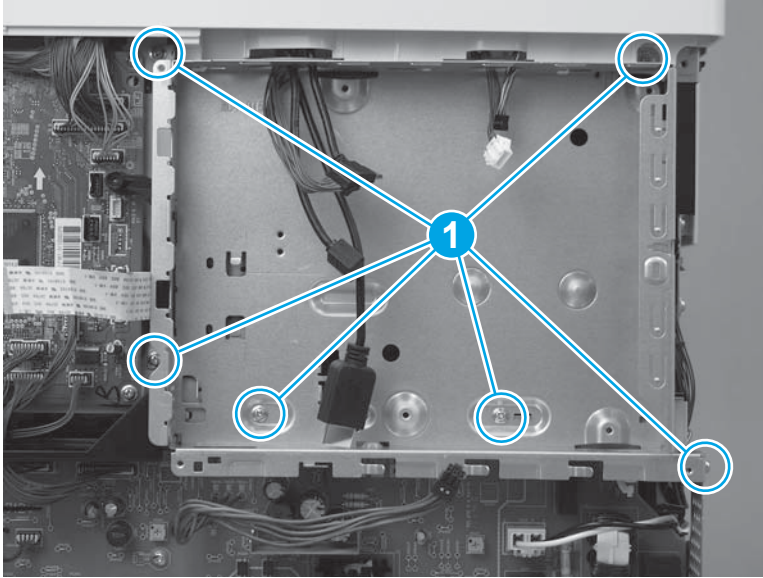

4. Pass two wire harnesses and one flat cable (callout 1) through the opening in the formatter case, and then install one wire harness in the retainer (callout 2).

 **IMPORTANT:** Make sure that the flat cable is securely fastened to the DC controller, and was not dislodged when the formatter case was removed.

Figure 1-2895 Install wire harnesses and flat cable



5. Position the LVPS cover on the printer, slide the cover to the left to install it, and then install two screws (callout 1).

Figure 1-2896 Install the LVPS cover

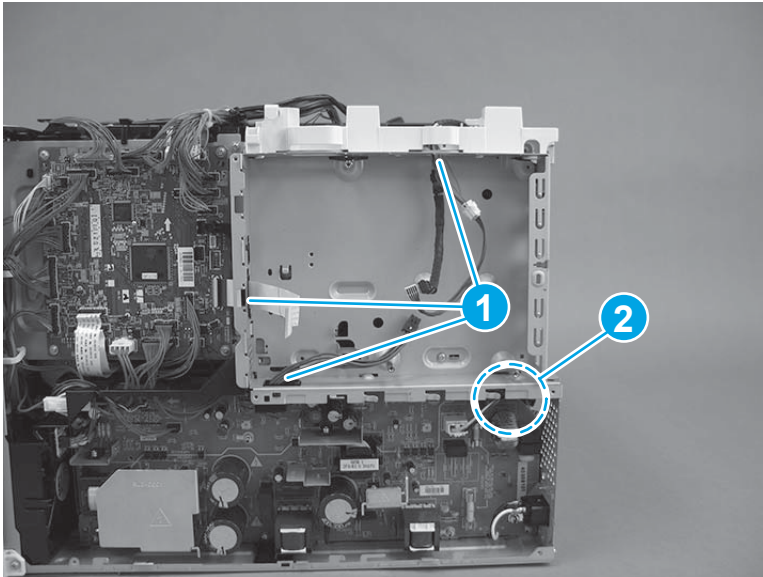
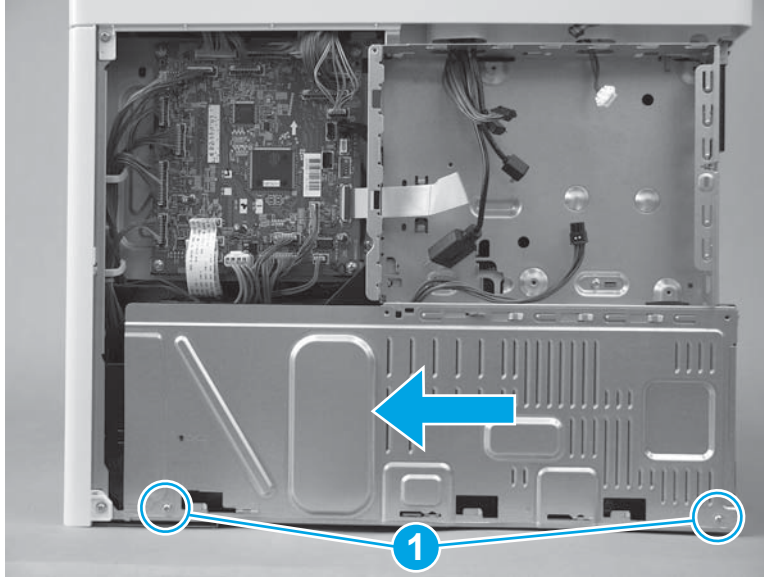

6. If no tape is affixed to the back of the flat cable, skip this step. If double-sided tape is affixed to the back of the flat cable, align the line (callout 1) on the cable with the edge (callout 2) of the opening in the sheet metal. Press to attach the flat cable to the formatter case.

Figure 1-2897 Attach the flat cable

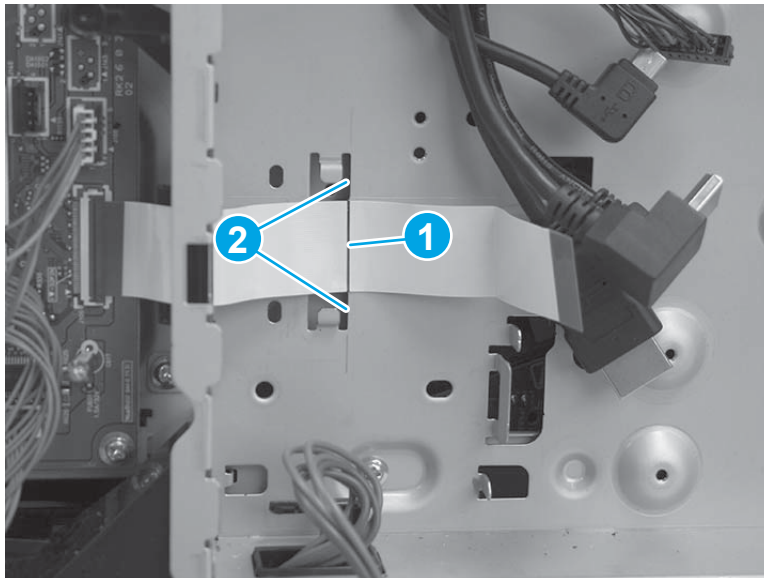

7. Position the bracket over the flat cable, and then slide the bracket to the left to install it. Make sure that the edges of the bracket fit under the sheet metal tabs (callout 1) on the formatter case and that the tabs (callout 2) snap into place.

Figure 1-2898 Position the bracket

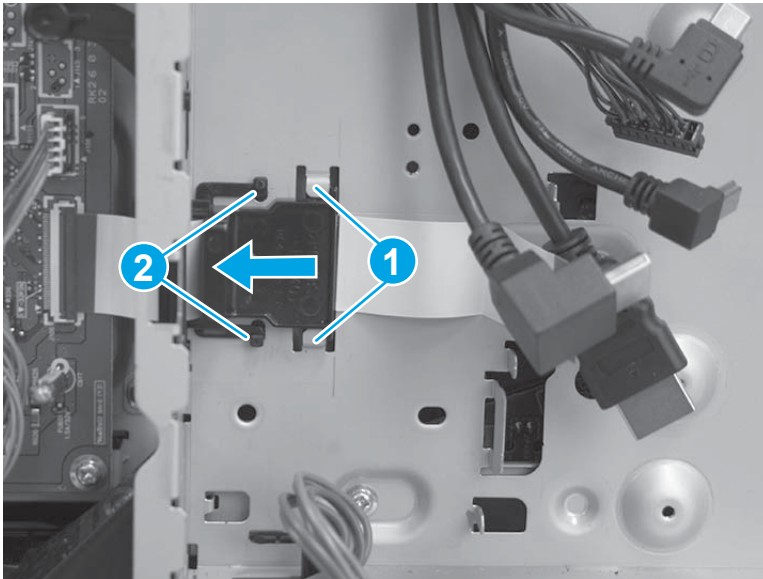

8. **M577 only:** Pass the wire harness (callout 1) through the openings in the formatter case (callout 2), and then connect one connector (callout 3).

Figure 1-2899 Connect one connector

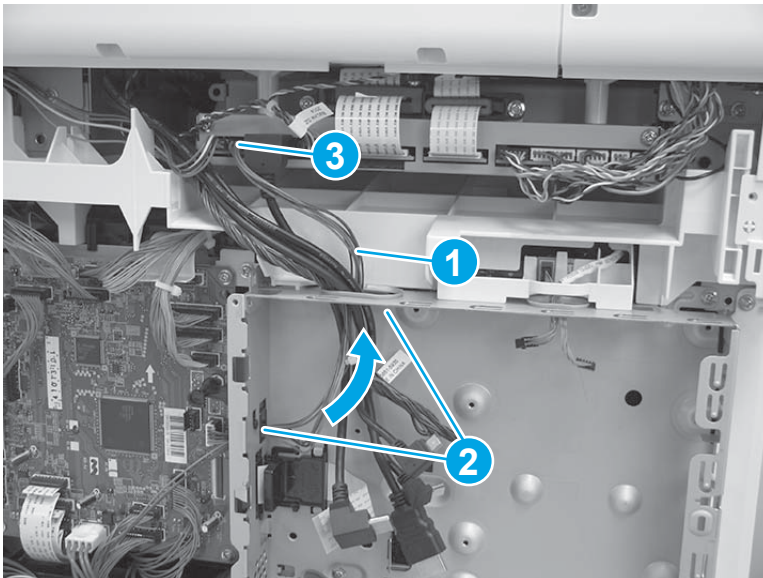

Step 32: Install the upper cover (M552 and M553)



NOTE: This step is for the M552 and M553 models. For the M577 models, skip this step and go to [Step 33: Install the left cover on page 1640](#).

1. Position the cover on the printer.

 **NOTE:** For the M553x model, do not forget to pass the control-panel wire harness and USB cable through the opening in the cover.

Figure 1-2900 Install the cover



2. Push down on the rear corner of the cover to engage one tab (callout 1).

Figure 1-2901 Engage one tab

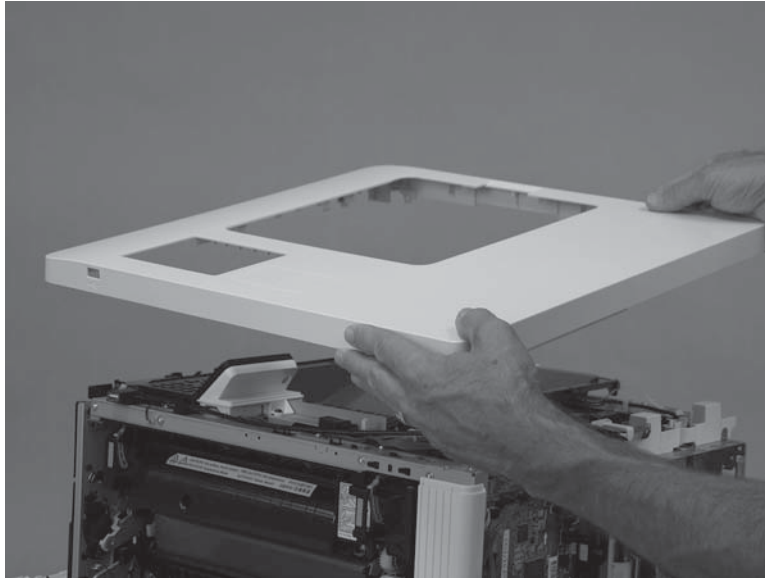
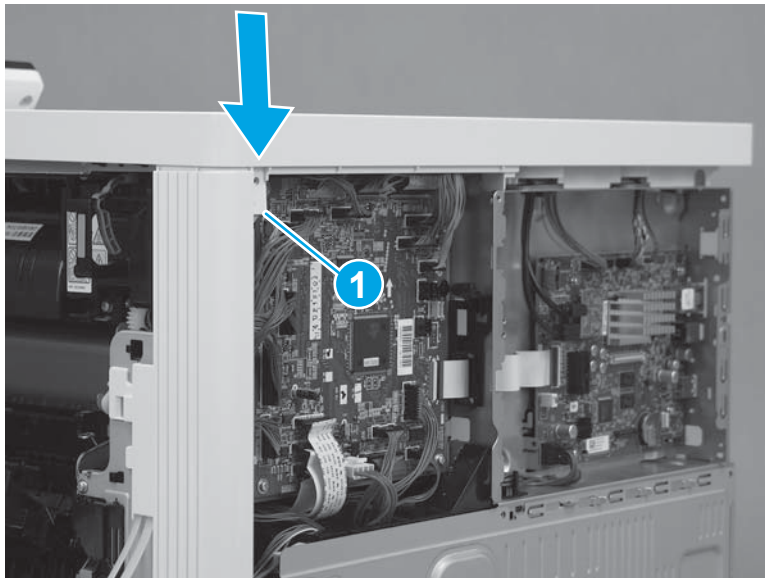

3. Push down on the front corner of the cover to engage one tab (callout 1), and then install one screw (callout 2).

 **NOTE:** This is a self-tapping plastic-thread screw. Make sure that this screw is used in this location when it is reinstalled.

Figure 1-2902 Engage one tab and install one screw



4. Install three screws (callout 1).

Figure 1-2903 Install three screws

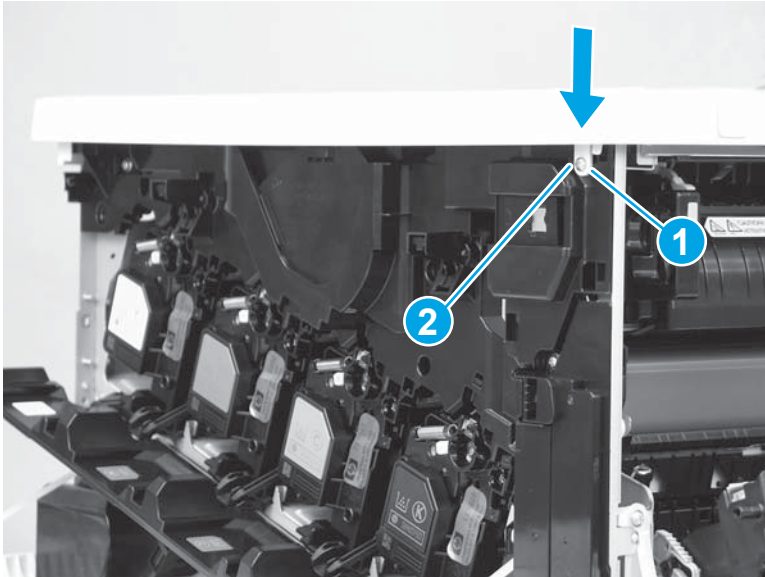
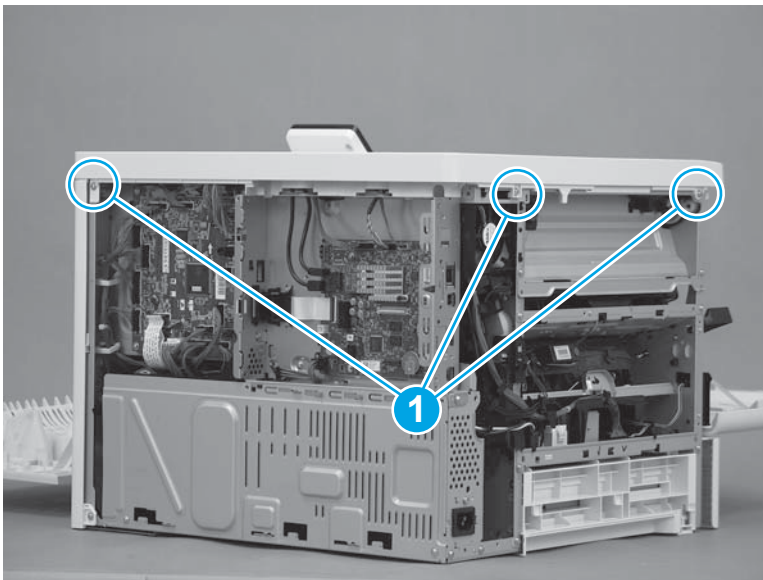

Step 33: Install the left cover

1. Position the cover on the printer.

 **NOTE:** Slightly offset the cover toward the rear of the printer.

Figure 1-2904 Install the cover

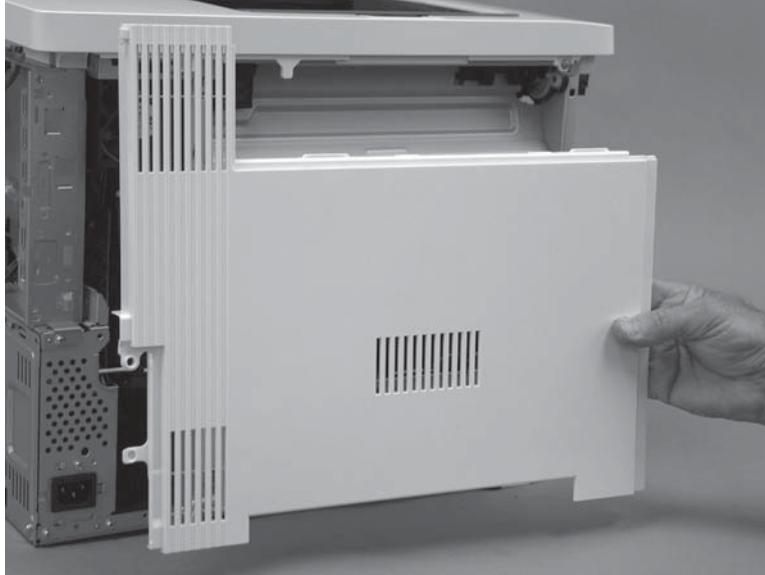

2. Slide the cover (callout 1) toward the front of the printer to engage it. Make sure that the tab (callout 2) snaps into place.

 **NOTE:** Locate the alignment pin (callout 3) on the cover from the front door side of the printer, and then make sure that it is fully engaged in the slot in the chassis.

 **TIP:** While sliding the cover into place, push in on the center of the cover (callout 1) to make sure that the hooks on the back of the cover engage with the slots in the chassis.

Figure 1-2905 Engage the cover



3. At the left side of the printer, install one screw (callout 1).

Figure 1-2906 Install one screw

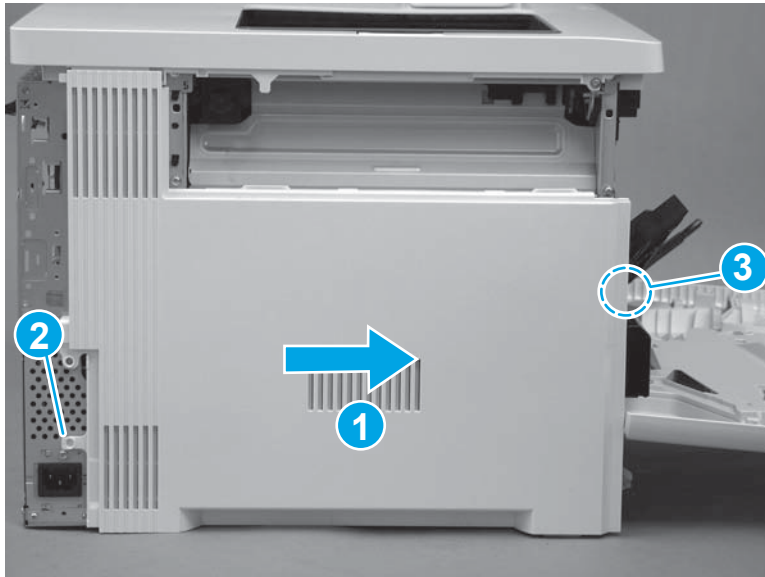

Step 34: Install the top rear cover (M577)



NOTE: This step is for the M577 models. For the M552 and M553 models, skip this step and go to [Step 42: Install the rear cover \(M552 and M553\) on page 1658](#).

1. Align the locator tabs (callout 1) on the cover with the slots (callout 2) in the printer.

Figure 1-2907 Align the locator tabs

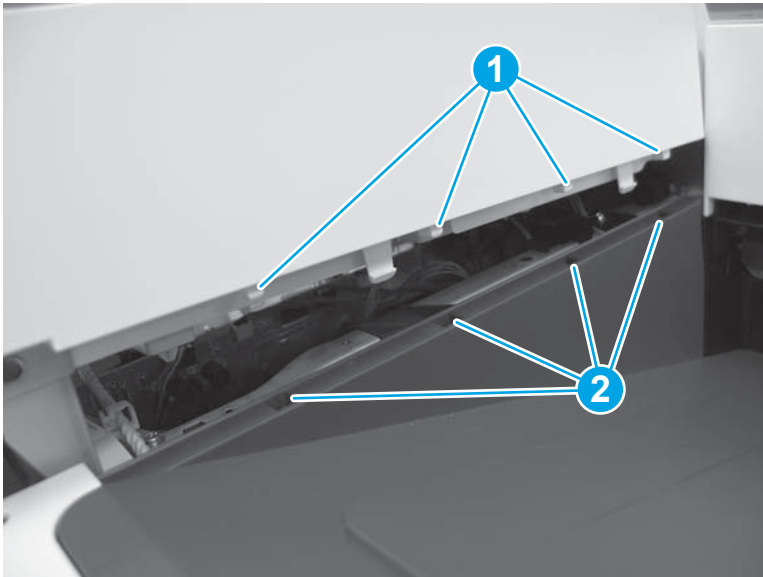

2. Press down to install the cover. Make sure that the tabs snap into place.

Figure 1-2908 Install the cover

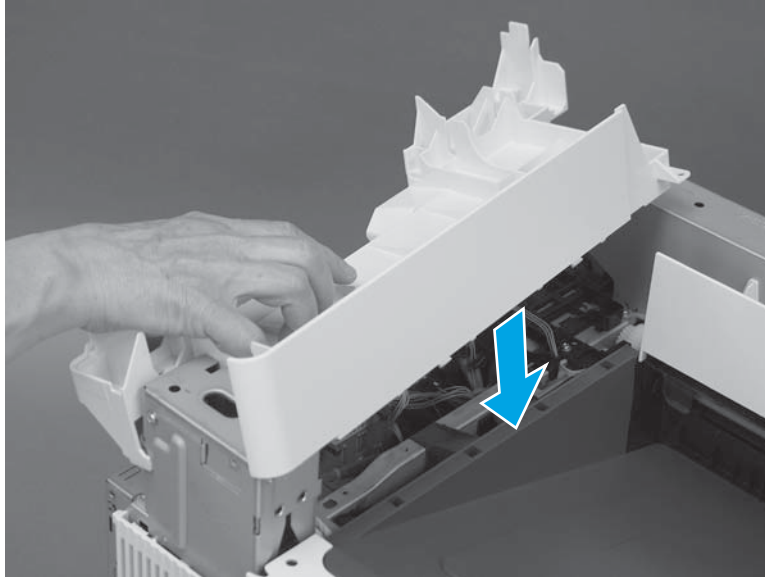

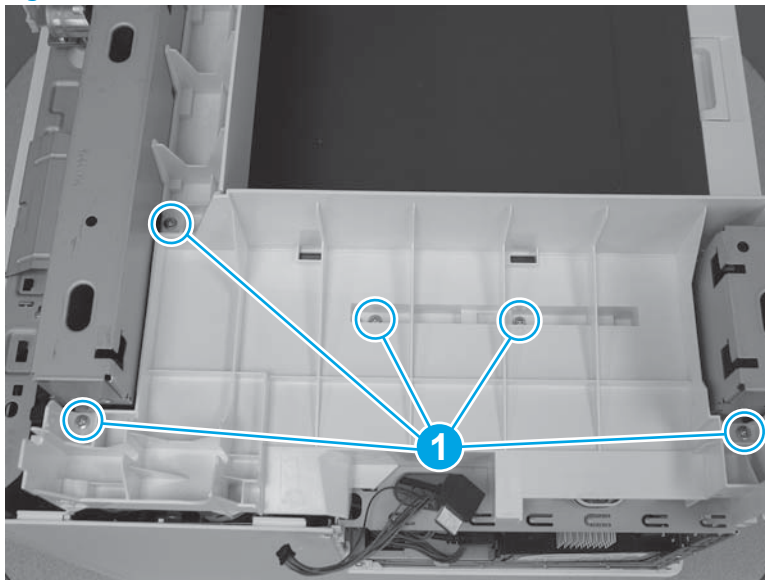

3. At the top of the printer, install five screws (callout 1).

Figure 1-2909 Install five screws



Step 35: Install the right upper cover (M577)

 **NOTE:** This step is for the M577 models. For the M552 and M553 models, skip this step and go to [Step 42: Install the rear cover \(M552 and M553\) on page 1658.](#)

 **NOTE:** The figures below show the image scanner installed. The procedures for removing and installing the right upper cover are the same whether the image scanner is installed or removed."

1. **M577c/f/z only:** Install the cables (callout 1) through the slot (callout 2) in the printer.

Figure 1-2910 Install the cables

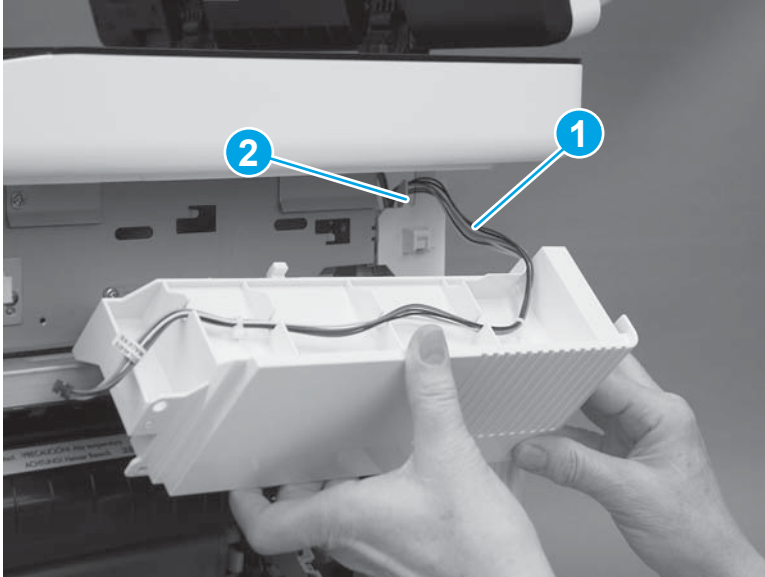

2. Position the hooks (callout 1) on the cover in the slots (callout 2) in the printer.

Figure 1-2911 Position the hooks

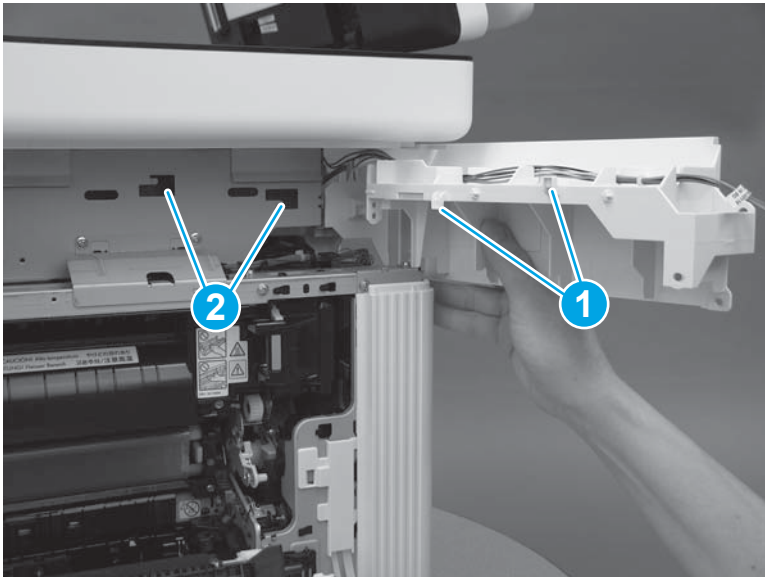

3. Slide the cover toward the front of the printer to install it.

Figure 1-2912 Install the cover

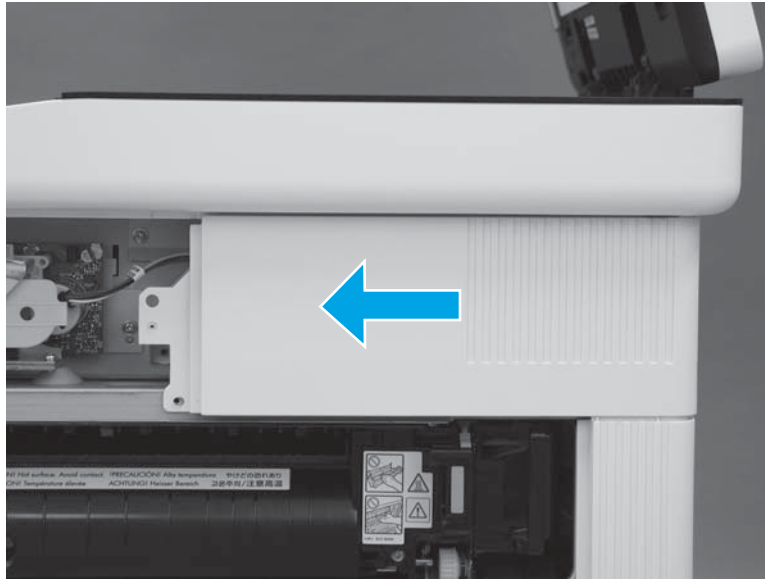

4. At the back of the printer, install one screw (callout 1).

M577c/f/z only: Connect one connector (callout 2), if the integrated scanner assembly is installed.

 **TIP:** This screw is smaller than the screws installed in the next step. Make sure that this screw is installed in the correct position.

Figure 1-2913 Install one screw and connector



5. At the right side of the printer, install two screws (callout 1).

M577c/f/z only: Connect one connector (callout 2), if the stapler is installed.

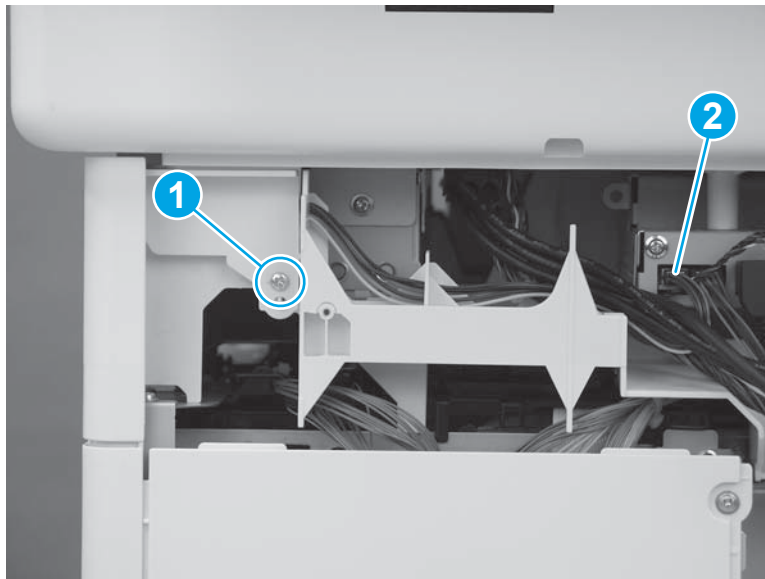
Figure 1-2914 Install one screw and connector

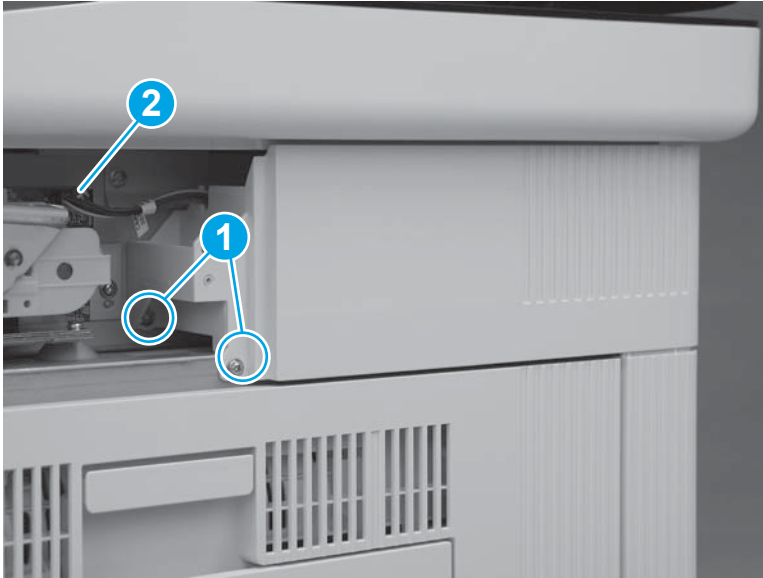

Step 36: Install the integrated scanner assembly (ISA) (M577)

 **NOTE:** This step is for the M577 models. For the M552 and M553 models, skip this step and go to [Step 42: Install the rear cover \(M552 and M553\) on page 1658.](#)

 **NOTE:** The ISA includes the document feeder, image scanner, scanner control board (SCB), control panel, keyboard (M577c/z) and NFC PCA (M577z).

1. Before proceeding, locate the mounting pins (callout 1) on the bottom of the ISA and the slots (callout 2) on the printer base.

Figure 1-2915 Locate the ISA mounting pins and slots

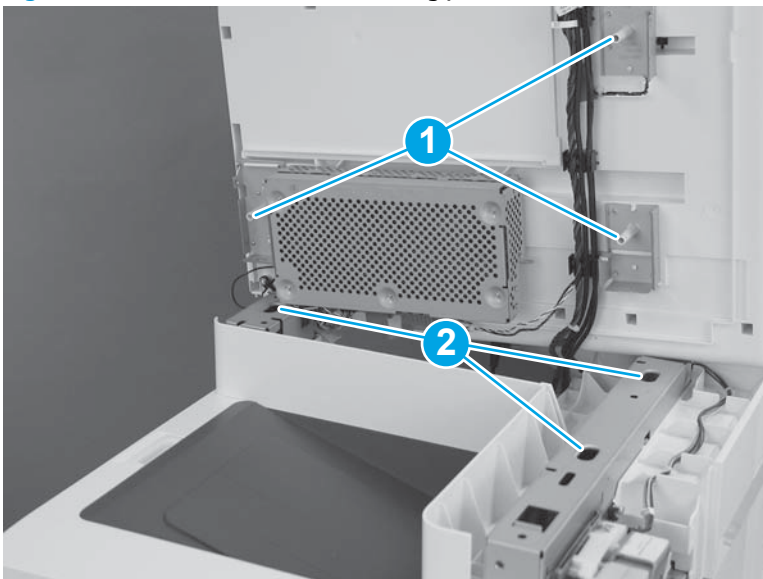

2. Position the ISA on the printer base with the pins in the slots.



NOTE: To locate the pins and slots, see [Figure 1-395 Locate the ISA mounting pins and slots on page 250](#).

When installing the ISA, carefully pass the cables through the opening in the top of the formatter case.

Figure 1-2916 Install the ISA



3. Slightly slide the ISA towards the front of the printer to engage it.

Figure 1-2917 Slide the ISA towards the front of the printer

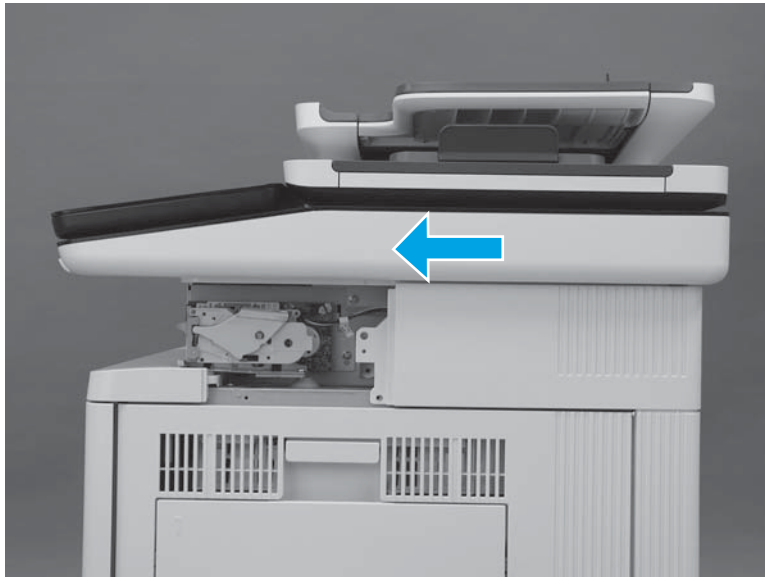

4. At the left side of the printer, install one screw (callout 1).

Figure 1-2918 Install one screw

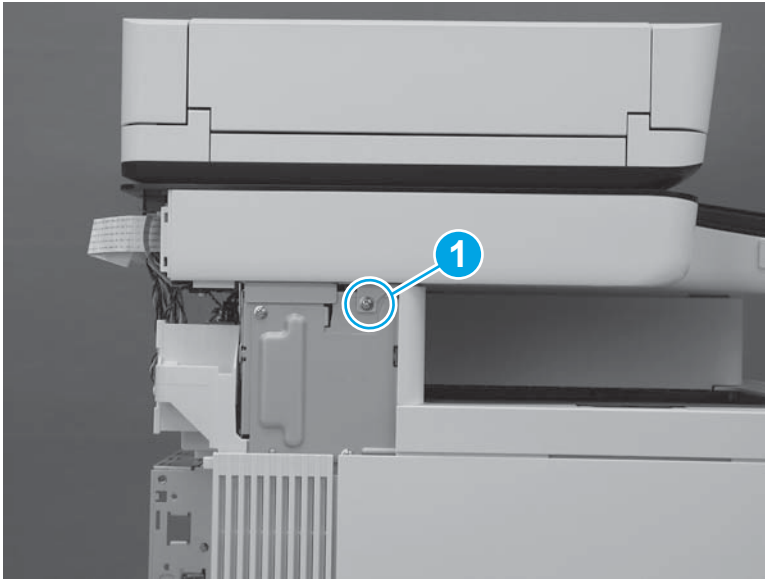

5. At the back of the printer, install two screws (callout 1).

Figure 1-2919 Install two screws

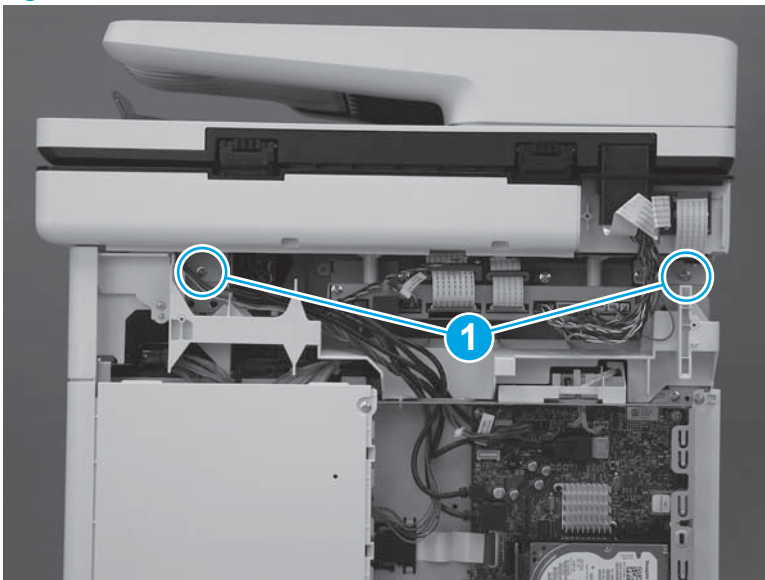

6. At the right side of the printer, install one screw (callout 1).

Figure 1-2920 Install one screw

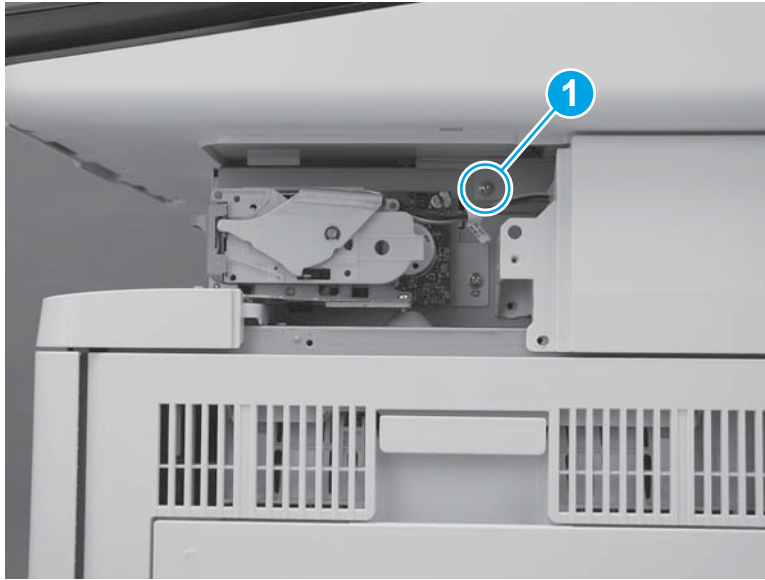

7. Connect two connectors on the scanner control board (callout 1).

M577c/f/z only: Connect one connector for the stapler on the scanner control board (callout 2).

Figure 1-2921 Connect connectors

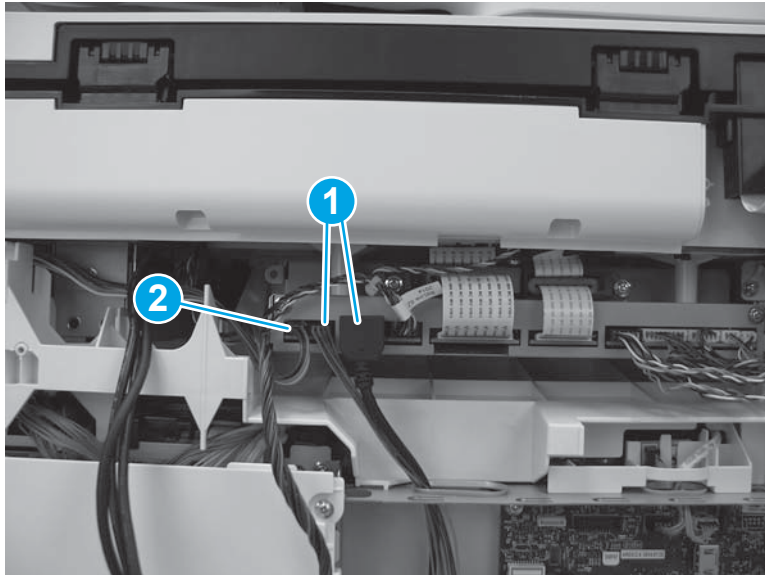

Step 37: Install the stapler cover assembly (M577c/f/z)

 **NOTE:** This step is for the M577c/f/z models only. For the M577dn model, skip this step and go to [Step 38: Install the right front upper cover \(M577dn\) on page 1651](#).

For the M552 and M553 models, skip this step and go to [Step 42: Install the rear cover \(M552 and M553\) on page 1658](#).

1. Install the tabs (callout 1) on the cover in the slots (callout 2) in the printer.

Figure 1-2922 Install two tabs



2. Press the cover toward the left side of the printer until it snaps into place.

Figure 1-2923 Install the cover assembly



3. Install one screw (callout 1).



 **IMPORTANT:** This is a self-tapping screw for plastic. Rotate it counterclockwise to align it with the existing thread pattern, and then carefully turn it clockwise to tighten. Do not overtighten. This will prevent stripping the threads inside the screw hole.

Figure 1-2924 Install one screw

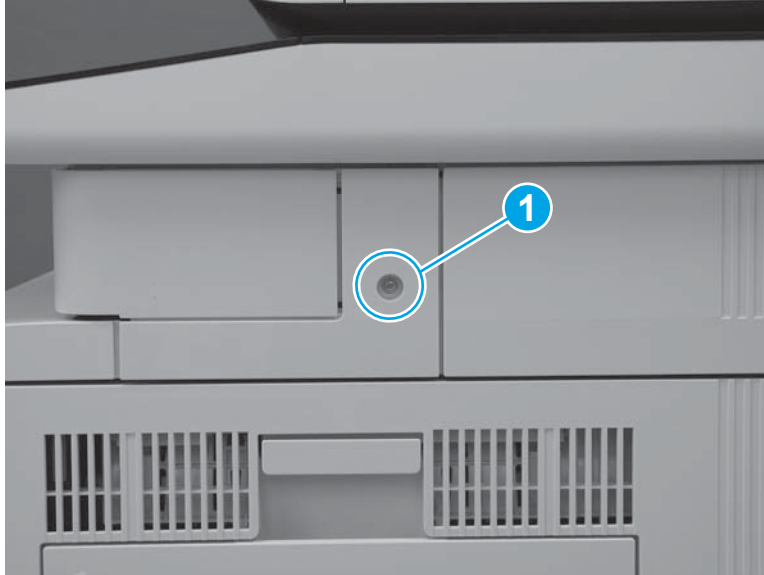

Step 38: Install the right front upper cover (M577dn)

 **NOTE:** This step is for the M577dn model only. For the M577c/f/z models, skip this step and go to [Step 39: Install the left upper cover \(M577\) on page 1653](#).

For the M552 and M553 models, skip this step and go to [Step 42: Install the rear cover \(M552 and M553\) on page 1658](#).

1. Slide the cover toward the left side of the printer to install it. Make sure that the slots (callout 1) in the cover fit over the tabs (callout 2) on the inside of the paper feeder cover.

Figure 1-2925 Install the cover



2. Press the right front upper cover (callout 1) and the paper feeder cover (callout 2) together until the tabs on the inside of the covers snap into place.

Figure 1-2926 Press the cover



3. Install one screw (callout 1).

Figure 1-2927 Install one screw

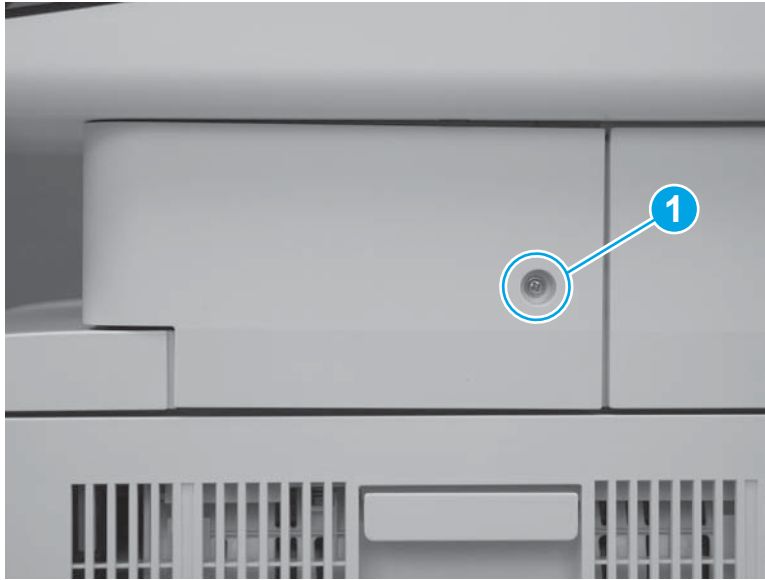

Step 39: Install the left upper cover (M577)

 **NOTE:** This step is for the M577 models. For the M552 and M553 models, skip this step and go to [Step 42: Install the rear cover \(M552 and M553\) on page 1658](#).

1. Position the tab (callout 1) on the lower edge of the cover behind the left cover (callout 2).

Figure 1-2928 Position the tab

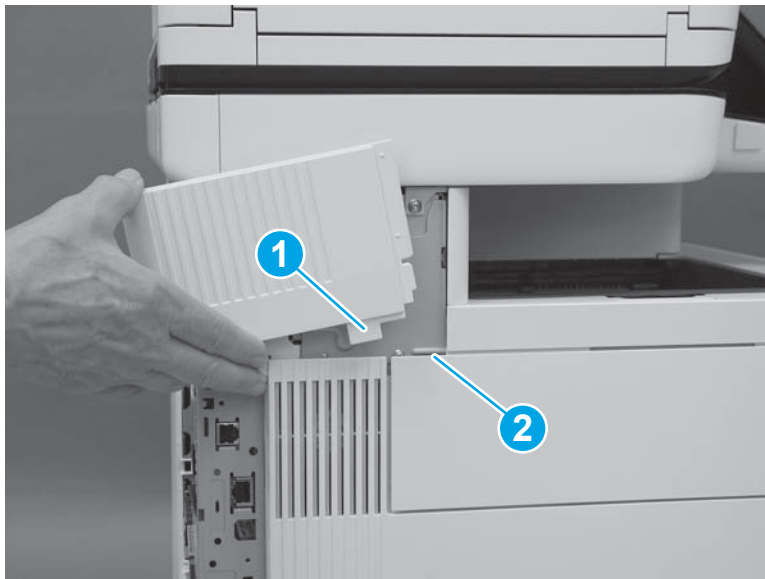

2. Slide the cover toward the front of the printer to install it. Make sure that the edge (callout 1) of the cover fits behind the edge (callout 2) of the top rear cover.

Figure 1-2929 Slide the cover

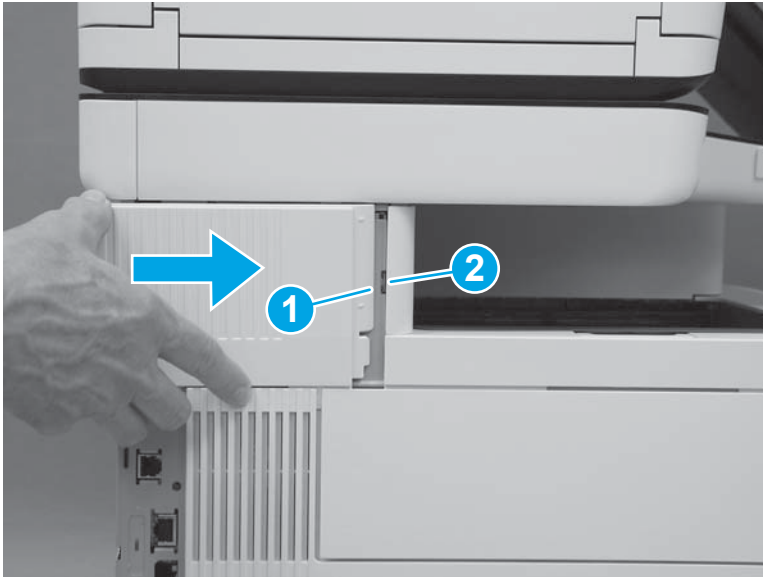

3. Make sure that the tab (callout 1) is fully installed.

Figure 1-2930 Check the tab

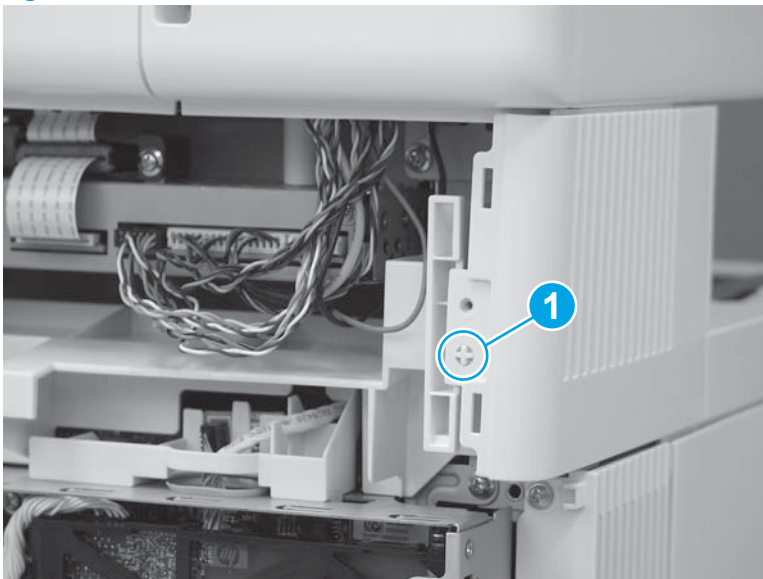

Step 40: Install the rear cover (M577)



NOTE: This step is for the M577 models. For the M552 and M553 models, skip this step and go to [Step 42: Install the rear cover \(M552 and M553\) on page 1658](#).

1. Position the hooks (callout 1) on the cover in the slots (callout 2) in the printer.

Figure 1-2931 Position the hooks

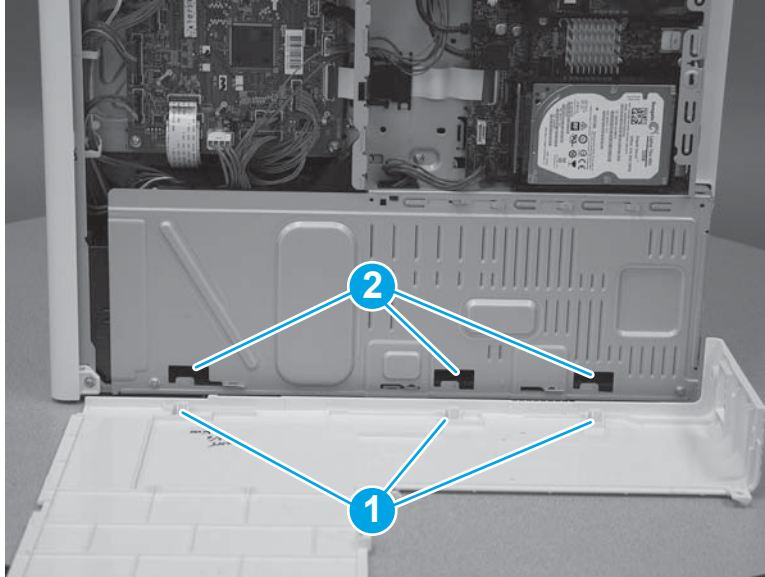

2. Position the back edge (callout 1) of the rear cover behind the edge (callout 2) of the right rear cover. Slide the cover to the left to install it.

Figure 1-2932 Install the cover

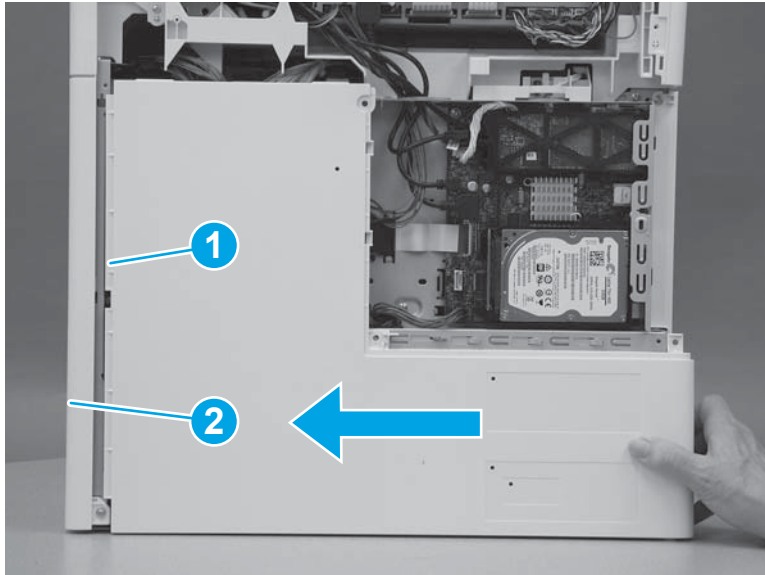

3. Install four screws (callout 1).

Figure 1-2933 Install four screws cover

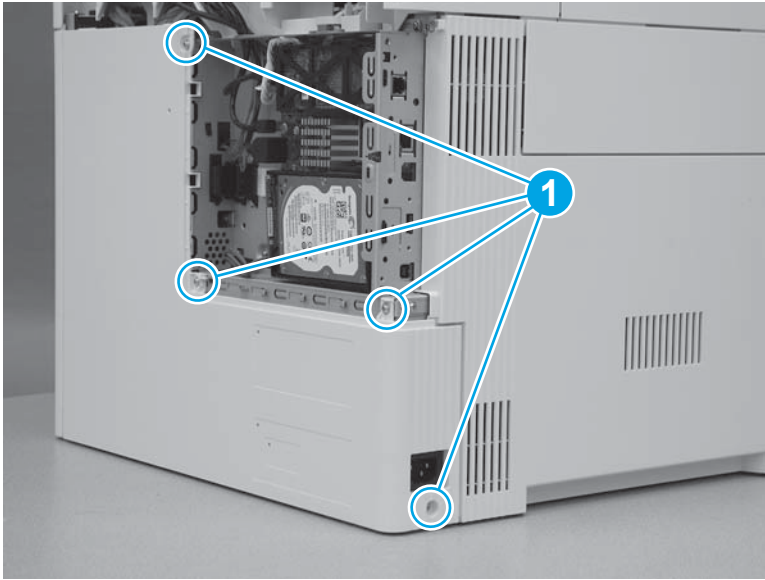

Step 41: Install the rear upper cover (M577)



NOTE: This step is for the M577 models. For the M552 and M553 models, skip this step and go to [Step 42: Install the rear cover \(M552 and M553\) on page 1658](#).

1. Align the ridge (callout 1) on the lower edge of the rear upper cover in front of the tabs (callout 2) on the top edge of the rear cover.

Figure 1-2934 Align the cover

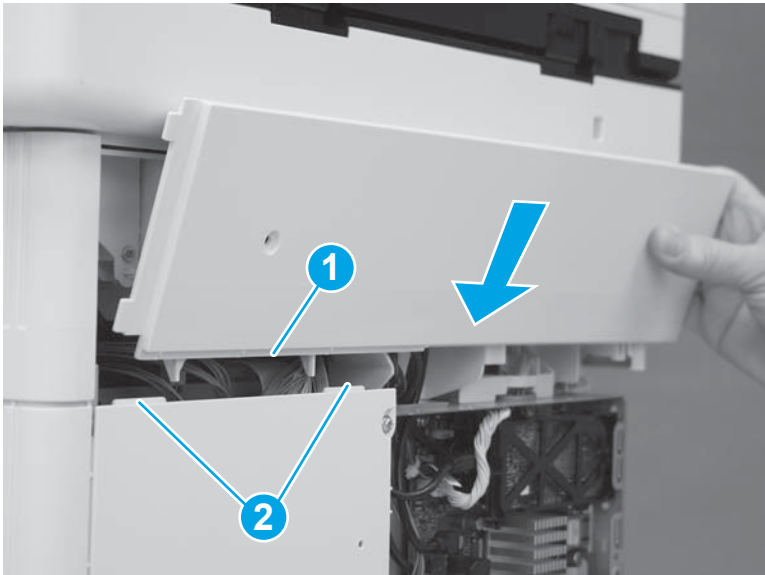

2. Rotate the top of the cover toward the printer.

Figure 1-2935 Rotate the top of the cover

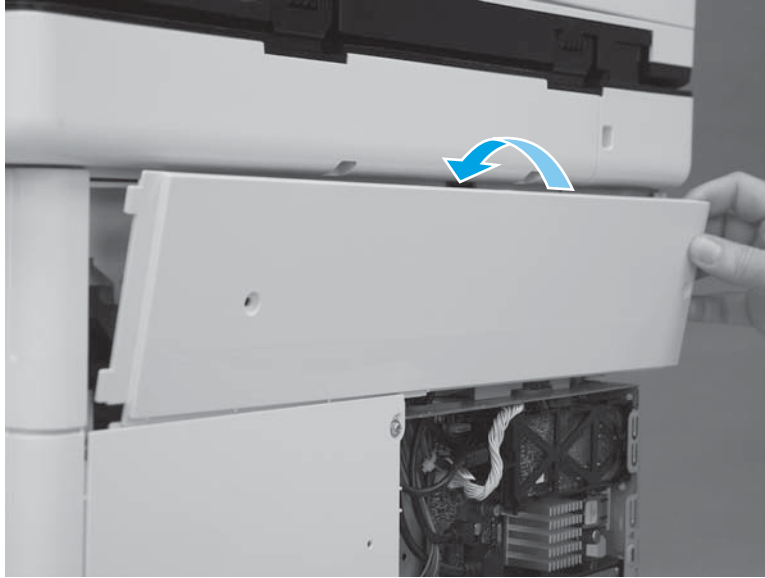

3. Slide the cover to the left (callout 1). Make sure that the tabs (callout 2) on the upper rear cover slide behind the edge (callout 3) of the right upper cover. Make sure that the cover is fully seated.

Figure 1-2936 Slide the cover

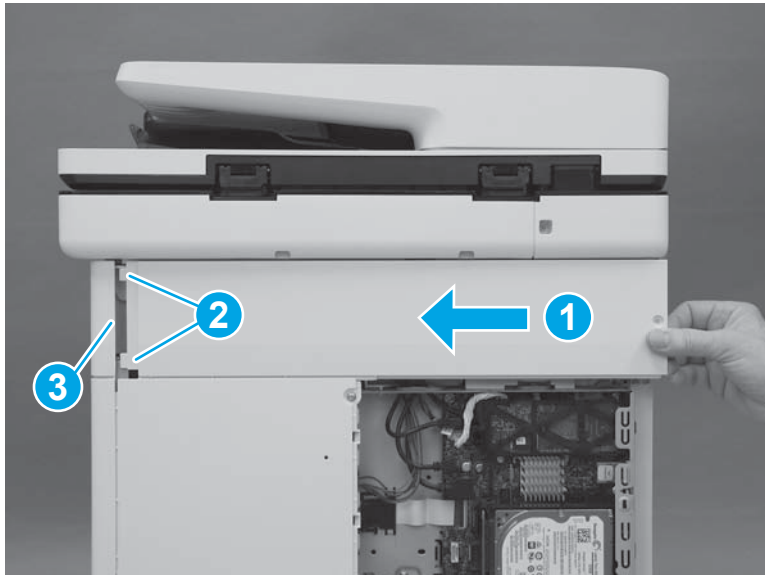

4. Install two screws (callout 1).

 **IMPORTANT:** These two screws are self-tapping screws for plastic. Rotate them counterclockwise to align them with the existing thread pattern, and then carefully turn them clockwise to tighten. Do not overtighten. This will prevent stripping the threads inside the screw holes.

Figure 1-2937 Install two screws



Step 42: Install the rear cover (M552 and M553)

 **NOTE:** This step is for the M552 and M553 models. For the M577 models, skip this step and go to [Step 43: Install the formatter \(M577\) on page 1659](#).

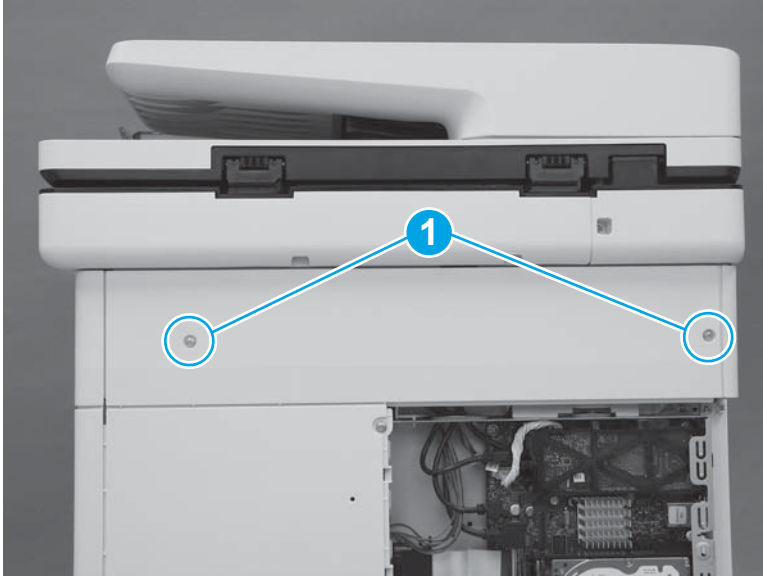
1. Position the top of the cover under the upper cover (callout 1), rotate the bottom of the cover onto the chassis (callout 2), and then slide the cover to the left (callout 3) to install it.

Figure 1-2938 Install the cover

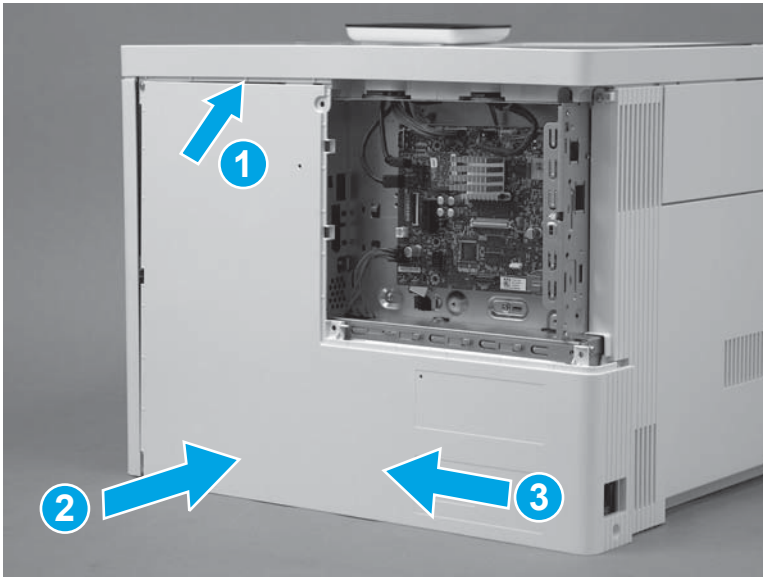

2. Install four screws (callout 1).

Figure 1-2939 Install four screws cover

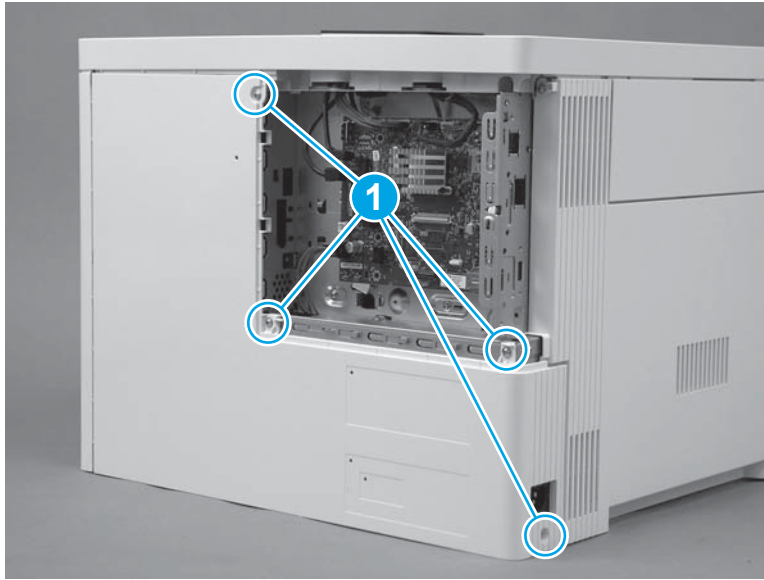

Step 43: Install the formatter (M577)

 **NOTE:** This step is for the M577 models. For the M552 and M553 models, skip this step and to go [Step 46: Install the formatter \(M552 and M553\)](#) on page 1664.

 **CAUTION:**  ESD-sensitive part.

1. Position the formatter in the printer. Make sure that the network port (callout 1) fits through the opening (callout 2) in the formatter case.

Figure 1-2940 Install the formatter

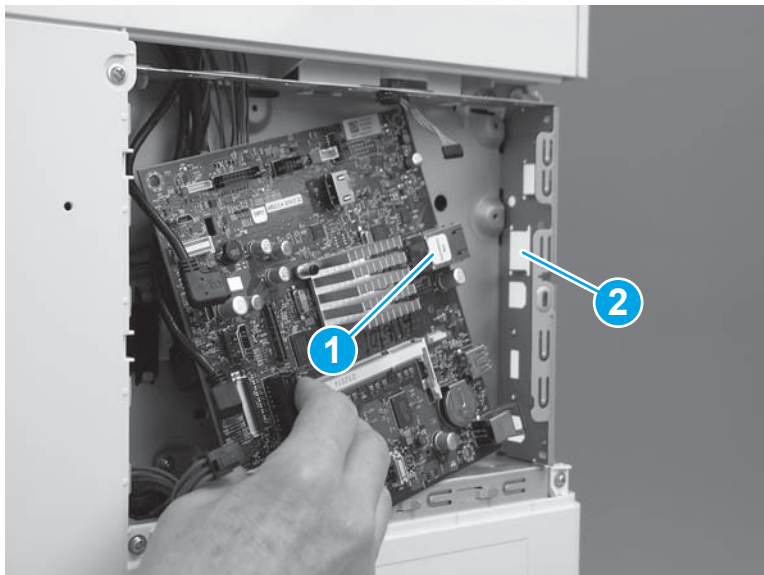

2. Install four screws (callout 1).

Figure 1-2941 Install four screws

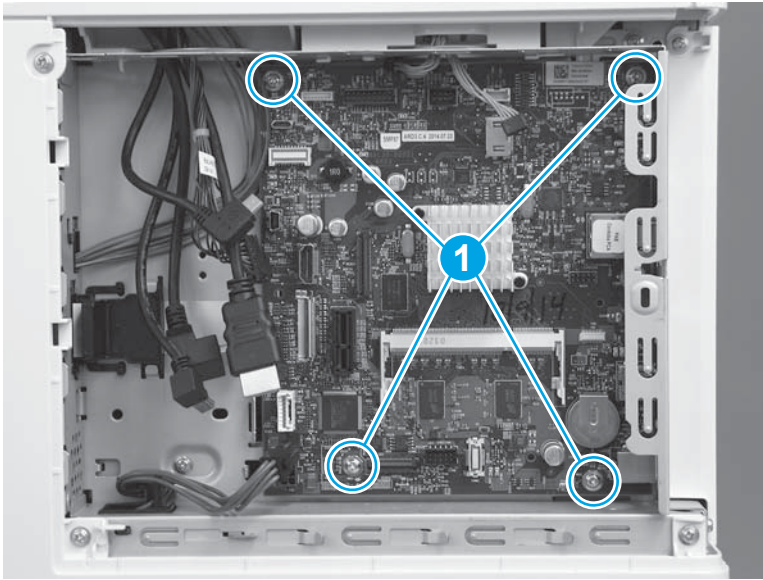

3. Connect all of the connectors on the formatter.

The following connectors are empty:

- All models: J1 (this connector is empty unless the optional DIMM is installed)
- All models: J3
- M577dn: J15 (this is the fax connector for the M577f/z/c models)
- All models: J21 (this connector is empty unless the optional internal USB ports component is installed)
- All models: J23
- All models: J24
- All models: J51
- All models: J57
- All models: J97
- All models: J98 (this connector is empty unless the optional trusted platform module (TPM) is installed)

 **IMPORTANT:** The flat-cable connector (callout 1) is a Zero Insertion Force (ZIF) connector that uses a hinged retainer to secure the flat cable. The hinged retainer must be opened to install the flat cable, and then closed after the cable is installed.

Figure 1-2942 Connect all connectors



Step 44: Install the fax PCA (M577c/f/z)

 **NOTE:** This step is for the M577c/f/z models. For the M577n model, skip this step and go to [Step 45: Install the HDD \(M577\)](#) on page 1662.

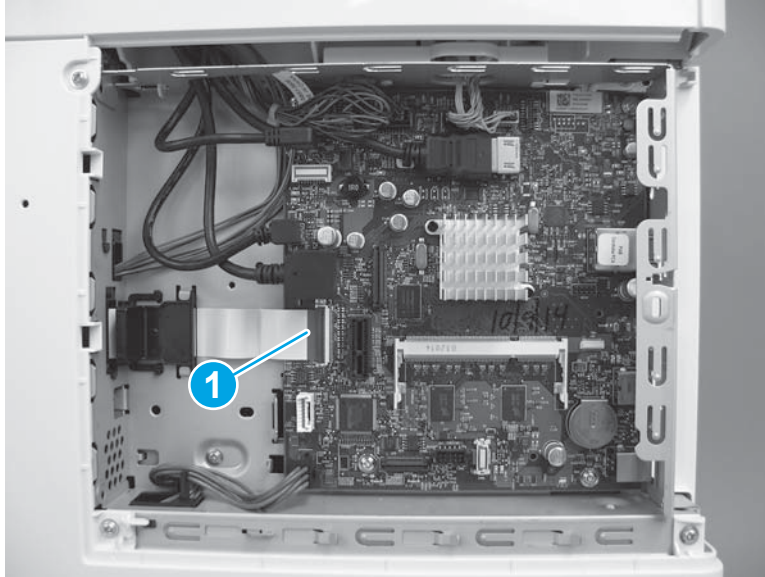
For the M552 and M553 models, skip this step and go to [Step 46: Install the formatter \(M552 and M553\)](#) on page 1664.

 **CAUTION:**  ESD-sensitive part.

1. Position the tab and telephone port (callout 1) on the fax PCA in the slots (callout 2) in the formatter case.

Figure 1-2943 Position the fax PCA

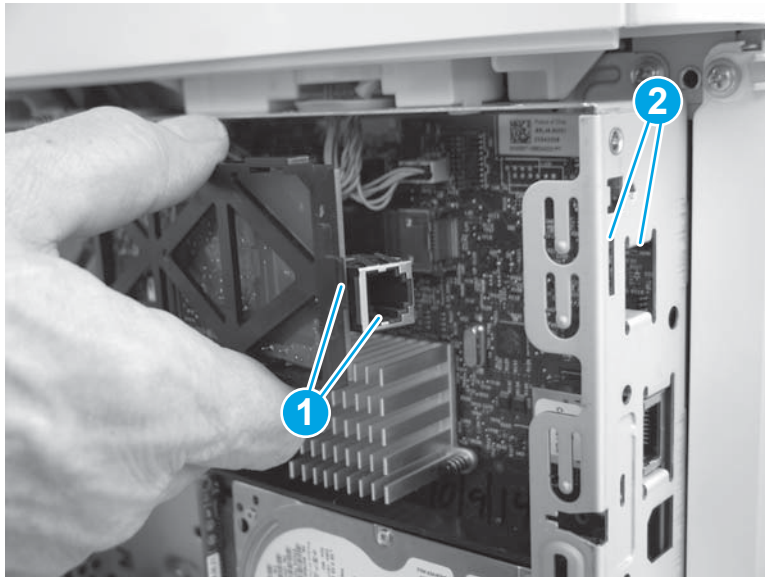

2. Slide the fax PCA to the right (callout 1) until the tab and telephone port described in the previous step and seated in the formatter case. Position the retainer (callout 2) in the slot (callout 3) in the formatter. Rotate the end of the fax PCA toward the formatter (callout 4) until the retainer snaps into place.

Figure 1-2944 Install the fax PCA

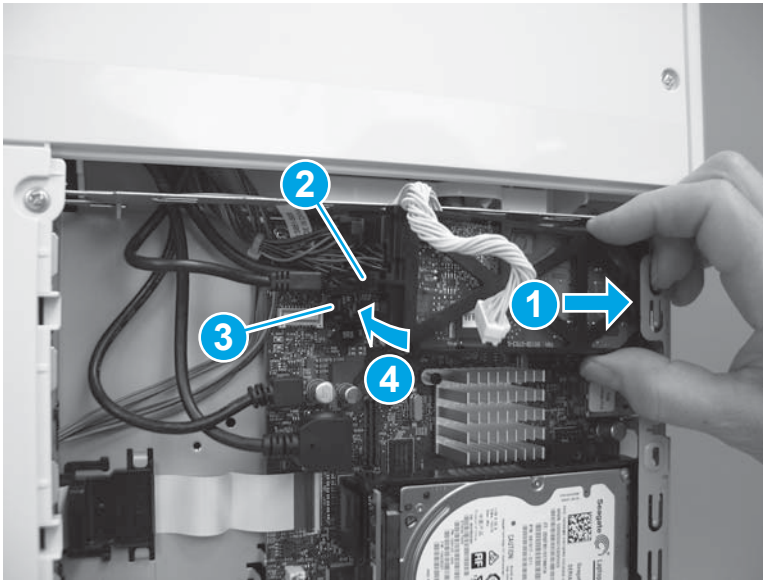

3. Position the cable (callout 1) in the guide (callout 2), and then connect one connector (callout 3).

Figure 1-2945 Connect the connector

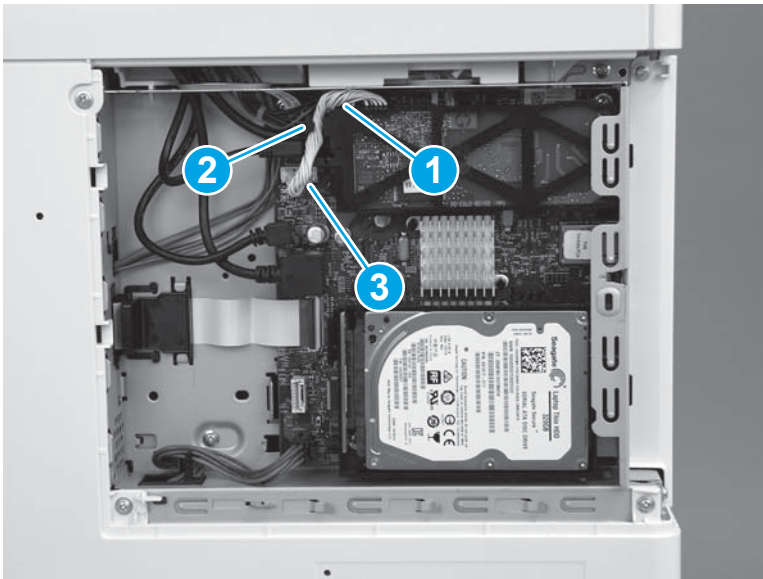

Step 45: Install the HDD (M577)



NOTE: This step is for the M577 models. For the M552 and M553 models, skip this step and go to [Step 46: Install the formatter \(M552 and M553\) on page 1664](#).

 **CAUTION:**  ESD-sensitive part.

1. Align the end of the bracket (callout 1) with the slot in the chassis (callout 2), and then slide the HDD into the printer (callout 3) to engage the bracket with the chassis.

Figure 1-2946 Install the holder

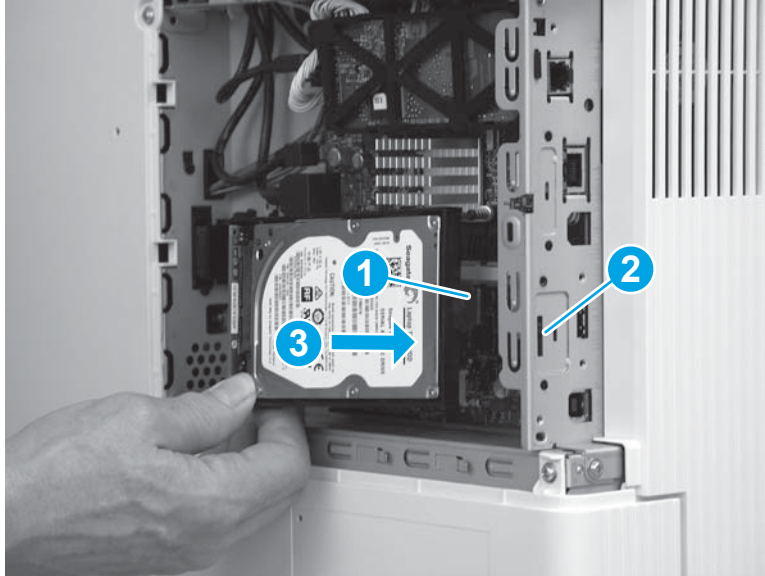

2. Hold the HDD connector latch (callout 1) in the released position, and then rotate the HDD down and into the connector on the formatter to install it.

 **NOTE:** Make sure that the tab (callout 2) snaps into place, and that the HDD is securely installed.

Figure 1-2947 Release the HDD

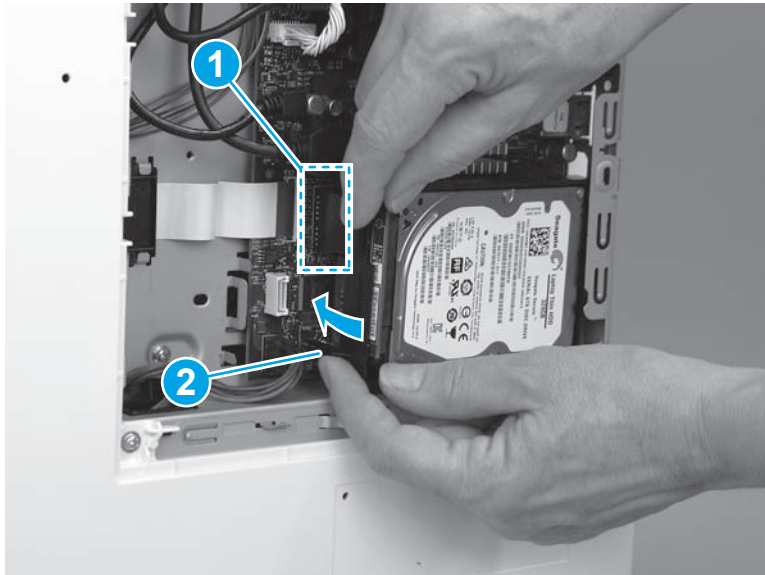

Step 46: Install the formatter (M552 and M553)

 **NOTE:** This step is for the M552 and M553 models. For the M577 models, skip this step and go to [Step 47: Install the formatter cover on page 1665](#).

If the optional hard-disk drive (HDD) was removed, do not forget to reinstall it after the formatter is reinstalled.

Engage the HDD holder with the chassis, rotate the HDD connector down and into the connector on the formatter. Make sure that the tabs snap into place.

 **CAUTION:**  ESD-sensitive part.

1. Position the formatter in the printer, and then install four screws (callout 1).

Figure 1-2948 Install the formatter

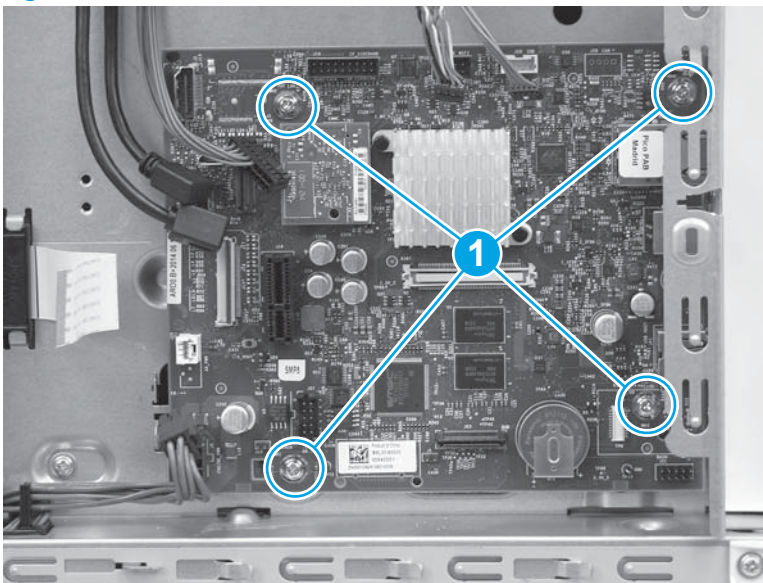

2. Connect all of the connectors on the formatter.

The following connectors are empty:

- All models: J1 (this connector is empty unless the optional DIMM is installed)
- M553n/dn and M552dn: J2 (callout 1; this is the touchscreen connector for the M553x model)
- All models: J9 (this connector is empty unless the optional internal USB ports component is installed)
- All models: J18 (this connector is empty unless the optional hard-disk-drive (HDD) is installed)
- All models: J23
- All models: J24
- M553n/dn and M552dn: J25 (this is the wireless connector for the M553x model)

- All models: J57
- All models: J98 (this connector is empty unless the optional trusted platform module (TPM) is installed)



 **IMPORTANT:** The flat-cable connector (callout 2) is a Zero Insertion Force (ZIF) connector that uses a hinged retainer to secure the flat cable. The hinged retainer must be opened to install the flat cable.

Figure 1-2949 Connect all connectors

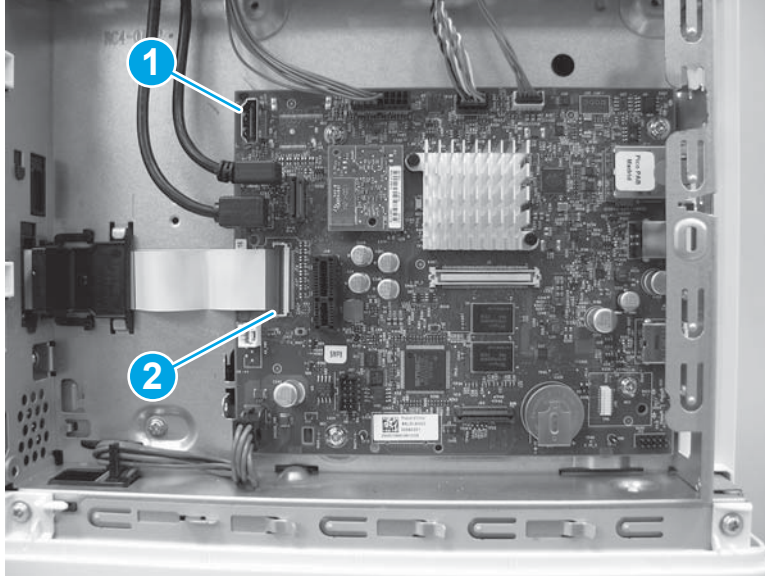

Step 47: Install the formatter cover

- ▲ Slide the cover onto the printer (callout 1) to install it.

 **NOTE:** Make sure that the tabs on the formatter cover align with the slots provided in the printer (callout 2). Tighten the two thumbscrews (callout 3).

 **TIP:** If needed, use the edge of a coin to turn the thumbscrews.

Figure 1-2950 Install the cover



Step 48: Install the TCU

1. Verify that the toner collection hatch cover is in the closed position on the TCU.

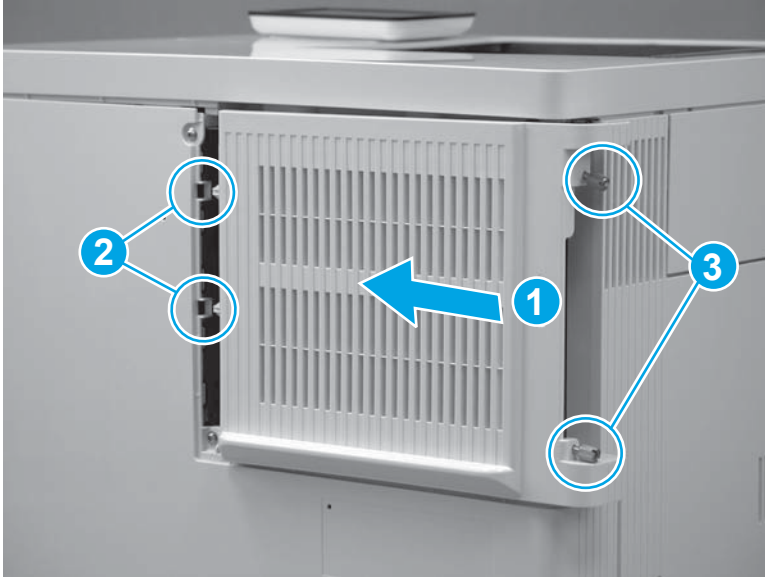
Figure 1-2951 Verify that the toner collection hatch cover is closed

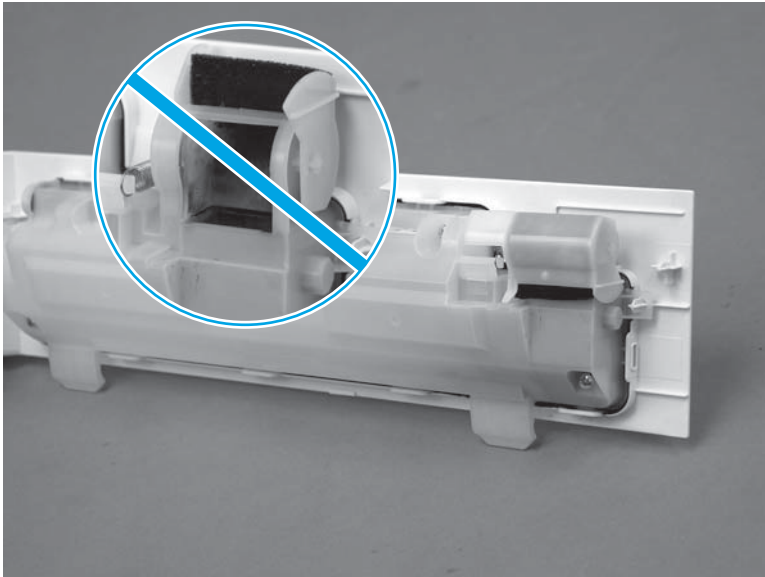

2. Position the TCU with the hinges in the slots provided in the printer (callout 1), and then rotate the TCU up and into the closed position.

 **NOTE:** The toner collection hatch cover automatically opens when the TCU is closed.

Figure 1-2952 Install the TCU



3. Close the front door.

Figure 1-2953 Close the front door

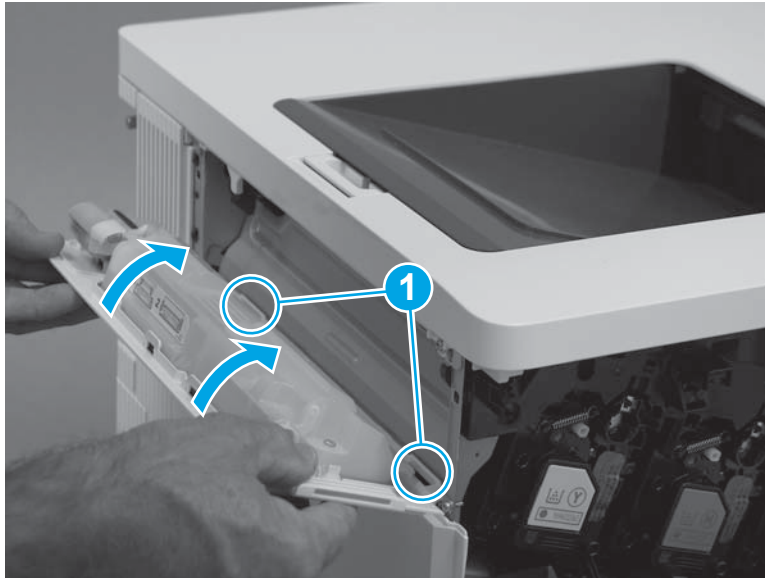

Step 49: Install the tray

1. With the front of the tray slightly lifted, align the sides of the tray with the rails in the printer, and then carefully slide the tray into the printer.

 **TIP:** As the tray slides into the printer, lower the front of it.

Figure 1-2954 Install the tray



2. Close the tray.

Figure 1-2955 Close the tray



Step 50: Install the control-panel assembly (M553x only)



NOTE: For the M553n/dn and M552dn models, skip this step and go to [Step 51: Install the USB cover \(M552 and M553\) on page 1671](#).

For the M577 models, skip this step.

1. Place the control panel on the printer as shown.

Figure 1-2956 Place the control panel on the product

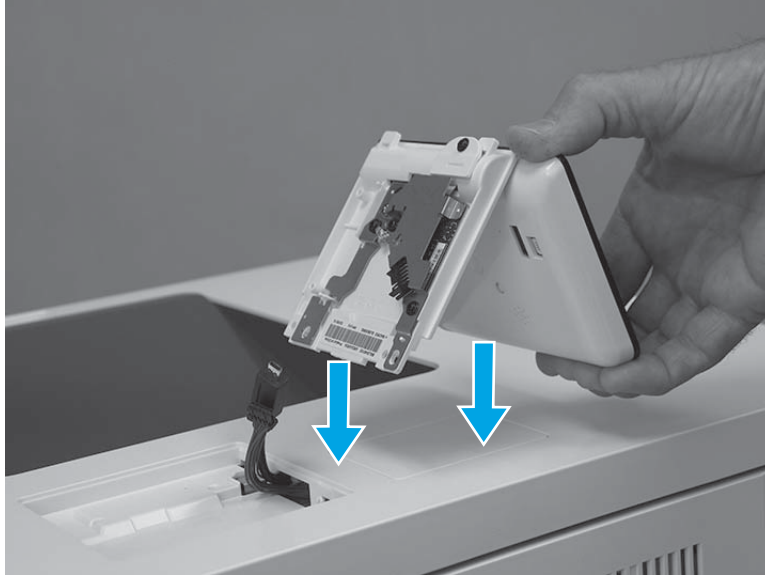

2. Connect one USB cable (callout 1), and one connector (callout 2).

 **IMPORTANT:** Take note of the location of the two mounting tabs (callout 3) on the control-panel assembly.

Figure 1-2957 Connect two connectors



3. Turn the control panel over, and then position the front edge tabs in the slots in the top cover.

Figure 1-2958 Turn the control panel over

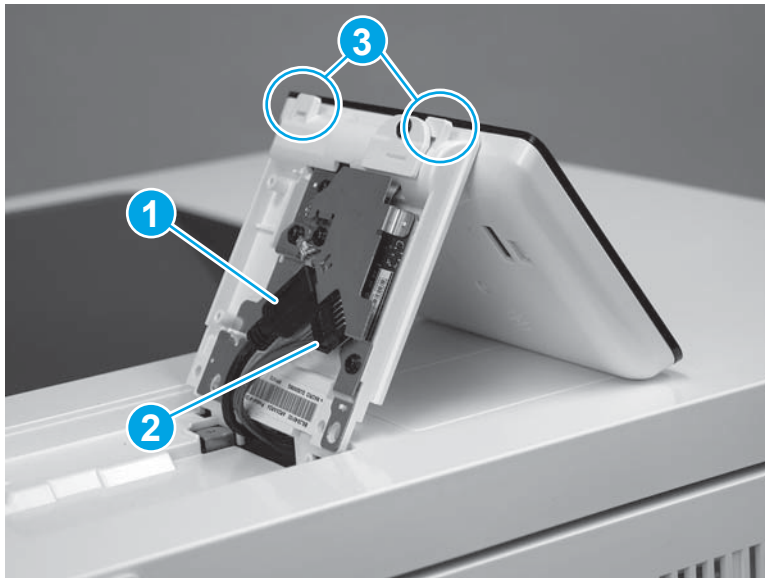
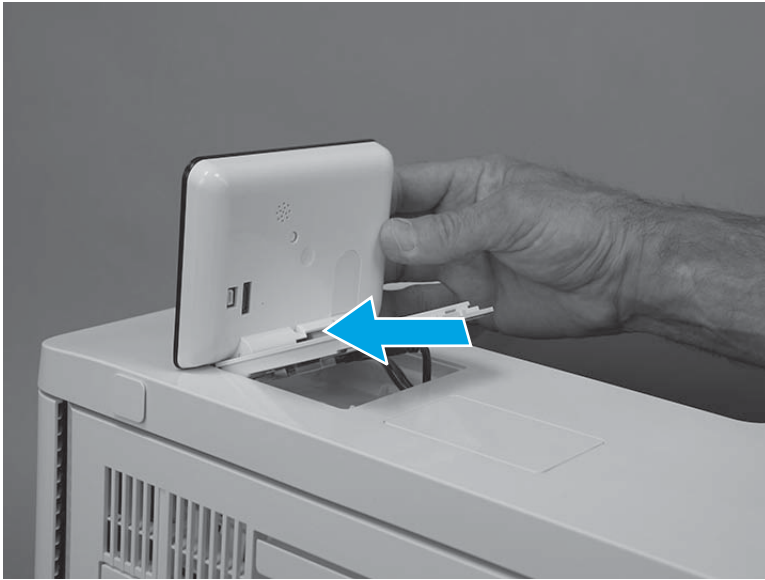

4. Rotate the control-panel base down onto the printer.

Figure 1-2959 Rotate the control-panel base down



5. Use a small Phillips screwdriver to install two screws (callout 1).

Figure 1-2960 Install two screws

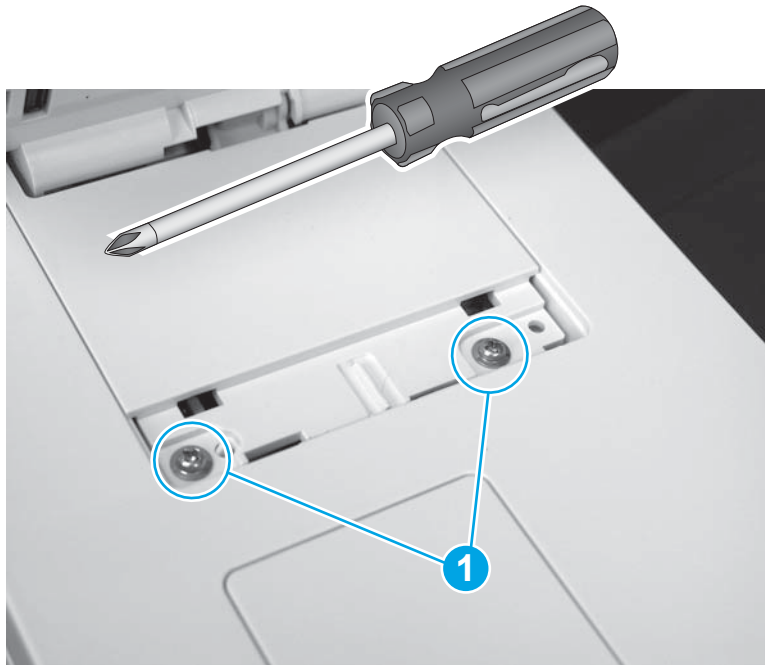

6. Position the screw cover mounting feet into the slots in the top cover (callout 1), and then rotate the cover down (callout 2) to install it.



 **NOTE:** Press down on the cover firmly to make sure that the tabs on the cover (callout 3) snap into place.

Figure 1-2961 Install the cover

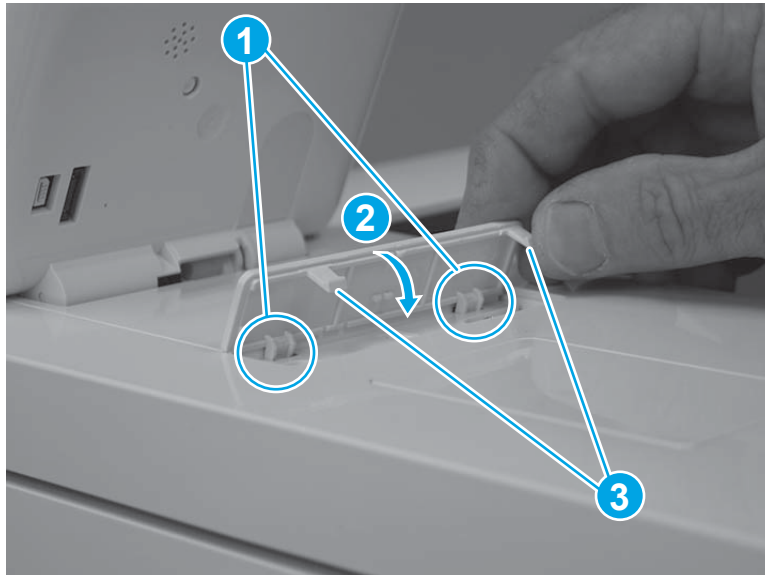

Step 51: Install the USB cover (M552 and M553)

 **NOTE:** This step is for the M552 and M553 models. For the M577 models, skip this step.

1. Push the cover into the USB port to install it.

Figure 1-2962 Install the cover



2. Make sure that the USB cover is fully seated after installing it.

Figure 1-2963 Check the installation

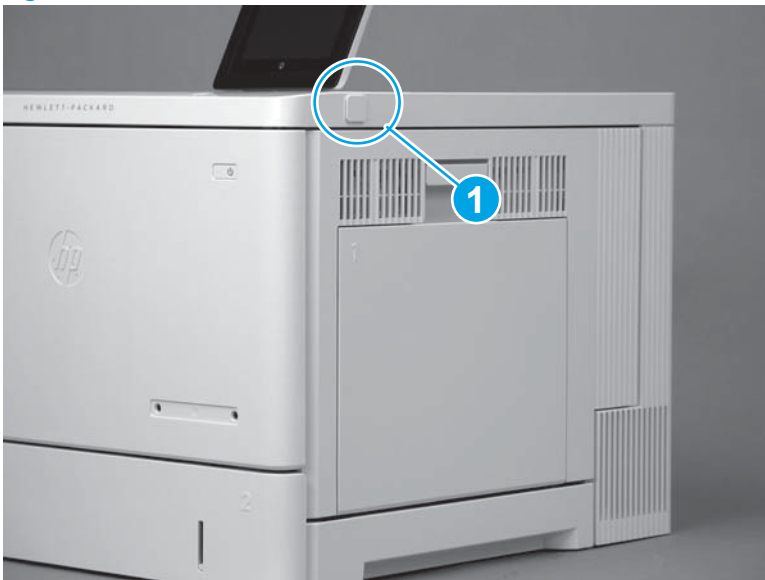

Removal and replacement: Fuser motor (M4)

- [Introduction](#)
- [Step 1: Remove the USB cover \(M552 and M553\)](#)
- [Step 2: Remove the control panel \(M553x only\)](#)
- [Step 3: Remove the tray](#)
- [Step 4: Remove the toner collection unit \(TCU\)](#)
- [Step 5: Remove the formatter cover](#)
- [Step 6: Remove the formatter \(M552 and M553\)](#)
- [Step 7: Remove the hard-disk drive \(HDD\) \(M577\)](#)
- [Step 8: Remove the fax PCA \(M577c/f/z\)](#)
- [Step 9: Remove the formatter \(M577\)](#)
- [Step 10: Remove the rear cover \(M552 and M553\)](#)
- [Step 11: Remove the rear upper cover \(M577\)](#)
- [Step 12: Remove the rear cover \(M577\)](#)
- [Step 13: Remove the left upper cover \(M577\)](#)
- [Step 14: Remove the right front upper cover \(M577dn\)](#)
- [Step 15: Remove the stapler cover assembly \(M577c/f/z\)](#)
- [Step 16: Remove the integrated scanner assembly \(ISA\) \(M577\)](#)
- [Step 17: Remove the right upper cover \(M577\)](#)
- [Step 18: Remove the top rear cover \(M577\)](#)
- [Step 19: Remove the left cover](#)
- [Step 20: Remove the upper cover \(M552 and M553\)](#)
- [Step 21: Remove the formatter case](#)
- [Step 22: Remove the right rear cover](#)
- [Step 23: Remove the DC controller and sheet-metal bracket](#)
- [Step 24: Remove the high-voltage power supply T \(HVPST\)](#)
- [Step 25: Remove the fuser motor \(M4\)](#)
- [Step 26: Unpack the replacement assembly](#)
- [Step 27: Install the fuser motor \(M4\)](#)
- [Step 28: Install the HVPST](#)
- [Step 29: Install the DC controller and sheet-metal bracket](#)

- [Step 30: Install the right rear cover](#)
- [Step 31: Install the formatter case](#)
- [Step 32: Install the upper cover \(M552 and M553\)](#)
- [Step 33: Install the left cover](#)
- [Step 34: Install the top rear cover \(M577\)](#)
- [Step 35: Install the right upper cover \(M577\)](#)
- [Step 36: Install the integrated scanner assembly \(ISA\) \(M577\)](#)
- [Step 37: Install the stapler cover assembly \(M577c/f/z\)](#)
- [Step 38: Install the right front upper cover \(M577dn\)](#)
- [Step 39: Install the left upper cover \(M577\)](#)
- [Step 40: Install the rear cover \(M577\)](#)
- [Step 41: Install the rear upper cover \(M577\)](#)
- [Step 42: Install the rear cover \(M552 and M553\)](#)
- [Step 43: Install the formatter \(M577\)](#)
- [Step 44: Install the fax PCA \(M577c/f/z\)](#)
- [Step 45: Install the HDD \(M577\)](#)
- [Step 46: Install the formatter \(M552 and M553\)](#)
- [Step 47: Install the formatter cover](#)
- [Step 48: Install the TCU](#)
- [Step 49: Install the tray](#)
- [Step 50: Install the control-panel assembly \(M553x only\)](#)
- [Step 51: Install the USB cover \(M552 and M553\)](#)

Introduction

This document provides the procedures to remove and replace the fuser motor (M4).

Before performing service

Turn the printer power off

- Disconnect the power cable.

 **WARNING!** To avoid damage to the printer, turn the printer off, wait 30 seconds, and then remove the power cord before attempting to service the printer.

Use the table below to identify the correct part number for your printer, and then go to <http://h20141.www2.hp.com/hpparts> to order the part.

Fuser motor (M4) part number

RM2-0077-000CNFuser motor (M4)

Required tools

- #2 Phillips screwdriver with a magnetic tip

After performing service

Make sure that all of the connectors on the HVPST are fully seated.

Make sure that all of the connectors on the DC controller are fully seated.

Make sure that all of the connectors on the formatter are fully seated.

Make sure that the formatter cover is fully seated, and that the thumbscrews are finger tight after replacing it.

Turn the printer power on

- Connect the power cable.
- Use the power switch to turn the power on.

Post service test

Use the components test to test the motor. For more information, see the printer troubleshooting manual.

Step 1: Remove the USB cover (M552 and M553)

NOTE: This step is for the M552 and M553 models. For the M577 models, skip this step and go to [Step 3: Remove the tray on page 1680](#).

1. Locate the USB cover.

Figure 1-2964 Locate the USB cover



2. Pull the cover off of the printer to remove it.

Figure 1-2965 Remove the cover



Step 2: Remove the control panel (M553x only)

 **NOTE:** This step is for the M553x model. For the M553n/dn, M552dn, and M577 models, skip this step and go to [Step 3: Remove the tray on page 1680](#).

1. Tilt the control panel up.

Figure 1-2966 Tilt the control panel up



2. Use a small flat-blade screwdriver to release the control-panel screws cover tabs.

Figure 1-2967 Release the control-panel screws cover tabs



3. Rotate the cover up to remove it.

Figure 1-2968 Remove the cover

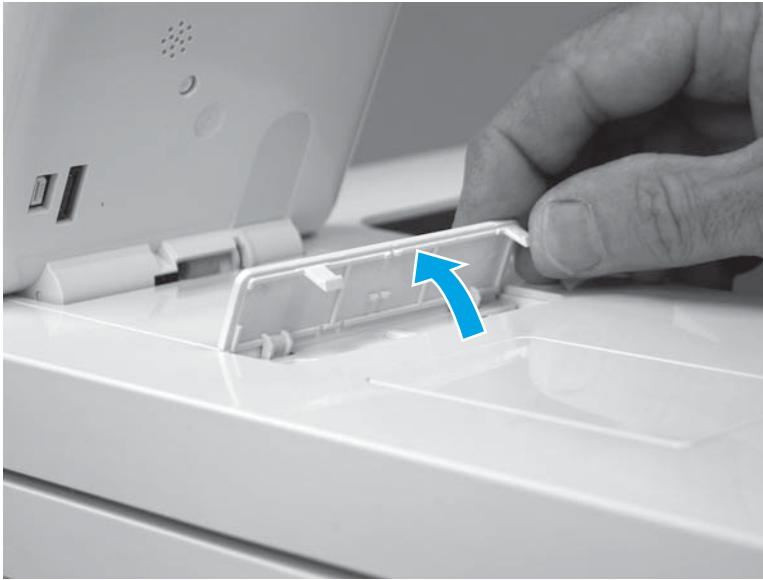

4. Use a small Phillips screwdriver to remove two screws (callout 1).

 **IMPORTANT:** Store the screws in a secure place where they cannot fall down into the printer.

Figure 1-2969 Remove two screws

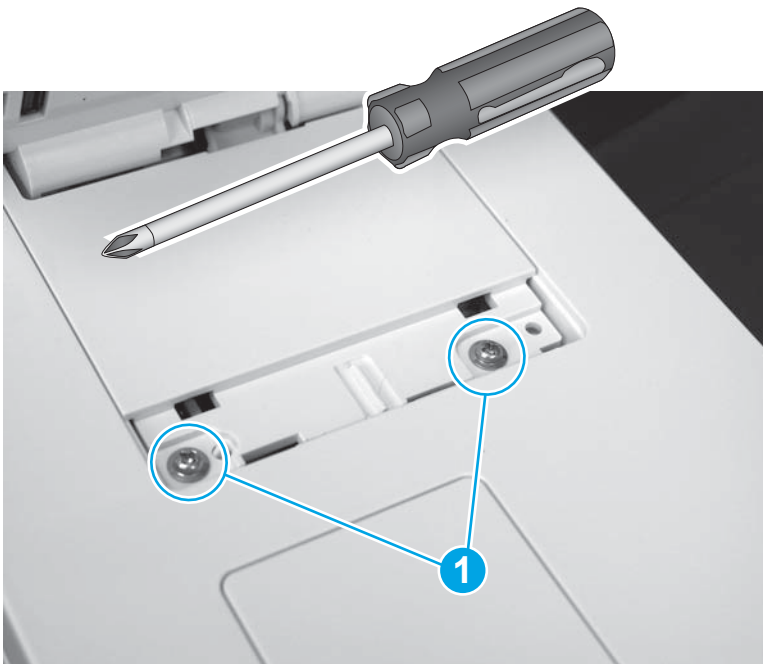

5. Rotate the control-panel base toward the front of the printer.

Figure 1-2970 Rotate the control-panel base up



6. Slightly slide the control-panel base toward the rear of the printer (callout 1) to release it, and then turn the control panel over (callout 2) to access the bottom side.

⚠ CAUTION: The control panel is still attached to the printer. Do not attempt to completely remove the control panel.

Figure 1-2971 Turn the control panel over

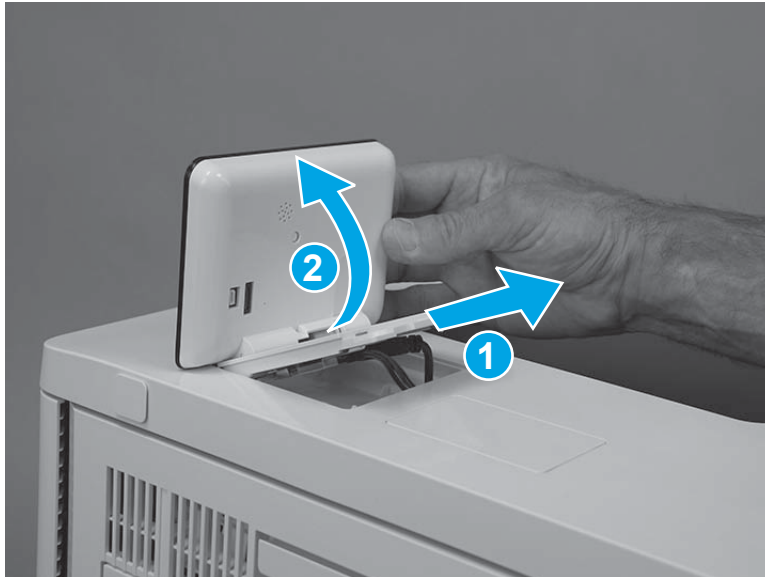

7. Disconnect one USB cable (callout 1), one connector (callout 2), and then remove the control panel.

Figure 1-2972 Disconnect two connectors

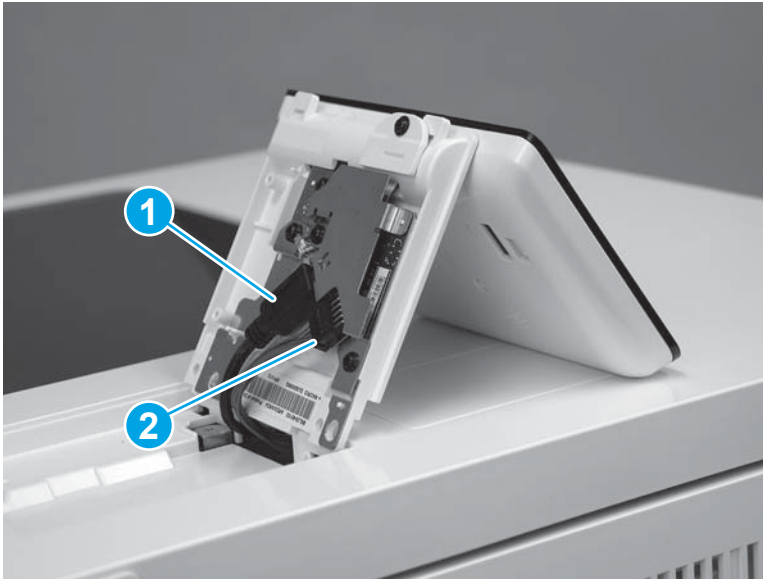

Step 3: Remove the tray

1. Pull the tray out until it stops.

Figure 1-2973 Pull the tray out



2. Lift the front of the tray, and then pull it out of the printer to remove it.

Figure 1-2974 Remove the tray

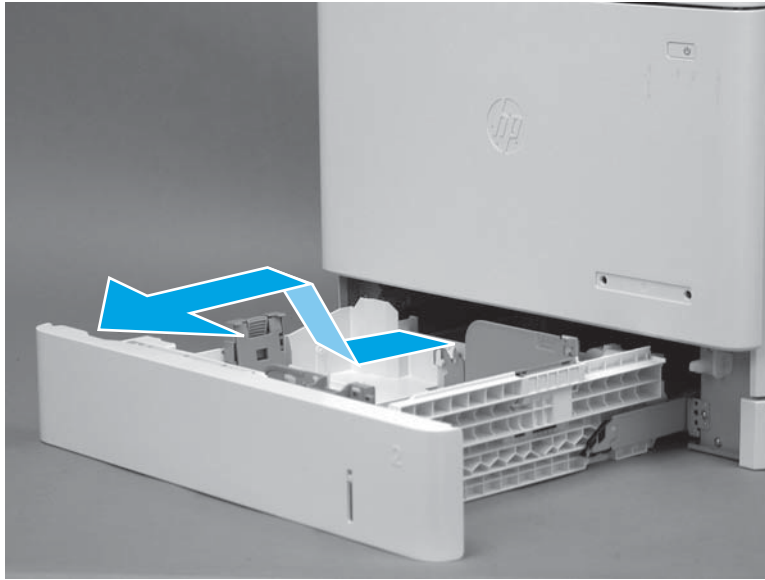

Step 4: Remove the toner collection unit (TCU)

1. Open the front door.

Figure 1-2975 Open the front door



2. Open the TCU.

 **NOTE:** The toner collection hatch cover automatically closes when the TCU is opened.

Figure 1-2976 Open the TCU



3. Pull the TCU away from the printer at an angle to remove it.

⚠ CAUTION: Do not open the toner collection hatch cover when handling the TCU. If toner gets on clothing, wipe it off by using a dry cloth and wash the clothes in cold water. Hot water sets toner into fabric.

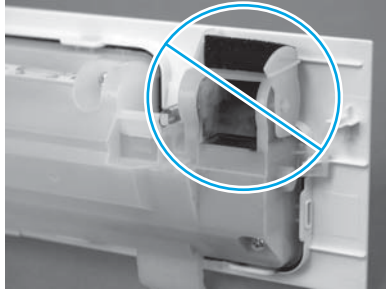
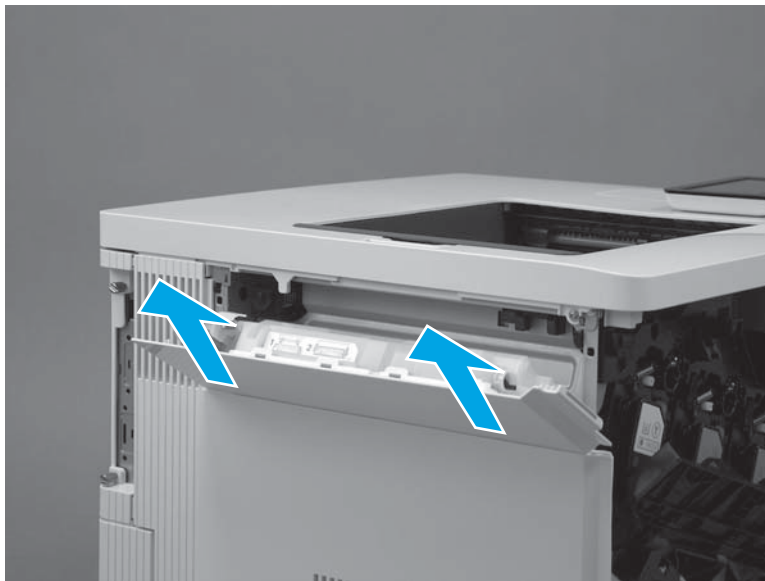

Figure 1-2977 Remove the TCU



Step 5: Remove the formatter cover

1. Locate the formatter cover.

Figure 1-2978 Locate the formatter cover

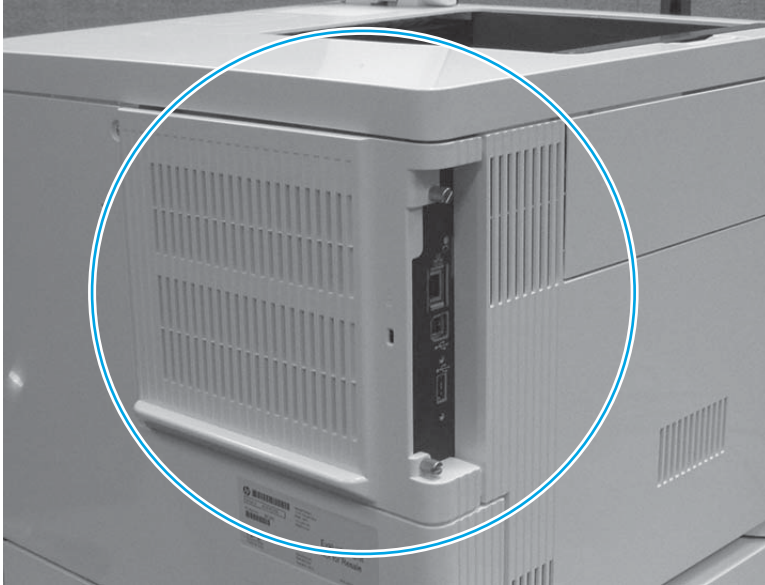

2. Loosen the two thumbscrews (callout 1). Grasp the two thumbscrews, and then slide the cover away from the printer (callout 2) to remove it.

 **TIP:** If needed, use the edge of a coin to turn the thumbscrews.

Figure 1-2979 Loosen the thumbscrews



Step 6: Remove the formatter (M552 and M553)

 **NOTE:** This step is for the M552 and M553 models. For the M577 models, skip this step and go to [Step 7: Remove the hard-disk drive \(HDD\) \(M577\) on page 1686](#).

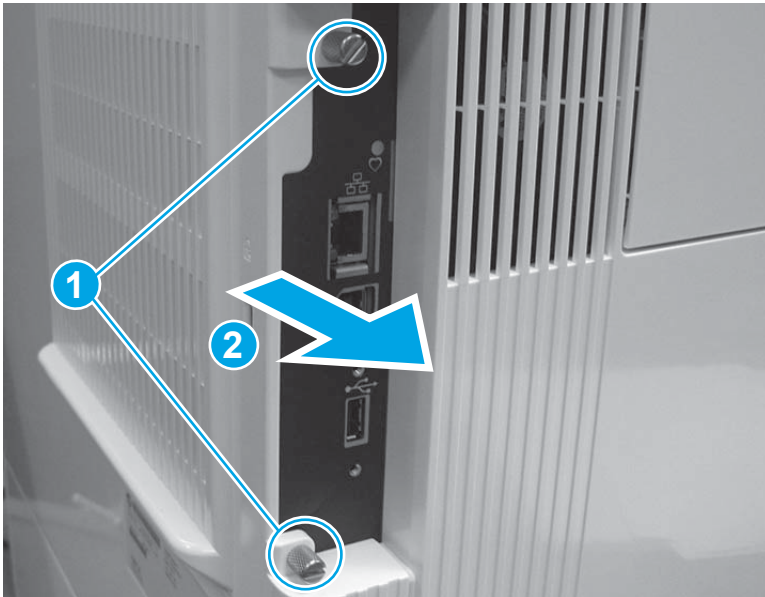
If the optional hard-disk drive (HDD) is installed, it must be removed to gain access to the formatter mounting screws.

Release two tabs along the left edge of the HDD, rotate the left edge away from the product, and then slide the HDD to the left to remove it.

 **CAUTION:**  ESD-sensitive part.

1. Disconnect all of the connectors on the formatter.

The following connectors are empty:

- All models: J1 (this connector is empty unless the optional DIMM is installed)
- M553n/dn and M552dn: J2 (callout 1; this is the touchscreen connector for the M553x model)
- All models: J9 (this connector is empty unless the optional internal USB ports component is installed)
- All models: J18 (this connector is empty unless the optional hard-disk-drive (HDD) is installed)
- All models: J23
- All models: J24
- M553n/dn and M552dn: J25 (this is the wireless connector for the M553x model)
- All models: J57
- All models: J98 (this connector is empty unless the optional trusted platform module (TPM) is installed)

 **IMPORTANT:** The flat-cable connector (callout 2) is a Zero Insertion Force (ZIF) connector that uses a hinged retainer to secure the flat cable. The hinged retainer must be opened to release the flat cable.

Figure 1-2980 Disconnect all connectors



2. Remove four screws (callout 1), and then remove the formatter.

Figure 1-2981 Remove the formatter

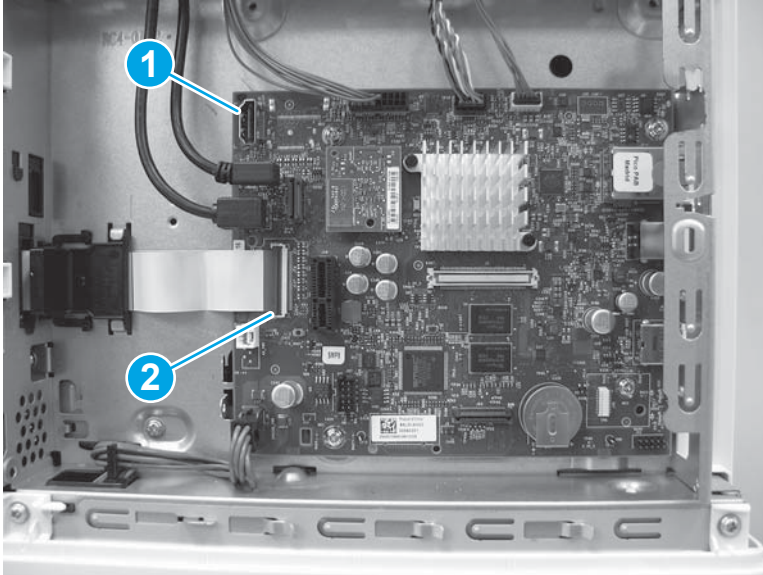
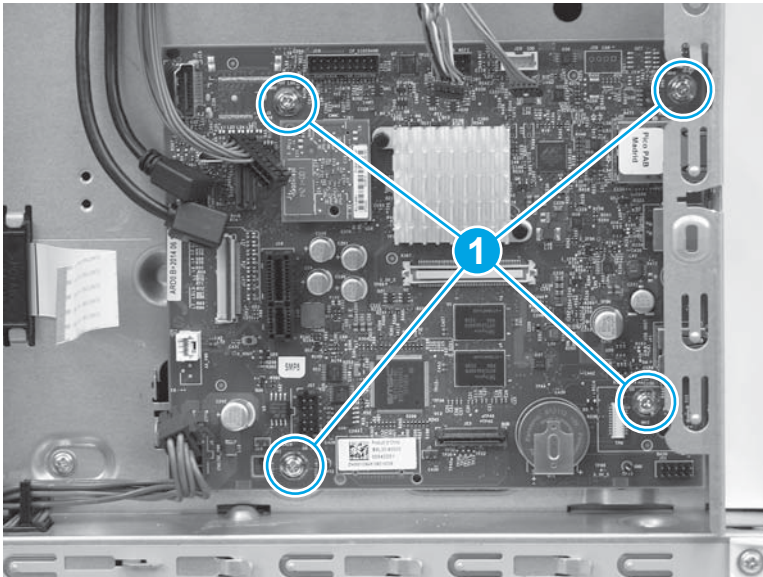

Step 7: Remove the hard-disk drive (HDD) (M577)

 **NOTE:** This step is for the M577 models. For the M552 and M553 models, skip this step and go to [Step 10: Remove the rear cover \(M552 and M553\)](#) on page 1691.

 **CAUTION:**  ESD-sensitive part.

1. Release two tabs (callout 1). Hold the tabs in the released position, and then rotate the hard disk drive (HDD) up (callout 2) to release the connector from the formatter.

Figure 1-2982 Release the HDD

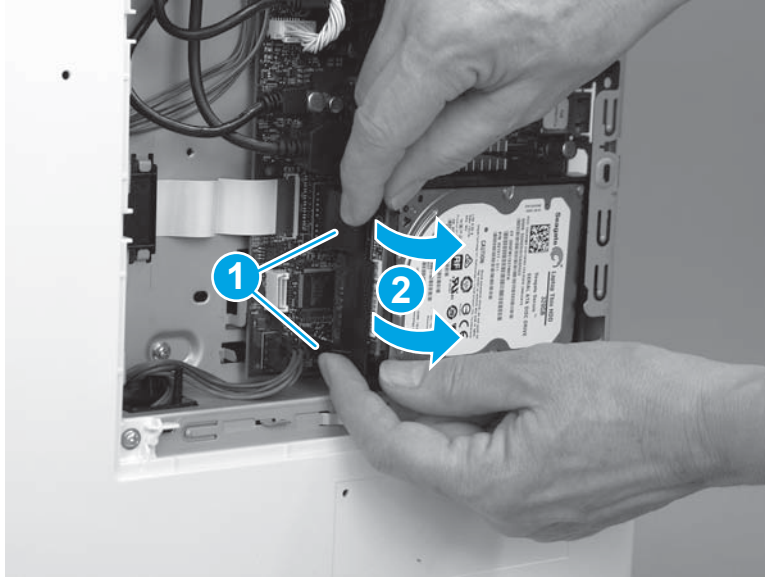

2. Slide the HDD away from the printer to remove it.

Figure 1-2983 Remove the HDD

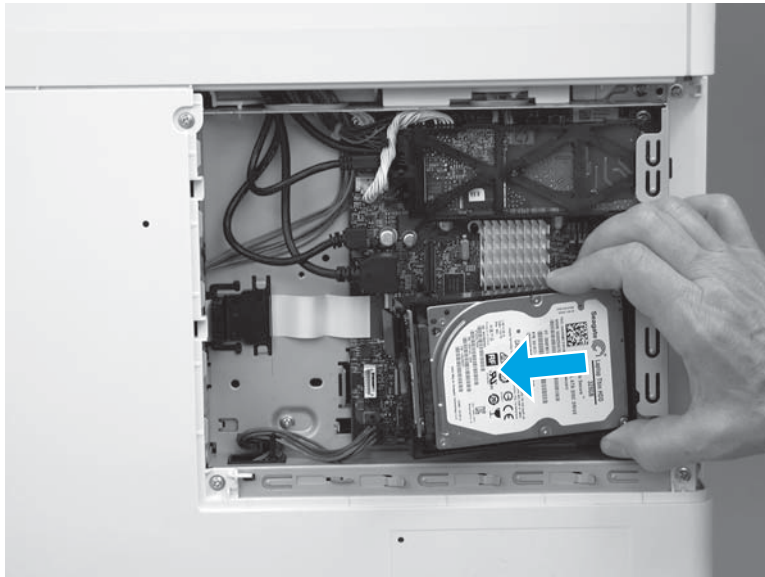

Step 8: Remove the fax PCA (M577c/f/z)

 **NOTE:** This step is for the M577c/f/z models. For the M577n model, skip this step and go to [Step 9: Remove the formatter \(M577\) on page 1689](#).

For the M552 and M553 models, skip this step and go to [Step 10: Remove the rear cover \(M552 and M553\) on page 1691](#).

 **CAUTION:**  ESD-sensitive part.

1. Locate the fax PCA component on the formatter.

Figure 1-2984 Locate the fax PCA

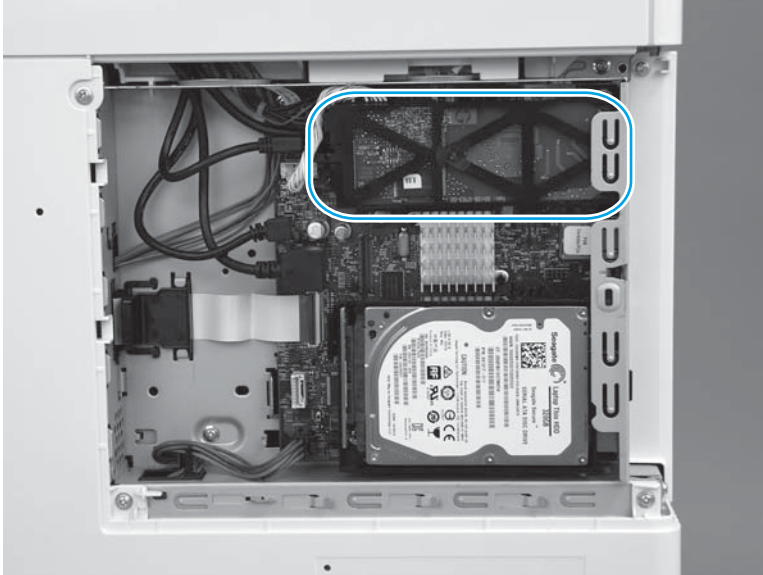

2. Release the connector latch (callout 1), and then pull the connector away from the formatter (callout 2) to disconnect it.

Figure 1-2985 Disconnect one connector

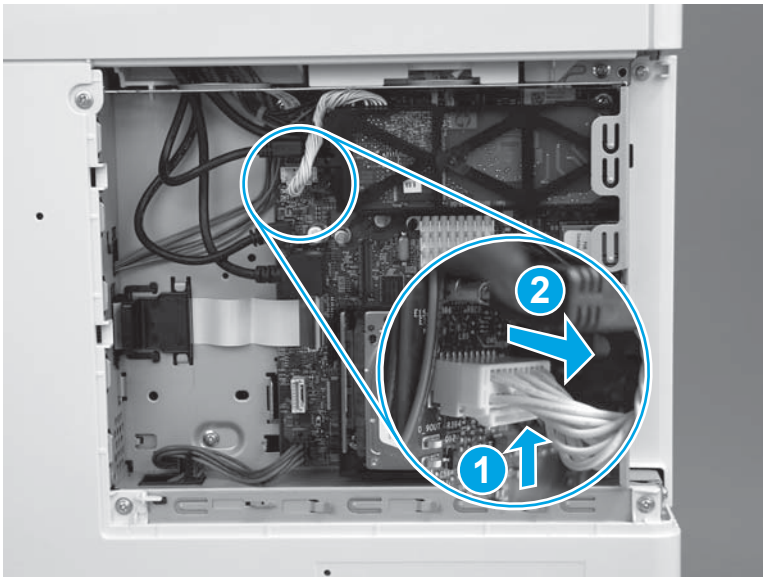

3. Release one retainer (callout 1) by pressing the bracket arms together.

Figure 1-2986 Release one latch

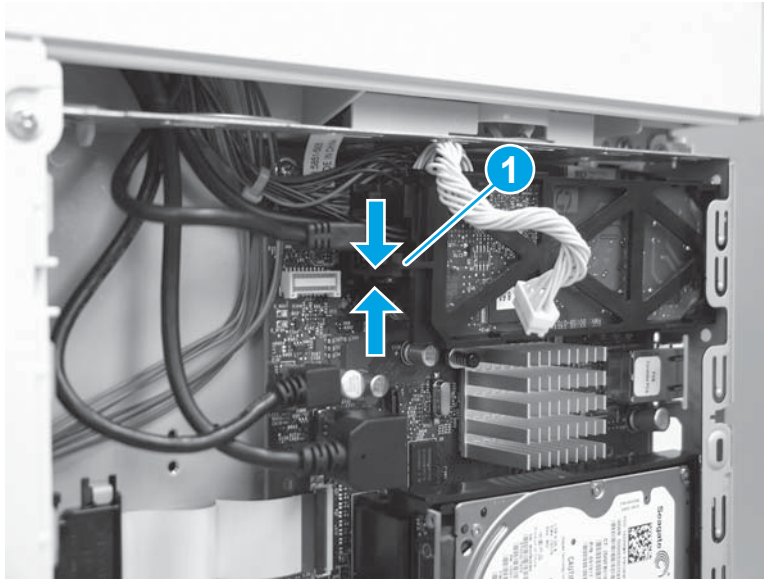

4. Rotate the end of the fax PCA (callout 1) away from the formatter, and then slide the PCA left (callout 2) to remove it.

Figure 1-2987 Remove the fax PCA

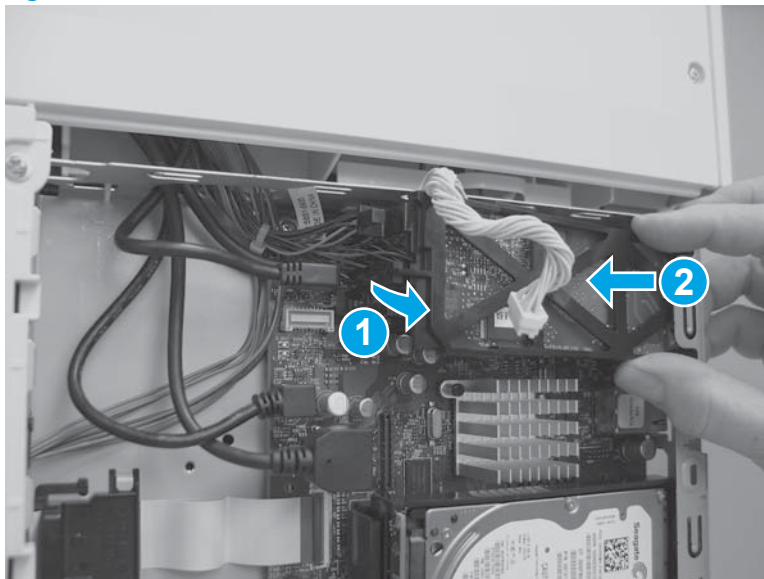

Step 9: Remove the formatter (M577)

 **NOTE:** This step is for the M577 models. For the M552 and M553 models, skip this step and go to [Step 10: Remove the rear cover \(M552 and M553\) on page 1691](#).

 **CAUTION:**  ESD-sensitive part.

1. Disconnect all of the connectors on the formatter.

The following connectors are empty:

- All models: J1 (this connector is empty unless the optional DIMM is installed)
- All models: J3
- M577dn: J15 (this is the fax connector for the M577f/z/c models)
- All models: J21 (this connector is empty unless the optional internal USB ports component is installed)
- All models: J23
- All models: J24
- All models: J51
- All models: J57
- All models: J97
- All models: J98 (this connector is empty unless the optional trusted platform module (TPM) is installed)

 **IMPORTANT:** The flat-cable connector (callout 1) is a Zero Insertion Force (ZIF) connector that uses a hinged retainer to secure the flat cable. The hinged retainer must be opened to release the flat cable.

Figure 1-2988 Disconnect all connectors



2. Remove four screws (callout 1).

Figure 1-2989 Remove four screws

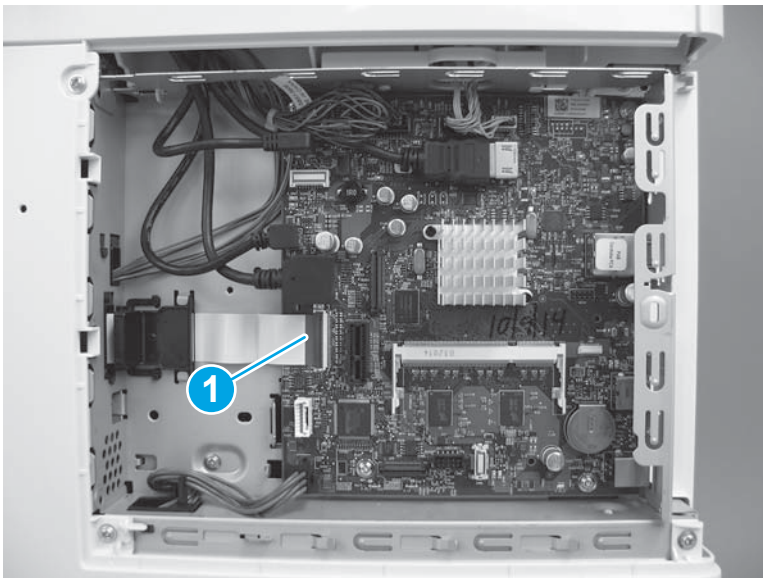
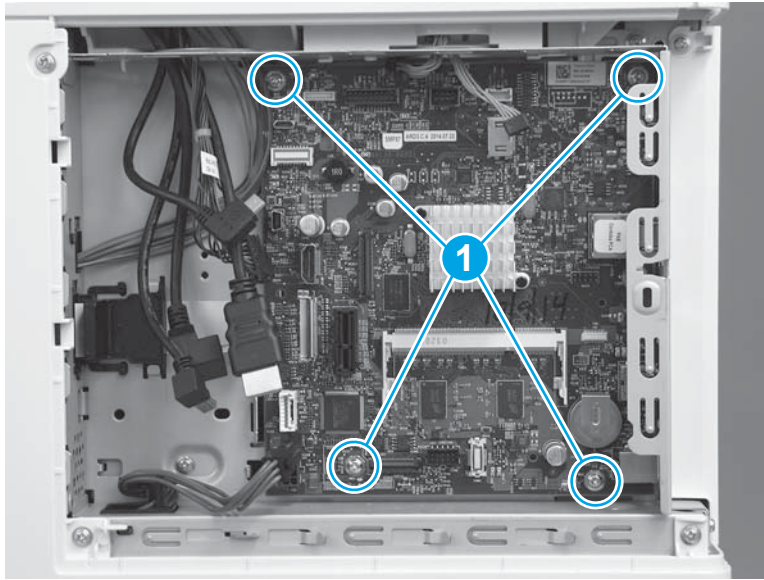

3. Remove the formatter.

Figure 1-2990 Remove the formatter

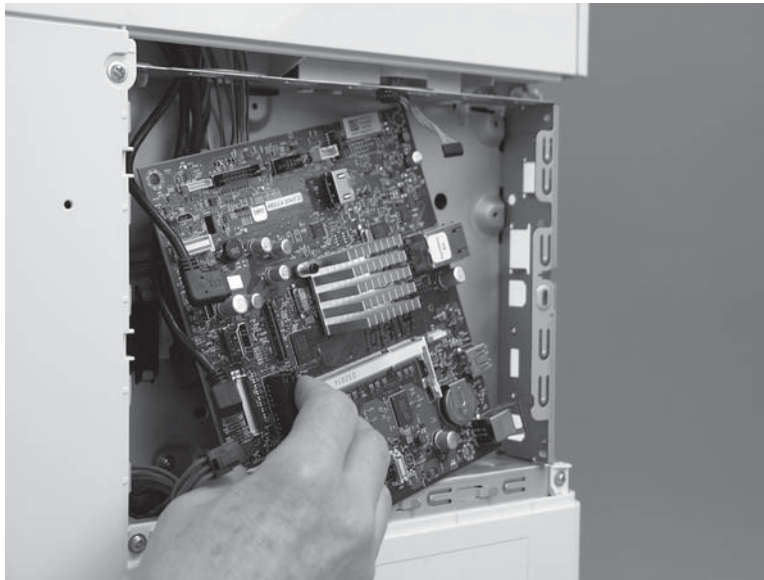

Step 10: Remove the rear cover (M552 and M553)

 **NOTE:** This step is for the M552 and M553 models. For the M577 models, skip this step and go to [Step 11: Remove the rear upper cover \(M577\) on page 1692.](#)

1. Remove four screws (callout 1).

Figure 1-2991 Remove four screws

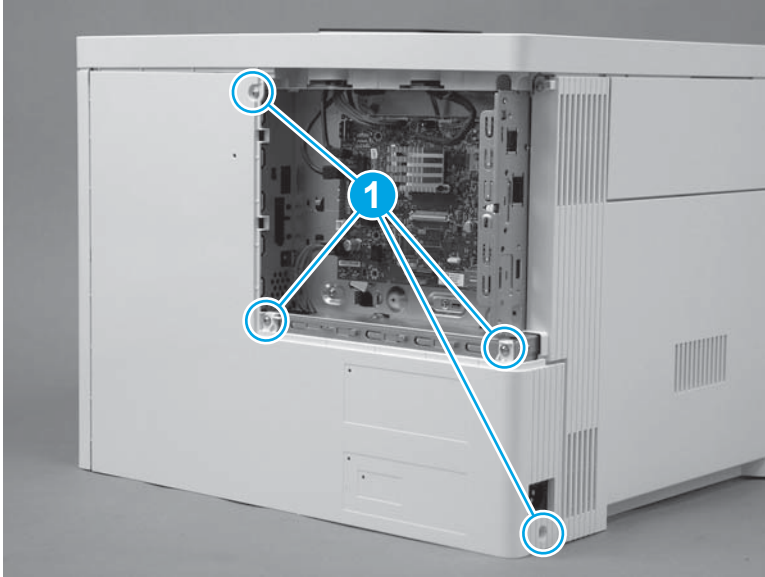

2. Slightly slide the cover to the right (callout 1), rotate the bottom of the cover away from the printer (callout 2), and then pull the top of the cover away from the printer (callout 3) to remove the cover.

Figure 1-2992 Remove the cover

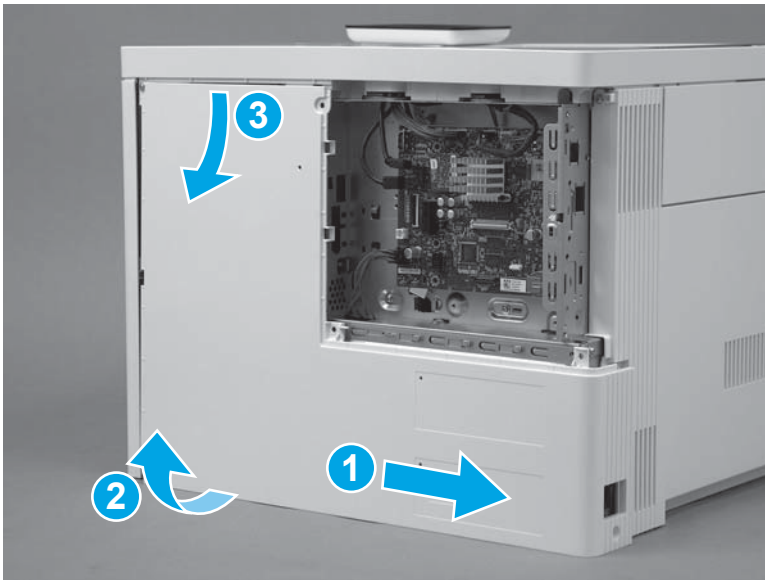

Step 11: Remove the rear upper cover (M577)



NOTE: This step is for the M577 models. For the M552 and M553 models, skip this step and go to [Step 19: Remove the left cover on page 1707](#).

1. Remove two screws (callout 1).



Reinstallation tip: These two screws are self-tapping screws for plastic. When reinstalling them, rotate the screws counterclockwise to align them with the existing thread pattern, and then carefully turn them clockwise to tighten. Do not overtighten. This will prevent stripping the threads inside the screw holes.

Figure 1-2993 Remove two screws

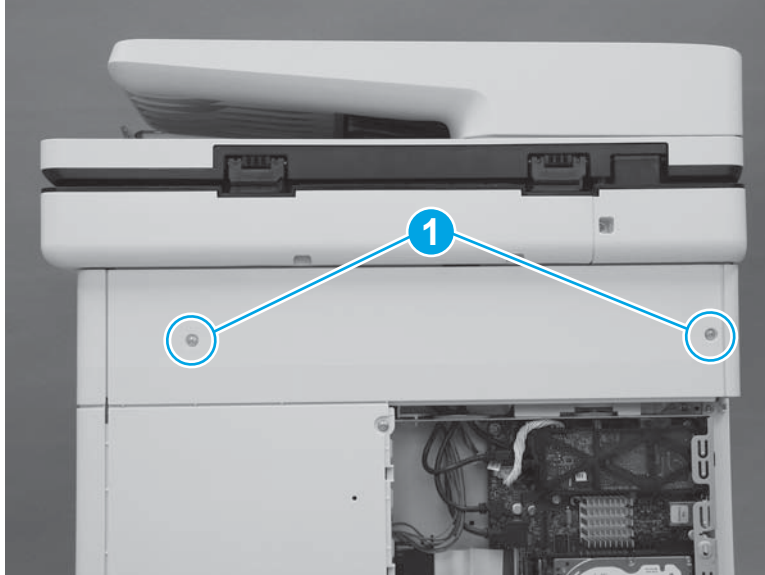

2. Use a small, flat blade screwdriver to release the right edge of the cover.

Figure 1-2994 Release the right edge

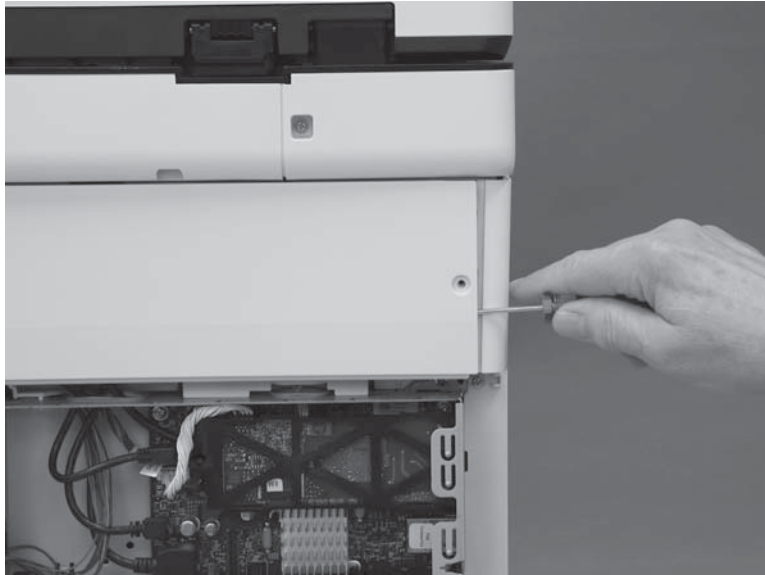

3. Pull the right edge of the cover (callout 1) away from the printer, and then slide the cover to the right (callout 2).

Figure 1-2995 Slide the cover right

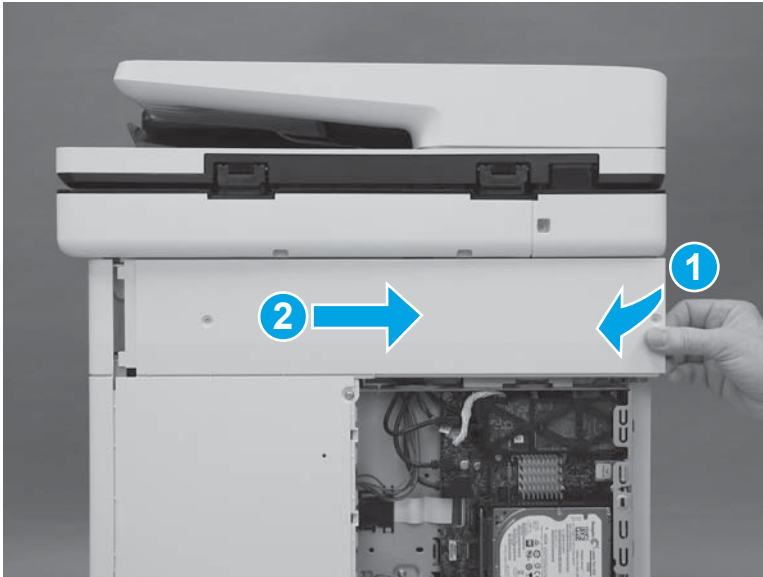

4. Remove the cover.

Figure 1-2996 Remove the cover

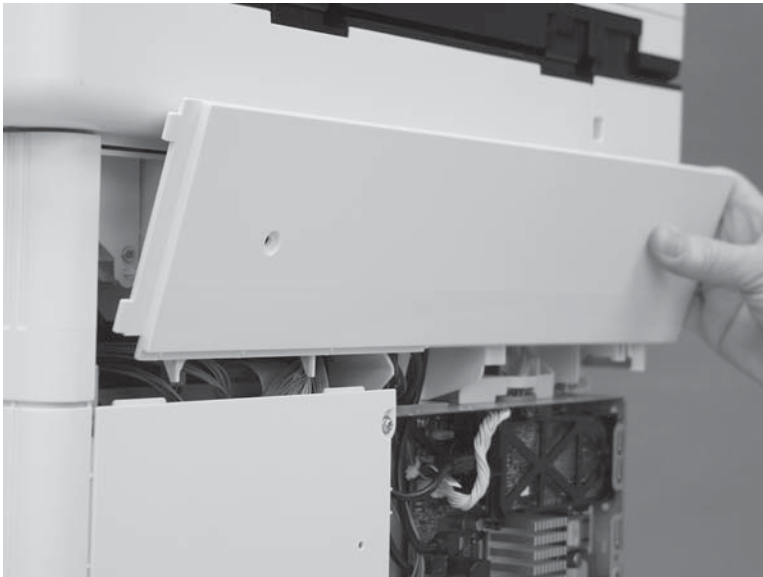

Step 12: Remove the rear cover (M577)



NOTE: This step is for the M577 models. For the M552 and M553 models, skip this step and go to [Step 19: Remove the left cover on page 1707](#).

1. Remove four screws (callout 1).

Figure 1-2997 Remove four screws

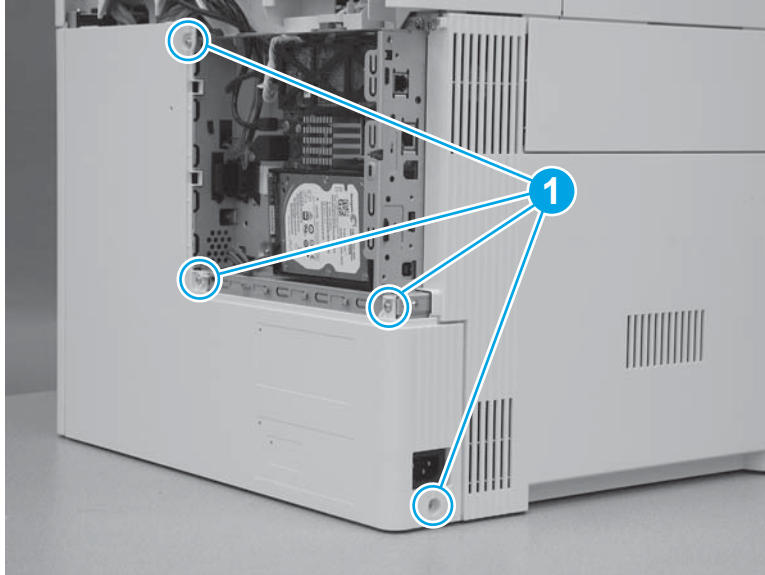

2. Slide the cover to the right to remove it.

Figure 1-2998 Remove the cover

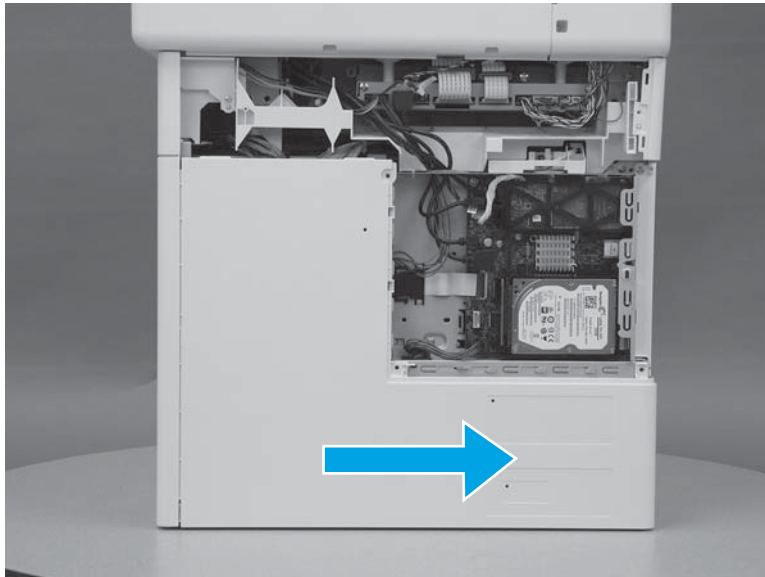

Step 13: Remove the left upper cover (M577)



NOTE: This step is for the M577 models. For the M552 and M553 models, skip this step and go to [Step 19: Remove the left cover on page 1707](#).

1. At the left side of the printer, release one tab (callout 1).

Figure 1-2999 Release one tab

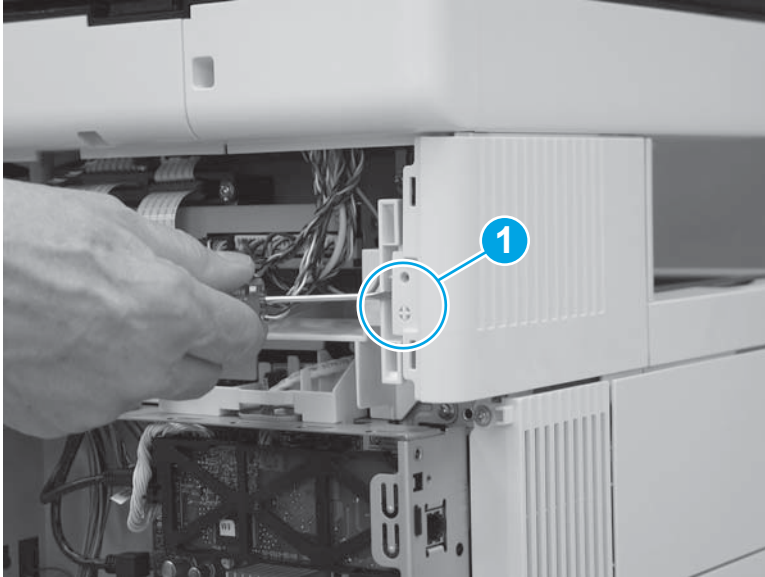

2. Slide the left upper cover toward the back of the printer.

Figure 1-3000 Slide the cover back

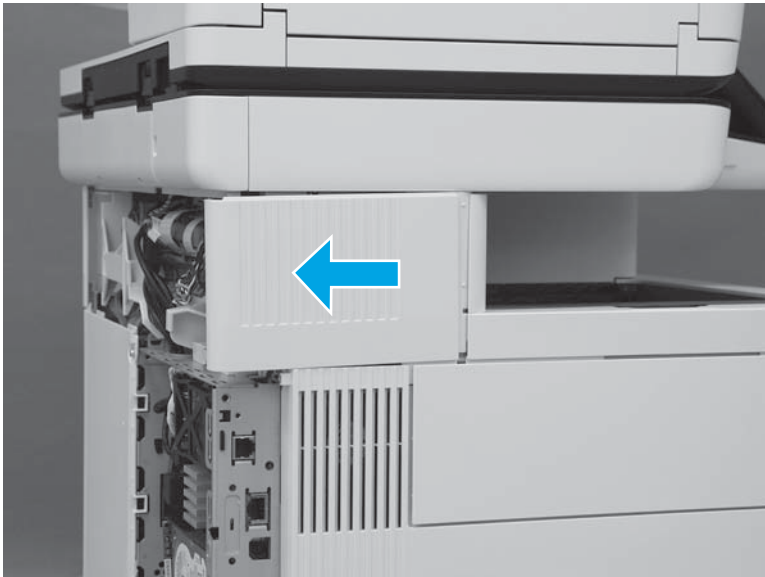

3. Rotate the cover up to remove it.

Figure 1-3001 Remove the left upper cover



Step 14: Remove the right front upper cover (M577dn)

 **NOTE:** This step is for the M577dn model. For the M577c/f/z models, skip this step and to go [Step 15: Remove the stapler cover assembly \(M577c/f/z\) on page 1698.](#)

For the M552 and M553 models, skip this step and go to [Step 19: Remove the left cover on page 1707.](#)

1. Remove one screw (callout 1).

Figure 1-3002 Remove one screw

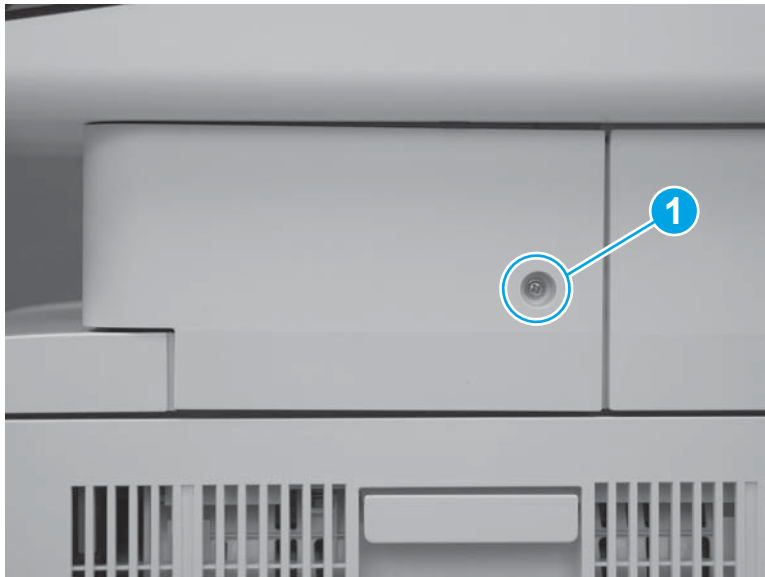

2. Release two tabs at the front edge of the cover (callout 1).

Figure 1-3003 Release two tabs



3. Rotate the front of the cover to the right to remove it.

Figure 1-3004 Rotate the cover



Step 15: Remove the stapler cover assembly (M577c/f/z)



NOTE: This step is for the M577c/f/z models. For the M577dn model, skip this step and go to [Step 17: Remove the right upper cover \(M577\) on page 1703](#).

For the M552 and M553 models, skip this step and go to [Step 19: Remove the left cover on page 1707](#).

1. Remove one screw (callout 1).

 **Reinstallation tip:** This is a self-tapping screw for plastic. When reinstalling, rotate the screw counterclockwise to align it with the existing thread pattern, and then carefully turn it clockwise to tighten. Do not overtighten. This will prevent stripping the threads inside the screw hole.

Figure 1-3005 Remove one screw



2. Release two tabs at the front edge of the cover (callout 1).

Figure 1-3006 Release two tabs

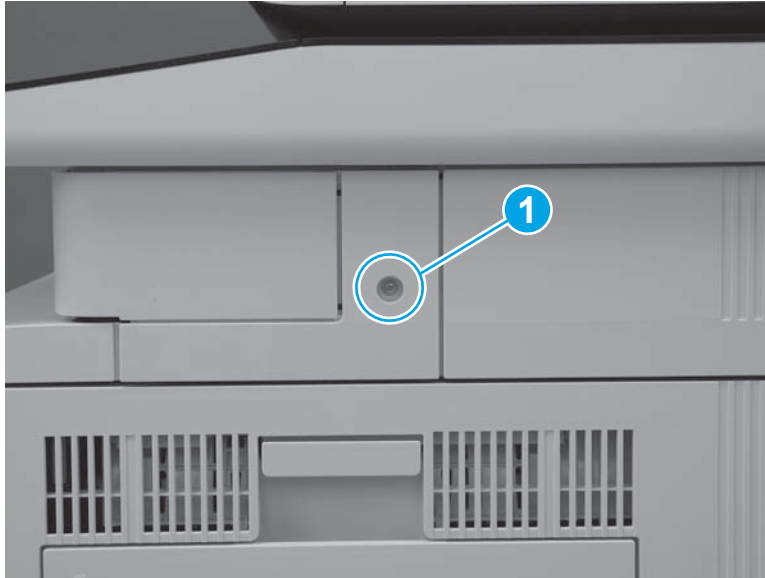

3. Release the back edge of the cover.

Figure 1-3007 Release the back edge of the cover

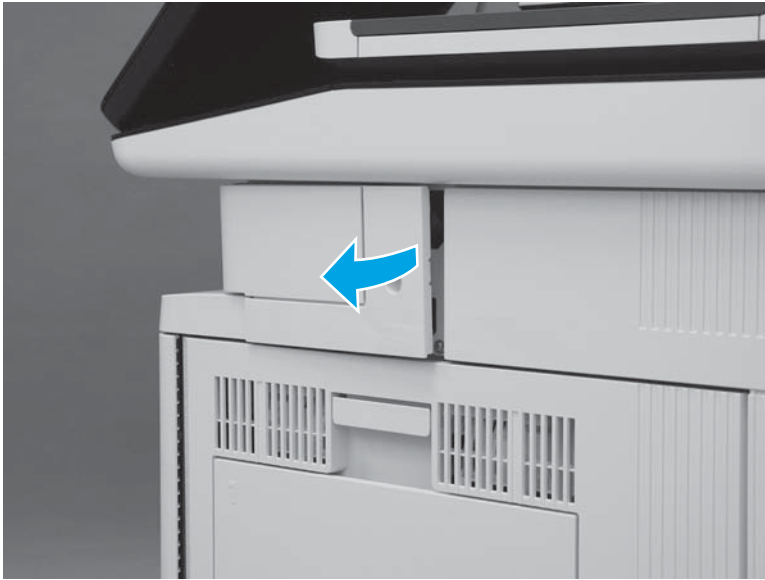

4. Rotate the cover away from the printer to remove it.

Figure 1-3008 Remove the cover



Step 16: Remove the integrated scanner assembly (ISA) (M577)



NOTE: This step is for the M577 models. For the M552 and M553 models, skip this step and go to [Step 19: Remove the left cover on page 1707](#).



NOTE: The ISA includes the document feeder, image scanner, scanner control board (SCB), control panel, keyboard (M577c/z) and NFC PCA (M577z).

1. At the left side of the printer, remove one screw (callout 1).

Figure 1-3009 Remove one screw

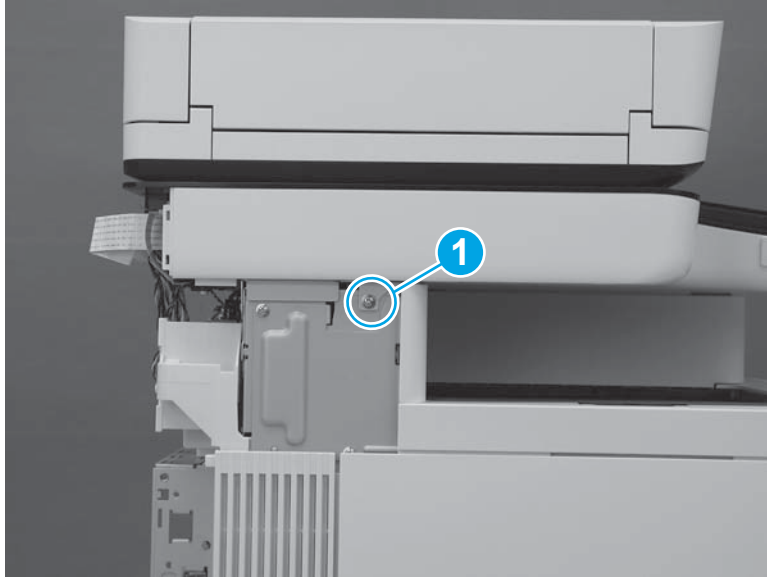

2. At the back side of the printer, remove two screws (callout 1).

Figure 1-3010 Remove two screws

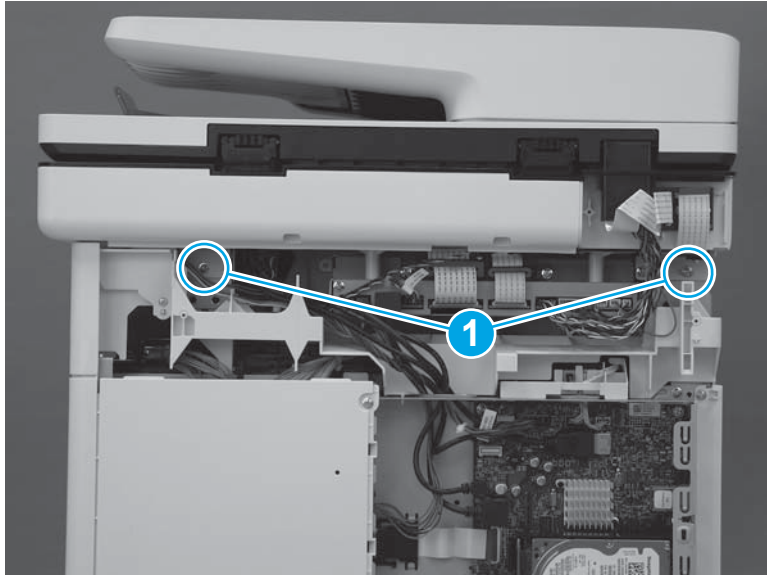

3. At the right side of the printer, remove one screw (callout 1).

Figure 1-3011 Remove one screw

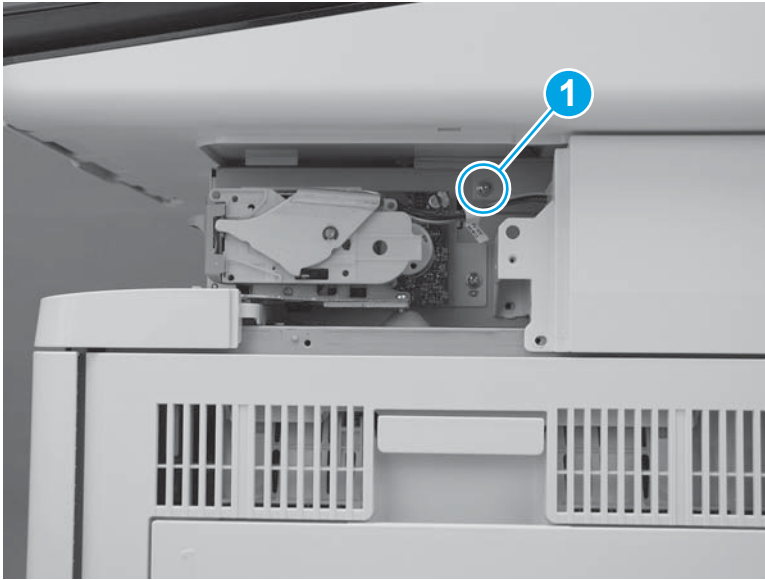

4. Disconnect two connectors on the scanner control board (callout 1).

M577c/f/z only: Disconnect one connector for the stapler on the scanner control board (callout 2).

Figure 1-3012 Disconnect connectors

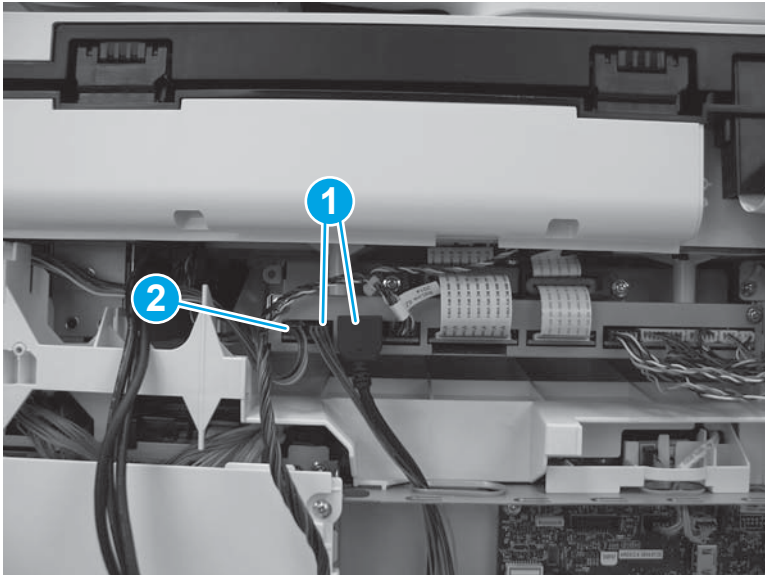

5. Slightly slide the ISA towards the back of the printer to release it.

Figure 1-3013 Slide the ISA towards the back of the printer

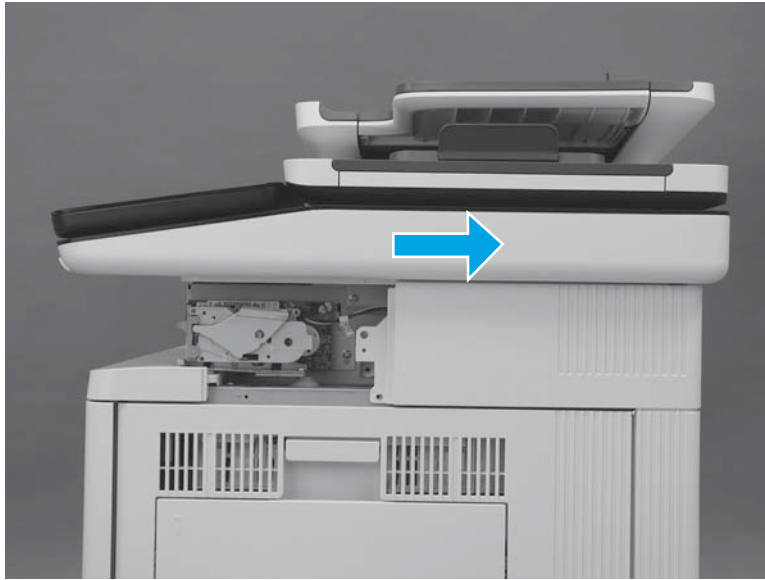

6. Lift the ISA up to remove it.



NOTE: When lifting the ISA, carefully pass the cables through the opening in the top of the formatter case.

Figure 1-3014 Remove the ISA

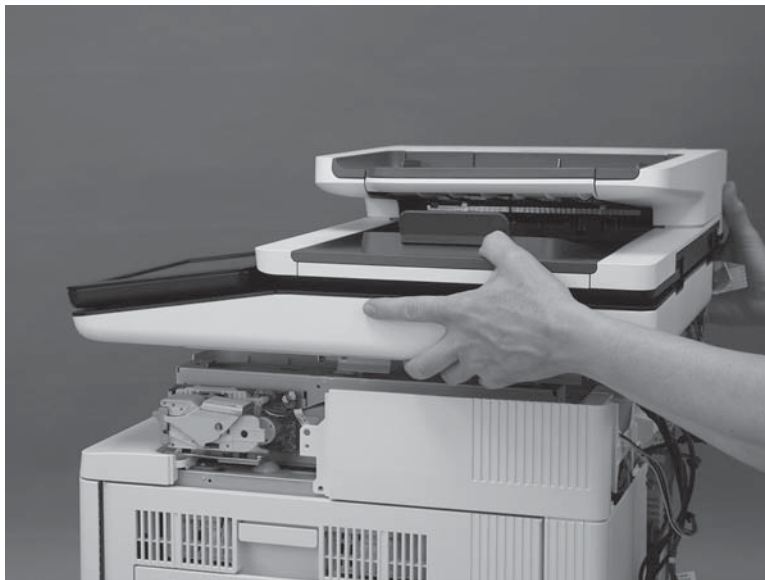

Step 17: Remove the right upper cover (M577)



NOTE: This step is for the M577 models. For the M552 and M553 models, skip this step and go to [Step 19: Remove the left cover on page 1707](#).

 **NOTE:** The figures below show the image scanner installed. The procedures for removing and installing the right upper cover are the same whether the image scanner is installed or removed."

1. At the right side of the printer, remove two screws (callout 1).

M577c/f/z only: Disconnect one connector (callout 2), if it was not already disconnected in a previous step.

Figure 1-3015 Remove two screws and one connector

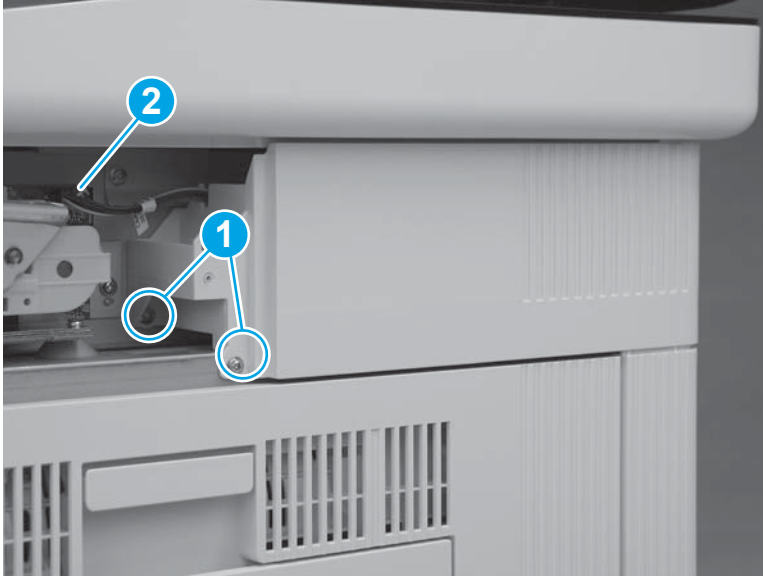

2. At the back of the printer, remove one screw (callout 1).

M577c/f/z only: Disconnect one connector (callout 2), if it was not already disconnected in a previous step.

 **Reinstallation tip:** This screw is smaller than the screws removed in the previous step. When reinstalling the right upper cover, make sure that this screw is installed in the correct position.

Figure 1-3016 Remove one screw and connector



3. Slide the cover toward the back of the printer.

Figure 1-3017 Slide the cover

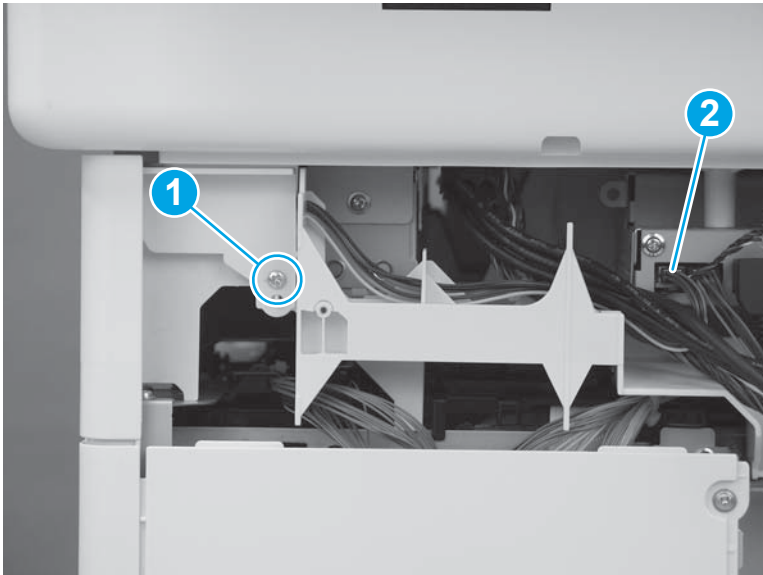
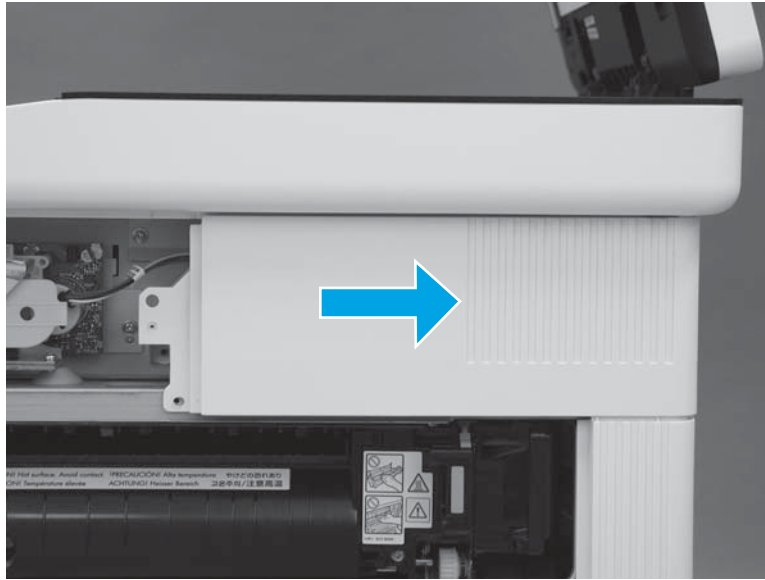

4. Lift the cover away from the printer to remove it.

M577c/f/z only: Release the cables (callout 1) through the slot (callout 2) in the printer.

Figure 1-3018 Remove the cover

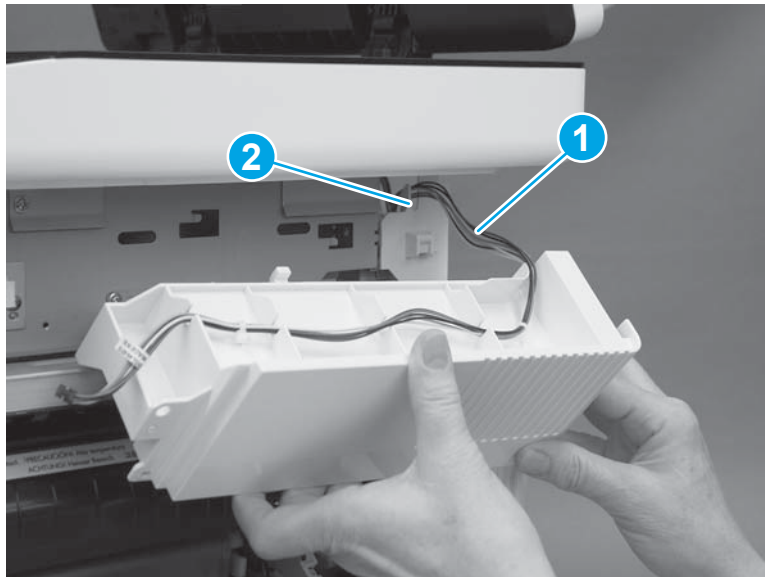

Step 18: Remove the top rear cover (M577)

 **NOTE:** This step is for the M577 models. For the M552 and M553 models, skip this step and go to [Step 19: Remove the left cover on page 1707](#).

1. At the top of the printer, remove five screws (callout 1).

Figure 1-3019 Remove five screws

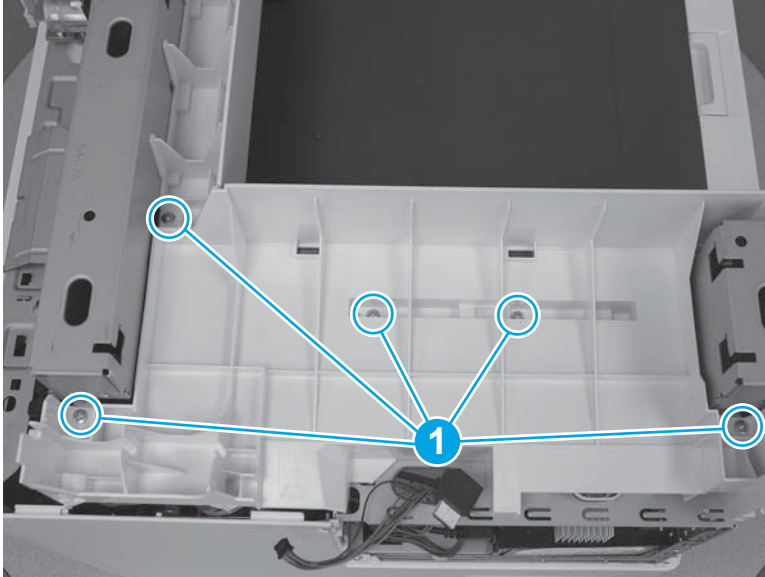

2. Release two tabs (callout 1) on the front edge of the cover.

Figure 1-3020 Release two tabs

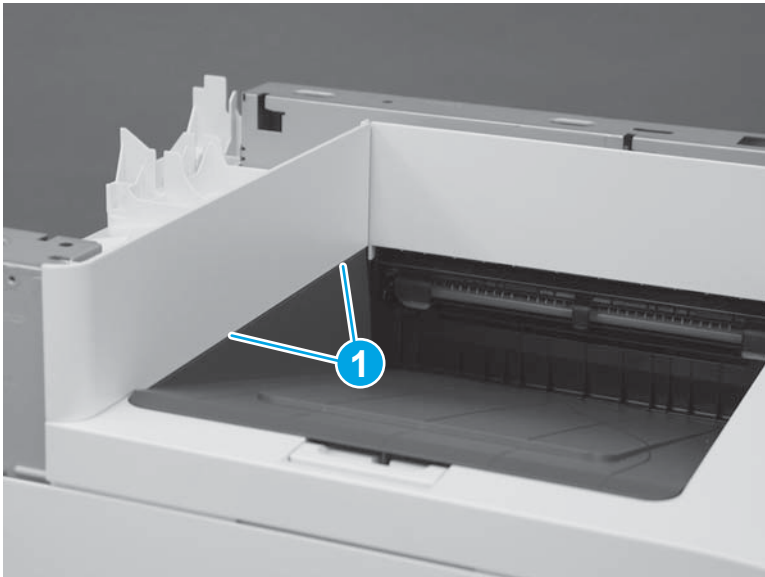

3. Remove the top rear cover.

Figure 1-3021 Remove the top rear cover

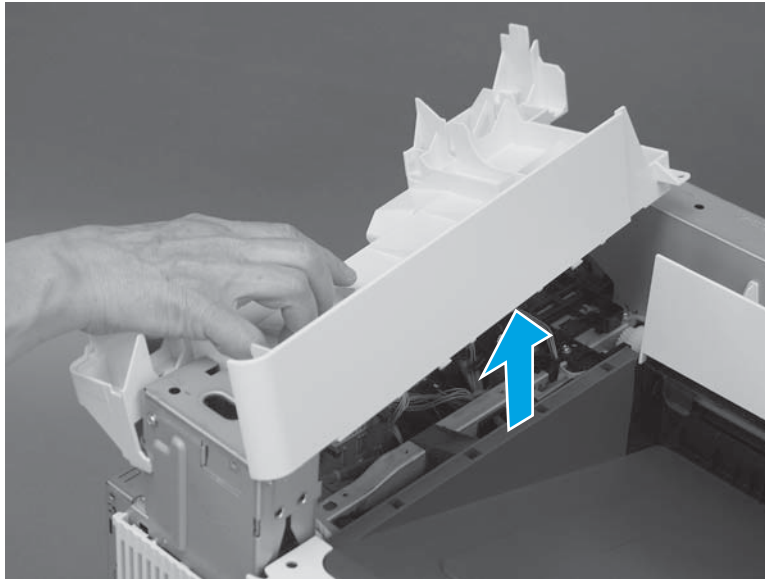

Step 19: Remove the left cover

1. At the left side of the printer, remove one screw (callout 1).

Figure 1-3022 Remove one screw



2. Release one tab (callout 1), rotate the front edge of the cover away from the printer (callout 2), and then slide the cover (callout 3) toward the rear of the printer to release it.

Figure 1-3023 Release the cover

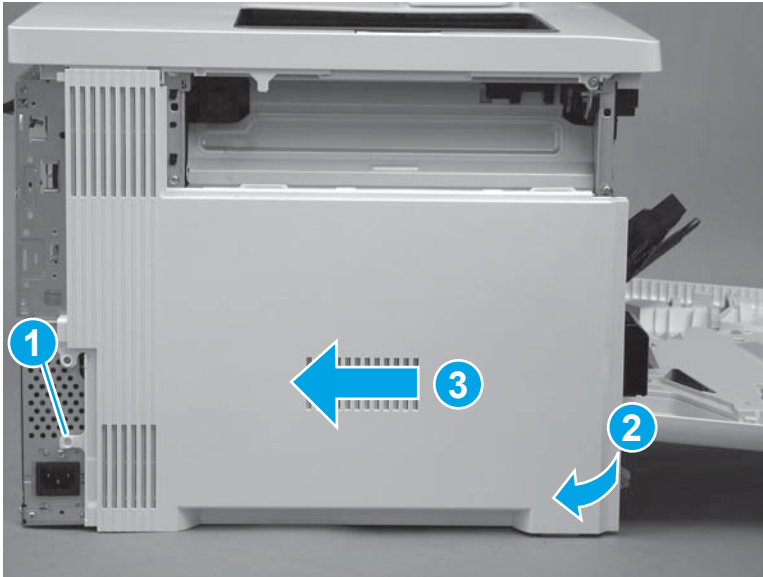

3. Remove the cover.

Figure 1-3024 Remove the cover

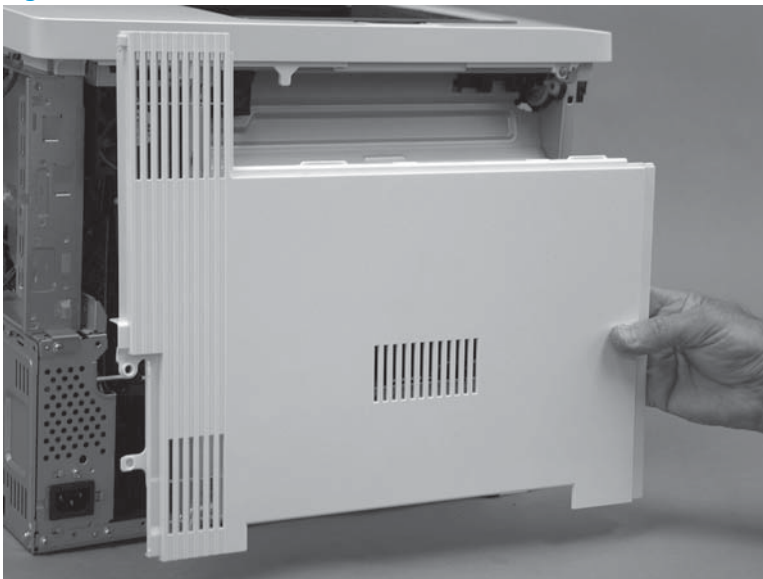

Step 20: Remove the upper cover (M552 and M553)



NOTE: This step is for the M552 and M553 models. For the M577 models, skip this step and go to [Step 21: Remove the formatter case on page 1710.](#)

1. Remove three screws (callout 1).

Figure 1-3025 Remove three screws

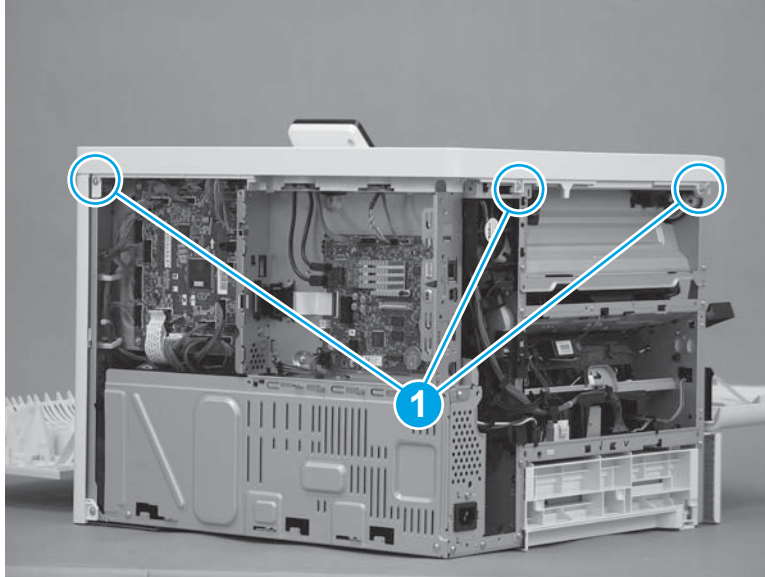

2. Remove one screw (callout 1), release one tab (callout 2), and then slightly separate the corner of the cover from the chassis.

 **NOTE:** This is a self-tapping plastic-thread screw. Make sure that this screw is used in this location when it is reinstalled.

Figure 1-3026 Remove one screw and release one tab



3. Release one tab (callout 1), and then lift up on the cover to release it.



NOTE: If the cover does not release, check for additional tabs by locating the triangles embossed in the cover at tab locations.

Figure 1-3027 Release the cover

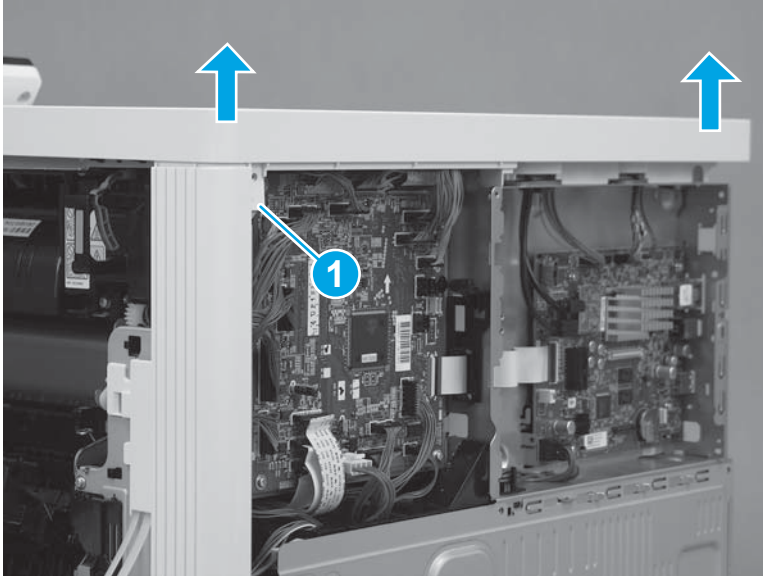

4. Remove the cover.

Figure 1-3028 Remove the cover

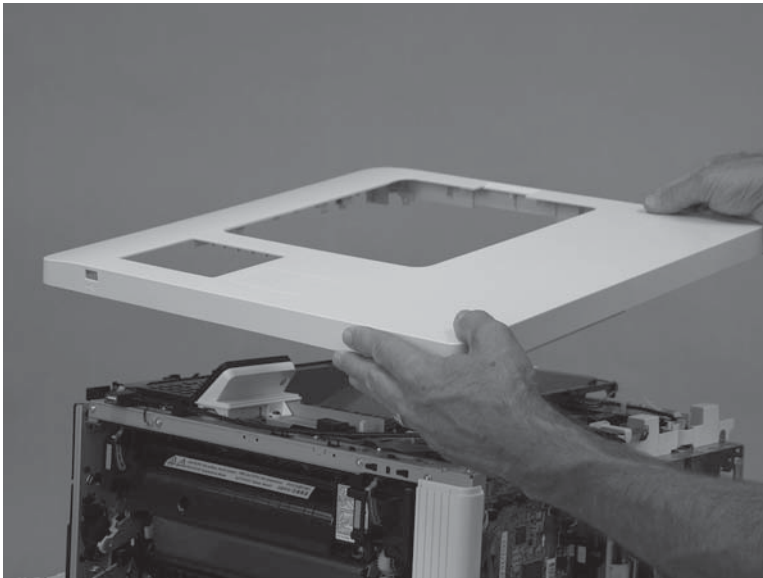

Step 21: Remove the formatter case

1. **M577 only:** Disconnect one connector (callout 1), and then pass the wire harness (callout 2) through two openings in the formatter case (callout 3).

Figure 1-3029 Disconnect one connector

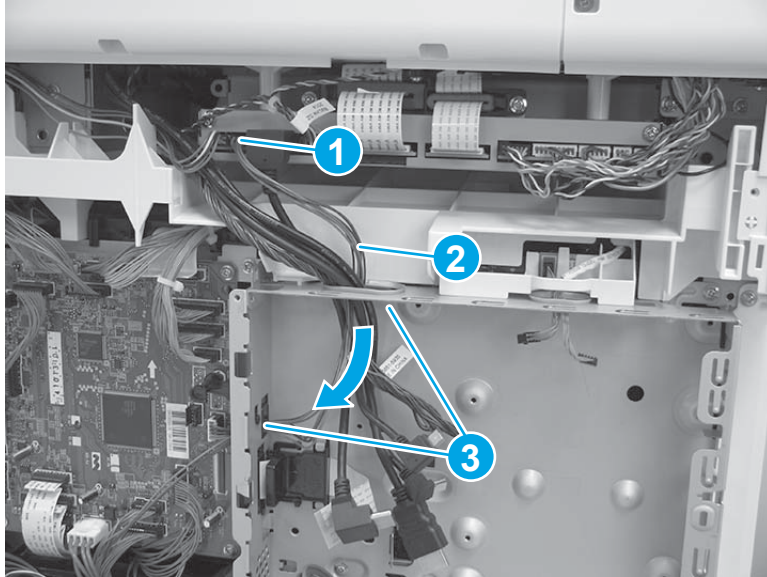

2. Release two tabs (callout 1) on the black plastic bracket. Hold the tabs in the released position, and then slide the bracket (callout 2) to the right to remove it from the formatter case.

Figure 1-3030 Remove the bracket

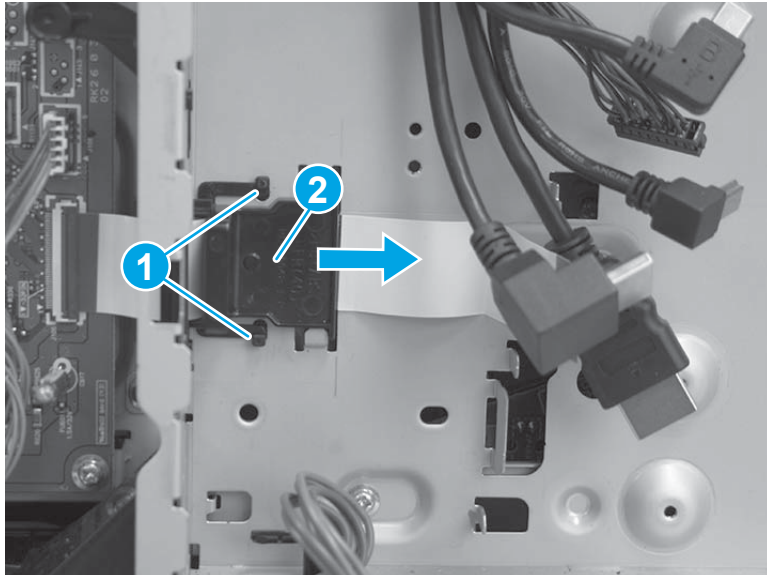

3. Remove two screws (callout 1), and then slide the low-voltage power supply (LVPS) cover to the right to remove it.

Figure 1-3031 Remove the LVPS cover

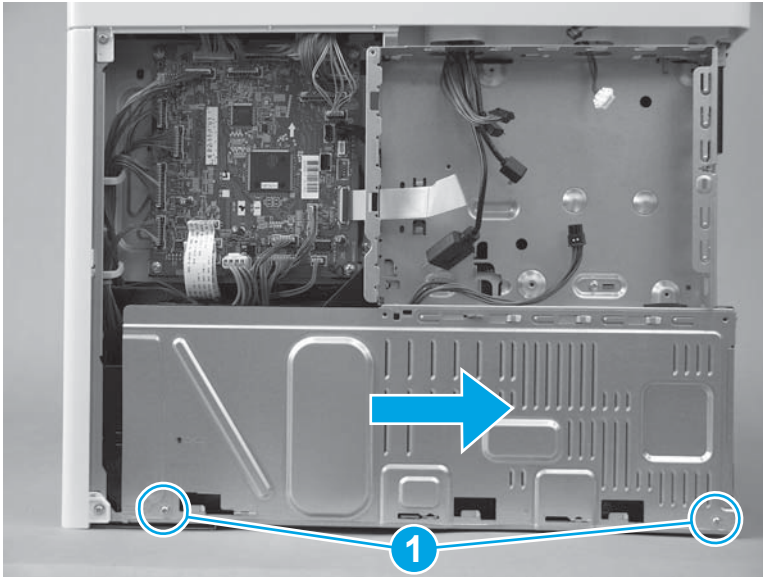

4. Pass two wire harnesses and one flat cable (callout 1) through the opening in the formatter case, and then release one wire harness from the retainer (callout 2).

CAUTION: The flat cable might be attached to the formatter case with double-sided tape. Make sure that this tape is released, so that the flat cable is not damaged when the formatter case is removed.

Figure 1-3032 Release wire harnesses and flat cable

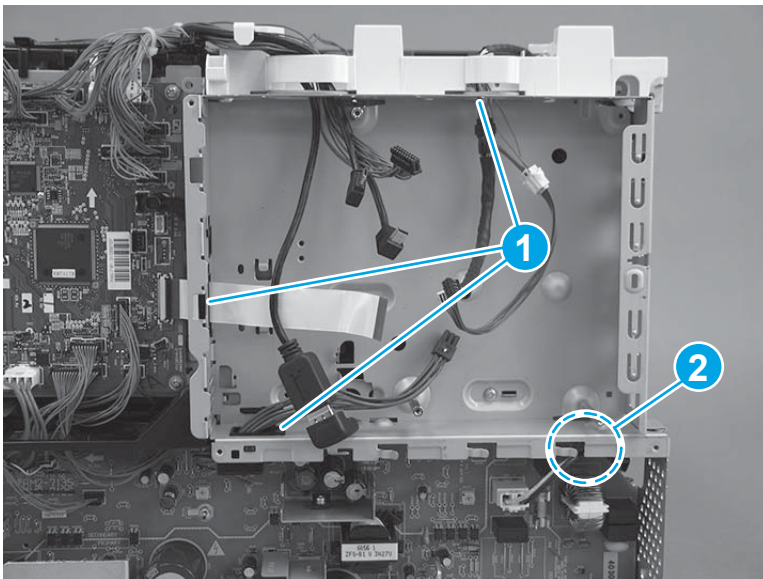

5. Remove six screws (callout 1).

Figure 1-3033 Remove six screws

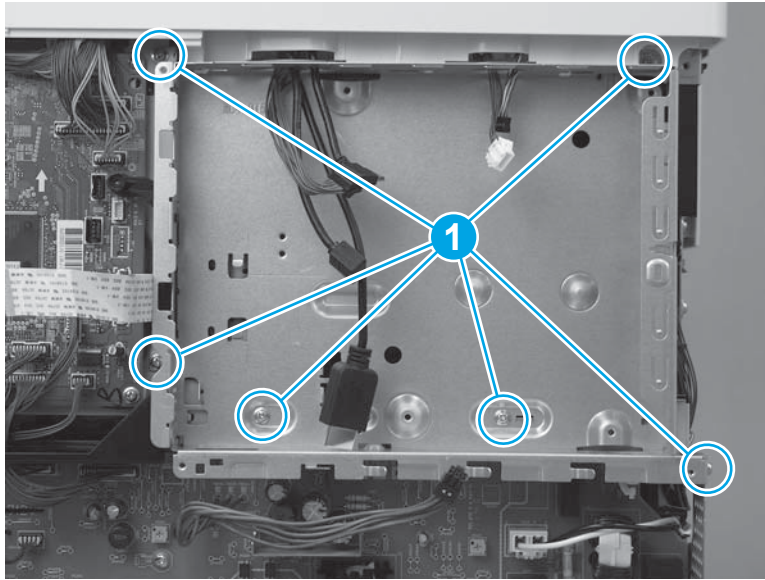

6. Rotate the bottom of the formatter case away from the printer (callout 1), and then pull it down (callout 2) to release it.

Figure 1-3034 Release the formatter case

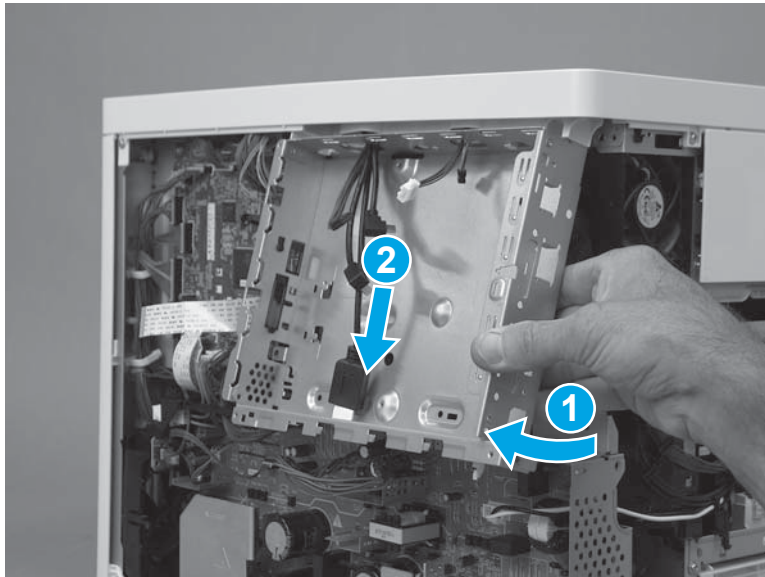

7. Pass the wire harnesses through the opening in the formatter case to remove it.

IMPORTANT: If the formatter case is removed so that it can be replaced, make sure to transfer the memory PCA (island of data) and plastic bracket (callout 1) to the replacement case.

Figure 1-3035 Remove the formatter case

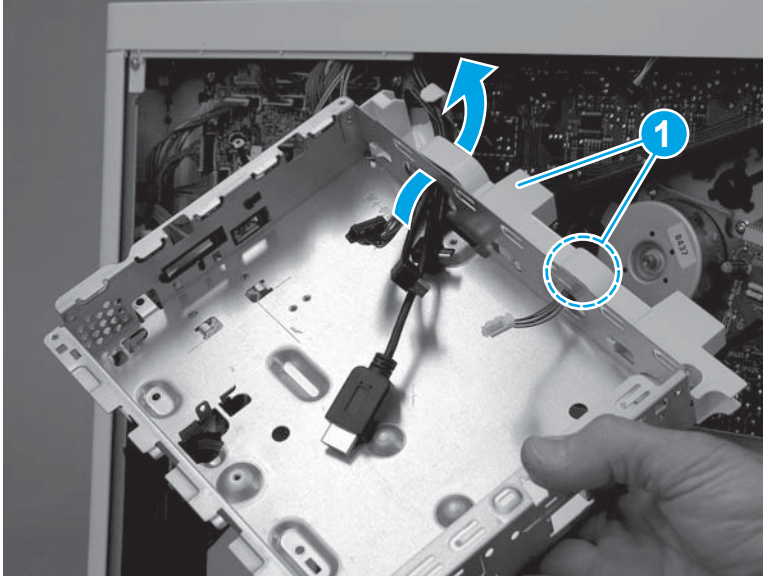

Step 22: Remove the right rear cover

1. Remove one screw (callout 1), and then slide the cover toward the rear of the printer (callout 2) to release it.

TIP: If the right door is closed, open it now.

Figure 1-3036 Release the cover

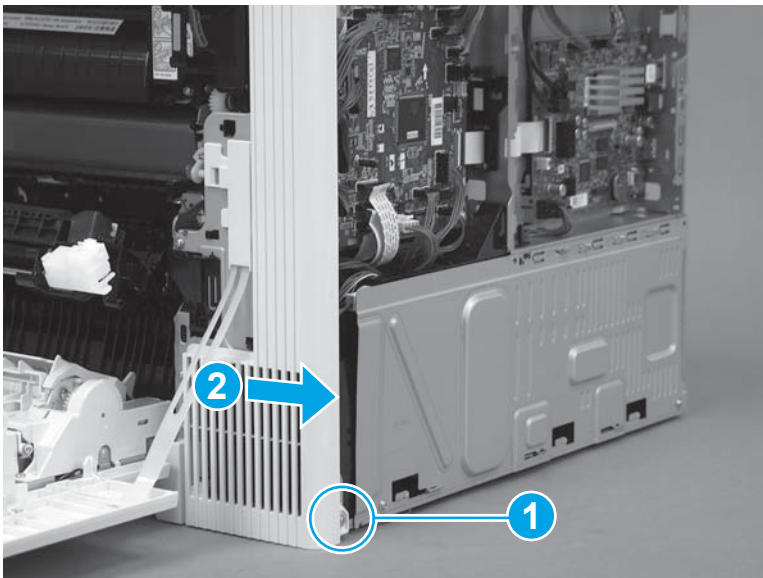

2. Remove the cover.

Figure 1-3037 Remove the cover

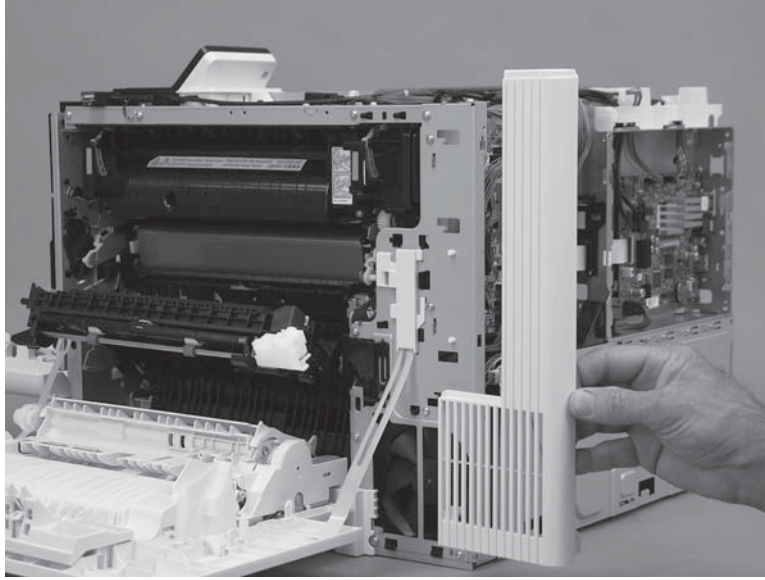

Step 23: Remove the DC controller and sheet-metal bracket

CAUTION:  ESD sensitive part.

1. Disconnect all of the connectors, and then remove two screws (callout 1).

The following connectors are empty:

- J140, J141, and J143

Figure 1-3038 Remove two screws

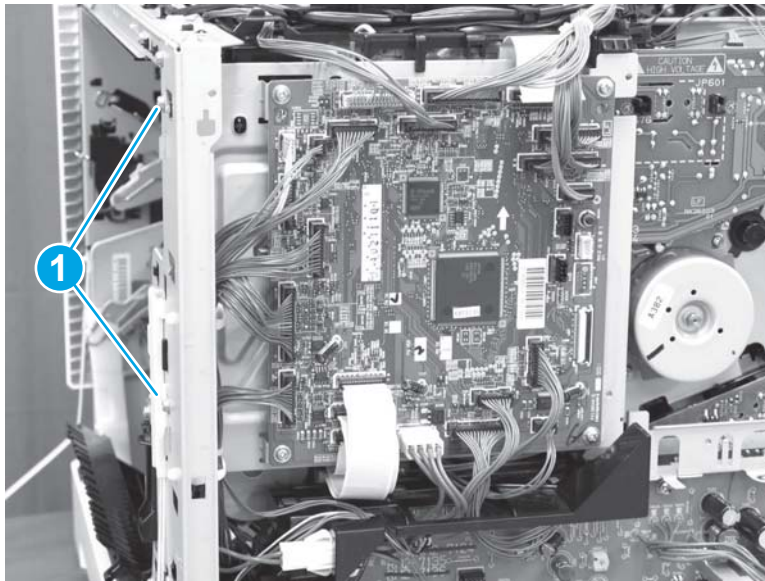

2. Lift up on the DC controller and sheet-metal plate to remove it.

Figure 1-3039 Remove the plate

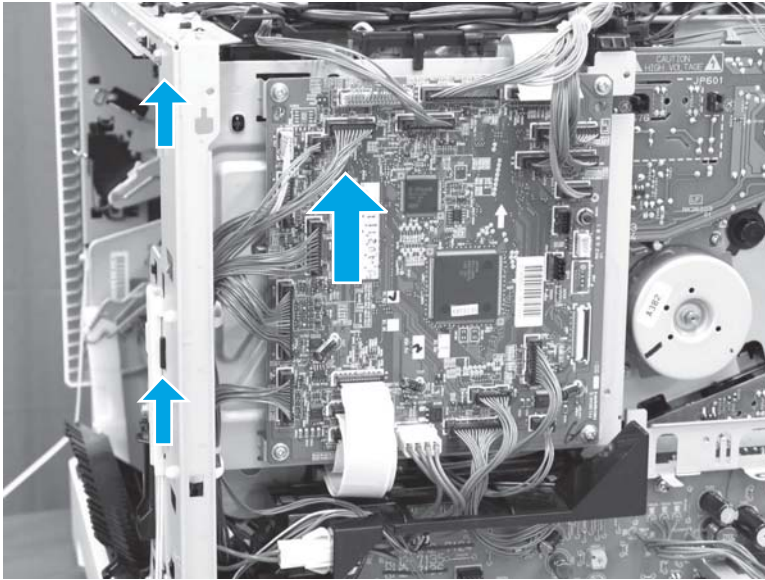

Step 24: Remove the high-voltage power supply T (HVPST)

 **CAUTION:**  ESD-sensitive part.

1. Disconnect five connectors (callout 1), and then disconnect one flat cable (callout 2).

Figure 1-3040 Disconnect five connectors and one flat cable

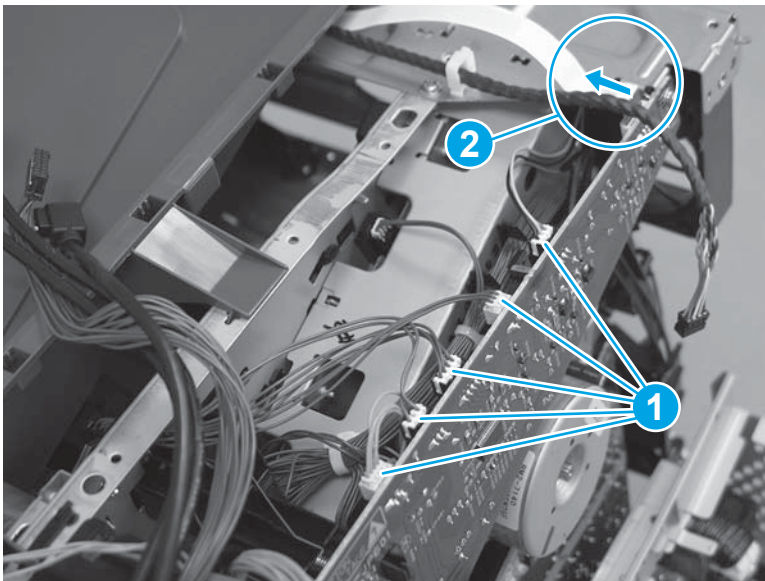

2. Remove one screw (callout 1).

Figure 1-3041 Remove one screw

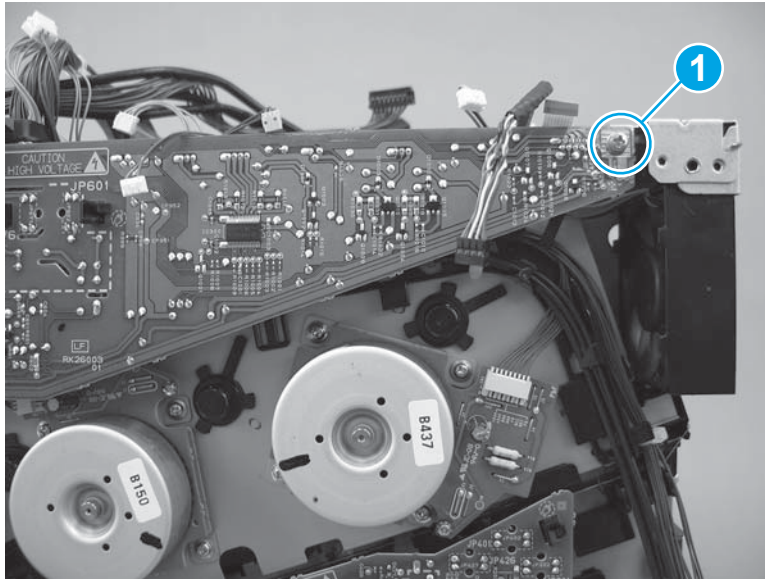

3. Release two tabs (callout 1), and then separate the HVPST from the printer.

⚠ CAUTION: Do not attempt to completely remove the HVPST. It is still connected to the printer by ground wire harness.

Figure 1-3042 Release the HVPST

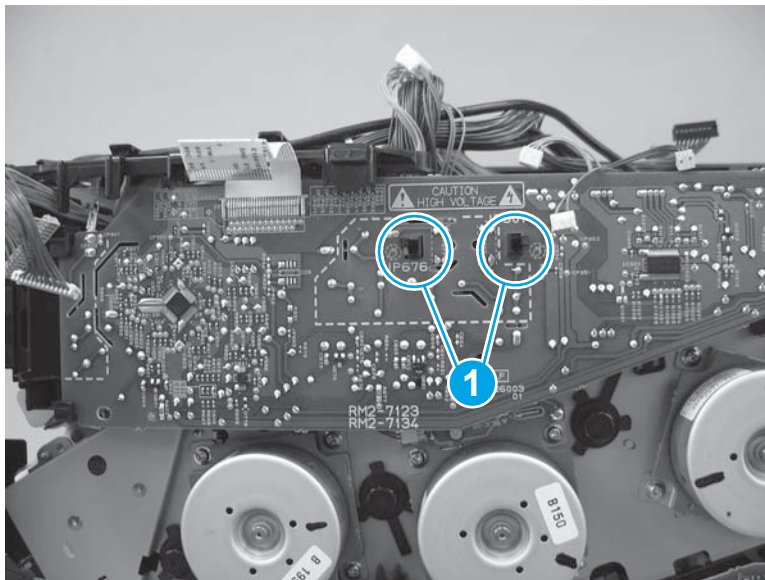

4. Release one ground wire connector (callout 1), and then remove the HVPST.

Figure 1-3043 Remove the HVPST

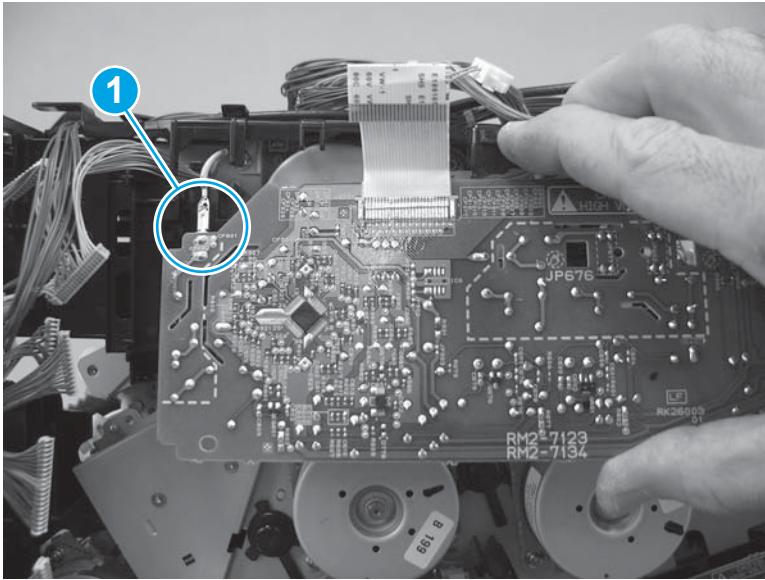

Step 25: Remove the fuser motor (M4)

- ▲ Disconnect one connector (callout 1), remove three screws (callout 2), and then remove the motor.

Figure 1-3044 Remove the motor

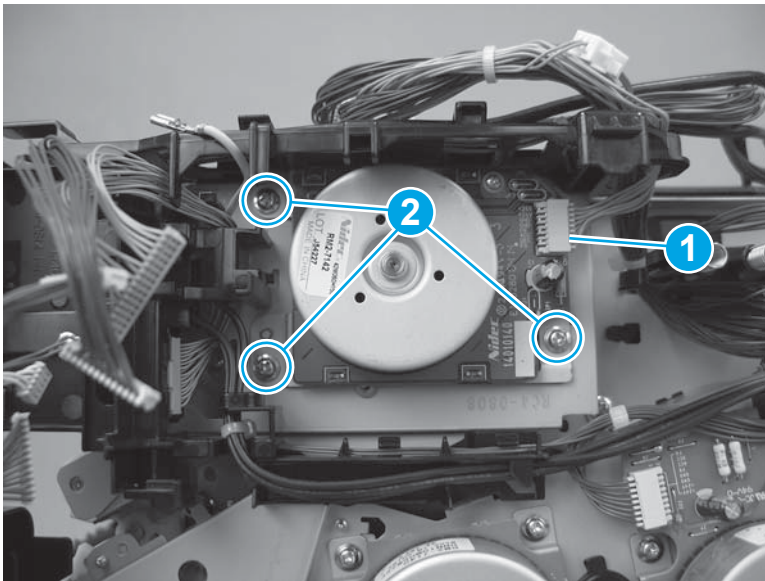

Step 26: Unpack the replacement assembly

Unpack the replacement assembly from the packaging.

For complete information on HP's recycling programs, go to [Product return and recycling](#).



NOTE: HP recommends responsible disposal of the defective assembly.

Figure 1-3045 Recycle and unpack

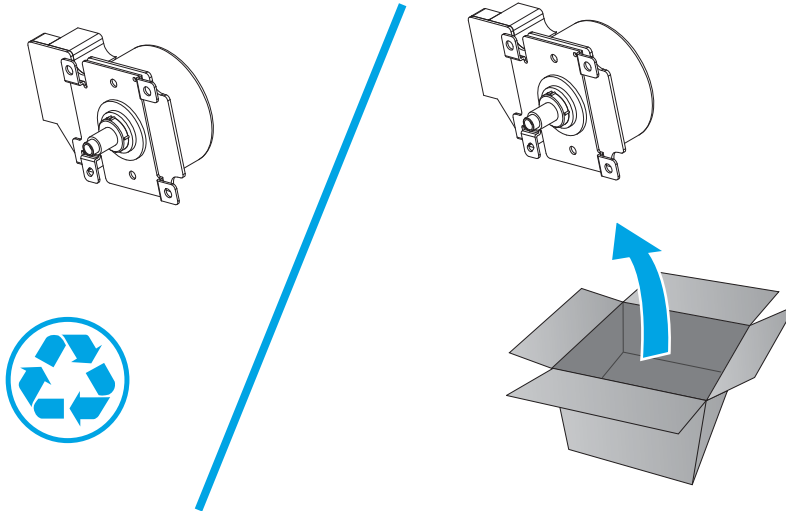

Step 27: Install the fuser motor (M4)

- ▲ Position the motor on the printer, install three screws (callout 1), and then connect one connector (callout 2).

Figure 1-3046 Install the motor

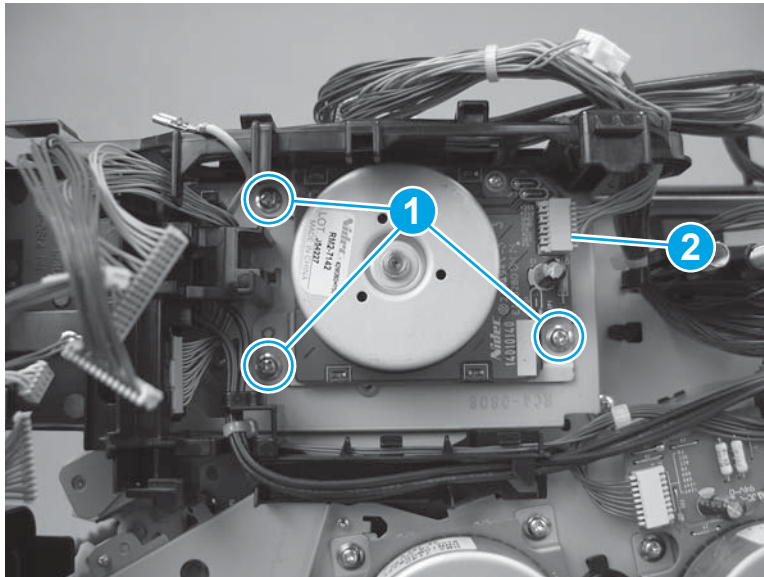

Step 28: Install the HVPST

⚠ **CAUTION:**  ESD-sensitive part.

1. Connect one ground wire connector (callout 1).

Figure 1-3047 Connect one ground wire

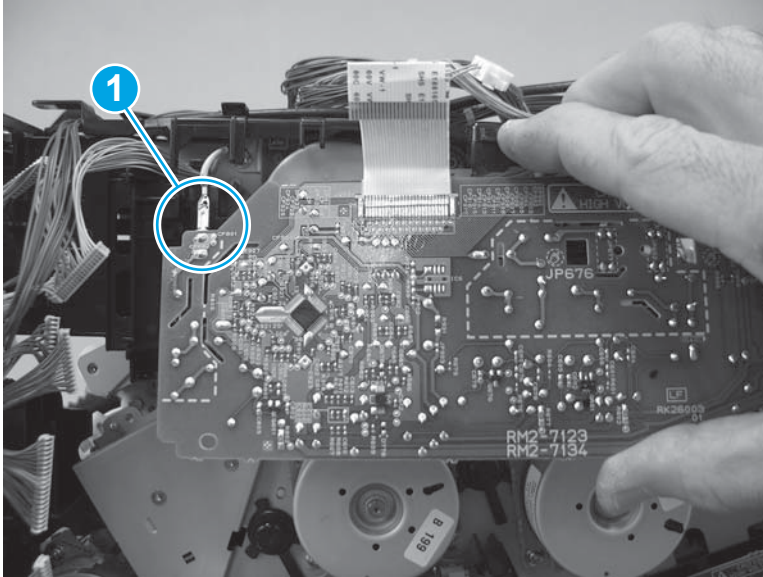

2. Position the HVPST on the printer, and then push in to engage two tabs (callout 1).

 **NOTE:** Make sure that the tabs snap into place.

Figure 1-3048 Install the HVPST



3. Install one screw (callout 1).

Figure 1-3049 Install one screw

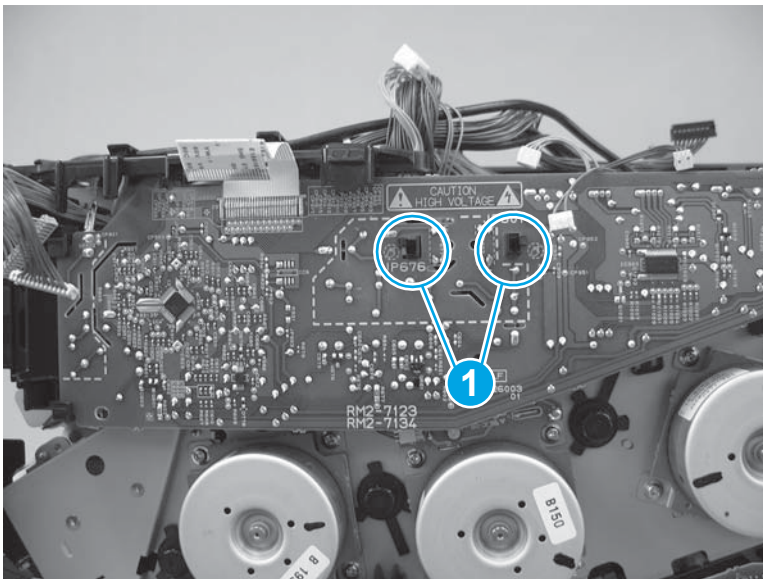
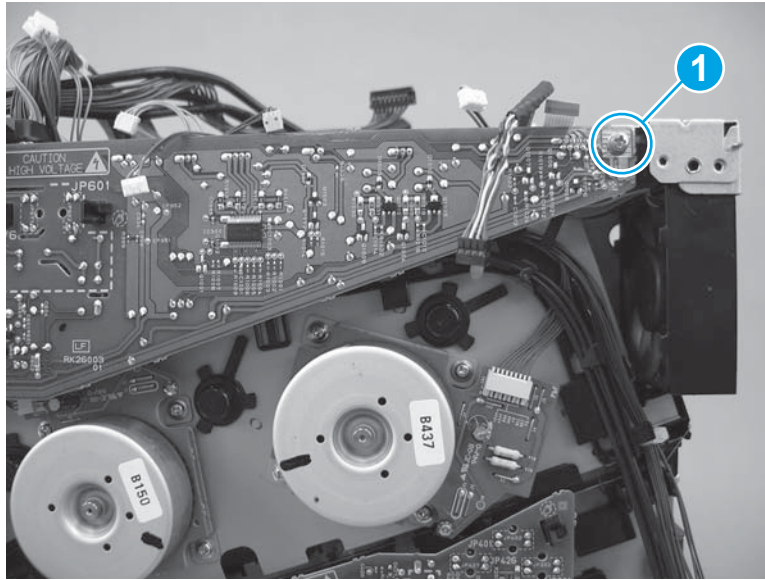

4. Connect five connectors (callout 1), and then connect one flat cable (callout 2).

Figure 1-3050 Connect five connectors and one flat cable

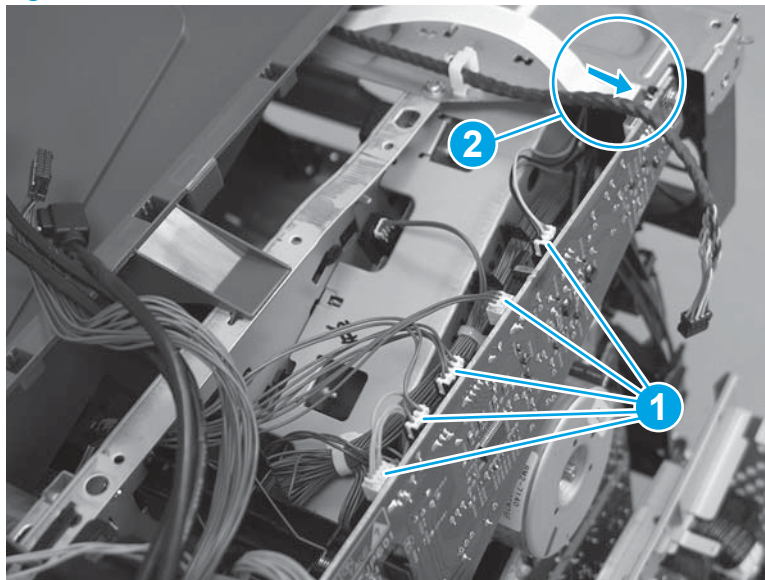

Step 29: Install the DC controller and sheet-metal bracket

 **CAUTION:**  ESD-sensitive part.

1. Position the DC controller and sheet-metal plate on the printer, and then push down to engage the plate with the chassis.

Figure 1-3051 Install the plate

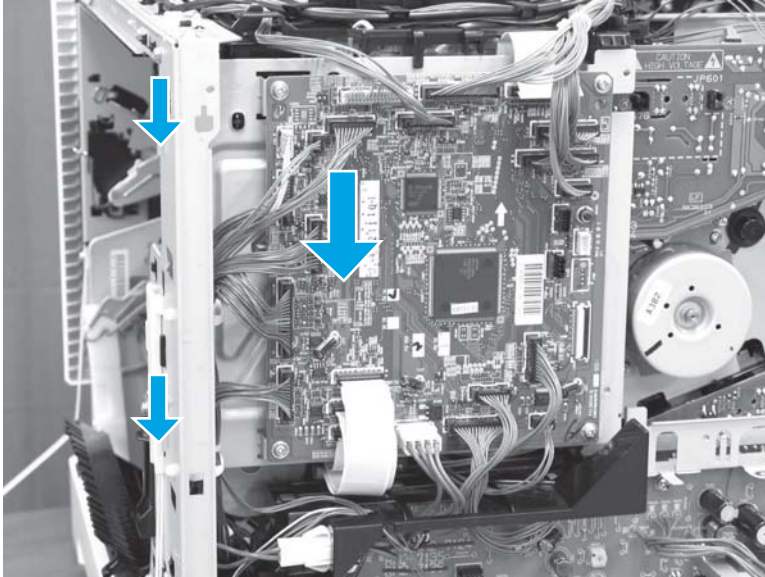

2. Install two screws (callout 1), and then connect all of the connectors.

The following connectors are empty:

- J140, J141, and J143

Figure 1-3052 Install two screws

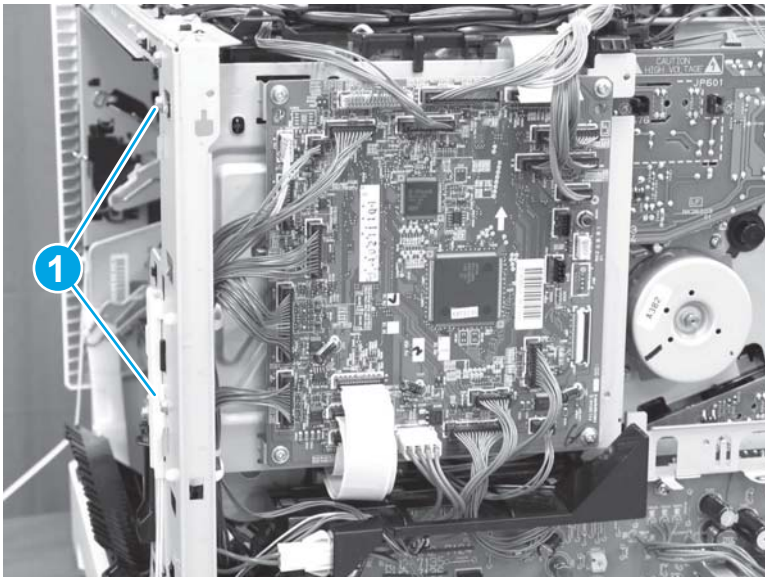

Step 30: Install the right rear cover

1. Position the cover on the printer.

Figure 1-3053 Install the cover

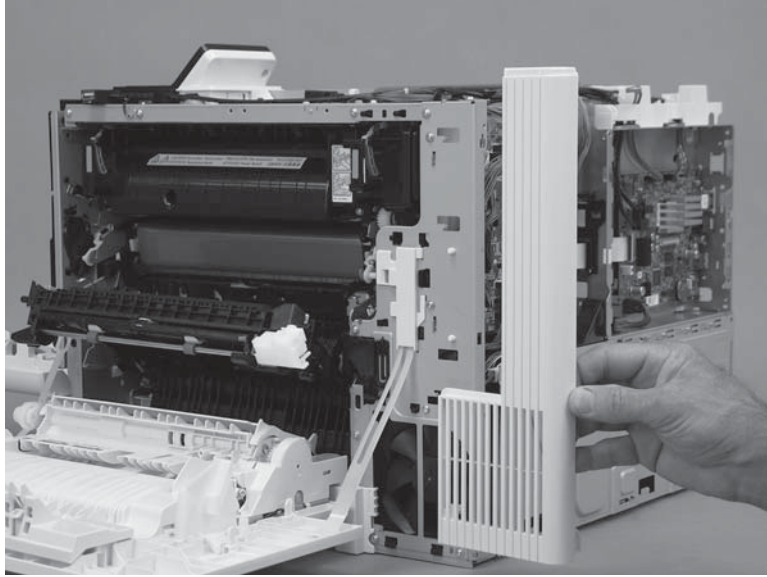

2. Slide the cover toward the right door (callout 1) to engage it with the printer, and then install one screw (callout 2).

Figure 1-3054 Install one screw

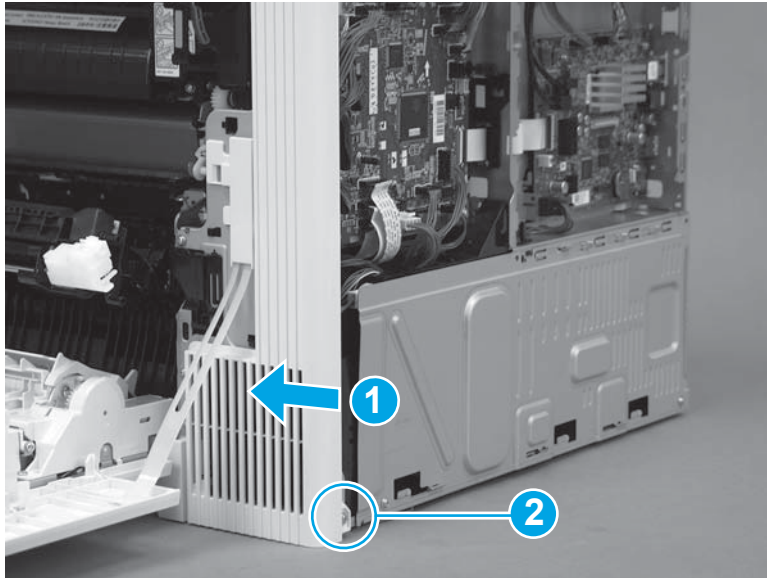

Step 31: Install the formatter case

1. Pass the wire harnesses through the opening in the formatter case.

Figure 1-3055 Pass the wire harnesses through the opening

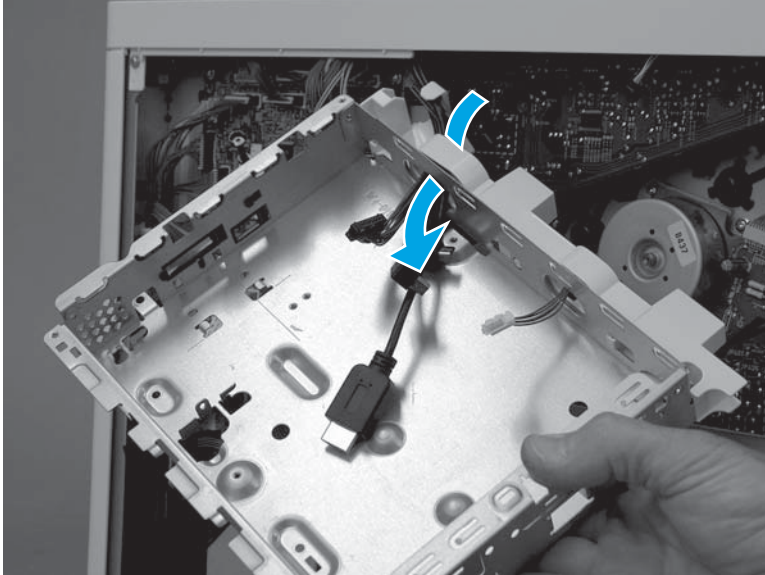

2. Position the top of the formatter case on the printer (callout 1), and then rotate the bottom of the case (callout 2) into the printer.

Figure 1-3056 Install the formatter case

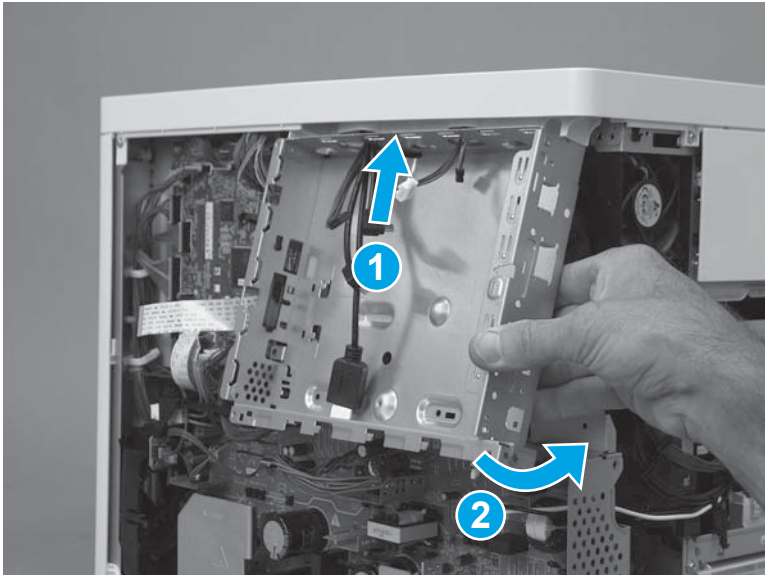

3. Install six screws (callout 1).

Figure 1-3057 Install six screws

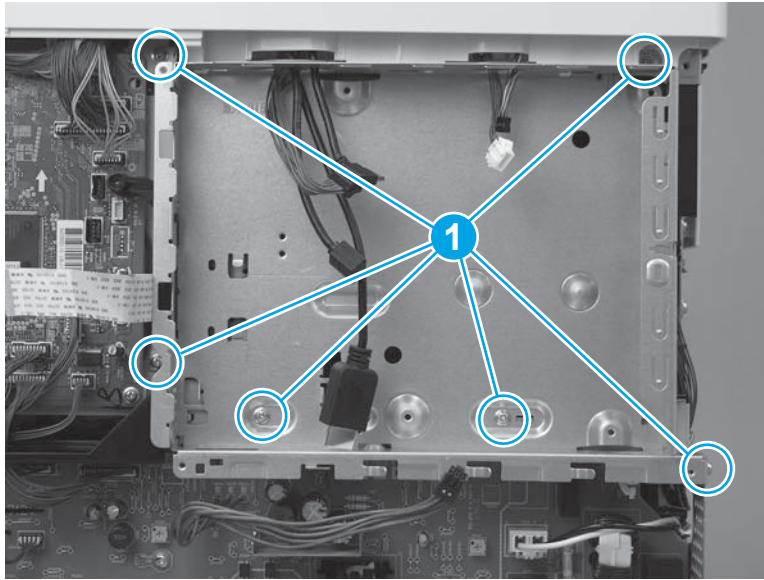

4. Pass two wire harnesses and one flat cable (callout 1) through the opening in the formatter case, and then install one wire harness in the retainer (callout 2).

 **IMPORTANT:** Make sure that the flat cable is securely fastened to the DC controller, and was not dislodged when the formatter case was removed.

Figure 1-3058 Install wire harnesses and flat cable



5. Position the LVPS cover on the printer, slide the cover to the left to install it, and then install two screws (callout 1).

Figure 1-3059 Install the LVPS cover

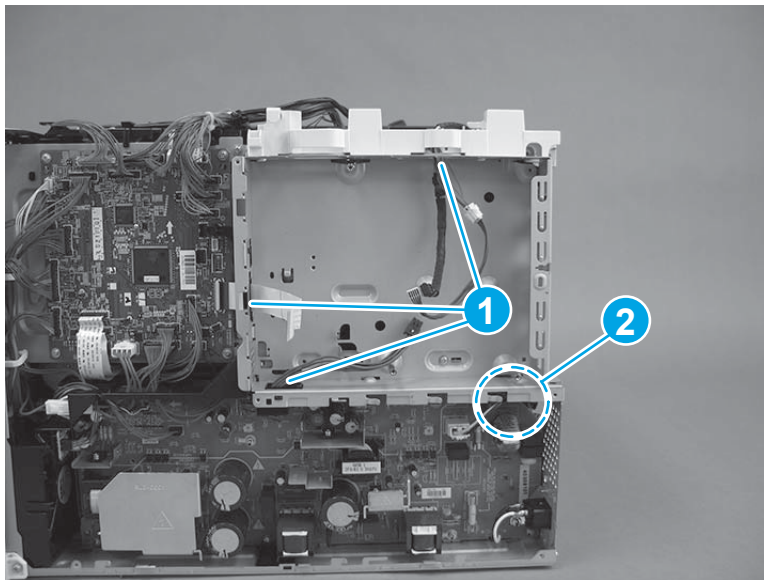
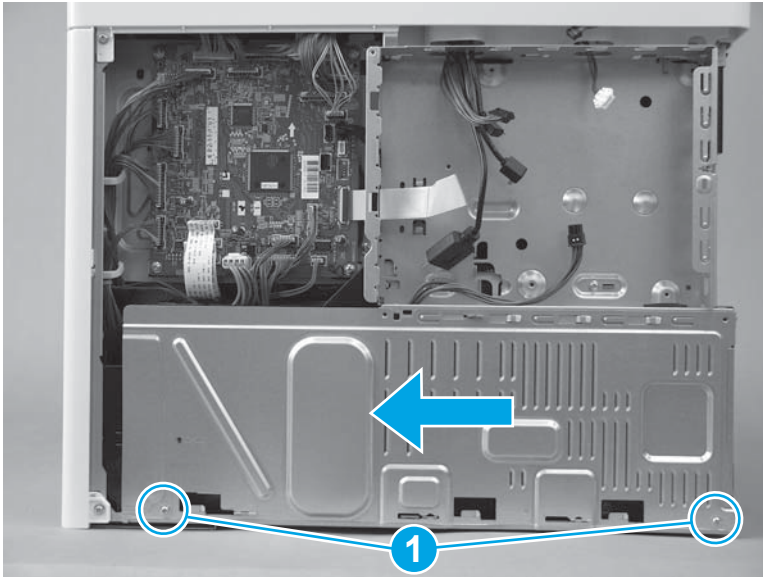

6. If no tape is affixed to the back of the flat cable, skip this step. If double-sided tape is affixed to the back of the flat cable, align the line (callout 1) on the cable with the edge (callout 2) of the opening in the sheet metal. Press to attach the flat cable to the formatter case.

Figure 1-3060 Attach the flat cable

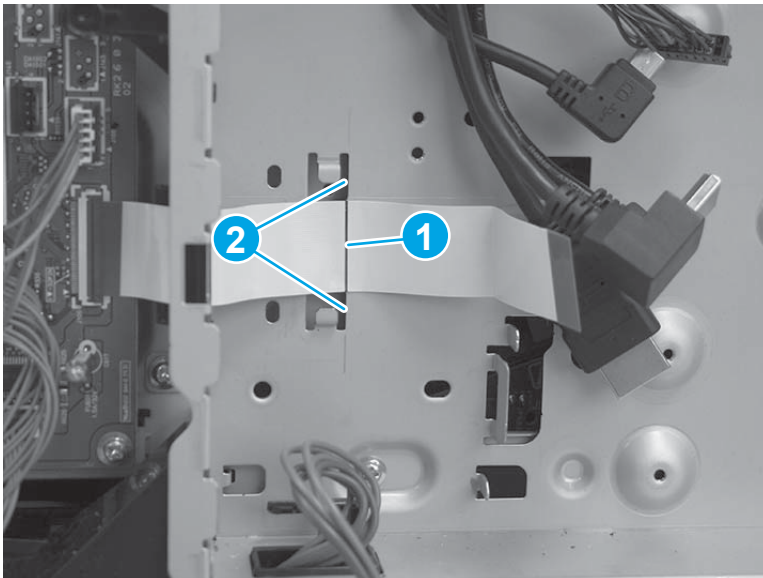

7. Position the bracket over the flat cable, and then slide the bracket to the left to install it. Make sure that the edges of the bracket fit under the sheet metal tabs (callout 1) on the formatter case and that the tabs (callout 2) snap into place.

Figure 1-3061 Position the bracket

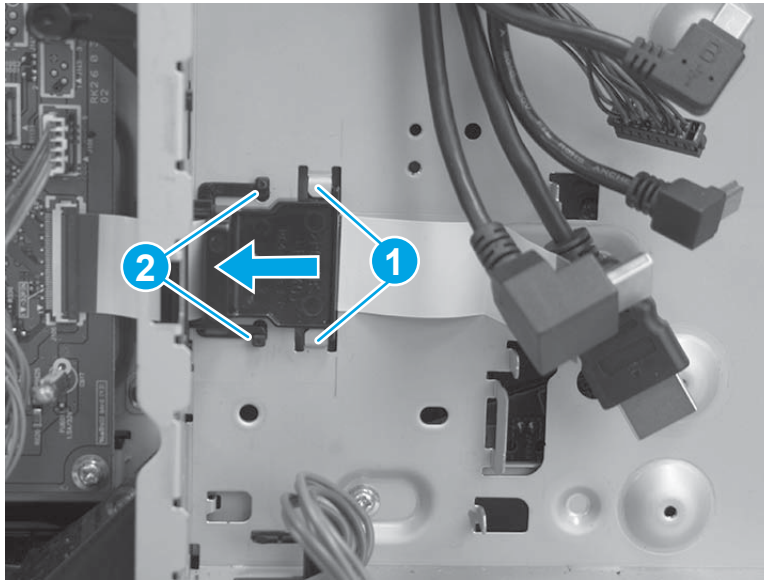

8. **M577 only:** Pass the wire harness (callout 1) through the openings in the formatter case (callout 2), and then connect one connector (callout 3).

Figure 1-3062 Connect one connector

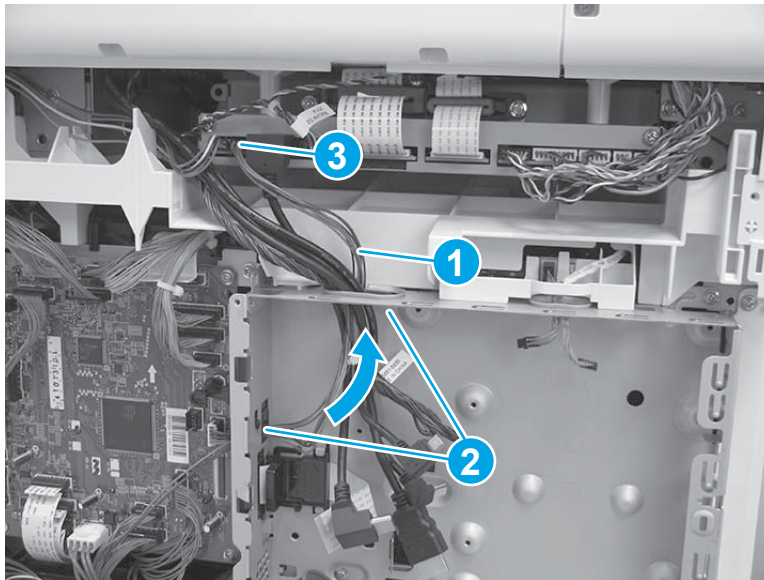

Step 32: Install the upper cover (M552 and M553)

 **NOTE:** This step is for the M552 and M553 models. For the M577 models, skip this step and go to [Step 33: Install the left cover on page 1729](#).

1. Position the cover on the printer.

 **NOTE:** For the M553x model, do not forget to pass the control-panel wire harness and USB cable through the opening in the cover.

Figure 1-3063 Install the cover



2. Push down on the rear corner of the cover to engage one tab (callout 1).

Figure 1-3064 Engage one tab

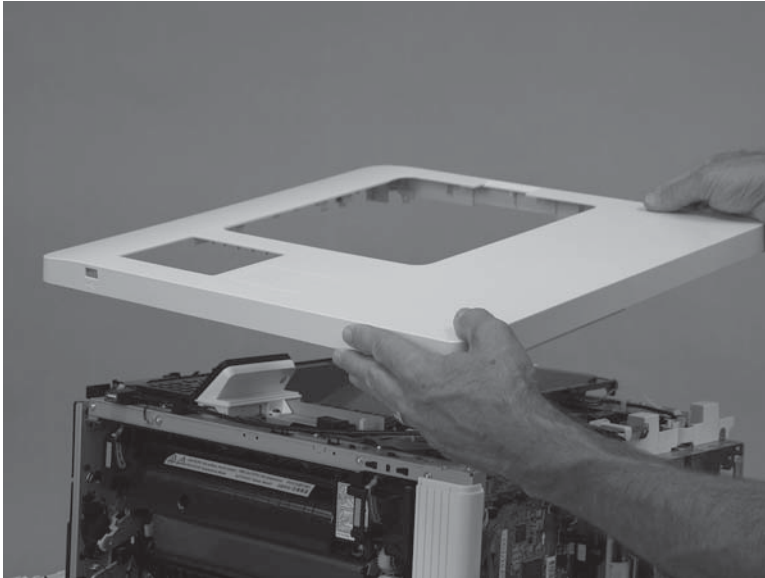
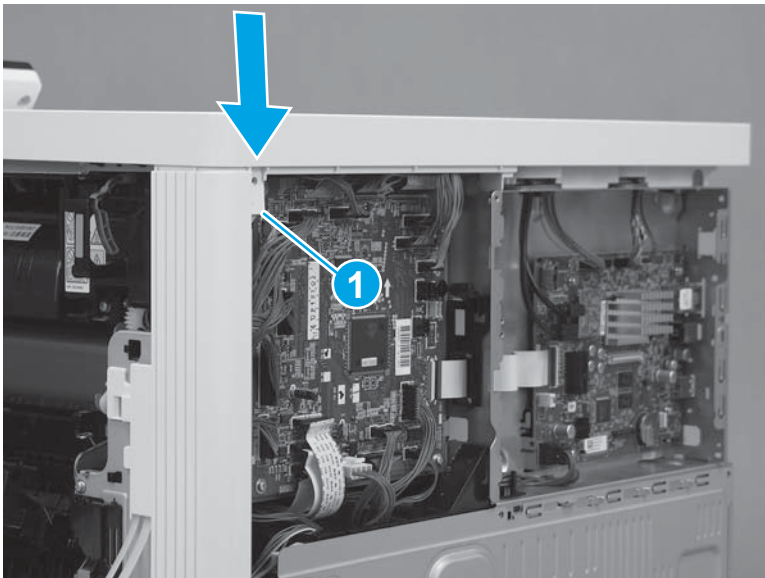

3. Push down on the front corner of the cover to engage one tab (callout 1), and then install one screw (callout 2).

 **NOTE:** This is a self-tapping plastic-thread screw. Make sure that this screw is used in this location when it is reinstalled.

Figure 1-3065 Engage one tab and install one screw



4. Install three screws (callout 1).

Figure 1-3066 Install three screws

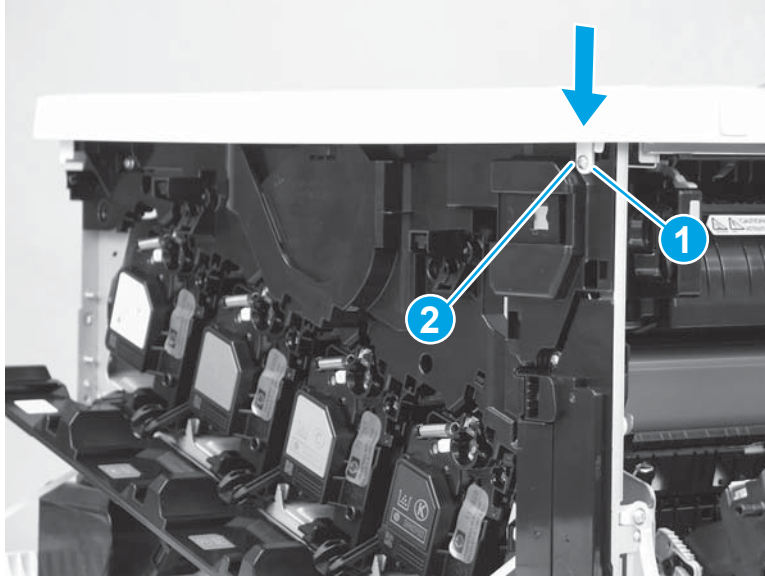
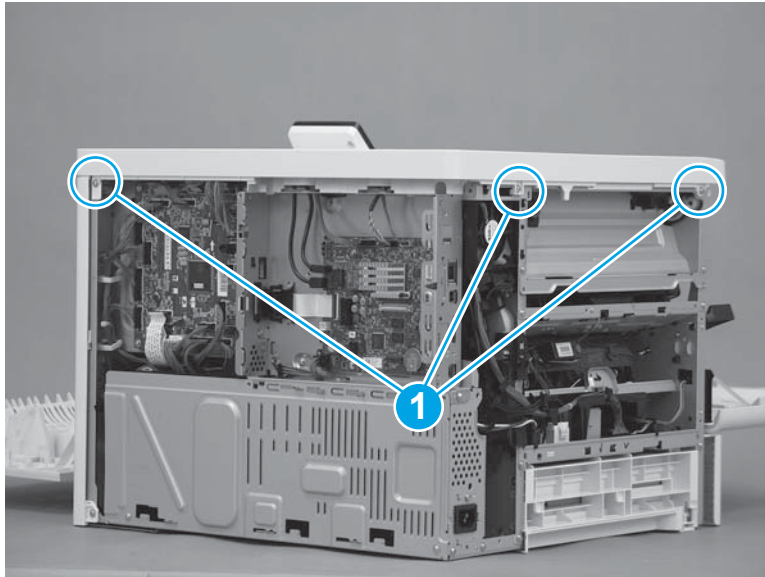

Step 33: Install the left cover

1. Position the cover on the printer.

 **NOTE:** Slightly offset the cover toward the rear of the printer.

Figure 1-3067 Install the cover

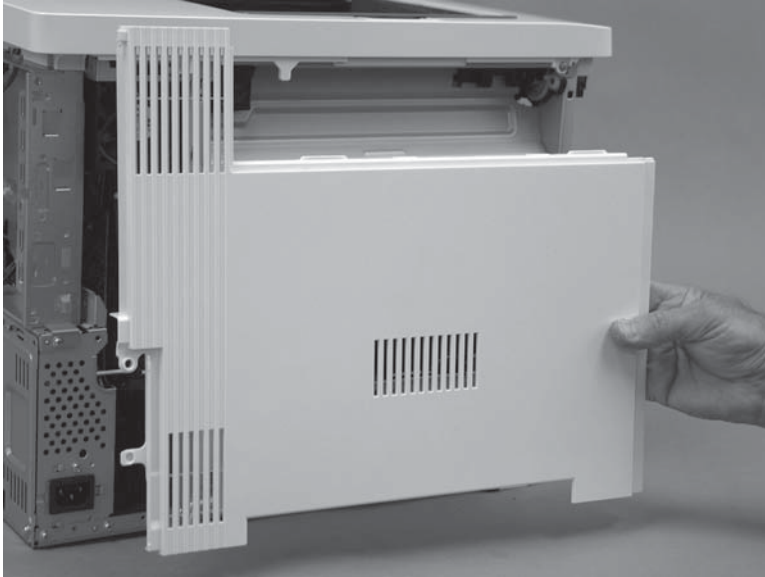

2. Slide the cover (callout 1) toward the front of the printer to engage it. Make sure that the tab (callout 2) snaps into place.

 **NOTE:** Locate the alignment pin (callout 3) on the cover from the front door side of the printer, and then make sure that it is fully engaged in the slot in the chassis.

 **TIP:** While sliding the cover into place, push in on the center of the cover (callout 1) to make sure that the hooks on the back of the cover engage with the slots in the chassis.

Figure 1-3068 Engage the cover



3. At the left side of the printer, install one screw (callout 1).

Figure 1-3069 Install one screw

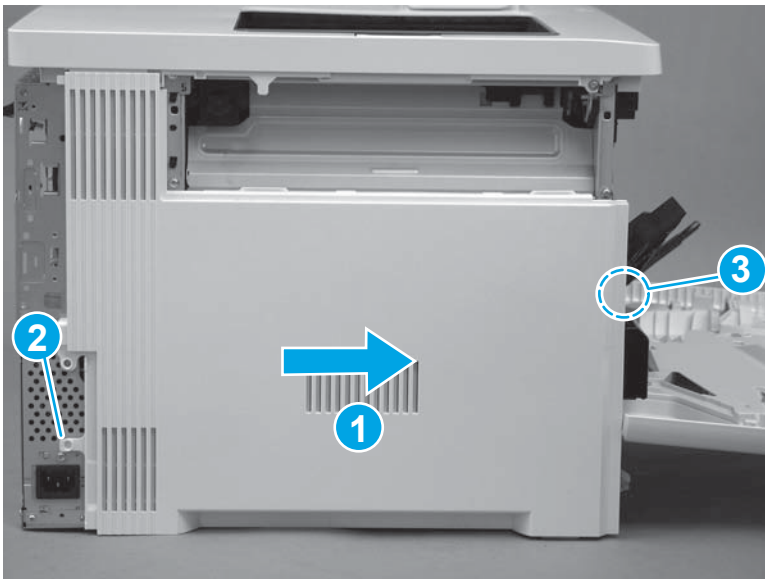

Step 34: Install the top rear cover (M577)

 **NOTE:** This step is for the M577 models. For the M552 and M553 models, skip this step and go to [Step 42: Install the rear cover \(M552 and M553\) on page 1747](#).

1. Align the locator tabs (callout 1) on the cover with the slots (callout 2) in the printer.

Figure 1-3070 Align the locator tabs

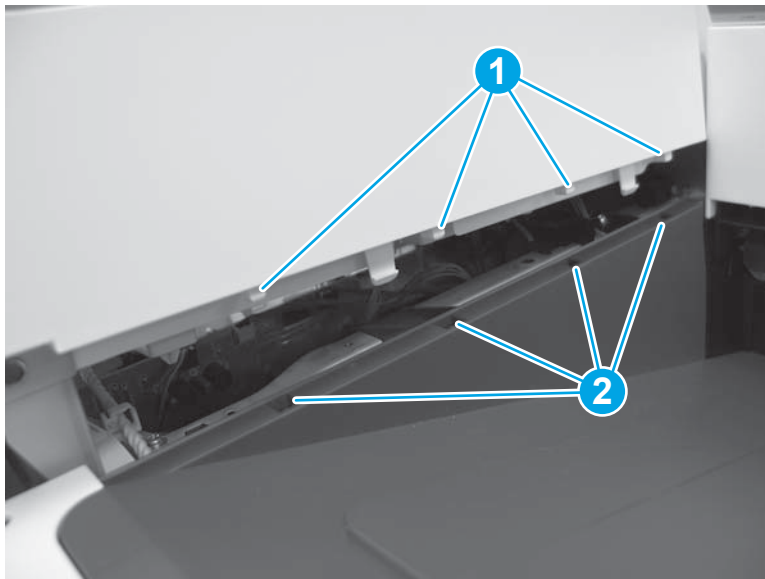

2. Press down to install the cover. Make sure that the tabs snap into place.

Figure 1-3071 Install the cover

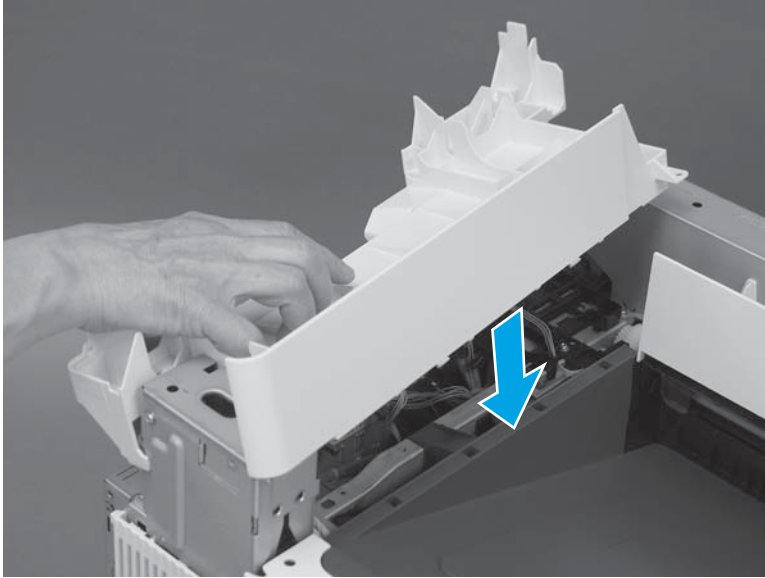

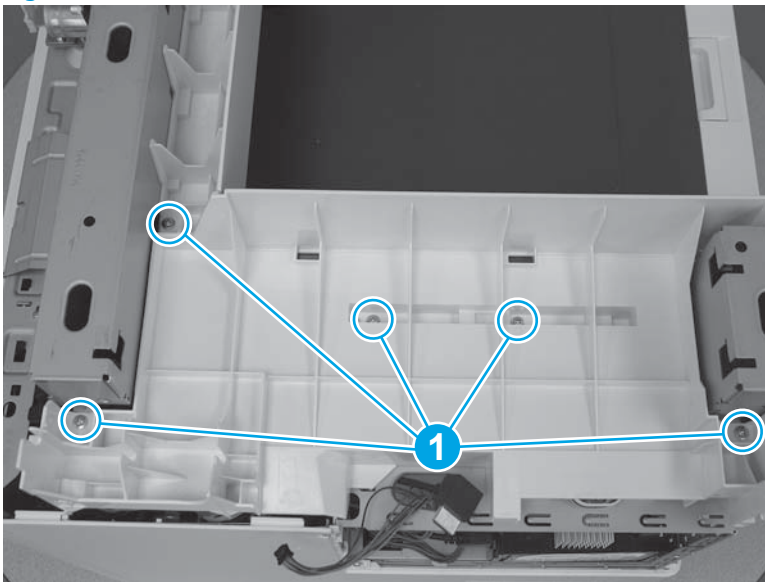

3. At the top of the printer, install five screws (callout 1).

Figure 1-3072 Install five screws



Step 35: Install the right upper cover (M577)

 **NOTE:** This step is for the M577 models. For the M552 and M553 models, skip this step and go to [Step 42: Install the rear cover \(M552 and M553\) on page 1747.](#)

 **NOTE:** The figures below show the image scanner installed. The procedures for removing and installing the right upper cover are the same whether the image scanner is installed or removed."

1. **M577c/f/z only:** Install the cables (callout 1) through the slot (callout 2) in the printer.

Figure 1-3073 Install the cables

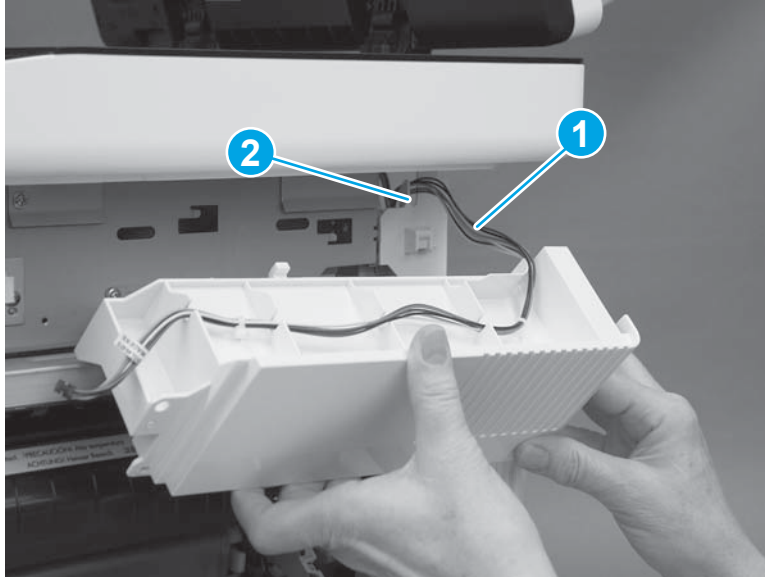

2. Position the hooks (callout 1) on the cover in the slots (callout 2) in the printer.

Figure 1-3074 Position the hooks

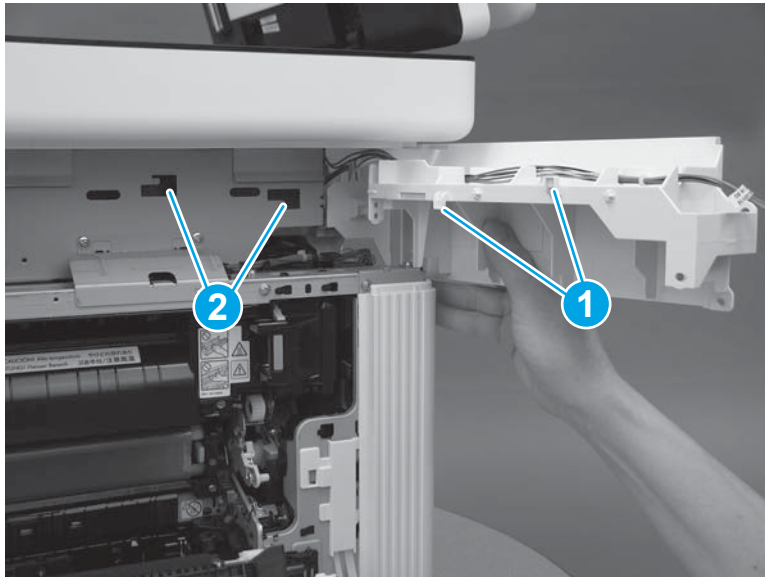

3. Slide the cover toward the front of the printer to install it.

Figure 1-3075 Install the cover

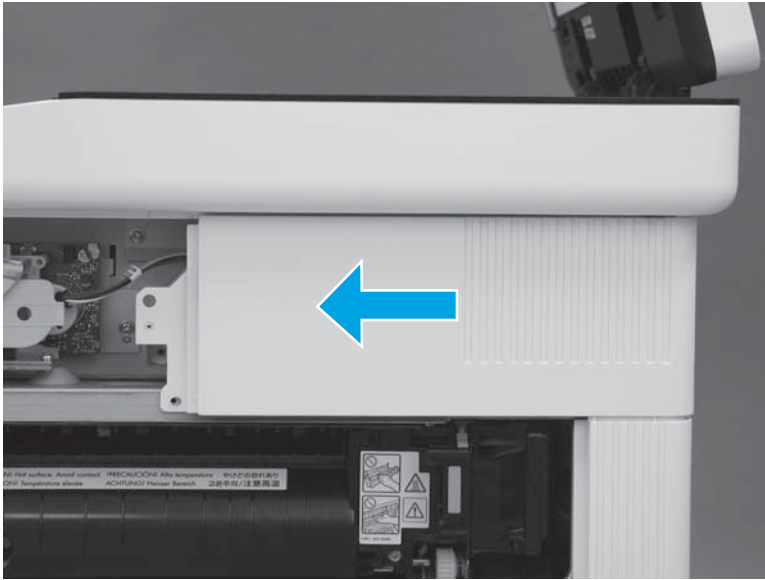

4. At the back of the printer, install one screw (callout 1).

M577c/f/z only: Connect one connector (callout 2), if the integrated scanner assembly is installed.

TIP: This screw is smaller than the screws installed in the next step. Make sure that this screw is installed in the correct position.

Figure 1-3076 Install one screw and connector

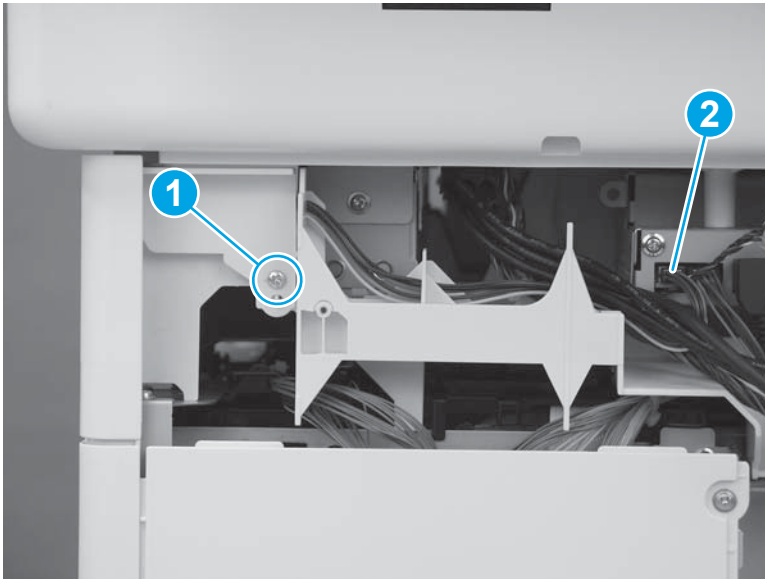

5. At the right side of the printer, install two screws (callout 1).

M577c/f/z only: Connect one connector (callout 2), if the stapler is installed.

Figure 1-3077 Install one screw and connector

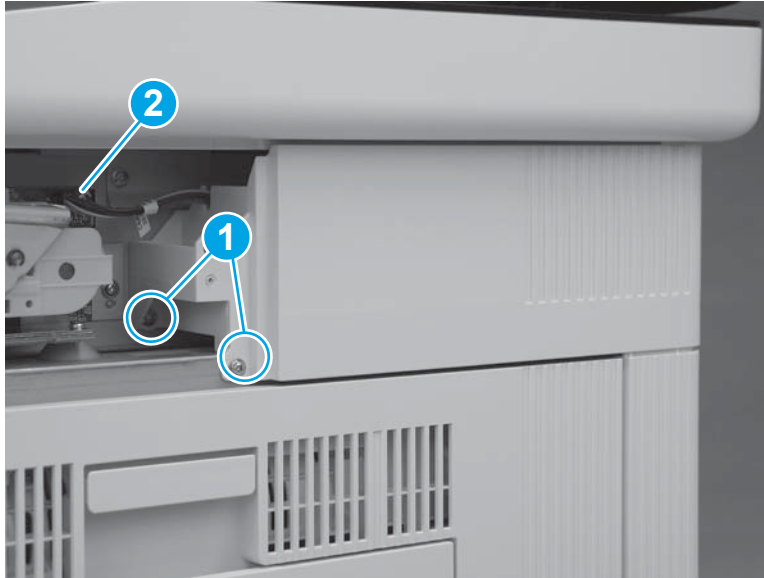

Step 36: Install the integrated scanner assembly (ISA) (M577)

 **NOTE:** This step is for the M577 models. For the M552 and M553 models, skip this step and go to [Step 42: Install the rear cover \(M552 and M553\)](#) on page 1747.

 **NOTE:** The ISA includes the document feeder, image scanner, scanner control board (SCB), control panel, keyboard (M577c/z) and NFC PCA (M577z).

1. Before proceeding, locate the mounting pins (callout 1) on the bottom of the ISA and the slots (callout 2) on the printer base.

Figure 1-3078 Locate the ISA mounting pins and slots

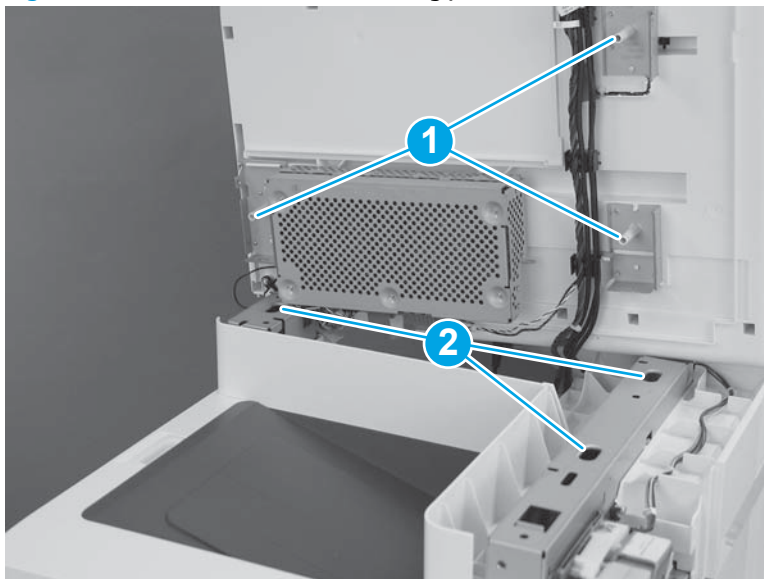

2. Position the ISA on the printer base with the pins in the slots.

 **NOTE:** To locate the pins and slots, see [Figure 1-395 Locate the ISA mounting pins and slots on page 250](#).

When installing the ISA, carefully pass the cables through the opening in the top of the formatter case.

Figure 1-3079 Install the ISA

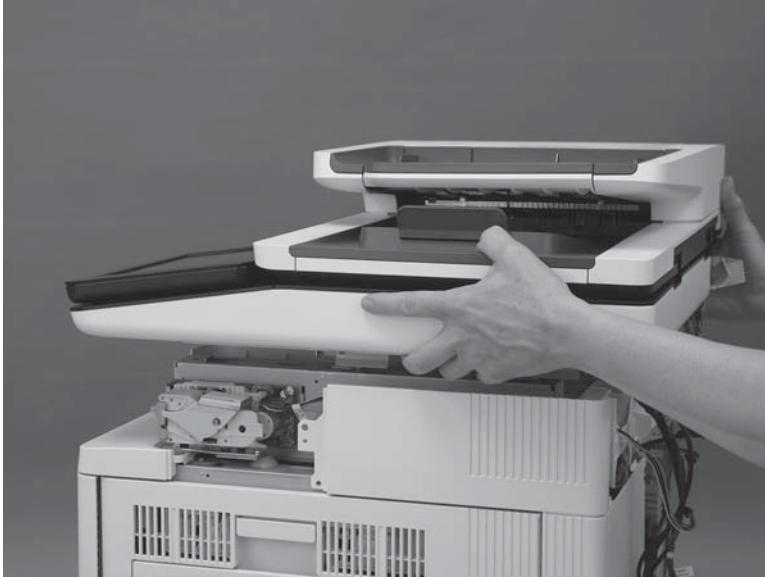

3. Slightly slide the ISA towards the front of the printer to engage it.

Figure 1-3080 Slide the ISA towards the front of the printer

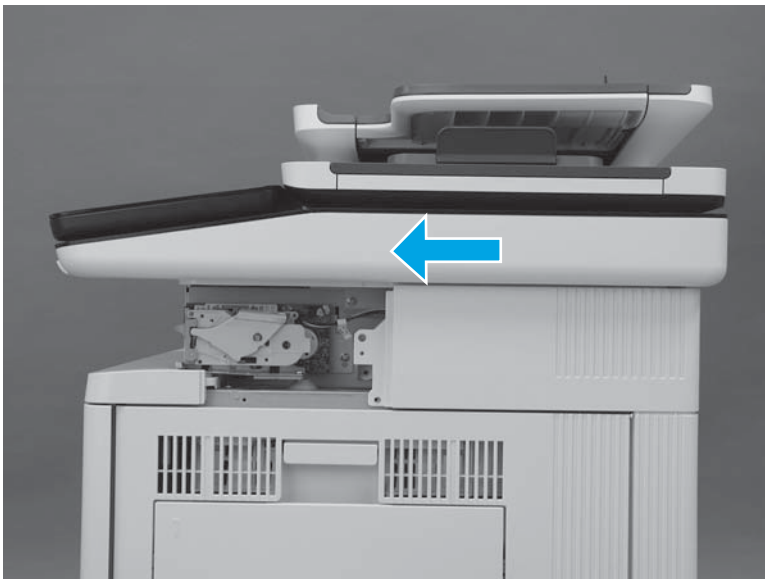

4. At the left side of the printer, install one screw (callout 1).

Figure 1-3081 Install one screw

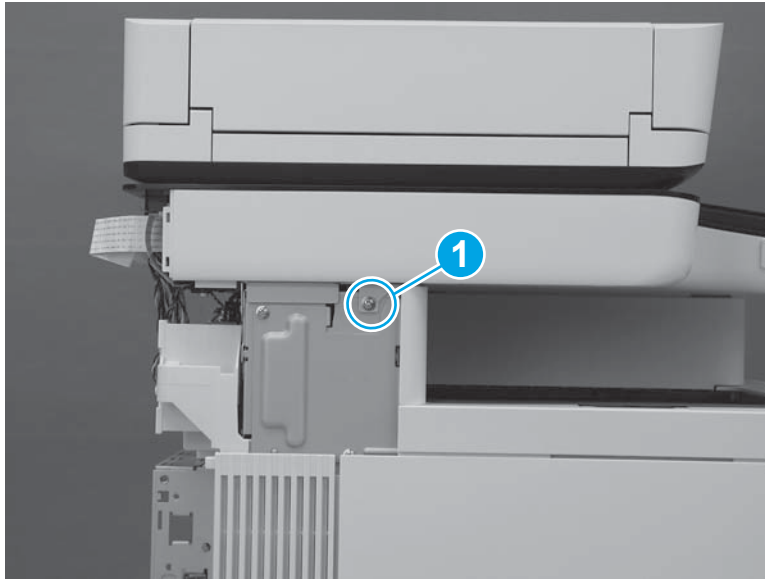

5. At the back of the printer, install two screws (callout 1).

Figure 1-3082 Install two screws

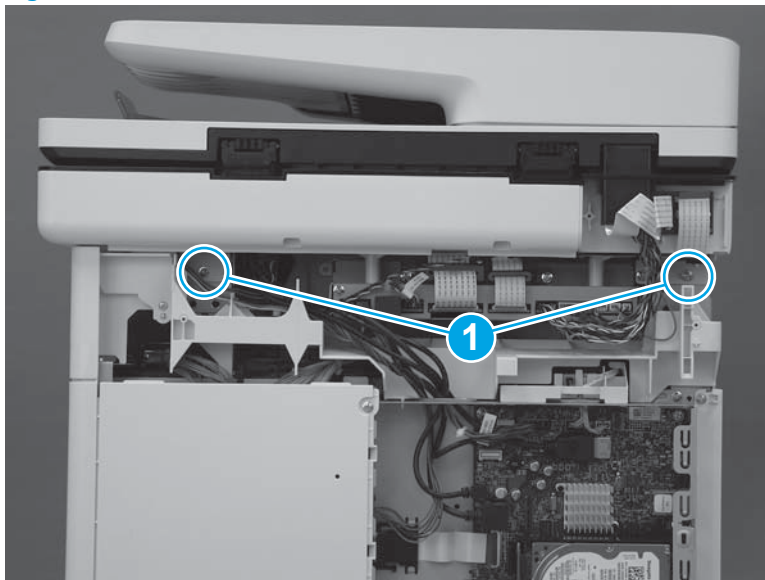

6. At the right side of the printer, install one screw (callout 1).

Figure 1-3083 Install one screw

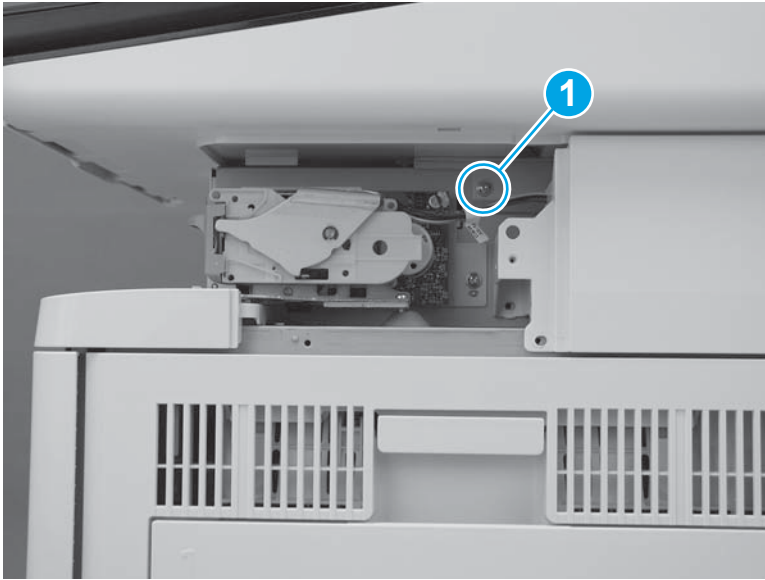

7. Connect two connectors on the scanner control board (callout 1).

M577c/f/z only: Connect one connector for the stapler on the scanner control board (callout 2).

Figure 1-3084 Connect connectors

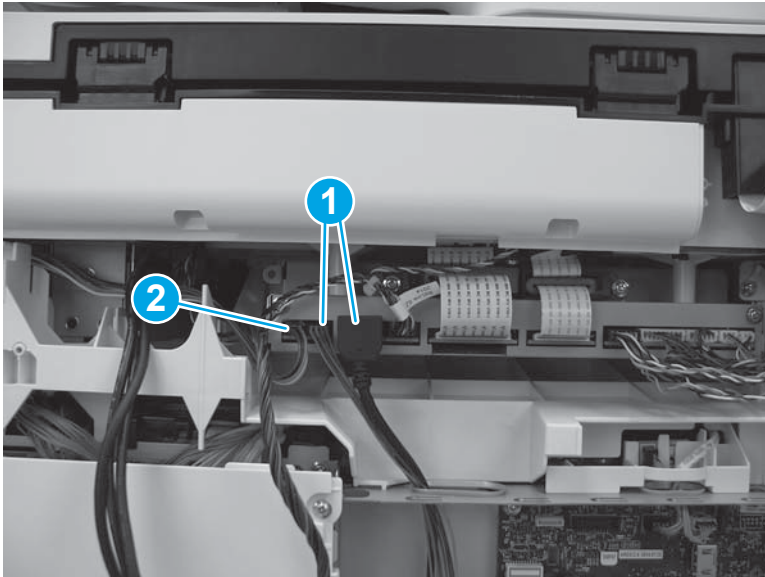

Step 37: Install the stapler cover assembly (M577c/f/z)

 **NOTE:** This step is for the M577c/f/z models only. For the M577dn model, skip this step and go to [Step 38: Install the right front upper cover \(M577dn\) on page 1740](#).

For the M552 and M553 models, skip this step and go to [Step 42: Install the rear cover \(M552 and M553\) on page 1747](#).

1. Install the tabs (callout 1) on the cover in the slots (callout 2) in the printer.

Figure 1-3085 Install two tabs



2. Press the cover toward the left side of the printer until it snaps into place.

Figure 1-3086 Install the cover assembly



3. Install one screw (callout 1).



 **IMPORTANT:** This is a self-tapping screw for plastic. Rotate it counterclockwise to align it with the existing thread pattern, and then carefully turn it clockwise to tighten. Do not overtighten. This will prevent stripping the threads inside the screw hole.

Figure 1-3087 Install one screw

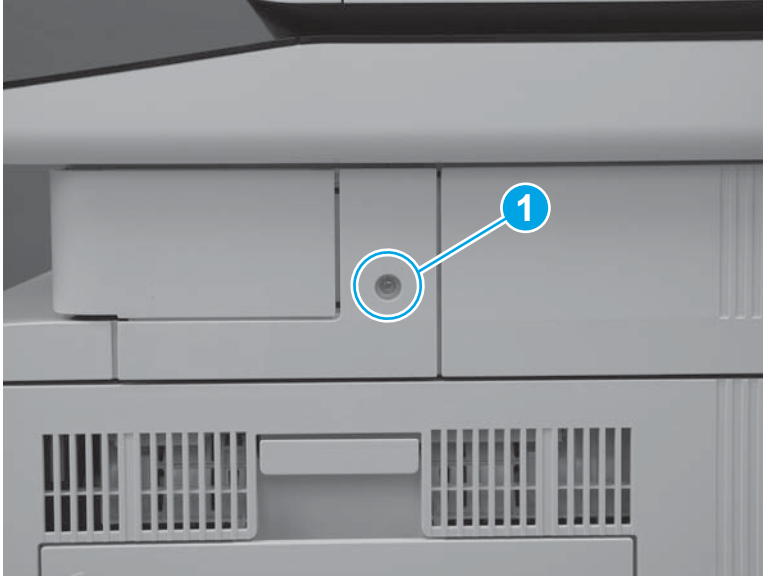

Step 38: Install the right front upper cover (M577dn)

 **NOTE:** This step is for the M577dn model only. For the M577c/f/z models, skip this step and go to [Step 39: Install the left upper cover \(M577\) on page 1742](#).

For the M552 and M553 models, skip this step and go to [Step 42: Install the rear cover \(M552 and M553\) on page 1747](#).

1. Slide the cover toward the left side of the printer to install it. Make sure that the slots (callout 1) in the cover fit over the tabs (callout 2) on the inside of the paper feeder cover.

Figure 1-3088 Install the cover



2. Press the right front upper cover (callout 1) and the paper feeder cover (callout 2) together until the tabs on the inside of the covers snap into place.

Figure 1-3089 Press the cover



3. Install one screw (callout 1).

Figure 1-3090 Install one screw

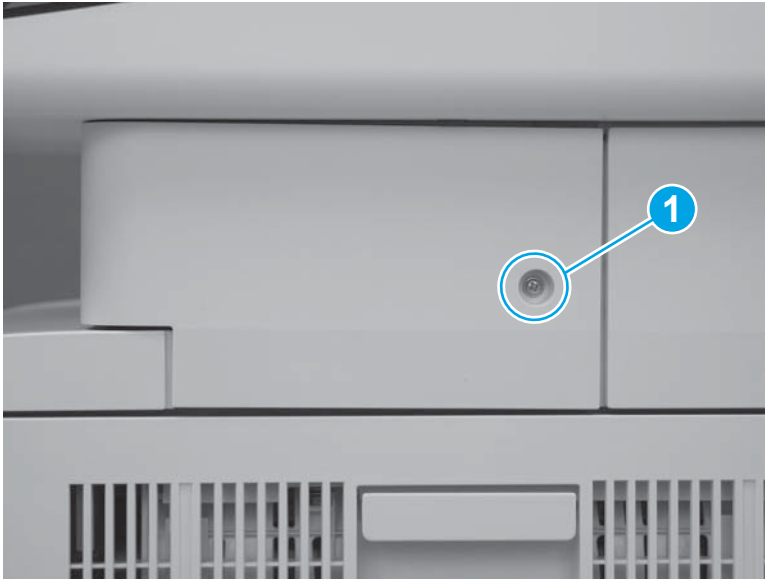

Step 39: Install the left upper cover (M577)



NOTE: This step is for the M577 models. For the M552 and M553 models, skip this step and go to [Step 42: Install the rear cover \(M552 and M553\) on page 1747](#).

1. Position the tab (callout 1) on the lower edge of the cover behind the left cover (callout 2).

Figure 1-3091 Position the tab

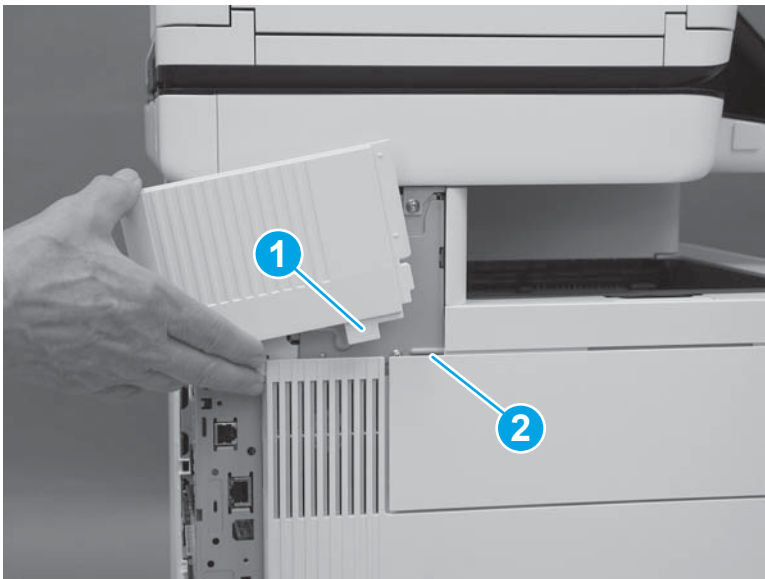

2. Slide the cover toward the front of the printer to install it. Make sure that the edge (callout 1) of the cover fits behind the edge (callout 2) of the top rear cover.

Figure 1-3092 Slide the cover

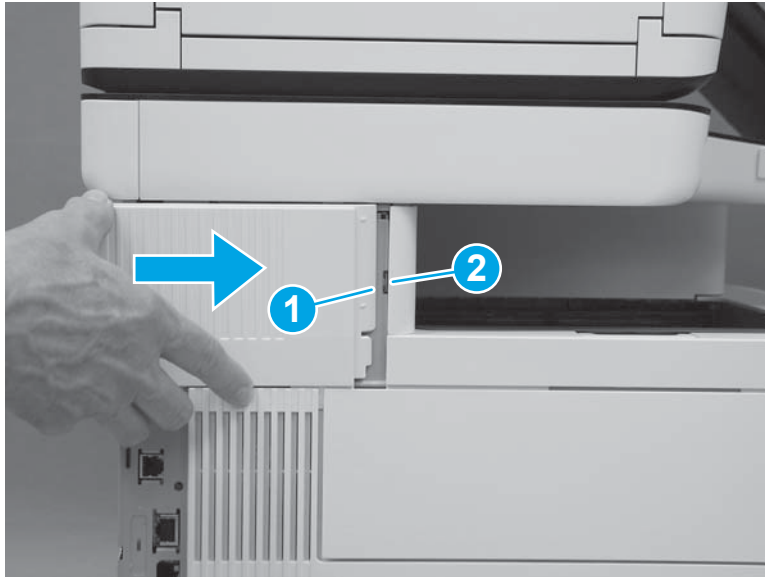

3. Make sure that the tab (callout 1) is fully installed.

Figure 1-3093 Check the tab

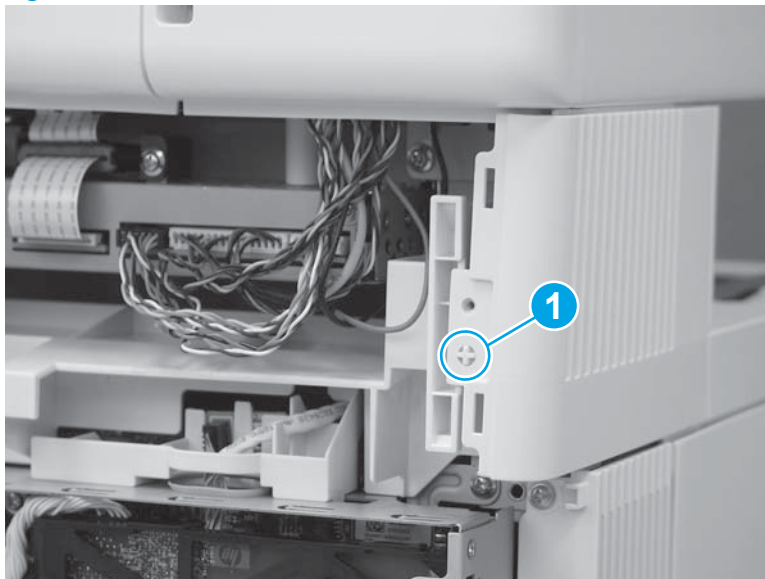

Step 40: Install the rear cover (M577)

 **NOTE:** This step is for the M577 models. For the M552 and M553 models, skip this step and go to [Step 42: Install the rear cover \(M552 and M553\) on page 1747.](#)

1. Position the hooks (callout 1) on the cover in the slots (callout 2) in the printer.

Figure 1-3094 Position the hooks

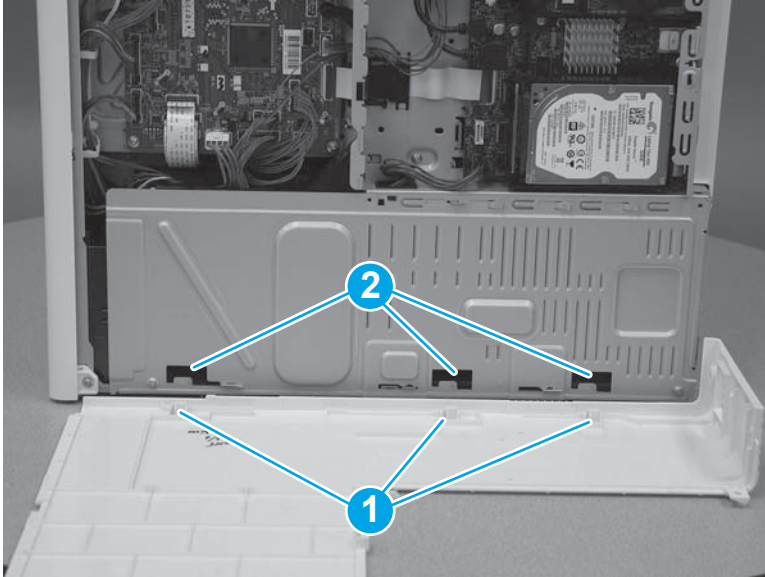

2. Position the back edge (callout 1) of the rear cover behind the edge (callout 2) of the right rear cover. Slide the cover to the left to install it.

Figure 1-3095 Install the cover

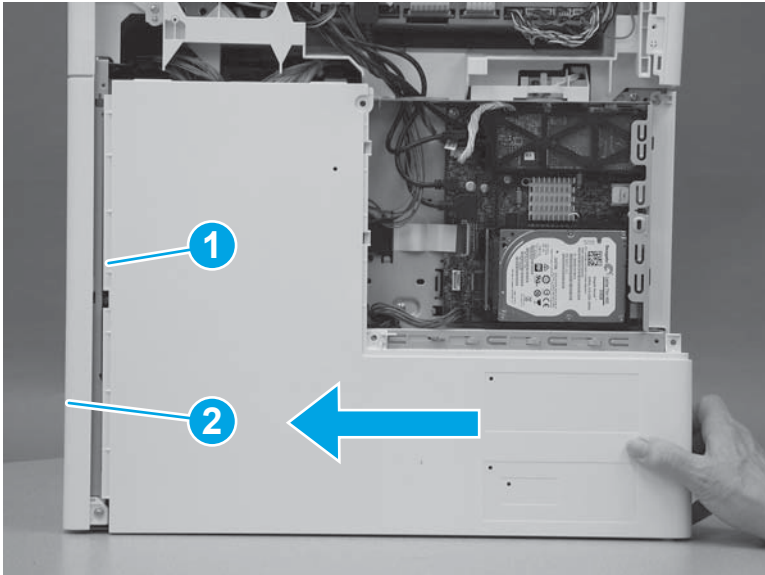

3. Install four screws (callout 1).

Figure 1-3096 Install four screws cover

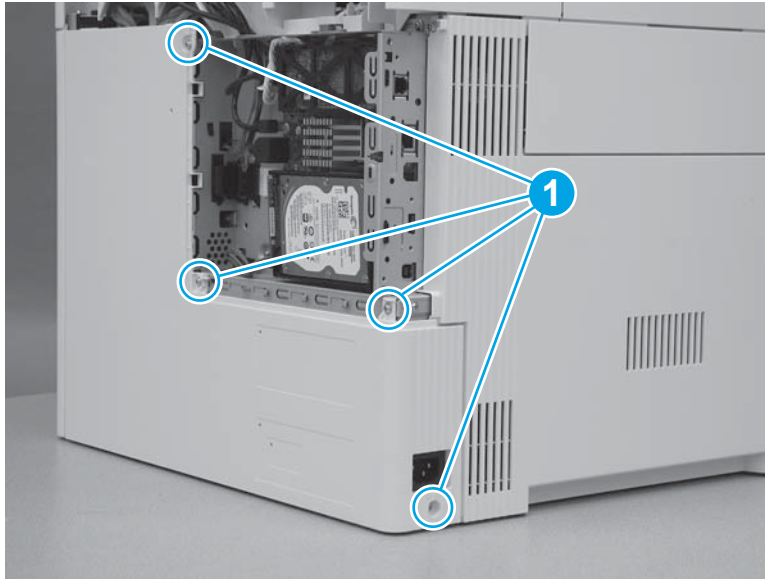

Step 41: Install the rear upper cover (M577)

 **NOTE:** This step is for the M577 models. For the M552 and M553 models, skip this step and go to [Step 42: Install the rear cover \(M552 and M553\) on page 1747](#).

1. Align the ridge (callout 1) on the lower edge of the rear upper cover in front of the tabs (callout 2) on the top edge of the rear cover.

Figure 1-3097 Align the cover

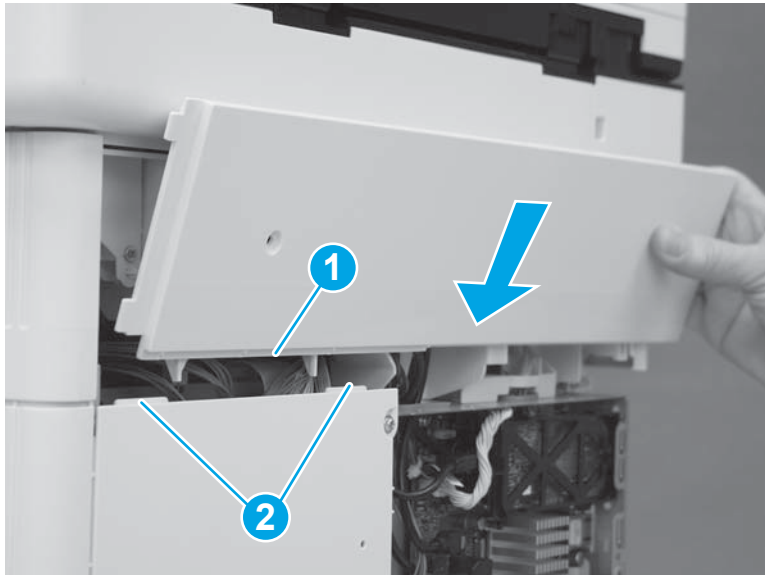

2. Rotate the top of the cover toward the printer.

Figure 1-3098 Rotate the top of the cover

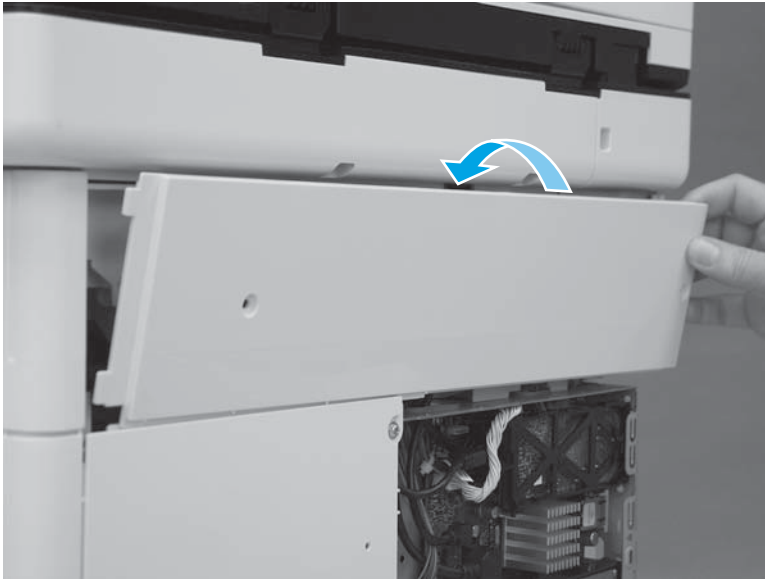

3. Slide the cover to the left (callout 1). Make sure that the tabs (callout 2) on the upper rear cover slide behind the edge (callout 3) of the right upper cover. Make sure that the cover is fully seated.

Figure 1-3099 Slide the cover

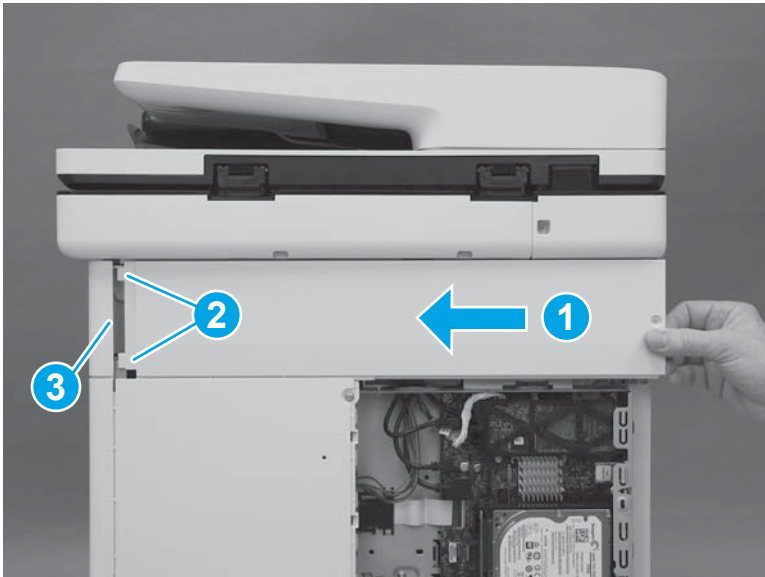

4. Install two screws (callout 1).

 **IMPORTANT:** These two screws are self-tapping screws for plastic. Rotate them counterclockwise to align them with the existing thread pattern, and then carefully turn them clockwise to tighten. Do not overtighten. This will prevent stripping the threads inside the screw holes.

Figure 1-3100 Install two screws



Step 42: Install the rear cover (M552 and M553)

 **NOTE:** This step is for the M552 and M553 models. For the M577 models, skip this step and go to [Step 43: Install the formatter \(M577\) on page 1748](#).

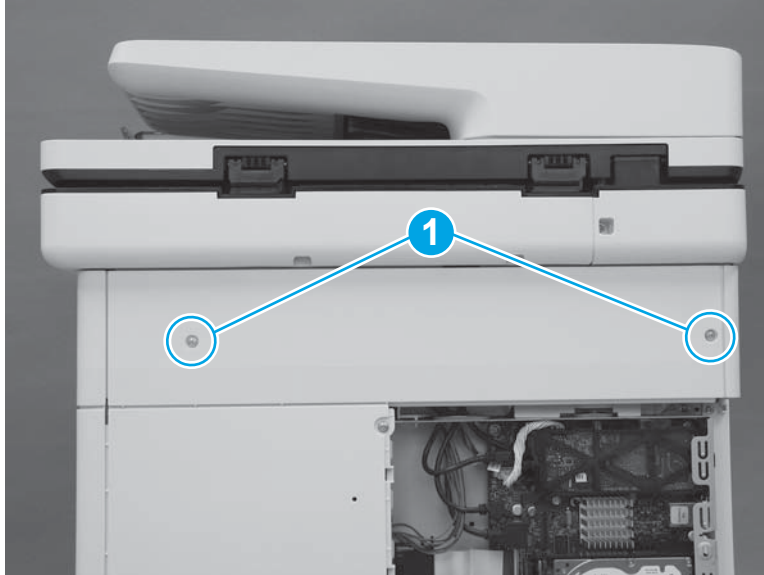
1. Position the top of the cover under the upper cover (callout 1), rotate the bottom of the cover onto the chassis (callout 2), and then slide the cover to the left (callout 3) to install it.

Figure 1-3101 Install the cover

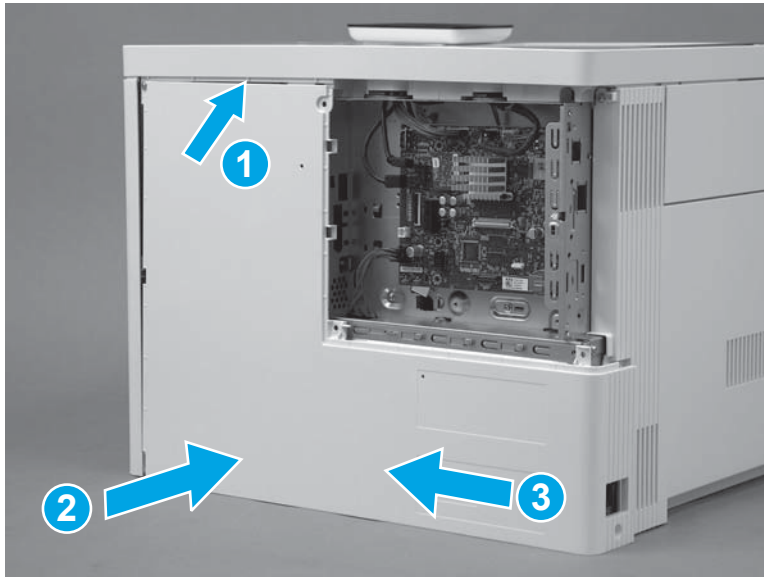

2. Install four screws (callout 1).

Figure 1-3102 Install four screws cover

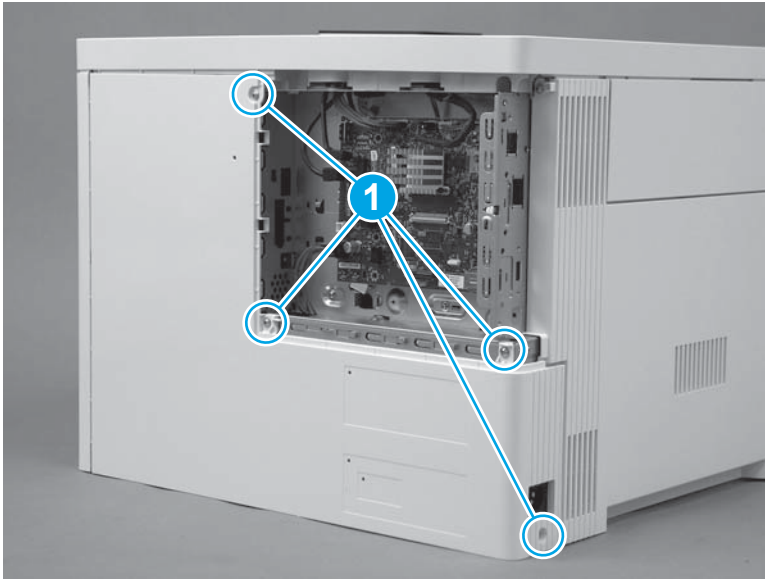

Step 43: Install the formatter (M577)



NOTE: This step is for the M577 models. For the M552 and M553 models, skip this step and to go [Step 46: Install the formatter \(M552 and M553\) on page 1753](#).



CAUTION:  ESD-sensitive part.

1. Position the formatter in the printer. Make sure that the network port (callout 1) fits through the opening (callout 2) in the formatter case.

Figure 1-3103 Install the formatter

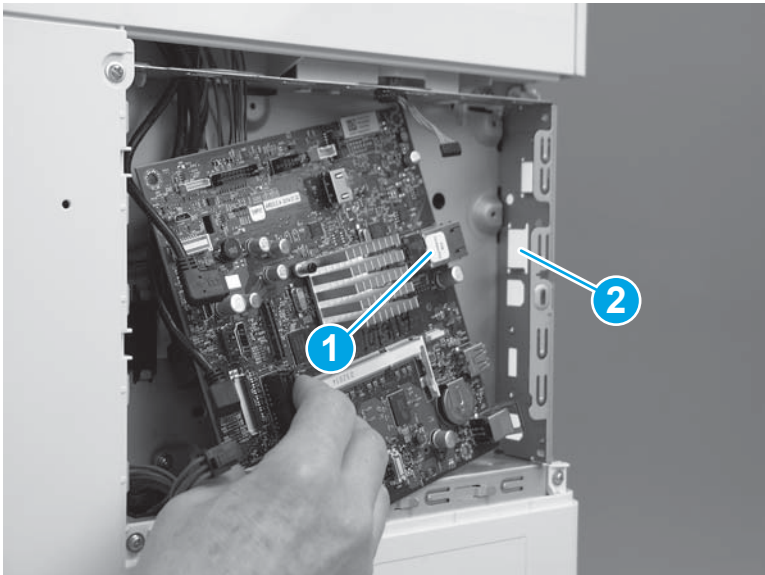

2. Install four screws (callout 1).

Figure 1-3104 Install four screws

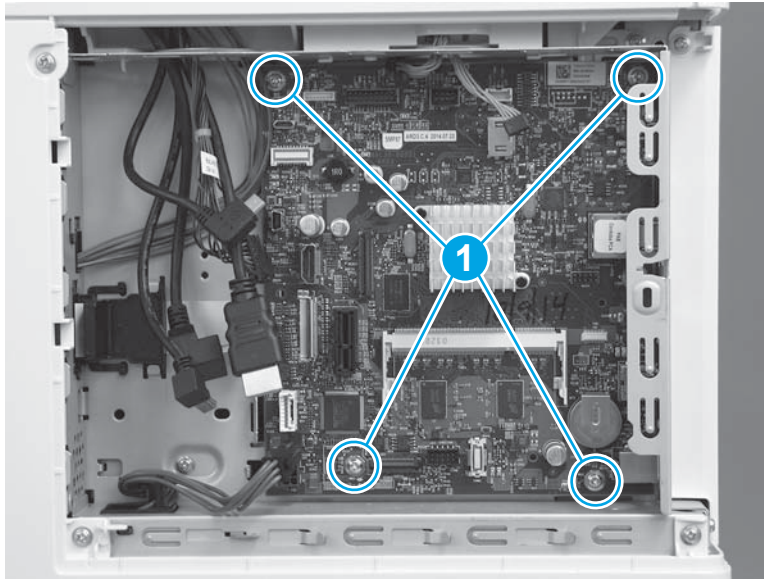

3. Connect all of the connectors on the formatter.

The following connectors are empty:

- All models: J1 (this connector is empty unless the optional DIMM is installed)
- All models: J3
- M577dn: J15 (this is the fax connector for the M577f/z/c models)
- All models: J21 (this connector is empty unless the optional internal USB ports component is installed)
- All models: J23
- All models: J24
- All models: J51
- All models: J57
- All models: J97
- All models: J98 (this connector is empty unless the optional trusted platform module (TPM) is installed)

 **IMPORTANT:** The flat-cable connector (callout 1) is a Zero Insertion Force (ZIF) connector that uses a hinged retainer to secure the flat cable. The hinged retainer must be opened to install the flat cable, and then closed after the cable is installed.

Figure 1-3105 Connect all connectors



Step 44: Install the fax PCA (M577c/f/z)

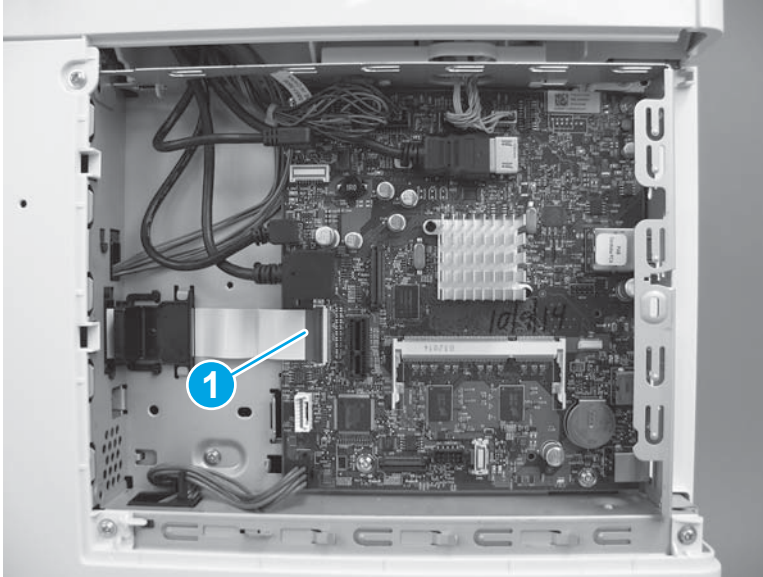

NOTE: This step is for the M577c/f/z models. For the M577n model, skip this step and go to [Step 45: Install the HDD \(M577\) on page 1751](#).

For the M552 and M553 models, skip this step and go to [Step 46: Install the formatter \(M552 and M553\) on page 1753](#).



CAUTION:  ESD-sensitive part.

1. Position the tab and telephone port (callout 1) on the fax PCA in the slots (callout 2) in the formatter case.

Figure 1-3106 Position the fax PCA

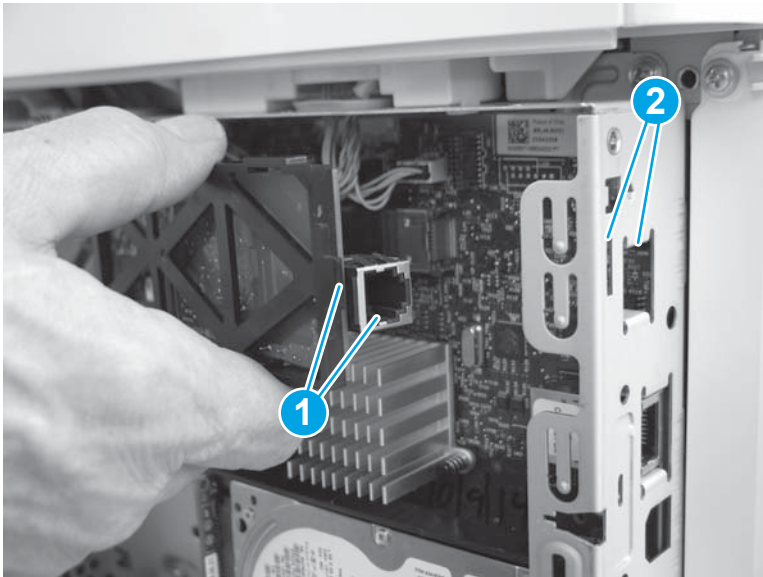

2. Slide the fax PCA to the right (callout 1) until the tab and telephone port described in the previous step and seated in the formatter case. Position the retainer (callout 2) in the slot (callout 3) in the formatter. Rotate the end of the fax PCA toward the formatter (callout 4) until the retainer snaps into place.

Figure 1-3107 Install the fax PCA

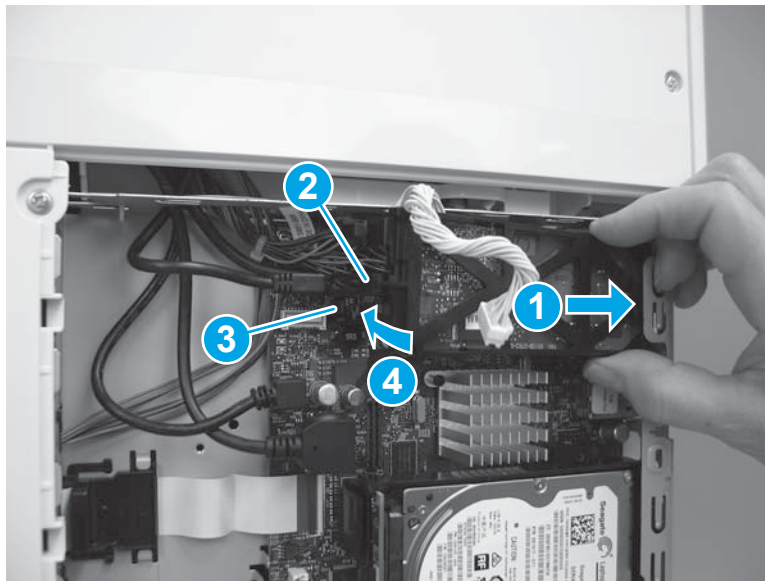

3. Position the cable (callout 1) in the guide (callout 2), and then connect one connector (callout 3).

Figure 1-3108 Connect the connector

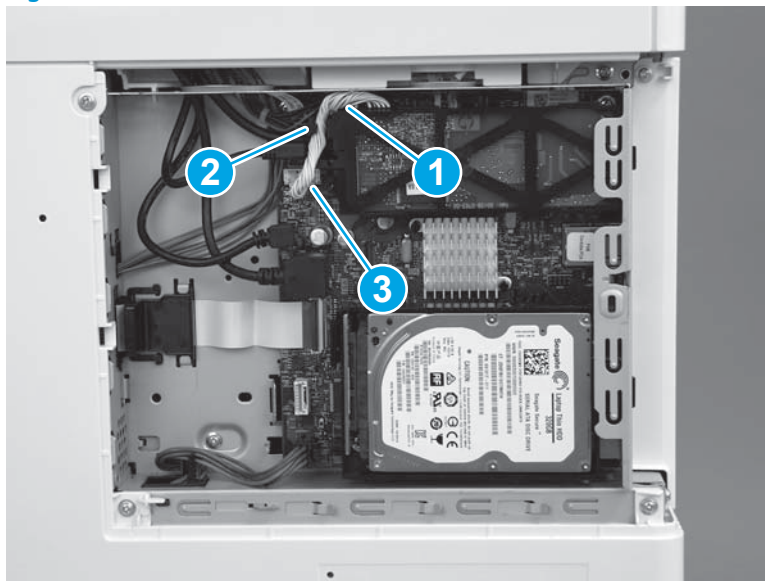

Step 45: Install the HDD (M577)

 **NOTE:** This step is for the M577 models. For the M552 and M553 models, skip this step and go to [Step 46: Install the formatter \(M552 and M553\) on page 1753.](#)

 **CAUTION:**  ESD-sensitive part.

1. Align the end of the bracket (callout 1) with the slot in the chassis (callout 2), and then slide the HDD into the printer (callout 3) to engage the bracket with the chassis.

Figure 1-3109 Install the holder

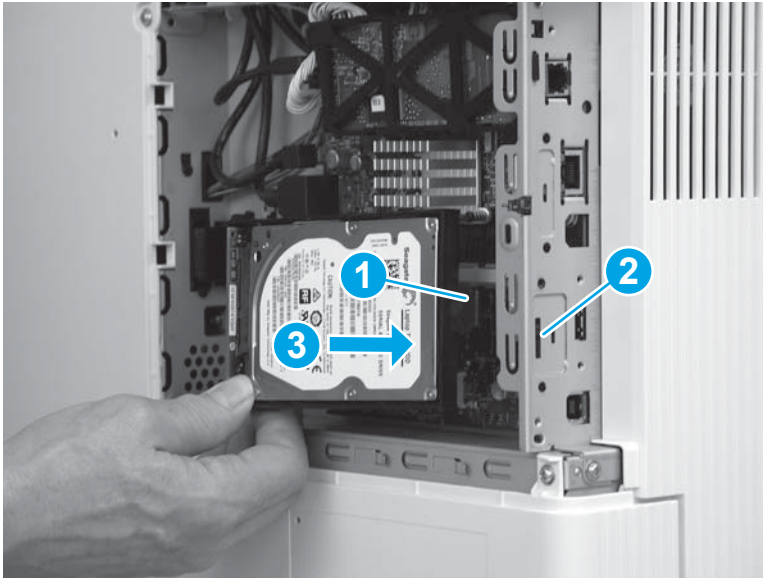

2. Hold the HDD connector latch (callout 1) in the released position, and then rotate the HDD down and into the connector on the formatter to install it.

 **NOTE:** Make sure that the tab (callout 2) snaps into place, and that the HDD is securely installed.

Figure 1-3110 Release the HDD

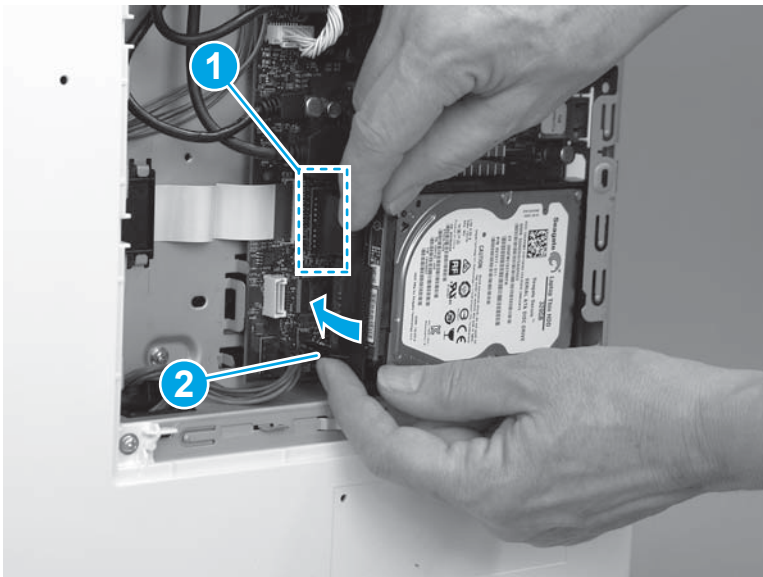

Step 46: Install the formatter (M552 and M553)

 **NOTE:** This step is for the M552 and M553 models. For the M577 models, skip this step and go to [Step 47: Install the formatter cover on page 1754](#).

If the optional hard-disk drive (HDD) was removed, do not forget to reinstall it after the formatter is reinstalled.

Engage the HDD holder with the chassis, rotate the HDD connector down and into the connector on the formatter. Make sure that the tabs snap into place.

 **CAUTION:**  ESD-sensitive part.

1. Position the formatter in the printer, and then install four screws (callout 1).

Figure 1-3111 Install the formatter

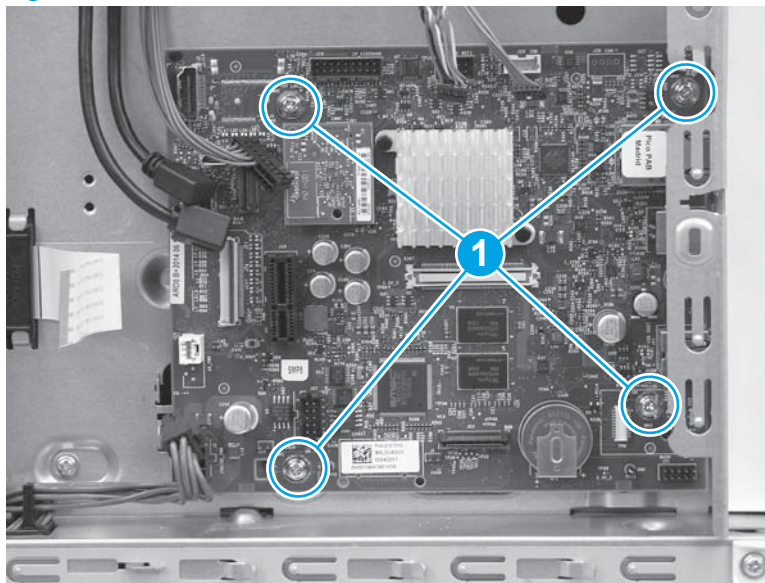

2. Connect all of the connectors on the formatter.

The following connectors are empty:

- All models: J1 (this connector is empty unless the optional DIMM is installed)
- M553n/dn and M552dn: J2 (callout 1; this is the touchscreen connector for the M553x model)
- All models: J9 (this connector is empty unless the optional internal USB ports component is installed)
- All models: J18 (this connector is empty unless the optional hard-disk-drive (HDD) is installed)
- All models: J23
- All models: J24
- M553n/dn and M552dn: J25 (this is the wireless connector for the M553x model)

- All models: J57
- All models: J98 (this connector is empty unless the optional trusted platform module (TPM) is installed)



 **IMPORTANT:** The flat-cable connector (callout 2) is a Zero Insertion Force (ZIF) connector that uses a hinged retainer to secure the flat cable. The hinged retainer must be opened to install the flat cable.

Figure 1-3112 Connect all connectors

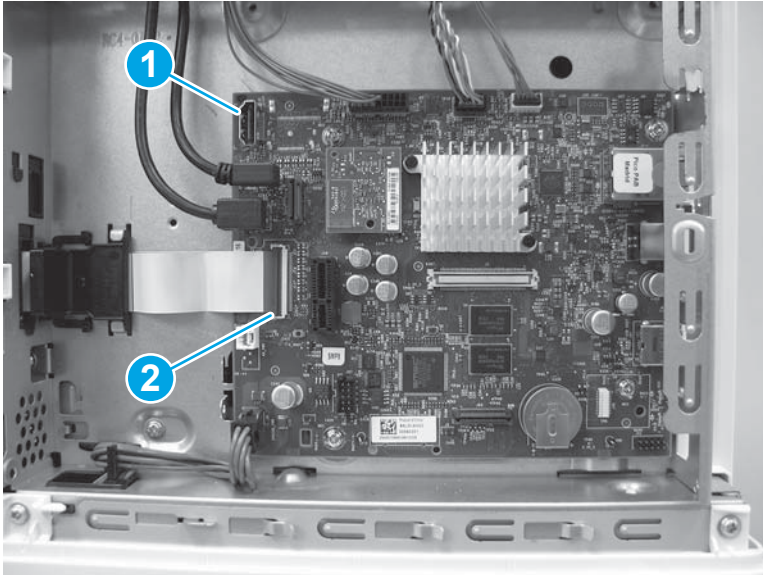

Step 47: Install the formatter cover

- ▲ Slide the cover onto the printer (callout 1) to install it.

 **NOTE:** Make sure that the tabs on the formatter cover align with the slots provided in the printer (callout 2). Tighten the two thumbscrews (callout 3).

 **TIP:** If needed, use the edge of a coin to turn the thumbscrews.

Figure 1-3113 Install the cover



Step 48: Install the TCU

1. Verify that the toner collection hatch cover is in the closed position on the TCU.

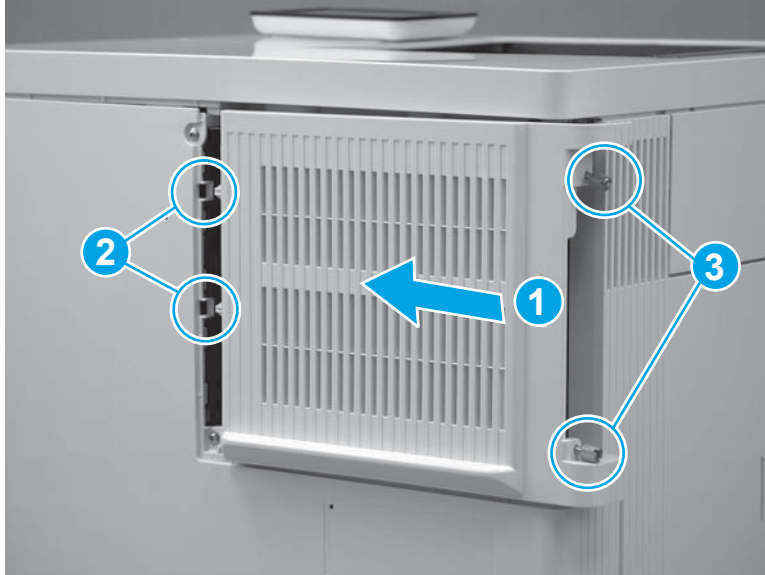
Figure 1-3114 Verify that the toner collection hatch cover is closed

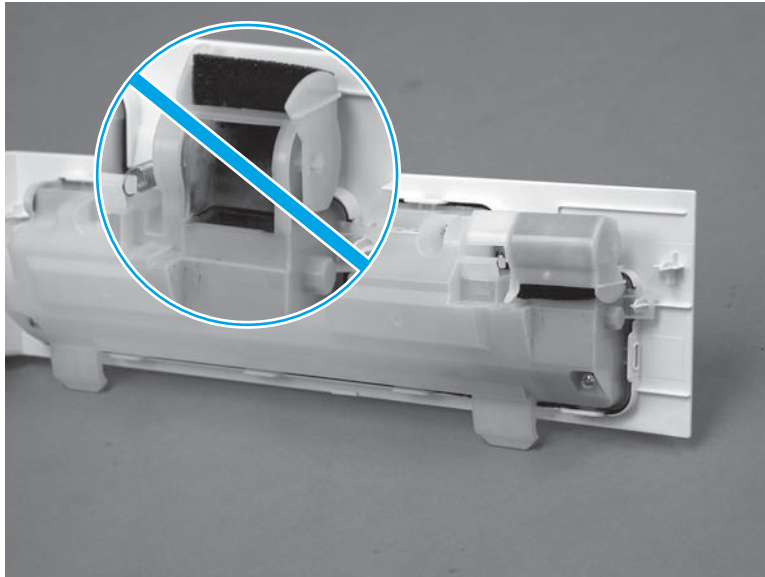

2. Position the TCU with the hinges in the slots provided in the printer (callout 1), and then rotate the TCU up and into the closed position.

 **NOTE:** The toner collection hatch cover automatically opens when the TCU is closed.

Figure 1-3115 Install the TCU



3. Close the front door.

Figure 1-3116 Close the front door

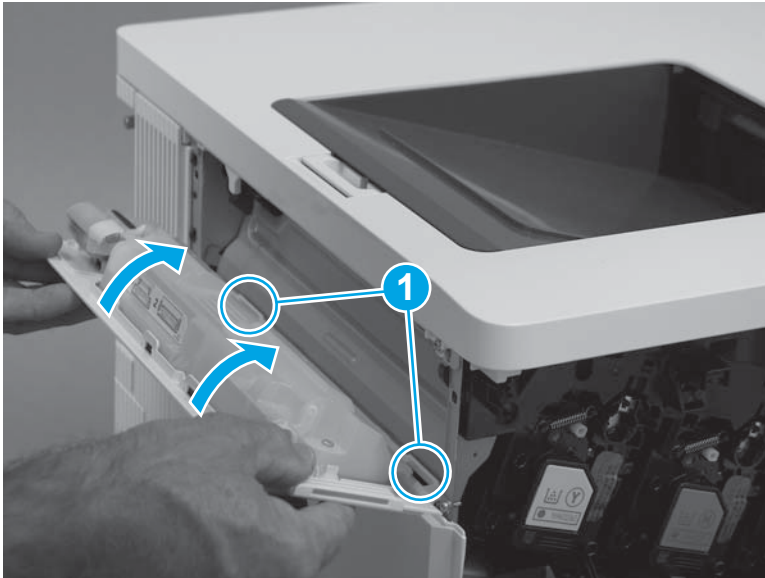

Step 49: Install the tray

1. With the front of the tray slightly lifted, align the sides of the tray with the rails in the printer, and then carefully slide the tray into the printer.

 **TIP:** As the tray slides into the printer, lower the front of it.

Figure 1-3117 Install the tray



2. Close the tray.

Figure 1-3118 Close the tray



Step 50: Install the control-panel assembly (M553x only)

 **NOTE:** For the M553n/dn and M552dn models, skip this step and go to [Step 51: Install the USB cover \(M552 and M553\) on page 1760](#).

For the M577 models, skip this step.

1. Place the control panel on the printer as shown.

Figure 1-3119 Place the control panel on the product

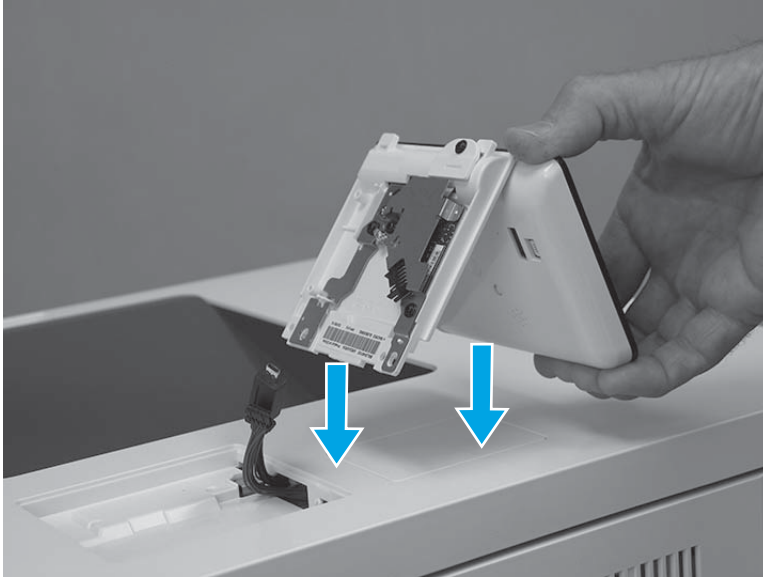

2. Connect one USB cable (callout 1), and one connector (callout 2).

 **IMPORTANT:** Take note of the location of the two mounting tabs (callout 3) on the control-panel assembly.

Figure 1-3120 Connect two connectors



3. Turn the control panel over, and then position the front edge tabs in the slots in the top cover.

Figure 1-3121 Turn the control panel over

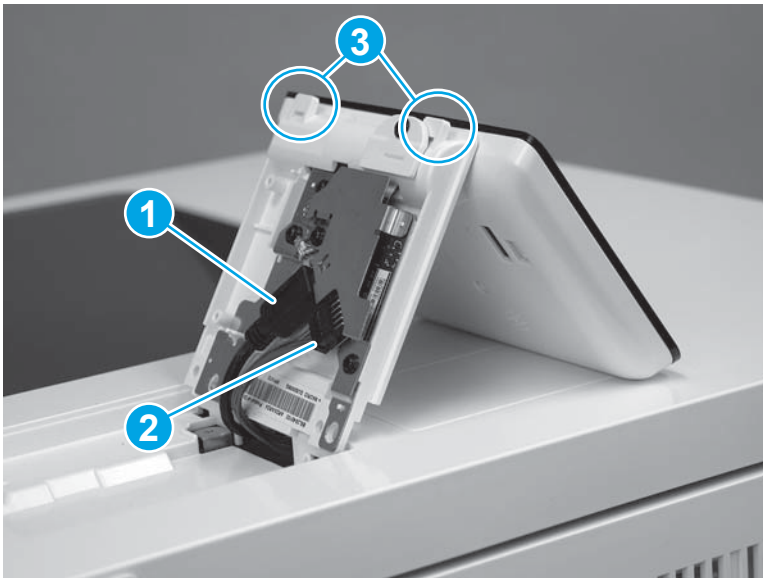
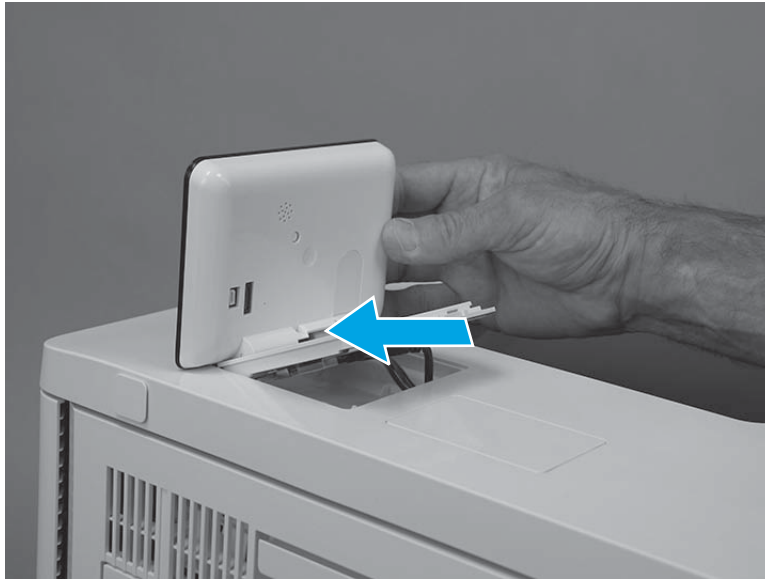

4. Rotate the control-panel base down onto the printer.

Figure 1-3122 Rotate the control-panel base down



5. Use a small Phillips screwdriver to install two screws (callout 1).

Figure 1-3123 Install two screws

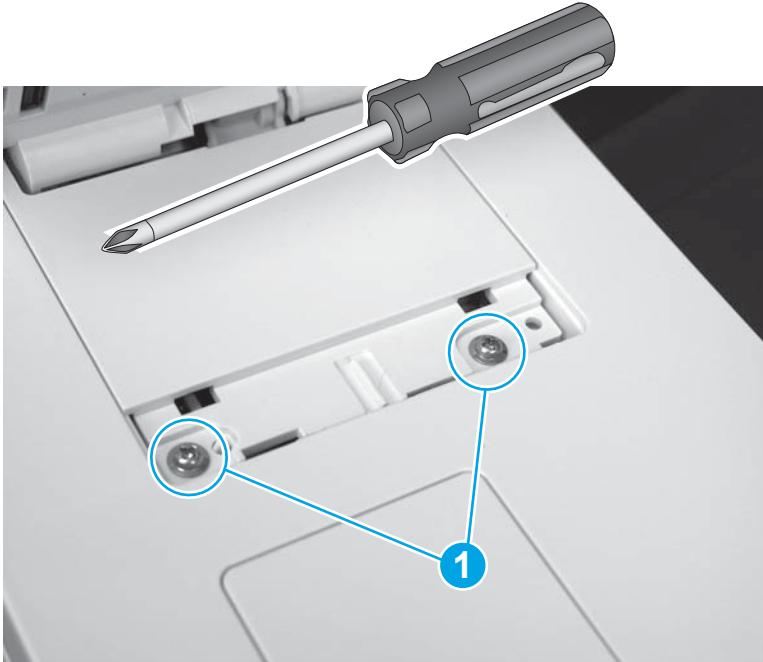

6. Position the screw cover mounting feet into the slots in the top cover (callout 1), and then rotate the cover down (callout 2) to install it.



 **NOTE:** Press down on the cover firmly to make sure that the tabs on the cover (callout 3) snap into place.

Figure 1-3124 Install the cover

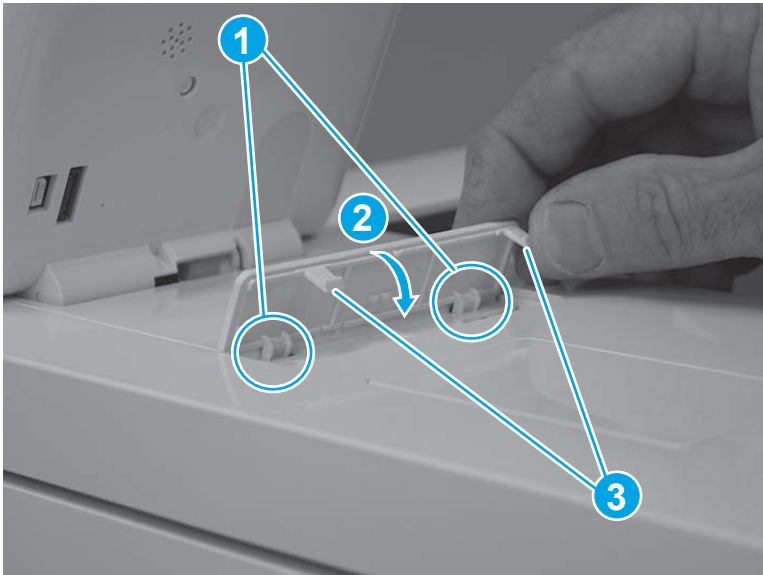

Step 51: Install the USB cover (M552 and M553)

 **NOTE:** This step is for the M552 and M553 models. For the M577 models, skip this step.

1. Push the cover into the USB port to install it.

Figure 1-3125 Install the cover



2. Make sure that the USB cover is fully seated after installing it.

Figure 1-3126 Check the installation



Removal and replacement: Environmental sensor printed circuit assembly (PCA)

- [Introduction](#)
- [Step 1: Remove the formatter cover](#)
- [Step 2: Remove the rear cover \(M552 and M553\)](#)
- [Step 3: Remove the rear upper cover \(M577\)](#)
- [Step 4: Remove the rear cover \(M577\)](#)
- [Step 5: Remove the environmental sensor PCA](#)
- [Step 6: Unpack the replacement assembly](#)
- [Step 7: Install the environmental sensor PCA](#)
- [Step 8: Install the rear cover \(M577\)](#)
- [Step 9: Install the rear upper cover \(M577\)](#)
- [Step 10: Install the rear cover \(M552 and M553\)](#)
- [Step 11: Install the formatter cover](#)

Introduction



This document provides the procedures to remove and replace the environmental sensor printed circuit assembly (PCA).

Before performing service

Turn the printer power off

- Disconnect the power cable.

 **WARNING!** To avoid damage to the printer, turn the printer off, wait 30 seconds, and then remove the power cord before attempting to service the printer.

 **CAUTION:**  This part contains components that are electrostatic discharge (ESD) sensitive. To reduce the possibility of ESD damage, always touch the sheet-metal chassis to ground yourself before touching an ESD sensitive part.

Use the table below to identify the correct part number for your printer, and then go to <http://h20141.www2.hp.com/hpparts> to order the part.

Environmental sensor printed circuit assembly (PCA) part number	
---	--

RM2-7154-000CN

Environmental sensor printed circuit assembly (PCA)

Required tools

- #2 Phillips screwdriver with a magnetic tip

After performing service

Turn the printer power on

- Connect the power cable.
- Use the power switch to turn the power on.

Post service test

Print a configuration page to make sure that the printer is functioning correctly.

Step 1: Remove the formatter cover

1. Locate the formatter cover.

Figure 1-3127 Locate the formatter cover

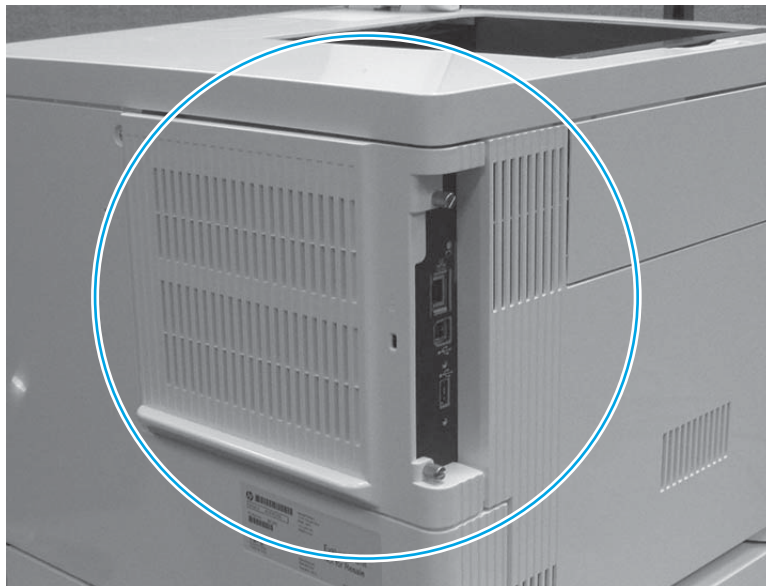

2. Loosen the two thumbscrews (callout 1). Grasp the two thumbscrews, and then slide the cover away from the printer (callout 2) to remove it.



 **TIP:** If needed, use the edge of a coin to turn the thumbscrews.

Figure 1-3128 Loosen the thumbscrews

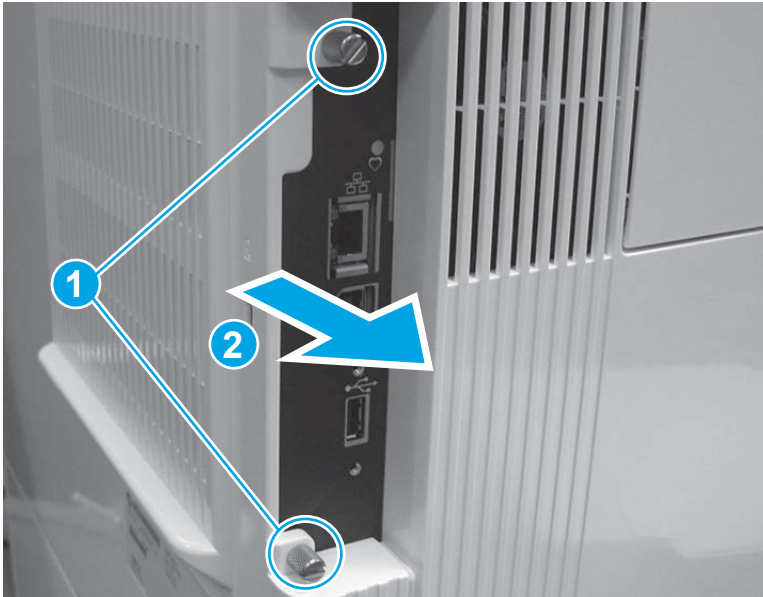

Step 2: Remove the rear cover (M552 and M553)

 **NOTE:** This step is for the M552 and M553 models. For the M577 models, skip this step and go to [Step 3: Remove the rear upper cover \(M577\) on page 1765](#).

1. Remove four screws (callout 1).

Figure 1-3129 Remove four screws

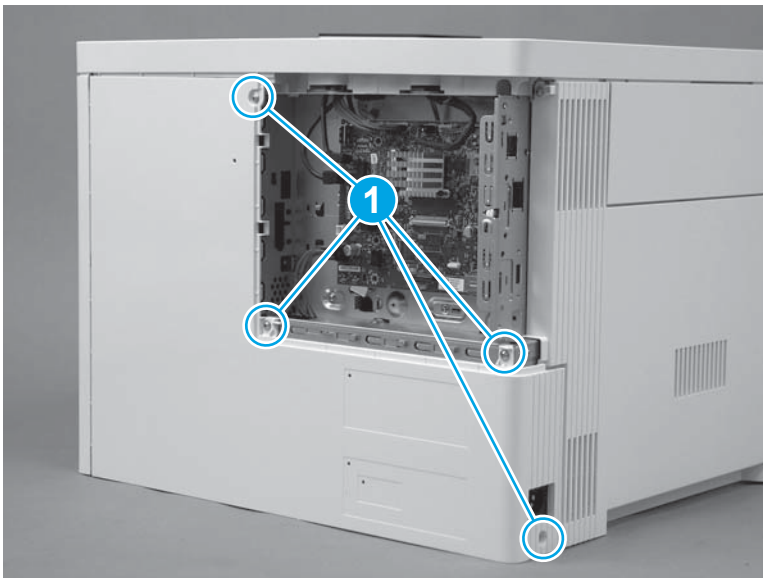

2. Slightly slide the cover to the right (callout 1), rotate the bottom of the cover away from the printer (callout 2), and then pull the top of the cover away from the printer (callout 3) to remove the cover.

Figure 1-3130 Remove the cover

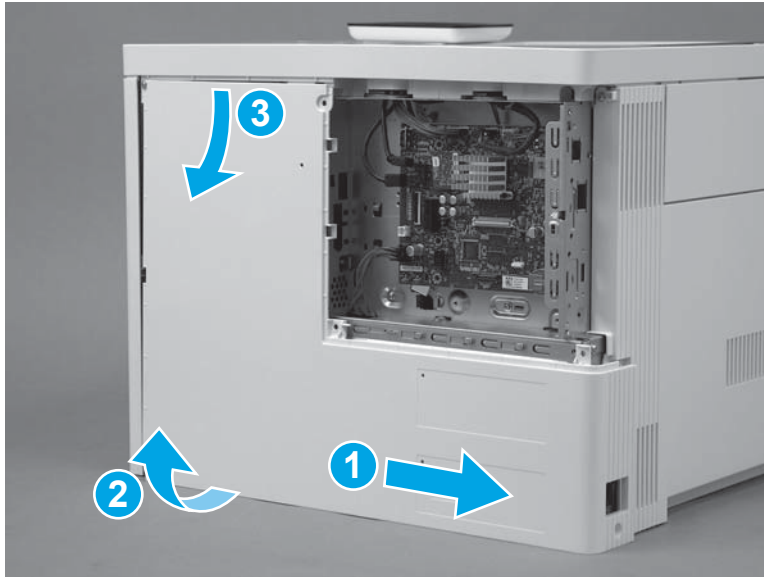

Step 3: Remove the rear upper cover (M577)

 **NOTE:** This step is for the M577 models. For the M552 and M553 models, skip this step and go to [Step 5: Remove the environmental sensor PCA on page 1768](#).

1. Remove two screws (callout 1).

 **Reinstallation tip:** These two screws are self-tapping screws for plastic. When reinstalling them, rotate the screws counterclockwise to align them with the existing thread pattern, and then carefully turn them clockwise to tighten. Do not overtighten. This will prevent stripping the threads inside the screw holes.

Figure 1-3131 Remove two screws



2. Use a small, flat blade screwdriver to release the right edge of the cover.

Figure 1-3132 Release the right edge

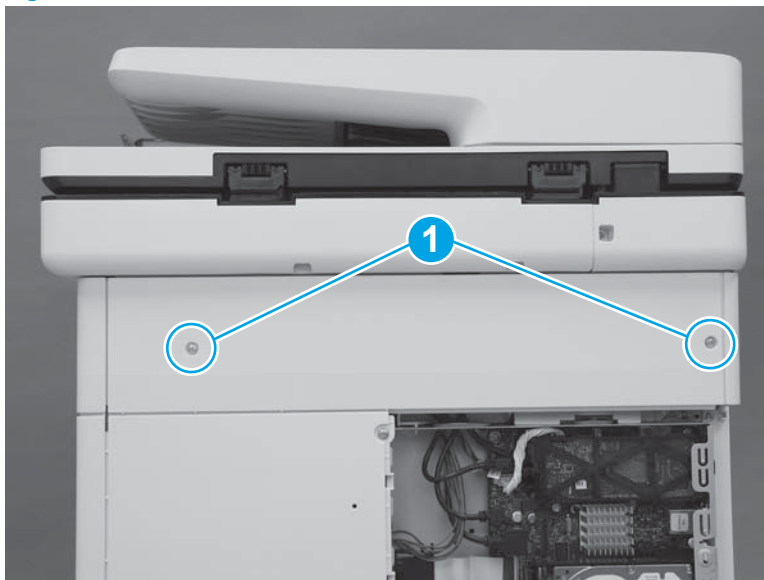
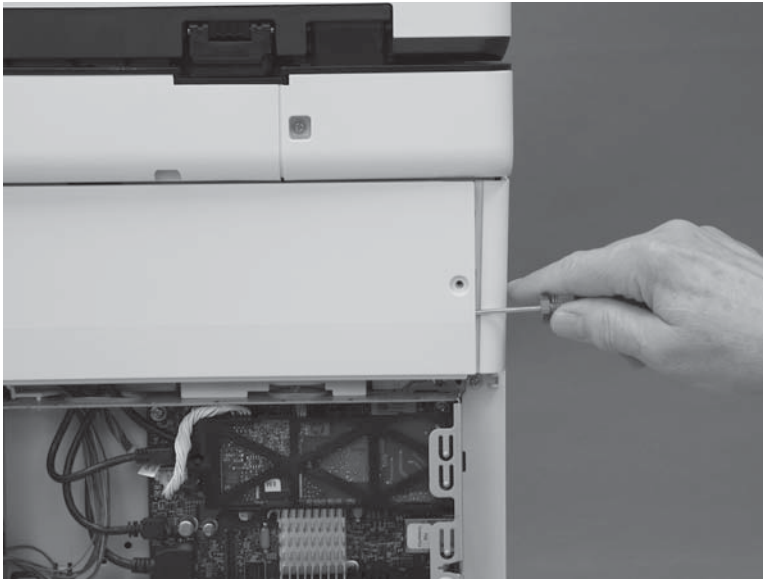

3. Pull the right edge of the cover (callout 1) away from the printer, and then slide the cover to the right (callout 2).

Figure 1-3133 Slide the cover right

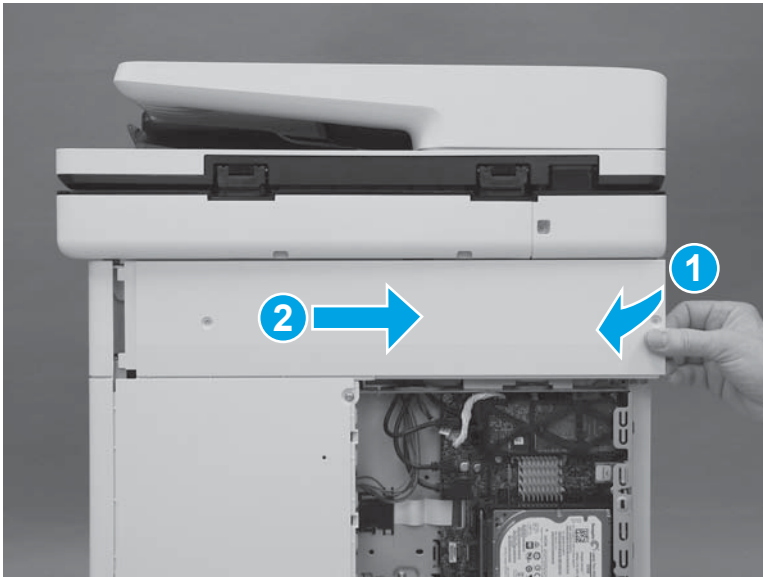

4. Remove the cover.

Figure 1-3134 Remove the cover

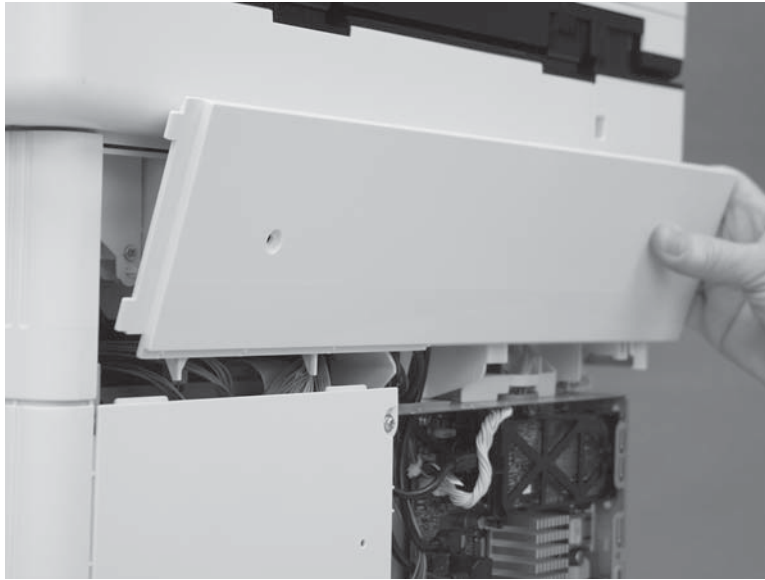

Step 4: Remove the rear cover (M577)

 **NOTE:** This step is for the M577 models. For the M552 and M553 models, skip this step and go to [Step 5: Remove the environmental sensor PCA on page 1768.](#)

1. Remove four screws (callout 1).

Figure 1-3135 Remove four screws

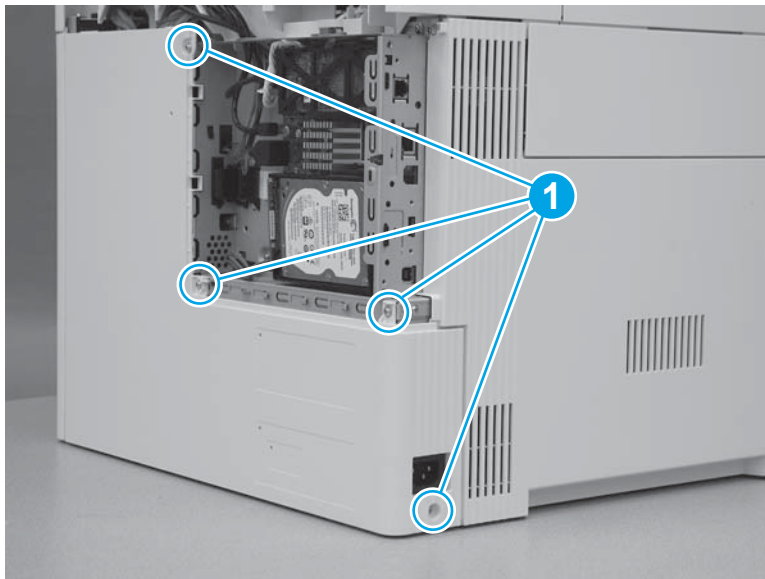

2. Slide the cover to the right to remove it.

Figure 1-3136 Remove the cover

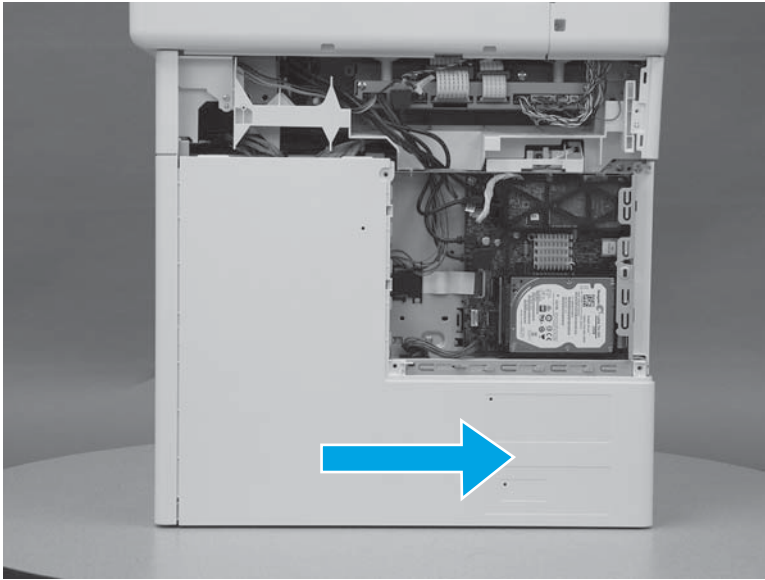

Step 5: Remove the environmental sensor PCA

 **CAUTION:**  ESD-sensitive part.

1. Remove two screws (callout 1), and then slide the low-voltage power supply (LVPS) cover to the right to remove it.

Figure 1-3137 Remove the LVPS cover

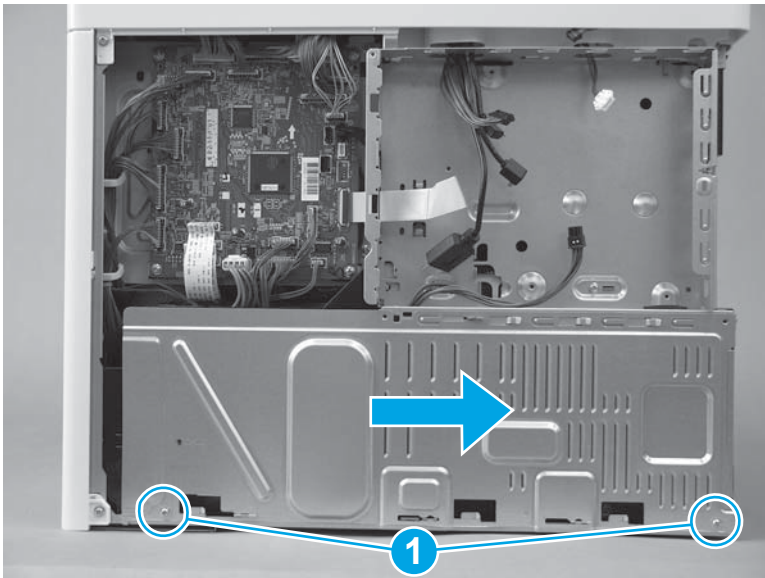

2. Disconnect one connector (callout 1).

Figure 1-3138 Disconnect one connector

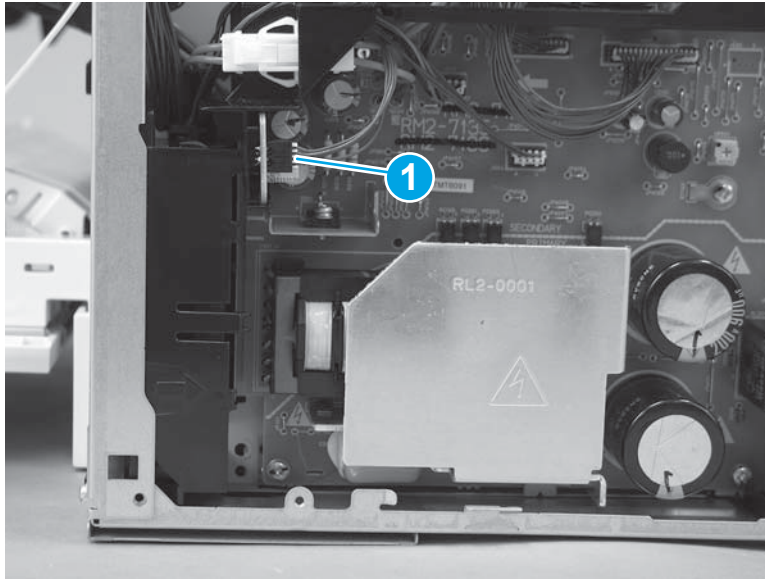

3. Slide the environmental sensor PCA out of the holder to remove it.

Figure 1-3139 Remove the sensor

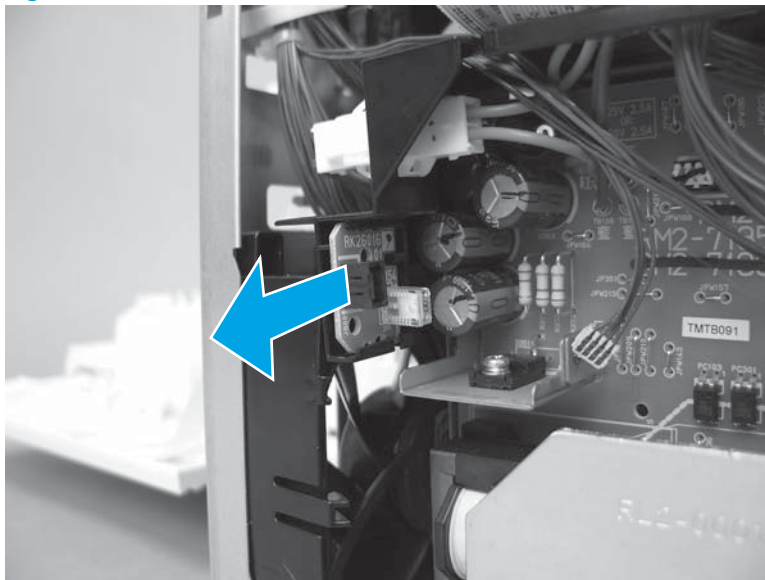

Step 6: Unpack the replacement assembly

Unpack the replacement assembly from the packaging.

 **CAUTION:**  ESD-sensitive part.

For complete information on HP's recycling programs, go to [Product return and recycling](#).

 **NOTE:** HP recommends responsible disposal of the defective assembly.

Figure 1-3140 Recycle and unpack

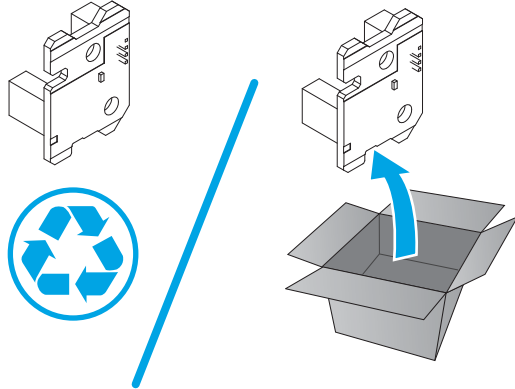

Step 7: Install the environmental sensor PCA

 **CAUTION:**  ESD-sensitive part.

1. Slide the environmental sensor PCA into the holder to install it.

Figure 1-3141 Install the sensor

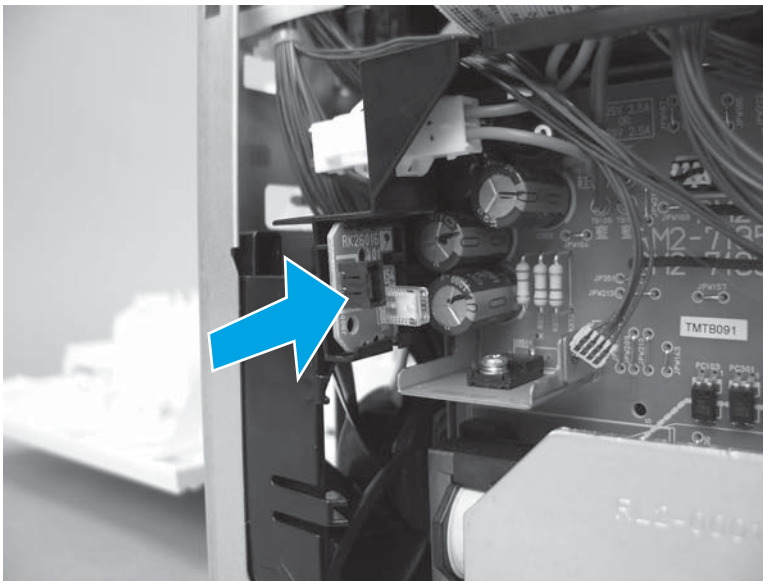

2. Connect one connector (callout 1).

Figure 1-3142 Connect one connector

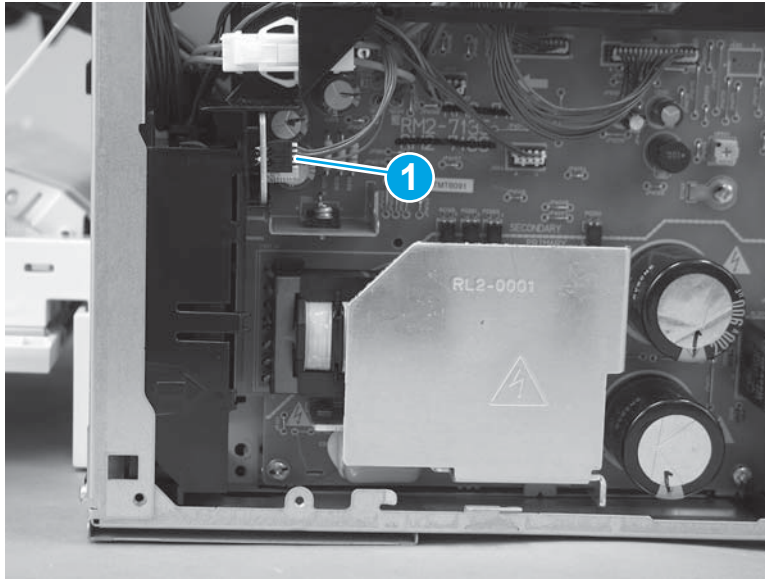

3. Position the LVPS cover on the chassis, slide the cover to the left to install it, and then install two screws (callout 1).

Figure 1-3143 Install the LVPS cover

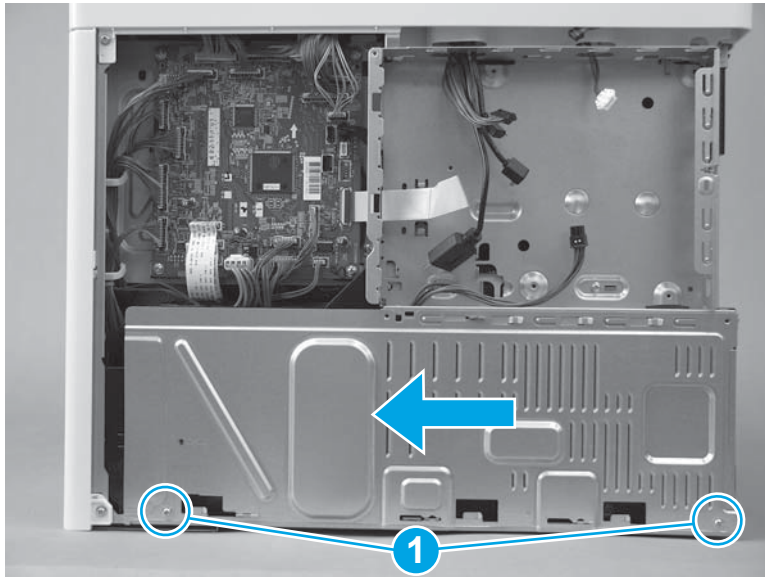

Step 8: Install the rear cover (M577)

 **NOTE:** This step is for the M577 models. For the M552 and M553 models, skip this step and go to [Step 10: Install the rear cover \(M552 and M553\) on page 1775.](#)

1. Position the hooks (callout 1) on the cover in the slots (callout 2) in the printer.

Figure 1-3144 Position the hooks

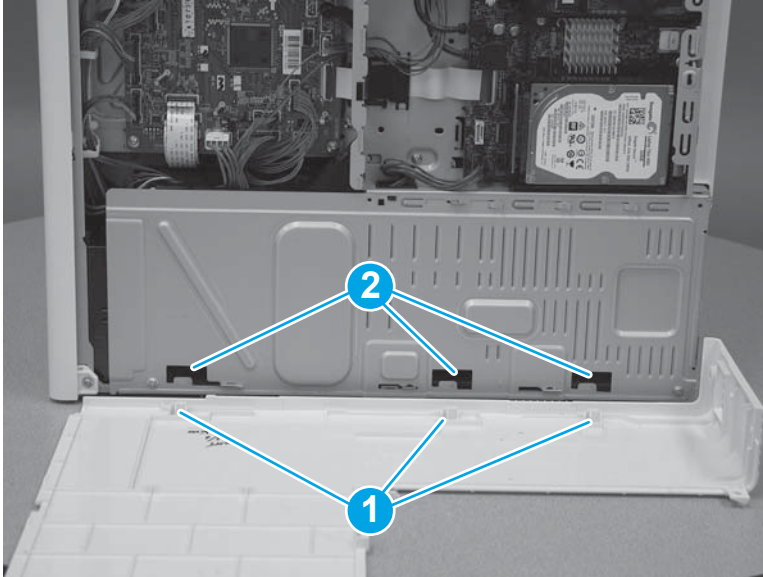

2. Position the back edge (callout 1) of the rear cover behind the edge (callout 2) of the right rear cover. Slide the cover to the left to install it.

Figure 1-3145 Install the cover

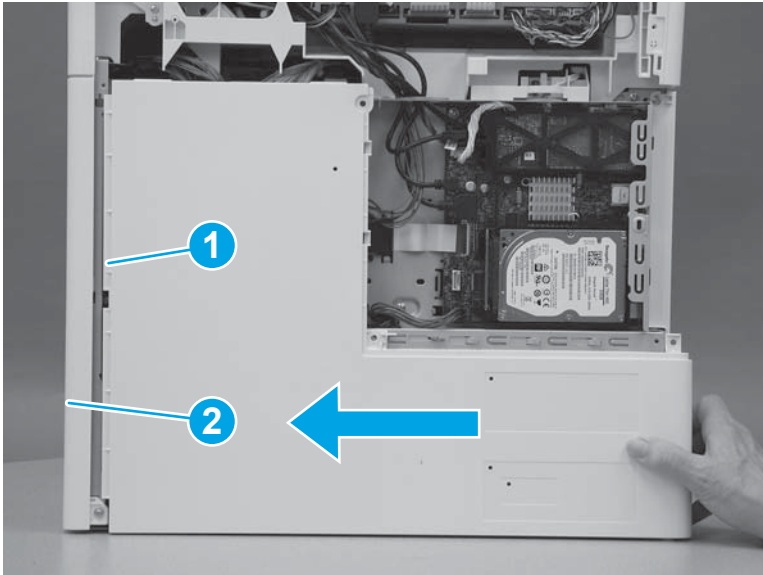

3. Install four screws (callout 1).

Figure 1-3146 Install four screws cover

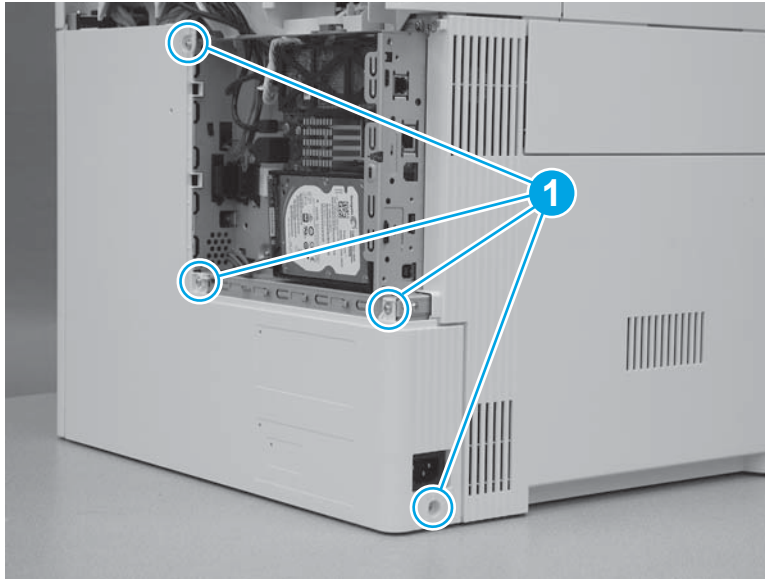

Step 9 Install the rear upper cover (M577)

 **NOTE:** This step is for the M577 models. For the M552 and M553 models, skip this step and go to [Step 10: Install the rear cover \(M552 and M553\)](#) on page 1775.

1. Align the ridge (callout 1) on the lower edge of the rear upper cover in front of the tabs (callout 2) on the top edge of the rear cover.

Figure 1-3147 Align the cover

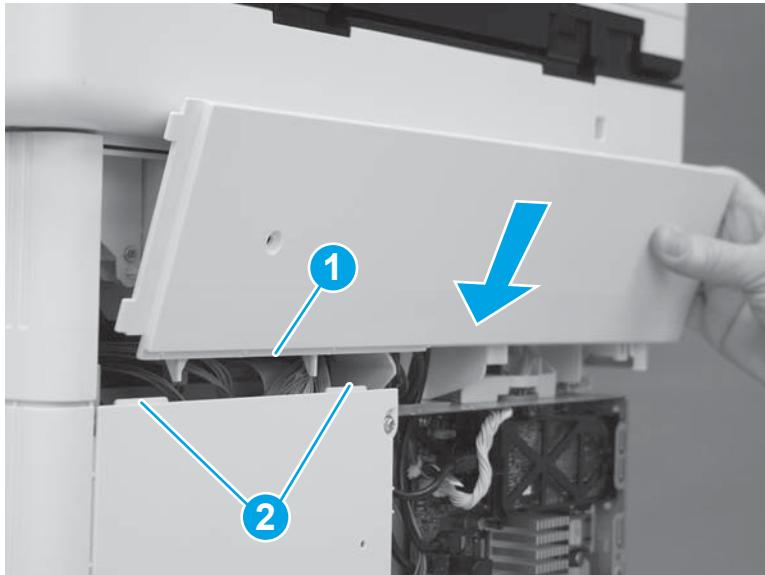

2. Rotate the top of the cover toward the printer.

Figure 1-3148 Rotate the top of the cover

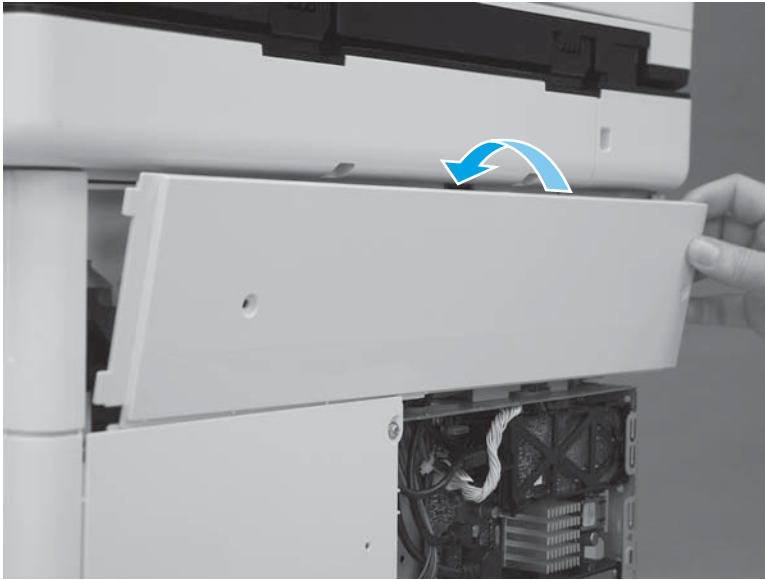

3. Slide the cover to the left (callout 1). Make sure that the tabs (callout 2) on the upper rear cover slide behind the edge (callout 3) of the right upper cover. Make sure that the cover is fully seated.

Figure 1-3149 Slide the cover

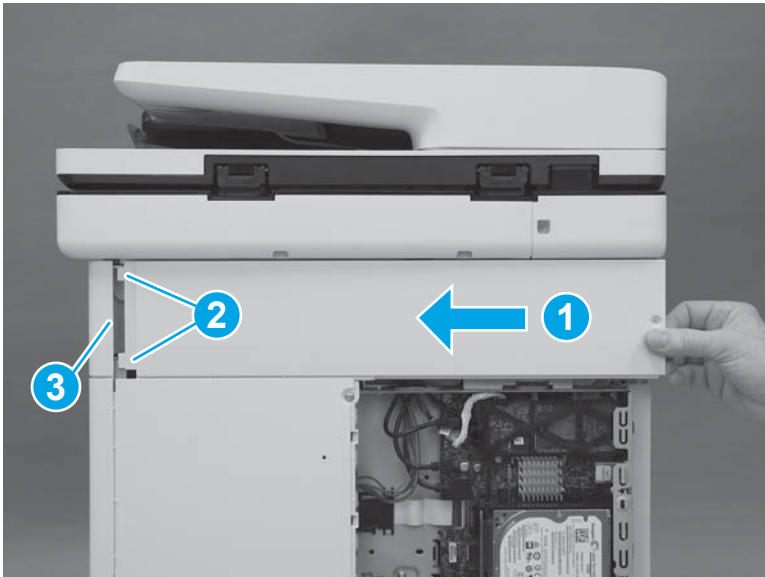

4. Install two screws (callout 1).

 **IMPORTANT:** These two screws are self-tapping screws for plastic. Rotate them counterclockwise to align them with the existing thread pattern, and then carefully turn them clockwise to tighten. Do not overtighten. This will prevent stripping the threads inside the screw holes.

Figure 1-3150 Install two screws



Step 10: Install the rear cover (M552 and M553)

 **NOTE:** This step is for the M552 and M553 models. For the M577 models, skip this step and go to [Step 11: Install the formatter cover on page 1776](#).

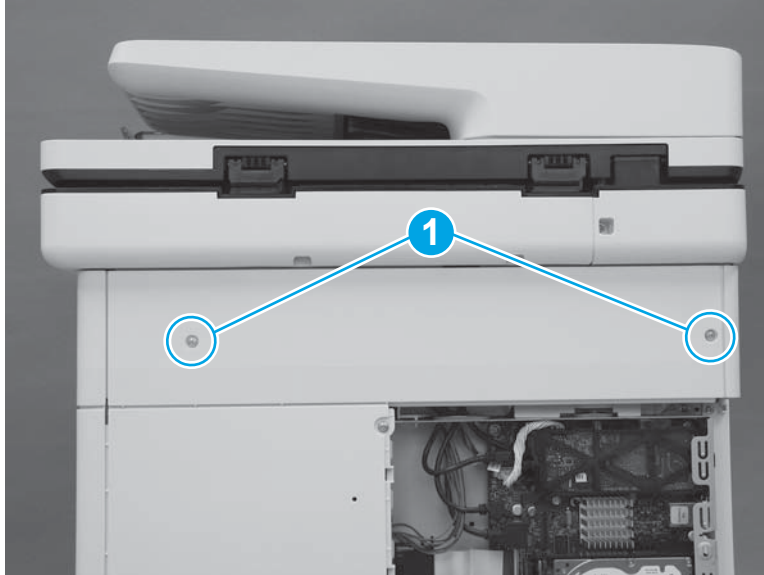
1. Position the top of the cover under the upper cover (callout 1), rotate the bottom of the cover onto the chassis (callout 2), and then slide the cover to the left (callout 3) to install it.

Figure 1-3151 Install the cover

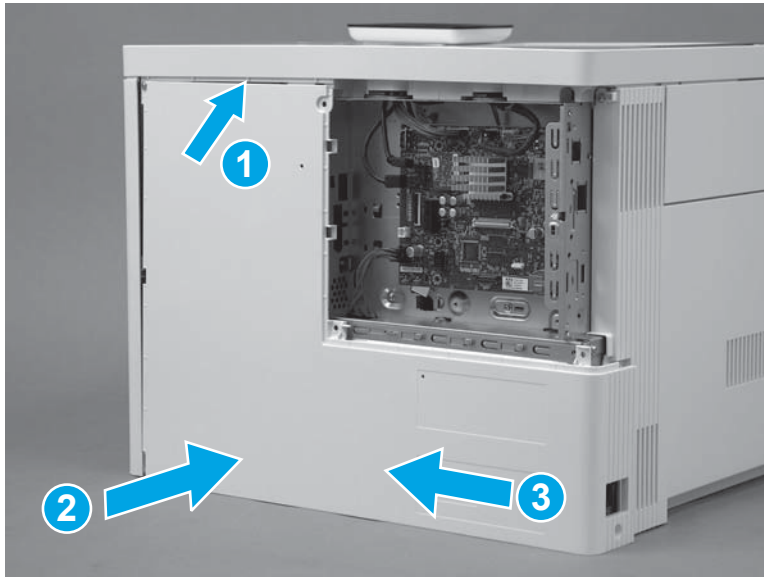

2. Install four screws (callout 1).

Figure 1-3152 Install four screws cover

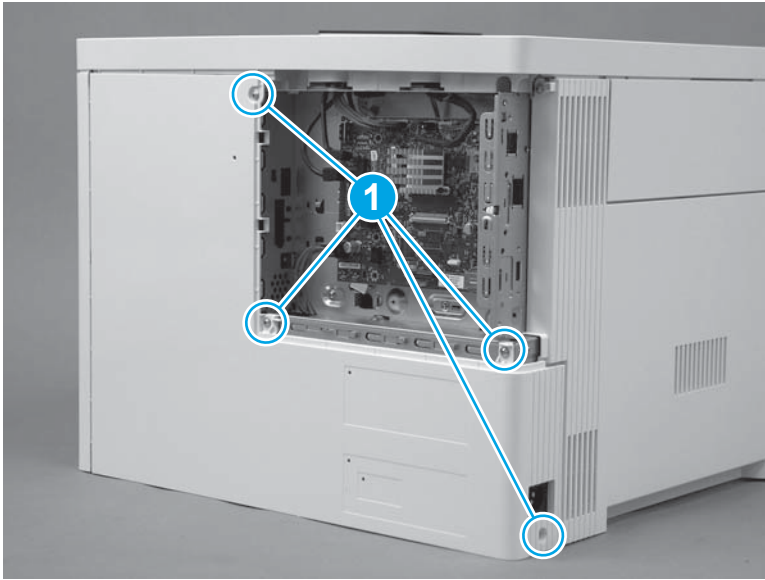

Step 11: Install the formatter cover

- ▲ Slide the cover onto the printer (callout 1) to install it.

 **NOTE:** Make sure that the tabs on the formatter cover align with the slots provided in the printer (callout 2). Tighten the two thumbscrews (callout 3).

 **TIP:** If needed, use the edge of a coin to turn the thumbscrews.

Figure 1-3153 Install the cover



Removal and replacement: Fuser drive assembly

- [Introduction](#)
- [Step 1: Remove the USB cover \(M552 and M553\)](#)
- [Step 2: Remove the fuser](#)
- [Step 3: Remove the control panel \(M553x only\)](#)
- [Step 4: Remove the tray](#)
- [Step 5: Remove the toner collection unit \(TCU\)](#)
- [Step 6: Remove the formatter cover](#)
- [Step 7: Remove the formatter \(M552 and M553\)](#)
- [Step 8: Remove the hard-disk drive \(HDD\) \(M577\)](#)
- [Step 9: Remove the fax PCA \(M577c/f/z\)](#)
- [Step 10: Remove the formatter \(M577\)](#)
- [Step 11: Remove the rear cover \(M552 and M553\)](#)
- [Step 12: Remove the rear upper cover \(M577\)](#)
- [Step 13: Remove the rear cover \(M577\)](#)
- [Step 14: Remove the left upper cover \(M577\)](#)
- [Step 15: Remove the right front upper cover \(M577dn\)](#)
- [Step 16: Remove the stapler cover assembly \(M577c/f/z\)](#)
- [Step 17: Remove the integrated scanner assembly \(ISA\) \(M577\)](#)
- [Step 18: Remove the stapler unit \(M577c/f/z\)](#)
- [Step 19: Remove the right upper cover \(M577\)](#)
- [Step 20: Remove the top rear cover \(M577\)](#)
- [Step 21: Remove the paper feed cover \(M577\)](#)
- [Step 22: Remove the top cover \(M577\)](#)
- [Step 23: Remove the top bracket \(M577\)](#)
- [Step 24: Remove the left cover](#)
- [Step 25: Remove the upper cover \(M552 and M553\)](#)
- [Step 26: Remove the formatter case](#)
- [Step 27: Remove the right rear cover](#)
- [Step 28: Remove the DC controller and sheet-metal bracket](#)
- [Step 29: Remove the high-voltage power supply T \(HVPST\)](#)

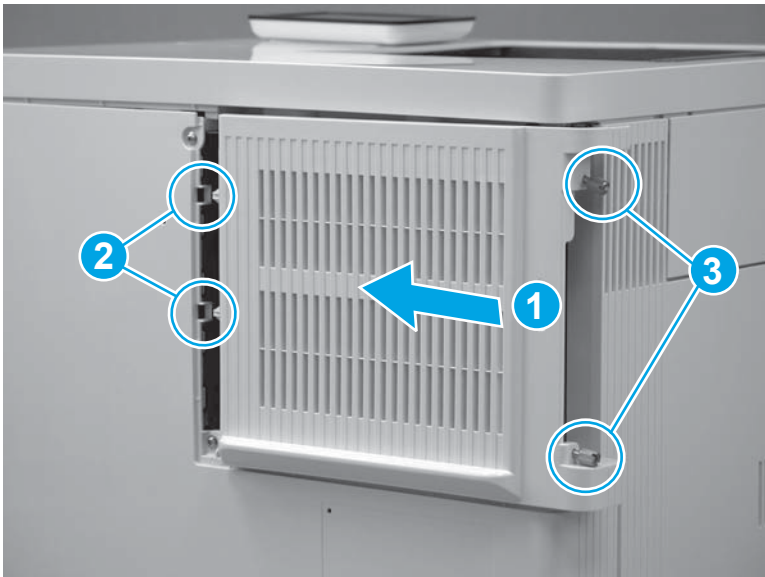
- [Step 30: Remove the fuser drive assembly](#)
- [Step 31: Unpack the replacement assembly](#)
- [Step 32: Install the fuser drive assembly](#)
- [Step 33: Install the HVPST](#)
- [Step 34: Install the DC controller and sheet-metal bracket](#)
- [Step 35: Install the right rear cover](#)
- [Step 36: Install the formatter case](#)
- [Step 37: Install the upper cover \(M552 and M553\)](#)
- [Step 38: Install the left cover](#)
- [Step 39: Install the top bracket \(M577\)](#)
- [Step 40: Install the top cover \(M577\)](#)
- [Step 41: Install the paper feed cover \(M577\)](#)
- [Step 42: Install the top rear cover \(M577\)](#)
- [Step 43: Install the right upper cover \(M577\)](#)
- [Step 44: Install the stapler unit \(M577c/f/z\)](#)
- [Step 45: Install the integrated scanner assembly \(ISA\) \(M577\)](#)
- [Step 46: Install the stapler cover assembly \(M577c/f/z\)](#)
- [Step 47: Install the right front upper cover \(M577dn\)](#)
- [Step 48: Install the left upper cover \(M577\)](#)
- [Step 49: Install the rear cover \(M577\)](#)
- [Step 50: Install the rear upper cover \(M577\)](#)
- [Step 51: Install the rear cover \(M552 and M553\)](#)
- [Step 52: Install the formatter \(M577\)](#)
- [Step 53: Install the fax PCA \(M577c/f/z\)](#)
- [Step 54: Install the HDD \(M577\)](#)
- [Step 55: Install the formatter \(M552 and M553\)](#)
- [Step 56: Install the formatter cover](#)
- [Step 57: Install the TCU](#)
- [Step 58: Install the tray](#)
- [Step 59: Install the control-panel assembly \(M553x only\)](#)
- [Step 60: Install the fuser](#)

- [Step 61: Install the USB cover \(M552 and M553\)](#)

Introduction

This document provides the procedures to remove and replace the fuser drive assembly.



NOTE: The fuser drive assembly includes the fuser motor (M4).

Before performing service



TIP: Some figures might show assemblies removed or installed that have not yet been removed or installed at that specific step. However, the procedures are correct for this printer and the target assembly. Always thoroughly read the instructions that accompany each figure.

Turn the printer power off

- Disconnect the power cable.



WARNING! To avoid damage to the printer, turn the printer off, wait 30 seconds, and then remove the power cord before attempting to service the printer.

Use the table below to identify the correct part number for your printer, and then go to <http://h20141.www2.hp.com/hpparts> to order the part.

Fuser drive assembly part number	
RM2-0091-000CN	Fuser drive assembly (M553n)
RM2-0009-000CN	Fuser drive assembly (M552dn, M553dn, M553x, M577)

Required tools

- #2 Phillips screwdriver with a magnetic tip

After performing service

Make sure that all of the connectors on the HVPST are fully seated.

Make sure that all of the connectors on the DC controller are fully seated.

Make sure that all of the connectors on the formatter are fully seated.

Make sure that the formatter cover is fully seated, and that the thumbscrews are finger tight after replacing it.

Turn the printer power on

- Connect the power cable.
- Use the power switch to turn the power on.

Post service test

Use the components test to test the (fuser) motor. For more information, see the printer troubleshooting manual.

Step 1: Remove the USB cover (M552 and M553)

 **NOTE:** This step is for the M552 and M553 models. For the M577 models, skip this step and go to [Step 4: Remove the tray on page 1786](#).

1. Locate the USB cover.

Figure 1-3154 Locate the USB cover



2. Pull the cover off of the printer to remove it.

Figure 1-3155 Remove the cover



Step 2: Remove the fuser

1. Open the right door.

 **CAUTION:** The fuser is very hot. After turning the printer power off, allow the fuser to cool for at least 30 minutes before removing it.

Figure 1-3156 Open the right door



2. Grasp the two fuser handles, and then squeeze the two blue triggers on the handles to release the fuser.

Figure 1-3157 Release the fuser

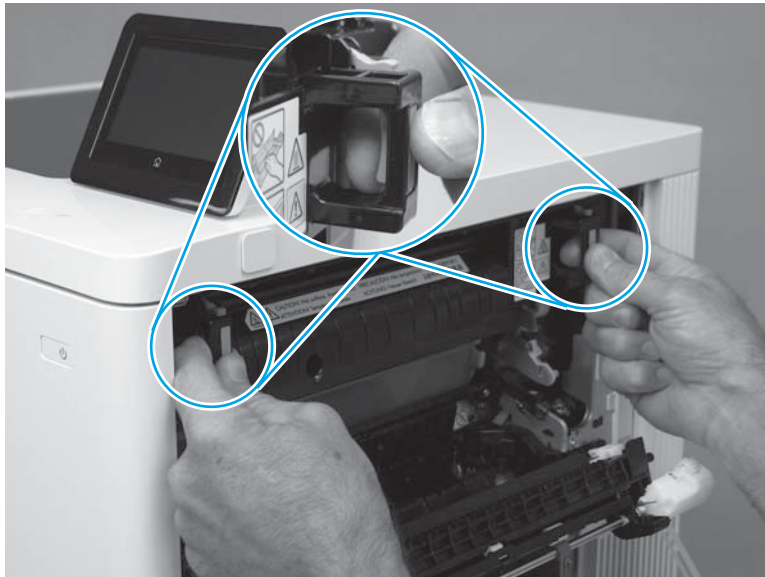

3. Slide the fuser straight out of the printer to remove it.

Figure 1-3158 Remove the fuser



Step 3: Remove the control panel (M553x only)

 **NOTE:** This step is for the M553x model. For the M553n/dn, M552dn, and M577 models, skip this step and go to [Step 4: Remove the tray on page 1786](#).

1. Tilt the control panel up.

Figure 1-3159 Tilt the control panel up



2. Use a small flat-blade screwdriver to release the control-panel screws cover tabs.

Figure 1-3160 Release the control-panel screws cover tabs



3. Rotate the cover up to remove it.

Figure 1-3161 Remove the cover

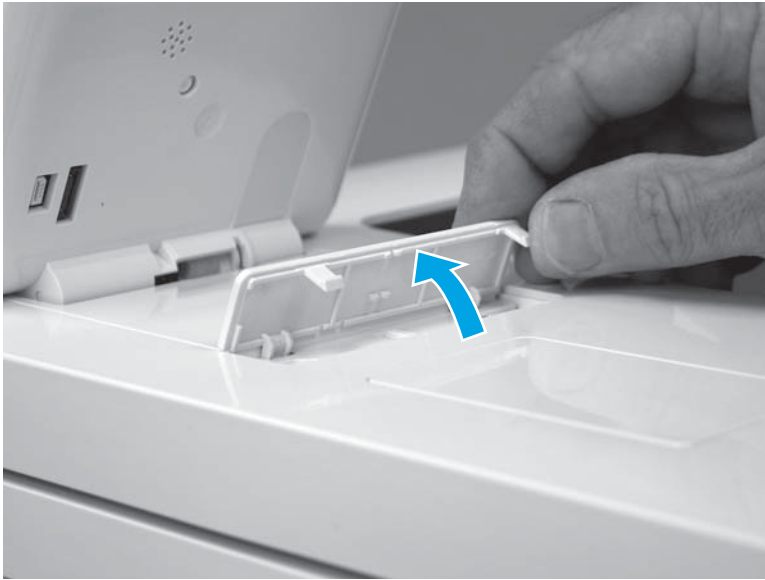

4. Use a small Phillips screwdriver to remove two screws (callout 1).

 **IMPORTANT:** Store the screws in a secure place where they cannot fall down into the printer.

Figure 1-3162 Remove two screws



5. Rotate the control-panel base toward the front of the printer.

Figure 1-3163 Rotate the control-panel base up

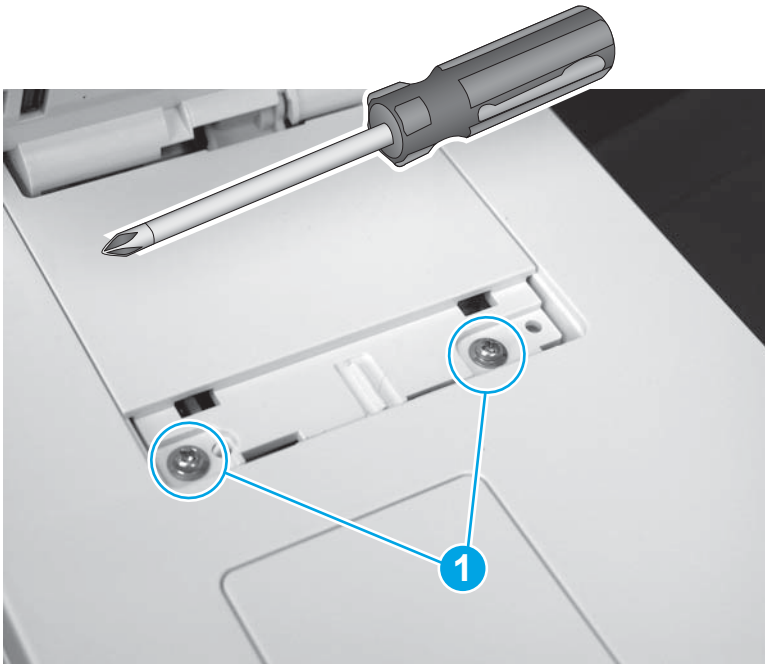

6. Slightly slide the control-panel base toward the rear of the printer (callout 1) to release it, and then turn the control panel over (callout 2) to access the bottom side.

⚠ CAUTION: The control panel is still attached to the printer. Do not attempt to completely remove the control panel.

Figure 1-3164 Turn the control panel over

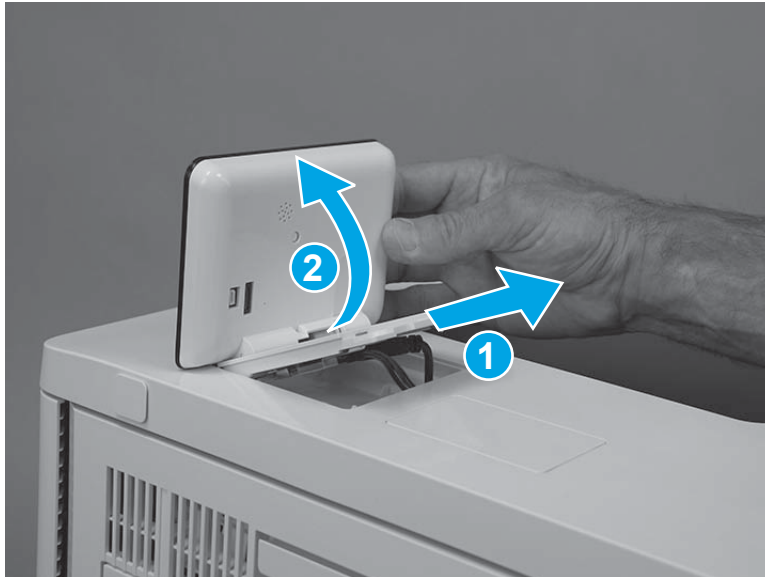

7. Disconnect one USB cable (callout 1), one connector (callout 2), and then remove the control panel.

Figure 1-3165 Disconnect two connectors

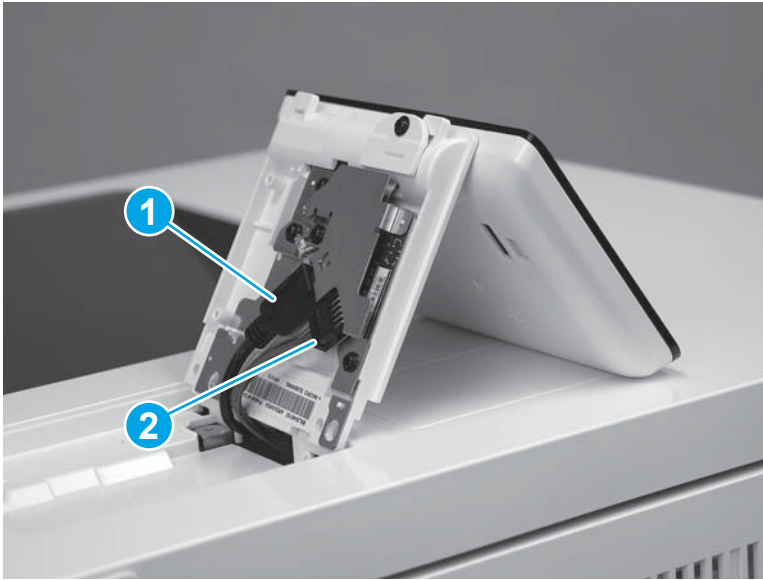

Step 4: Remove the tray

1. Pull the tray out until it stops.

Figure 1-3166 Pull the tray out



2. Lift the front of the tray, and then pull it out of the printer to remove it.

Figure 1-3167 Remove the tray

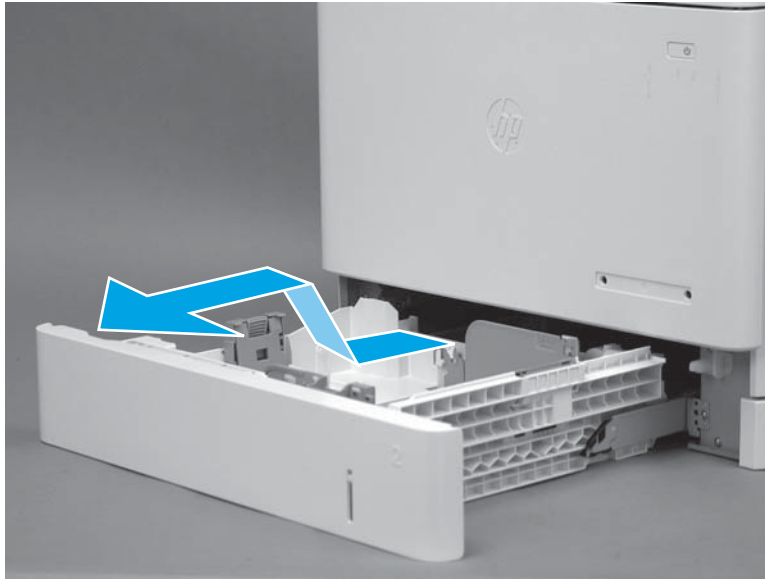

Step 5: Remove the toner collection unit (TCU)

1. Open the front door.

Figure 1-3168 Open the front door



2. Open the TCU.

 **NOTE:** The toner collection hatch cover automatically closes when the TCU is opened.

Figure 1-3169 Open the TCU



3. Pull the TCU away from the printer at an angle to remove it.

⚠ CAUTION: Do not open the toner collection hatch cover when handling the TCU. If toner gets on clothing, wipe it off by using a dry cloth and wash the clothes in cold water. Hot water sets toner into fabric.

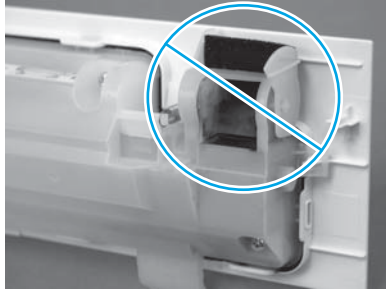
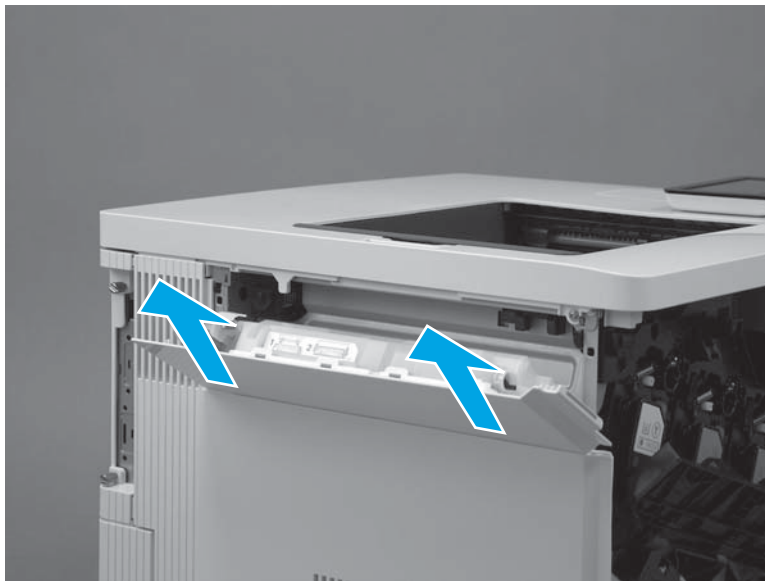

Figure 1-3170 Remove the TCU



Step 6: Remove the formatter cover

1. Locate the formatter cover.

Figure 1-3171 Locate the formatter cover

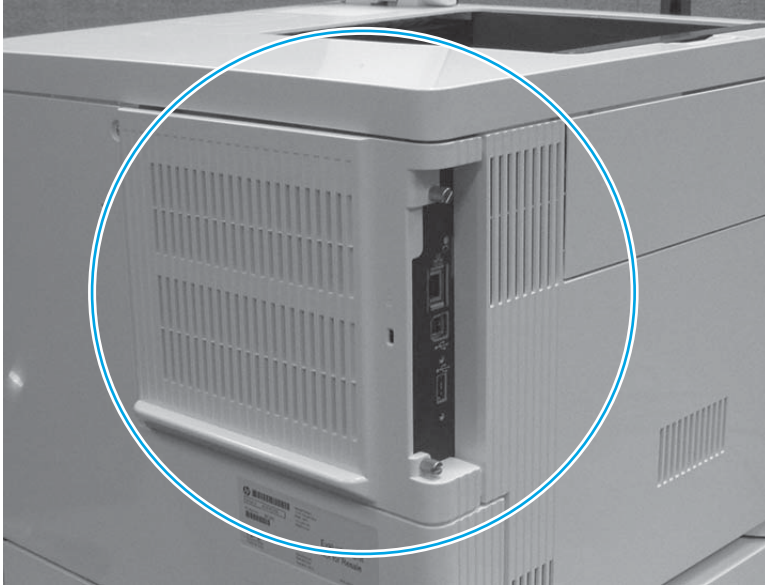

2. Loosen the two thumbscrews (callout 1). Grasp the two thumbscrews, and then slide the cover away from the printer (callout 2) to remove it.

 **TIP:** If needed, use the edge of a coin to turn the thumbscrews.

Figure 1-3172 Loosen the thumbscrews



Step 7: Remove the formatter (M552 and M553)

 **NOTE:** This step is for the M552 and M553 models. For the M577 models, skip this step and go to [Step 8: Remove the hard-disk drive \(HDD\) \(M577\) on page 1792](#).

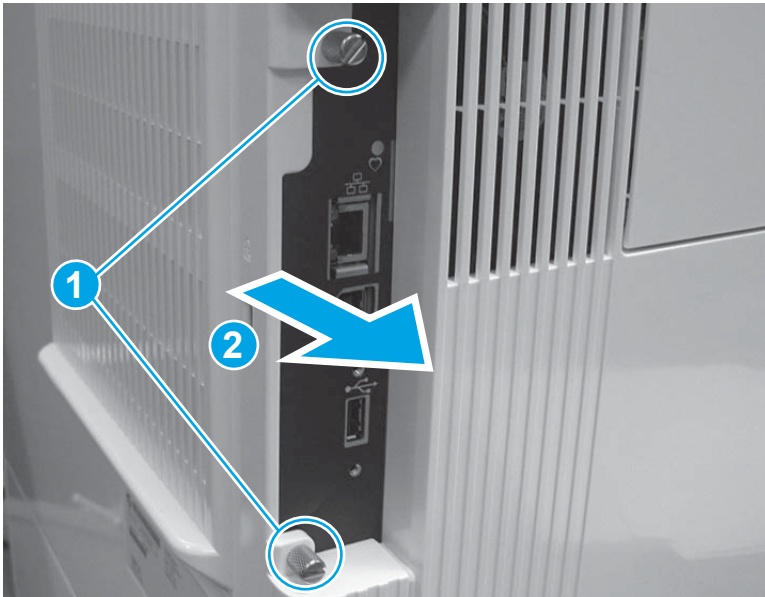
If the optional hard-disk drive (HDD) is installed, it must be removed to gain access to the formatter mounting screws.

Release two tabs along the left edge of the HDD, rotate the left edge away from the product, and then slide the HDD to the left to remove it.

 **CAUTION:**  ESD-sensitive part.

1. Disconnect all of the connectors on the formatter.

The following connectors are empty:

- All models: J1 (this connector is empty unless the optional DIMM is installed)
- M553n/dn and M552dn: J2 (callout 1; this is the touchscreen connector for the M553x model)
- All models: J9 (this connector is empty unless the optional internal USB ports component is installed)
- All models: J18 (this connector is empty unless the optional hard-disk-drive (HDD) is installed)
- All models: J23
- All models: J24
- M553n/dn and M552dn: J25 (this is the wireless connector for the M553x model)
- All models: J57
- All models: J98 (this connector is empty unless the optional trusted platform module (TPM) is installed)

 **IMPORTANT:** The flat-cable connector (callout 2) is a Zero Insertion Force (ZIF) connector that uses a hinged retainer to secure the flat cable. The hinged retainer must be opened to release the flat cable.

Figure 1-3173 Disconnect all connectors



2. Remove four screws (callout 1), and then remove the formatter.

Figure 1-3174 Remove the formatter

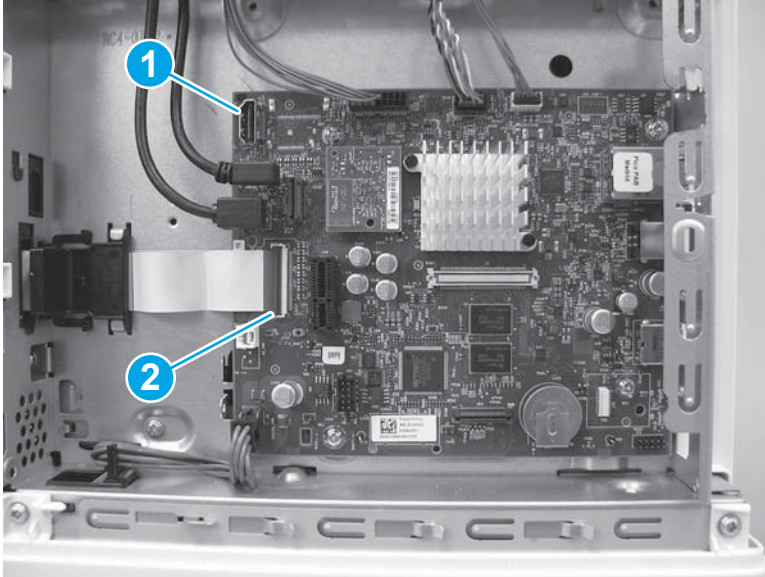
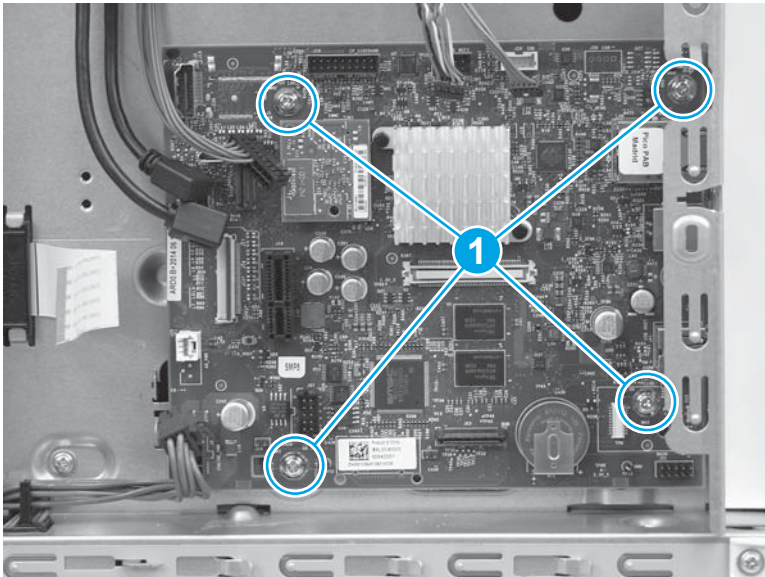

Step 8: Remove the hard-disk drive (HDD) (M577)

 **NOTE:** This step is for the M577 models. For the M552 and M553 models, skip this step and go to [Step 11: Remove the rear cover \(M552 and M553\)](#) on page 1797.

 **CAUTION:**  ESD-sensitive part.

1. Release two tabs (callout 1). Hold the tabs in the released position, and then rotate the hard disk drive (HDD) up (callout 2) to release the connector from the formatter.

Figure 1-3175 Release the HDD

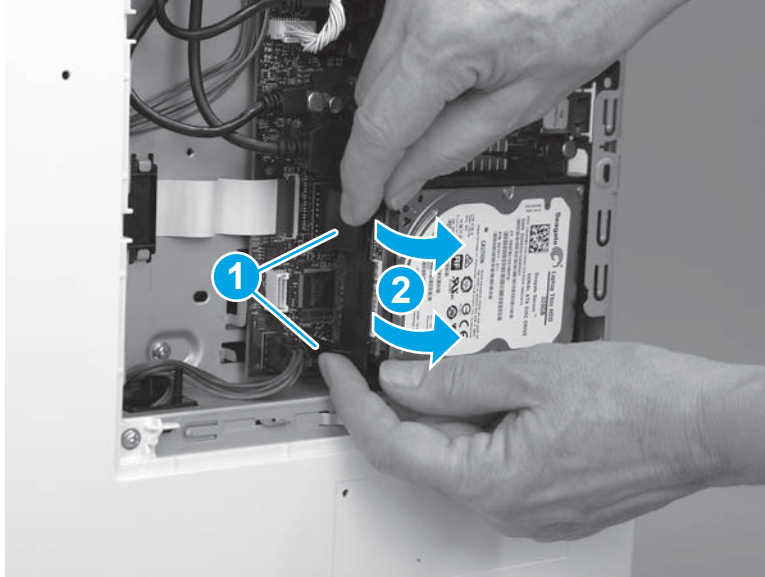

2. Slide the HDD away from the printer to remove it.

Figure 1-3176 Remove the HDD

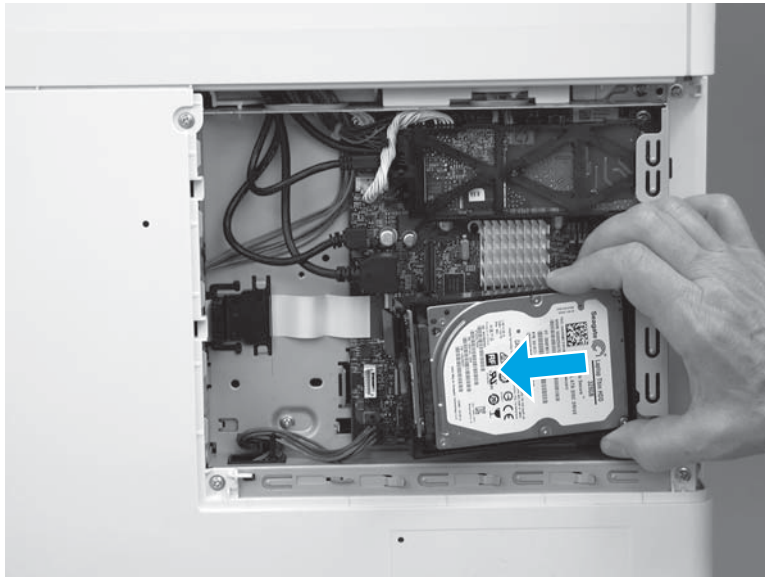

Step 9: Remove the fax PCA (M577c/f/z)



NOTE: This step is for the M577c/f/z models. For the M577n model, skip this step and go to [Step 10: Remove the formatter \(M577\) on page 1795](#).

For the M552 and M553 models, skip this step and go to [Step 11: Remove the rear cover \(M552 and M553\) on page 1797](#).



CAUTION:  ESD-sensitive part.

1. Locate the fax PCA component on the formatter.

Figure 1-3177 Locate the fax PCA

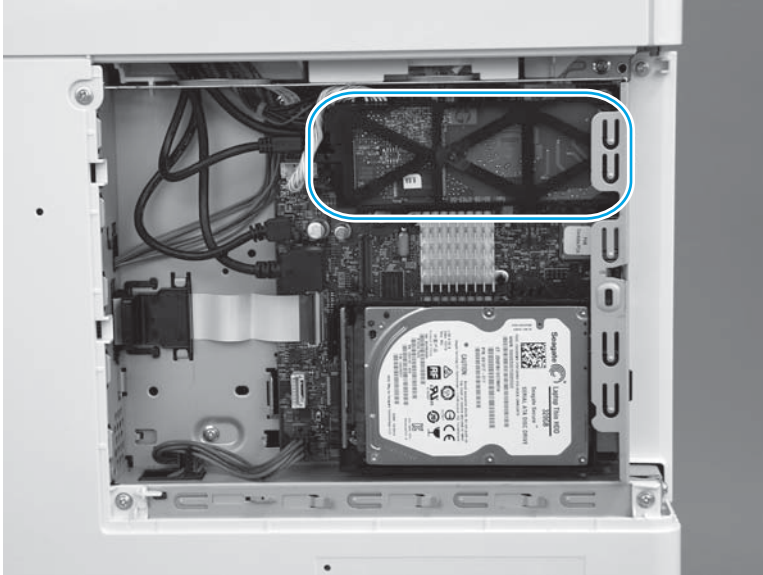

2. Release the connector latch (callout 1), and then pull the connector away from the formatter (callout 2) to disconnect it.

Figure 1-3178 Disconnect one connector

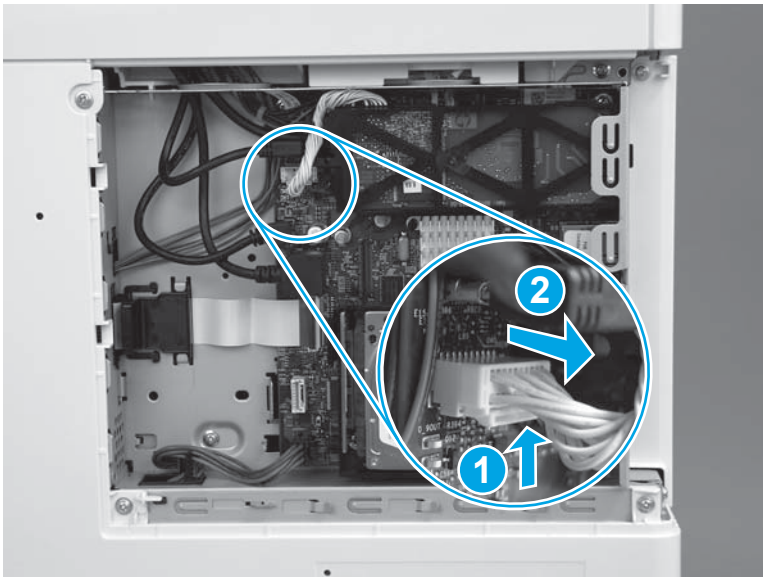

3. Release one retainer (callout 1) by pressing the bracket arms together.

Figure 1-3179 Release one latch

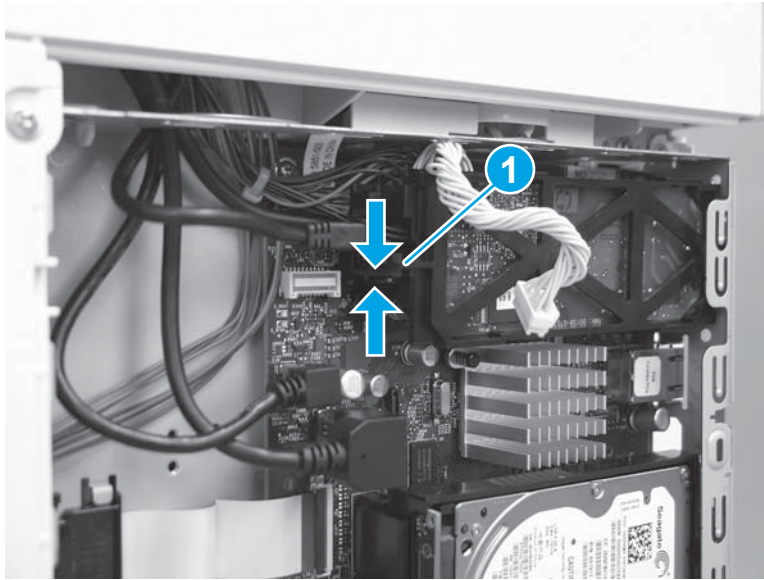

4. Rotate the end of the fax PCA (callout 1) away from the formatter, and then slide the PCA left (callout 2) to remove it.

Figure 1-3180 Remove the fax PCA

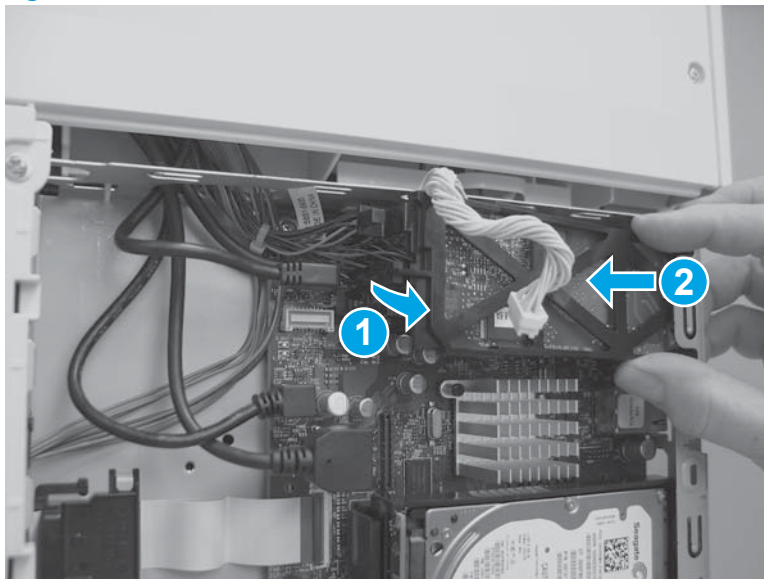

Step 10: Remove the formatter (M577)

 **NOTE:** This step is for the M577 models. For the M552 and M553 models, skip this step and go to [Step 11: Remove the rear cover \(M552 and M553\) on page 1797.](#)

 **CAUTION:**  ESD-sensitive part.

1. Disconnect all of the connectors on the formatter.

The following connectors are empty:

- All models: J1 (this connector is empty unless the optional DIMM is installed)
- All models: J3
- M577dn: J15 (this is the fax connector for the M577f/z/c models)
- All models: J21 (this connector is empty unless the optional internal USB ports component is installed)
- All models: J23
- All models: J24
- All models: J51
- All models: J57
- All models: J97
- All models: J98 (this connector is empty unless the optional trusted platform module (TPM) is installed)

 **IMPORTANT:** The flat-cable connector (callout 1) is a Zero Insertion Force (ZIF) connector that uses a hinged retainer to secure the flat cable. The hinged retainer must be opened to release the flat cable.

Figure 1-3181 Disconnect all connectors



2. Remove four screws (callout 1).

Figure 1-3182 Remove four screws

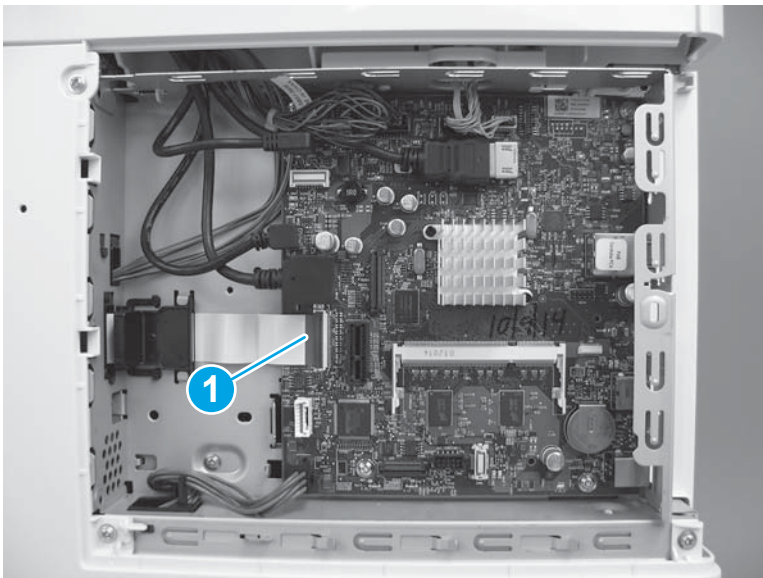
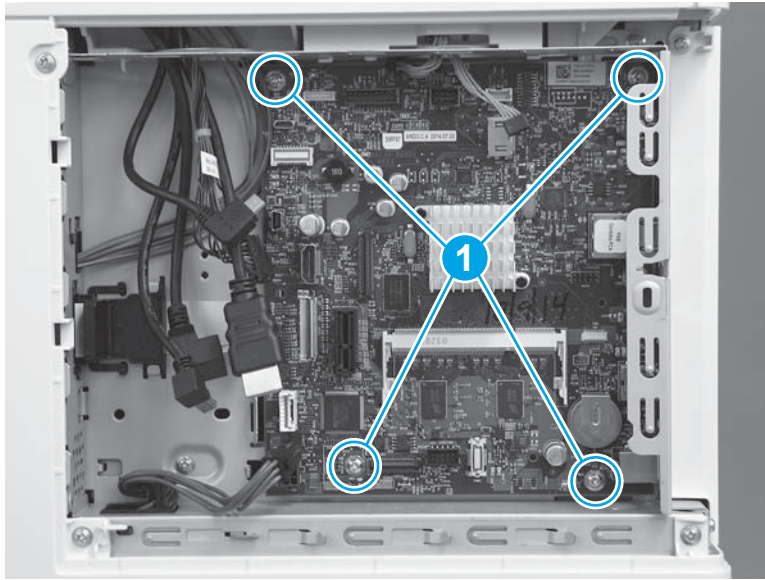

3. Remove the formatter.

Figure 1-3183 Remove the formatter

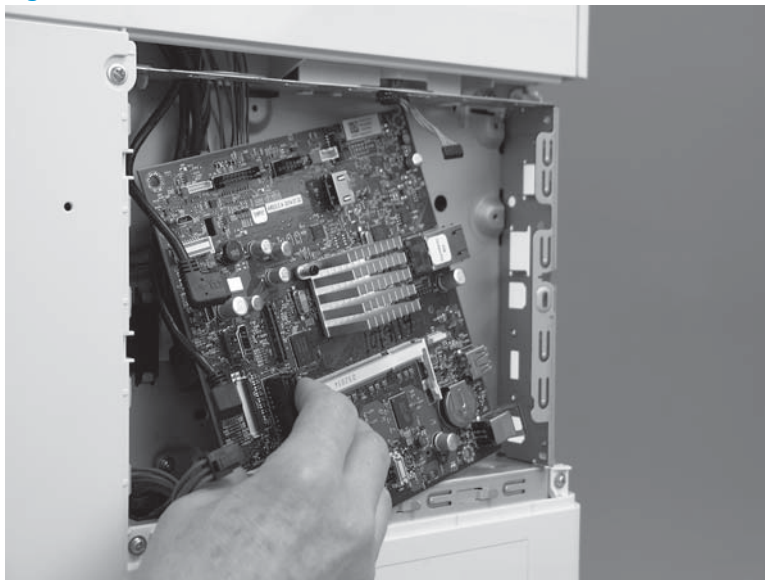

Step 11: Remove the rear cover (M552 and M553)

 **NOTE:** This step is for the M552 and M553 models. For the M577 models, skip this step and go to [Step 12: Remove the rear upper cover \(M577\) on page 1798.](#)

1. Remove four screws (callout 1).

Figure 1-3184 Remove four screws

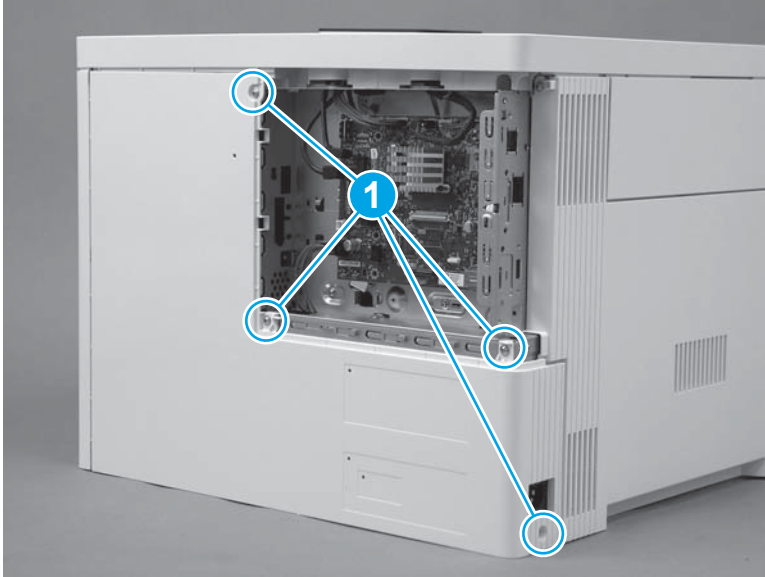

2. Slightly slide the cover to the right (callout 1), rotate the bottom of the cover away from the printer (callout 2), and then pull the top of the cover away from the printer (callout 3) to remove the cover.

Figure 1-3185 Remove the cover

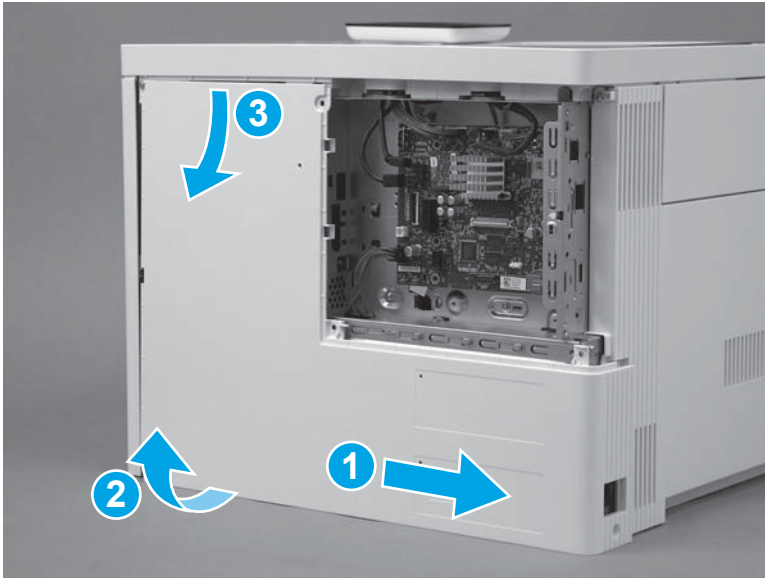

Step 12: Remove the rear upper cover (M577)



NOTE: This step is for the M577 models. For the M552 and M553 models, skip this step and go to [Step 24: Remove the left cover on page 1818](#).

1. Remove two screws (callout 1).



Reinstallation tip: These two screws are self-tapping screws for plastic. When reinstalling them, rotate the screws counterclockwise to align them with the existing thread pattern, and then carefully turn them clockwise to tighten. Do not overtighten. This will prevent stripping the threads inside the screw holes.

Figure 1-3186 Remove two screws

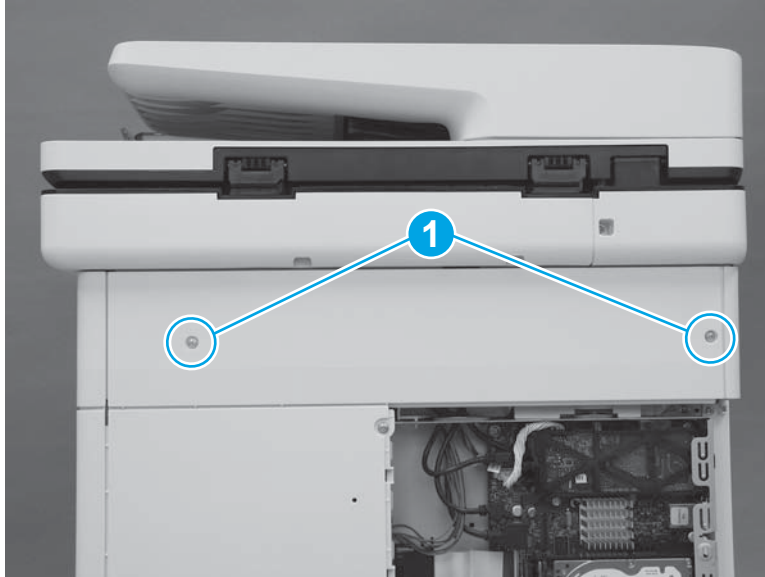

2. Use a small, flat blade screwdriver to release the right edge of the cover.

Figure 1-3187 Release the right edge

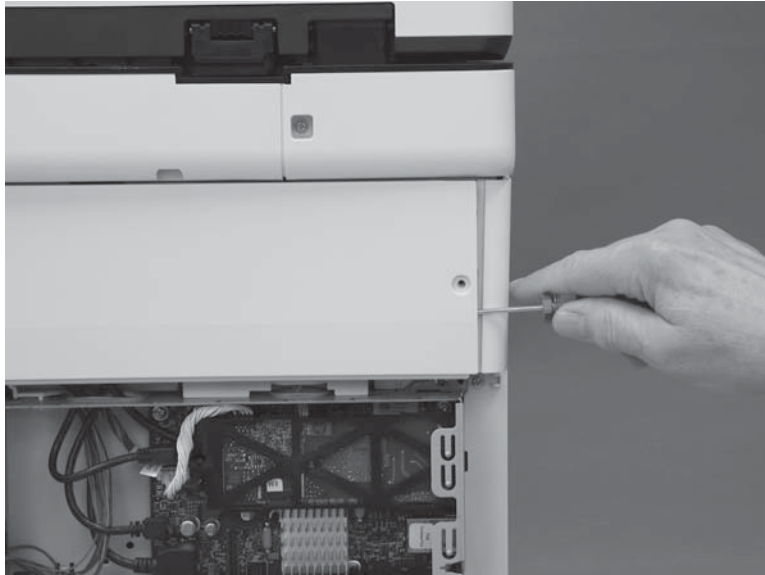

3. Pull the right edge of the cover (callout 1) away from the printer, and then slide the cover to the right (callout 2).

Figure 1-3188 Slide the cover right

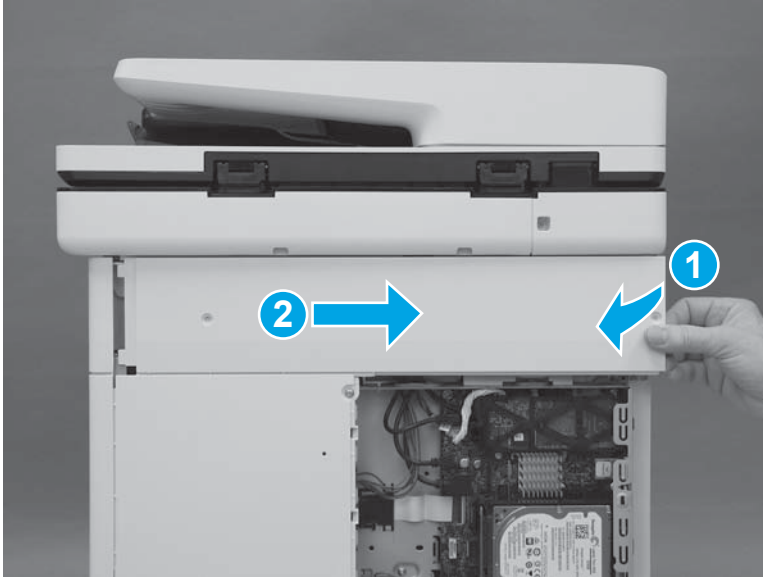

4. Remove the cover.

Figure 1-3189 Remove the cover

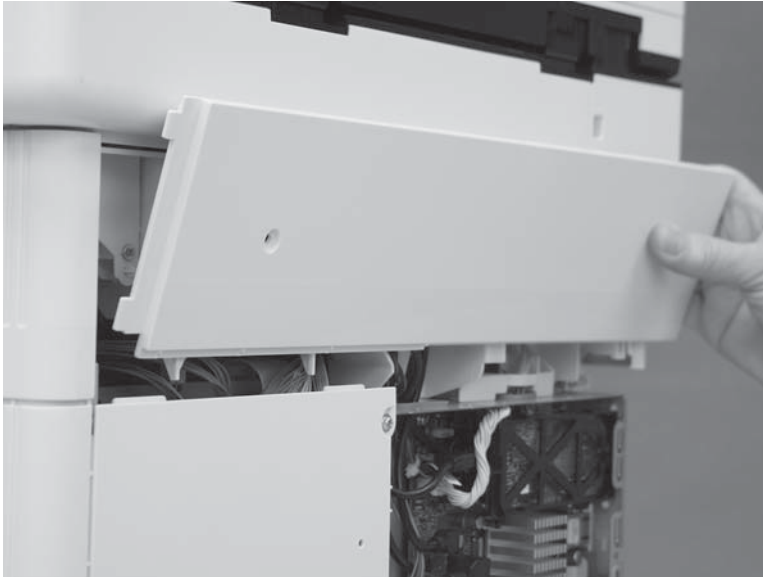

Step 13: Remove the rear cover (M577)



NOTE: This step is for the M577 models. For the M552 and M553 models, skip this step and go to [Step 24: Remove the left cover on page 1818.](#)

1. Remove four screws (callout 1).

Figure 1-3190 Remove four screws

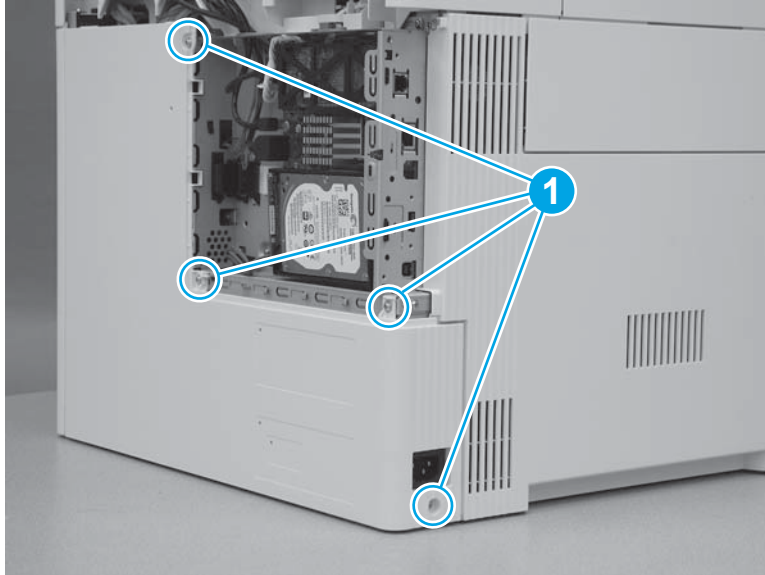

2. Slide the cover to the right to remove it.

Figure 1-3191 Remove the cover

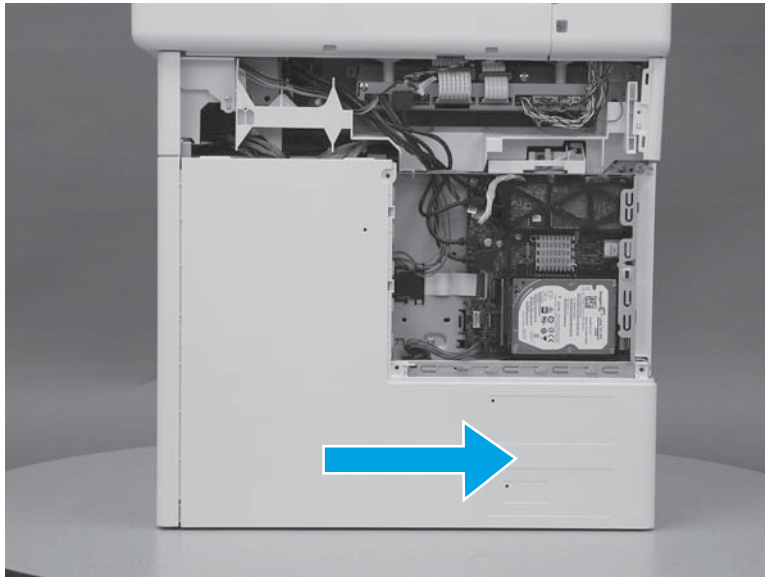

Step 14: Remove the left upper cover (M577)



NOTE: This step is for the M577 models. For the M552 and M553 models, skip this step and go to [Step 24: Remove the left cover on page 1818](#).

1. At the left side of the printer, release one tab (callout 1).

Figure 1-3192 Release one tab

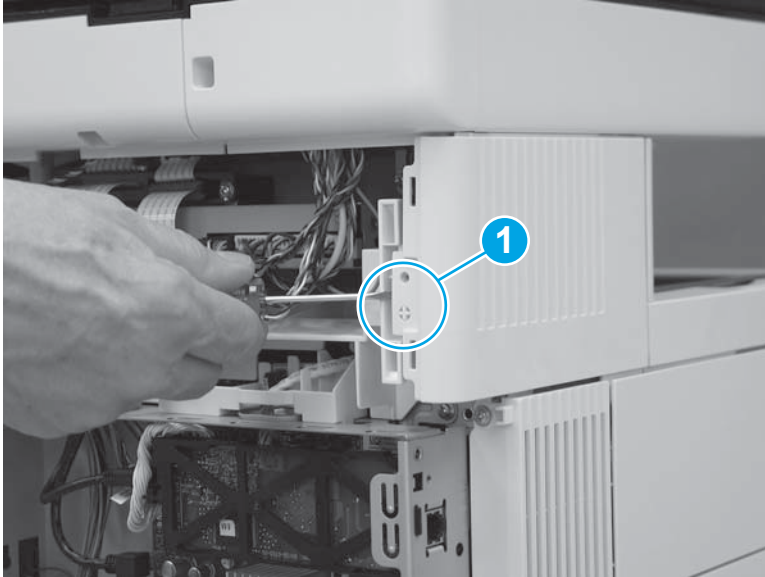

2. Slide the left upper cover toward the back of the printer.

Figure 1-3193 Slide the cover back

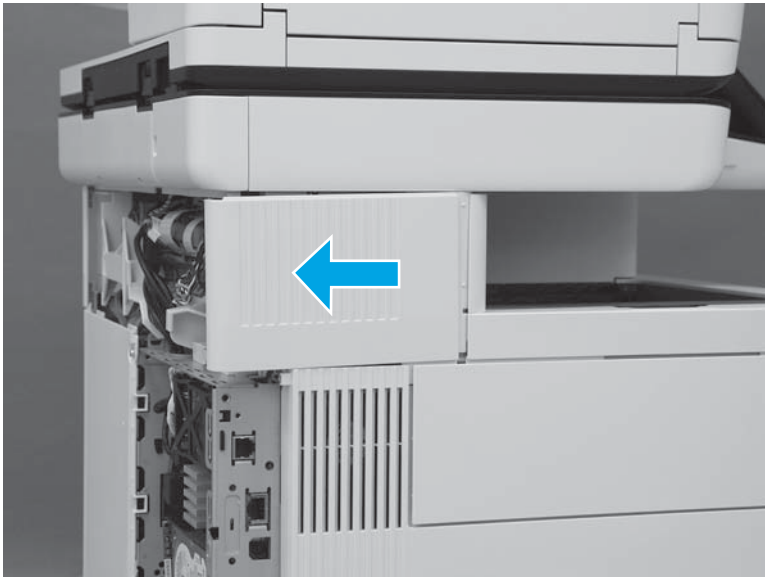

3. Rotate the cover up to remove it.

Figure 1-3194 Remove the left upper cover

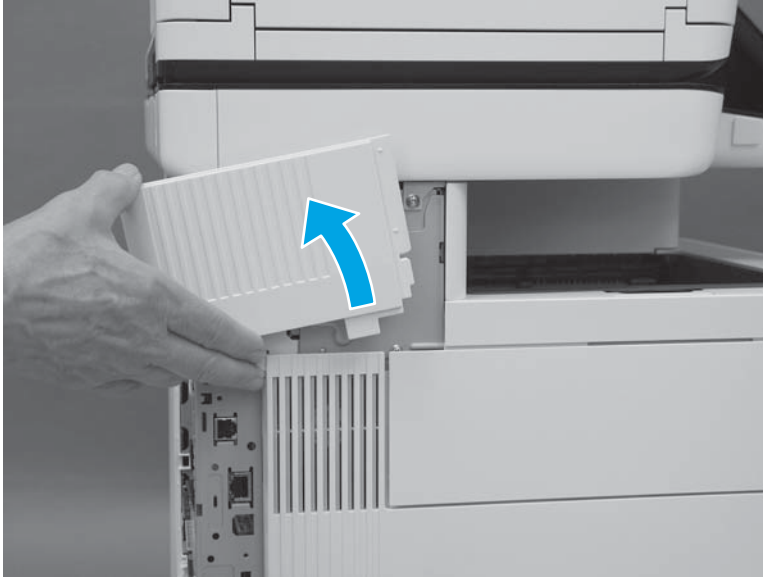

Step 15: Remove the right front upper cover (M577dn)

 **NOTE:** This step is for the M577dn model. For the M577c/f/z models, skip this step and go to [Step 16: Remove the stapler cover assembly \(M577c/f/z\) on page 1804](#).

For the M552 and M553 models, skip this step and go to [Step 24: Remove the left cover on page 1818](#).

1. Remove one screw (callout 1).

Figure 1-3195 Remove one screw

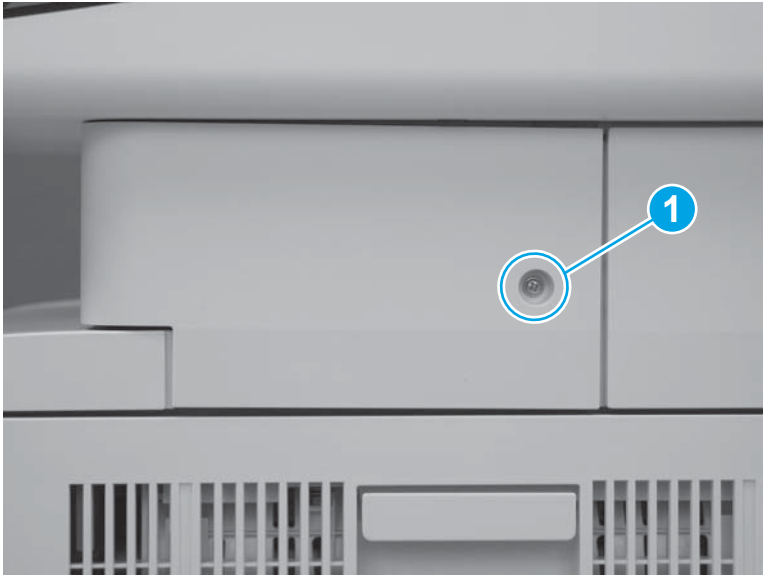

2. Release two tabs at the front edge of the cover (callout 1).

Figure 1-3196 Release two tabs



3. Rotate the front of the cover to the right to remove it.

Figure 1-3197 Rotate the cover



Step 16: Remove the stapler cover assembly (M577c/f/z)

 **NOTE:** This step is for the M577c/f/z models. For the M577dn model, skip this step and go to [Step 19: Remove the right upper cover \(M577\) on page 1810.](#)

For the M552 and M553 models, skip this step and go to [Step 24: Remove the left cover on page 1818.](#)

1. Remove one screw (callout 1).

 **Reinstallation tip:** This is a self-tapping screw for plastic. When reinstalling, rotate the screw counterclockwise to align it with the existing thread pattern, and then carefully turn it clockwise to tighten. Do not overtighten. This will prevent stripping the threads inside the screw hole.

Figure 1-3198 Remove one screw



2. Release two tabs at the front edge of the cover (callout 1).

Figure 1-3199 Release two tabs

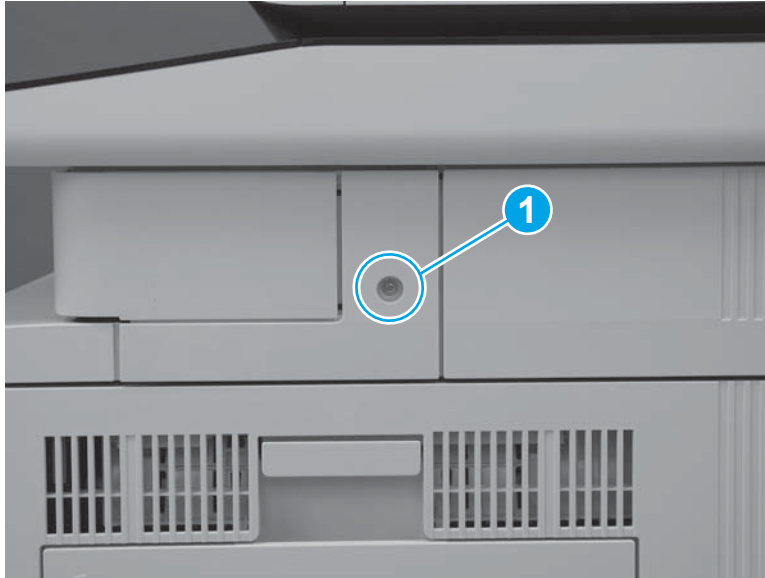

3. Release the back edge of the cover.

Figure 1-3200 Release the back edge of the cover

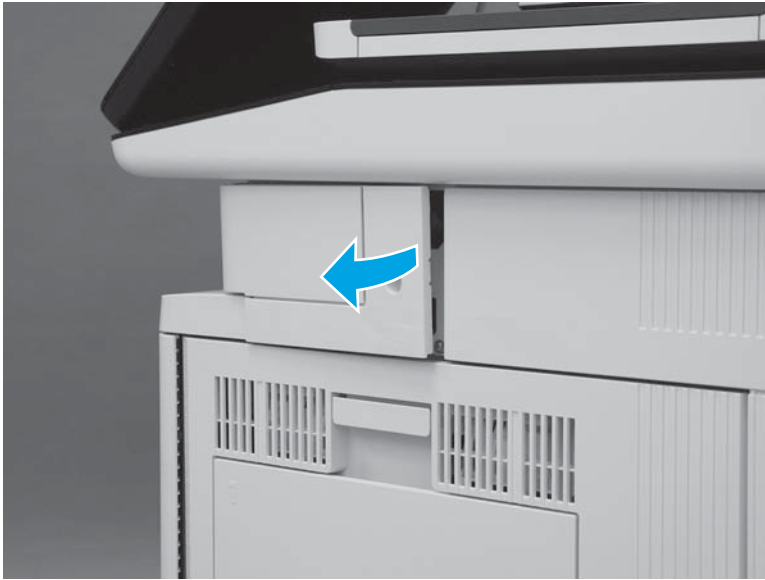



4. Rotate the cover away from the printer to remove it.

Figure 1-3201 Remove the cover



Step 17: Remove the integrated scanner assembly (ISA) (M577)

 **NOTE:** This step is for the M577 models. For the M552 and M553 models, skip this step and go to [Step 24: Remove the left cover on page 1818](#).

 **NOTE:** The ISA includes the document feeder, image scanner, scanner control board (SCB), control panel, keyboard (M577c/z) and NFC PCA (M577z).

1. At the left side of the printer, remove one screw (callout 1).

Figure 1-3202 Remove one screw

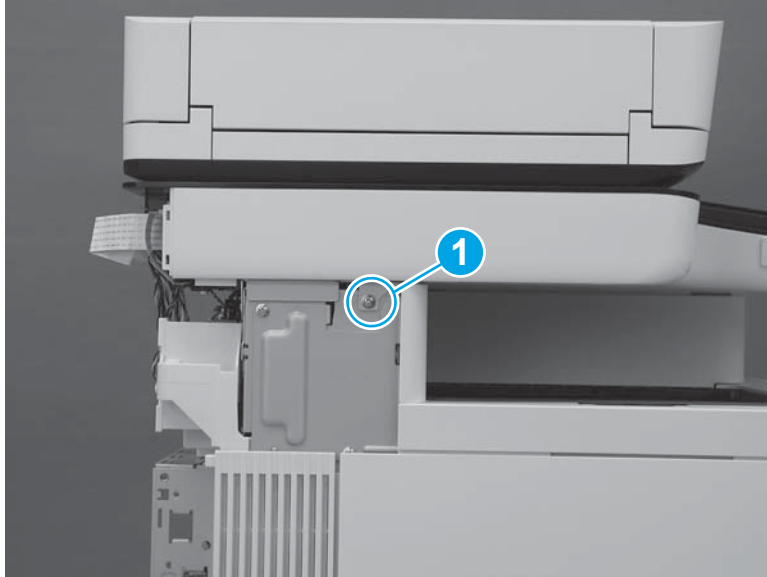

2. At the back side of the printer, remove two screws (callout 1).

Figure 1-3203 Remove two screws

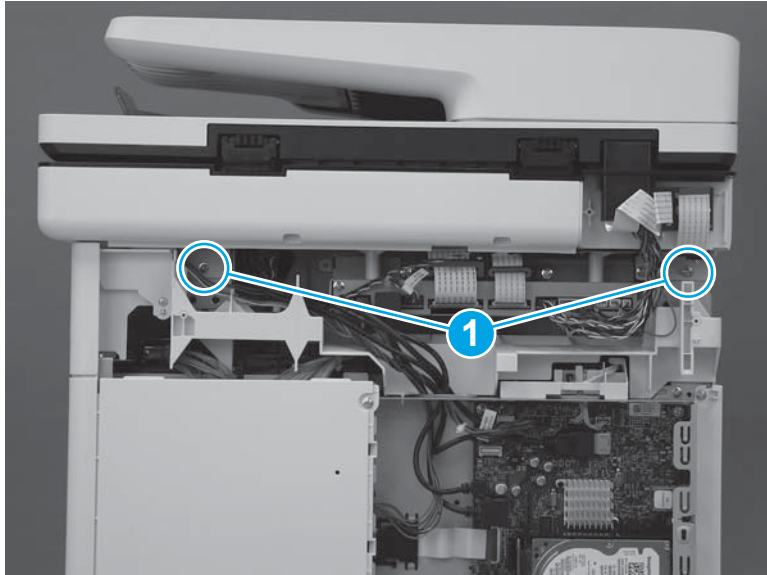

3. At the right side of the printer, remove one screw (callout 1).

Figure 1-3204 Remove one screw

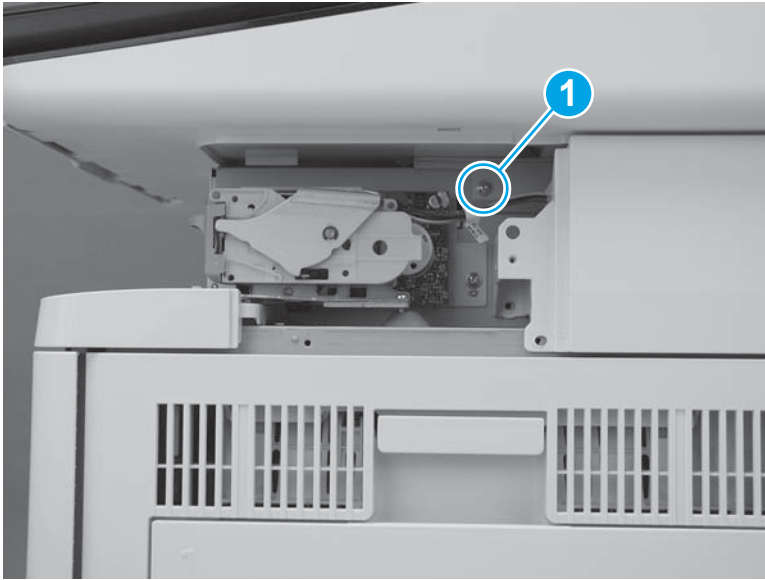

4. Disconnect two connectors on the scanner control board (callout 1).

M577c/f/z only: Disconnect one connector for the stapler on the scanner control board (callout 2).

Figure 1-3205 Disconnect connectors

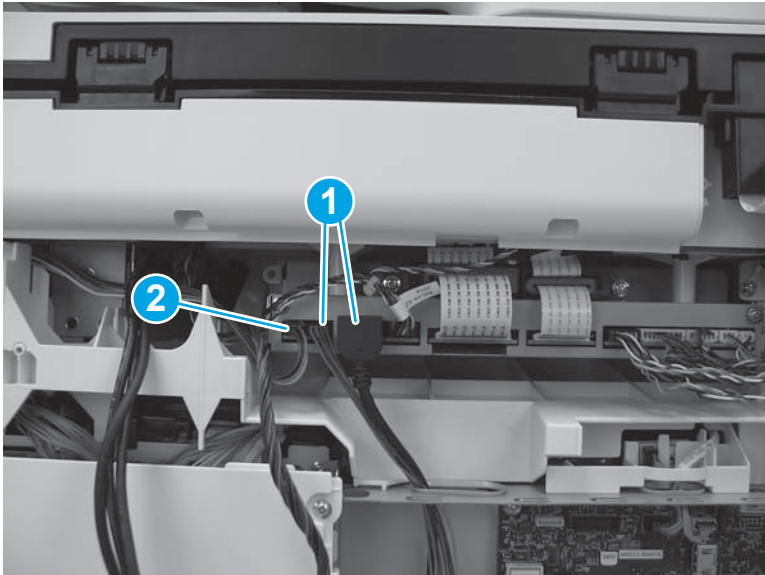

5. Slightly slide the ISA towards the back of the printer to release it.

Figure 1-3206 Slide the ISA towards the back of the printer

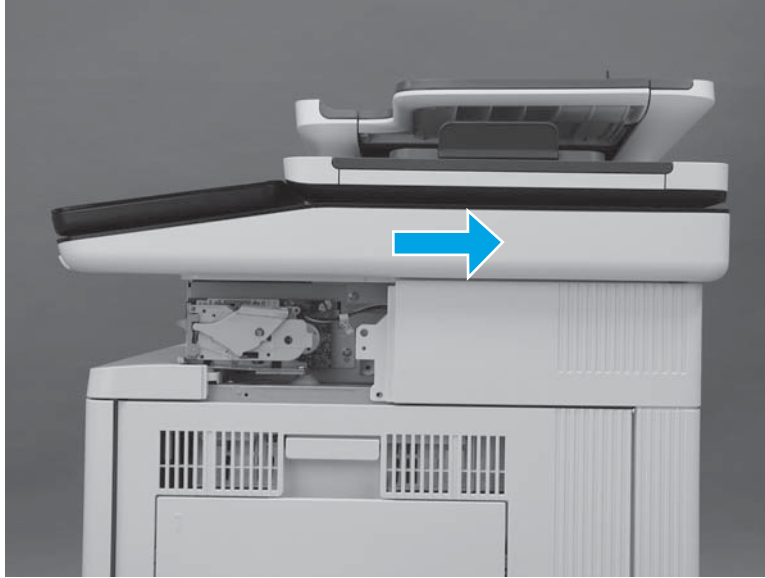

6. Lift the ISA up to remove it.



NOTE: When lifting the ISA, carefully pass the cables through the opening in the top of the formatter case.

Figure 1-3207 Remove the ISA

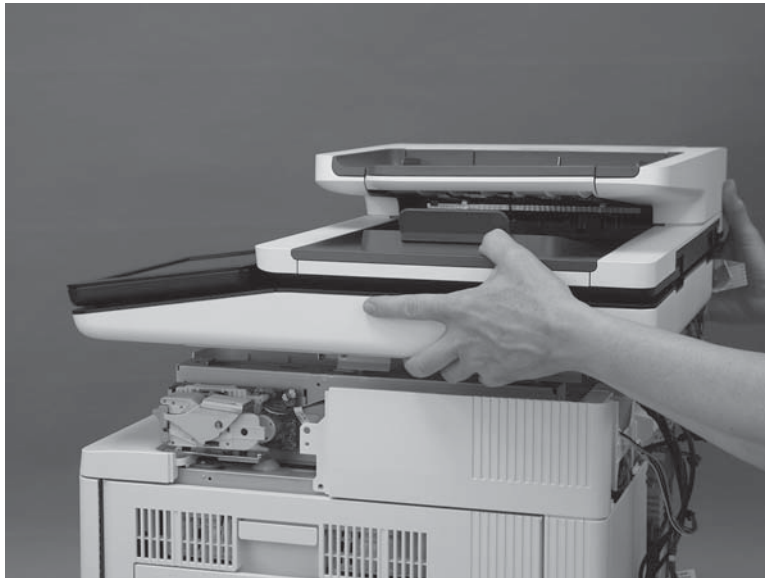

Step 18: Remove the stapler unit (M577c/f/z)



NOTE: This step is for the M577c/f/z models. For the M577dn model, skip this step and go to [Step 20: Remove the top rear cover \(M577\) on page 1812](#).

For the M552 and M553 models, skip this step and go to [Step 24: Remove the left cover on page 1818](#).

1. Disconnect one connector (callout 1), and then remove two screws (callout 2).

Figure 1-3208 Disconnect connector and remove screws

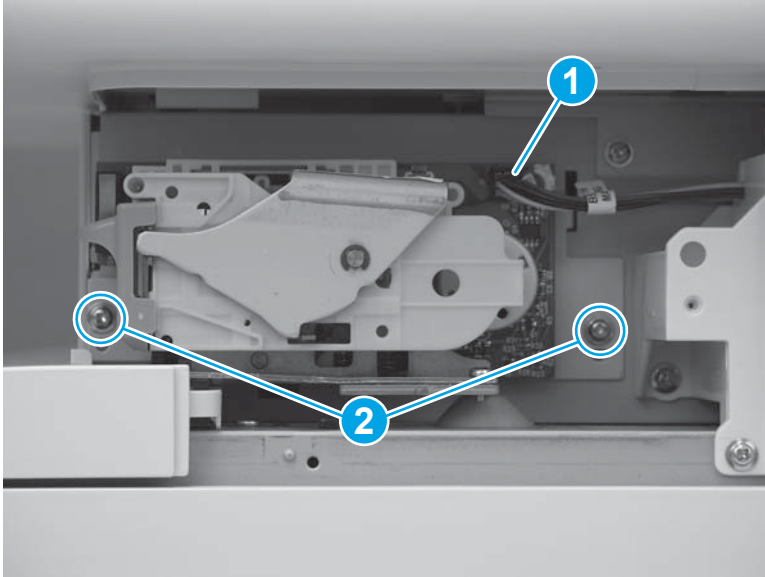

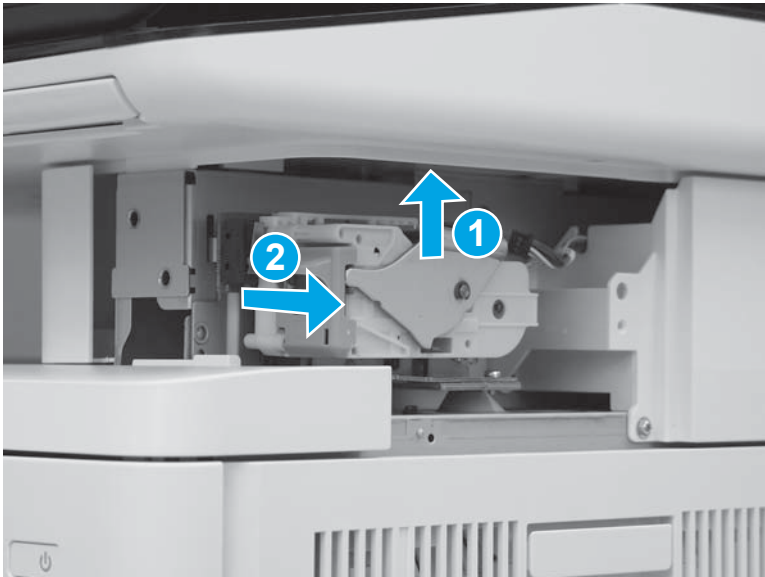

2. Slide the stapler unit up (callout 1), and then pull it away from the printer (callout 2) to remove it.

Figure 1-3209 Remove the stapler unit



Step 19: Remove the right upper cover (M577)

 **NOTE:** This step is for the M577 models. For the M552 and M553 models, skip this step and go to [Step 24: Remove the left cover on page 1818.](#)

 **NOTE:** The figures below show the image scanner installed. The procedures for removing and installing the right upper cover are the same whether the image scanner is installed or removed."

1. At the right side of the printer, remove two screws (callout 1).

M577c/f/z only: Disconnect one connector (callout 2), if it was not already disconnected in a previous step.

Figure 1-3210 Remove two screws and one connector

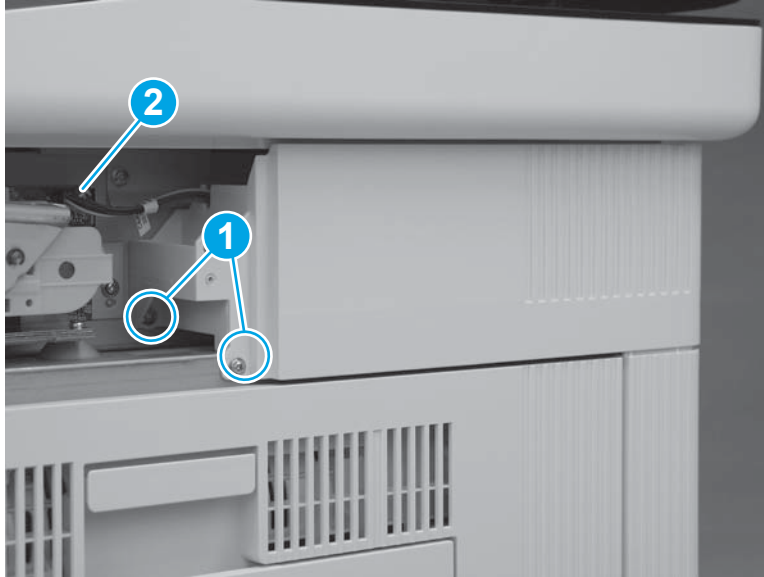

2. At the back of the printer, remove one screw (callout 1).

M577c/f/z only: Disconnect one connector (callout 2), if it was not already disconnected in a previous step.

 **Reinstallation tip:** This screw is smaller than the screws removed in the previous step. When reinstalling the right upper cover, make sure that this screw is installed in the correct position.

Figure 1-3211 Remove one screw and connector



3. Slide the cover toward the back of the printer.

Figure 1-3212 Slide the cover

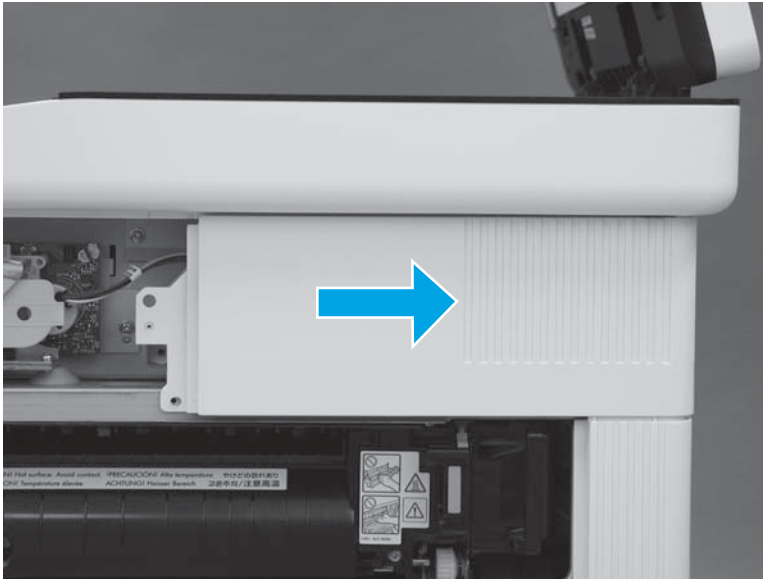

4. Lift the cover away from the printer to remove it.

M577c/f/z only: Release the cables (callout 1) through the slot (callout 2) in the printer.

Figure 1-3213 Remove the cover

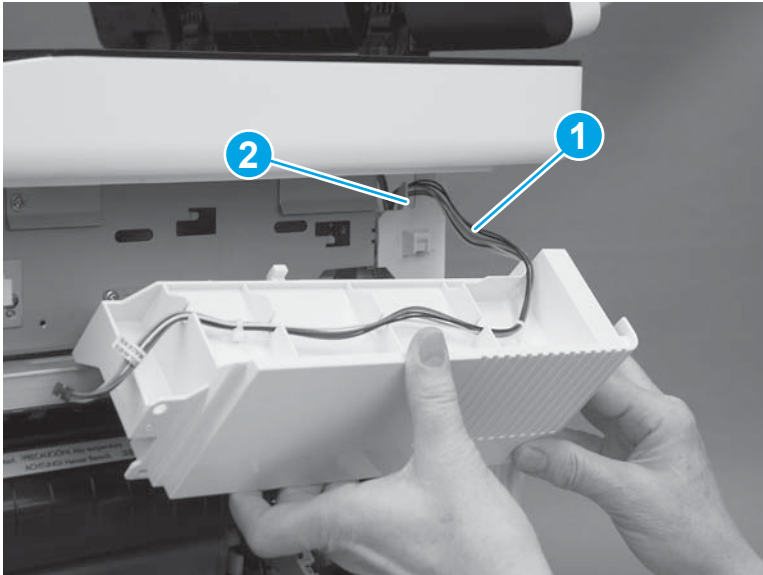

Step 20: Remove the top rear cover (M577)



NOTE: This step is for the M577 models. For the M552 and M553 models, skip this step and go to [Step 24: Remove the left cover on page 1818](#).

1. At the top of the printer, remove five screws (callout 1).

Figure 1-3214 Remove five screws

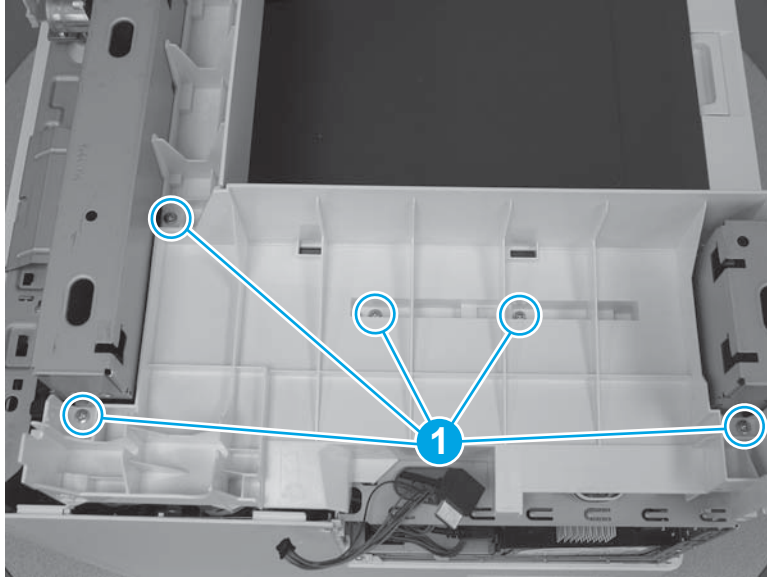

2. Release two tabs (callout 1) on the front edge of the cover.

Figure 1-3215 Release two tabs

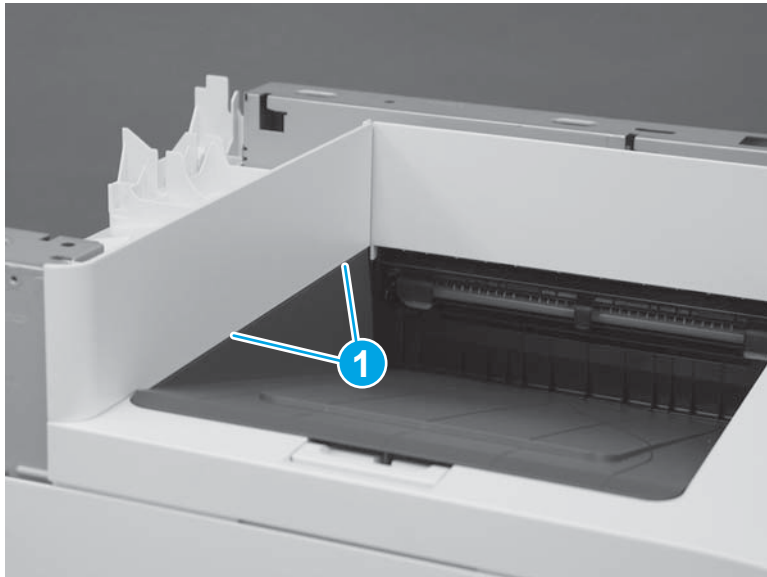

3. Remove the top rear cover.

Figure 1-3216 Remove the top rear cover

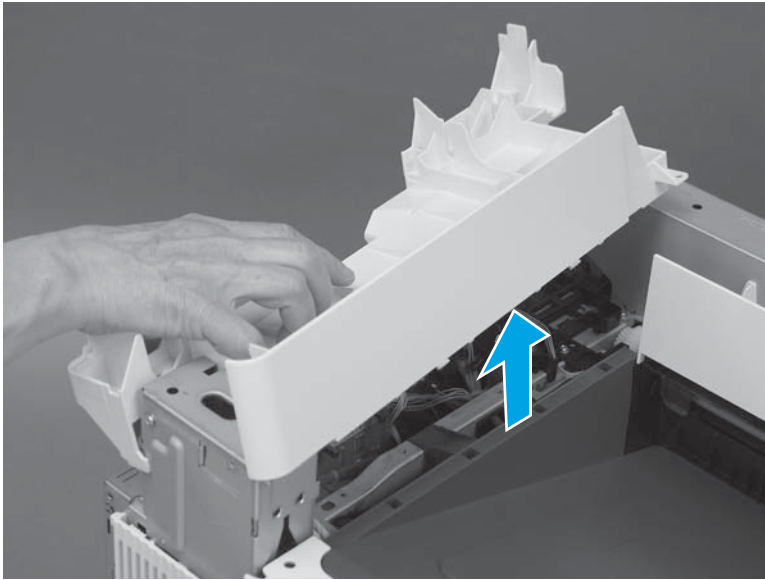

Step 21: Remove the paper feed cover (M577)



NOTE: This step is for the M577 models. For the M552 and M553 models, skip this step and go to [Step 24: Remove the left cover on page 1818](#).

1. Remove one screw (callout 1).

Figure 1-3217 Remove one screw

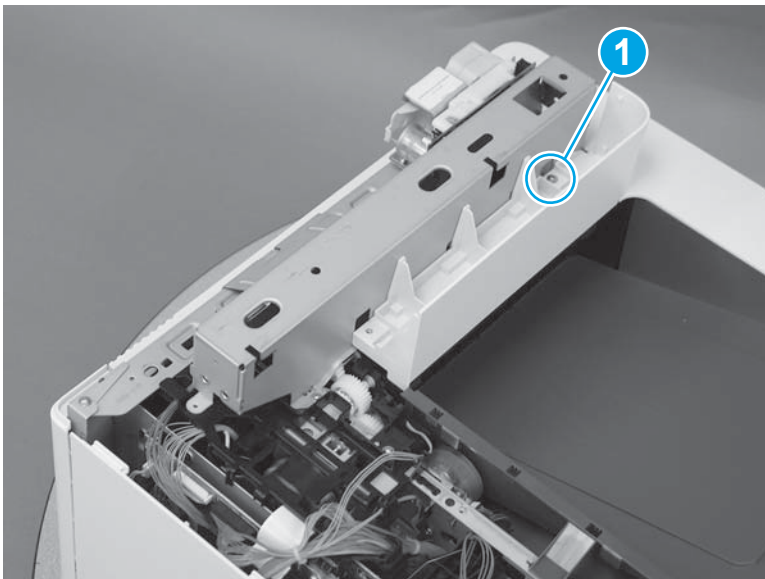

2. Lift the cover up to remove it.

Figure 1-3218 Remove the cover

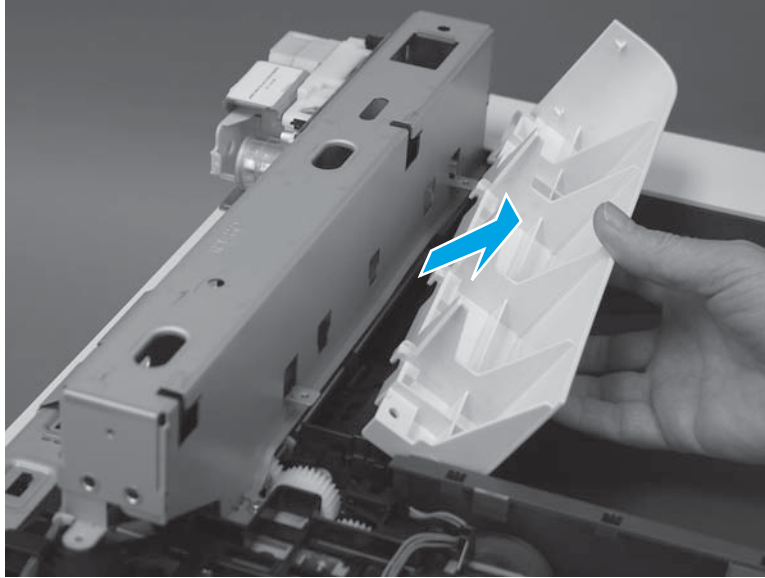

Step 22: Remove the top cover (M577)

 **NOTE:** This step is for the M577 models. For the M552 and M553 models, skip this step and go to [Step 24: Remove the left cover on page 1818](#).

1. At the front of the printer, remove one screw (callout 1).

 **Reinstallation tip:** This screw is longer and a different type of screw than the screw removed in the next step. When reinstalling the top cover, make sure that this screw is installed in the correct position.

Figure 1-3219 Remove one screw



2. At the left side of the printer, remove one screw (callout 1).

Figure 1-3220 Remove one screw

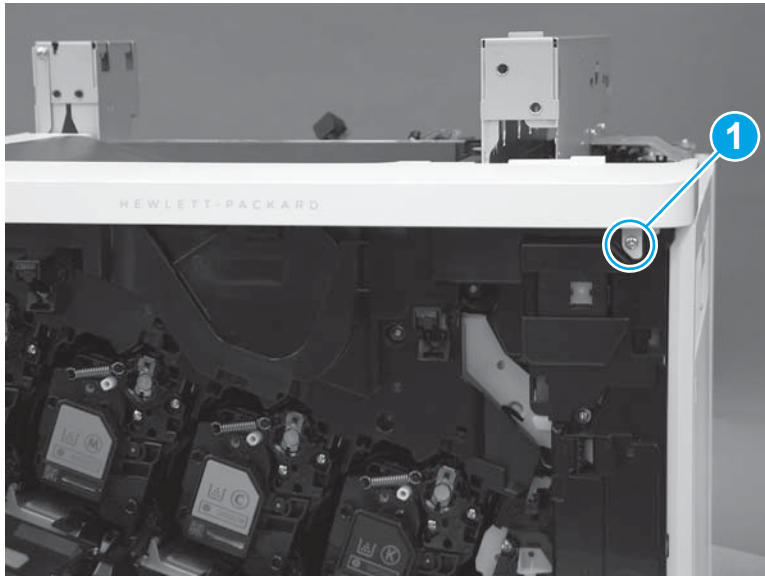
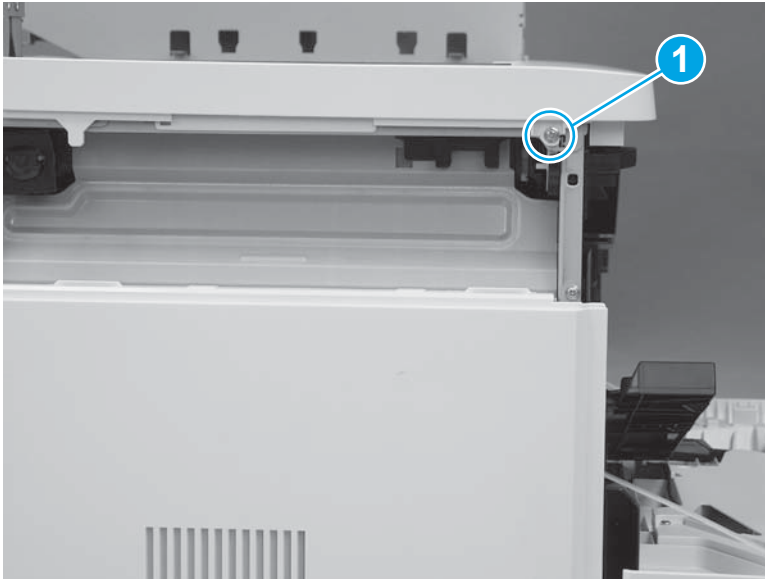

3. At the front of the printer, release one tab (callout 1).

Figure 1-3221 Release one tab

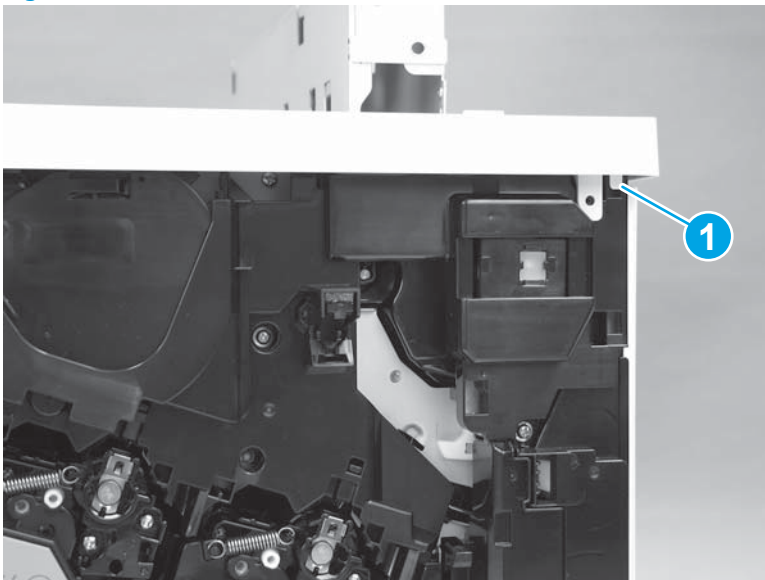

4. At the top of the printer, release two tabs (callout 1) next to the output bin, and then remove the top cover.

Figure 1-3222 Release two tabs

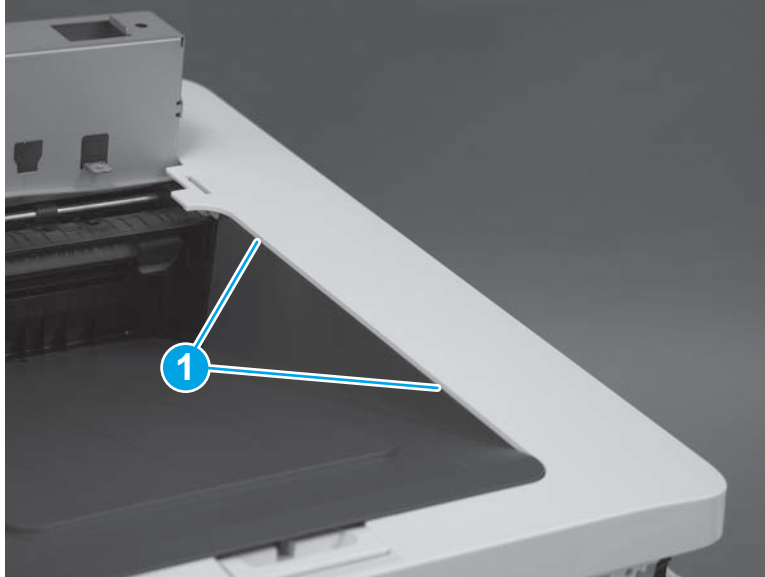

Step 23: Remove the top bracket (M577)

 **NOTE:** This step is for the M577 models. For the M552 and M553 models, skip this step and go to [Step 24: Remove the left cover on page 1818](#).

1. At the top of the printer, remove three screws (callout 1).

Figure 1-3223 Remove three screws

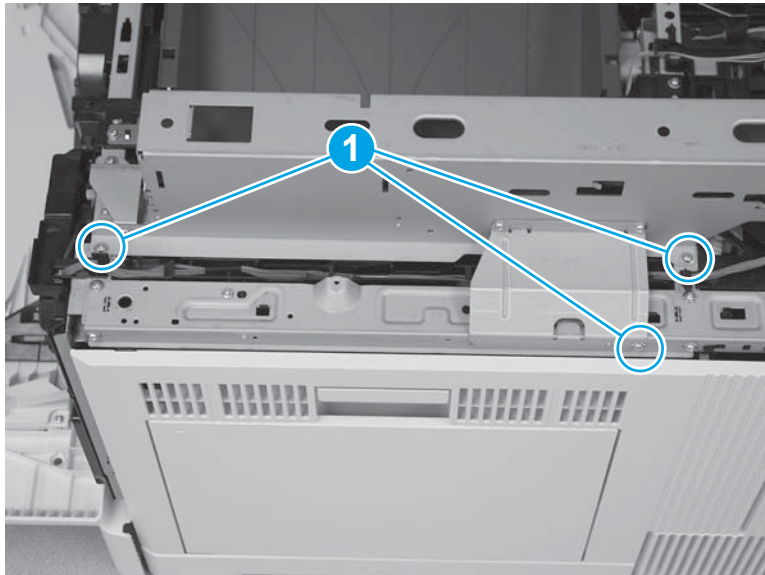

2. At the top of the printer, remove two screws (callout 1).

Figure 1-3224 Remove two screws

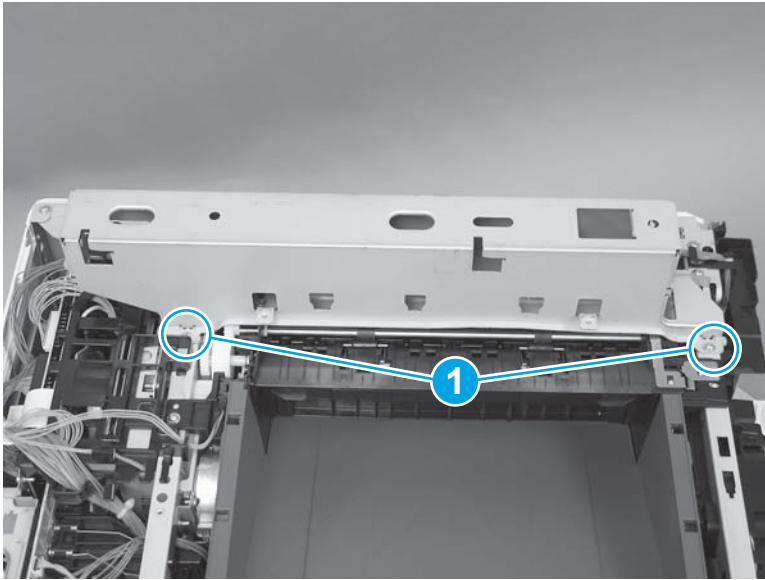

3. Lift the top bracket up to remove it.

Figure 1-3225 Remove the bracket

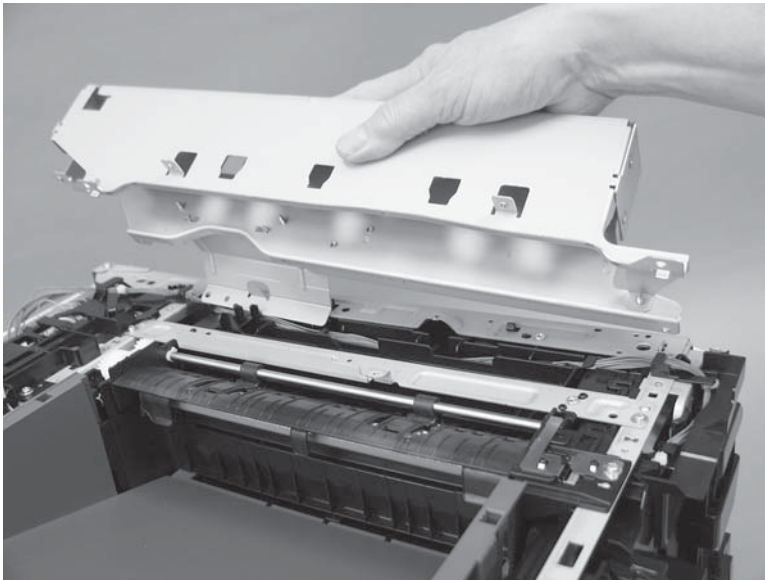

Step 24: Remove the left cover

1. At the left side of the printer, remove one screw (callout 1).

Figure 1-3226 Remove one screw



2. Release one tab (callout 1), rotate the front edge of the cover away from the printer (callout 2), and then slide the cover (callout 3) toward the rear of the printer to release it.

Figure 1-3227 Release the cover

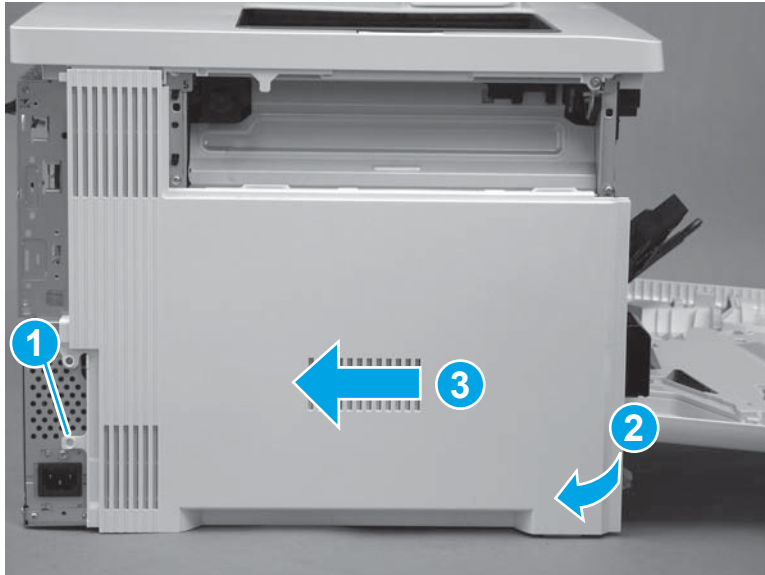

3. Remove the cover.

Figure 1-3228 Remove the cover

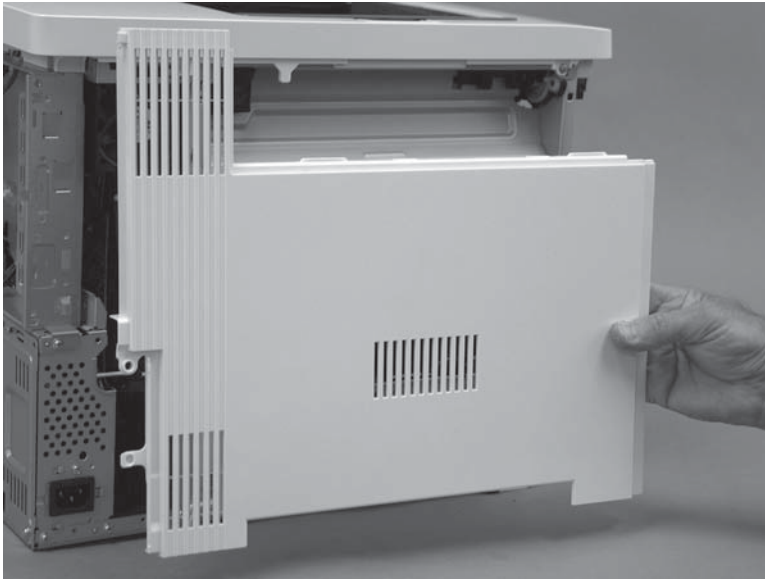

Step 25: Remove the upper cover (M552 and M553)



NOTE: This step is for the M552 and M553 models. For the M577 models, skip this step and go to [Step 26: Remove the formatter case on page 1822](#).

1. Remove three screws (callout 1).

Figure 1-3229 Remove three screws

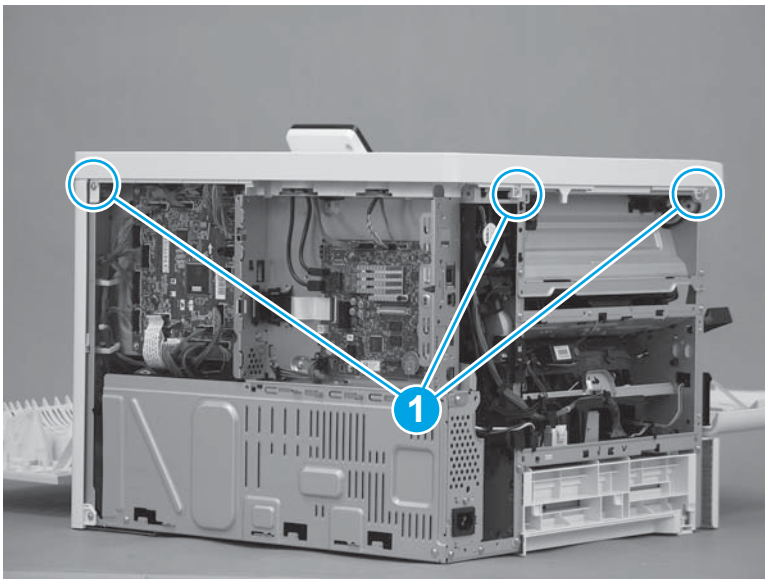

2. Remove one screw (callout 1), release one tab (callout 2), and then slightly separate the corner of the cover from the chassis.

 **NOTE:** This is a self-tapping plastic-thread screw. Make sure that this screw is used in this location when it is reinstalled.

Figure 1-3230 Remove one screw and release one tab



3. Release one tab (callout 1), and then lift up on the cover to release it.

 **NOTE:** If the cover does not release, check for additional tabs by locating the triangles embossed in the cover at tab locations.

Figure 1-3231 Release the cover



4. Remove the cover.

Figure 1-3232 Remove the cover

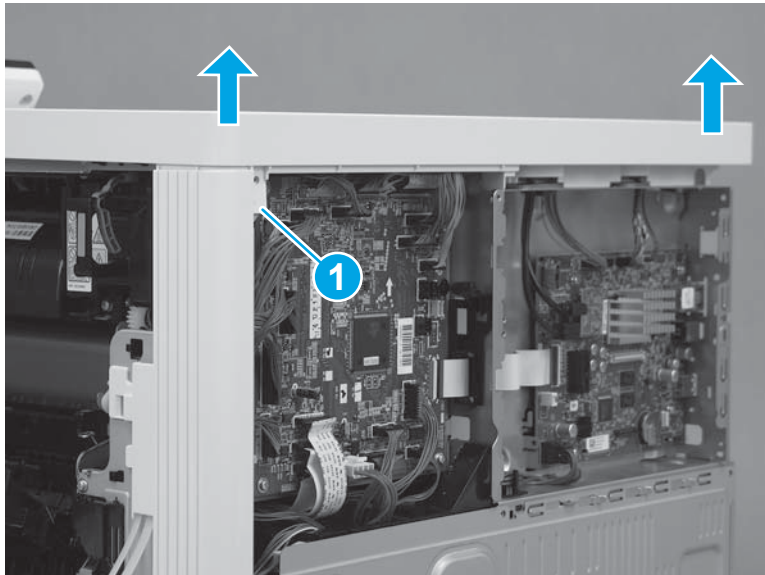
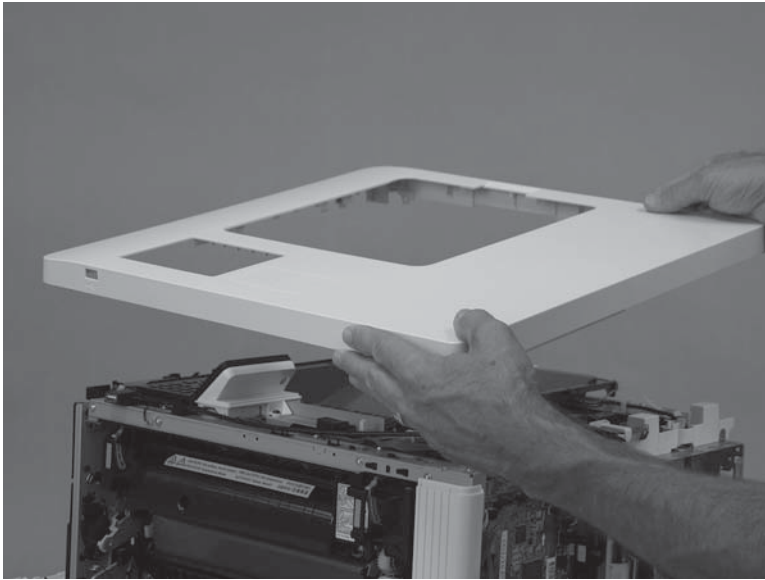

Step 26: Remove the formatter case

1. **M577 only:** Disconnect one connector (callout 1), and then pass the wire harness (callout 2) through two openings in the formatter case (callout 3).

Figure 1-3233 Disconnect one connector

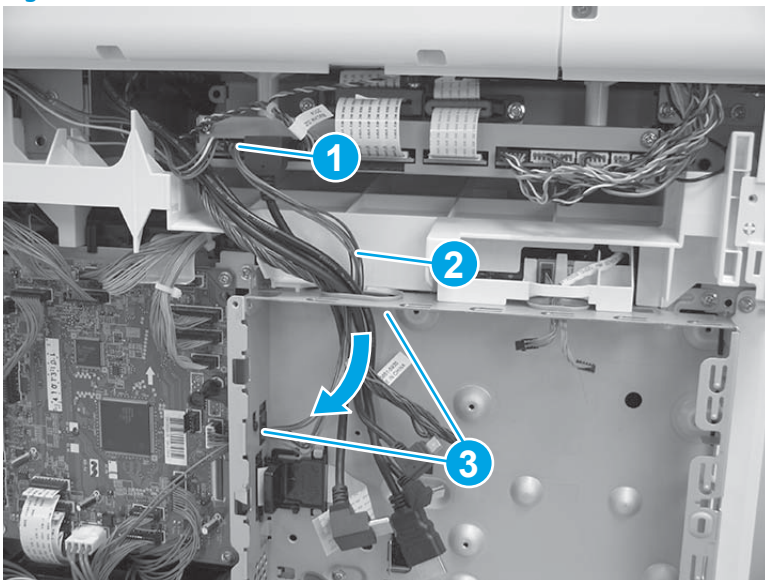

2. Release two tabs (callout 1) on the black plastic bracket. Hold the tabs in the released position, and then slide the bracket (callout 2) to the right to remove it from the formatter case.

Figure 1-3234 Remove the bracket

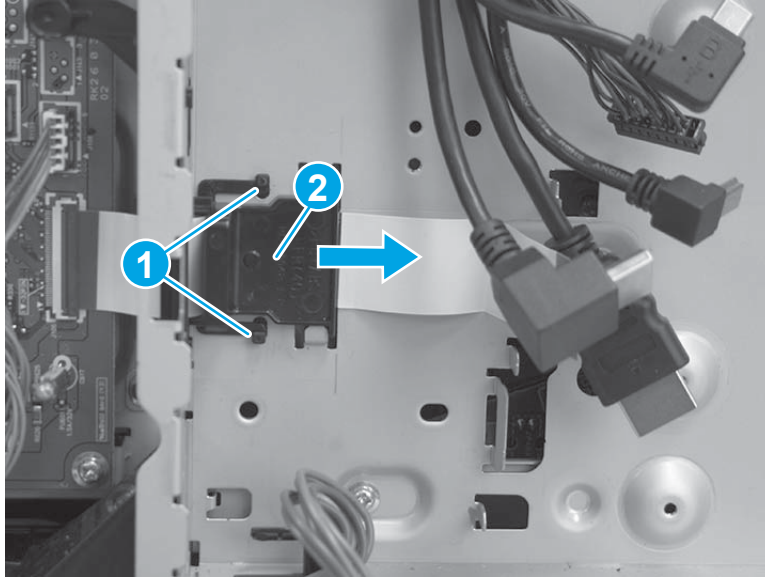

3. Remove two screws (callout 1), and then slide the low-voltage power supply (LVPS) cover to the right to remove it.

Figure 1-3235 Remove the LVPS cover

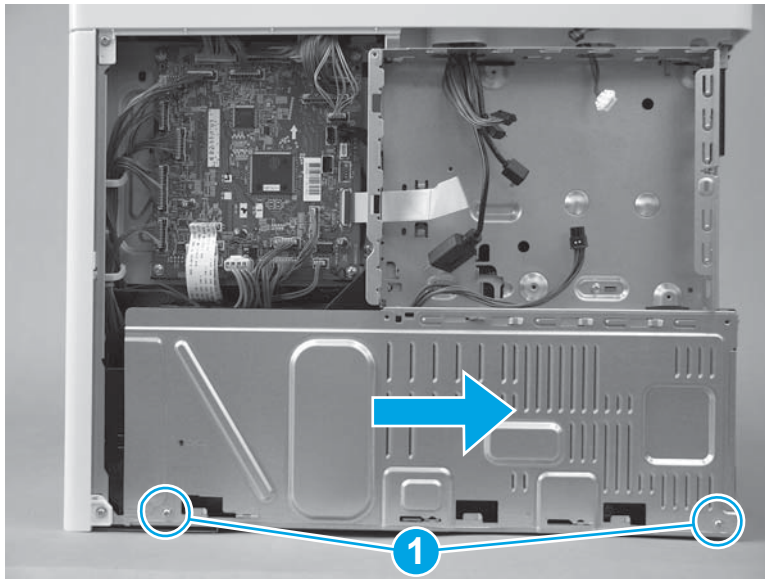

4. Pass two wire harnesses and one flat cable (callout 1) through the opening in the formatter case, and then release one wire harness from the retainer (callout 2).

⚠ CAUTION: The flat cable might be attached to the formatter case with double-sided tape. Make sure that this tape is released, so that the flat cable is not damaged when the formatter case is removed.

Figure 1-3236 Release wire harnesses and flat cable

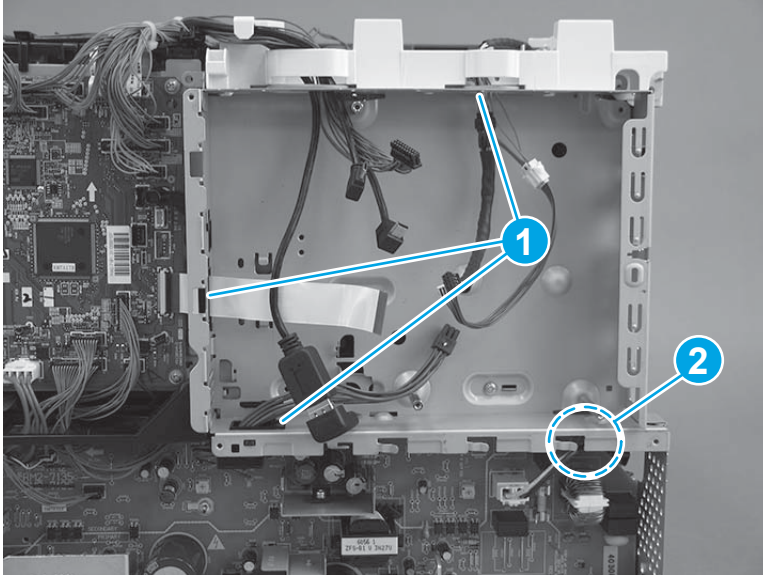

5. Remove six screws (callout 1).

Figure 1-3237 Remove six screws

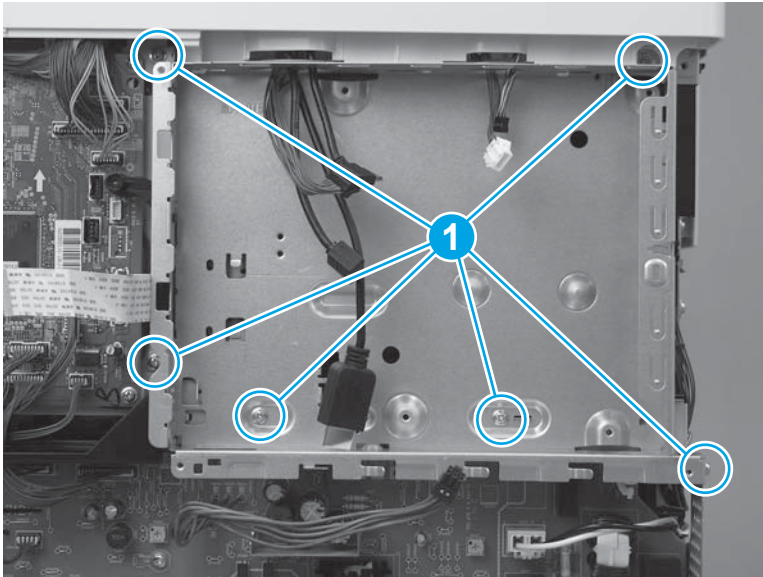

6. Rotate the bottom of the formatter case away from the printer (callout 1), and then pull it down (callout 2) to release it.

Figure 1-3238 Release the formatter case

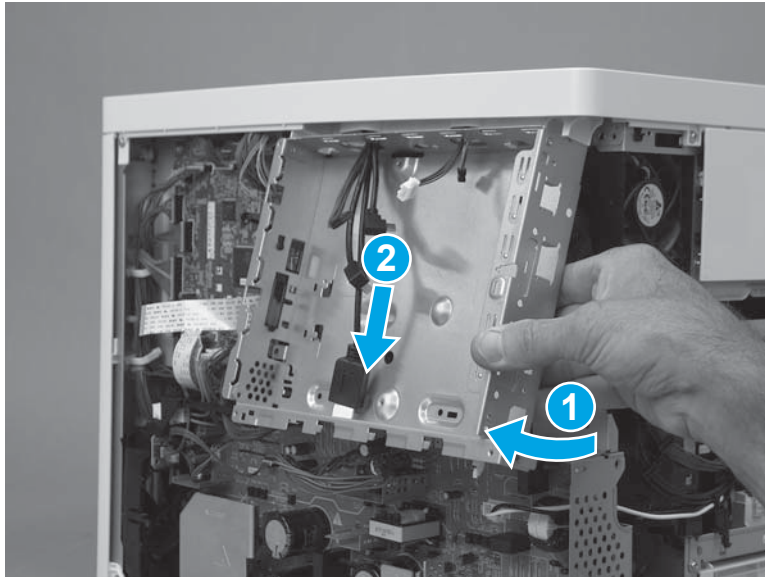

7. Pass the wire harnesses through the opening in the formatter case to remove it.

 **IMPORTANT:** If the formatter case is removed so that it can be replaced, make sure to transfer the memory PCA (island of data) and plastic bracket (callout 1) to the replacement case.

Figure 1-3239 Remove the formatter case



Step 27: Remove the right rear cover

1. Remove one screw (callout 1), and then slide the cover toward the rear of the printer (callout 2) to release it.

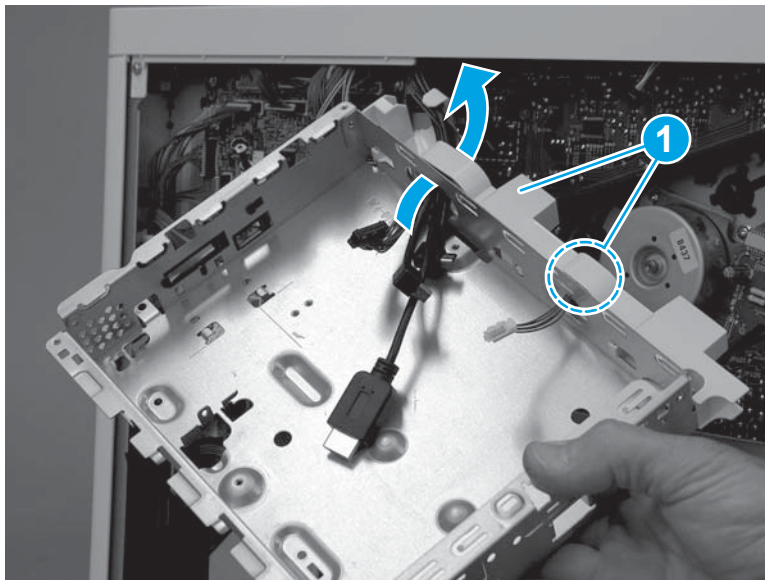
 **TIP:** If the right door is closed, open it now.

Figure 1-3240 Release the cover

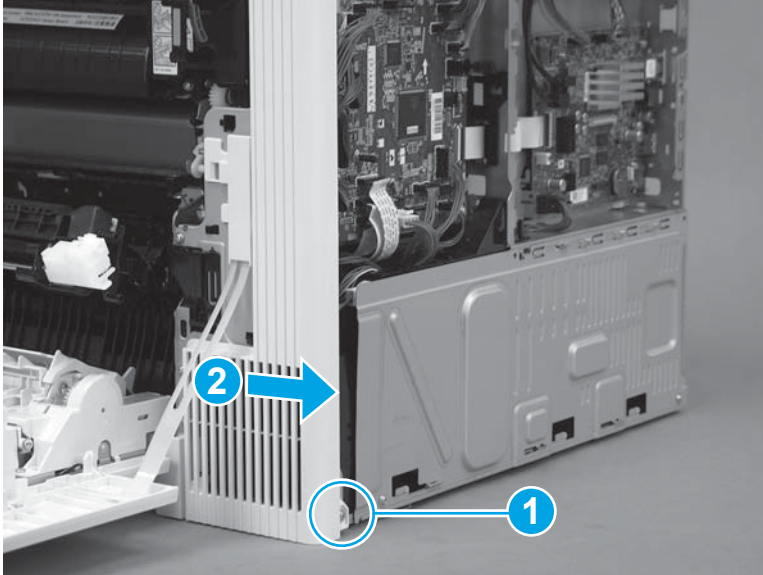

2. Remove the cover.

Figure 1-3241 Remove the cover

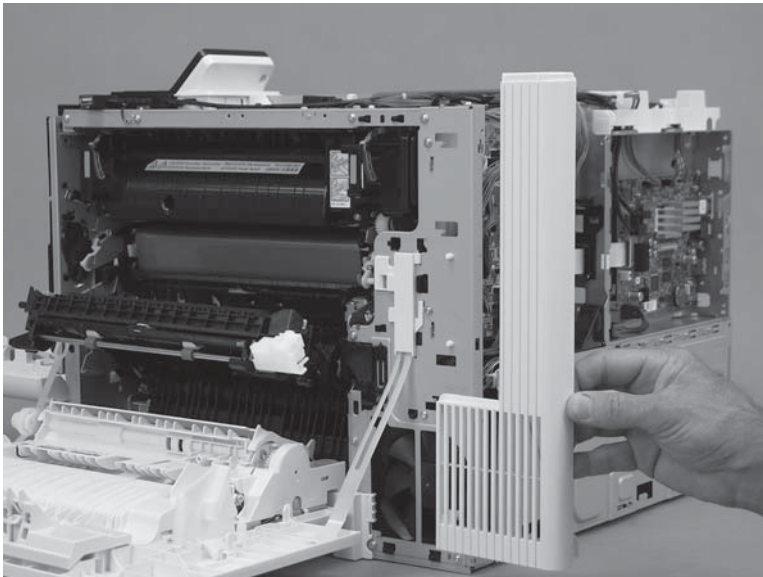

Step 28: Remove the DC controller and sheet-metal bracket

 **CAUTION:**  ESD sensitive part.

1. Disconnect all of the connectors, and then remove two screws (callout 1).

The following connectors are empty:

- J140, J141, and J143

Figure 1-3242 Remove two screws

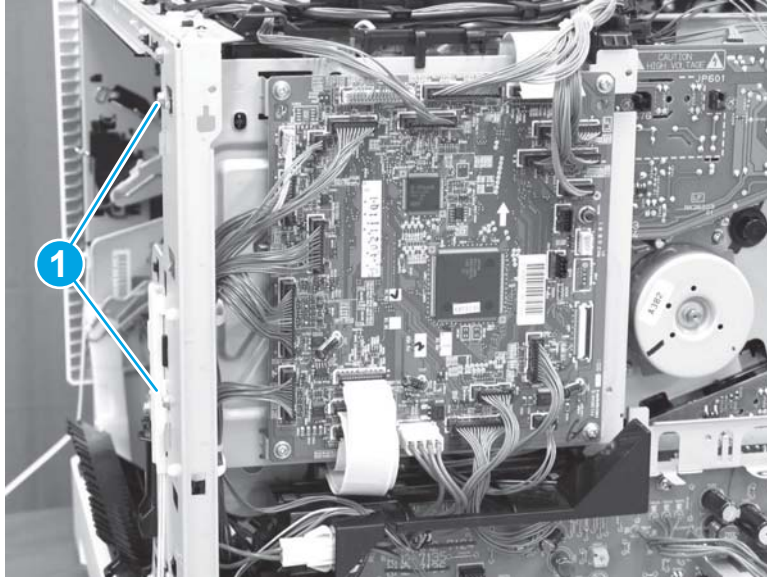

2. Lift up on the DC controller and sheet-metal plate to remove it.

Figure 1-3243 Remove the plate

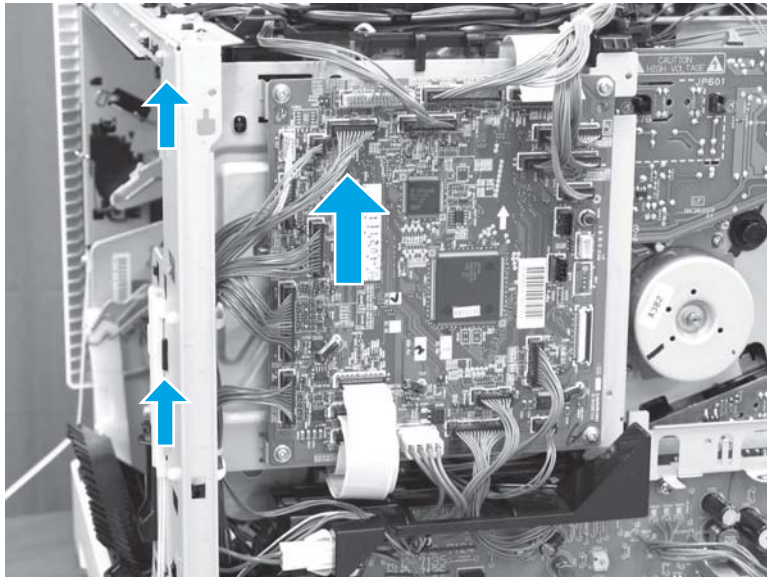

Step 29: Remove the high-voltage power supply T (HVPST)

CAUTION:  ESD-sensitive part.

1. Disconnect five connectors (callout 1), and then disconnect one flat cable (callout 2).

Figure 1-3244 Disconnect five connectors and one flat cable

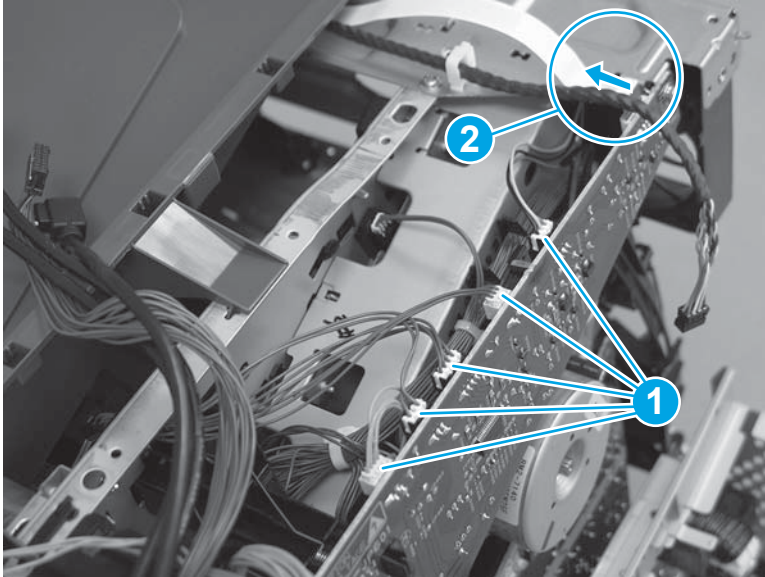

2. Remove one screw (callout 1).

Figure 1-3245 Remove one screw

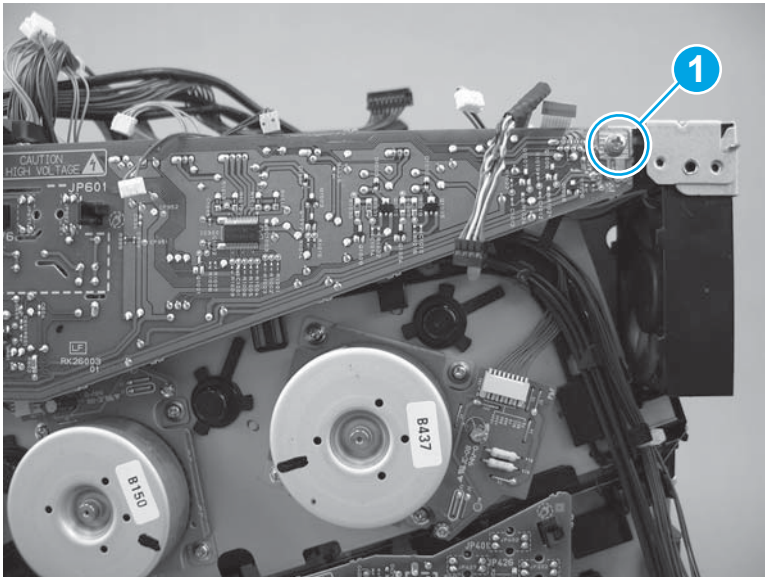

3. Release two tabs (callout 1), and then separate the HVPST from the printer.

CAUTION: Do not attempt to completely remove the HVPST. It is still connected to the printer by ground wire harness.

Figure 1-3246 Release the HVPST

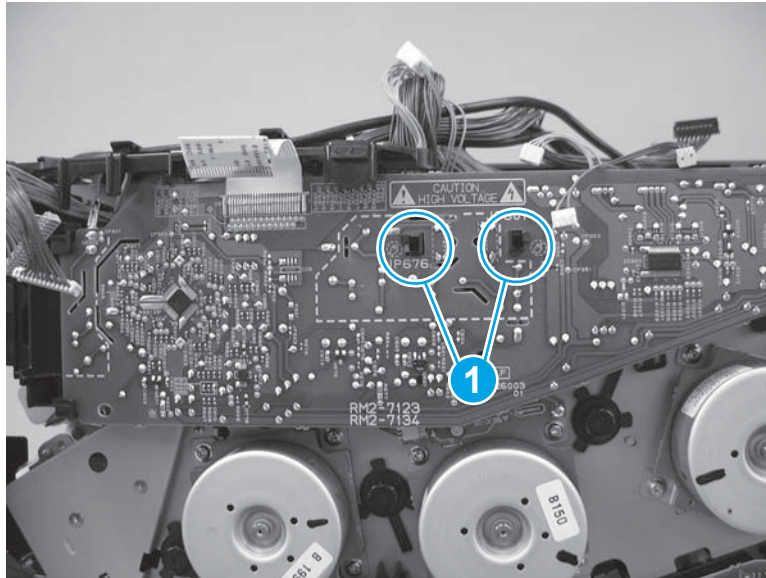

4. Release one ground wire connector (callout 1), and then remove the HVPST.

Figure 1-3247 Remove the HVPST

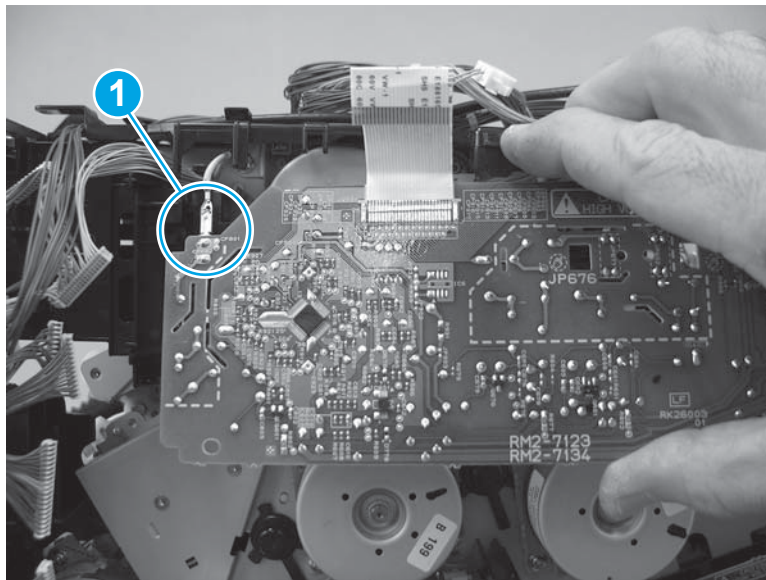

Step 30: Remove the fuser drive assembly

1. Release one tab (callout 1), slide the guide to release it (callout 2), and then rotate the guide up and away from the chassis to move it out of the way (callout 3).

CAUTION: One wire harnesses in the guide is still attached to the fuser motor. Do not attempt to completely remove the guide.

Figure 1-3248 Move the guide out of the way

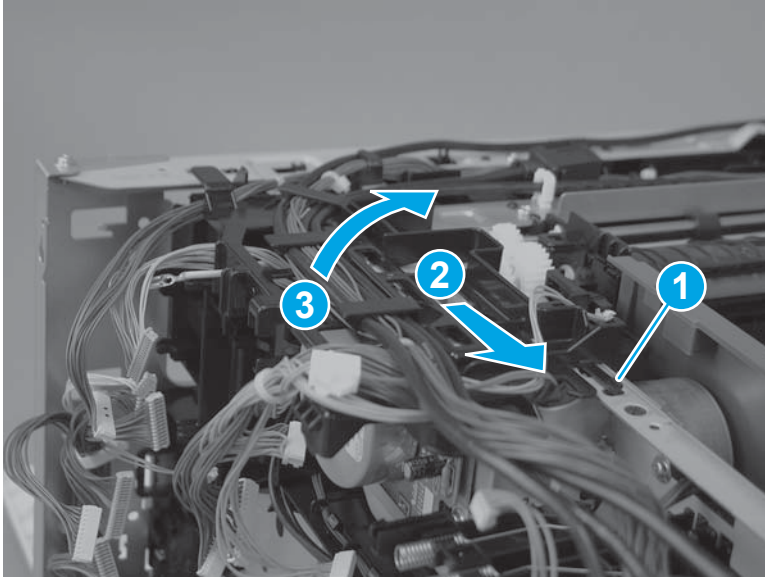

2. Disconnect one connector (callout 1).

Figure 1-3249 Disconnect one connector

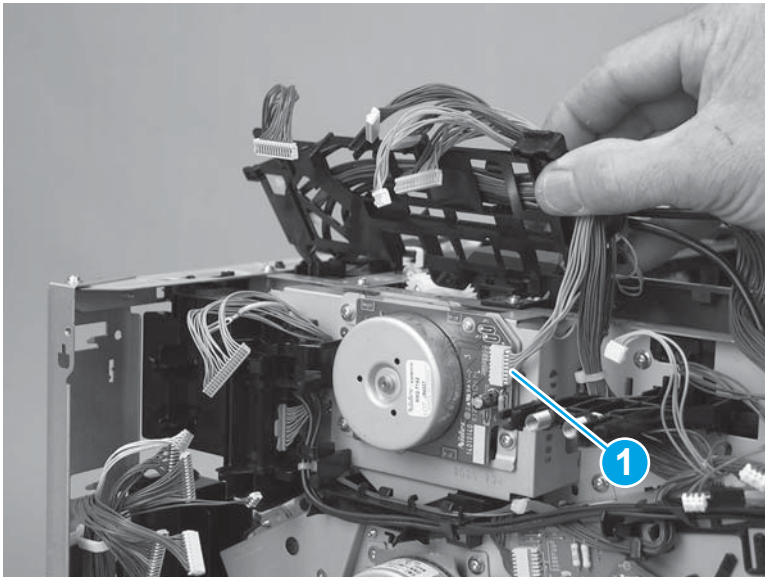

3. Remove one screw (callout 1).

Figure 1-3250 Remove one screw

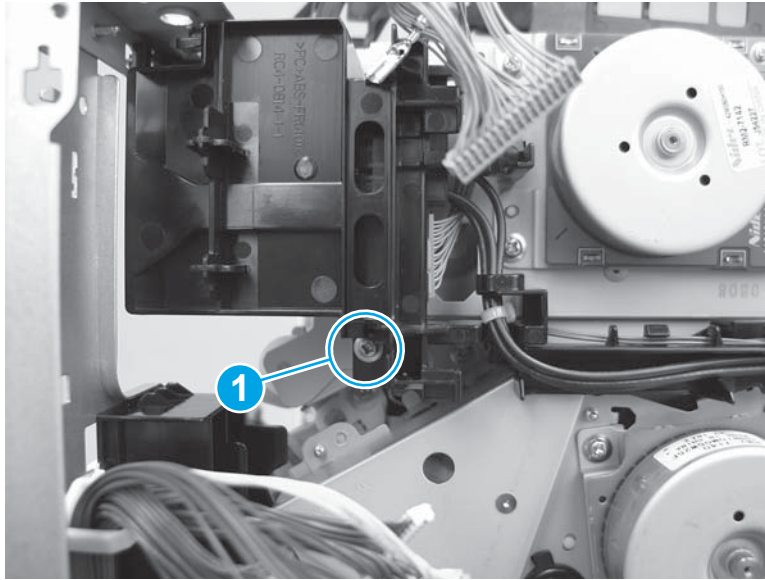

4. Release one tab (callout 1), slide the guide down to release it (callout 2), and then rotate the guide away from the chassis to remove it (callout 3).

Figure 1-3251 Remove the guide

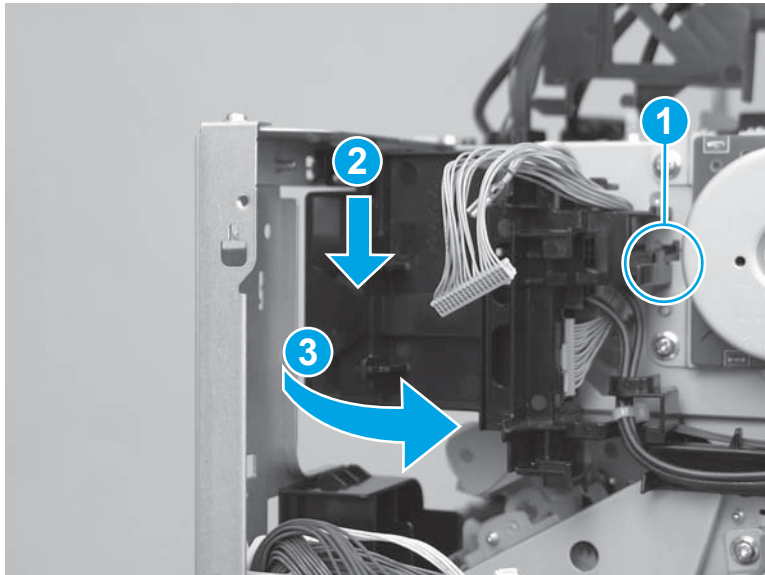

5. Remove three screws (callout 1).

Figure 1-3252 Remove three screws

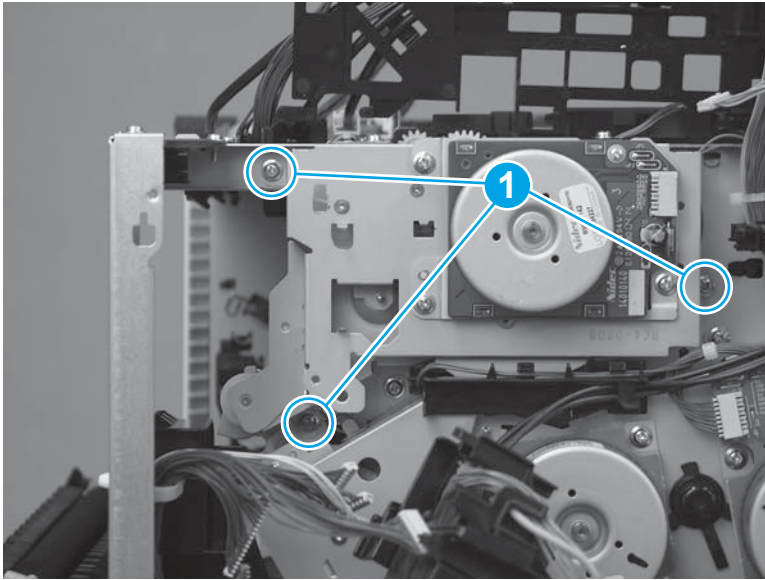

6. Remove the assembly.

CAUTION: Two gears on the back side of the assembly are not captive. Handle the assembly carefully.

Figure 1-3253 Remove the assembly

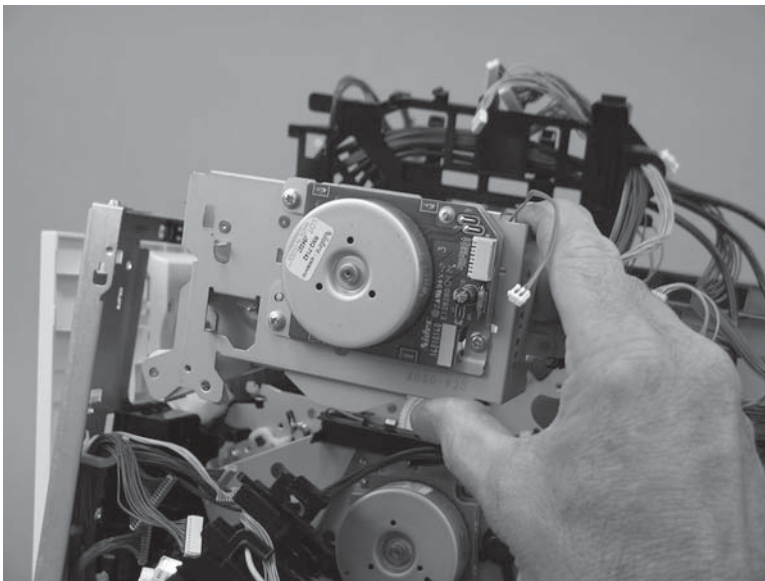

Step 31: Unpack the replacement assembly

Unpack the replacement assembly from the packaging.

For complete information on HP's recycling programs, go to [Product return and recycling](#).

⚠ CAUTION: Two gears (callout 1) on the back side of the assembly are not captive. Handle the assembly carefully.

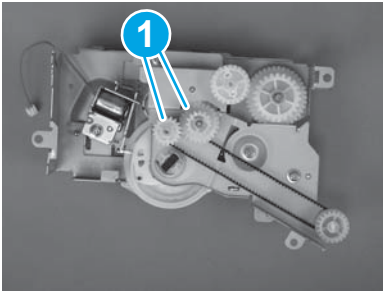

📄 NOTE: HP recommends responsible disposal of the defective assembly.

Figure 1-3254 Recycle and unpack

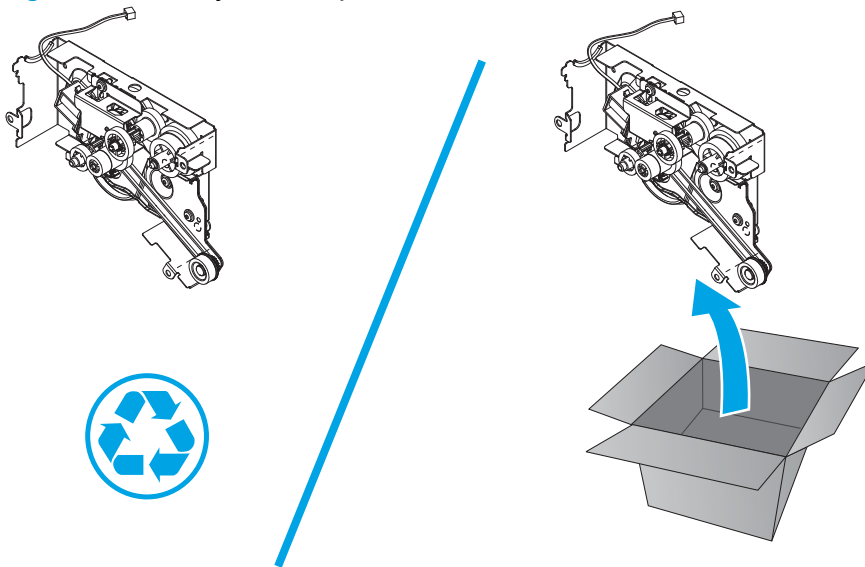

Step 32: Install the fuser drive assembly

1. Two gears (callout 1) on the back side of the assembly are not captive. If the gears are dislodged, install them as shown.

⚠ CAUTION: Handle the assembly carefully.

Figure 1-3255 Check the gears on the assembly

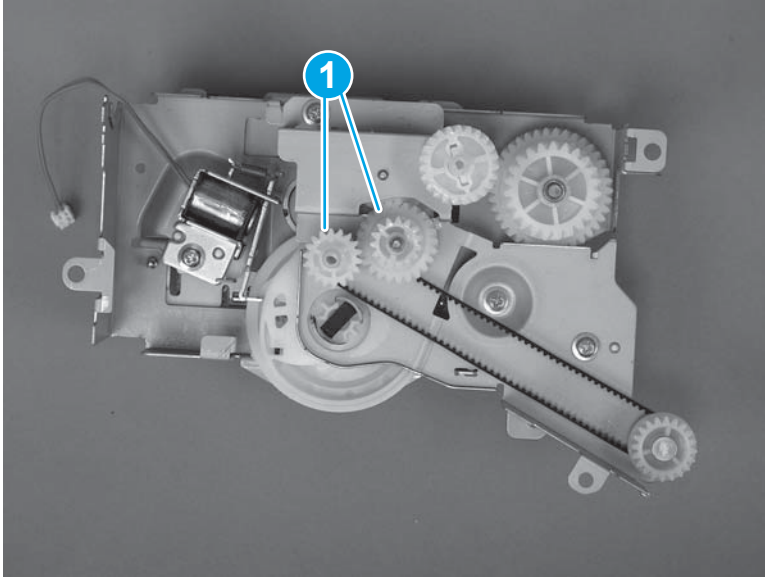

2. Position the assembly on the chassis, and then install three screws (callout 1).

Figure 1-3256 Install three screws

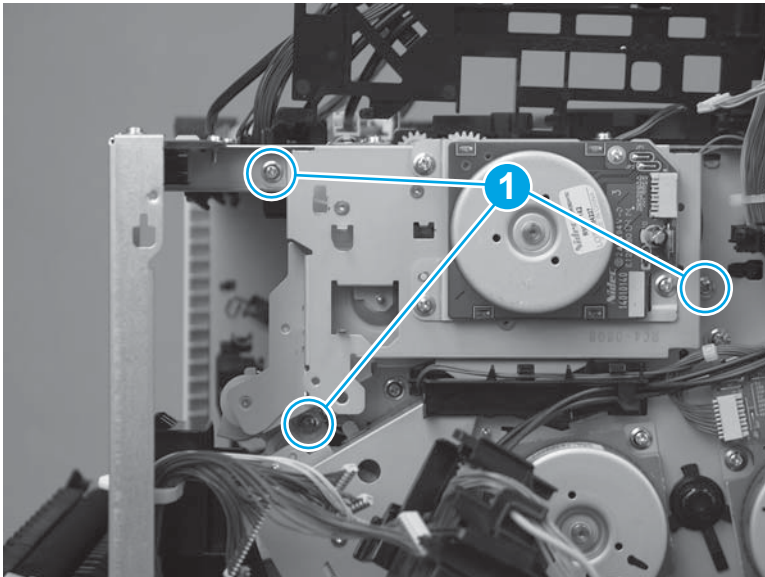

3. Position the guide on the chassis (callout 1), slide the guide up to engage it (callout 2), and then verify that the tab (callout 1) snaps into place.

Figure 1-3257 Install the guide

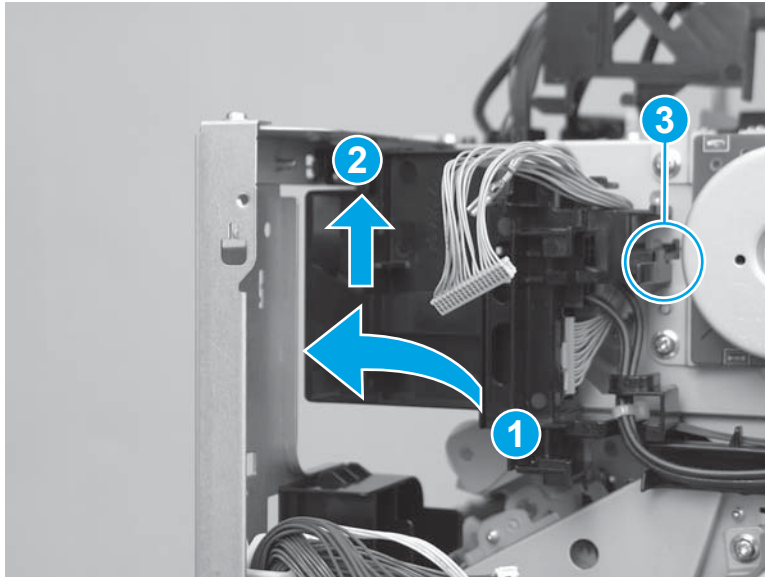

4. Install one screw (callout 1).

Figure 1-3258 Install one screw

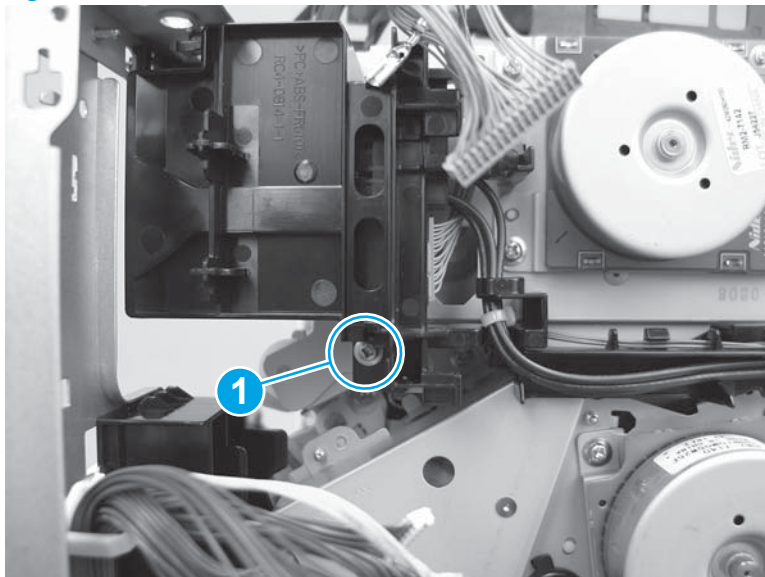

5. Connect one connector (callout 1).

Figure 1-3259 Connect one connector

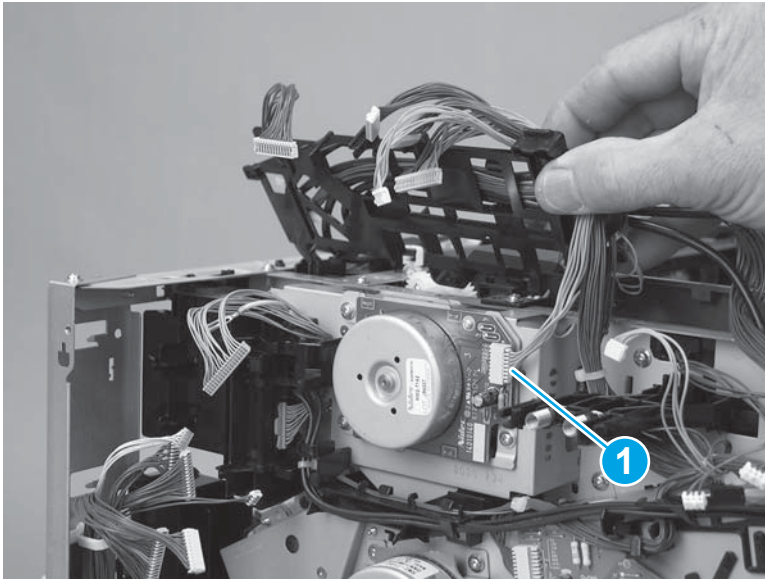

6. Rotate the guide down and onto the chassis (callout 1), slide the guide to engage it (callout 2), and then make sure that the tab (callout 3) snaps into place.

CAUTION: Do not dislodge the fuser motor connector when installing the guide.

Figure 1-3260 Install the guide

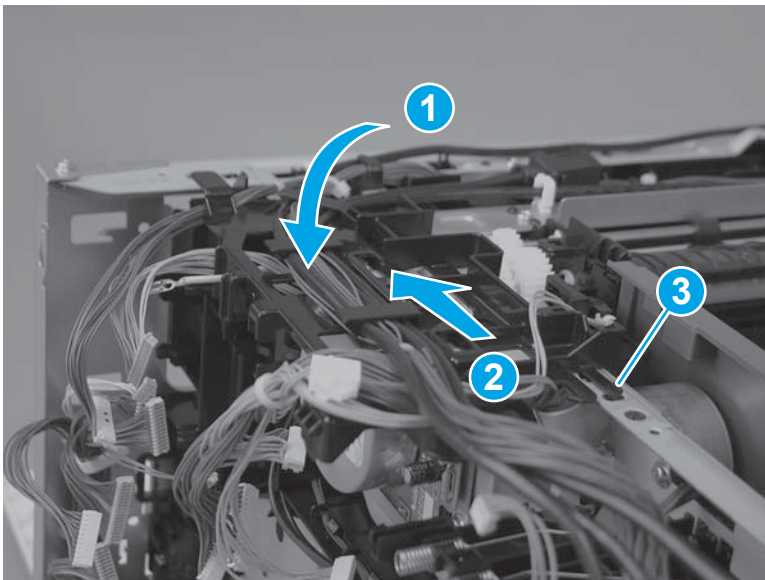

Step 33: Install the HVPST

CAUTION:  ESD-sensitive part.

1. Connect one ground wire connector (callout 1).

Figure 1-3261 Connect one ground wire

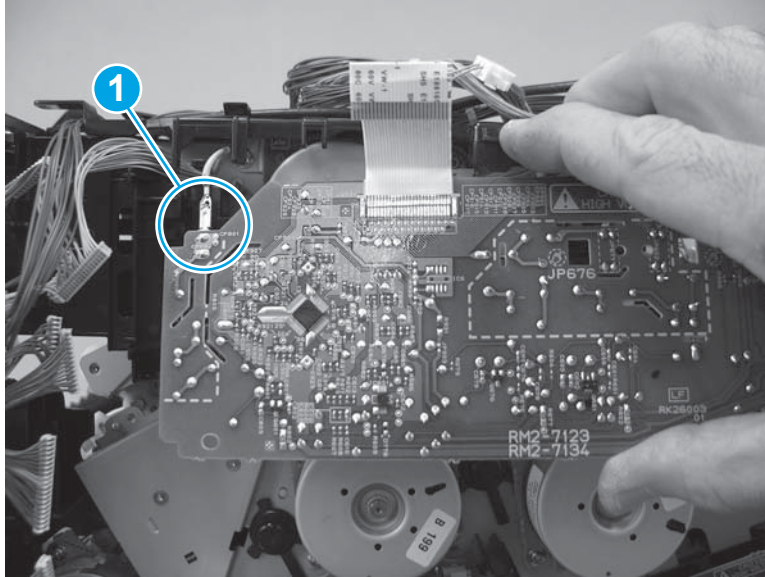

2. Position the HVPST on the printer, and then push in to engage two tabs (callout 1).

 **NOTE:** Make sure that the tabs snap into place.

Figure 1-3262 Install the HVPST



3. Install one screw (callout 1).

Figure 1-3263 Install one screw

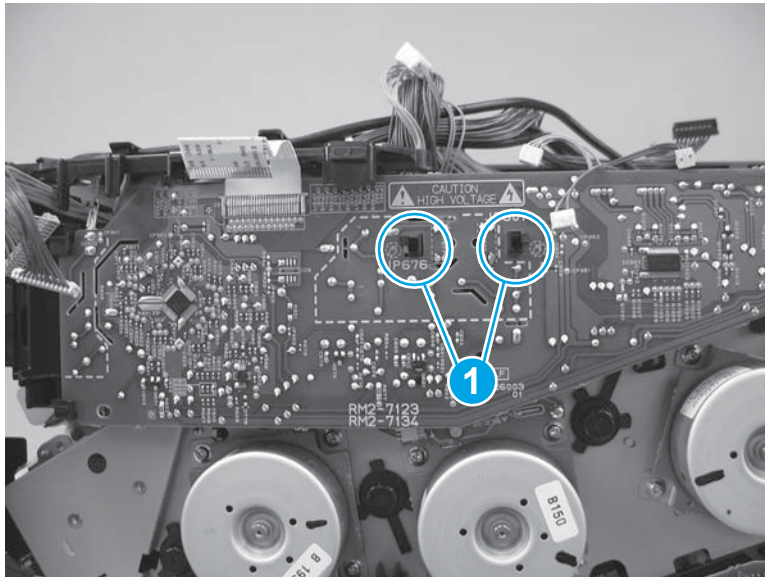
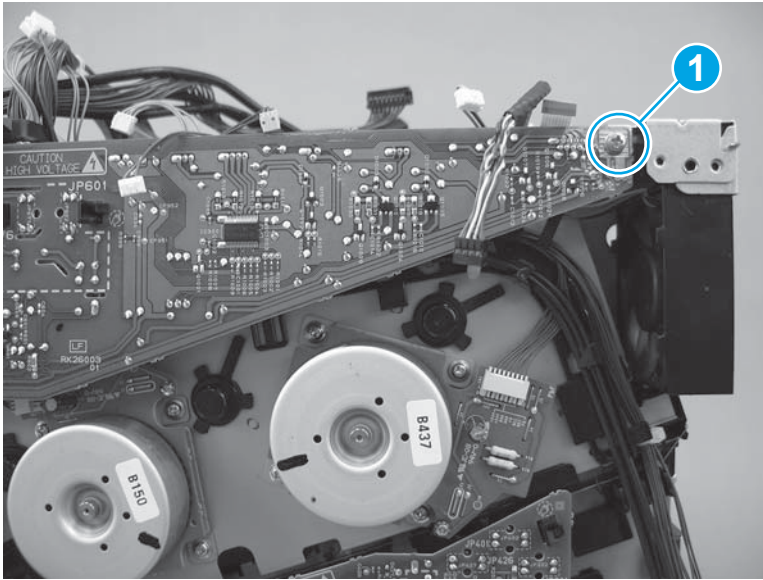

4. Connect five connectors (callout 1), and then connect one flat cable (callout 2).

Figure 1-3264 Connect five connectors and one flat cable

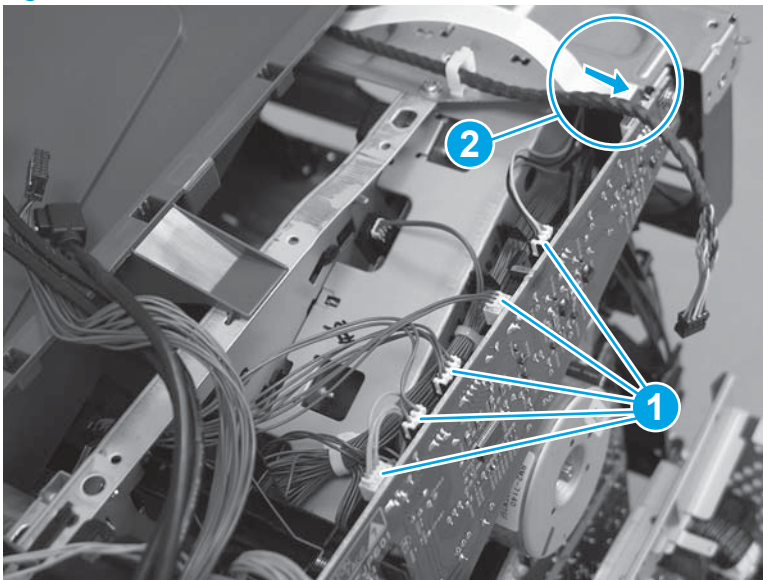

Step 34: Install the DC controller and sheet-metal bracket

 **CAUTION:**  ESD-sensitive part.

1. Position the DC controller and sheet-metal plate on the printer, and then push down to engage the plate with the chassis.

Figure 1-3265 Install the plate

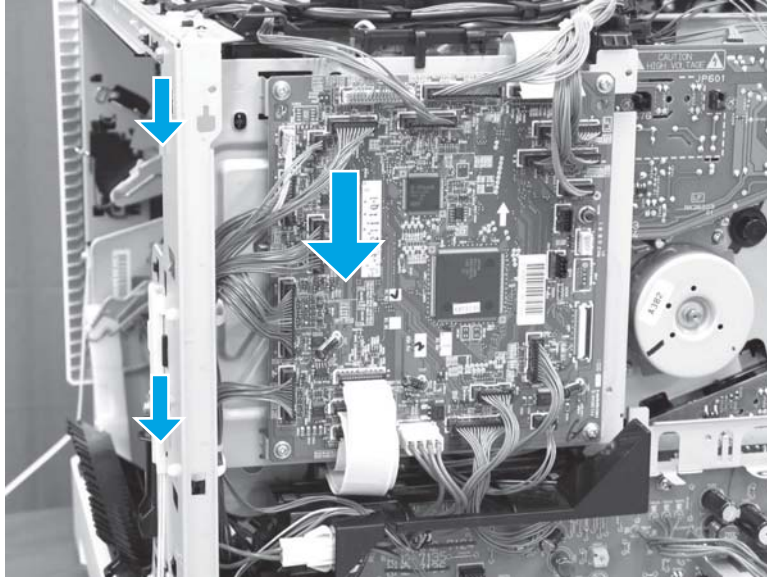

2. Install two screws (callout 1), and then connect all of the connectors.

The following connectors are empty:

- J140, J141, and J143

Figure 1-3266 Install two screws

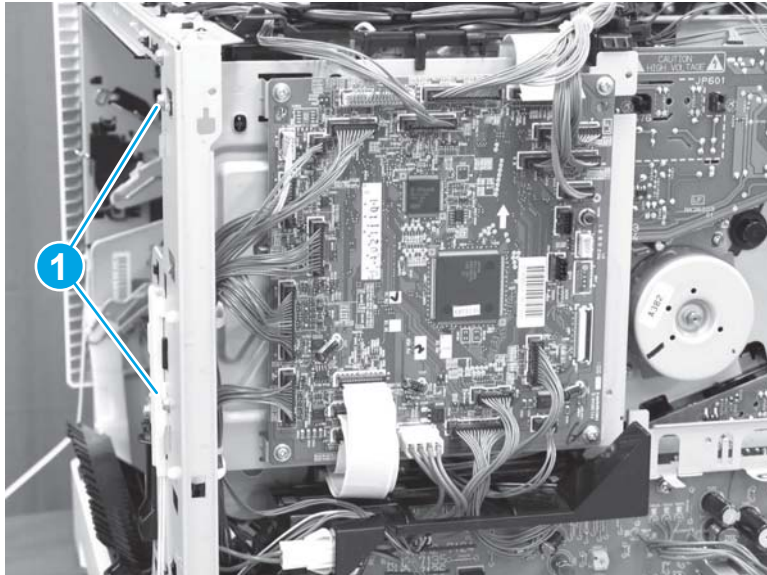

Step 35: Install the right rear cover

1. Position the cover on the printer.

Figure 1-3267 Install the cover

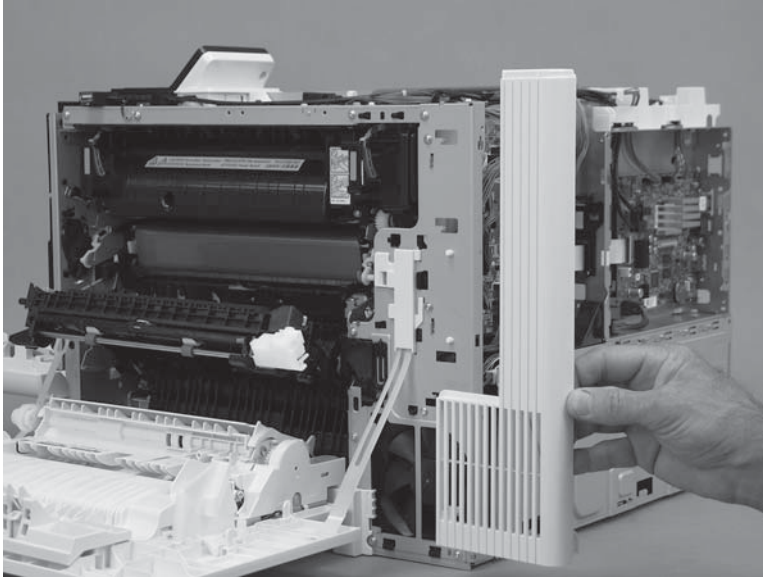

2. Slide the cover toward the right door (callout 1) to engage it with the printer, and then install one screw (callout 2).

Figure 1-3268 Install one screw

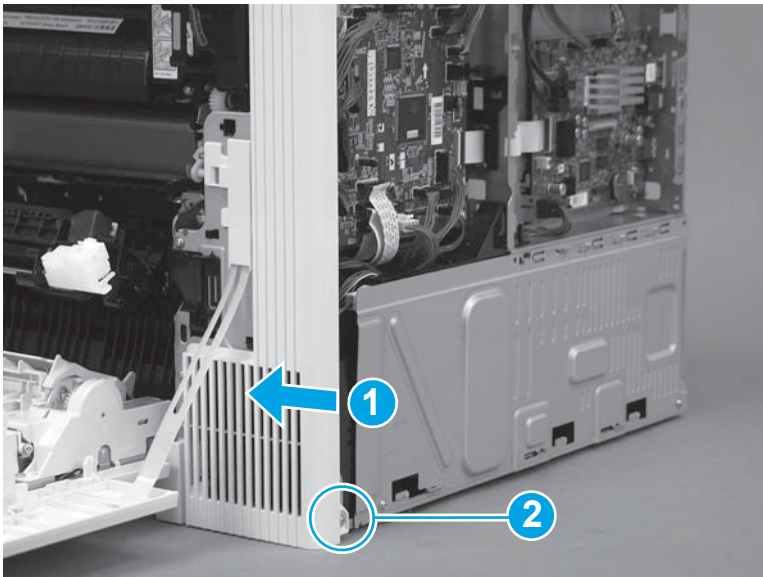

Step 36: Install the formatter case

1. Pass the wire harnesses through the opening in the formatter case.

Figure 1-3269 Pass the wire harnesses through the opening

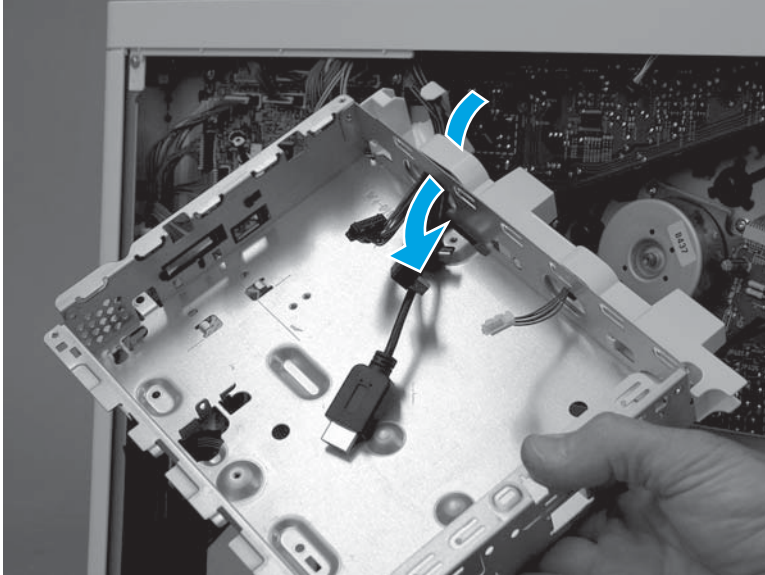

2. Position the top of the formatter case on the printer (callout 1), and then rotate the bottom of the case (callout 2) into the printer.

Figure 1-3270 Install the formatter case

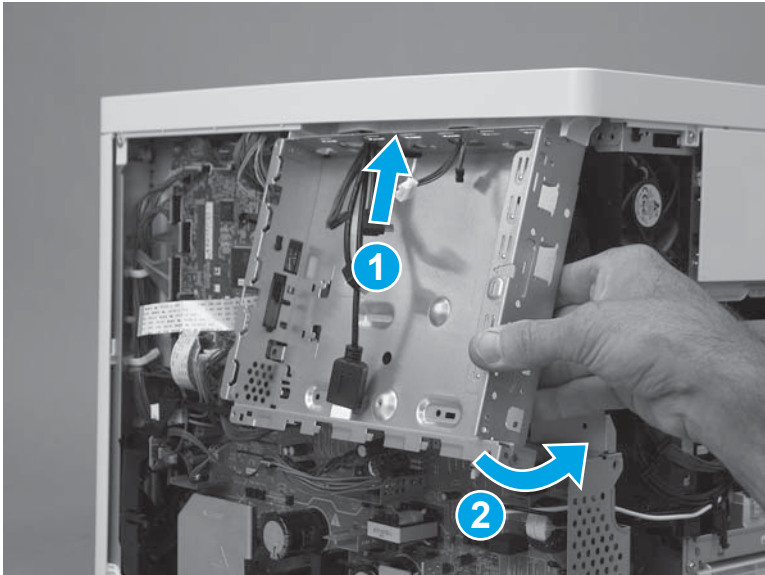

3. Install six screws (callout 1).

Figure 1-3271 Install six screws

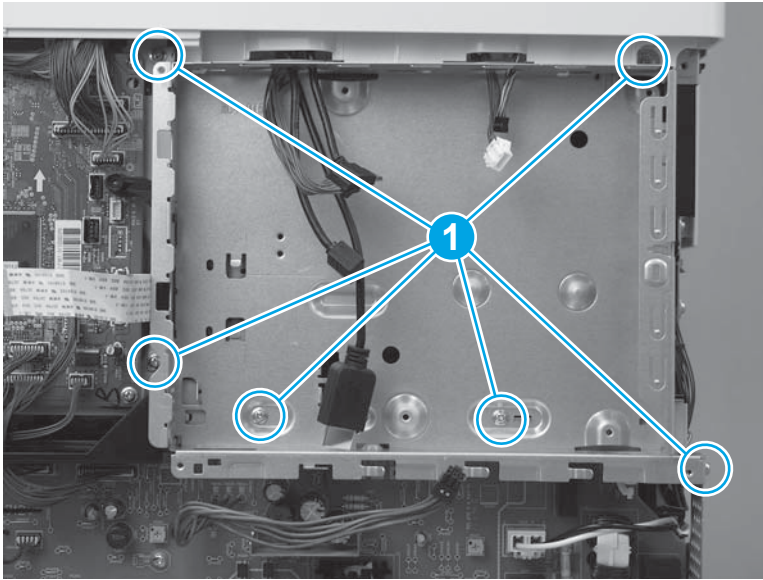

4. Pass two wire harnesses and one flat cable (callout 1) through the opening in the formatter case, and then install one wire harness in the retainer (callout 2).

 **IMPORTANT:** Make sure that the flat cable is securely fastened to the DC controller, and was not dislodged when the formatter case was removed.

Figure 1-3272 Install wire harnesses and flat cable



5. Position the LVPS cover on the printer, slide the cover to the left to install it, and then install two screws (callout 1).

Figure 1-3273 Install the LVPS cover

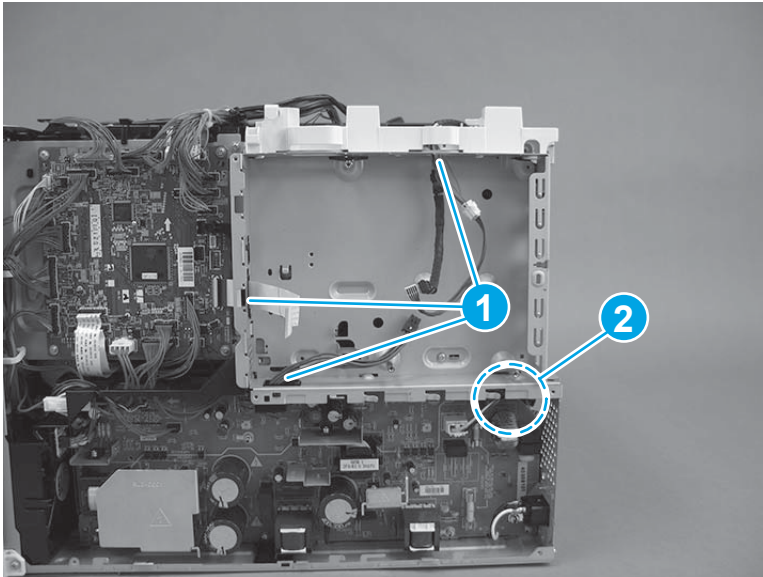
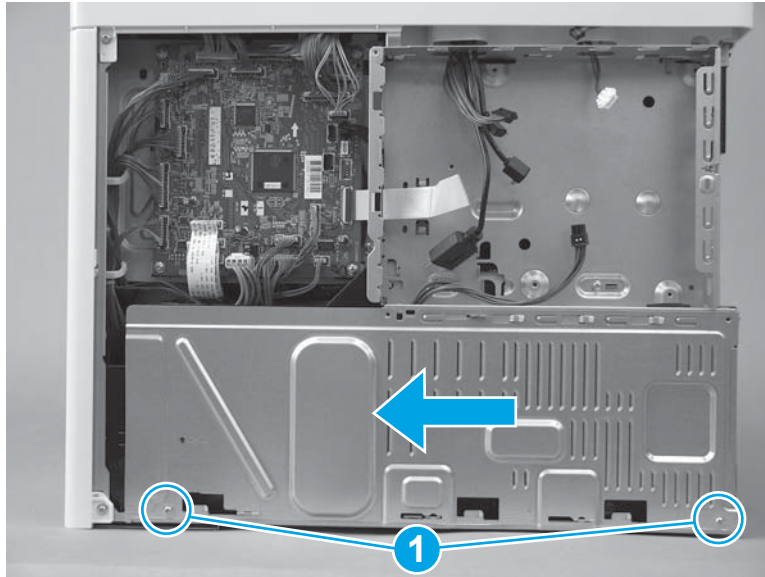

6. If no tape is affixed to the back of the flat cable, skip this step. If double-sided tape is affixed to the back of the flat cable, align the line (callout 1) on the cable with the edge (callout 2) of the opening in the sheet metal. Press to attach the flat cable to the formatter case.

Figure 1-3274 Attach the flat cable

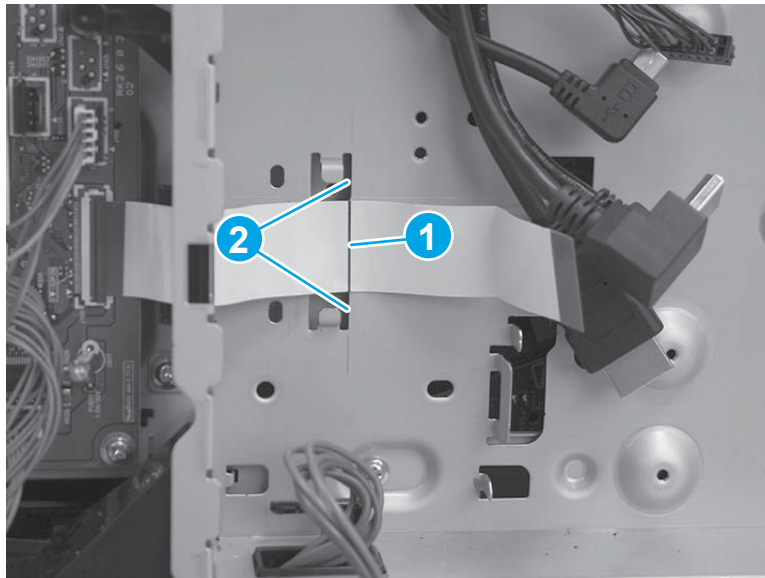

7. Position the bracket over the flat cable, and then slide the bracket to the left to install it. Make sure that the edges of the bracket fit under the sheet metal tabs (callout 1) on the formatter case and that the tabs (callout 2) snap into place.

Figure 1-3275 Position the bracket

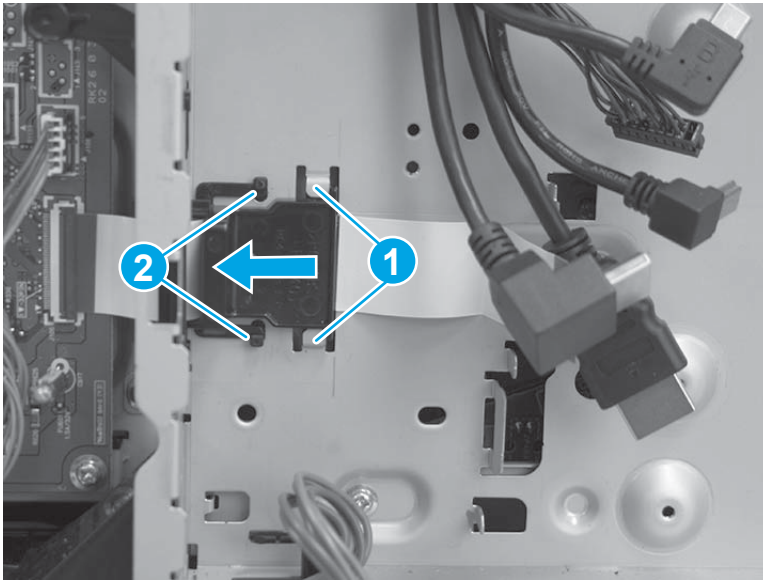

8. **M577 only:** Pass the wire harness (callout 1) through the openings in the formatter case (callout 2), and then connect one connector (callout 3).

Figure 1-3276 Connect one connector

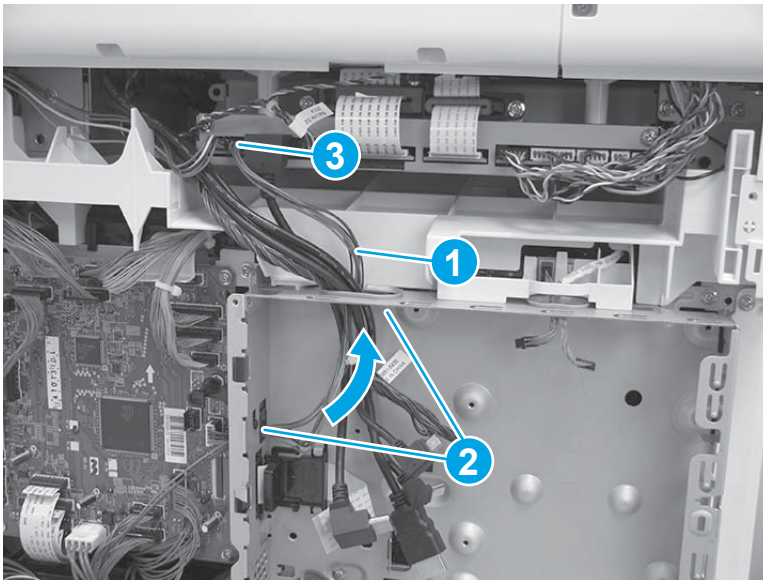

Step 37: Install the upper cover (M552 and M553)

 **NOTE:** This step is for the M552 and M553 models. For the M577 models, skip this step and go to [Step 38: Install the left cover on page 1846](#).

1. Position the cover on the printer.

 **NOTE:** For the M553x model, do not forget to pass the control-panel wire harness and USB cable through the opening in the cover.

Figure 1-3277 Install the cover



2. Push down on the rear corner of the cover to engage one tab (callout 1).

Figure 1-3278 Engage one tab

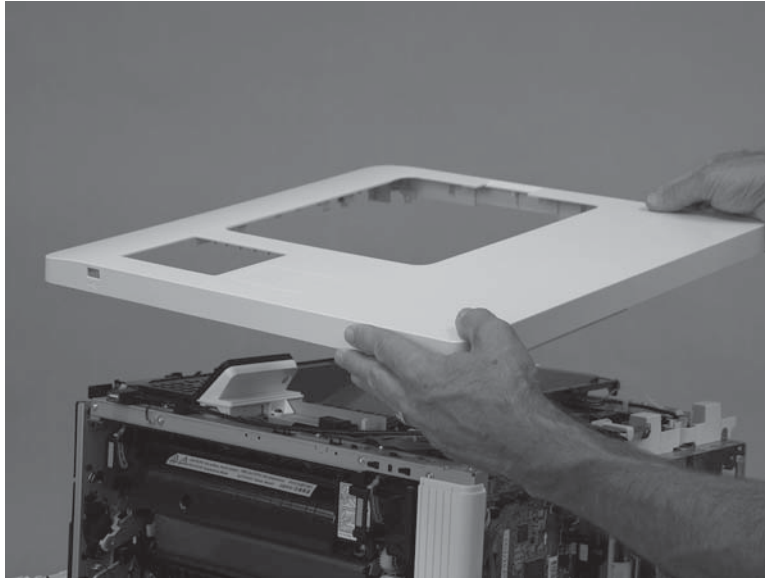
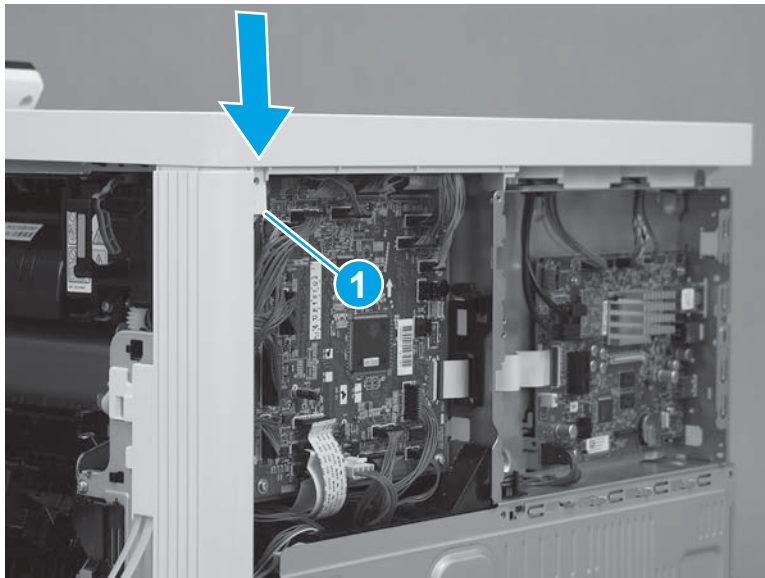

3. Push down on the front corner of the cover to engage one tab (callout 1), and then install one screw (callout 2).

 **NOTE:** This is a self-tapping plastic-thread screw. Make sure that this screw is used in this location when it is reinstalled.

Figure 1-3279 Engage one tab and install one screw



4. Install three screws (callout 1).

Figure 1-3280 Install three screws

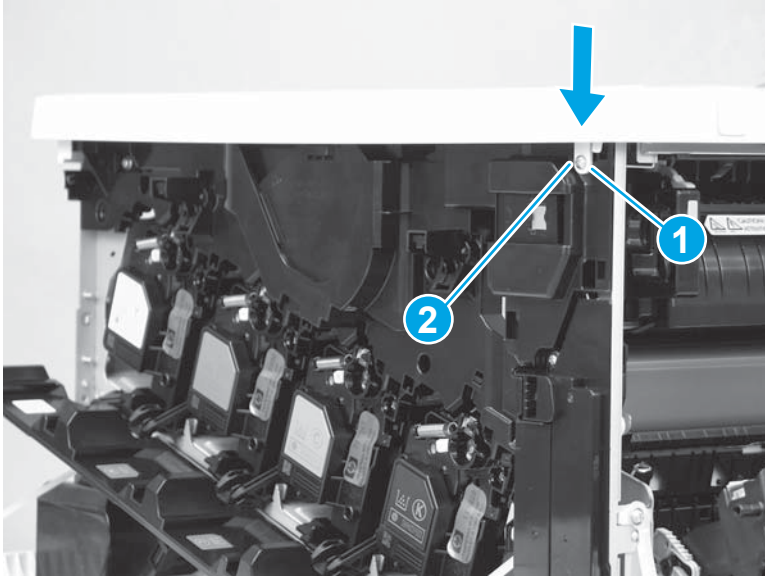
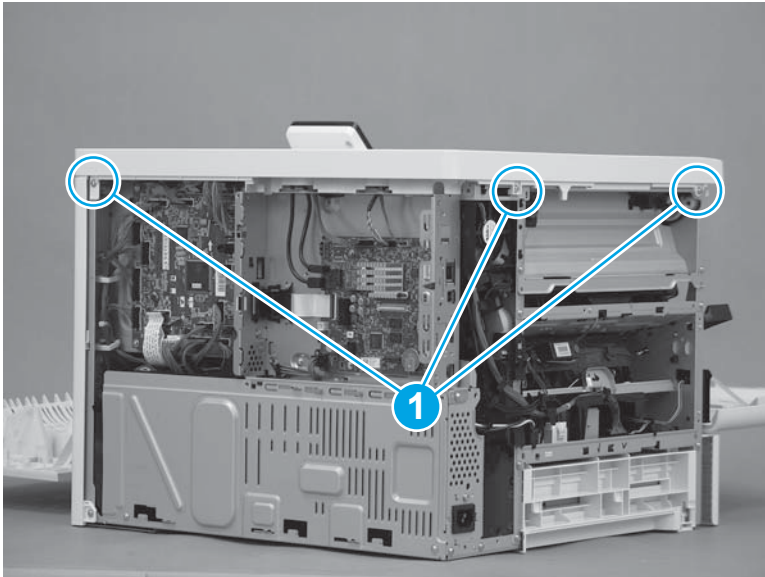

Step 38: Install the left cover

1. Position the cover on the printer.

 **NOTE:** Slightly offset the cover toward the rear of the printer.

Figure 1-3281 Install the cover

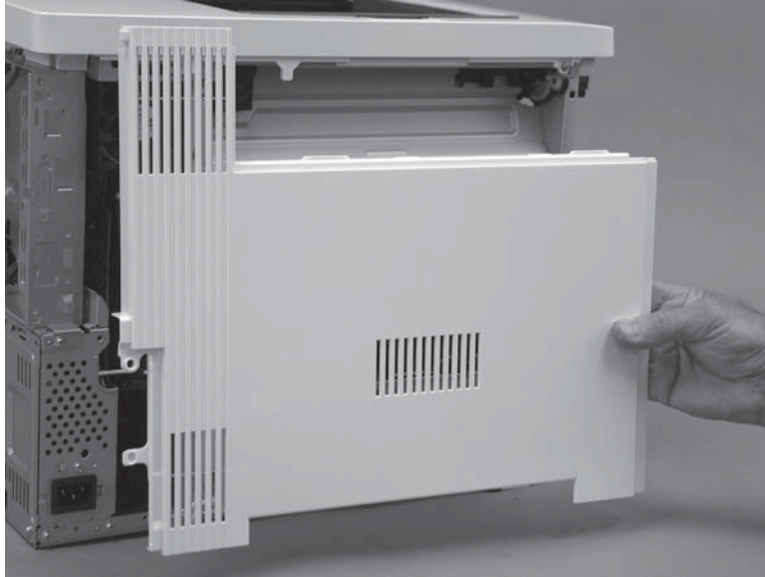

2. Slide the cover (callout 1) toward the front of the printer to engage it. Make sure that the tab (callout 2) snaps into place.

 **NOTE:** Locate the alignment pin (callout 3) on the cover from the front door side of the printer, and then make sure that it is fully engaged in the slot in the chassis.

 **TIP:** While sliding the cover into place, push in on the center of the cover (callout 1) to make sure that the hooks on the back of the cover engage with the slots in the chassis.

Figure 1-3282 Engage the cover



3. At the left side of the printer, install one screw (callout 1).

Figure 1-3283 Install one screw

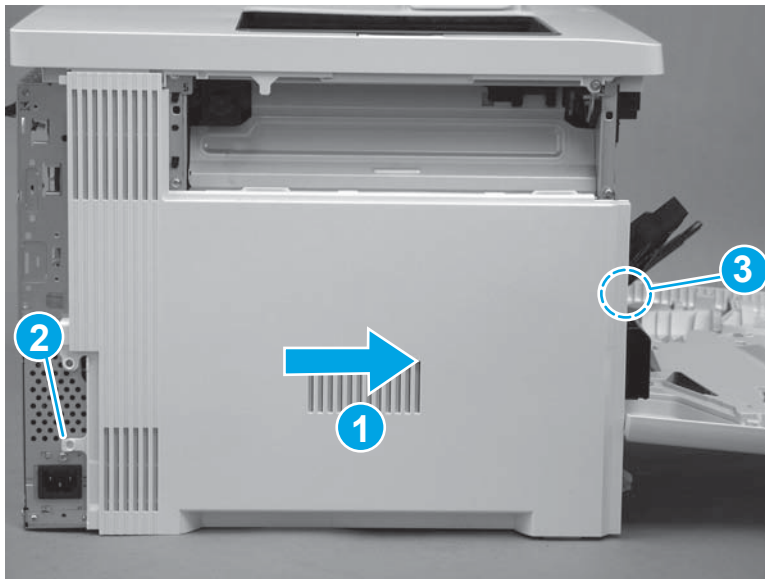

Step 39: Install the top bracket (M577)



NOTE: This step is for the M577 models. For the M552 and M553 models, skip this step and go to [Step 51: Install the rear cover \(M552 and M553\) on page 1870](#).

1. Position the tabs (callout 1) on the bracket in the slots (callout 2) in the printer.

Figure 1-3284 Position the tabs in the slots

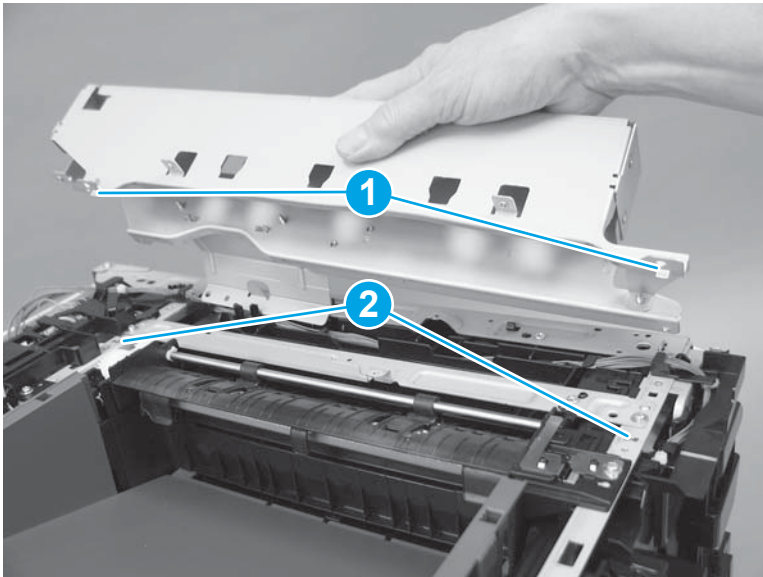

2. At the top of the printer, install two screws (callout 1).

Figure 1-3285 Install two screws

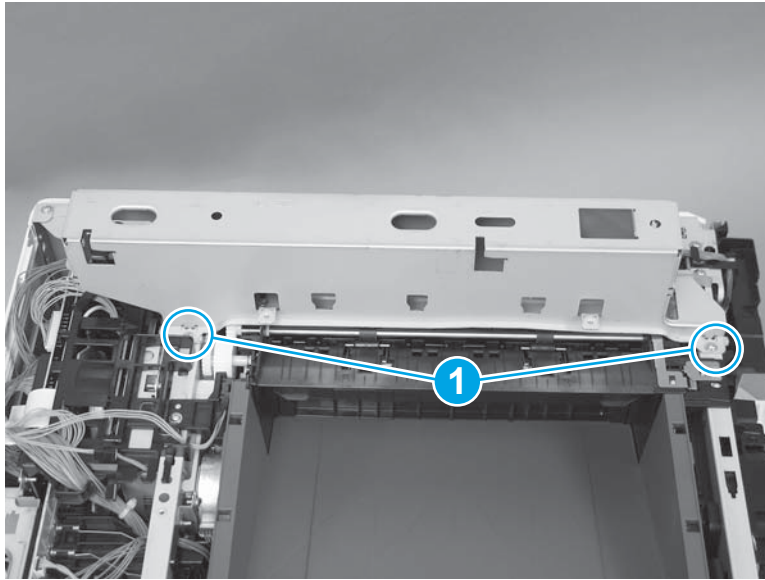

3. At the top of the printer, install three screws (callout 1).

Figure 1-3286 Install three screws

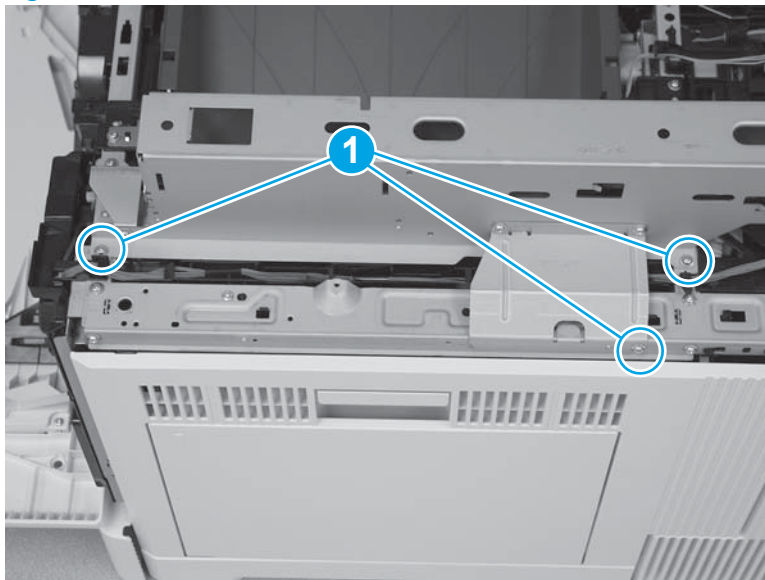

Step 40: Install the top cover (M577)

 **NOTE:** This step is for the M577 models. For the M552 and M553 models, skip this step and go to [Step 51: Install the rear cover \(M552 and M553\) on page 1870.](#)

1. Position the locator pins (callout 1) on the cover in the slots (callout 2) in the printer.

Figure 1-3287 Position the locator pins

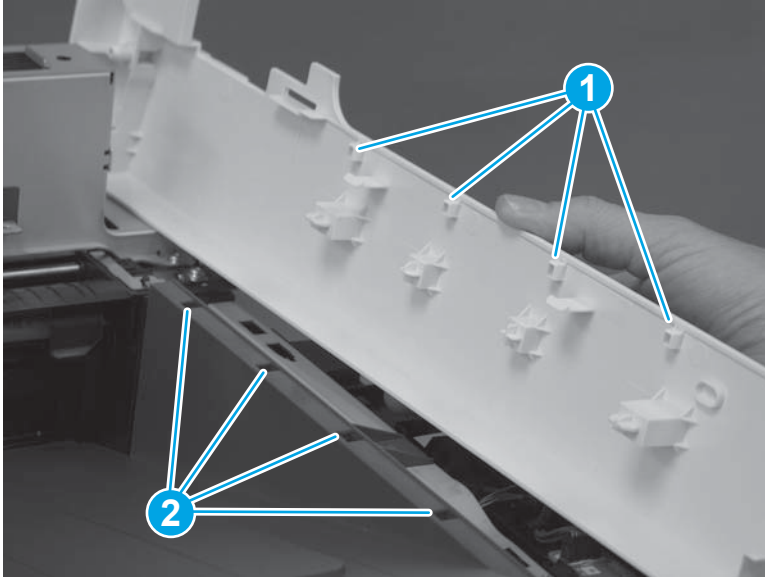

2. Press down on the cover to install it. Make sure that the tabs (callout 1) snap into place.

Figure 1-3288 Press down on the cover

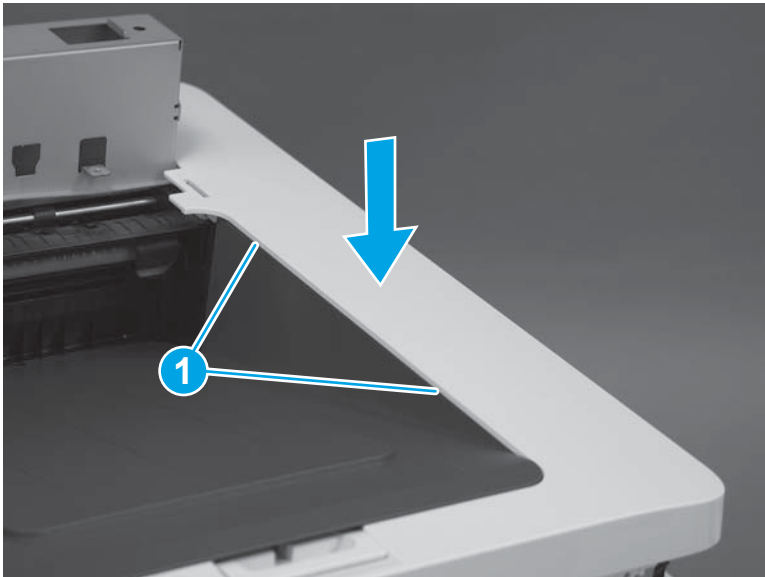

3. At the front of the printer, install one screw (callout 1).

 **Reinstallation tip:** This screw is longer and a different type of screw than the screw installed in the next step. Make sure that this screw is installed in the correct position.

Figure 1-3289 Install one screw



4. At the left side of the printer, install one screw (callout 1).

Figure 1-3290 Install one screw

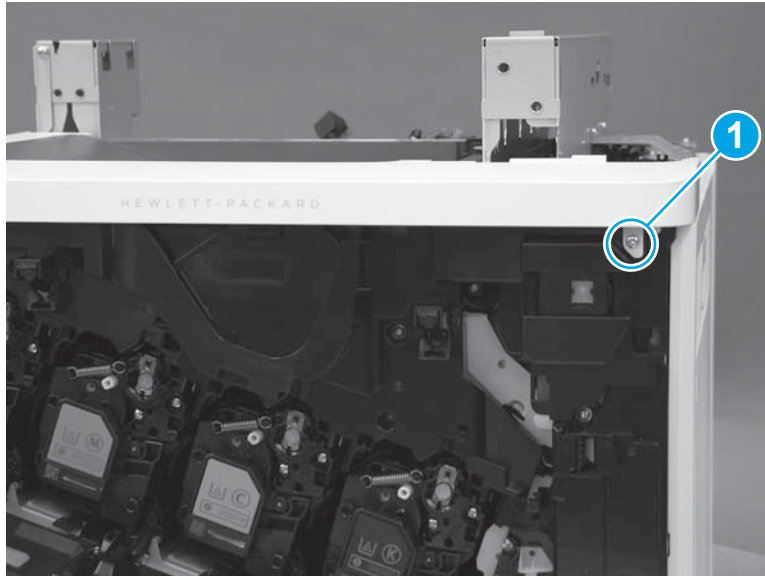
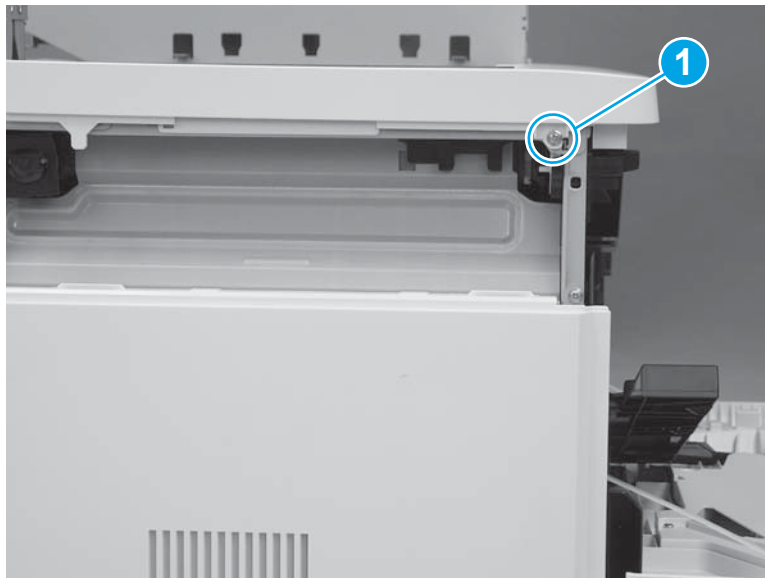

Step 41: Install the paper feed cover (M577)

 **NOTE:** This step is for the M577 models. For the M552 and M553 models, skip this step and go to [Step 51: Install the rear cover \(M552 and M553\) on page 1870](#).

1. Position the locator tabs (callout 1) on the cover in the slots (callout 2) in the printer. Press down until the cover snaps into place.

Figure 1-3291 Install the cover

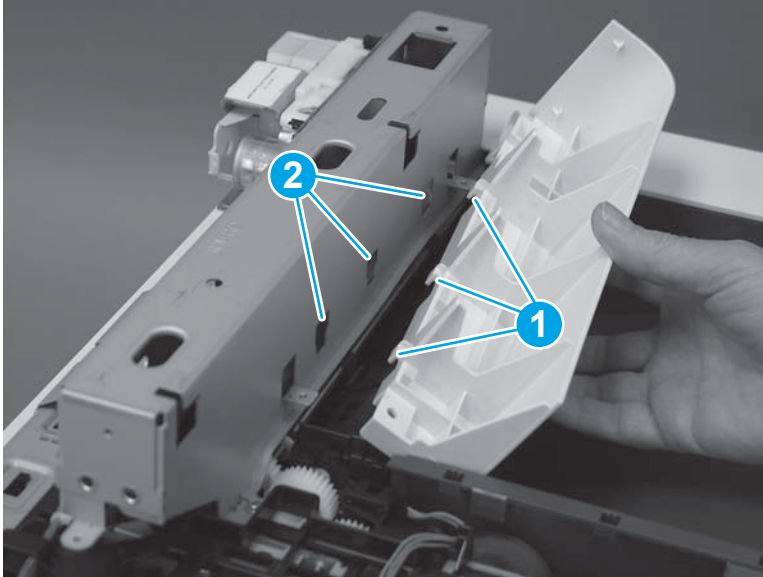

2. Install one screw (callout 1).

Figure 1-3292 Install one screw

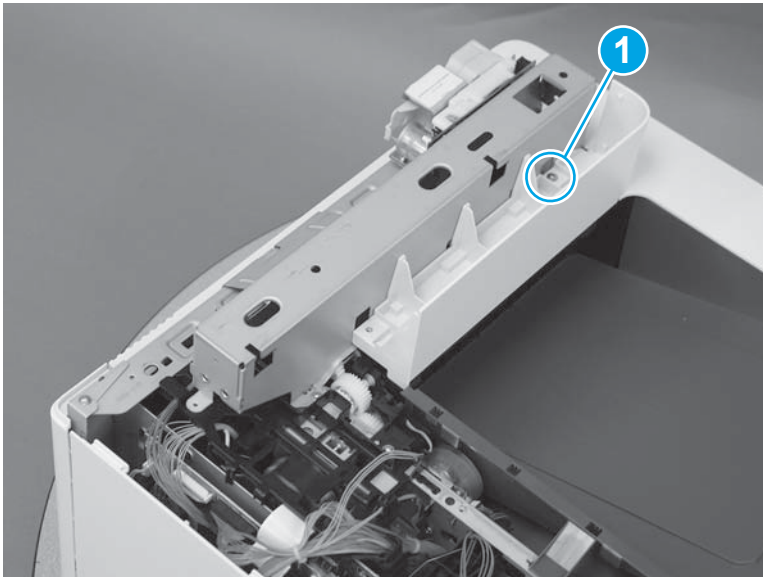

Step 42: Install the top rear cover (M577)



NOTE: This step is for the M577 models. For the M552 and M553 models, skip this step and go to [Step 51: Install the rear cover \(M552 and M553\) on page 1870](#).

1. Align the locator tabs (callout 1) on the cover with the slots (callout 2) in the printer.

Figure 1-3293 Align the locator tabs

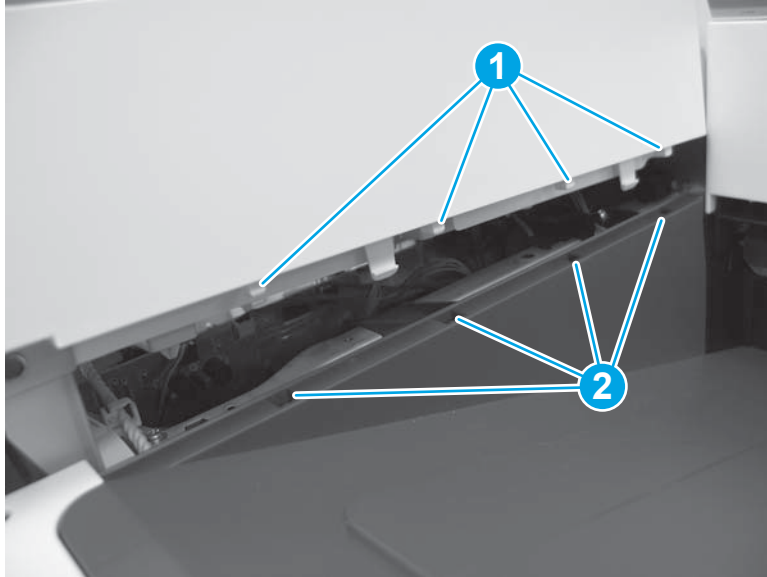

2. Press down to install the cover. Make sure that the tabs snap into place.

Figure 1-3294 Install the cover

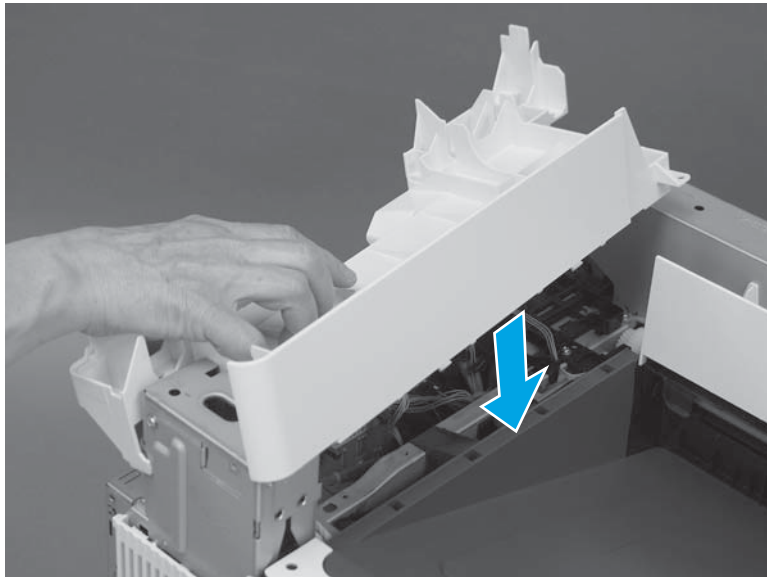

3. At the top of the printer, install five screws (callout 1).

Figure 1-3295 Install five screws

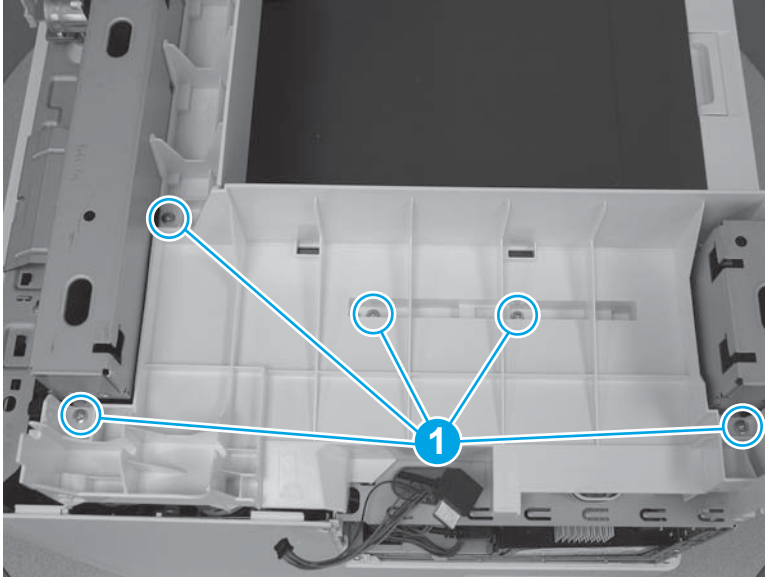

Step 43: Install the right upper cover (M577)



NOTE: This step is for the M577 models. For the M552 and M553 models, skip this step and go to [Step 51: Install the rear cover \(M552 and M553\) on page 1870](#).



NOTE: The figures below show the image scanner installed. The procedures for removing and installing the right upper cover are the same whether the image scanner is installed or removed."

1. **M577c/f/z only:** Install the cables (callout 1) through the slot (callout 2) in the printer.

Figure 1-3296 Install the cables

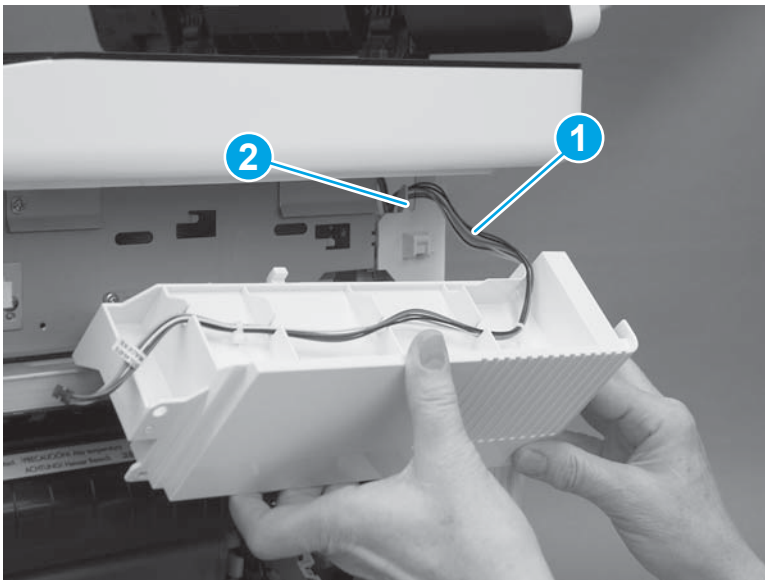

2. Position the hooks (callout 1) on the cover in the slots (callout 2) in the printer.

Figure 1-3297 Position the hooks

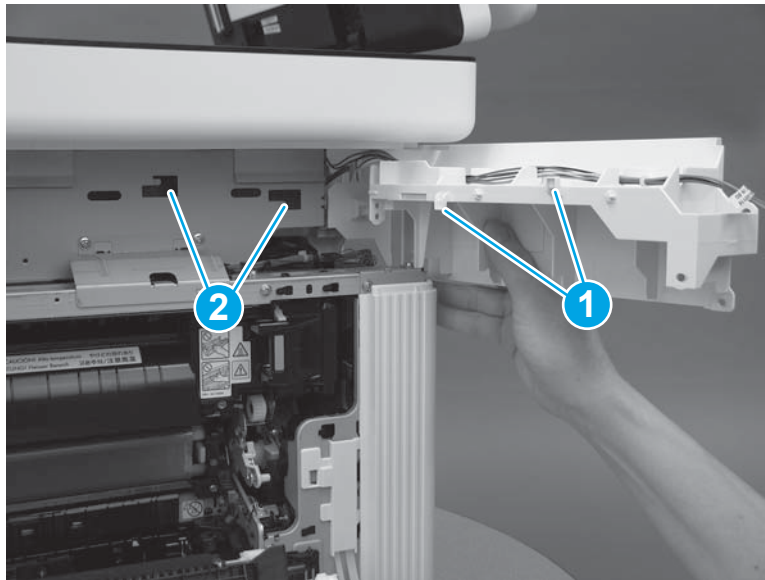

3. Slide the cover toward the front of the printer to install it.

Figure 1-3298 Install the cover

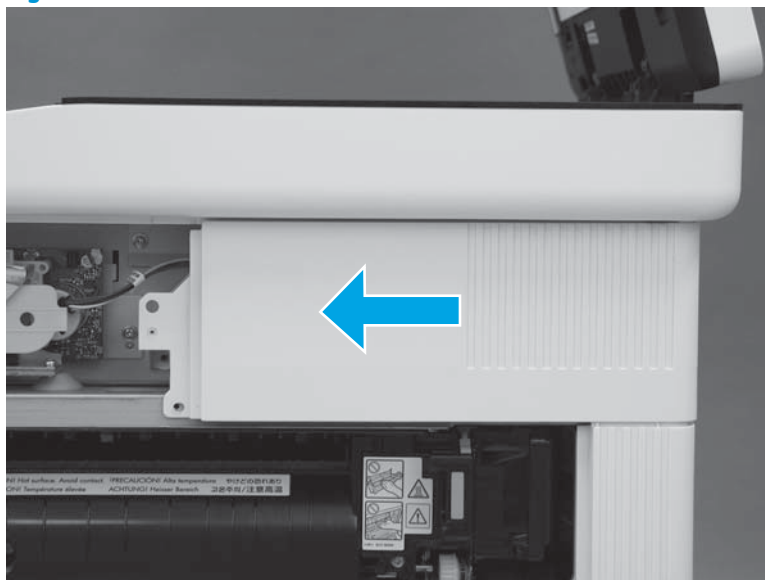

4. At the back of the printer, install one screw (callout 1).

M577c/f/z only: Connect one connector (callout 2), if the integrated scanner assembly is installed.

 **TIP:** This screw is smaller than the screws installed in the next step. Make sure that this screw is installed in the correct position.

Figure 1-3299 Install one screw and connector



5. At the right side of the printer, install two screws (callout 1).

M577c/f/z only: Connect one connector (callout 2), if the stapler is installed.

Figure 1-3300 Install one screw and connector

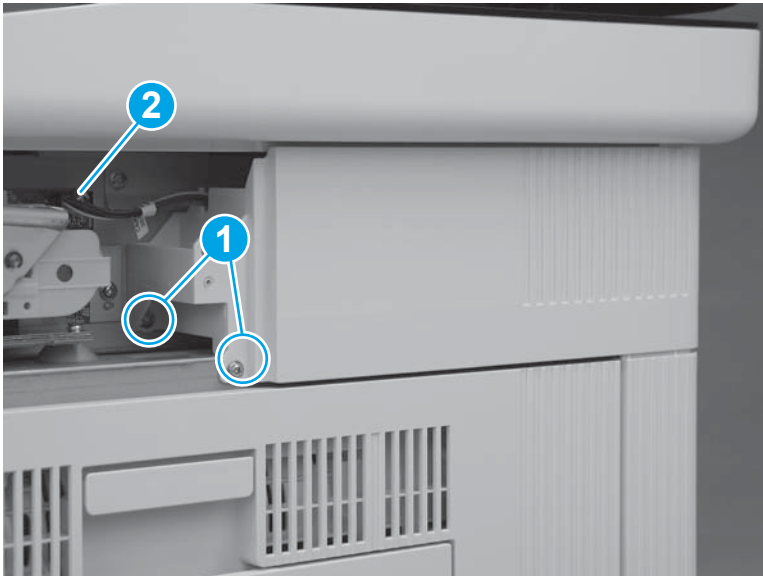

Step 44: Install the stapler unit (M577c/f/z)

 **NOTE:** This step is for the M577c/f/z models. For the M577dn model, skip this step and go to [Step 45: Install the integrated scanner assembly \(ISA\) \(M577\) on page 1858](#).

For the M552 and M553 models, skip this step and go to [Step 51: Install the rear cover \(M552 and M553\) on page 1870](#).

1. Position the hooks (callout 1) on the stapler unit in the slots (callout 2) in the printer.

Figure 1-3301 Position the hooks in the slots

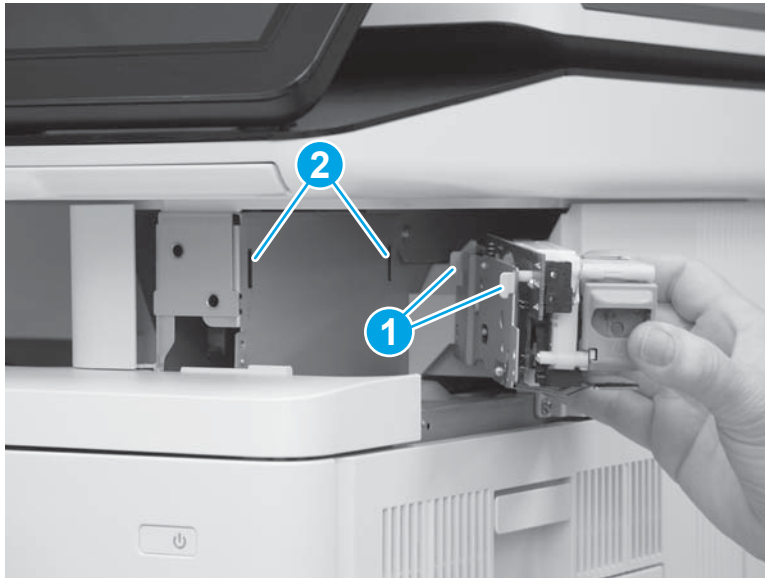

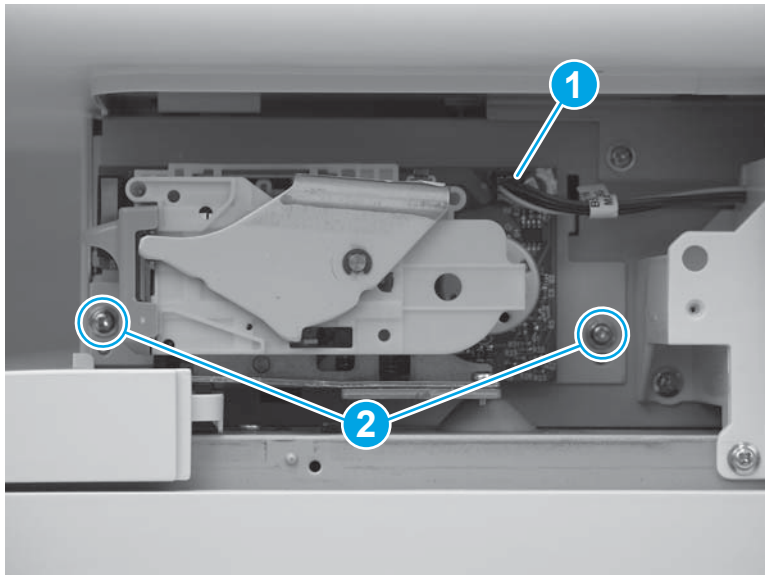

2. Connect one connector (callout 1), and then install two screws (callout 2).

Figure 1-3302 Connect connector and install screws



Step 45: Install the integrated scanner assembly (ISA) (M577)

 **NOTE:** This step is for the M577 models. For the M552 and M553 models, skip this step and go to [Step 51: Install the rear cover \(M552 and M553\) on page 1870.](#)

 **NOTE:** The ISA includes the document feeder, image scanner, scanner control board (SCB), control panel, keyboard (M577c/z) and NFC PCA (M577z).

1. Before proceeding, locate the mounting pins (callout 1) on the bottom of the ISA and the slots (callout 2) on the printer base.

Figure 1-3303 Locate the ISA mounting pins and slots

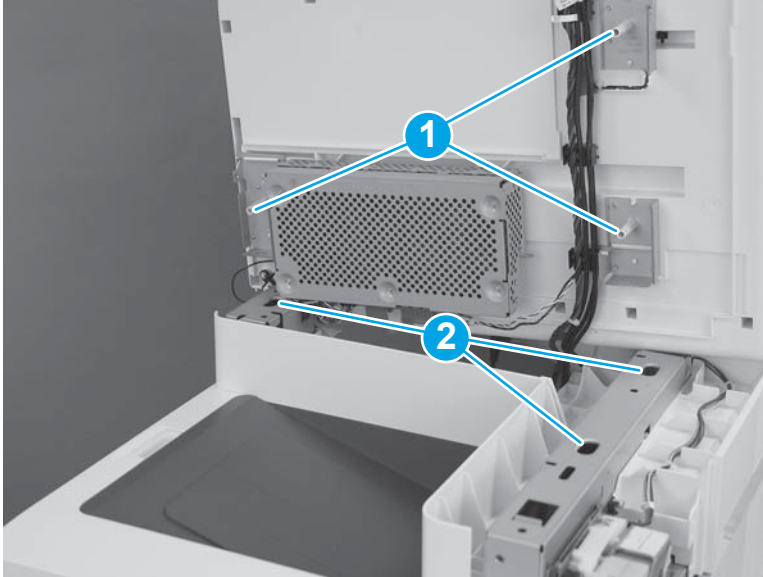

2. Position the ISA on the printer base with the pins in the slots.



NOTE: To locate the pins and slots, see [Figure 1-395 Locate the ISA mounting pins and slots on page 250](#).

When installing the ISA, carefully pass the cables through the opening in the top of the formatter case.

Figure 1-3304 Install the ISA



3. Slightly slide the ISA towards the front of the printer to engage it.

Figure 1-3305 Slide the ISA towards the front of the printer

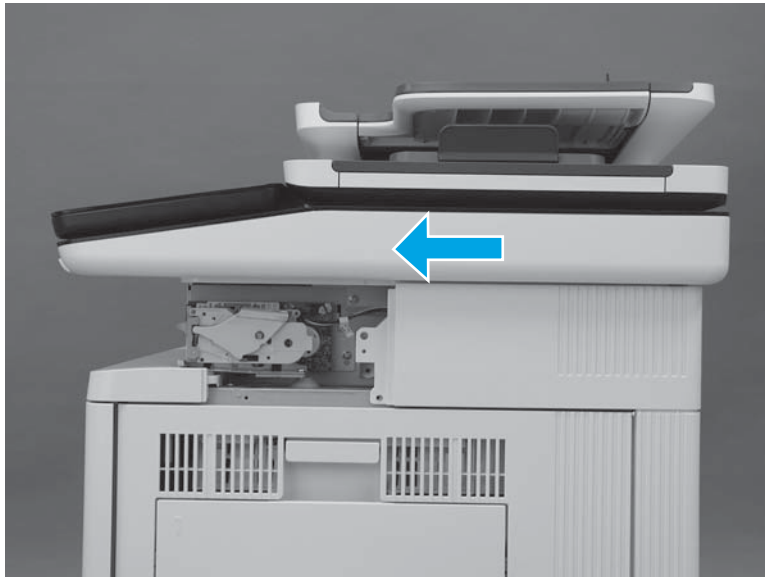

4. At the left side of the printer, install one screw (callout 1).

Figure 1-3306 Install one screw

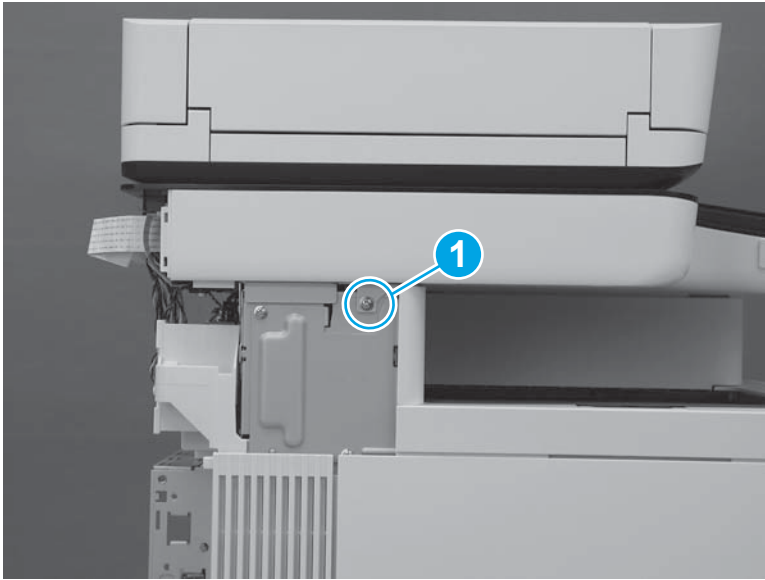

5. At the back of the printer, install two screws (callout 1).

Figure 1-3307 Install two screws

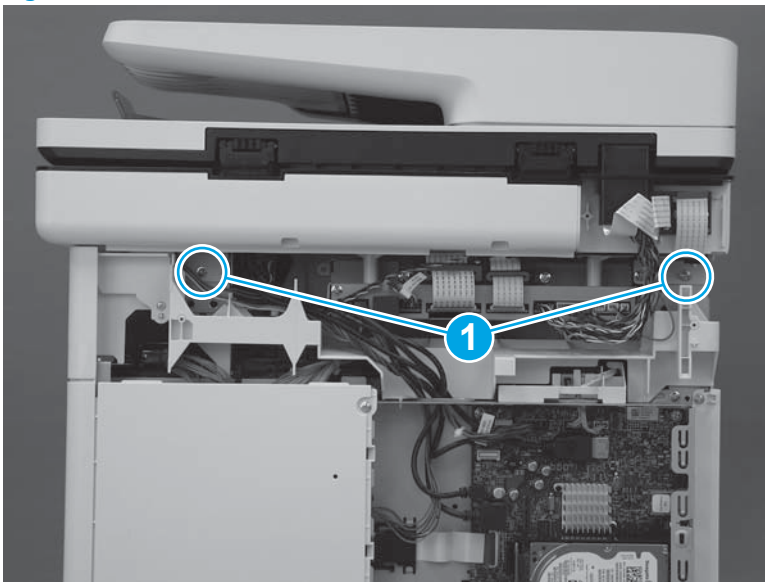

6. At the right side of the printer, install one screw (callout 1).

Figure 1-3308 Install one screw

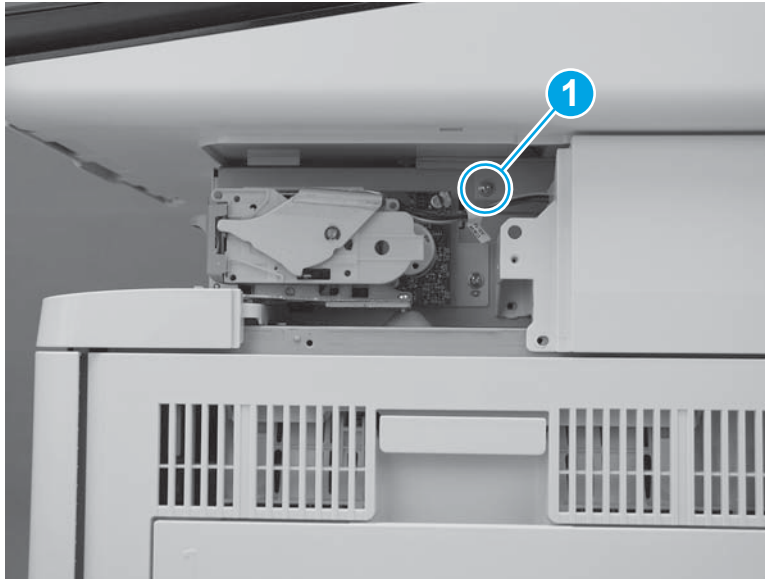

7. Connect two connectors on the scanner control board (callout 1).

M577c/f/z only: Connect one connector for the stapler on the scanner control board (callout 2).

Figure 1-3309 Connect connectors

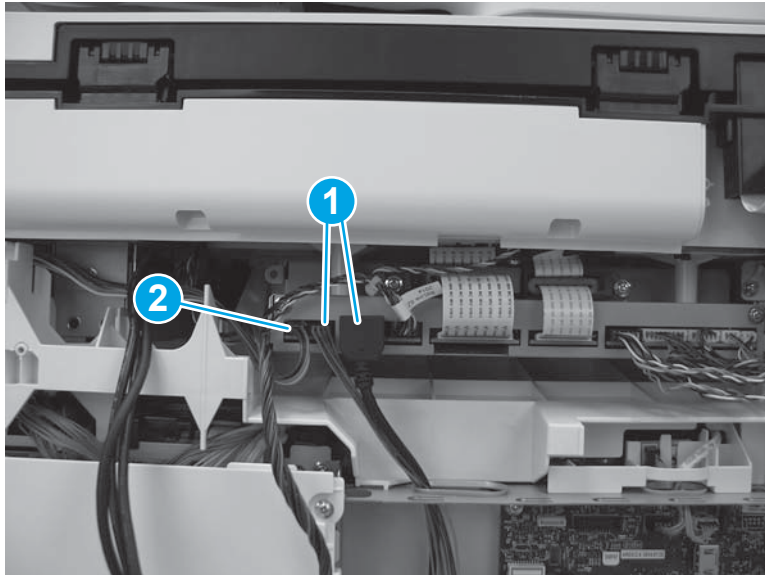

Step 46: Install the stapler cover assembly (M577c/f/z)

 **NOTE:** This step is for the M577c/f/z models only. For the M577dn model, skip this step and go to [Step 47: Install the right front upper cover \(M577dn\) on page 1863](#).

For the M552 and M553 models, skip this step and go to [Step 51: Install the rear cover \(M552 and M553\) on page 1870](#).

1. Install the tabs (callout 1) on the cover in the slots (callout 2) in the printer.

Figure 1-3310 Install two tabs



2. Press the cover toward the left side of the printer until it snaps into place.

Figure 1-3311 Install the cover assembly



3. Install one screw (callout 1).



 **IMPORTANT:** This is a self-tapping screw for plastic. Rotate it counterclockwise to align it with the existing thread pattern, and then carefully turn it clockwise to tighten. Do not overtighten. This will prevent stripping the threads inside the screw hole.

Figure 1-3312 Install one screw

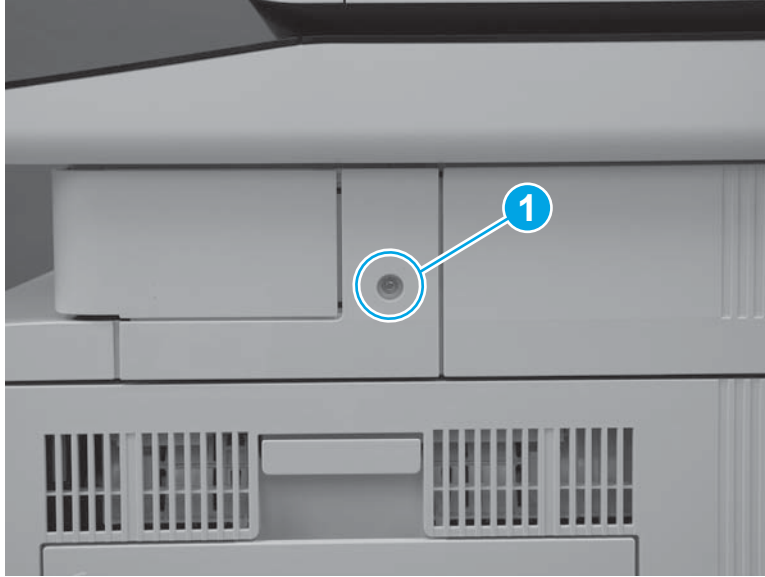

Step 47: Install the right front upper cover (M577dn)

 **NOTE:** This step is for the M577dn model only. For the M577c/f/z models, skip this step and go to [Step 48: Install the left upper cover \(M577\) on page 1865](#).

For the M552 and M553 models, skip this step and go to [Step 51: Install the rear cover \(M552 and M553\) on page 1870](#).

1. Slide the cover toward the left side of the printer to install it. Make sure that the slots (callout 1) in the cover fit over the tabs (callout 2) on the inside of the paper feeder cover.

Figure 1-3313 Install the cover



2. Press the right front upper cover (callout 1) and the paper feeder cover (callout 2) together until the tabs on the inside of the covers snap into place.

Figure 1-3314 Press the cover



3. Install one screw (callout 1).

Figure 1-3315 Install one screw

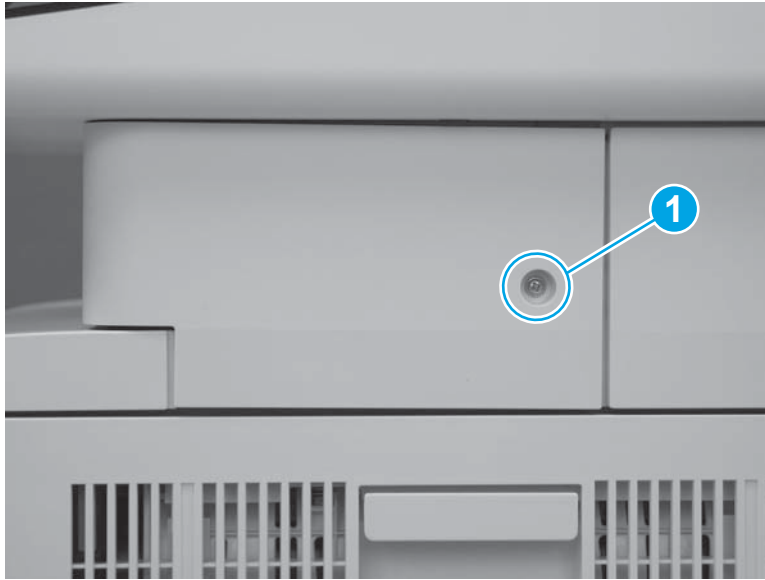

Step 48: Install the left upper cover (M577)

 **NOTE:** This step is for the M577 models. For the M552 and M553 models, skip this step and go to [Step 51: Install the rear cover \(M552 and M553\) on page 1870](#).

1. Position the tab (callout 1) on the lower edge of the cover behind the left cover (callout 2).

Figure 1-3316 Position the tab

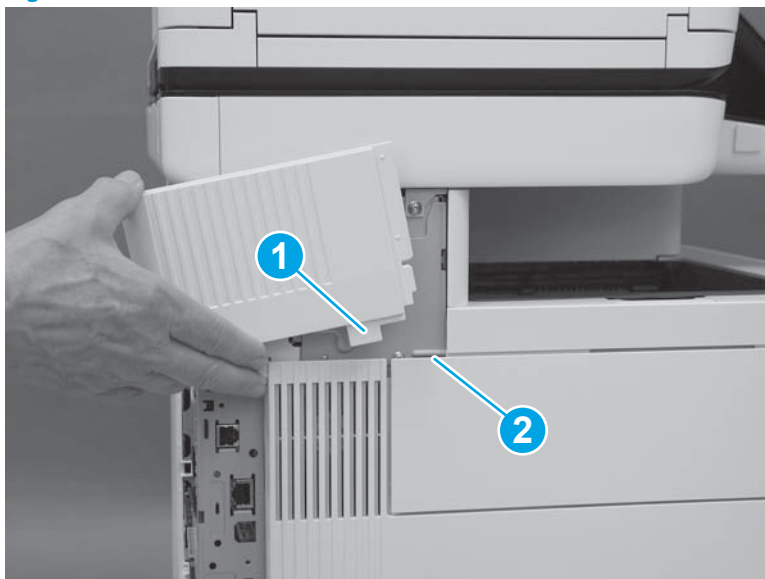

2. Slide the cover toward the front of the printer to install it. Make sure that the edge (callout 1) of the cover fits behind the edge (callout 2) of the top rear cover.

Figure 1-3317 Slide the cover

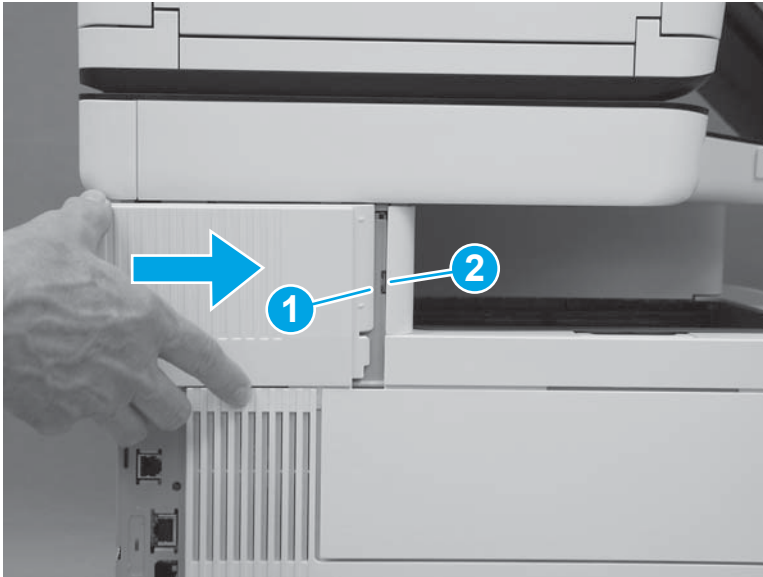

3. Make sure that the tab (callout 1) is fully installed.

Figure 1-3318 Check the tab

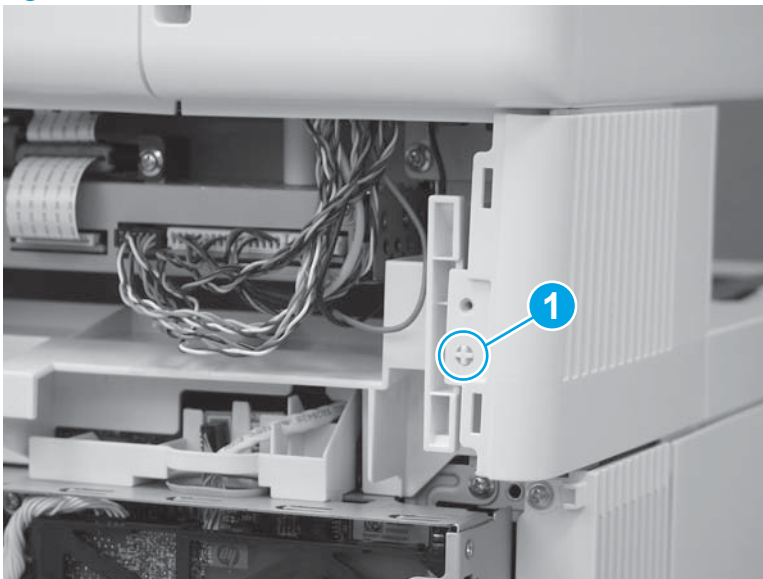

Step 49: Install the rear cover (M577)



NOTE: This step is for the M577 models. For the M552 and M553 models, skip this step and go to [Step 51: Install the rear cover \(M552 and M553\) on page 1870](#).

1. Position the hooks (callout 1) on the cover in the slots (callout 2) in the printer.

Figure 1-3319 Position the hooks

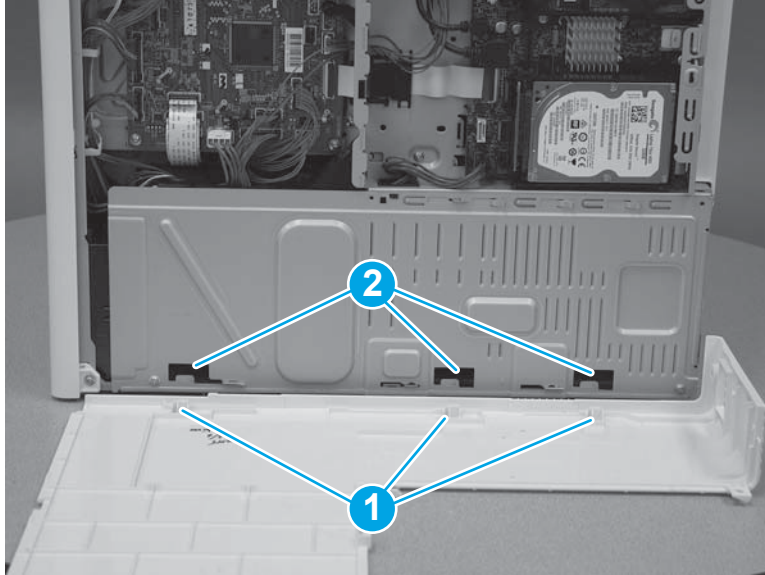

2. Position the back edge (callout 1) of the rear cover behind the edge (callout 2) of the right rear cover. Slide the cover to the left to install it.

Figure 1-3320 Install the cover

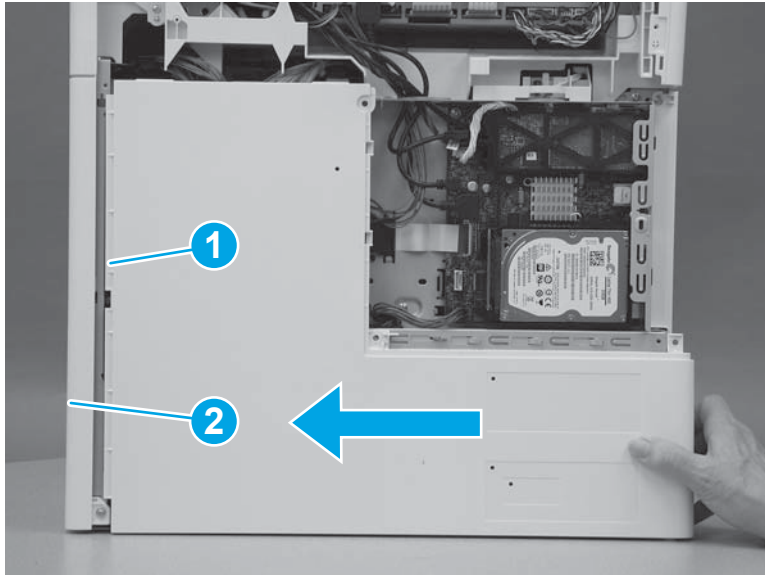

3. Install four screws (callout 1).

Figure 1-3321 Install four screws cover

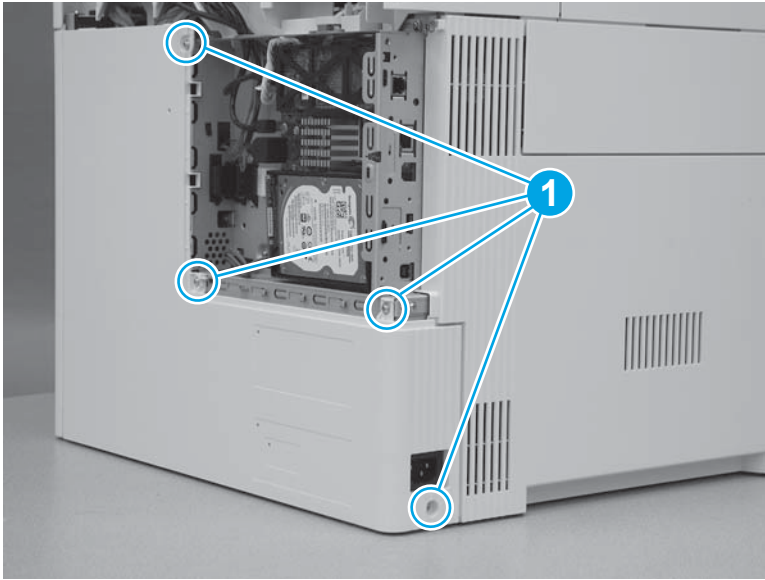

Step 50: Install the rear upper cover (M577)



NOTE: This step is for the M577 models. For the M552 and M553 models, skip this step and go to [Step 51: Install the rear cover \(M552 and M553\) on page 1870](#).

1. Align the ridge (callout 1) on the lower edge of the rear upper cover in front of the tabs (callout 2) on the top edge of the rear cover.

Figure 1-3322 Align the cover

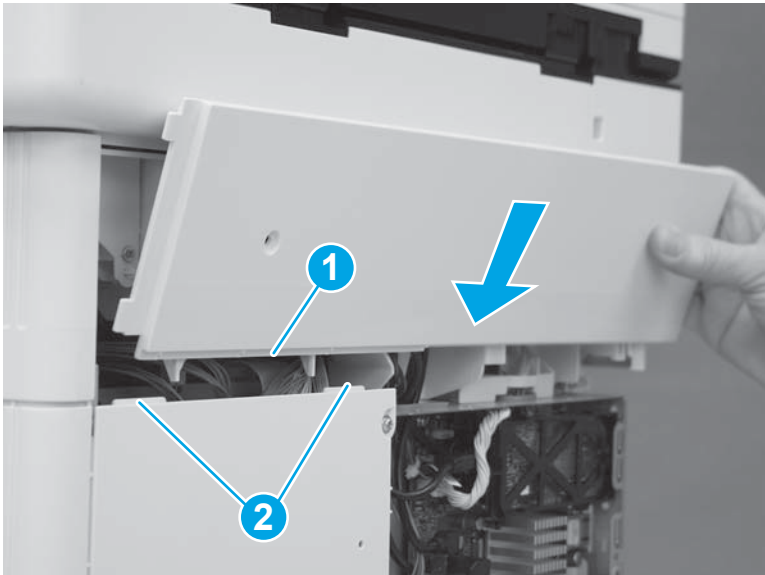

2. Rotate the top of the cover toward the printer.

Figure 1-3323 Rotate the top of the cover

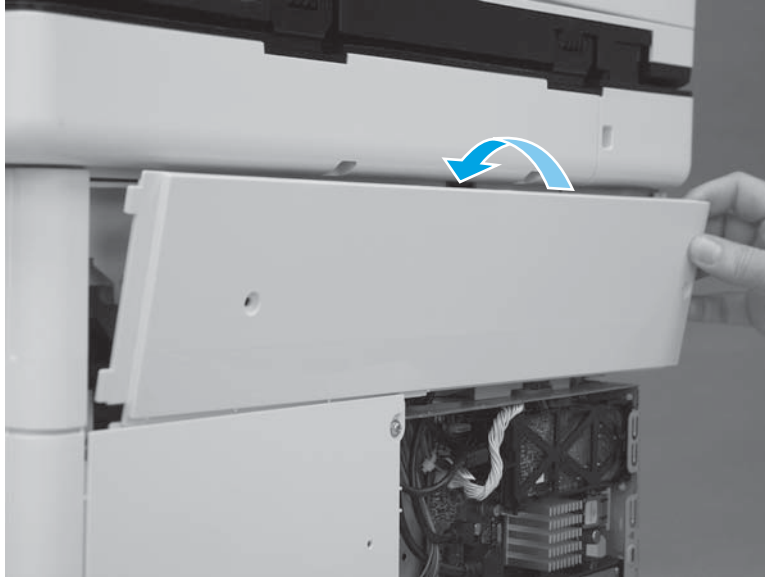

3. Slide the cover to the left (callout 1). Make sure that the tabs (callout 2) on the upper rear cover slide behind the edge (callout 3) of the right upper cover. Make sure that the cover is fully seated.

Figure 1-3324 Slide the cover

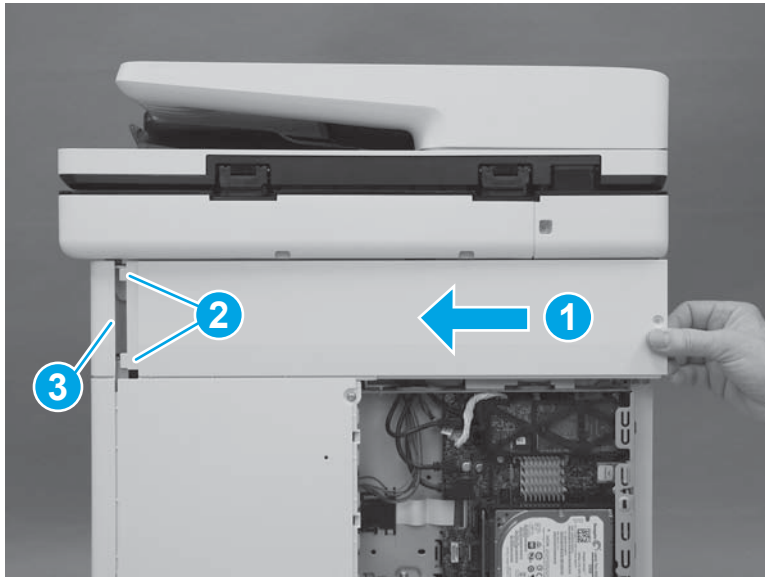

4. Install two screws (callout 1).

 **IMPORTANT:** These two screws are self-tapping screws for plastic. Rotate them counterclockwise to align them with the existing thread pattern, and then carefully turn them clockwise to tighten. Do not overtighten. This will prevent stripping the threads inside the screw holes.

Figure 1-3325 Install two screws



Step 51: Install the rear cover (M552 and M553)

 **NOTE:** This step is for the M552 and M553 models. For the M577 models, skip this step and go to [Step 52: Install the formatter \(M577\) on page 1871](#).

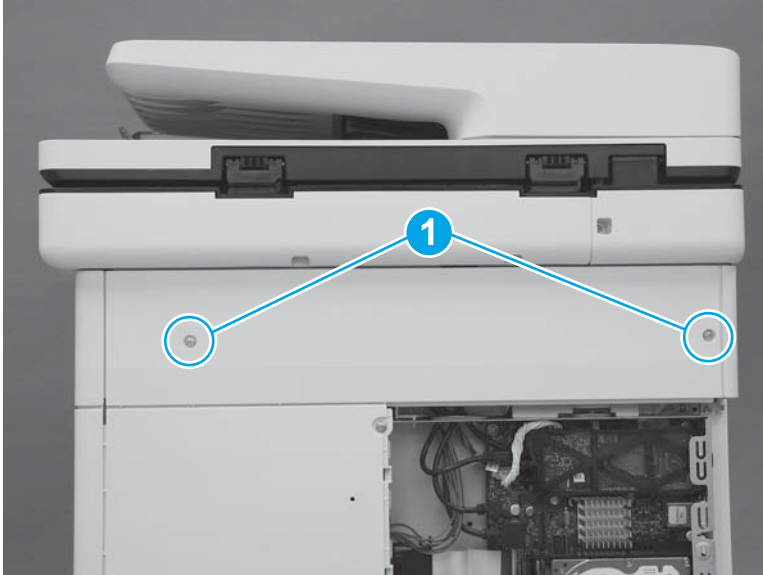
1. Position the top of the cover under the upper cover (callout 1), rotate the bottom of the cover onto the chassis (callout 2), and then slide the cover to the left (callout 3) to install it.

Figure 1-3326 Install the cover

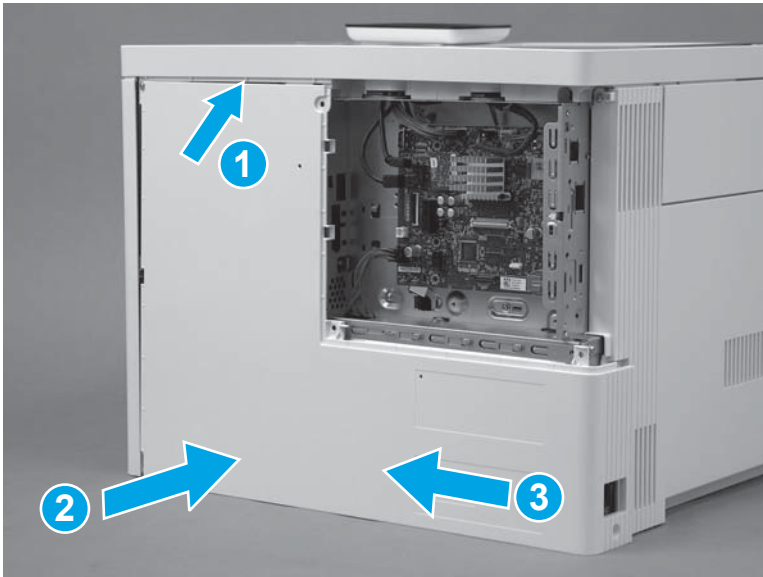

2. Install four screws (callout 1).

Figure 1-3327 Install four screws cover

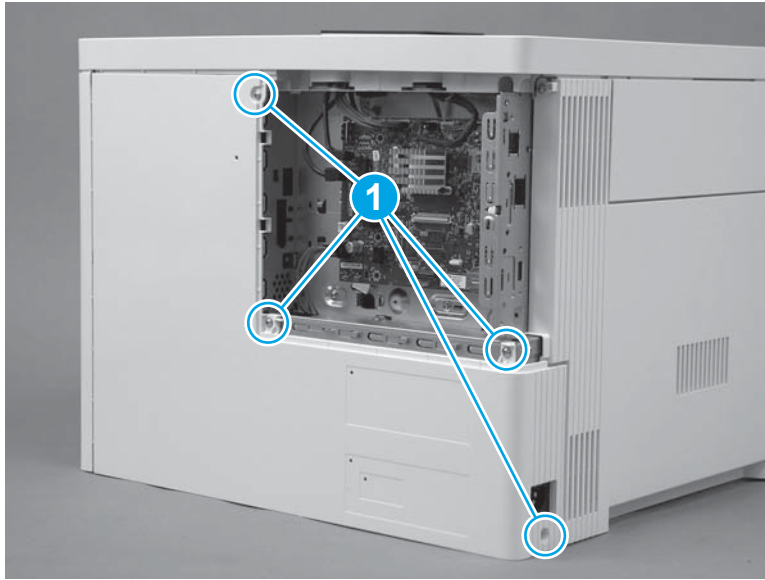

Step 52: Install the formatter (M577)

 **NOTE:** This step is for the M577 models. For the M552 and M553 models, skip this step and to go [Step 55: Install the formatter \(M552 and M553\)](#) on page 1876.

 **CAUTION:**  ESD-sensitive part.

1. Position the formatter in the printer. Make sure that the network port (callout 1) fits through the opening (callout 2) in the formatter case.

Figure 1-3328 Install the formatter

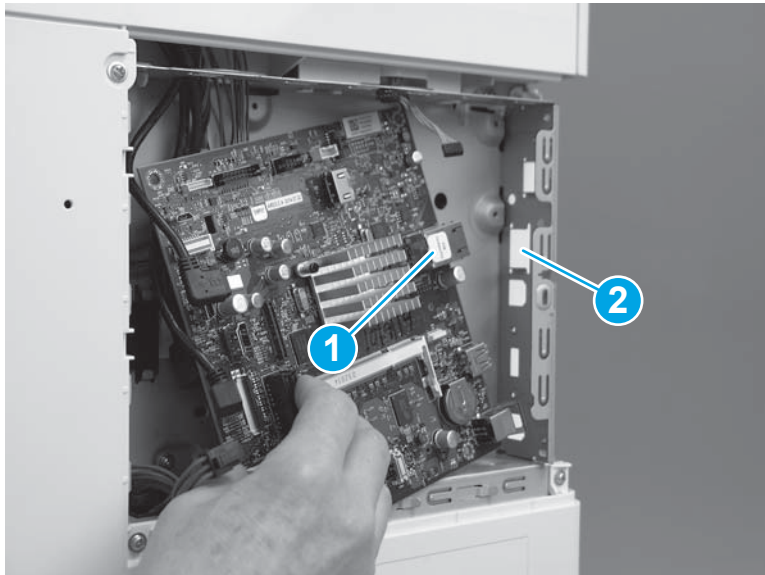

2. Install four screws (callout 1).

Figure 1-3329 Install four screws

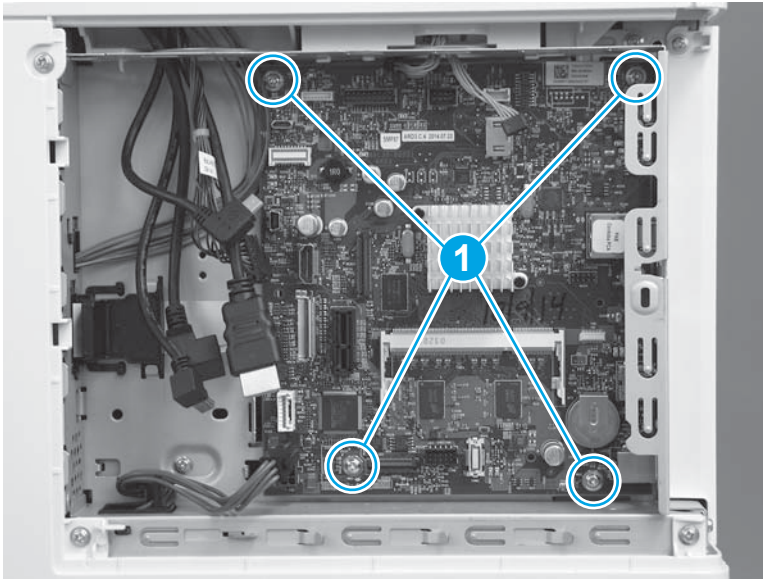

3. Connect all of the connectors on the formatter.

The following connectors are empty:

- All models: J1 (this connector is empty unless the optional DIMM is installed)
- All models: J3
- M577dn: J15 (this is the fax connector for the M577f/z/c models)
- All models: J21 (this connector is empty unless the optional internal USB ports component is installed)
- All models: J23
- All models: J24
- All models: J51
- All models: J57
- All models: J97
- All models: J98 (this connector is empty unless the optional trusted platform module (TPM) is installed)

 **IMPORTANT:** The flat-cable connector (callout 1) is a Zero Insertion Force (ZIF) connector that uses a hinged retainer to secure the flat cable. The hinged retainer must be opened to install the flat cable, and then closed after the cable is installed.

Figure 1-3330 Connect all connectors



Step 53: Install the fax PCA (M577c/f/z)

 **NOTE:** This step is for the M577c/f/z models. For the M577n model, skip this step and go to [Step 54: Install the HDD \(M577\)](#) on page 1874.

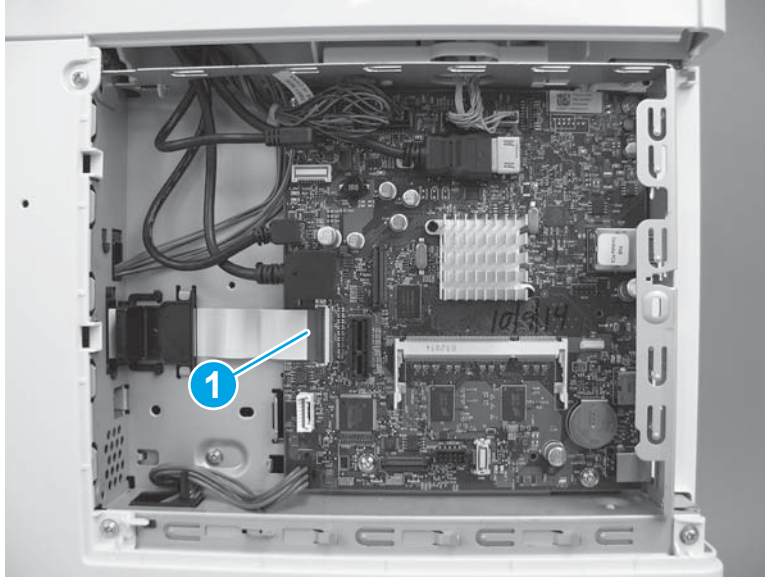
For the M552 and M553 models, skip this step and go to [Step 55: Install the formatter \(M552 and M553\)](#) on page 1876.

 **CAUTION:**  ESD-sensitive part.

1. Position the tab and telephone port (callout 1) on the fax PCA in the slots (callout 2) in the formatter case.

Figure 1-3331 Position the fax PCA

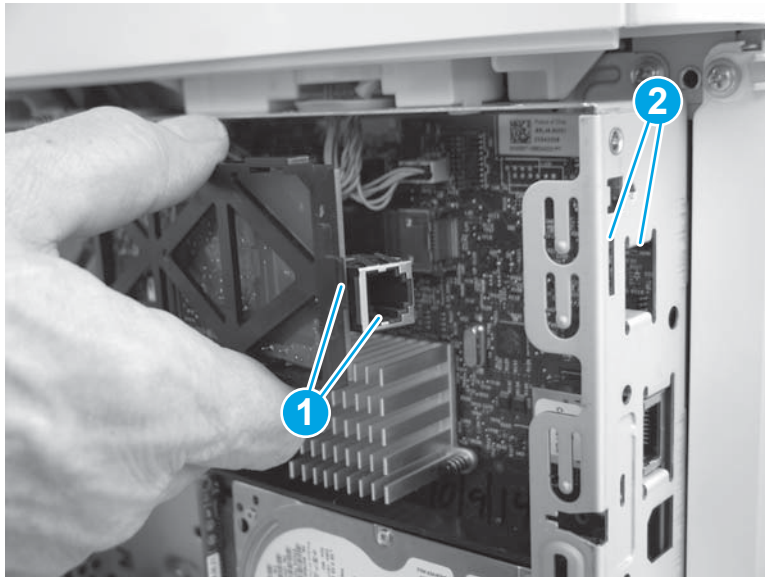

2. Slide the fax PCA to the right (callout 1) until the tab and telephone port described in the previous step and seated in the formatter case. Position the retainer (callout 2) in the slot (callout 3) in the formatter. Rotate the end of the fax PCA toward the formatter (callout 4) until the retainer snaps into place.

Figure 1-3332 Install the fax PCA

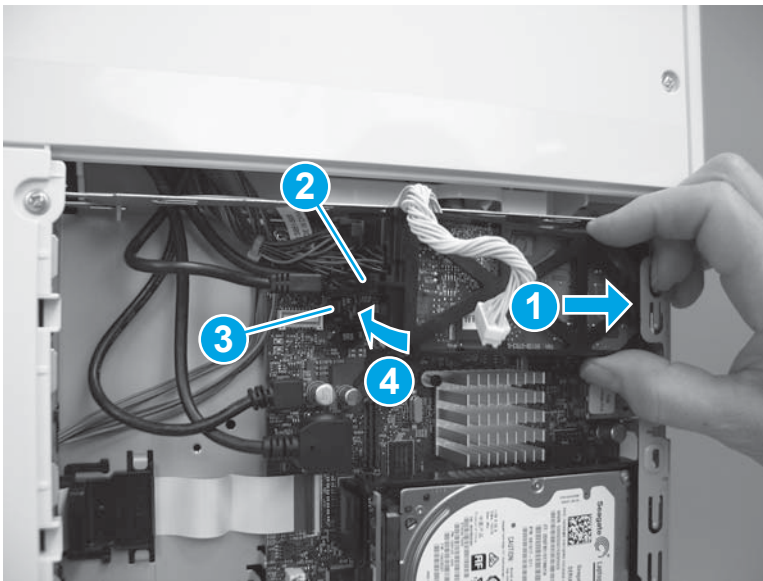

3. Position the cable (callout 1) in the guide (callout 2), and then connect one connector (callout 3).

Figure 1-3333 Connect the connector

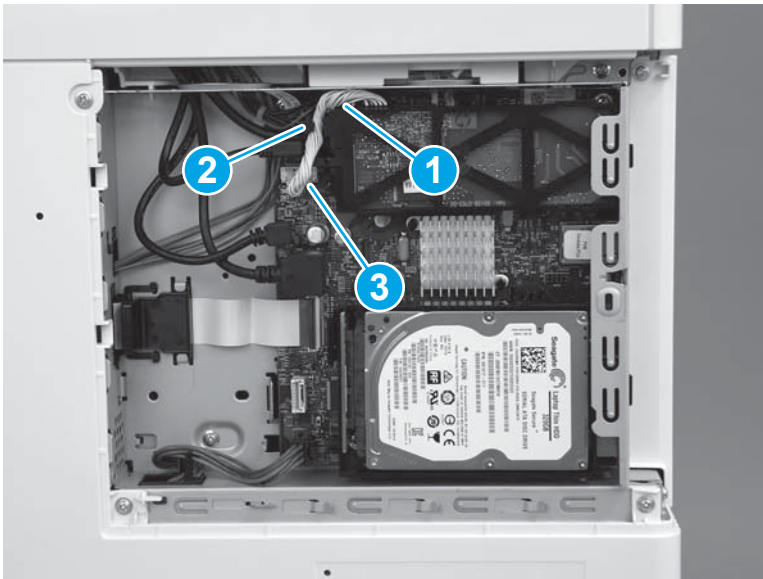

Step 54: Install the HDD (M577)



NOTE: This step is for the M577 models. For the M552 and M553 models, skip this step and go to [Step 55: Install the formatter \(M552 and M553\) on page 1876](#).

 **CAUTION:**  ESD-sensitive part.

1. Align the end of the bracket (callout 1) with the slot in the chassis (callout 2), and then slide the HDD into the printer (callout 3) to engage the bracket with the chassis.

Figure 1-3334 Install the holder

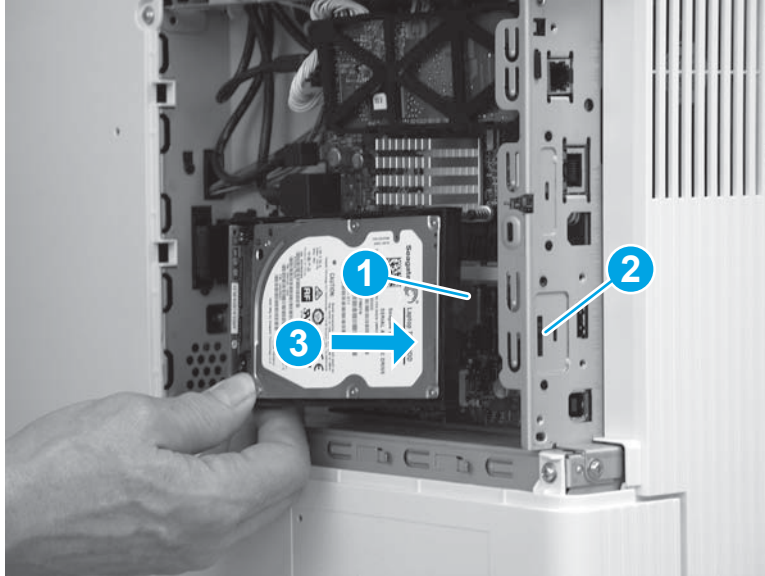

2. Hold the HDD connector latch (callout 1) in the released position, and then rotate the HDD down and into the connector on the formatter to install it.

 **NOTE:** Make sure that the tab (callout 2) snaps into place, and that the HDD is securely installed.

Figure 1-3335 Release the HDD

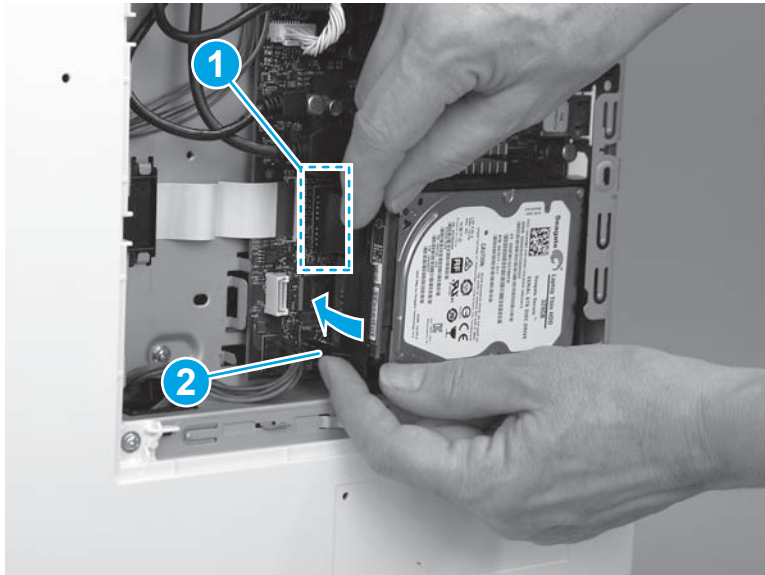

Step 55: Install the formatter (M552 and M553)

 **NOTE:** This step is for the M552 and M553 models. For the M577 models, skip this step and go to [Step 56: Install the formatter cover on page 1877](#).

If the optional hard-disk drive (HDD) was removed, do not forget to reinstall it after the formatter is reinstalled.

Engage the HDD holder with the chassis, rotate the HDD connector down and into the connector on the formatter. Make sure that the tabs snap into place.

 **CAUTION:**  ESD-sensitive part.

1. Position the formatter in the printer, and then install four screws (callout 1).

Figure 1-3336 Install the formatter

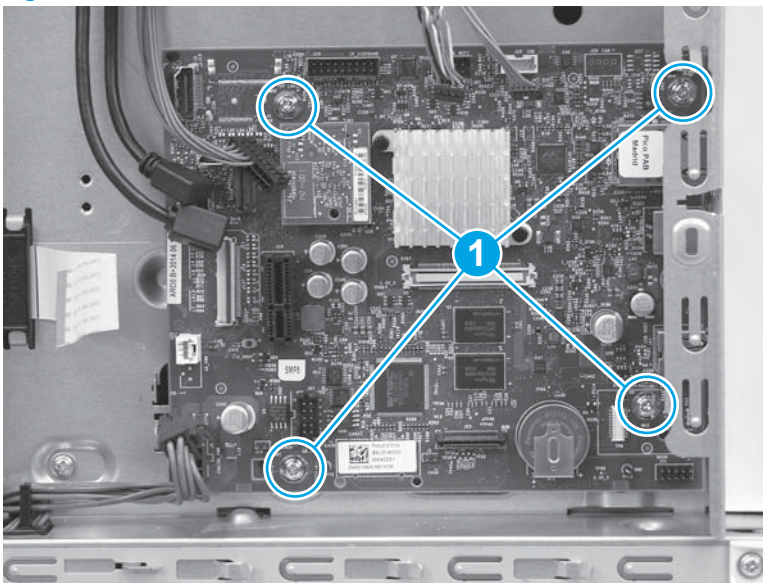

2. Connect all of the connectors on the formatter.

The following connectors are empty:

- All models: J1 (this connector is empty unless the optional DIMM is installed)
- M553n/dn and M552dn: J2 (callout 1; this is the touchscreen connector for the M553x model)
- All models: J9 (this connector is empty unless the optional internal USB ports component is installed)
- All models: J18 (this connector is empty unless the optional hard-disk-drive (HDD) is installed)
- All models: J23
- All models: J24
- M553n/dn and M552dn: J25 (this is the wireless connector for the M553x model)

- All models: J57
- All models: J98 (this connector is empty unless the optional trusted platform module (TPM) is installed)



 **IMPORTANT:** The flat-cable connector (callout 2) is a Zero Insertion Force (ZIF) connector that uses a hinged retainer to secure the flat cable. The hinged retainer must be opened to install the flat cable.

Figure 1-3337 Connect all connectors

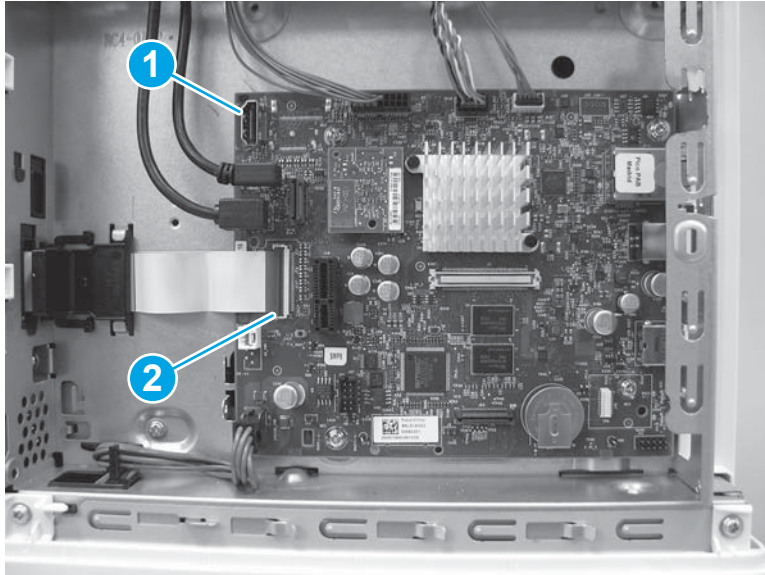

Step 56: Install the formatter cover

- ▲ Slide the cover onto the printer (callout 1) to install it.

 **NOTE:** Make sure that the tabs on the formatter cover align with the slots provided in the printer (callout 2). Tighten the two thumbscrews (callout 3).

 **TIP:** If needed, use the edge of a coin to turn the thumbscrews.

Figure 1-3338 Install the cover



Step 57: Install the TCU

1. Verify that the toner collection hatch cover is in the closed position on the TCU.

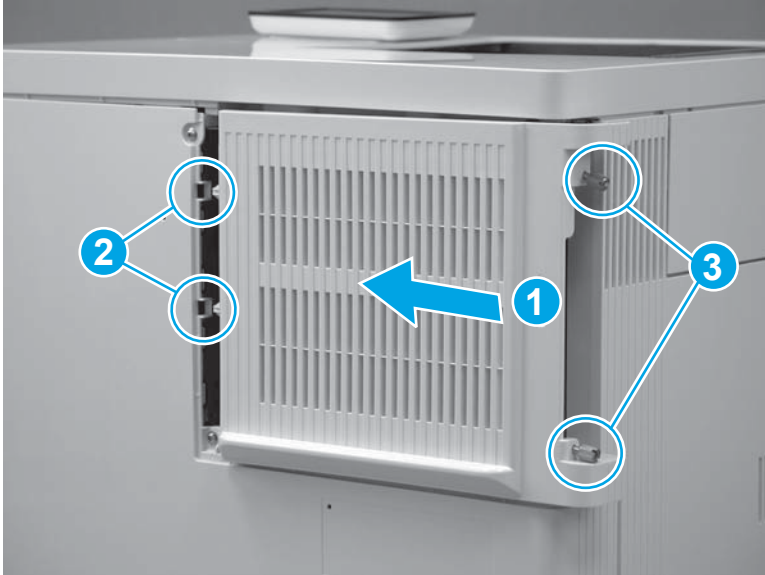
Figure 1-3339 Verify that the toner collection hatch cover is closed

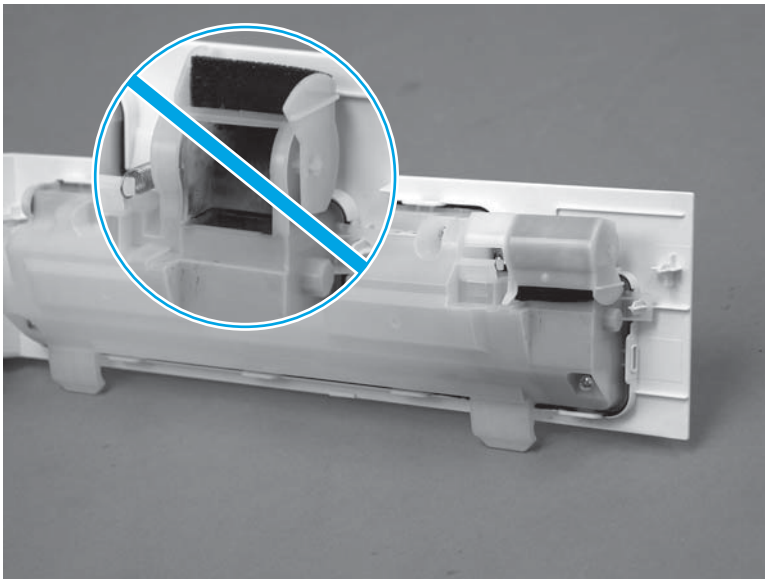

2. Position the TCU with the hinges in the slots provided in the printer (callout 1), and then rotate the TCU up and into the closed position.

 **NOTE:** The toner collection hatch cover automatically opens when the TCU is closed.

Figure 1-3340 Install the TCU



3. Close the front door.

Figure 1-3341 Close the front door

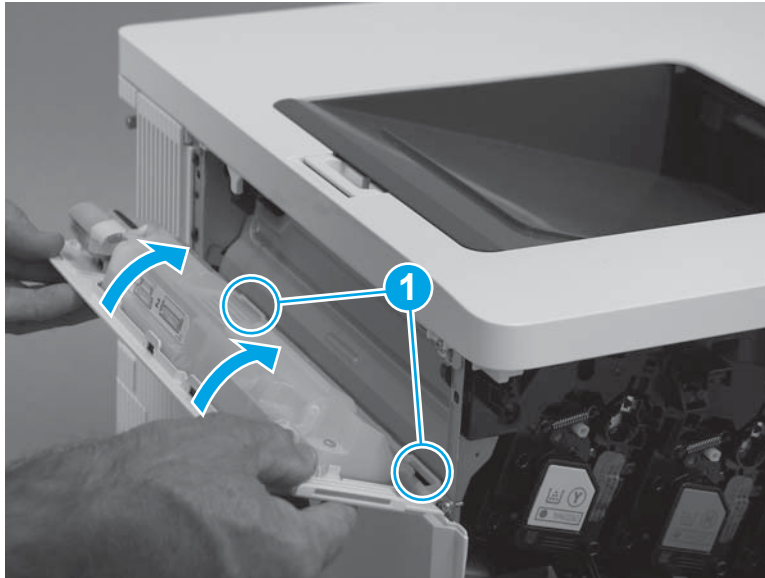

Step 58: Install the tray

1. With the front of the tray slightly lifted, align the sides of the tray with the rails in the printer, and then carefully slide the tray into the printer.

 **TIP:** As the tray slides into the printer, lower the front of it.

Figure 1-3342 Install the tray



2. Close the tray.

Figure 1-3343 Close the tray



Step 59: Install the control-panel assembly (M553x only)

 **NOTE:** For the M553n/dn and M552dn models, skip this step and go to [Step 61: Install the USB cover \(M552 and M553\) on page 1885](#).

For the M577 models, skip this step.

1. Place the control panel on the printer as shown.

Figure 1-3344 Place the control panel on the product

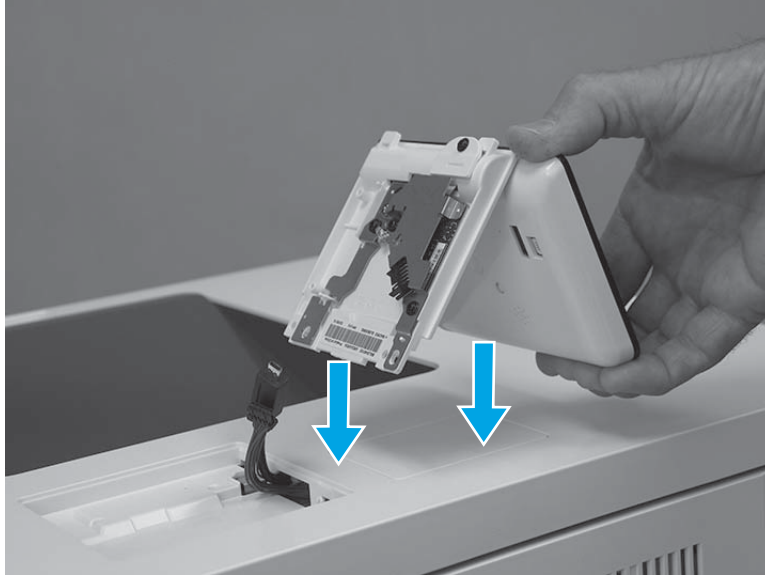

2. Connect one USB cable (callout 1), and one connector (callout 2).

 **IMPORTANT:** Take note of the location of the two mounting tabs (callout 3) on the control-panel assembly.

Figure 1-3345 Connect two connectors



3. Turn the control panel over, and then position the front edge tabs in the slots in the top cover.

Figure 1-3346 Turn the control panel over

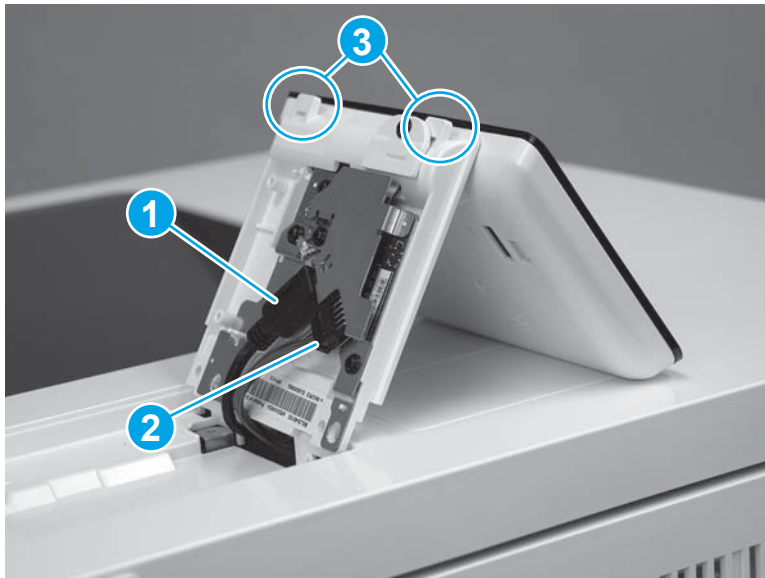
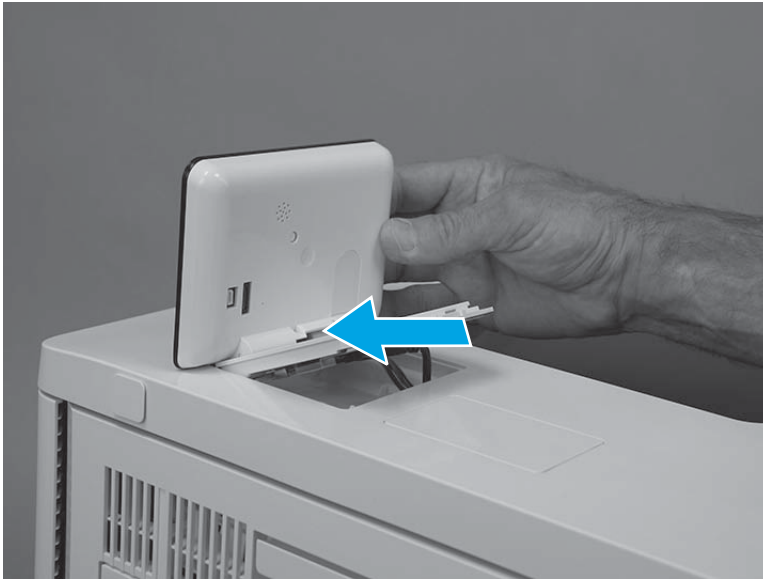

4. Rotate the control-panel base down onto the printer.

Figure 1-3347 Rotate the control-panel base down



5. Use a small Phillips screwdriver to install two screws (callout 1).

Figure 1-3348 Install two screws

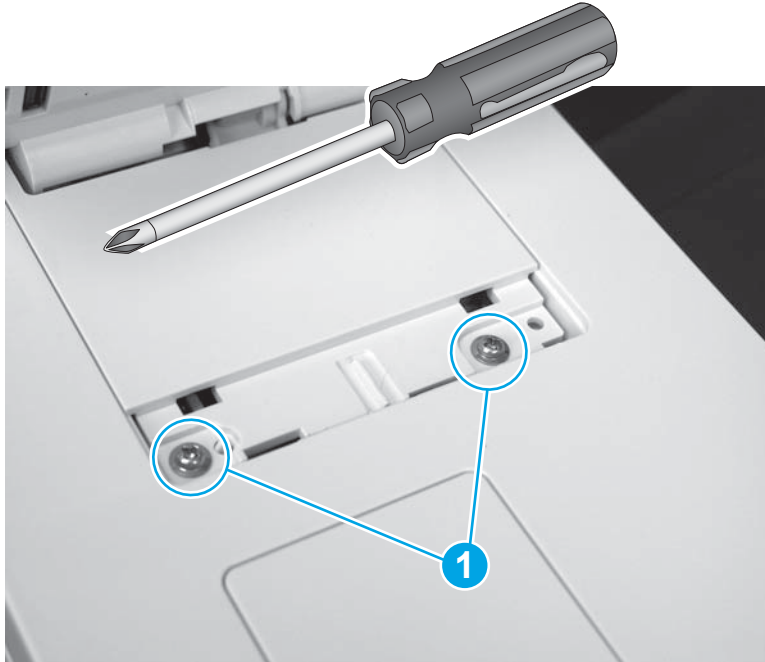

6. Position the screw cover mounting feet into the slots in the top cover (callout 1), and then rotate the cover down (callout 2) to install it.

 **NOTE:** Press down on the cover firmly to make sure that the tabs on the cover (callout 3) snap into place.

Figure 1-3349 Install the cover



Step 60: Install the fuser

1. Align the fuser with the opening in the printer.

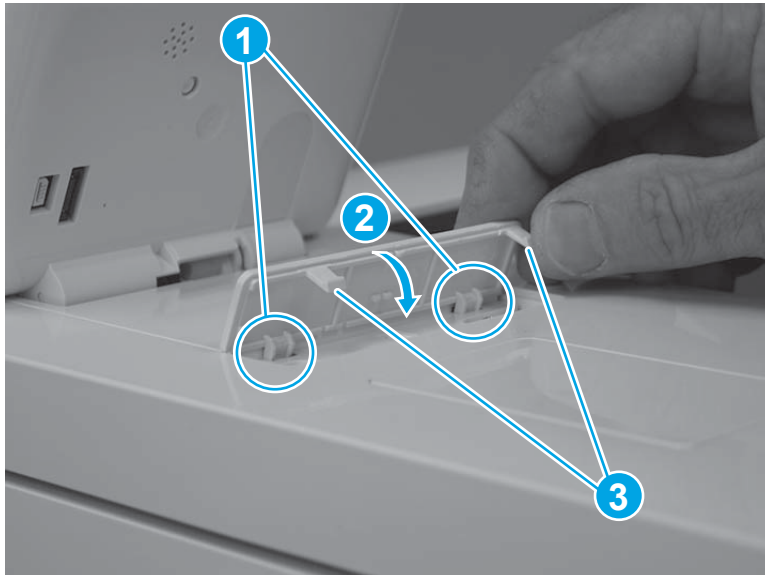
Figure 1-3350 Align the fuser with the opening

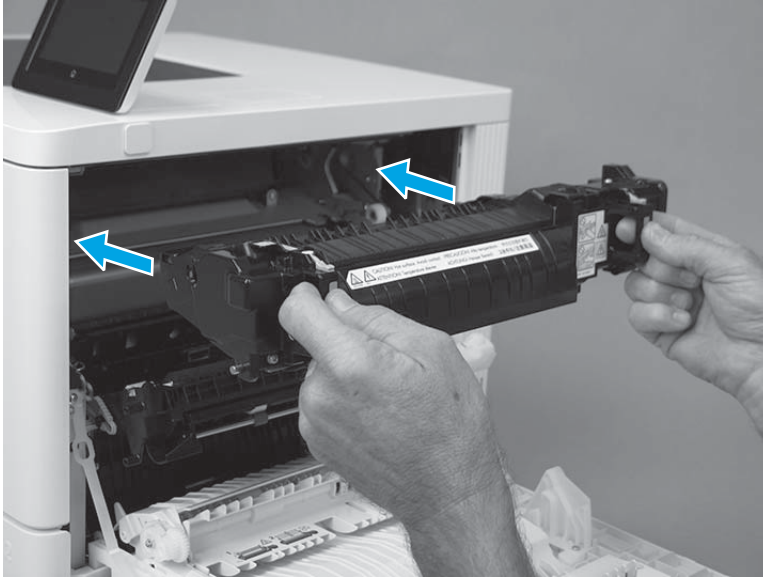

2. Slide the fuser into the printer, push in to install it, and then make sure that it is fully seated.

 **TIP:** When the fuser is fully seated, the two blue triggers on the handles make an audible click.

Figure 1-3351 Install the fuser



3. Close the right door.

Figure 1-3352 Close the right door

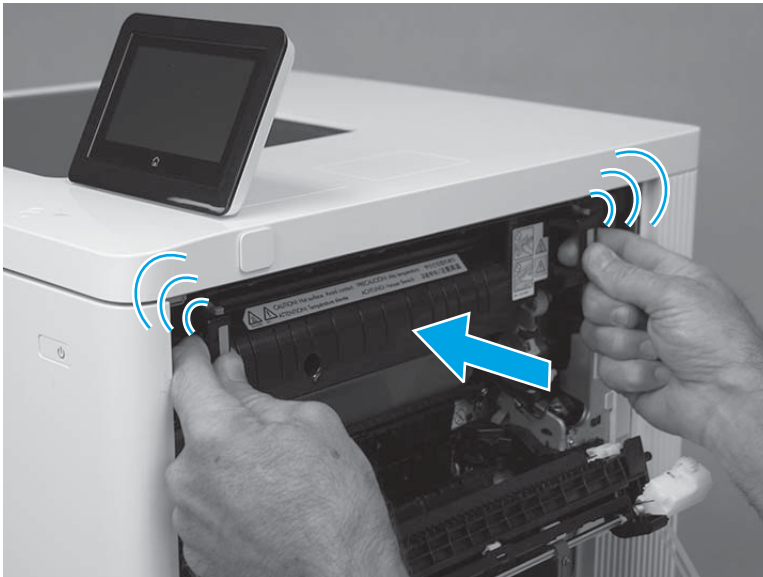

Step 61: Install the USB cover (M552 and M553)

 **NOTE:** This step is for the M552 and M553 models. For the M577 models, skip this step.

1. Push the cover into the USB port to install it.

Figure 1-3353 Install the cover



2. Make sure that the USB cover is fully seated after installing it.

Figure 1-3354 Check the installation

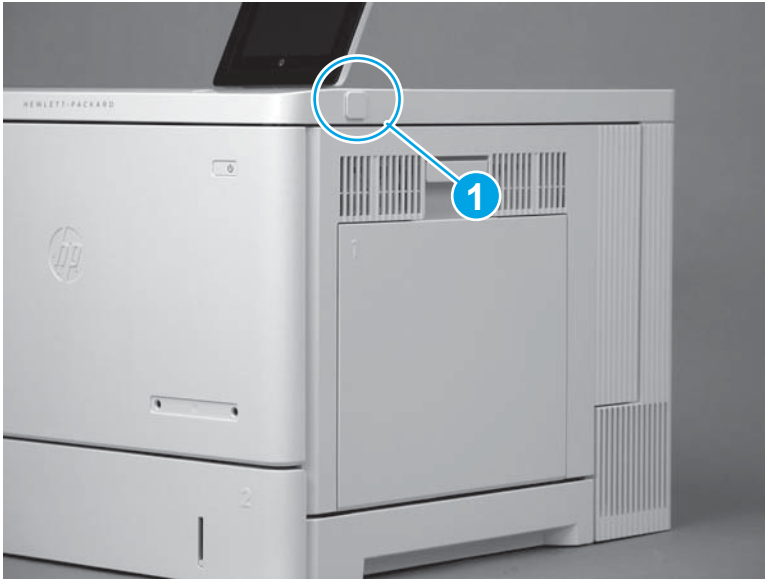

Removal and replacement: Duplex drive assembly and motor

- [Introduction](#)
- [Step 1: Remove the fuser](#)
- [Step 2: Remove the ITB](#)
- [Step 3: Remove the USB cover \(M552 and M553\)](#)
- [Step 4: Remove the control panel \(M553x only\)](#)
- [Step 5: Remove the tray](#)
- [Step 6: Remove the toner collection unit \(TCU\)](#)
- [Step 7: Remove the formatter cover](#)
- [Step 8: Remove the formatter \(M552 and M553\)](#)
- [Step 9: Remove the hard-disk drive \(HDD\) \(M577\)](#)
- [Step 10: Remove the fax PCA \(M577c/f/z\)](#)
- [Step 11: Remove the formatter \(M577\)](#)
- [Step 12: Remove the rear cover \(M552 and M553\)](#)
- [Step 13: Remove the rear upper cover \(M577\)](#)
- [Step 14: Remove the rear cover \(M577\)](#)
- [Step 15: Remove the left upper cover \(M577\)](#)
- [Step 16: Remove the right front upper cover \(M577dn\)](#)
- [Step 17: Remove the stapler cover assembly \(M577c/f/z\)](#)
- [Step 18: Remove the integrated scanner assembly \(ISA\) \(M577\)](#)
- [Step 19: Remove the stapler unit \(M577c/f/z\)](#)
- [Step 20: Remove the right upper cover \(M577\)](#)
- [Step 21: Remove the top rear cover \(M577\)](#)
- [Step 22: Remove the paper feed cover \(M577\)](#)
- [Step 23: Remove the top cover \(M577\)](#)
- [Step 24: Remove the top bracket \(M577\)](#)
- [Step 25: Remove the left cover](#)
- [Step 26: Remove the upper cover \(M552 and M553\)](#)
- [Step 27: Remove the control panel \(M553n/dn and M552dn only\)](#)
- [Step 28: Remove the output bin](#)
- [Step 29: Remove the formatter case](#)

- [Step 30: Remove the right rear cover](#)
- [Step 31: Remove the DC controller and sheet-metal bracket](#)
- [Step 32: Remove the high-voltage power supply T \(HVPST\)](#)
- [Step 33: Remove the fuser drive assembly](#)
- [Step 34: Remove the delivery assembly](#)
- [Step 35: Remove the duplex drive assembly and motor](#)
- [Step 36: Unpack the replacement assembly](#)
- [Step 37: Install the duplex drive assembly and motor](#)
- [Step 38: Install the delivery assembly](#)
- [Step 39: Install the fuser drive assembly](#)
- [Step 40: Install the HVPST](#)
- [Step 41: Install the DC controller and sheet-metal bracket](#)
- [Step 42: Install the right rear cover](#)
- [Step 43: Install the formatter case](#)
- [Step 44: Install the output bin](#)
- [Step 45: Install the control panel \(M553n/dn and M552dn only\)](#)
- [Step 46: Install the upper cover \(M552 and M553\)](#)
- [Step 47: Install the left cover](#)
- [Step 48: Install the top bracket \(M577\)](#)
- [Step 49: Install the top cover \(M577\)](#)
- [Step 50: Install the paper feed cover \(M577\)](#)
- [Step 51: Install the top rear cover \(M577\)](#)
- [Step 52: Install the right upper cover \(M577\)](#)
- [Step 53: Install the stapler unit \(M577c/f/z\)](#)
- [Step 54: Install the integrated scanner assembly \(ISA\) \(M577\)](#)
- [Step 55: Install the stapler cover assembly \(M577c/f/z\)](#)
- [Step 56: Install the right front upper cover \(M577dn\)](#)
- [Step 57: Install the left upper cover \(M577\)](#)
- [Step 58: Install the rear cover \(M577\)](#)
- [Step 59: Install the rear upper cover \(M577\)](#)
- [Step 60: Install the rear cover \(M552 and M553\)](#)

- [Step 61: Install the formatter \(M577\)](#)
- [Step 62: Install the fax PCA \(M577c/f/z\)](#)
- [Step 63: Install the HDD \(M577\)](#)
- [Step 64: Install the formatter \(M552 and M553\)](#)
- [Step 65: Install the formatter cover](#)
- [Step 66: Install the TCU](#)
- [Step 67: Install the tray](#)
- [Step 68: Install the control-panel assembly \(M553x only\)](#)
- [Step 69: Install the USB cover \(M552 and M553\)](#)
- [Step 70: Install the ITB](#)
- [Step 71: Install the fuser](#)

Introduction

This document provides the procedures to remove and replace the duplex drive assembly.



NOTE: The duplex drive assembly includes the duplex-drive motor (M8).

Before performing service



TIP: Some figures might show assemblies removed or installed that have not yet been removed or installed at that specific step. However, the procedures are correct for this printer and the target assembly. Always thoroughly read the instructions that accompany each figure.

Turn the printer power off

- Disconnect the power cable.



WARNING! To avoid damage to the printer, turn the printer off, wait 30 seconds, and then remove the power cord before attempting to service the printer.

Use the table below to identify the correct part number for your printer, and then go to <http://h20141.www2.hp.com/hpparts> to order the part.

Duplex drive assembly part number	
RM2-0006-000CN	Duplex drive assembly

Required tools

- #2 Phillips screwdriver with a magnetic tip

After performing service

Make sure that all of the connectors on the HVPST are fully seated.

Make sure that all of the connectors on the DC controller are fully seated.

Make sure that all of the connectors on the formatter are fully seated.

Make sure that the formatter cover is fully seated, and that the thumbscrews are finger tight after replacing it.

Turn the printer power on

- Connect the power cable.
- Use the power switch to turn the power on.

Post service test

Use the components test to test the (duplex) motor. For more information, see the printer troubleshooting manual.

Step 1: Remove the fuser

1. Open the right door.

CAUTION: The fuser is very hot. After turning the printer power off, allow the fuser to cool for at least 30 minutes before removing it.

Figure 1-3355 Open the right door



2. Grasp the two fuser handles, and then squeeze the two blue triggers on the handles to release the fuser.

Figure 1-3356 Release the fuser

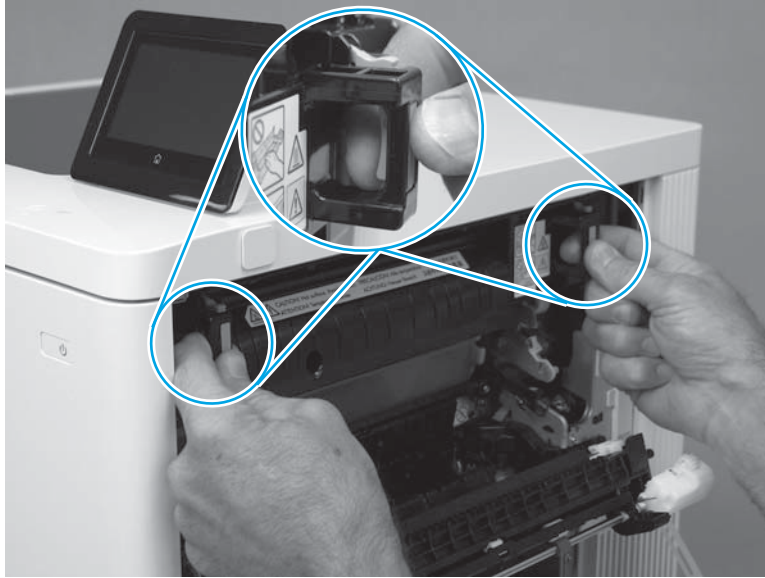

3. Slide the fuser straight out of the printer to remove it.

Figure 1-3357 Remove the fuser



Step 2: Remove the ITB

CAUTION: Do not touch the grey-plastic belt. Skin oils and fingerprints on the belt can cause print-quality problems.

1. Open the right door.

Figure 1-3358 Open the right door



2. Pull the blue lever to release the ITB drive coupling.

Figure 1-3359 Release the ITB drive coupling

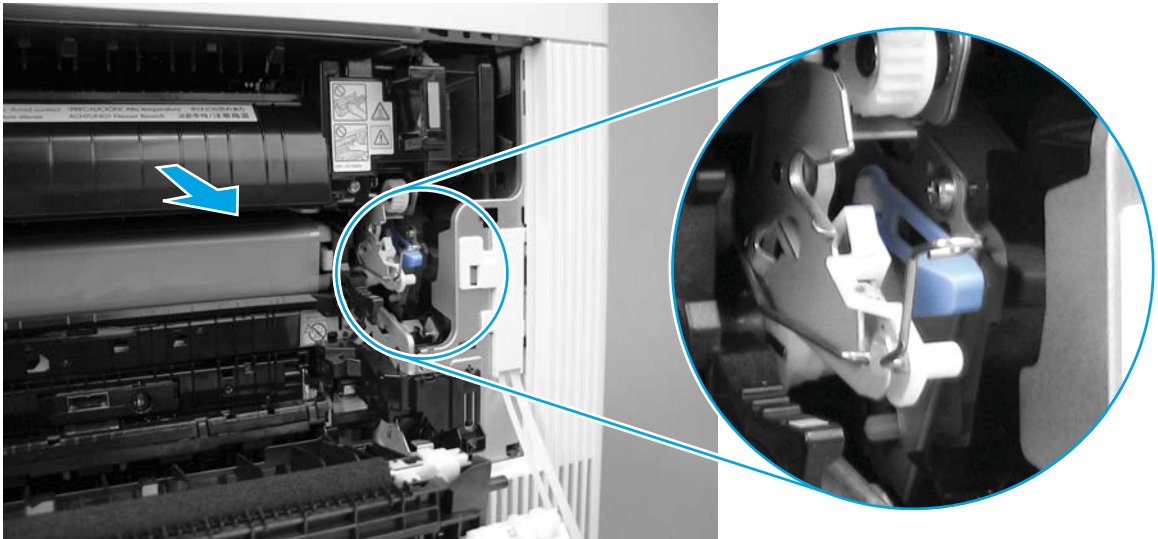

3. Push in on the blue arm to release the secondary transfer roller assembly, and then completely lower the assembly.

 **NOTE:** Press the blue arm on the secondary transfer roller assembly a second time to release the roller assembly when it stops at the halfway open position.

Figure 1-3360 Lower the secondary transfer roller assembly



4. Release the left-side ITB spring (callout 1) from the tab (callout 2).

Figure 1-3361 Release the front-side ITB spring

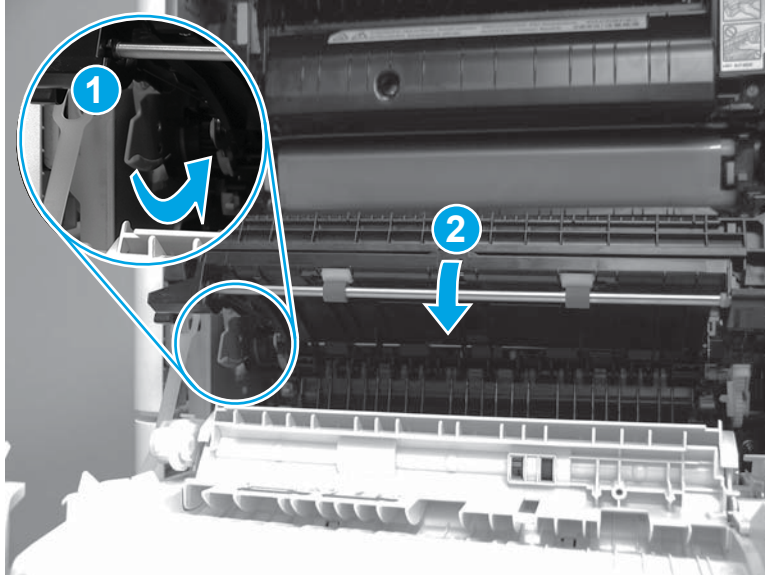
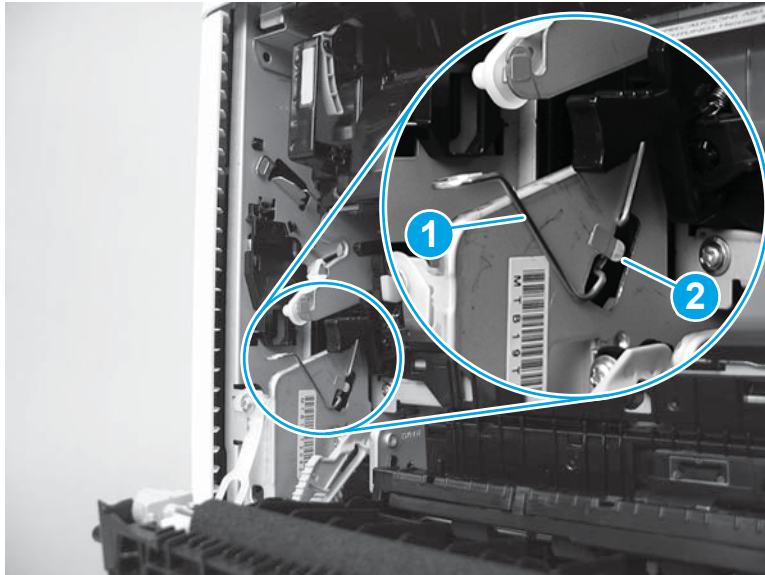

5. Place the left-side ITB spring on the holder to keep it out of the way.

 **TIP:** The holder is colored blue to help locate it.

Figure 1-3362 Place the spring on the holder

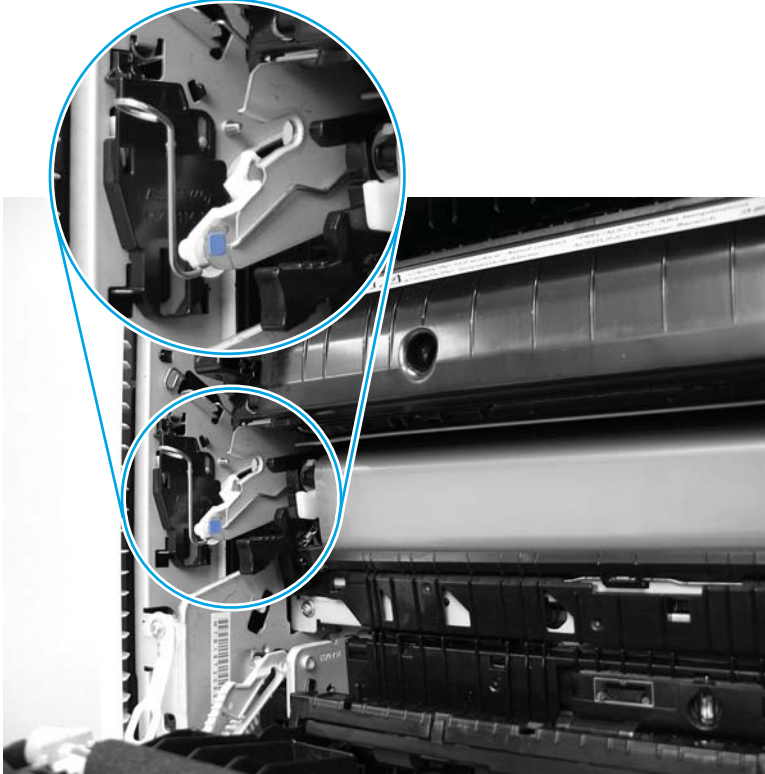

6. Release the right-side ITB spring (callout 1) from the tab (callout 2).

Figure 1-3363 Release the rear-side ITB spring

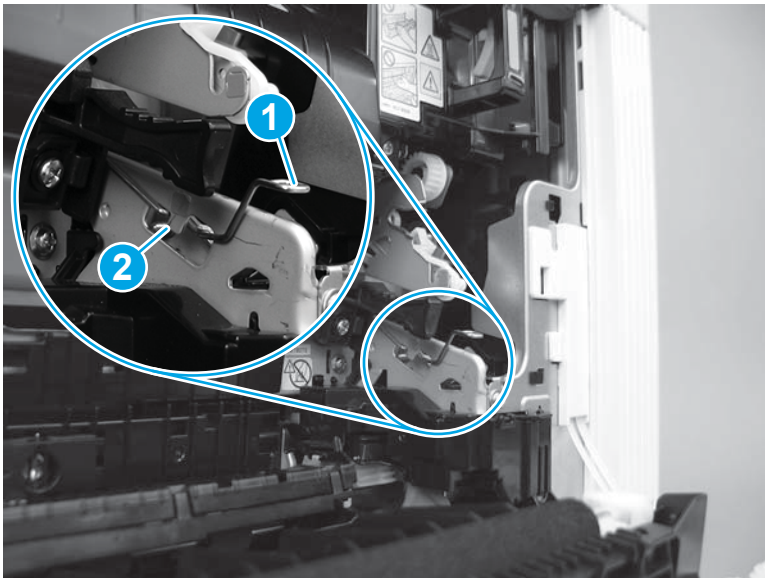

7. Place the right-side ITB spring on the holder to keep it out of the way.

 **TIP:** The holder is colored blue to help locate it.

Figure 1-3364 Place the spring on the holder

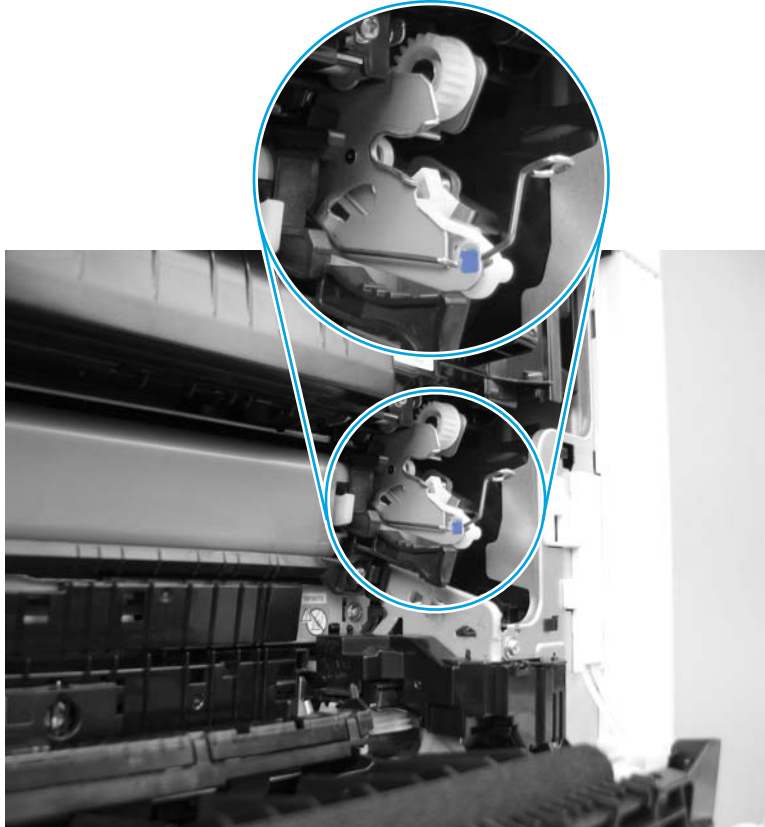

8. Grasp the two blue handles on the ITB.

⚠ CAUTION: If the ITB is removed to access other assemblies in the printer, use care. The ITB is a sensitive assembly. Be careful when handling the ITB so that it is not damaged. Always place the ITB in a safe and protected location.

Figure 1-3365 Grasp the ITB handles

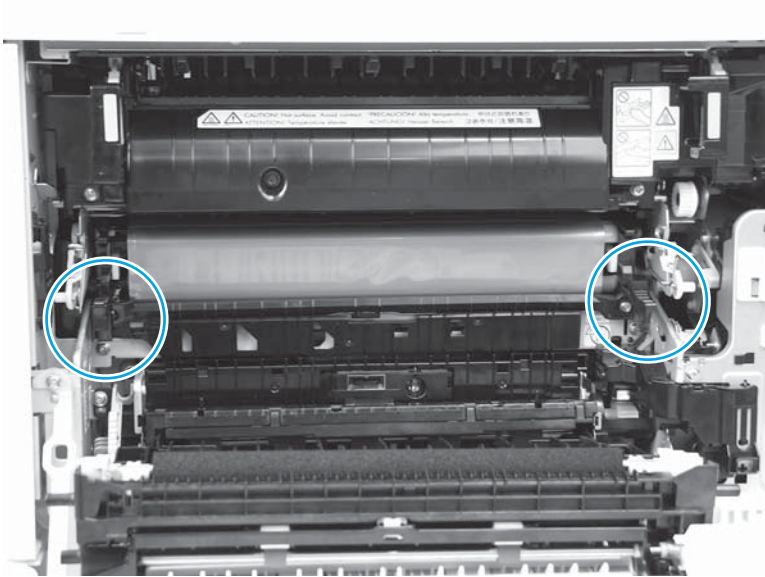

9. Pull the ITB out of the printer to remove it.

⚠ CAUTION: Do not touch the grey-plastic belt. Skin oils and fingerprints on the belt can cause print-quality problems.

Figure 1-3366 Remove the ITB

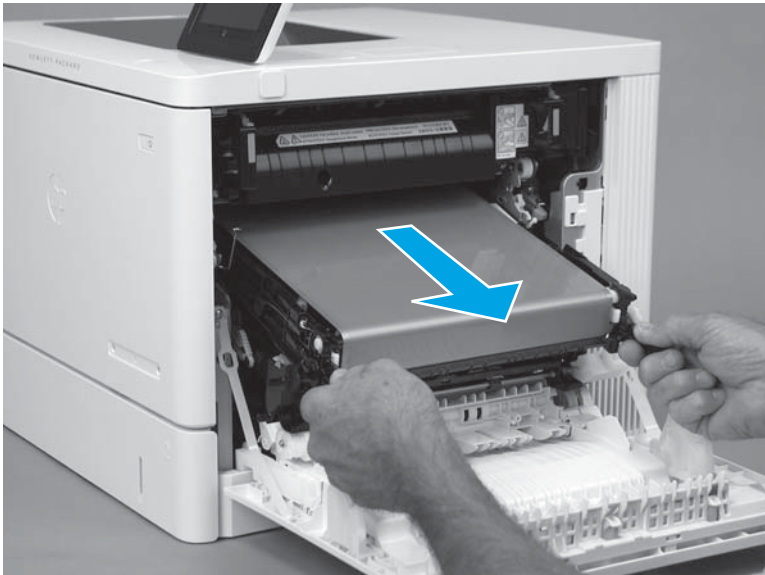

Step 3: Remove the USB cover (M552 and M553)

 **NOTE:** This step is for the M552 and M553 models. For the M577 models, skip this step and go to [Step 5: Remove the tray on page 1901](#).

1. Locate the USB cover.

Figure 1-3367 Locate the USB cover



2. Pull the cover off of the printer to remove it.

Figure 1-3368 Remove the cover



Step 4: Remove the control panel (M553x only)

 **NOTE:** This step is for the M553x model. For the M553n/dn, M552dn, and M577 models, skip this step and go to [Step 5: Remove the tray on page 1901](#).

1. Tilt the control panel up.

Figure 1-3369 Tilt the control panel up



2. Use a small flat-blade screwdriver to release the control-panel screws cover tabs.

Figure 1-3370 Release the control-panel screws cover tabs



3. Rotate the cover up to remove it.

Figure 1-3371 Remove the cover

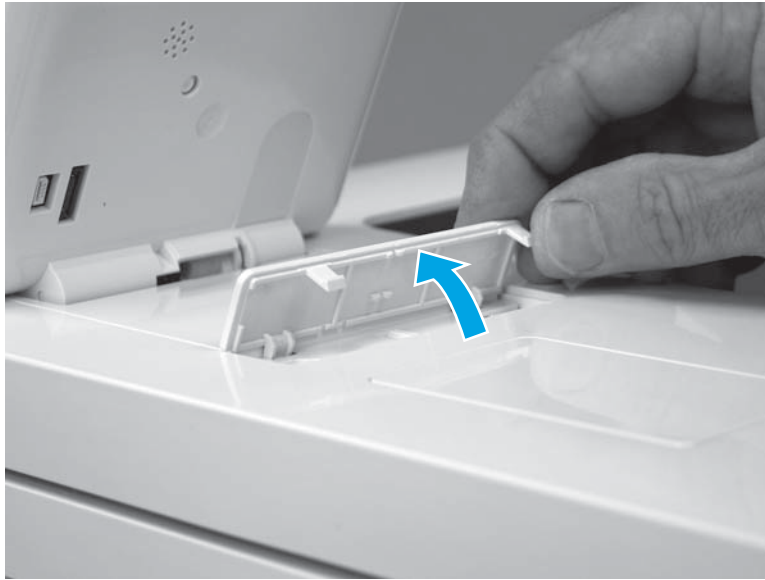

4. Use a small Phillips screwdriver to remove two screws (callout 1).

 **IMPORTANT:** Store the screws in a secure place where they cannot fall down into the printer.

Figure 1-3372 Remove two screws



5. Rotate the control-panel base toward the front of the printer.

Figure 1-3373 Rotate the control-panel base up

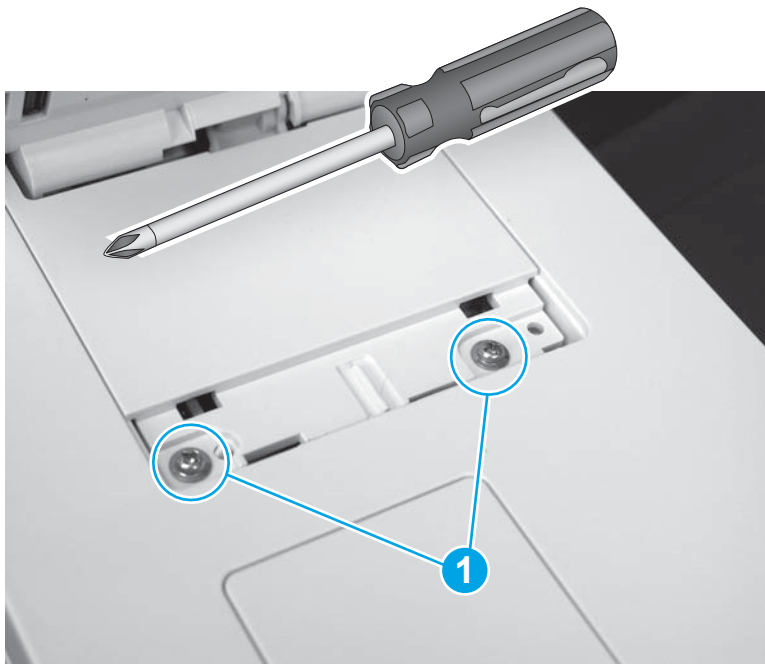

6. Slightly slide the control-panel base toward the rear of the printer (callout 1) to release it, and then turn the control panel over (callout 2) to access the bottom side.

CAUTION: The control panel is still attached to the printer. Do not attempt to completely remove the control panel.

Figure 1-3374 Turn the control panel over

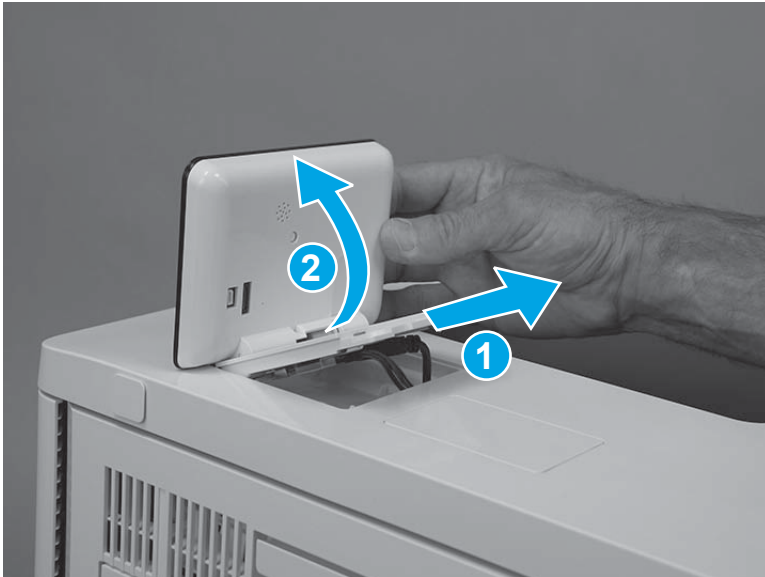

7. Disconnect one USB cable (callout 1), one connector (callout 2), and then remove the control panel.

Figure 1-3375 Disconnect two connectors

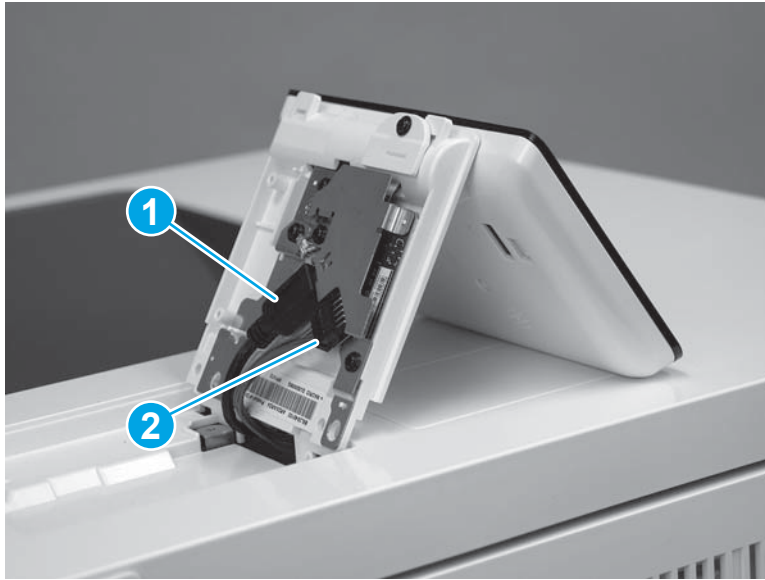

Step 5: Remove the tray

1. Pull the tray out until it stops.

Figure 1-3376 Pull the tray out



2. Lift the front of the tray, and then pull it out of the printer to remove it.

Figure 1-3377 Remove the tray

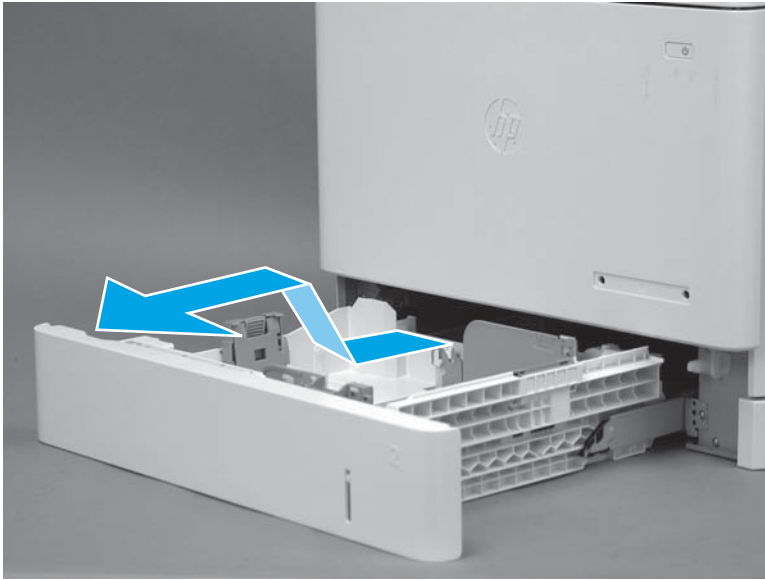

Step 6: Remove the toner collection unit (TCU)

1. Open the front door.

Figure 1-3378 Open the front door



2. Open the TCU.



NOTE: The toner collection hatch cover automatically closes when the TCU is opened.

Figure 1-3379 Open the TCU



3. Pull the TCU away from the printer at an angle to remove it.

⚠ CAUTION: Do not open the toner collection hatch cover when handling the TCU. If toner gets on clothing, wipe it off by using a dry cloth and wash the clothes in cold water. Hot water sets toner into fabric.

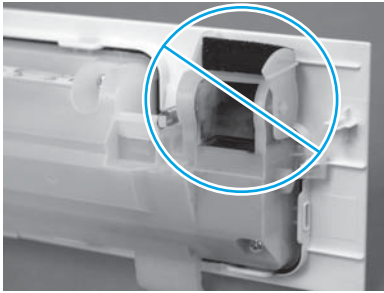
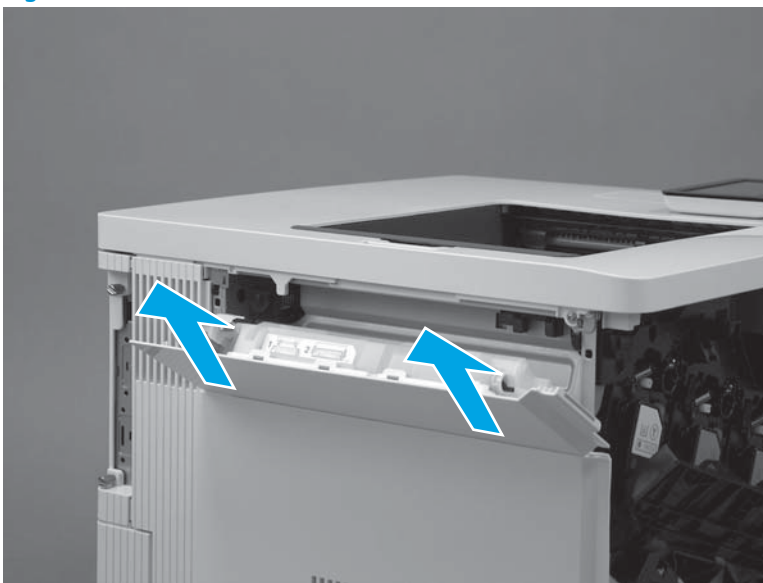

Figure 1-3380 Remove the TCU



Step 7: Remove the formatter cover

1. Locate the formatter cover.

Figure 1-3381 Locate the formatter cover

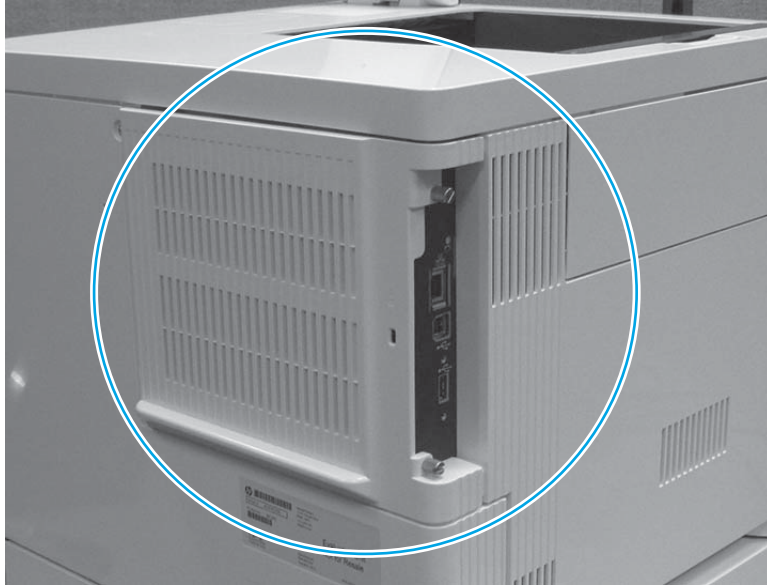

2. Loosen the two thumbscrews (callout 1). Grasp the two thumbscrews, and then slide the cover away from the printer (callout 2) to remove it.

 **TIP:** If needed, use the edge of a coin to turn the thumbscrews.

Figure 1-3382 Loosen the thumbscrews



Step 8: Remove the formatter (M552 and M553)

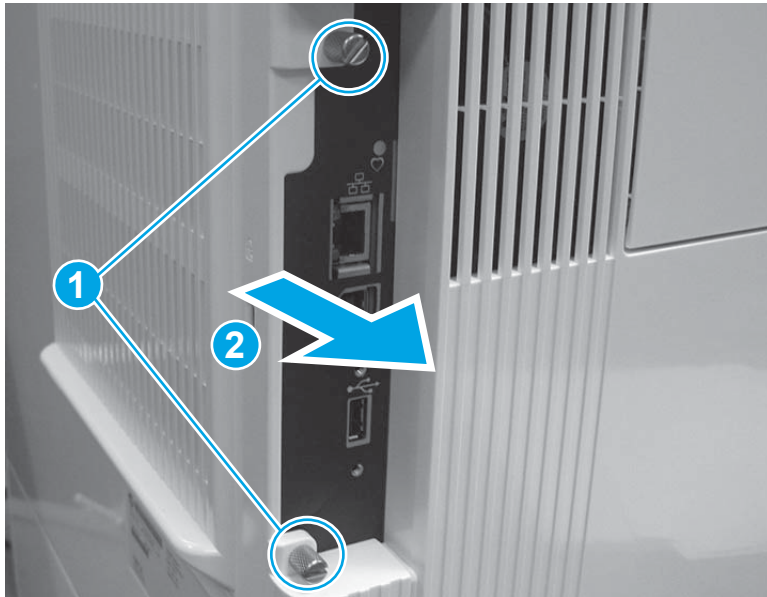

NOTE: This step is for the M552 and M553 models. For the M577 models, skip this step and go to [Step 9: Remove the hard-disk drive \(HDD\) \(M577\) on page 1907](#).

If the optional hard-disk drive (HDD) is installed, it must be removed to gain access to the formatter mounting screws.

Release two tabs along the left edge of the HDD, rotate the left edge away from the product, and then slide the HDD to the left to remove it.



CAUTION:  ESD-sensitive part.

1. Disconnect all of the connectors on the formatter.

The following connectors are empty:

- All models: J1 (this connector is empty unless the optional DIMM is installed)
- M553n/dn and M552dn: J2 (callout 1; this is the touchscreen connector for the M553x model)
- All models: J9 (this connector is empty unless the optional internal USB ports component is installed)
- All models: J18 (this connector is empty unless the optional hard-disk-drive (HDD) is installed)
- All models: J23
- All models: J24
- M553n/dn and M552dn: J25 (this is the wireless connector for the M553x model)
- All models: J57
- All models: J98 (this connector is empty unless the optional trusted platform module (TPM) is installed)



IMPORTANT: The flat-cable connector (callout 2) is a Zero Insertion Force (ZIF) connector that uses a hinged retainer to secure the flat cable. The hinged retainer must be opened to release the flat cable.

Figure 1-3383 Disconnect all connectors

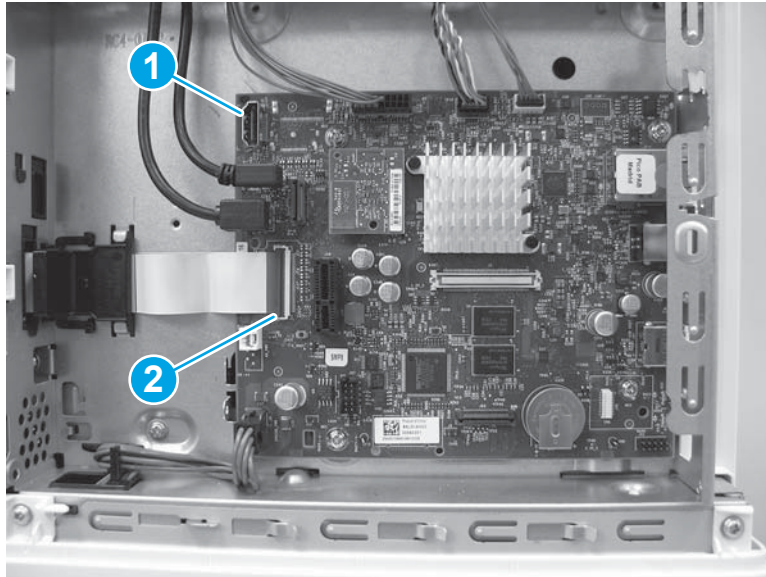

2. Remove four screws (callout 1), and then remove the formatter.

Figure 1-3384 Remove the formatter

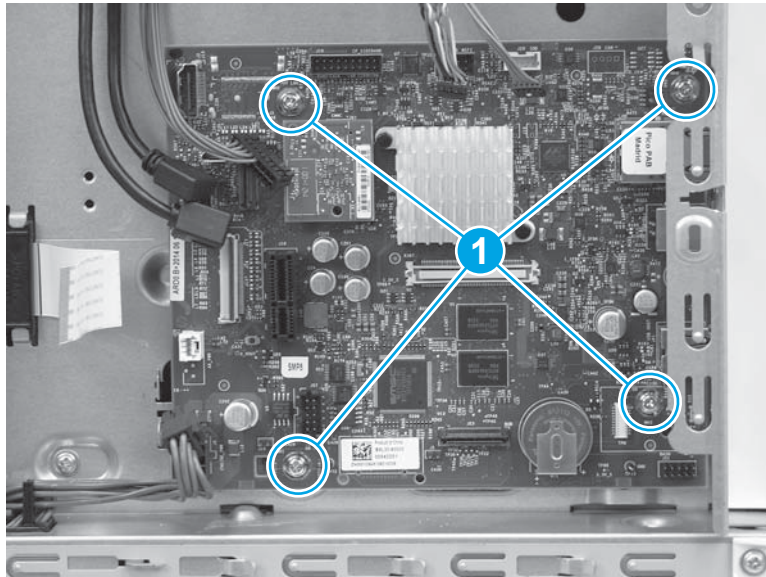

Step 9: Remove the hard-disk drive (HDD) (M577)

 **NOTE:** This step is for the M577 models. For the M552 and M553 models, skip this step and go to [Step 12: Remove the rear cover \(M552 and M553\) on page 1912](#).

 **CAUTION:**  ESD-sensitive part.

1. Release two tabs (callout 1). Hold the tabs in the released position, and then rotate the hard disk drive (HDD) up (callout 2) to release the connector from the formatter.

Figure 1-3385 Release the HDD

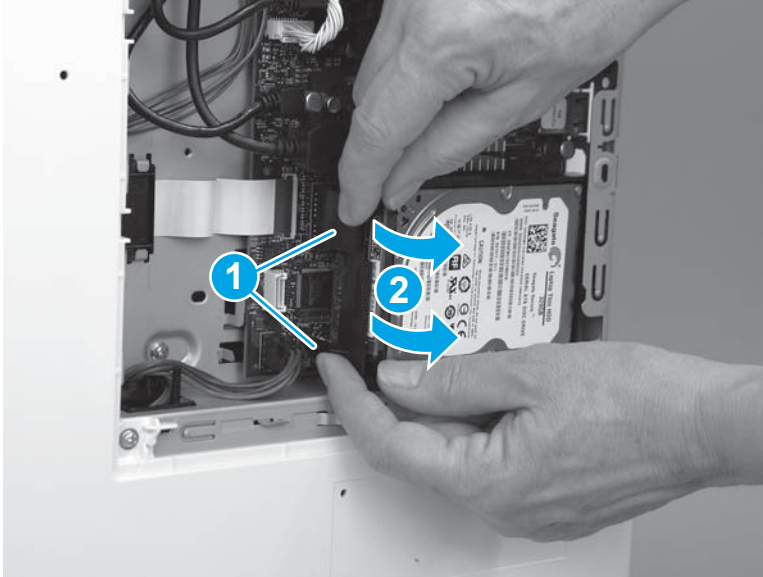

2. Slide the HDD away from the printer to remove it.

Figure 1-3386 Remove the HDD



Step 10: Remove the fax PCA (M577c/f/z)

 **NOTE:** This step is for the M577c/f/z models. For the M577n model, skip this step and go to [Step 11: Remove the formatter \(M577\) on page 1910](#).

For the M552 and M553 models, skip this step and go to [Step 12: Remove the rear cover \(M552 and M553\) on page 1912](#).

 **CAUTION:**  ESD-sensitive part.

1. Locate the fax PCA component on the formatter.

Figure 1-3387 Locate the fax PCA

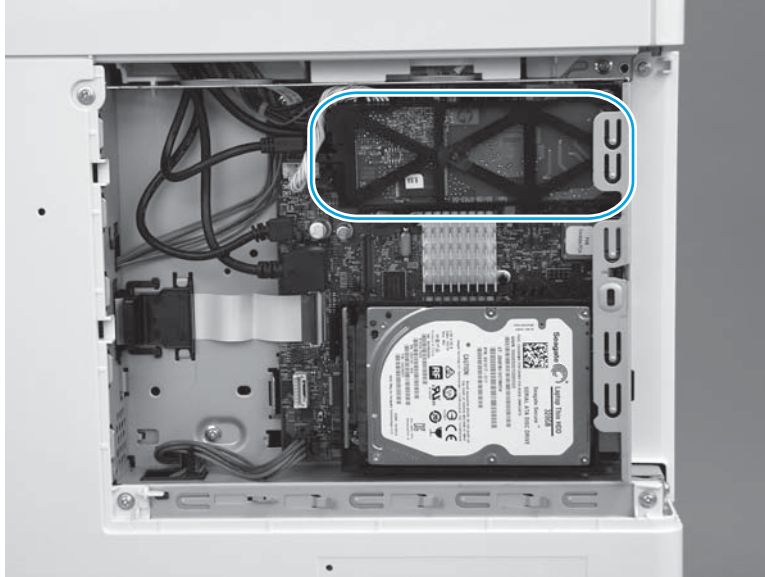

2. Release the connector latch (callout 1), and then pull the connector away from the formatter (callout 2) to disconnect it.

Figure 1-3388 Disconnect one connector

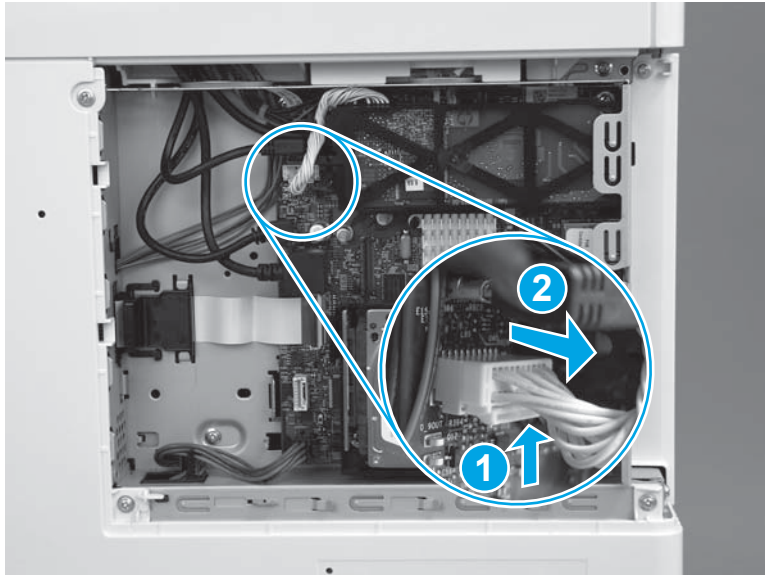

3. Release one retainer (callout 1) by pressing the bracket arms together.

Figure 1-3389 Release one latch

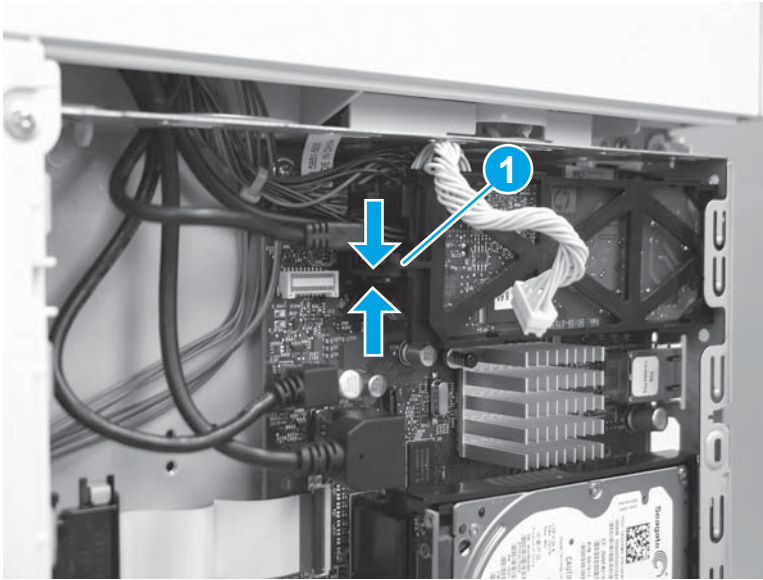

4. Rotate the end of the fax PCA (callout 1) away from the formatter, and then slide the PCA left (callout 2) to remove it.

Figure 1-3390 Remove the fax PCA

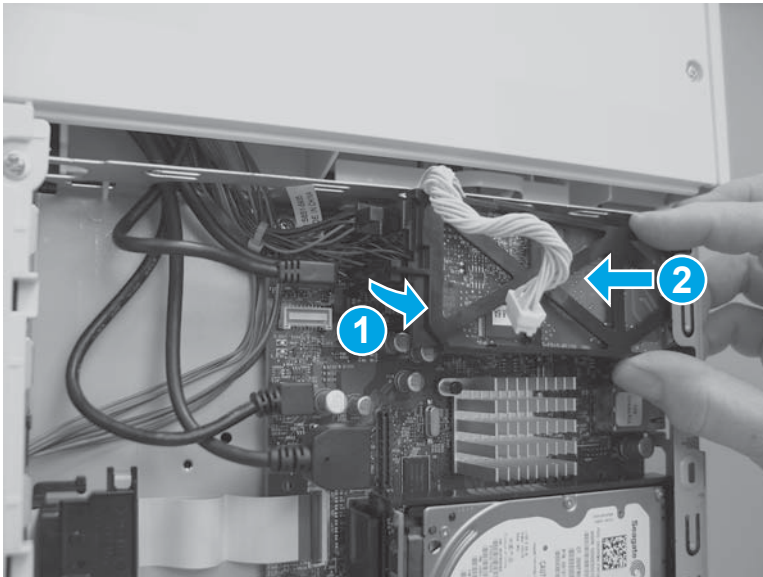

Step 11: Remove the formatter (M577)

 **NOTE:** This step is for the M577 models. For the M552 and M553 models, skip this step and go to [Step 12: Remove the rear cover \(M552 and M553\) on page 1912.](#)

 **CAUTION:**  ESD-sensitive part.

1. Disconnect all of the connectors on the formatter.

The following connectors are empty:

- All models: J1 (this connector is empty unless the optional DIMM is installed)
- All models: J3
- M577dn: J15 (this is the fax connector for the M577f/z/c models)
- All models: J21 (this connector is empty unless the optional internal USB ports component is installed)
- All models: J23
- All models: J24
- All models: J51
- All models: J57
- All models: J97
- All models: J98 (this connector is empty unless the optional trusted platform module (TPM) is installed)

 **IMPORTANT:** The flat-cable connector (callout 1) is a Zero Insertion Force (ZIF) connector that uses a hinged retainer to secure the flat cable. The hinged retainer must be opened to release the flat cable.

Figure 1-3391 Disconnect all connectors



2. Remove four screws (callout 1).

Figure 1-3392 Remove four screws

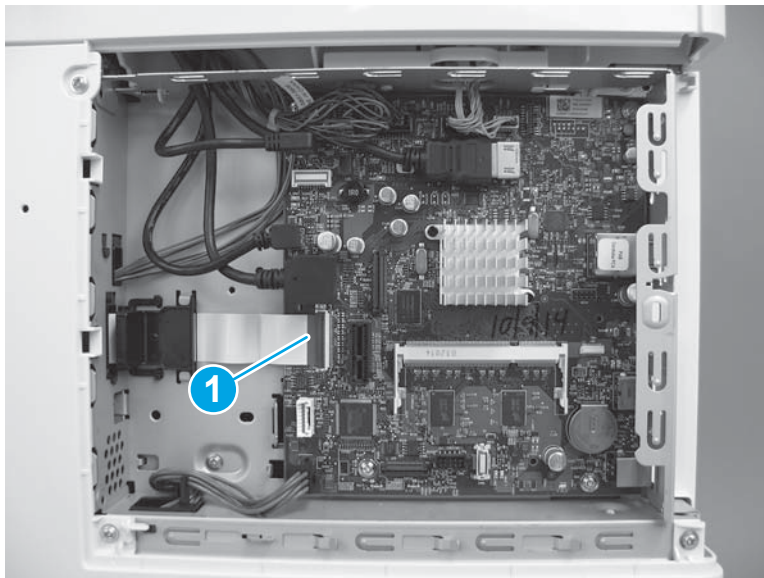
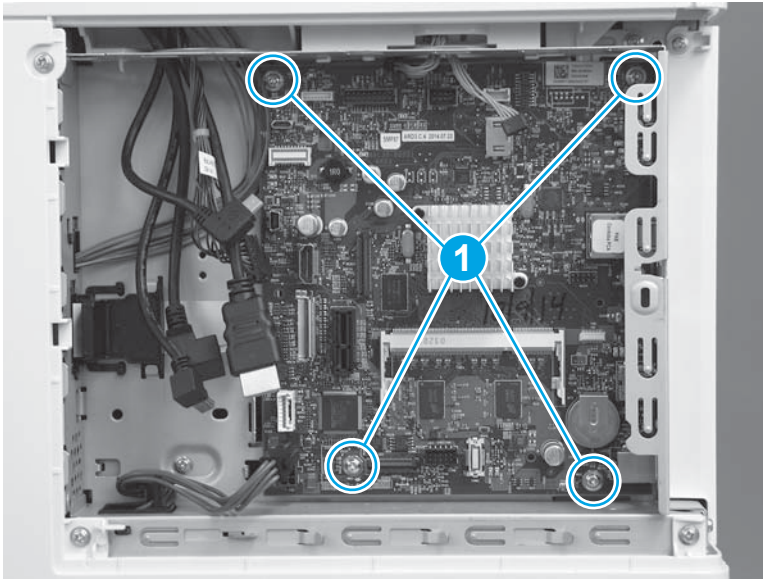

3. Remove the formatter.

Figure 1-3393 Remove the formatter

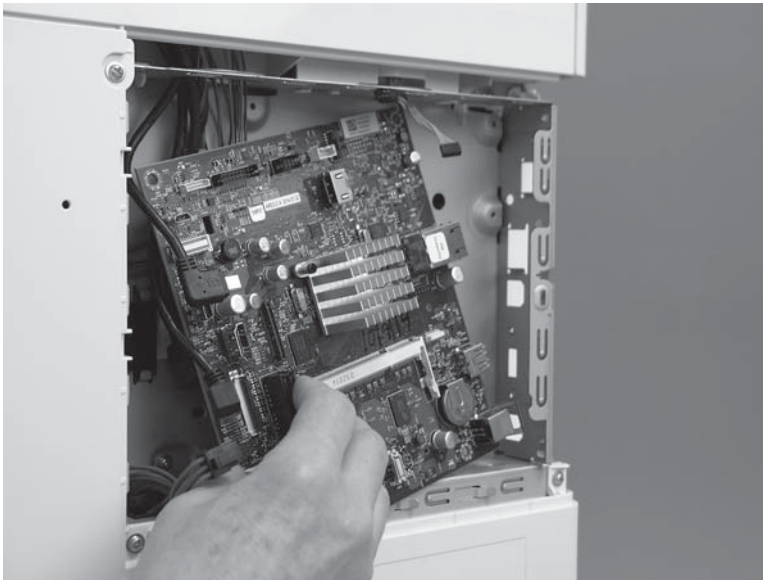

Step 12: Remove the rear cover (M552 and M553)



NOTE: This step is for the M552 and M553 models. For the M577 models, skip this step and go to [Step 13: Remove the rear upper cover \(M577\) on page 1913.](#)

1. Remove four screws (callout 1).

Figure 1-3394 Remove four screws

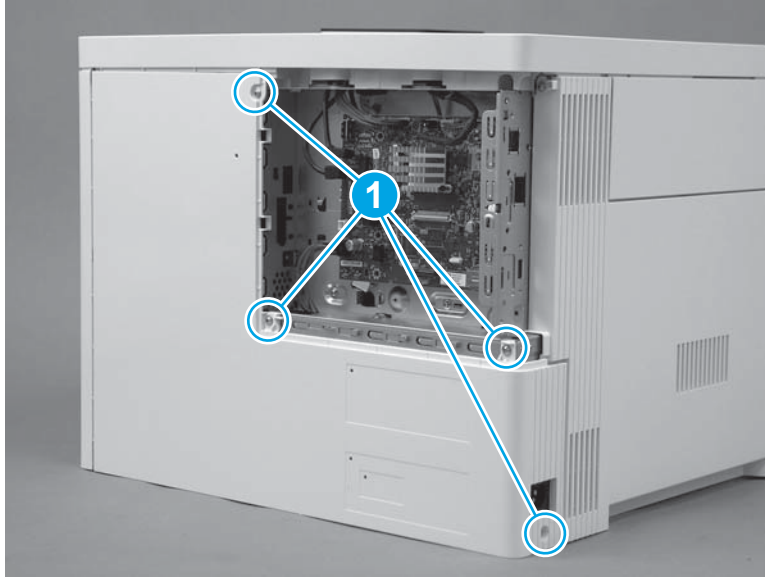

2. Slightly slide the cover to the right (callout 1), rotate the bottom of the cover away from the printer (callout 2), and then pull the top of the cover away from the printer (callout 3) to remove the cover.

Figure 1-3395 Remove the cover

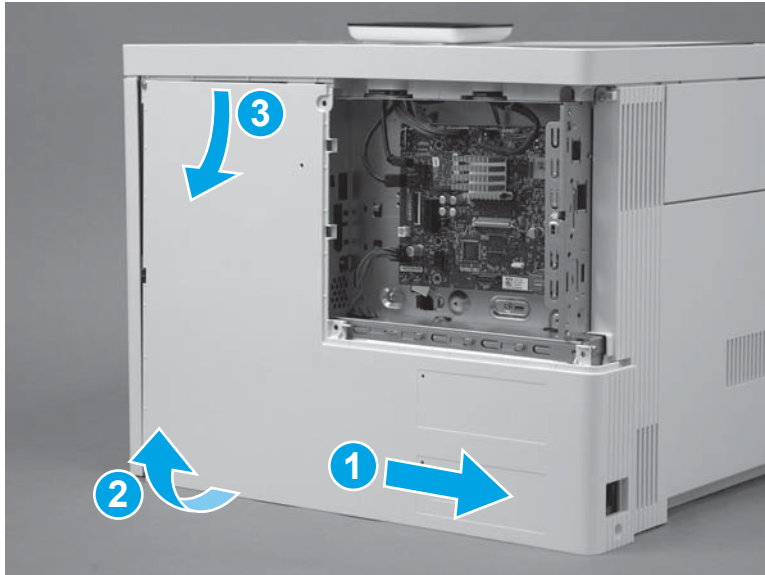

Step 13: Remove the rear upper cover (M577)



NOTE: This step is for the M577 models. For the M552 and M553 models, skip this step and go to [Step 25: Remove the left cover on page 1933](#).

1. Remove two screws (callout 1).



Reinstallation tip: These two screws are self-tapping screws for plastic. When reinstalling them, rotate the screws counterclockwise to align them with the existing thread pattern, and then carefully turn them clockwise to tighten. Do not overtighten. This will prevent stripping the threads inside the screw holes.

Figure 1-3396 Remove two screws

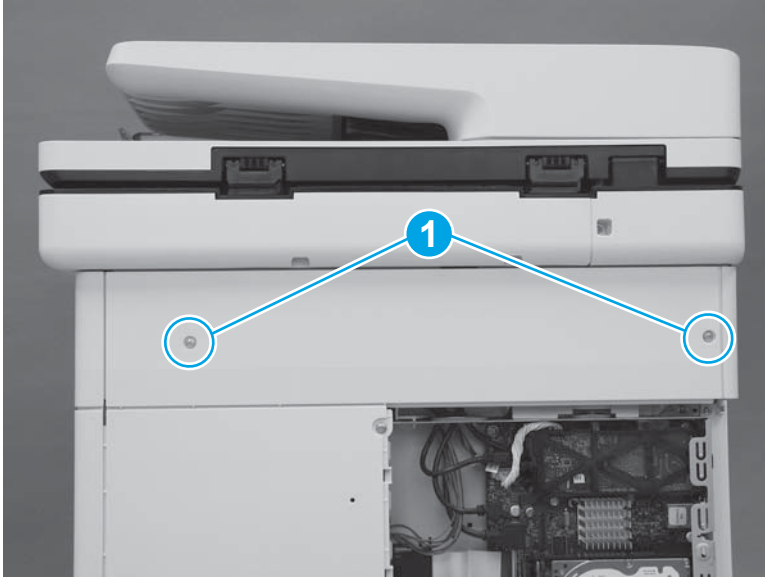

2. Use a small, flat blade screwdriver to release the right edge of the cover.

Figure 1-3397 Release the right edge

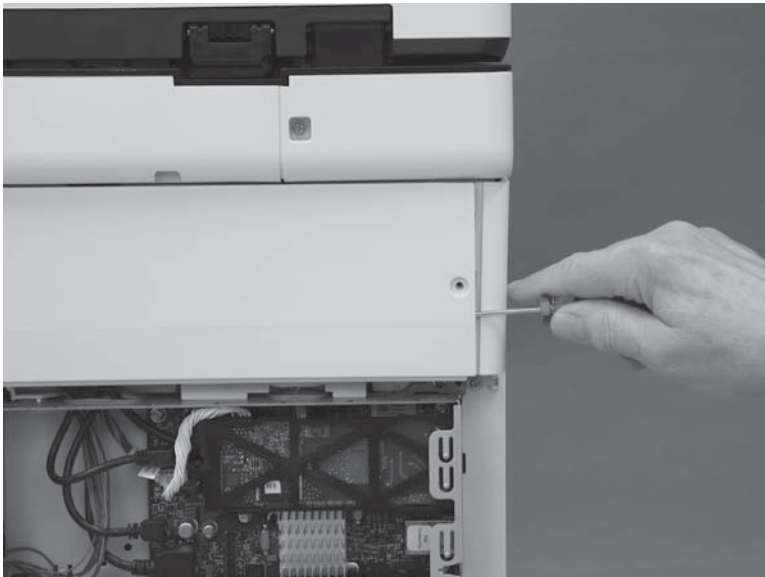

3. Pull the right edge of the cover (callout 1) away from the printer, and then slide the cover to the right (callout 2).

Figure 1-3398 Slide the cover right

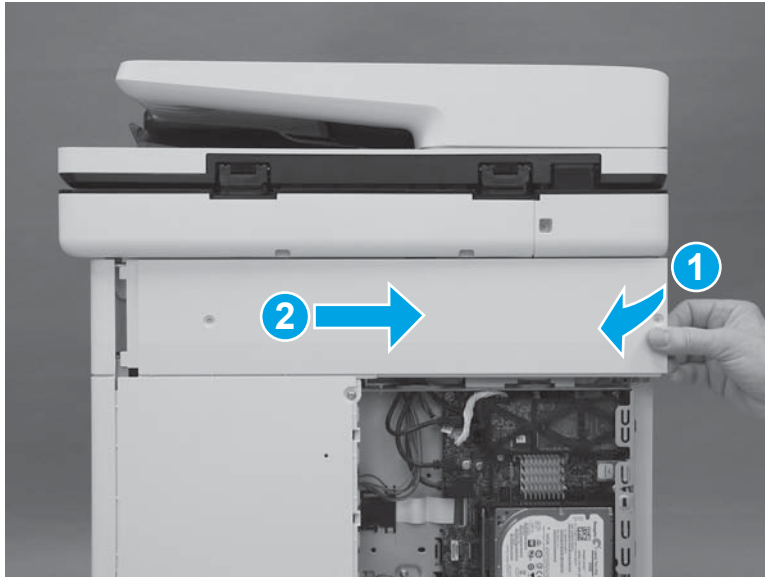

4. Remove the cover.

Figure 1-3399 Remove the cover

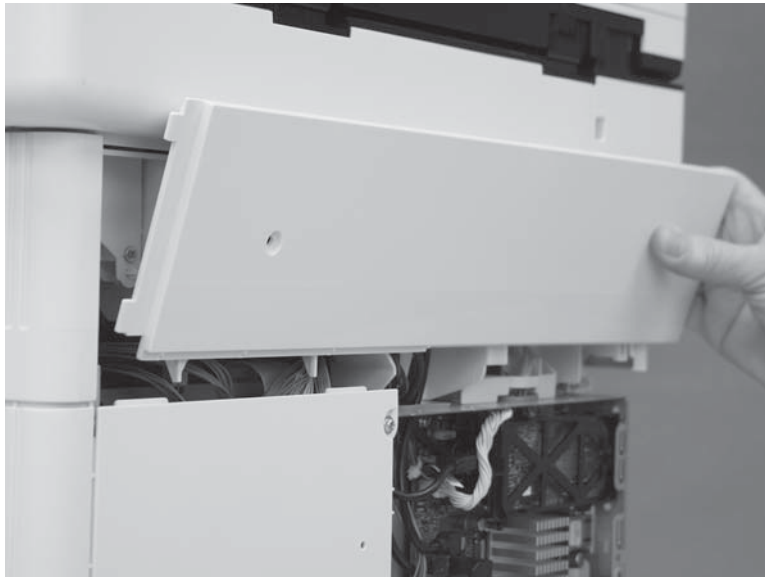

Step 14: Remove the rear cover (M577)

 **NOTE:** This step is for the M577 models. For the M552 and M553 models, skip this step and go to [Step 25: Remove the left cover on page 1933](#).

1. Remove four screws (callout 1).

Figure 1-3400 Remove four screws

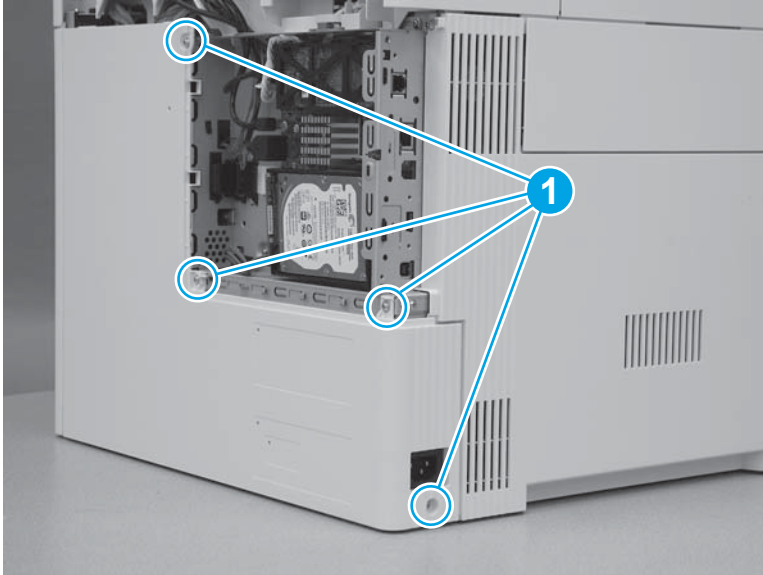

2. Slide the cover to the right to remove it.

Figure 1-3401 Remove the cover

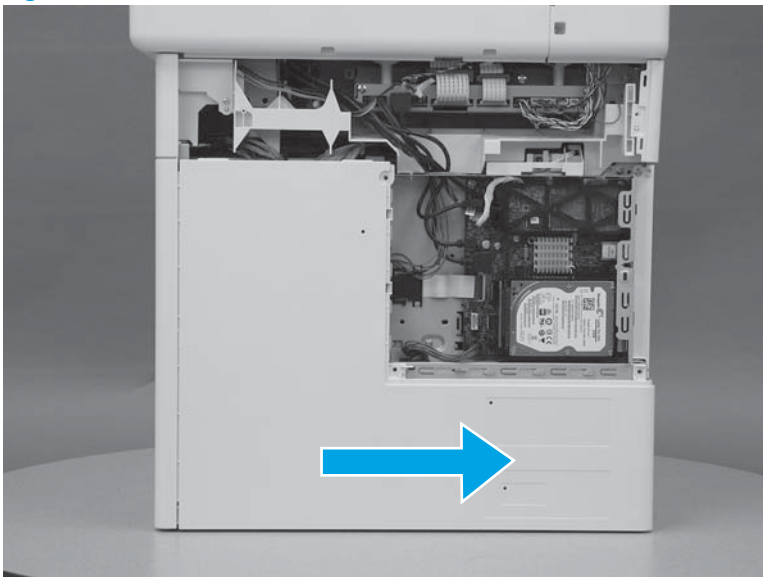

Step 15: Remove the left upper cover (M577)



NOTE: This step is for the M577 models. For the M552 and M553 models, skip this step and go to [Step 25: Remove the left cover on page 1933](#).

1. At the left side of the printer, release one tab (callout 1).

Figure 1-3402 Release one tab

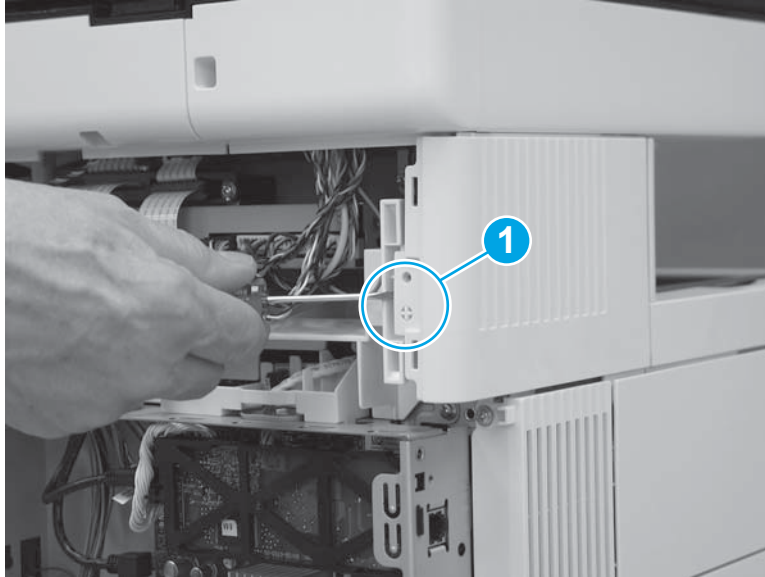

2. Slide the left upper cover toward the back of the printer.

Figure 1-3403 Slide the cover back

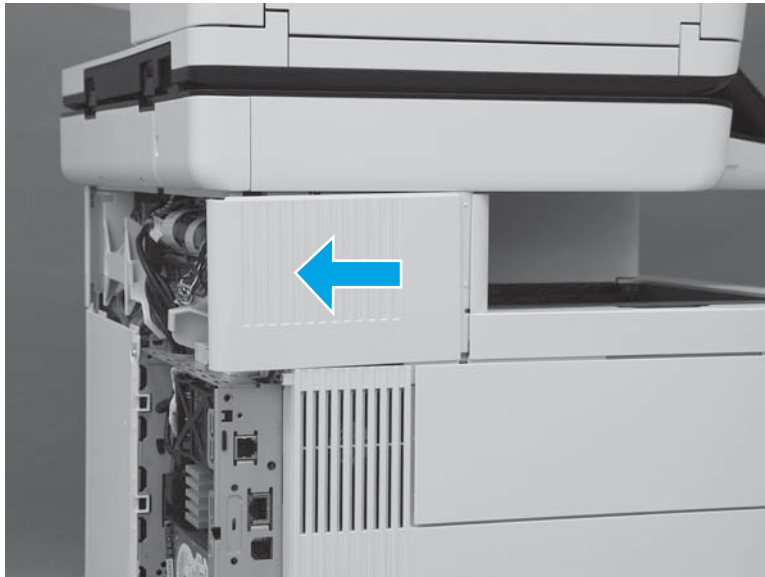

3. Rotate the cover up to remove it.

Figure 1-3404 Remove the left upper cover



Step 16: Remove the right front upper cover (M577dn)



NOTE: This step is for the M577dn model. For the M577c/f/z models, skip this step and go to [Step 17: Remove the stapler cover assembly \(M577c/f/z\) on page 1919.](#)

For the M552 and M553 models, skip this step and go to [Step 25: Remove the left cover on page 1933.](#)

1. Remove one screw (callout 1).

Figure 1-3405 Remove one screw

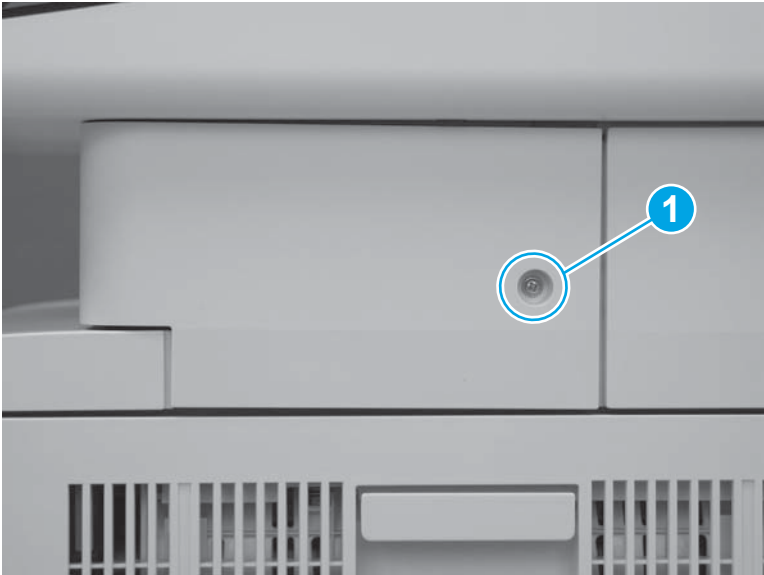

2. Release two tabs at the front edge of the cover (callout 1).

Figure 1-3406 Release two tabs



3. Rotate the front of the cover to the right to remove it.

Figure 1-3407 Rotate the cover



Step 17: Remove the stapler cover assembly (M577c/f/z)

 **NOTE:** This step is for the M577c/f/z models. For the M577dn model, skip this step and to go [Step 20: Remove the right upper cover \(M577\) on page 1925](#).

For the M552 and M553 models, skip this step and go to [Step 25: Remove the left cover on page 1933](#).

1. Remove one screw (callout 1).

 **Reinstallation tip:** This is a self-tapping screw for plastic. When reinstalling, rotate the screw counterclockwise to align it with the existing thread pattern, and then carefully turn it clockwise to tighten. Do not overtighten. This will prevent stripping the threads inside the screw hole.

Figure 1-3408 Remove one screw



2. Release two tabs at the front edge of the cover (callout 1).

Figure 1-3409 Release two tabs

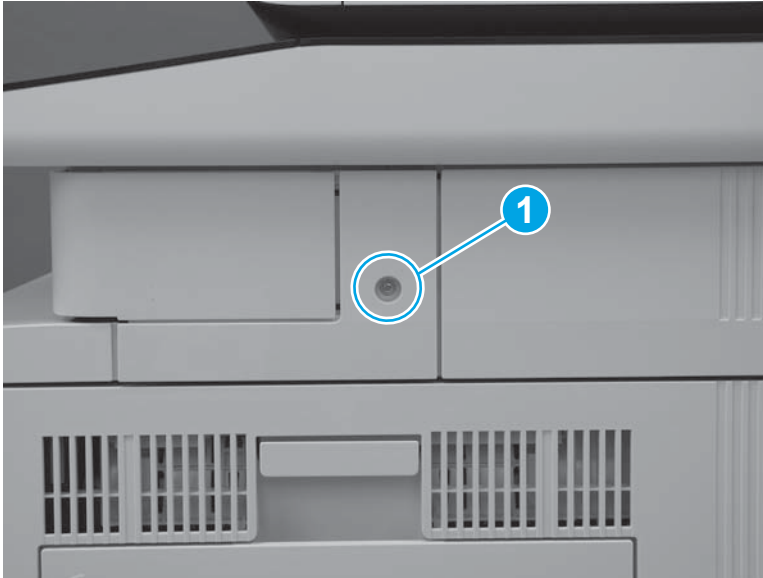

3. Release the back edge of the cover.

Figure 1-3410 Release the back edge of the cover

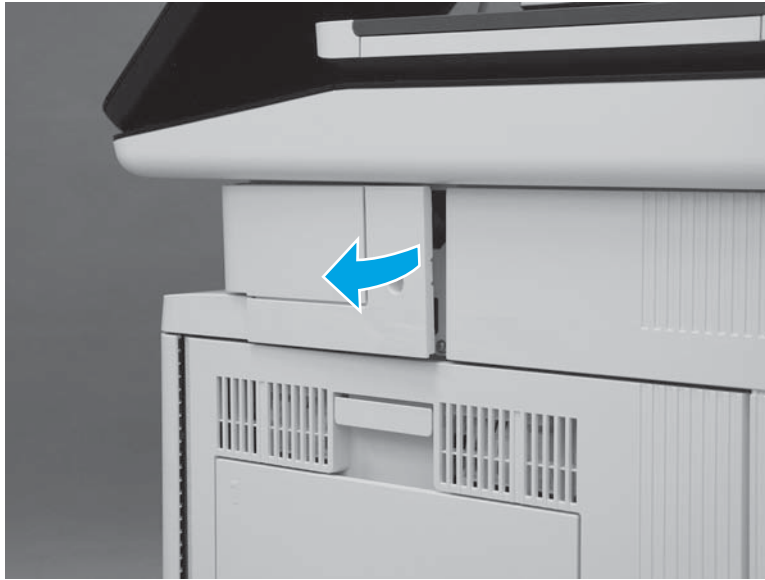



4. Rotate the cover away from the printer to remove it.

Figure 1-3411 Remove the cover



Step 18: Remove the integrated scanner assembly (ISA) (M577)

 **NOTE:** This step is for the M577 models. For the M552 and M553 models, skip this step and go to [Step 25: Remove the left cover on page 1933](#).

 **NOTE:** The ISA includes the document feeder, image scanner, scanner control board (SCB), control panel, keyboard (M577c/z) and NFC PCA (M577z).

1. At the left side of the printer, remove one screw (callout 1).

Figure 1-3412 Remove one screw

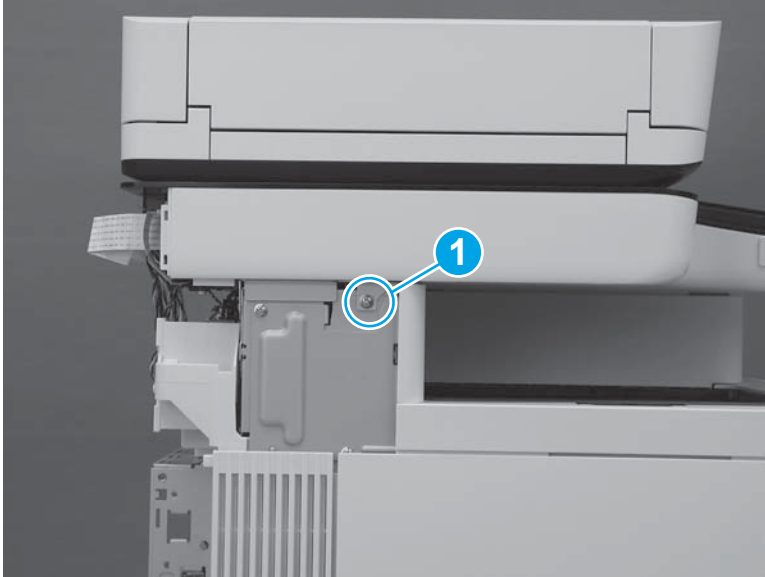

2. At the back side of the printer, remove two screws (callout 1).

Figure 1-3413 Remove two screws

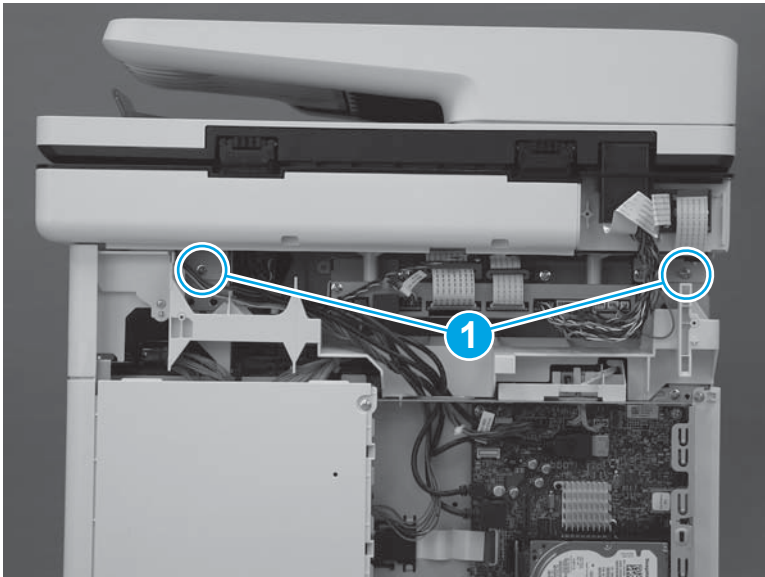

3. At the right side of the printer, remove one screw (callout 1).

Figure 1-3414 Remove one screw

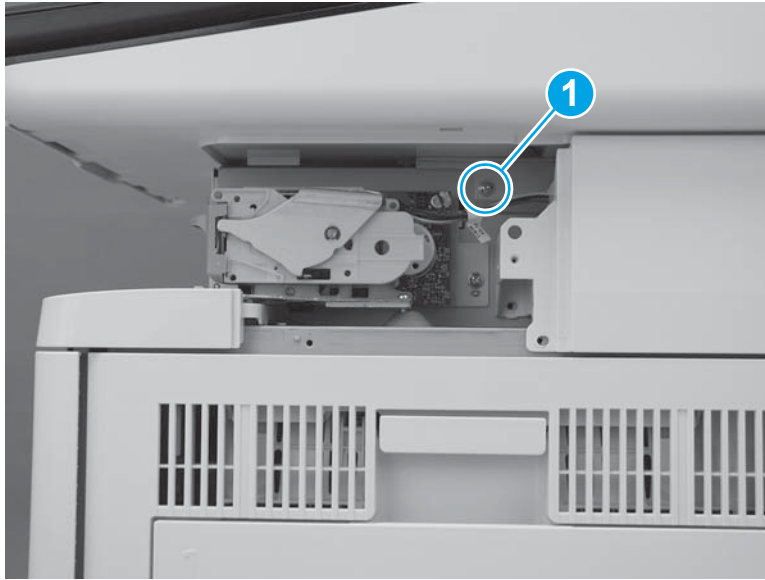

4. Disconnect two connectors on the scanner control board (callout 1).

M577c/f/z only: Disconnect one connector for the stapler on the scanner control board (callout 2).

Figure 1-3415 Disconnect connectors

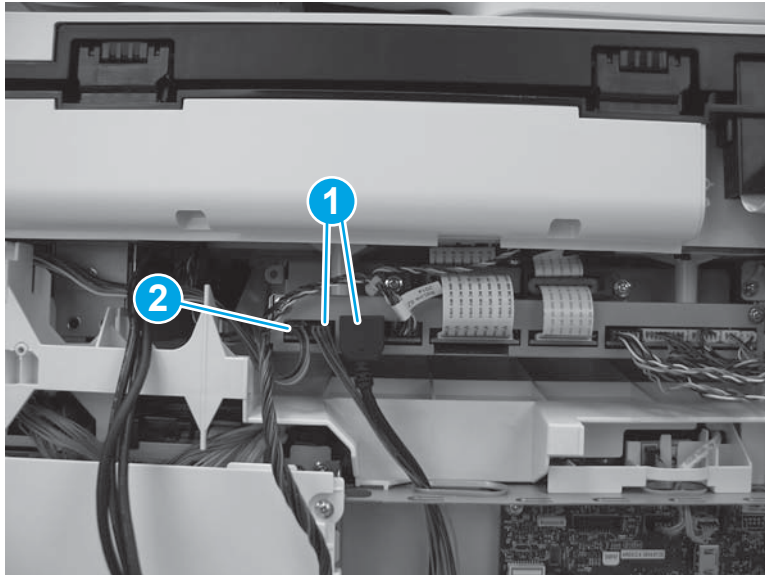

5. Slightly slide the ISA towards the back of the printer to release it.

Figure 1-3416 Slide the ISA towards the back of the printer

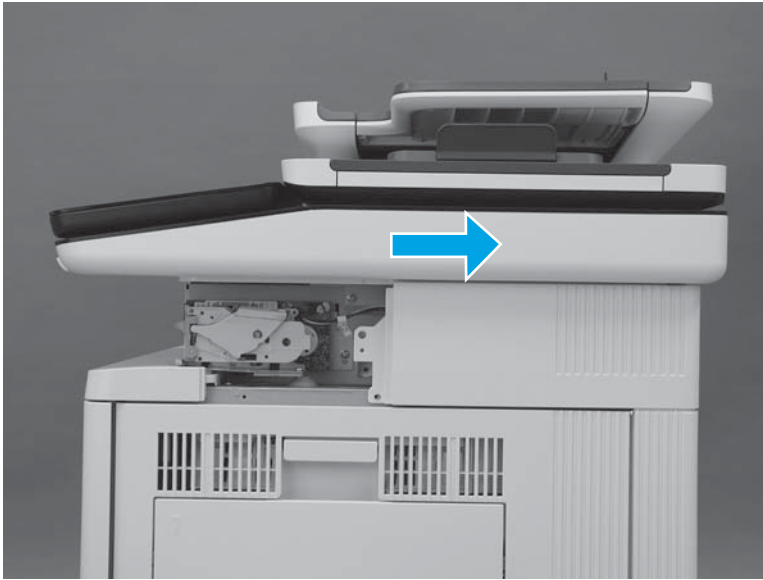

6. Lift the ISA up to remove it.



 **NOTE:** When lifting the ISA, carefully pass the cables through the opening in the top of the formatter case.

Figure 1-3417 Remove the ISA

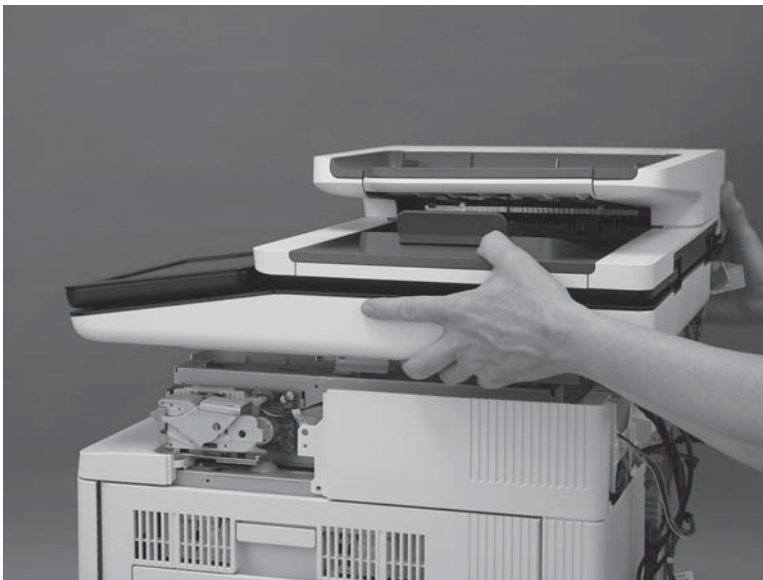

Step 19: Remove the stapler unit (M577c/f/z)

 **NOTE:** This step is for the M577c/f/z models. For the M577dn model, skip this step and to go [Step 21: Remove the top rear cover \(M577\) on page 1927](#).

For the M552 and M553 models, skip this step and go to [Step 25: Remove the left cover on page 1933](#).

1. Disconnect one connector (callout 1), and then remove two screws (callout 2).

Figure 1-3418 Disconnect connector and remove screws

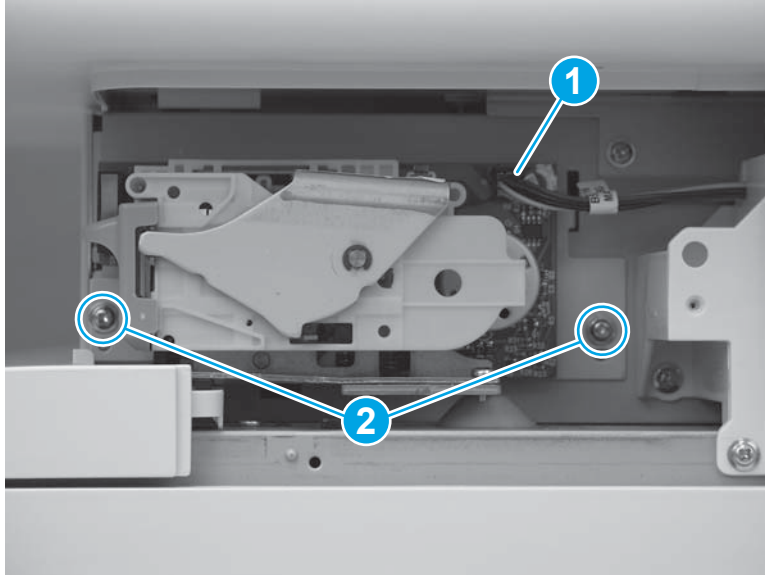

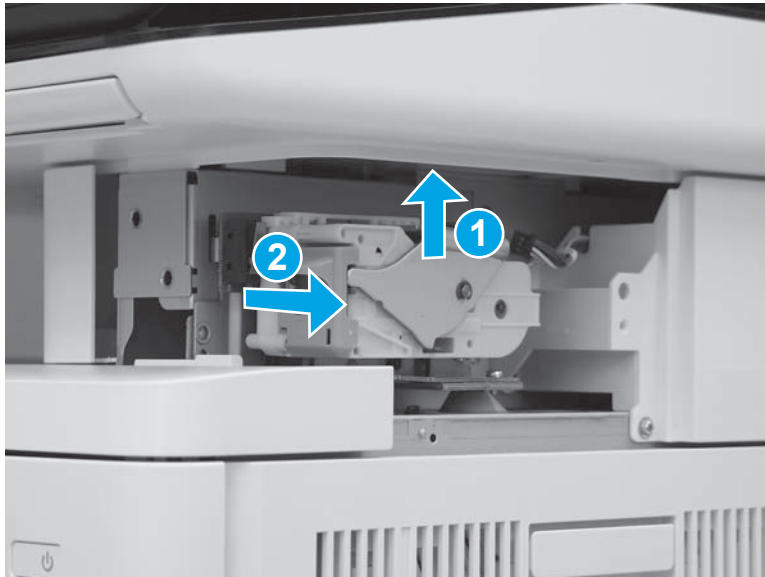

2. Slide the stapler unit up (callout 1), and then pull it away from the printer (callout 2) to remove it.

Figure 1-3419 Remove the stapler unit



Step 20: Remove the right upper cover (M577)

 **NOTE:** This step is for the M577 models. For the M552 and M553 models, skip this step and go to [Step 25: Remove the left cover on page 1933](#).

 **NOTE:** The figures below show the image scanner installed. The procedures for removing and installing the right upper cover are the same whether the image scanner is installed or removed."

1. At the right side of the printer, remove two screws (callout 1).

M577c/f/z only: Disconnect one connector (callout 2), if it was not already disconnected in a previous step.

Figure 1-3420 Remove two screws and one connector

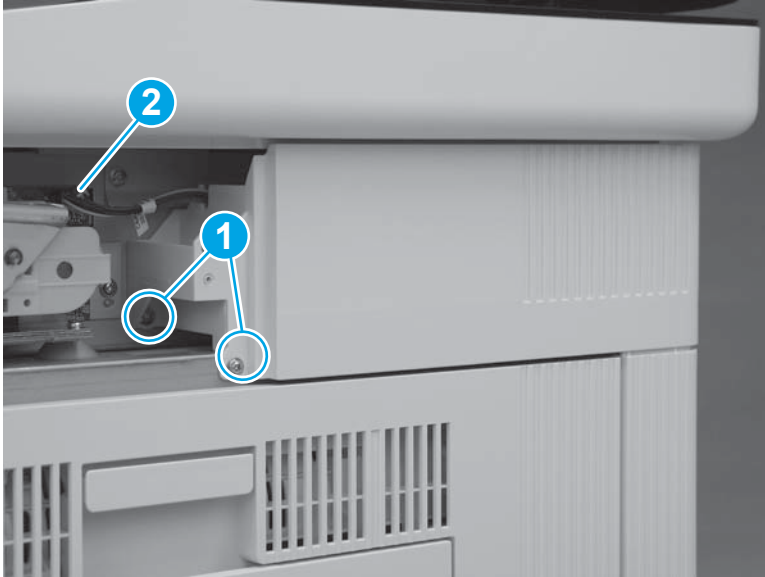

2. At the back of the printer, remove one screw (callout 1).

M577c/f/z only: Disconnect one connector (callout 2), if it was not already disconnected in a previous step.

 **Reinstallation tip:** This screw is smaller than the screws removed in the previous step. When reinstalling the right upper cover, make sure that this screw is installed in the correct position.

Figure 1-3421 Remove one screw and connector



3. Slide the cover toward the back of the printer.

Figure 1-3422 Slide the cover

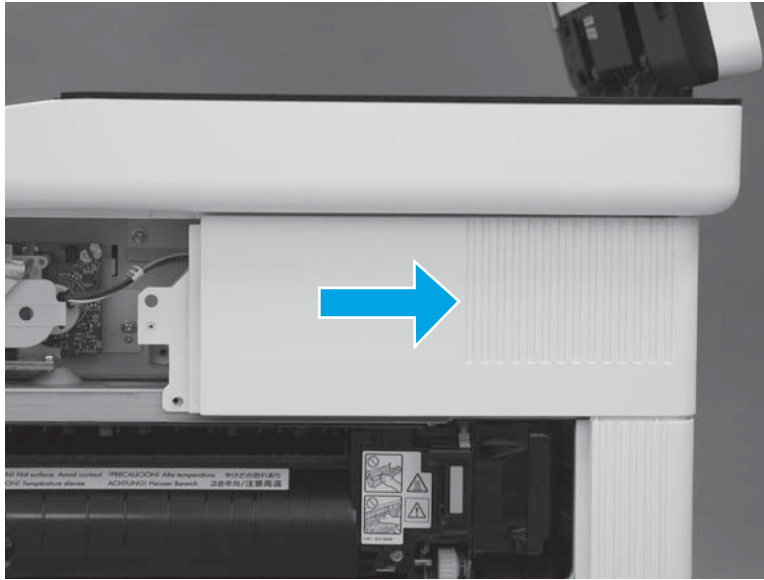

4. Lift the cover away from the printer to remove it.

M577c/f/z only: Release the cables (callout 1) through the slot (callout 2) in the printer.

Figure 1-3423 Remove the cover

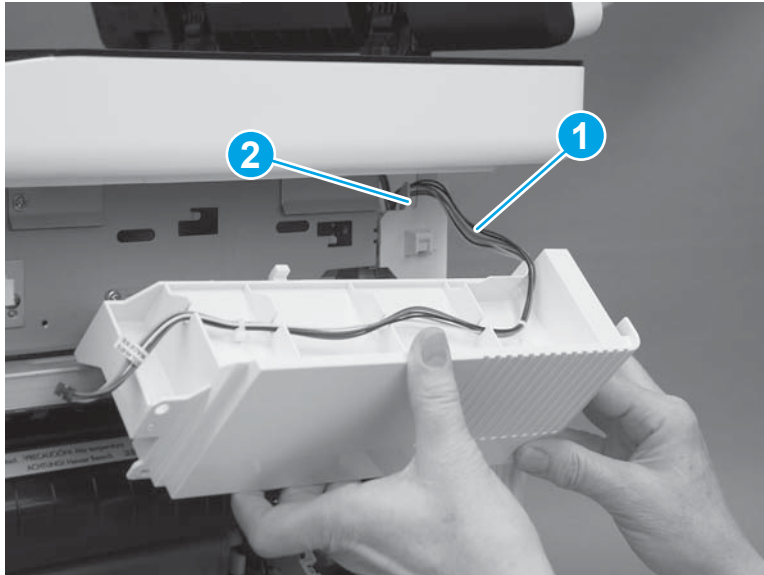

Step 21: Remove the top rear cover (M577)

 **NOTE:** This step is for the M577 models. For the M552 and M553 models, skip this step and go to [Step 25: Remove the left cover on page 1933](#).

1. At the top of the printer, remove five screws (callout 1).

Figure 1-3424 Remove five screws

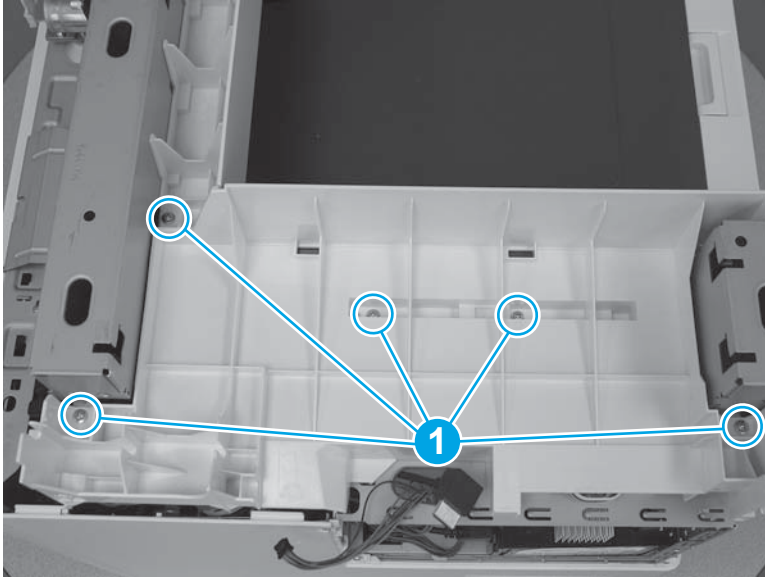

2. Release two tabs (callout 1) on the front edge of the cover.

Figure 1-3425 Release two tabs

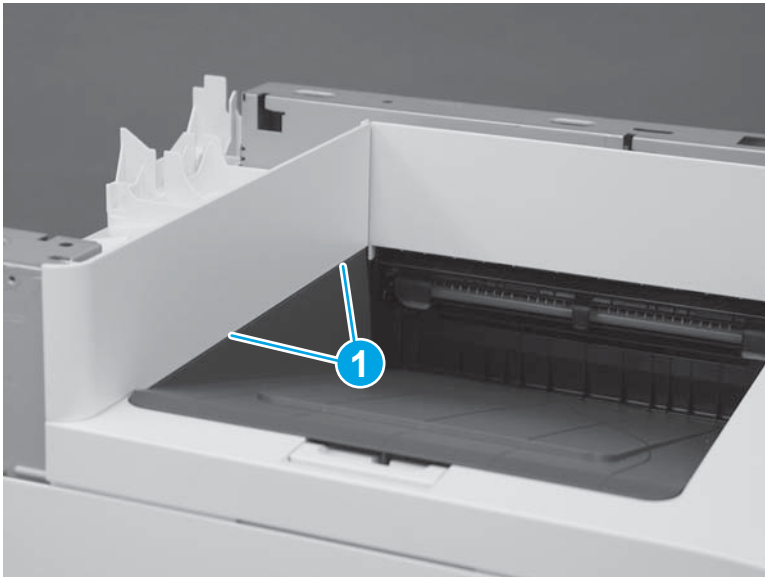

3. Remove the top rear cover.

Figure 1-3426 Remove the top rear cover

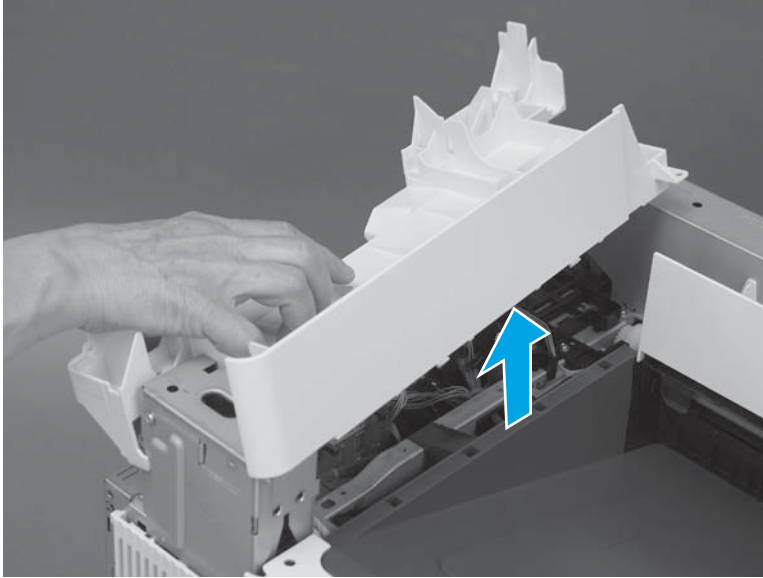

Step 22: Remove the paper feed cover (M577)



NOTE: This step is for the M577 models. For the M552 and M553 models, skip this step and go to [Step 25: Remove the left cover on page 1933](#).

1. Remove one screw (callout 1).

Figure 1-3427 Remove one screw

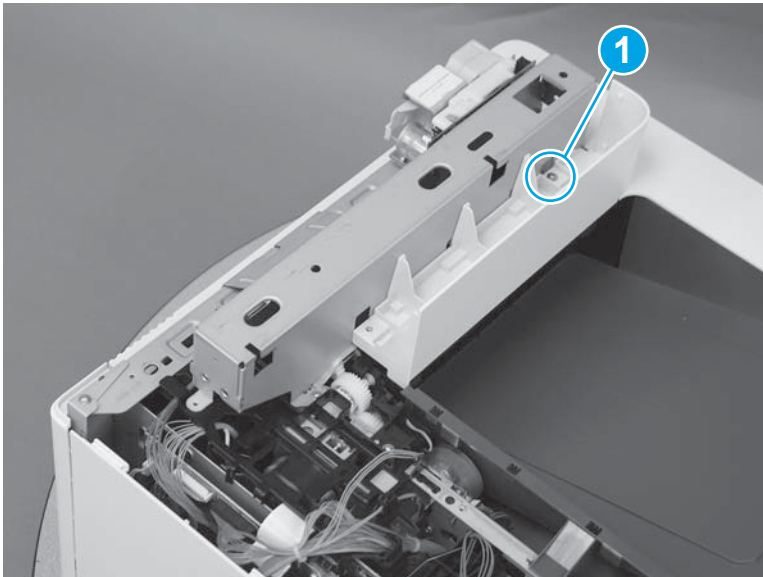

2. Lift the cover up to remove it.

Figure 1-3428 Remove the cover

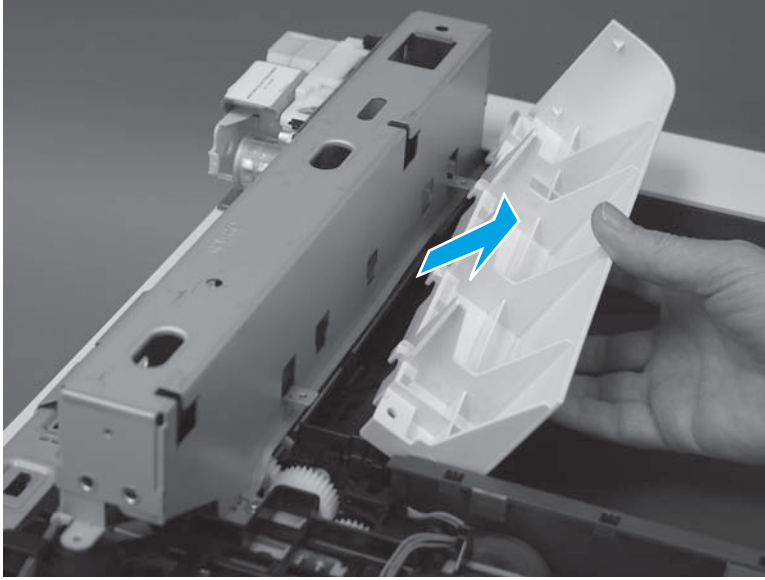

Step 23: Remove the top cover (M577)



NOTE: This step is for the M577 models. For the M552 and M553 models, skip this step and go to [Step 25: Remove the left cover on page 1933](#).

1. At the front of the printer, remove one screw (callout 1).



Reinstallation tip: This screw is longer and a different type of screw than the screw removed in the next step. When reinstalling the top cover, make sure that this screw is installed in the correct position.

Figure 1-3429 Remove one screw

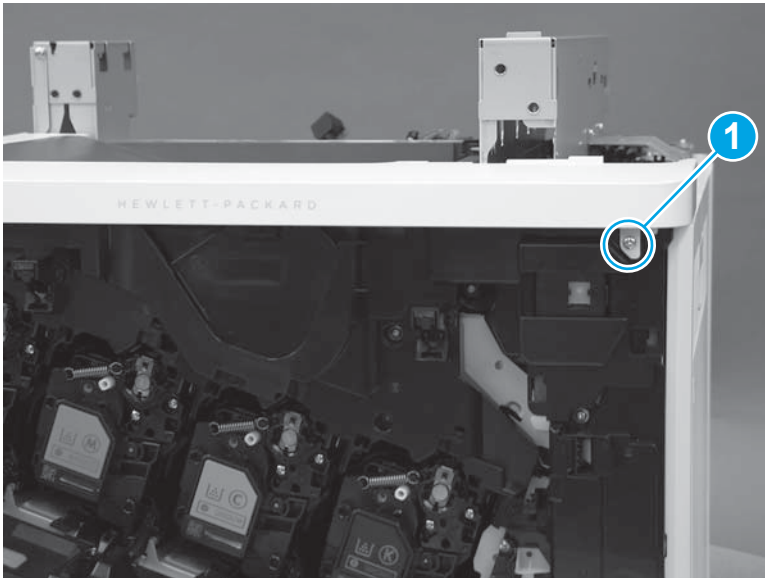

2. At the left side of the printer, remove one screw (callout 1).

Figure 1-3430 Remove one screw

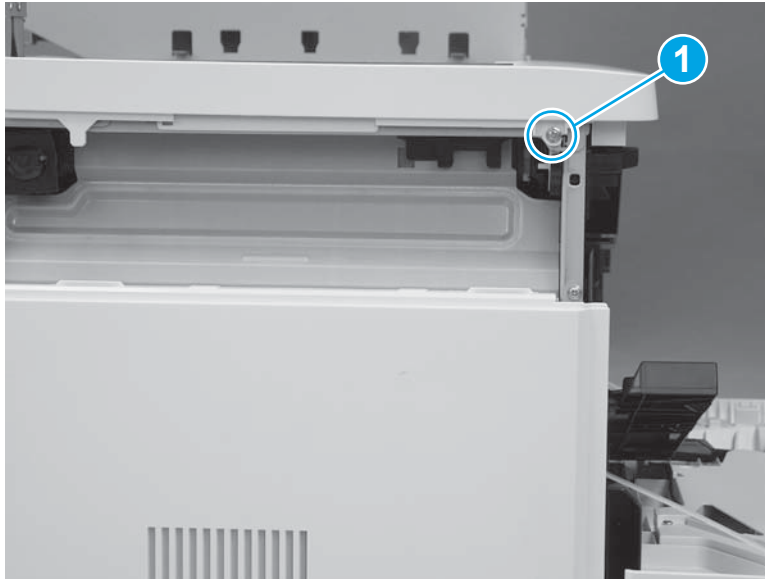

3. At the front of the printer, release one tab (callout 1).

Figure 1-3431 Release one tab



4. At the top of the printer, release two tabs (callout 1) next to the output bin, and then remove the top cover.

Figure 1-3432 Release two tabs

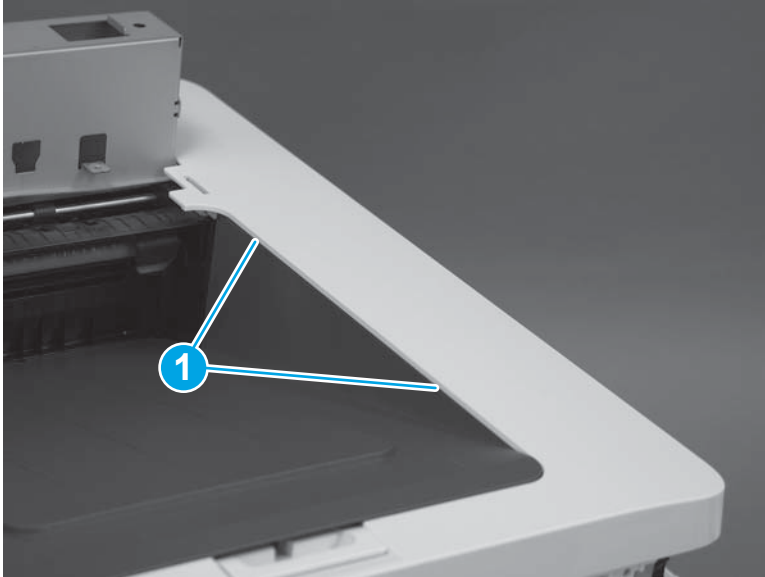

Step 24: Remove the top bracket (M577)



NOTE: This step is for the M577 models. For the M552 and M553 models, skip this step and go to [Step 25: Remove the left cover on page 1933](#).

1. At the top of the printer, remove three screws (callout 1).

Figure 1-3433 Remove three screws

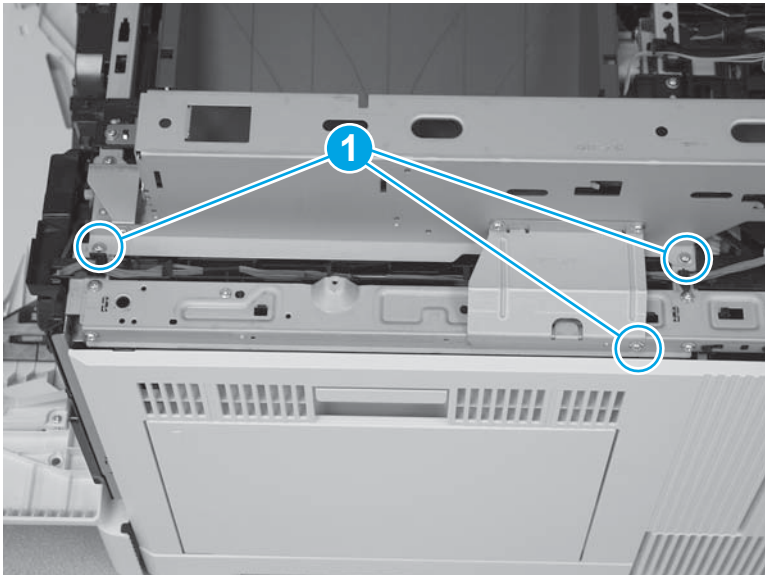

2. At the top of the printer, remove two screws (callout 1).

Figure 1-3434 Remove two screws

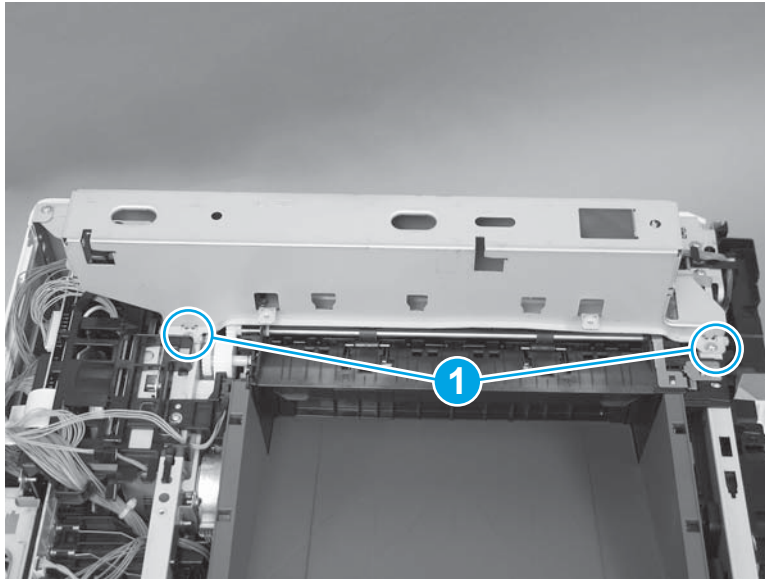

3. Lift the top bracket up to remove it.

Figure 1-3435 Remove the bracket

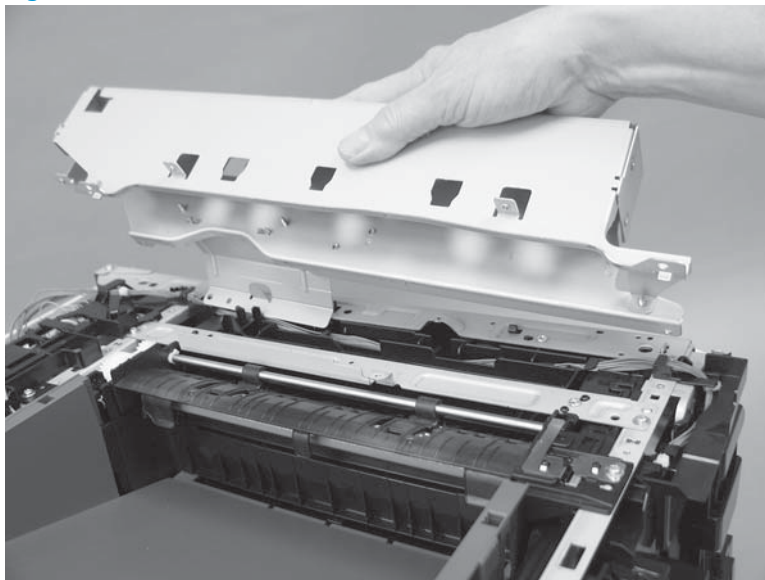

Step 25: Remove the left cover

1. At the left side of the printer, remove one screw (callout 1).

Figure 1-3436 Remove one screw



2. Release one tab (callout 1), rotate the front edge of the cover away from the printer (callout 2), and then slide the cover (callout 3) toward the rear of the printer to release it.

Figure 1-3437 Release the cover

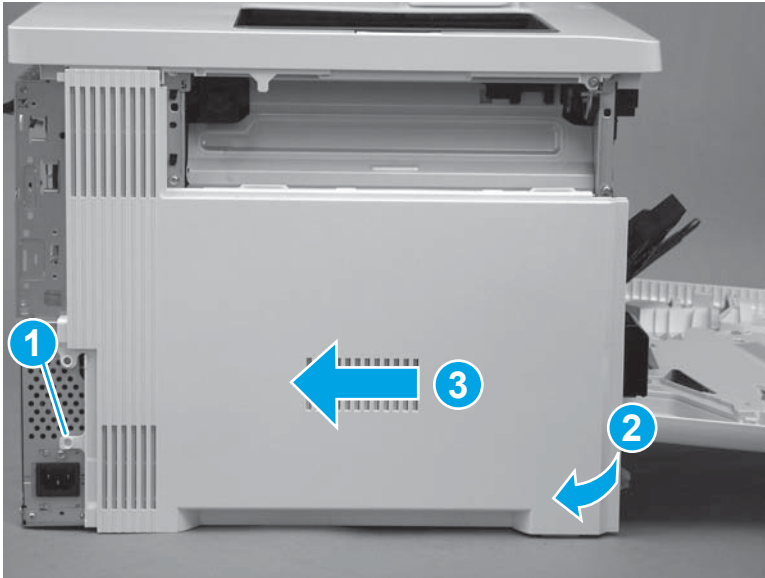

3. Remove the cover.

Figure 1-3438 Remove the cover

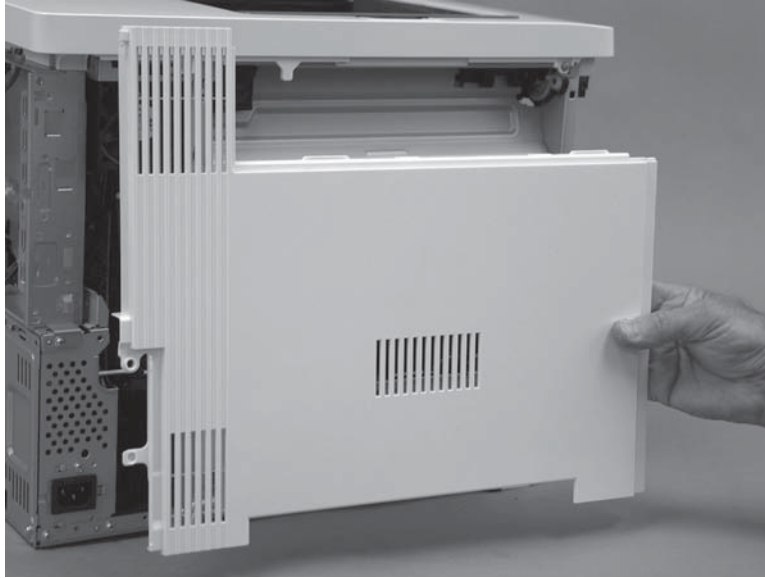

Step 26: Remove the upper cover (M552 and M553)



NOTE: This step is for the M552 and M553 models. For the M577 models, skip this step and go to [Step 29: Remove the formatter case on page 1940](#).

1. Remove three screws (callout 1).

Figure 1-3439 Remove three screws

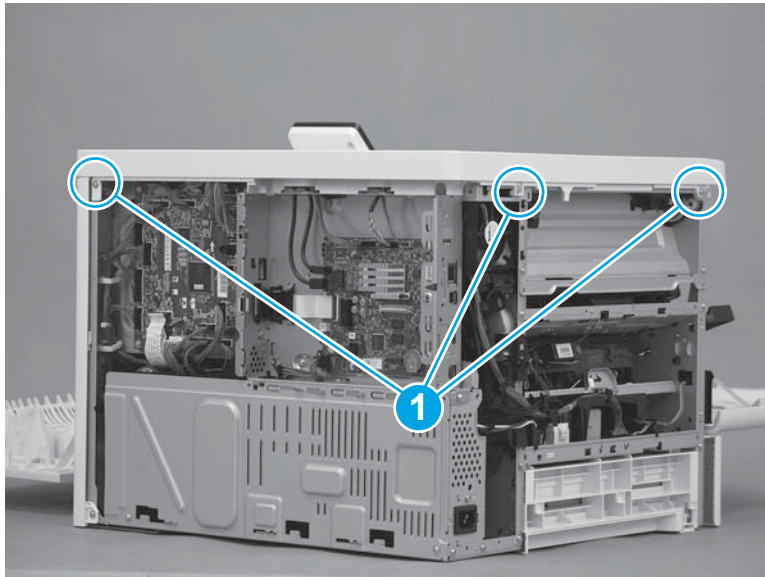

2. Remove one screw (callout 1), release one tab (callout 2), and then slightly separate the corner of the cover from the chassis.

 **NOTE:** This is a self-tapping plastic-thread screw. Make sure that this screw is used in this location when it is reinstalled.

Figure 1-3440 Remove one screw and release one tab



3. Release one tab (callout 1), and then lift up on the cover to release it.

 **NOTE:** If the cover does not release, check for addition tabs by locating the triangles embossed in the cover at tab locations.

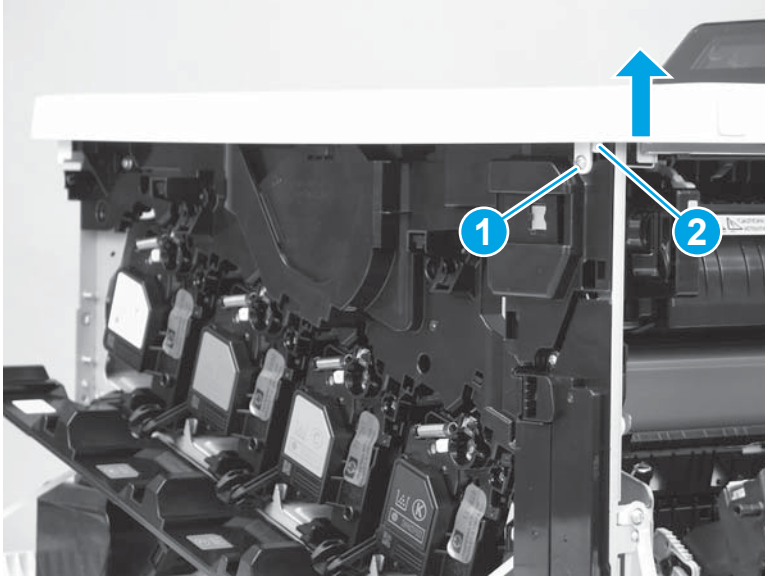
Figure 1-3441 Release the cover



4. Remove the cover.

Figure 1-3442 Remove the cover

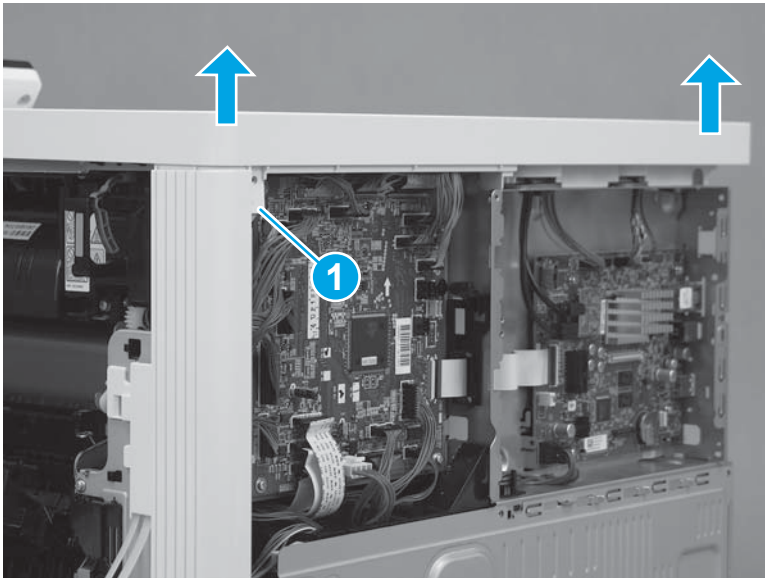
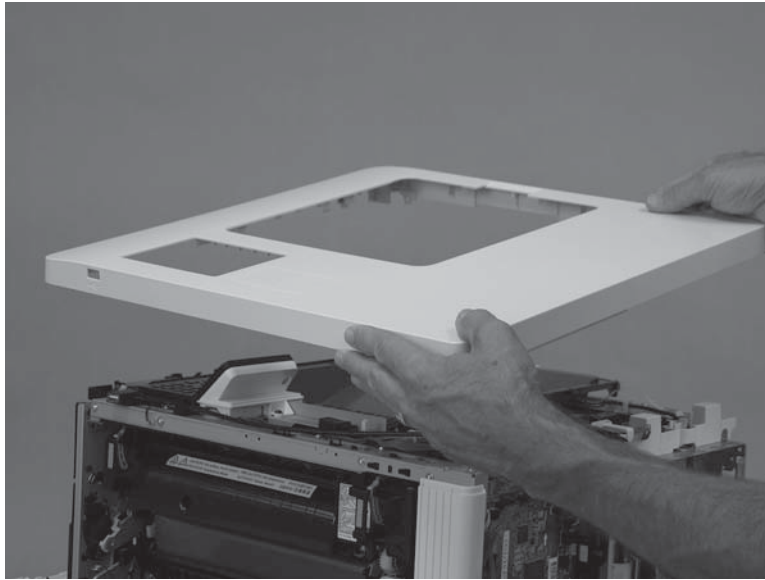

Step 27: Remove the control panel (M553n/dn and M552dn only)

 **NOTE:** This step is for the M553n/dn and M552dn models. For the M553x and M577 models, skip this step and go to [Step 28: Remove the output bin on page 1939](#).

1. Remove one screw (callout 1).

Figure 1-3443 Remove one screw

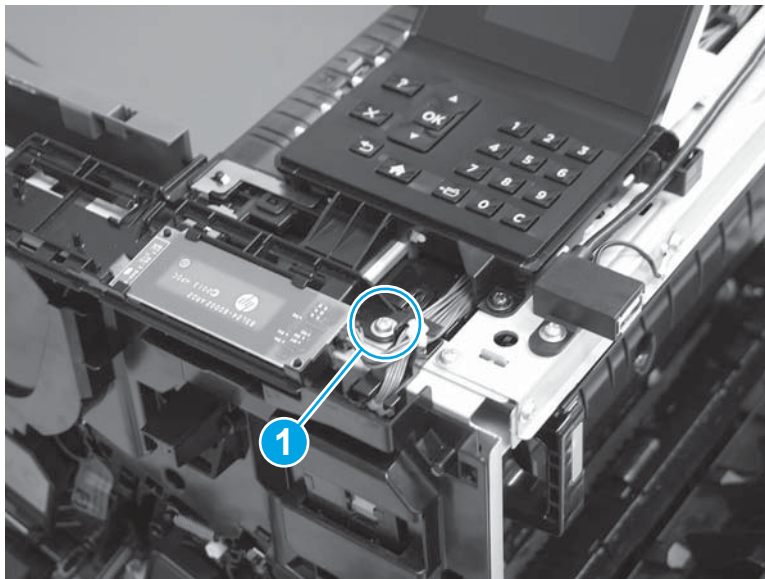

2. Disconnect one connector (callout 1). Rotate the near field communication (NFC) PCA holder up (callout 2), and then slide it to the right (callout 3) to remove it.

Figure 1-3444 Remove the PCA holder

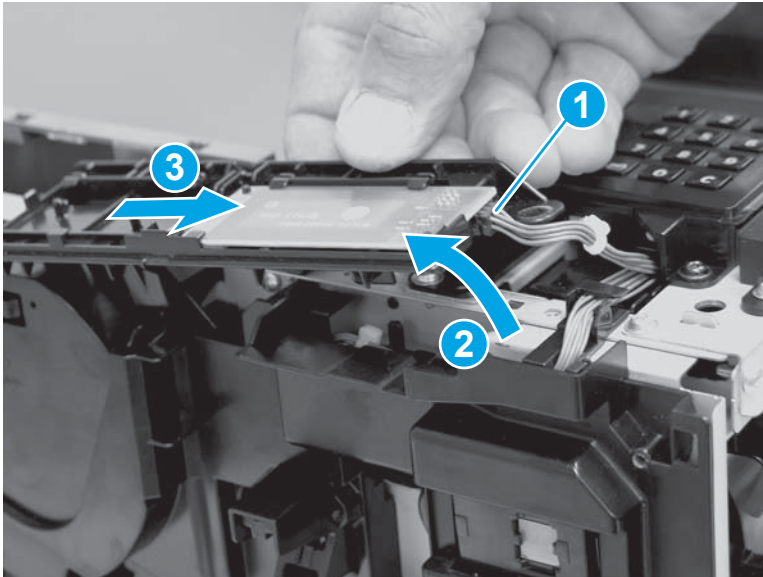

3. Remove one cable from the guide.

Figure 1-3445 Remove one cable



4. Remove four screws (callout 1), and then turn the control panel over (callout 2) to access the bottom side.

CAUTION: The control panel is still attached to the printer. Do not attempt to completely remove the control panel.

Figure 1-3446 Remove four screws

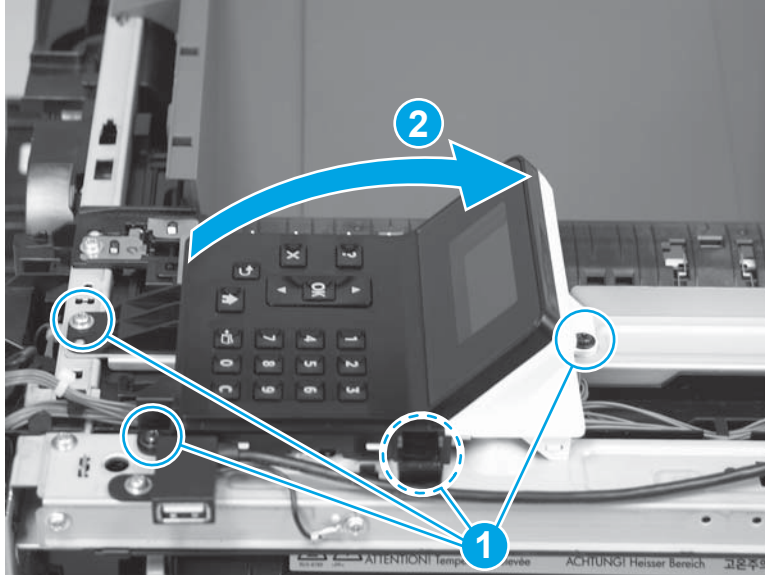

5. Disconnect one connector (callout 1), and then remove the control panel.

Figure 1-3447 Remove the control panel

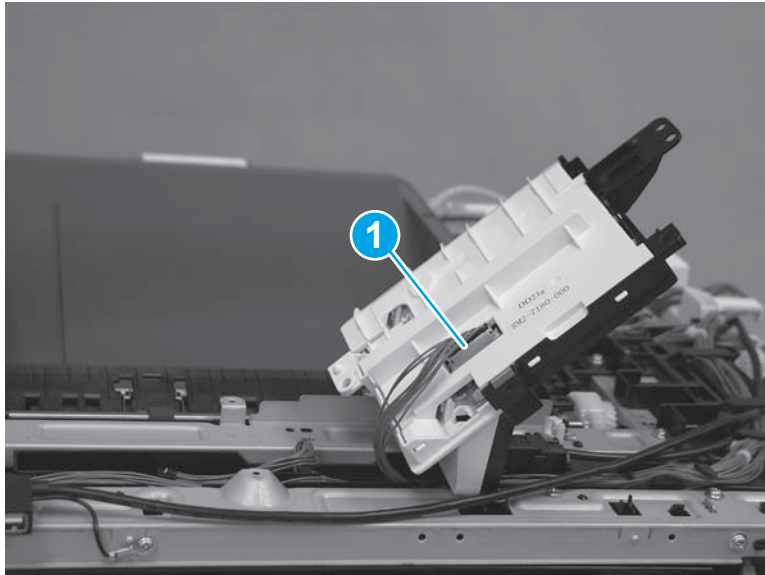

Step 28: Remove the output bin

1. Slightly slide and lift the cover to release it.

Figure 1-3448 Release the cover

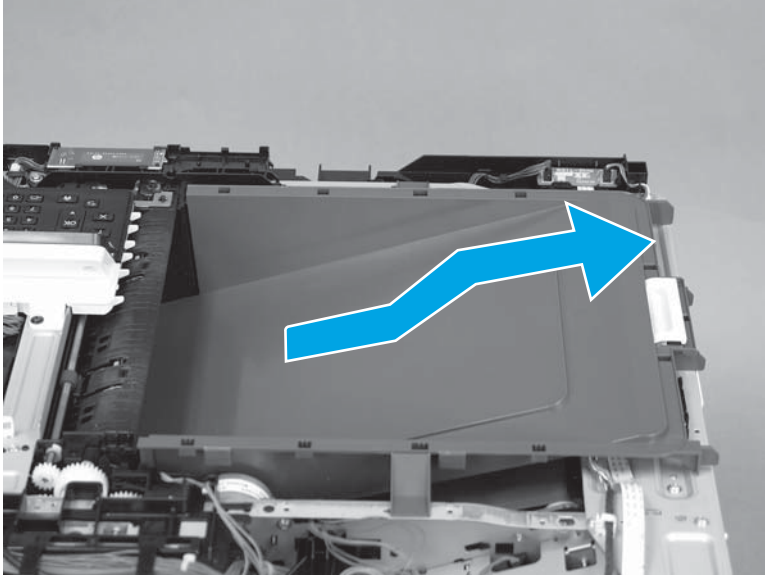

2. Remove the cover.

Figure 1-3449 Remove the cover

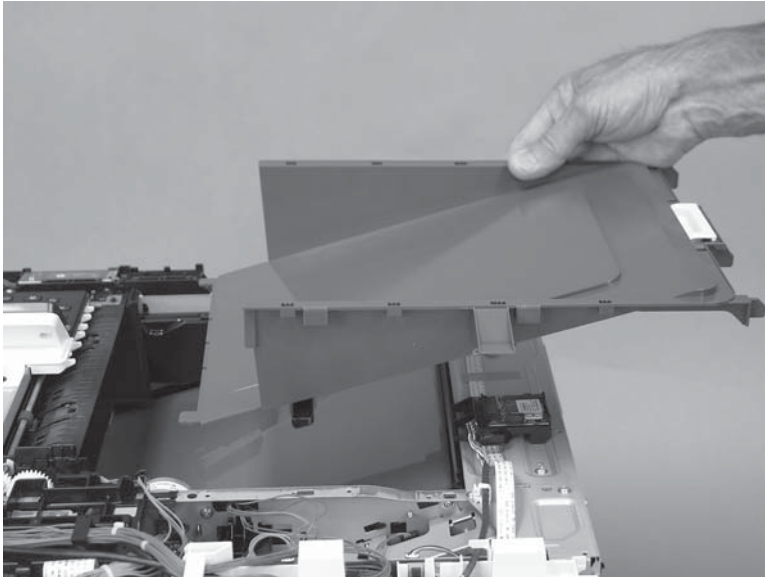

Step 29: Remove the formatter case

1. **M577 only:** Disconnect one connector (callout 1), and then pass the wire harness (callout 2) through two openings in the formatter case (callout 3).

Figure 1-3450 Disconnect one connector

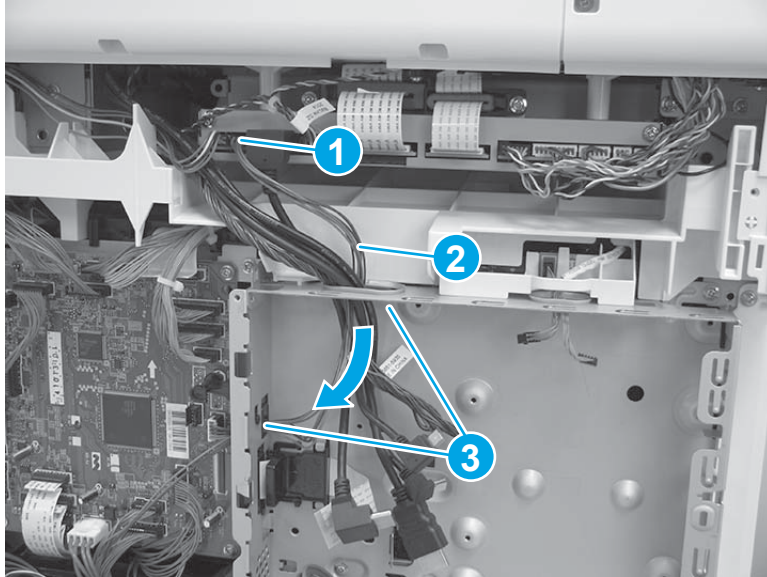

2. Release two tabs (callout 1) on the black plastic bracket. Hold the tabs in the released position, and then slide the bracket (callout 2) to the right to remove it from the formatter case.

Figure 1-3451 Remove the bracket

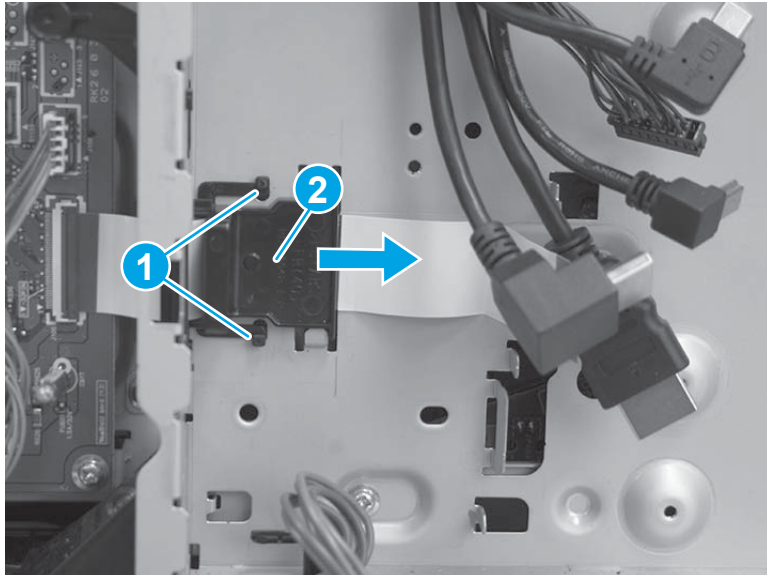

3. Remove two screws (callout 1), and then slide the low-voltage power supply (LVPS) cover to the right to remove it.

Figure 1-3452 Remove the LVPS cover

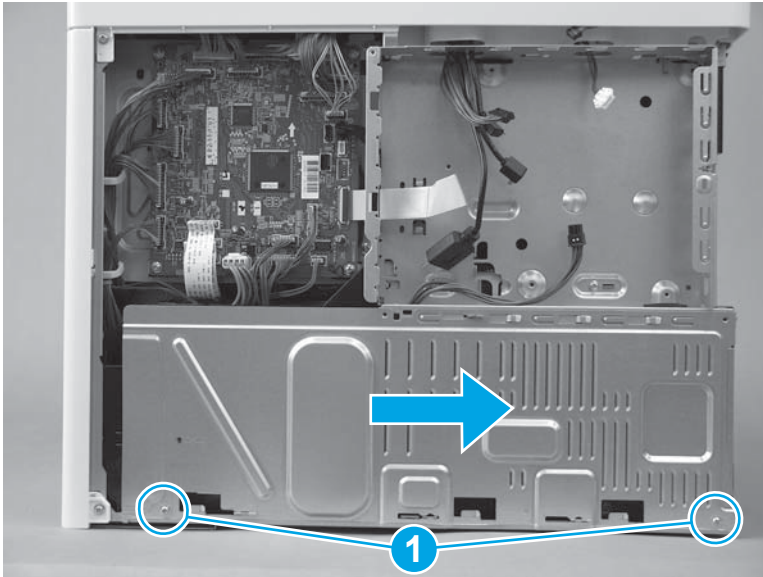

4. Pass two wire harnesses and one flat cable (callout 1) through the opening in the formatter case, and then release one wire harness from the retainer (callout 2).

CAUTION: The flat cable might be attached to the formatter case with double-sided tape. Make sure that this tape is released, so that the flat cable is not damaged when the formatter case is removed.

Figure 1-3453 Release wire harnesses and flat cable

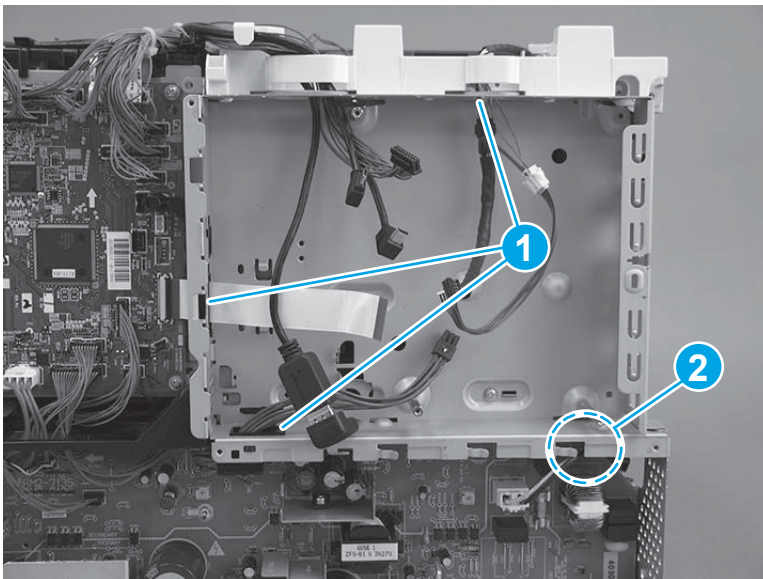

5. Remove six screws (callout 1).

Figure 1-3454 Remove six screws

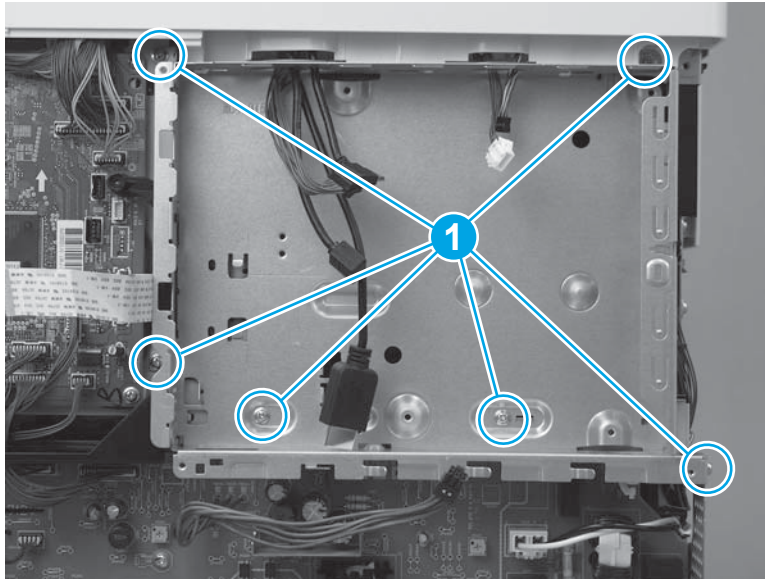

6. Rotate the bottom of the formatter case away from the printer (callout 1), and then pull it down (callout 2) to release it.

Figure 1-3455 Release the formatter case

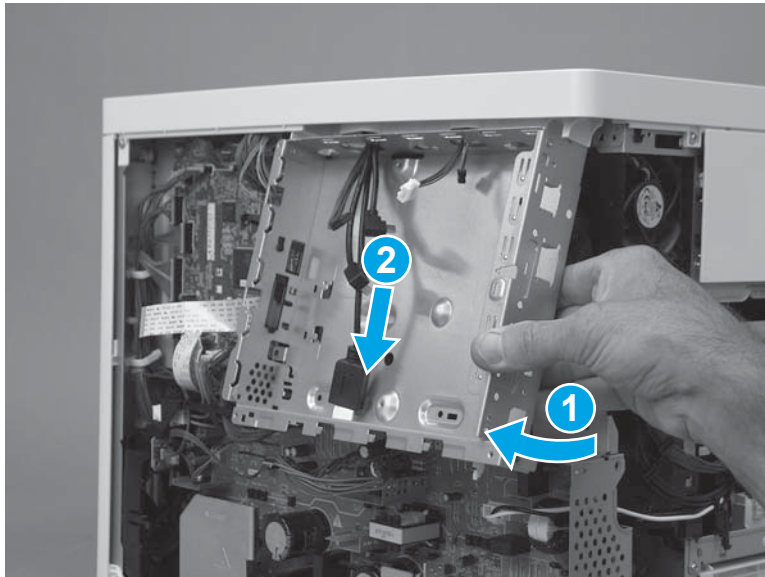

7. Pass the wire harnesses through the opening in the formatter case to remove it.

 **IMPORTANT:** If the formatter case is removed so that it can be replaced, make sure to transfer the memory PCA (island of data) and plastic bracket (callout 1) to the replacement case.

Figure 1-3456 Remove the formatter case



Step 30: Remove the right rear cover

1. Remove one screw (callout 1), and then slide the cover toward the rear of the printer (callout 2) to release it.

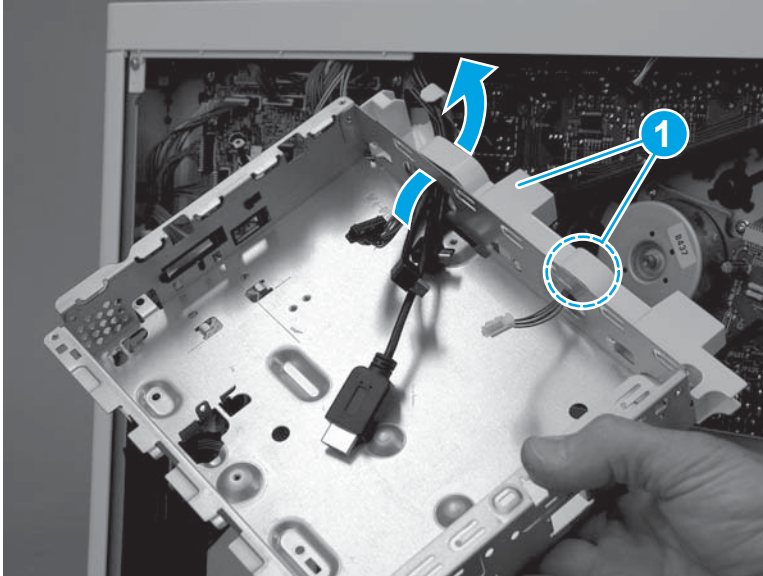
 **TIP:** If the right door is closed, open it now.

Figure 1-3457 Release the cover

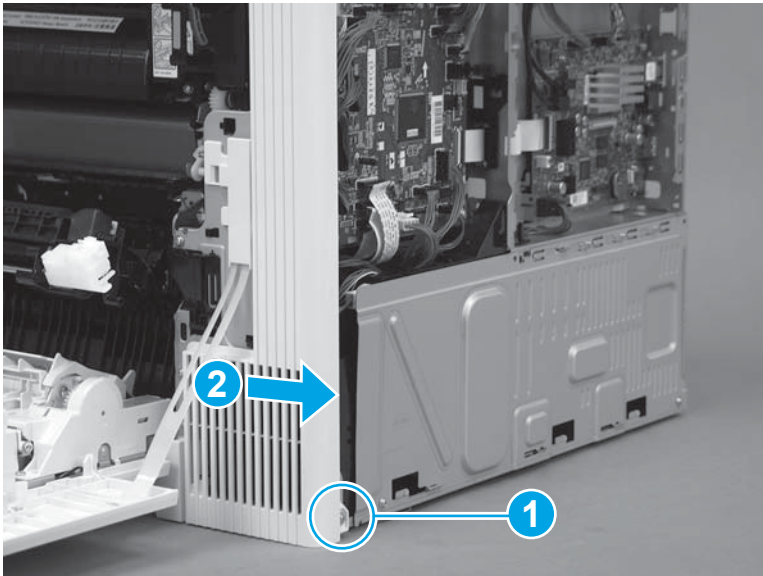

2. Remove the cover.

Figure 1-3458 Remove the cover

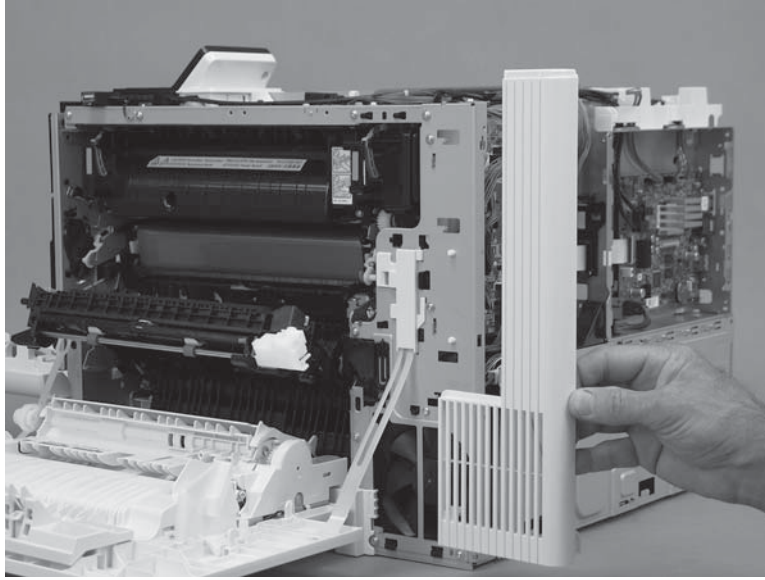

Step 31: Remove the DC controller and sheet-metal bracket

 **NOTE:** Some of the connectors shown in this procedure might already be disconnected. Disconnect all remaining connectors to remove the DC controller.

 **CAUTION:**  ESD sensitive part.

1. Disconnect all of the connectors, and then remove two screws (callout 1).

The following connectors are empty:

- J140, J141, and J143

Figure 1-3459 Remove two screws

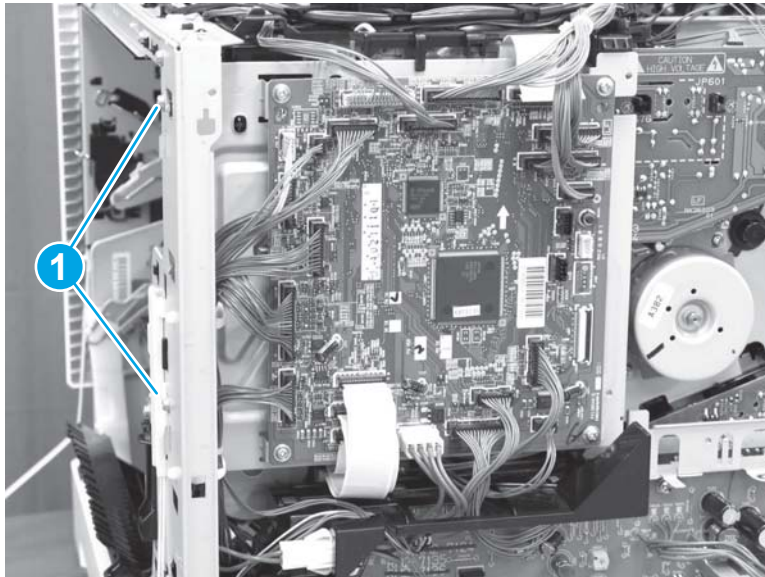

2. Lift up on the DC controller and sheet-metal plate to remove it.

Figure 1-3460 Remove the plate

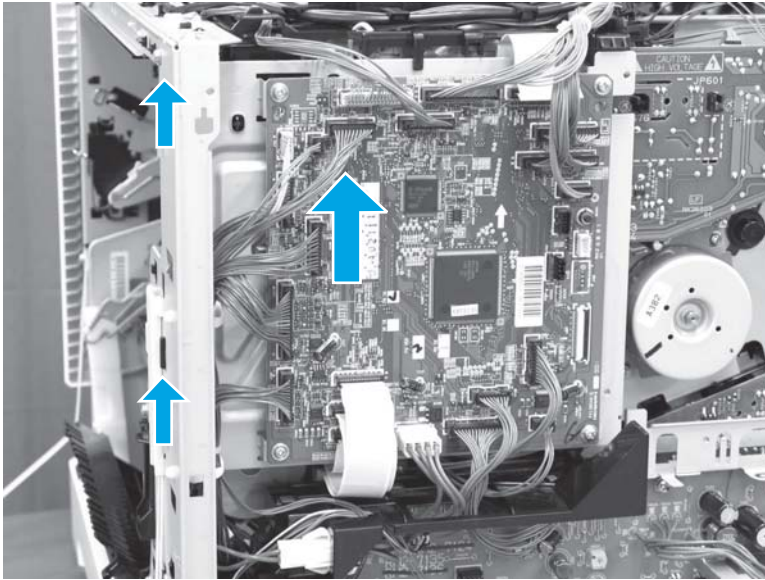

Step 32: Remove the high-voltage power supply T (HVPST)

 **CAUTION:**  ESD-sensitive part.

1. Disconnect five connectors (callout 1), and then disconnect one flat cable (callout 2).

Figure 1-3461 Disconnect five connectors and one flat cable

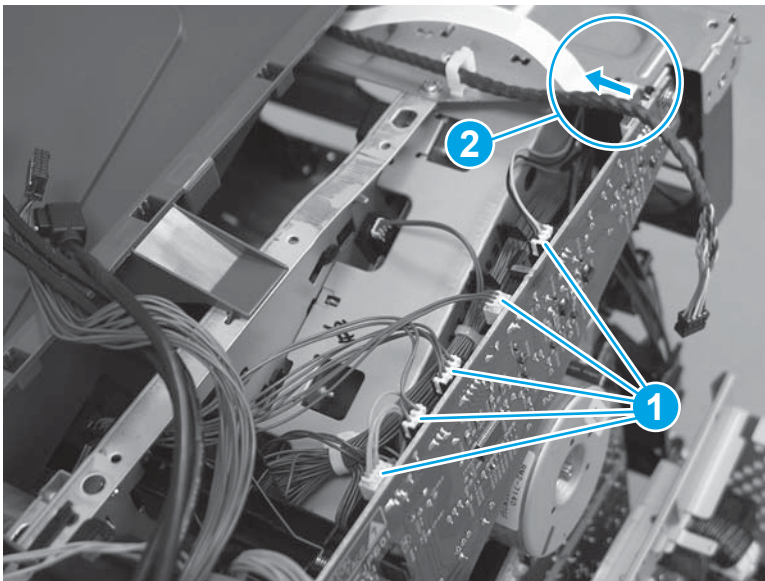

2. Remove one screw (callout 1).

Figure 1-3462 Remove one screw

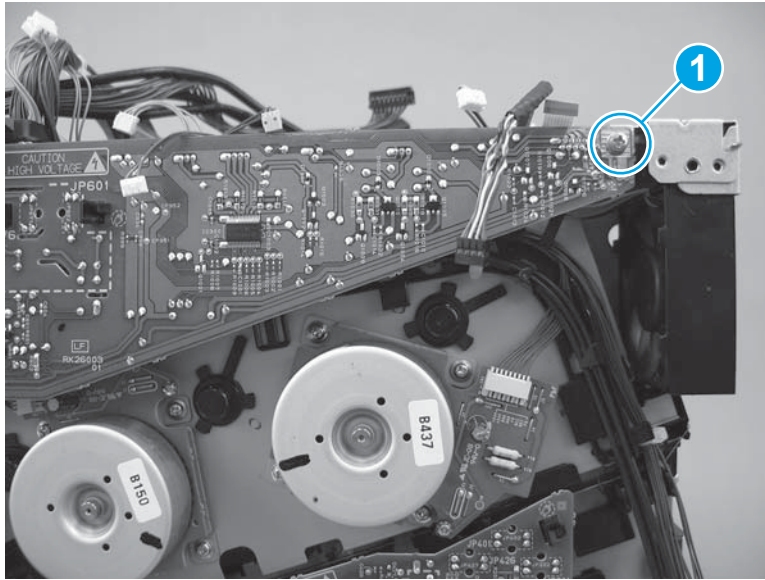

3. Release two tabs (callout 1), and then separate the HVPST from the printer.

⚠ CAUTION: Do not attempt to completely remove the HVPST. It is still connected to the printer by ground wire harness.

Figure 1-3463 Release the HVPST

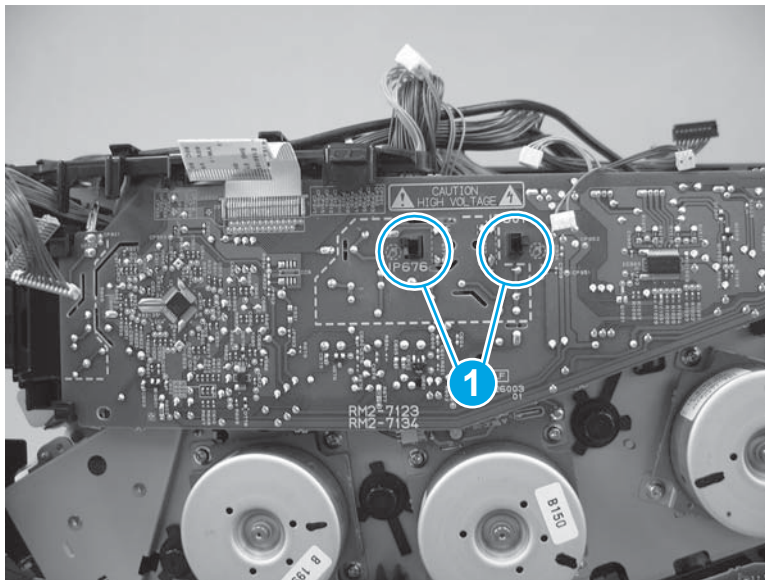

4. Release one ground wire connector (callout 1), and then remove the HVPST.

Figure 1-3464 Remove the HVPST

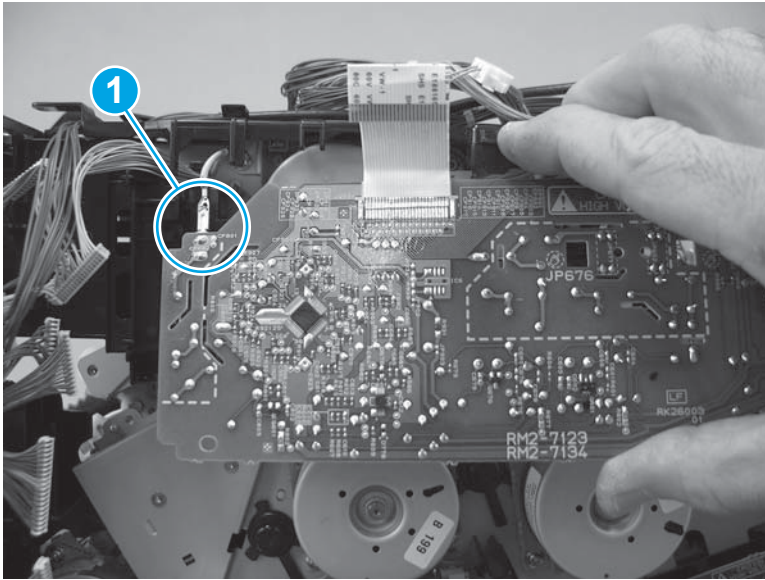

Step 33: Remove the fuser drive assembly

1. Release one tab (callout 1), slide the guide to release it (callout 2), and then rotate the guide up and away from the chassis to move it out of the way (callout 3).

CAUTION: One wire harnesses in the guide is still attached to the fuser motor. Do not attempt to completely remove the guide.

Figure 1-3465 Move the guide out of the way

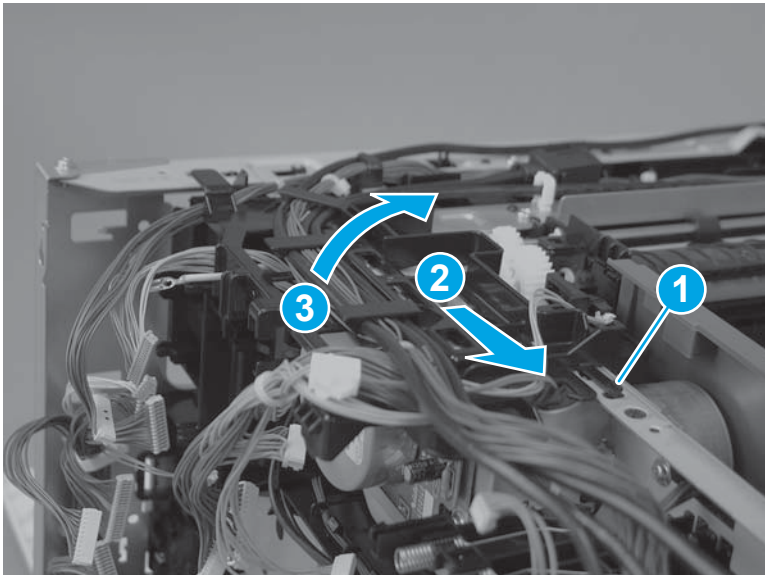

2. Disconnect one connector (callout 1).

Figure 1-3466 Disconnect one connector

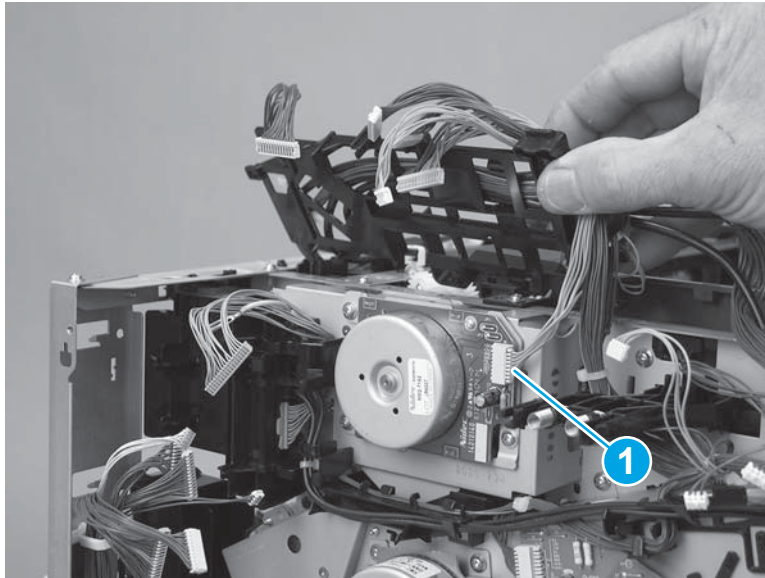

3. Remove one screw (callout 1).

Figure 1-3467 Remove one screw

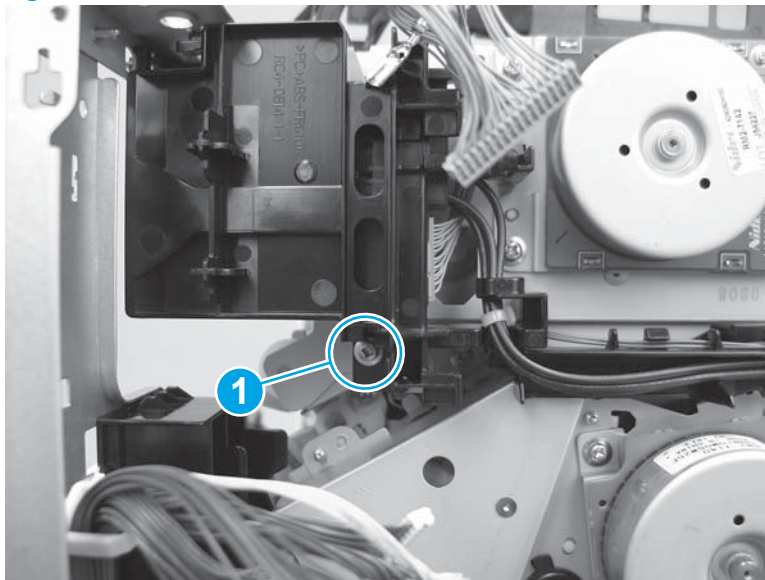

4. Release one tab (callout 1), slide the guide down to release it (callout 2), and then rotate the guide away from the chassis to remove it (callout 3).

Figure 1-3468 Remove the guide

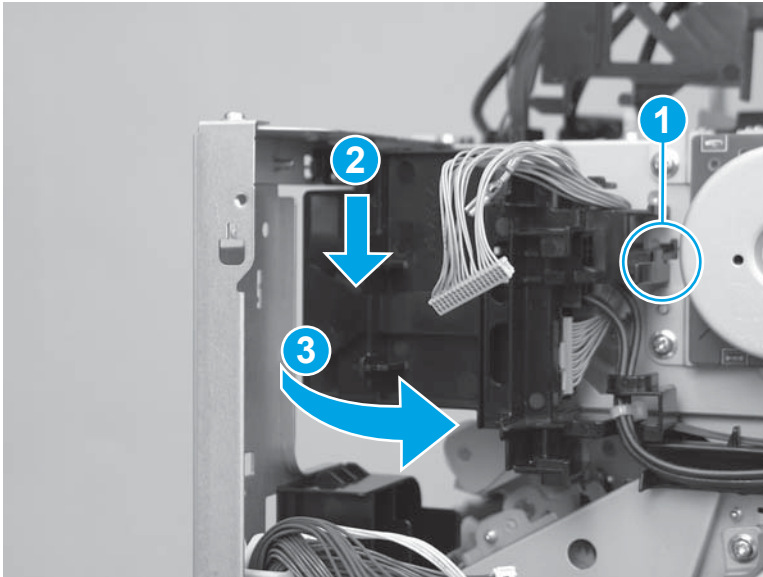

5. Remove three screws (callout 1).

Figure 1-3469 Remove three screws

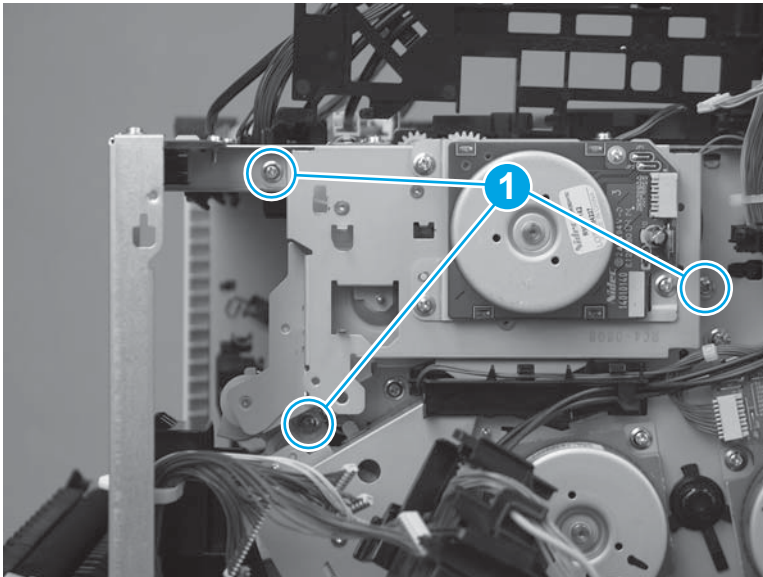

6. Remove the assembly.

CAUTION: Two gears on the back side of the assembly are not captive. Handle the assembly carefully.

Figure 1-3470 Remove the assembly

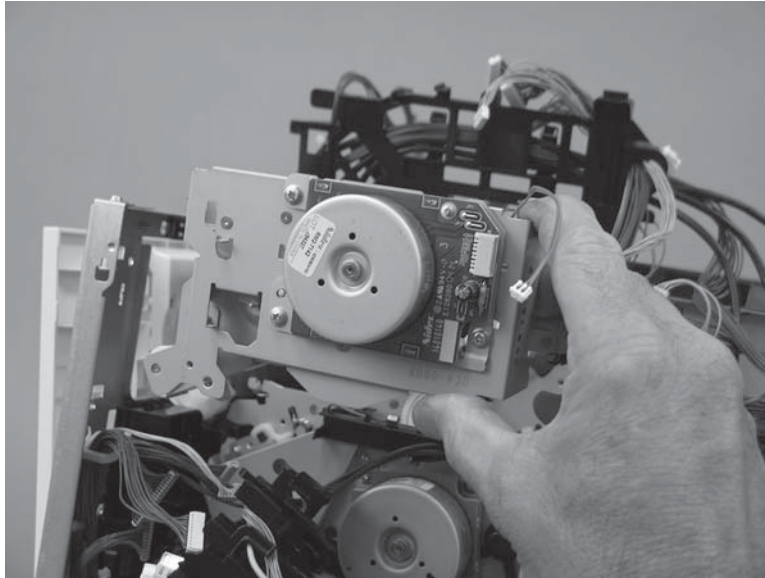

Step 34: Remove the delivery assembly

1. At the right side of the printer, remove two screws (callout 1).

NOTE: These two screws are the self-tapping type.

Figure 1-3471 Remove two screws

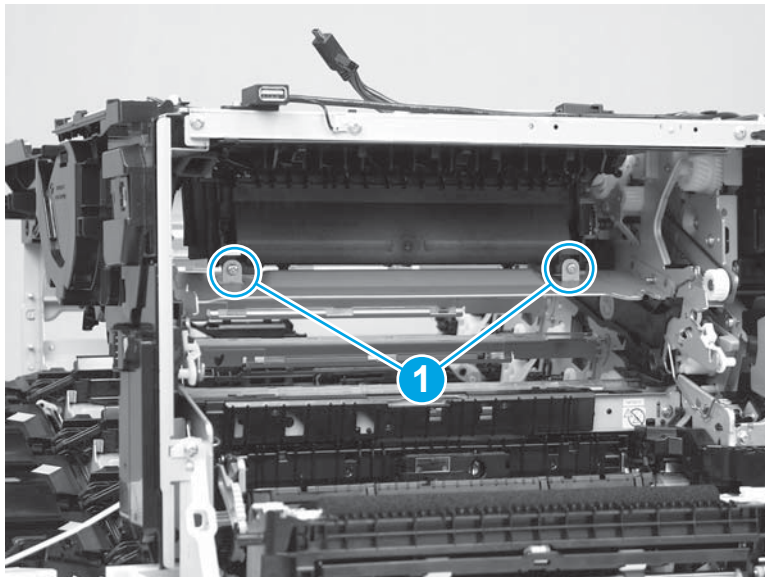

- 2. M553x only:** At the top-front-right corner of the printer, disconnect one connector (callout 1), remove one screw (callout 2), and then remove the near field communication (NFC) PCA and holder by sliding them to the right (callout 3).

Figure 1-3472 Remove the PCA

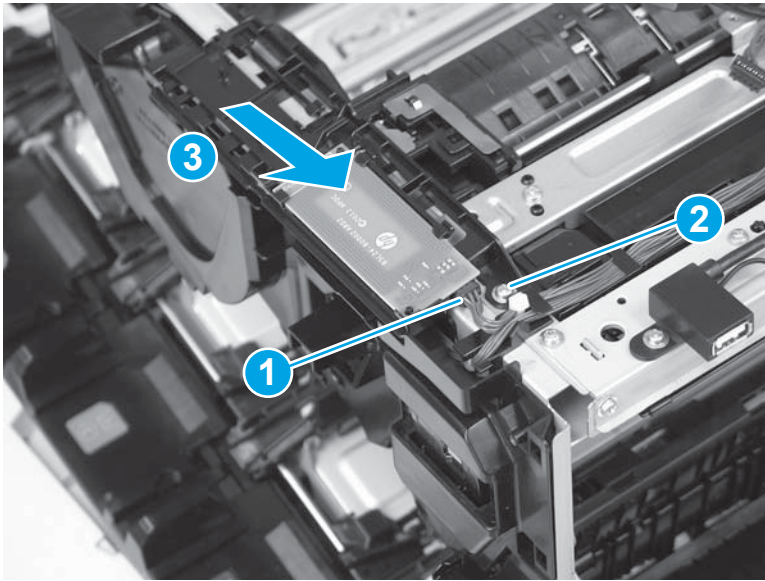

- 3.** Release two retainers (callout 1), remove the USB cable (callout 2) from the retainers, and then disconnect one connector (callout 3).

Figure 1-3473 Release two retainers and disconnect one connector

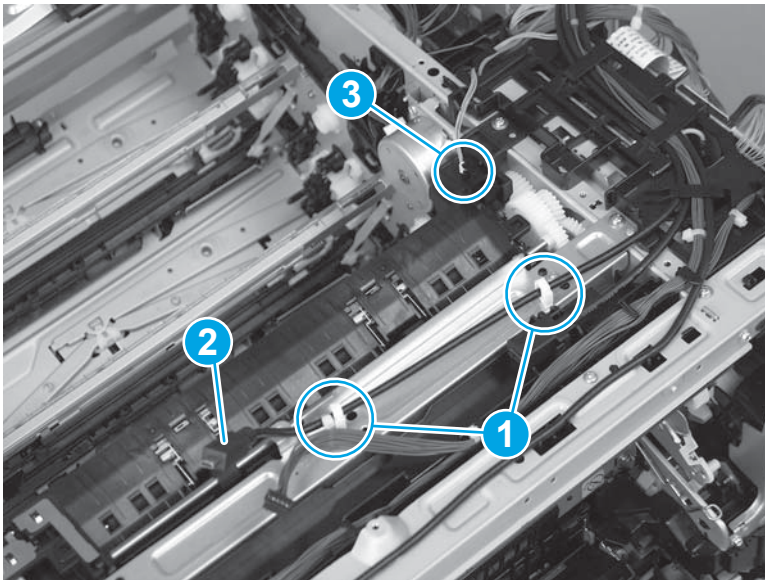

4. Remove four screws (callout 1).

Figure 1-3474 Remove four screws

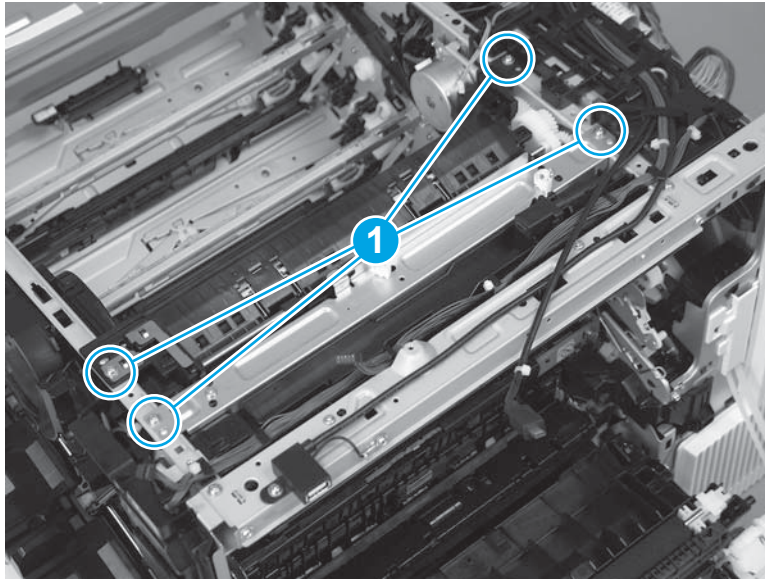

5. Remove the delivery assembly.

 **NOTE:** The solenoid plunger and arm (callout 1) located on the right side of the assembly are not captive. Do not lose the plunger and arm when handling the assembly.

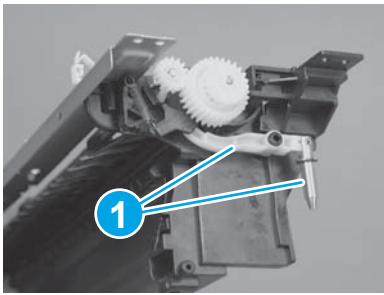
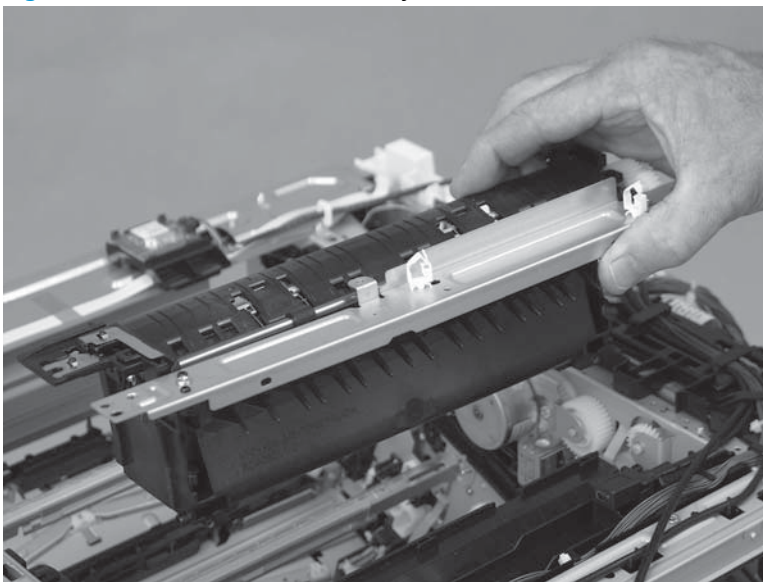

Figure 1-3475 Remove the assembly



Step 35: Remove the duplex drive assembly and motor

1. Remove two screws (callout 1).

Figure 1-3476 Remove two screws

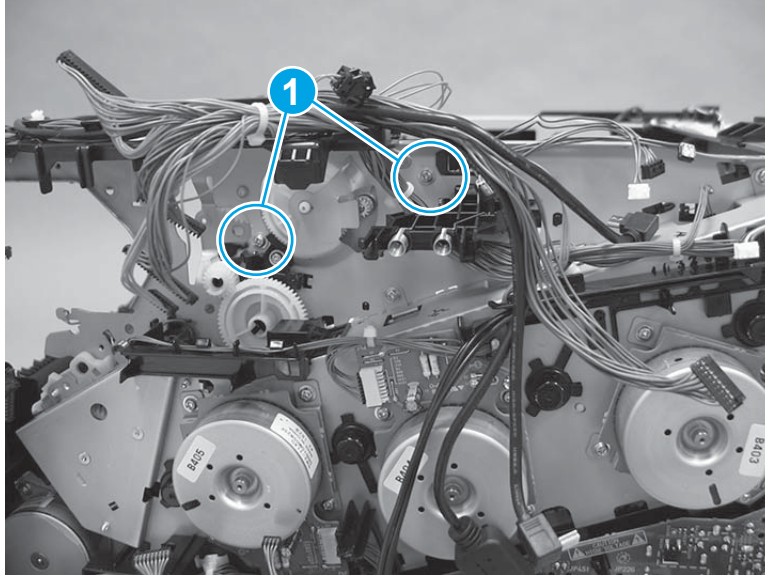

2. Remove the duplex drive assembly.

 **NOTE:** Feed two wire harnesses through the opening in the chassis as the assembly is removed.

Figure 1-3477 Remove the duplex drive assembly



Step 36: Unpack the replacement assembly

Unpack the replacement assembly from the packaging.

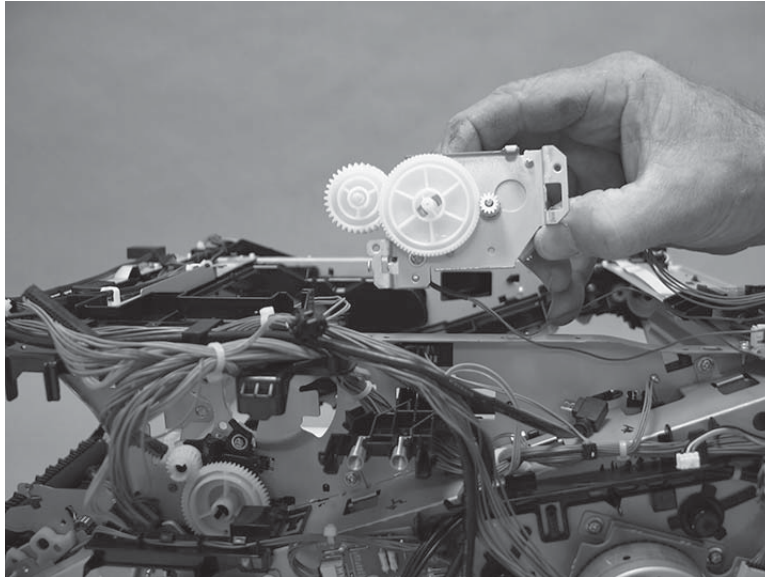
For complete information on HP's recycling programs, go to [Product return and recycling](#).

 **NOTE:** HP recommends responsible disposal of the defective assembly.

Figure 1-3478 Recycle and unpack

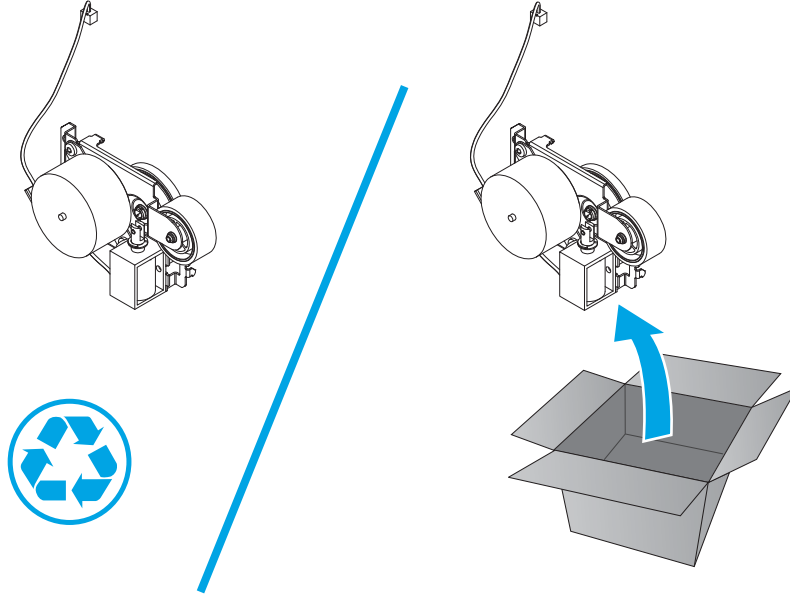

Step 37: Install the duplex drive assembly and motor

1. Install the duplex drive assembly in the printer.

 **NOTE:** Feed two wire harnesses through the opening in the chassis as the assembly is installed.

Make sure that the assembly is tight up against the sheet metal chassis. There should be no gaps between the assembly and the chassis.

Figure 1-3479 Install the duplex drive assembly

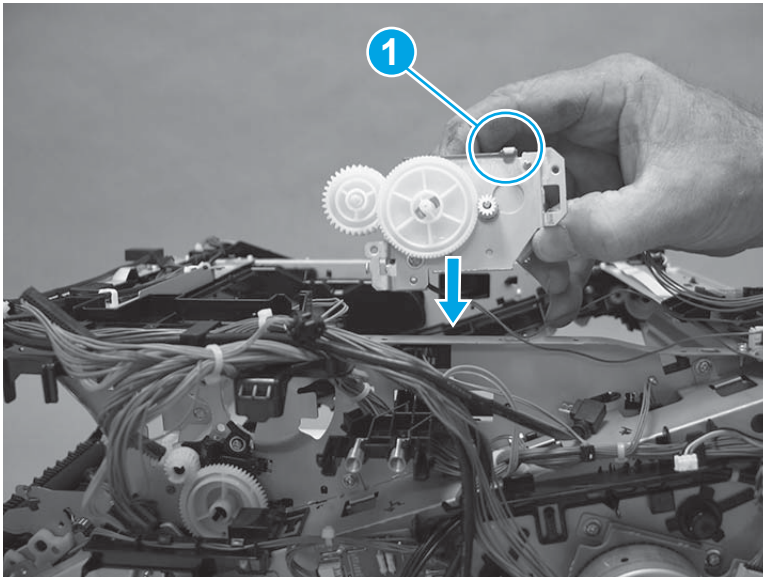

2. Install two screws (callout 1).

Figure 1-3480 Install two screws

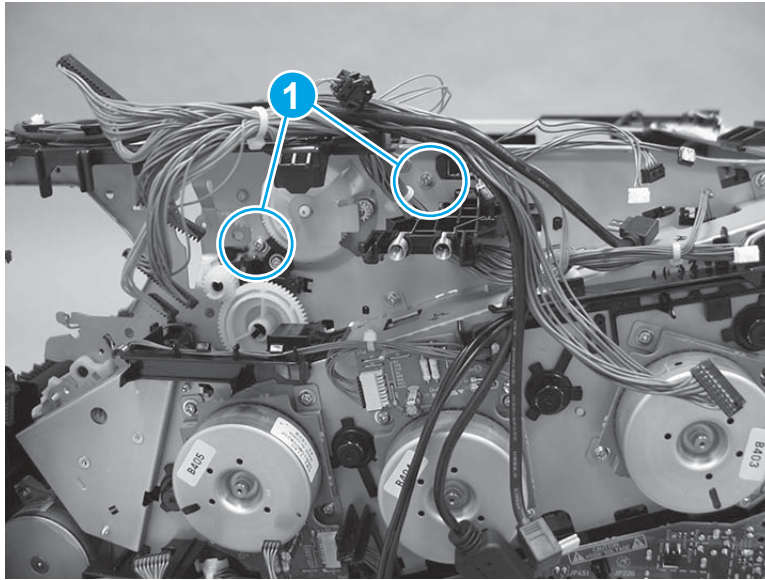

Step 38: Install the delivery assembly

1. Position the delivery assembly on the printer—make sure that the solenoid plunger is placed into the solenoid when the assembly is installed.

Figure 1-3481 Install the assembly

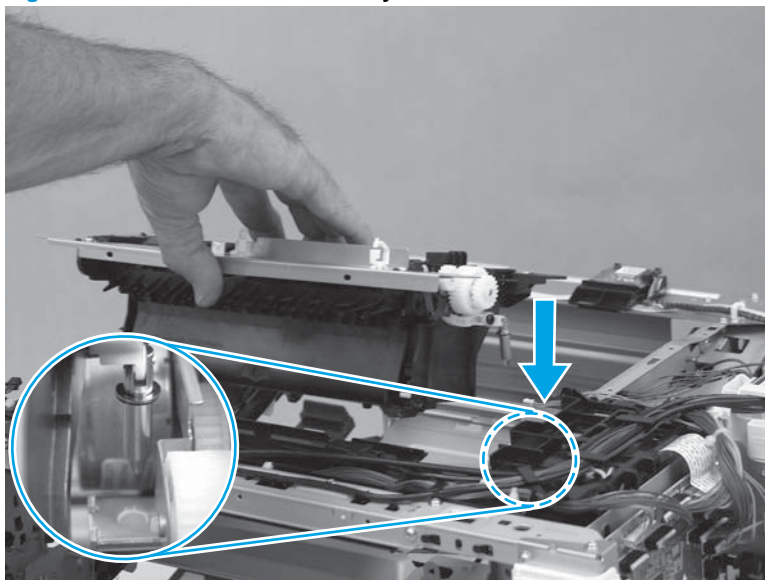

2. Install four screws (callout 1).

Figure 1-3482 Install four screws

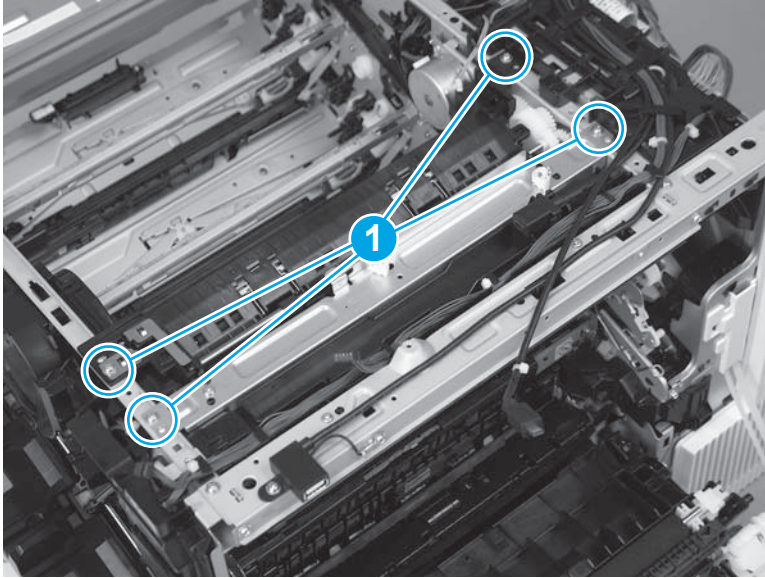

3. Connect one connector (callout 1), and then place the USB cable (callout 2) in the retainers (callout 3).

Figure 1-3483 Connect one connector

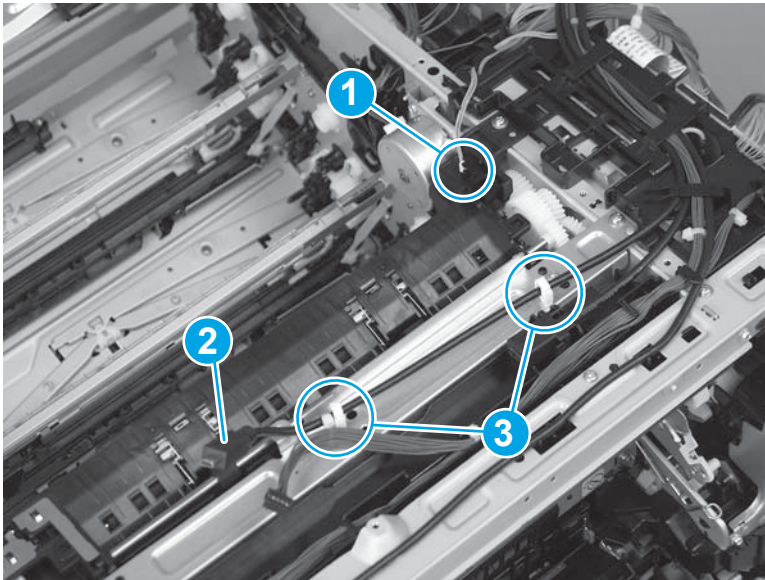

4. **M553x only:** At the top-front-right corner of the printer, install the tab on the NFC PCA holder (callout 1) in the slot (callout 2) in the chassis.

Figure 1-3484 Install the PCA holder

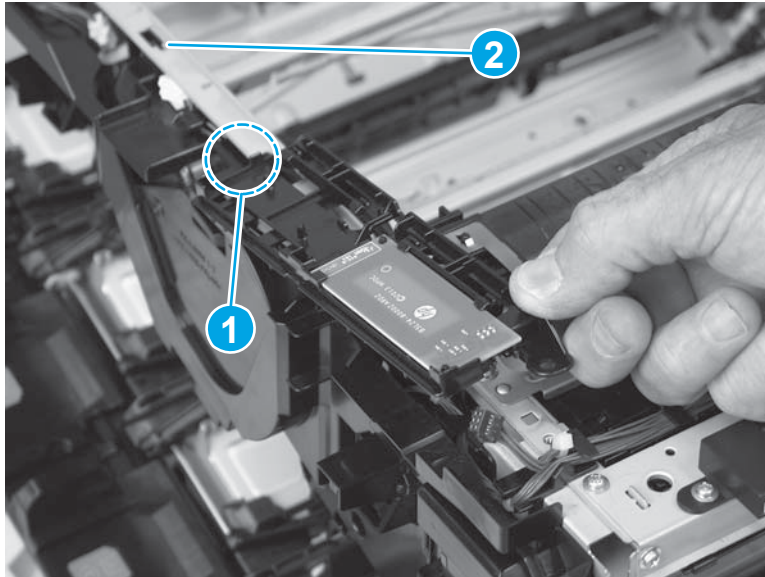

5. **M553x only:** Rotate the NFC PCA holder down (callout 1) to install it, and then install one screw (callout 2).

Figure 1-3485 Install one screw

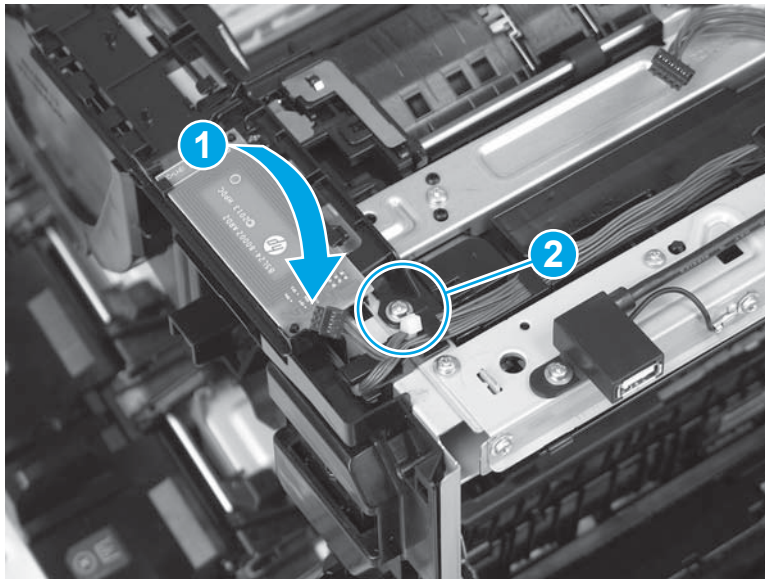

6. **M553x only:** Connect one connector (callout 1) on the NFC PCA.

Figure 1-3486 Connect one connector

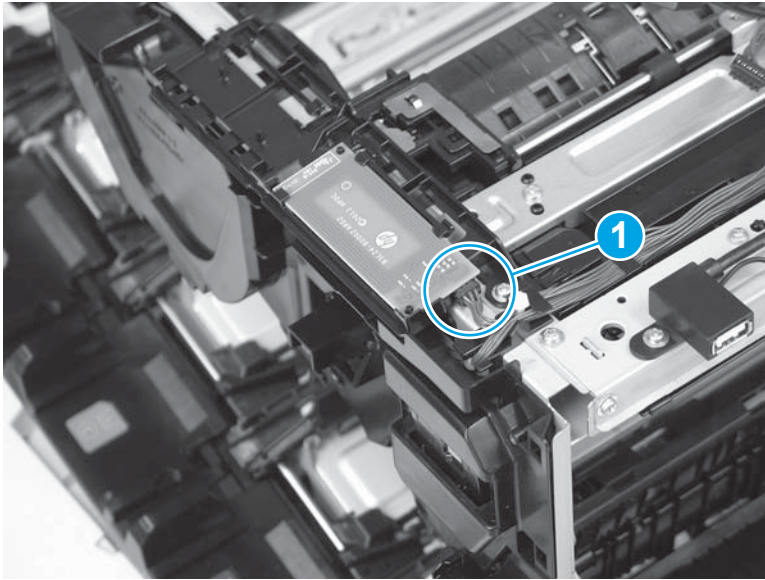

7. At the right side of the printer, install two screws (callout 1).

 **NOTE:** These two screws are the self-tapping type.

Figure 1-3487 Install two screws

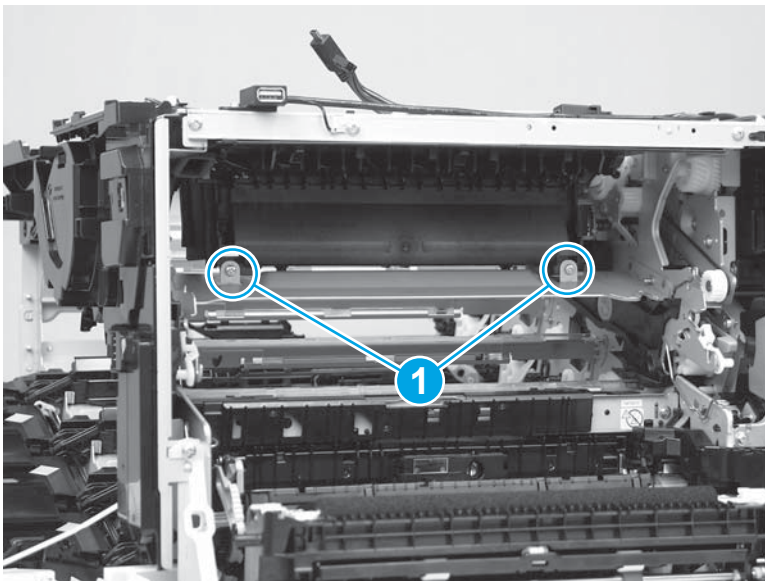

Step 39: Install the fuser drive assembly

1. Two gears (callout 1) on the back side of the assembly are not captive. If the gears are dislodged, install them as shown.

 **CAUTION:** Handle the assembly carefully.

Figure 1-3488 Check the gears on the assembly



2. Position the assembly on the chassis, and then install three screws (callout 1).

Figure 1-3489 Install three screws

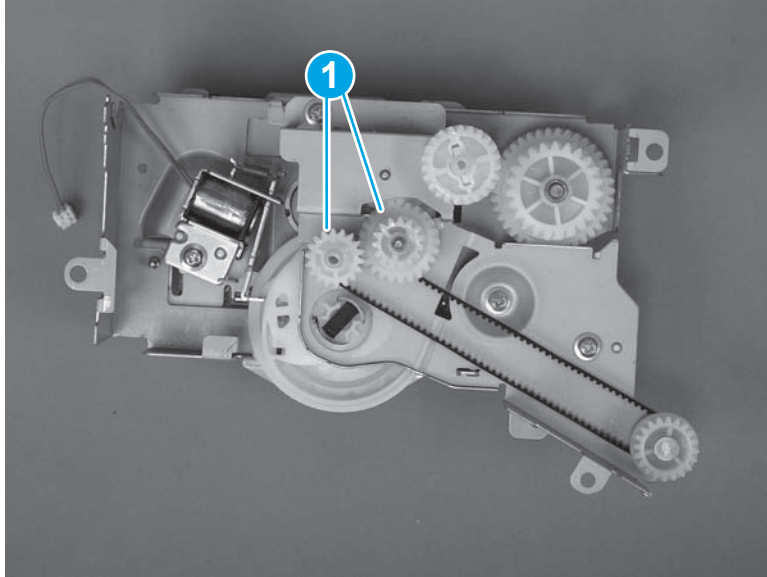
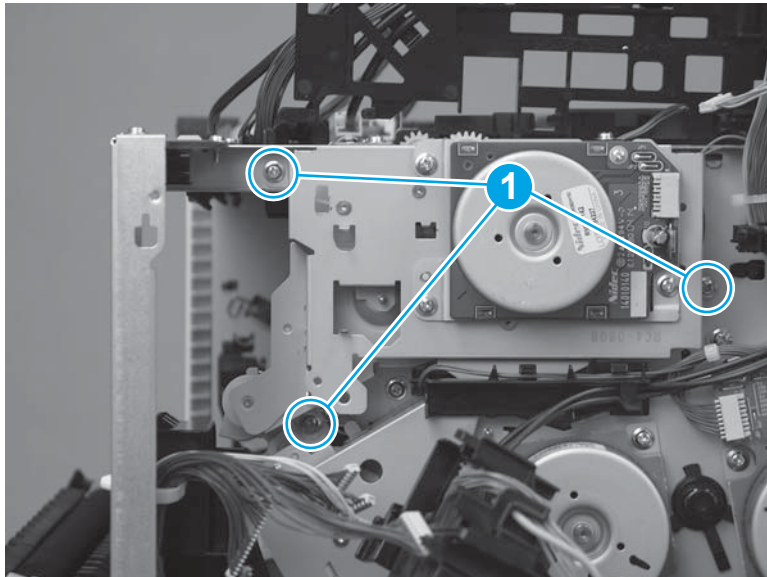

3. Position the guide on the chassis (callout 1), slide the guide up to engage it (callout 2), and then verify that the tab (callout 3) snaps into place.

Figure 1-3490 Install the guide

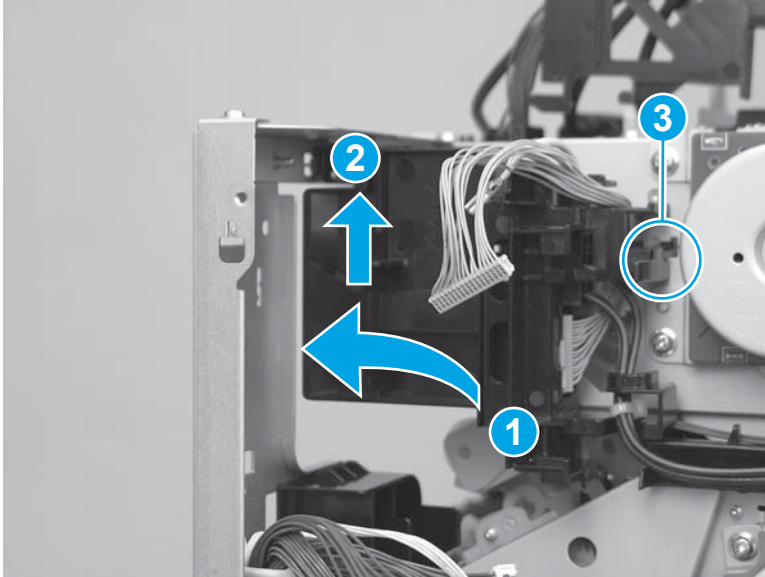

4. Install one screw (callout 1).

Figure 1-3491 Install one screw

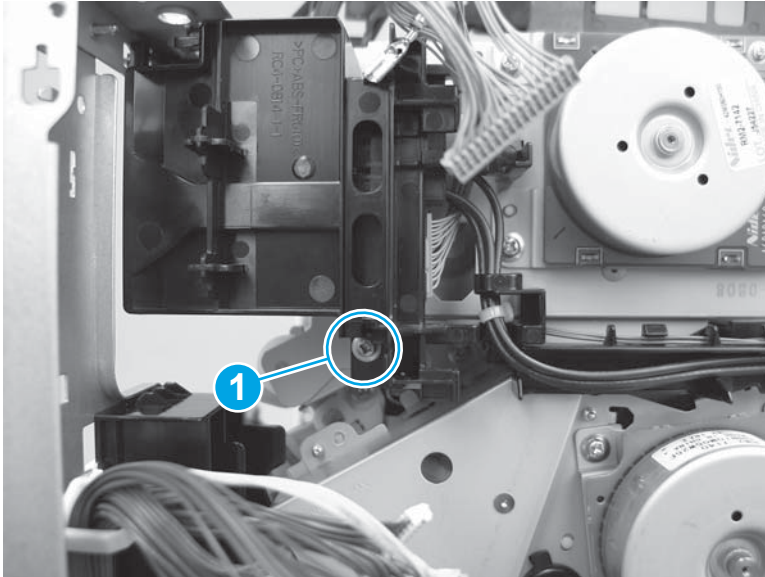

5. Connect one connector (callout 1).

Figure 1-3492 Connect one connector

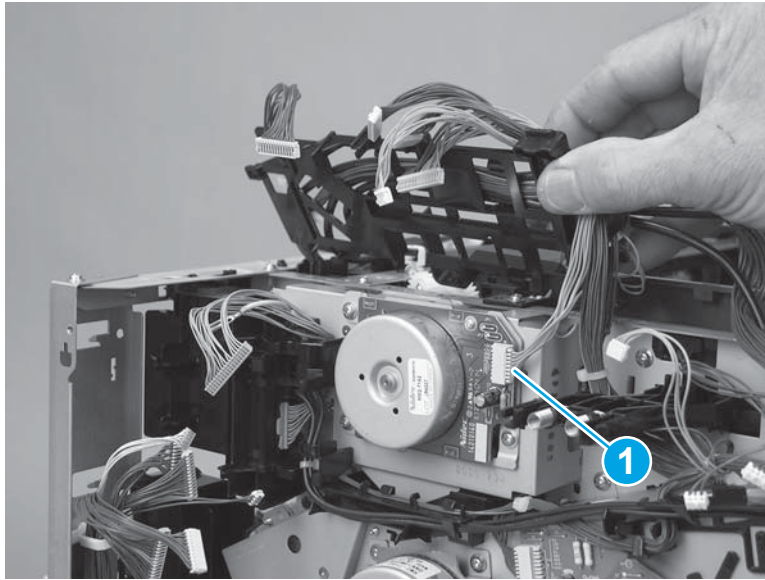

6. Rotate the guide down and onto the chassis (callout 1), slide the guide to engage it (callout 2), and then make sure that the tab (callout 3) snaps into place.

CAUTION: Do not dislodge the fuser motor connector when installing the guide.

Figure 1-3493 Install the guide

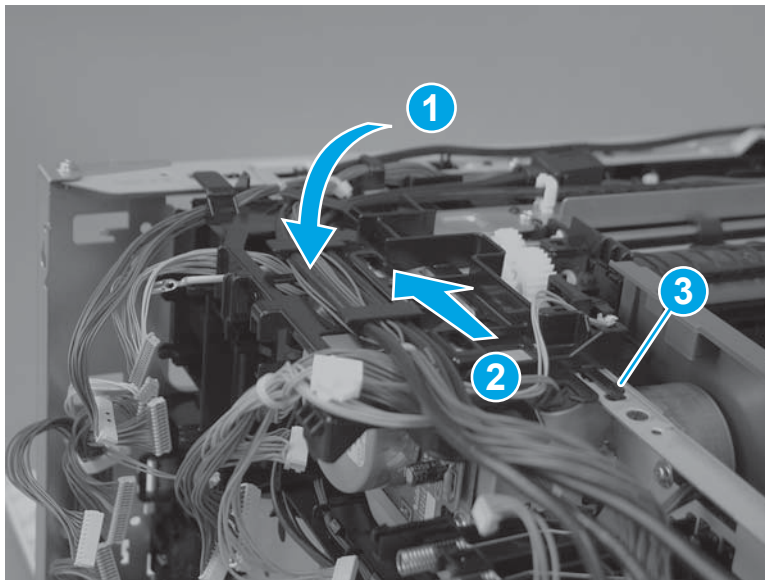

Step 40: Install the HVPST

CAUTION:  ESD-sensitive part.

1. Connect one ground wire connector (callout 1).

Figure 1-3494 Connect one ground wire

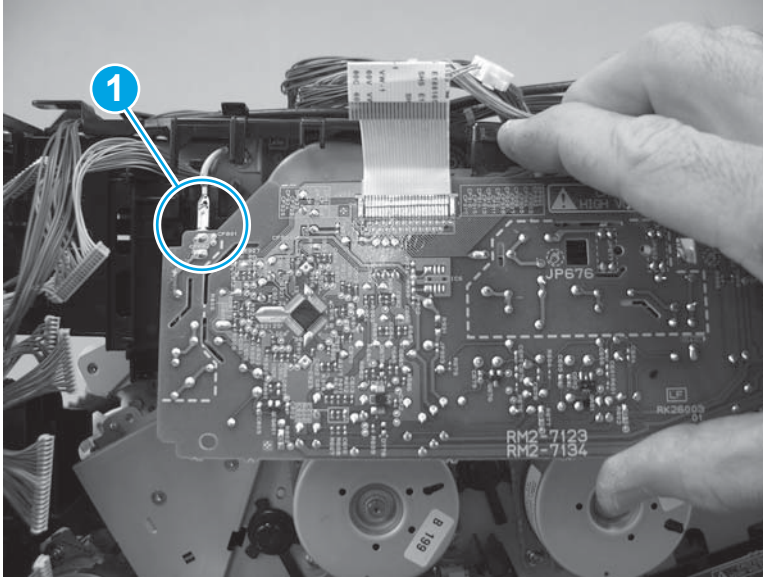

2. Position the HVPST on the printer, and then push in to engage two tabs (callout 1).

 **NOTE:** Make sure that the tabs snap into place.

Figure 1-3495 Install the HVPST



3. Install one screw (callout 1).

Figure 1-3496 Install one screw

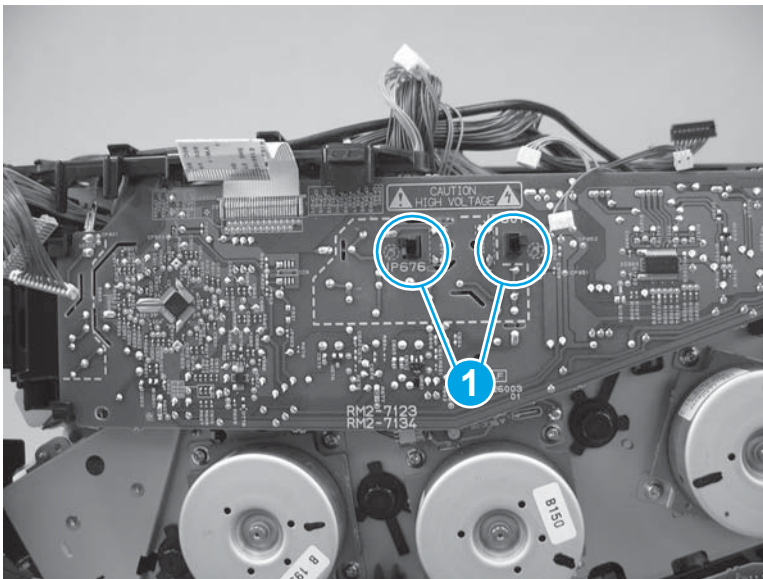
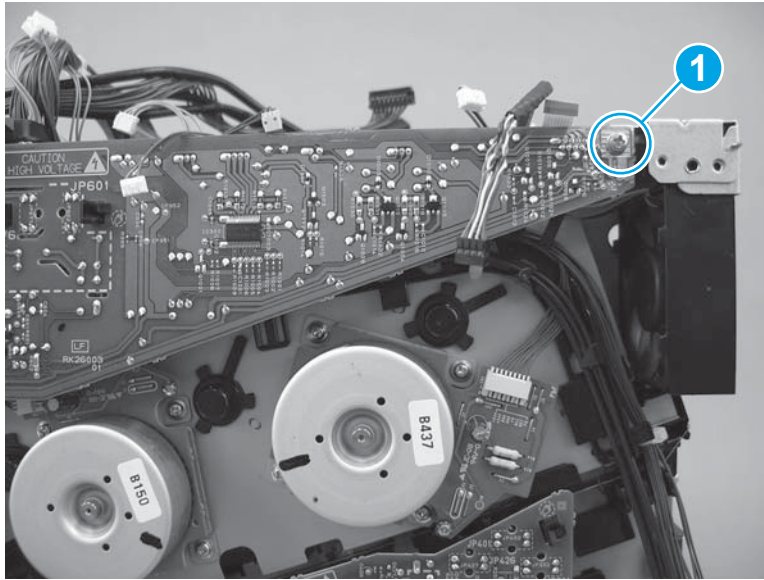

4. Connect five connectors (callout 1), and then connect one flat cable (callout 2).

Figure 1-3497 Connect five connectors and one flat cable

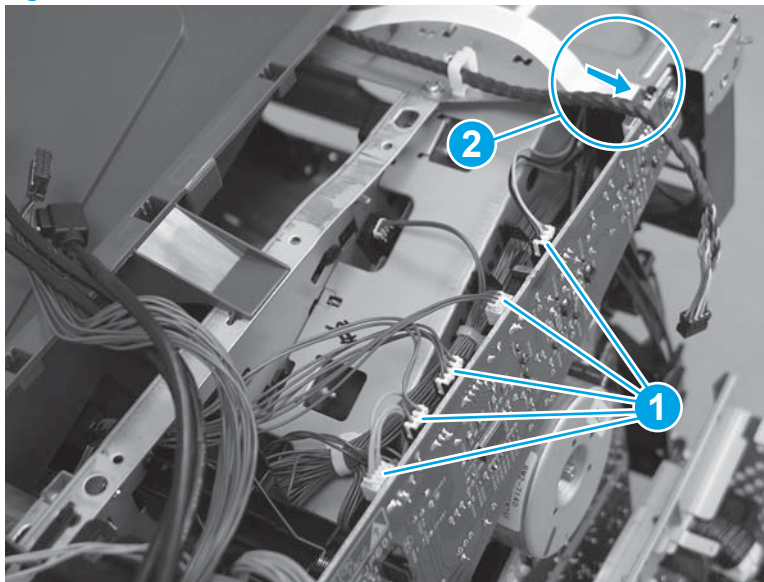

Step 41: Install the DC controller and sheet-metal bracket

 **NOTE:** Some of the connectors shown in this procedure might be connected in subsequent steps as other assemblies are reinstalled. Connect all available connectors to install the DC controller now.

 **CAUTION:**  ESD-sensitive part.

1. Position the DC controller and sheet-metal plate on the printer, and then push down to engage the plate with the chassis.

Figure 1-3498 Install the plate

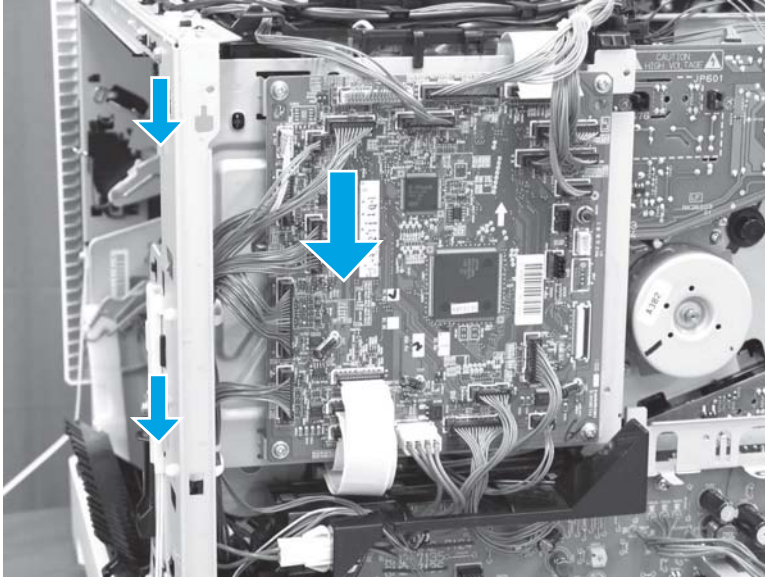

2. Install two screws (callout 1), and then connect all of the connectors.

The following connectors are empty:

- J140, J141, and J143

Figure 1-3499 Install two screws

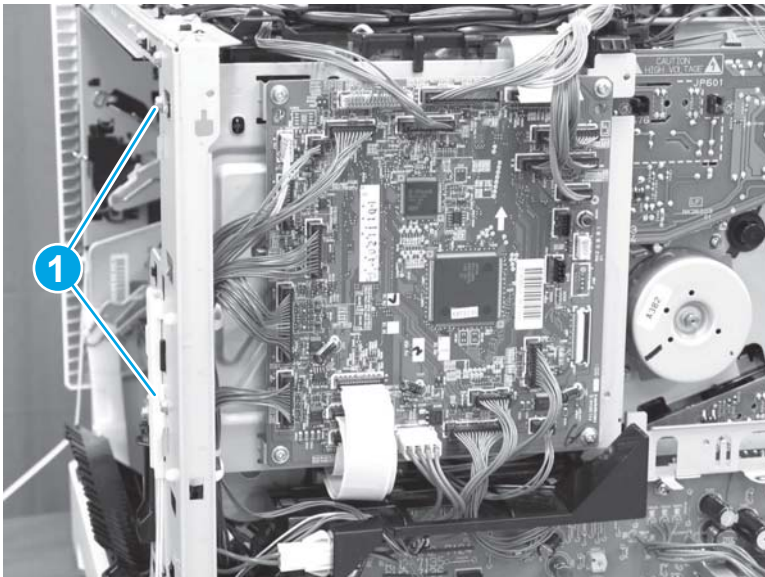

Step 42: Install the right rear cover

1. Position the cover on the printer.

Figure 1-3500 Install the cover

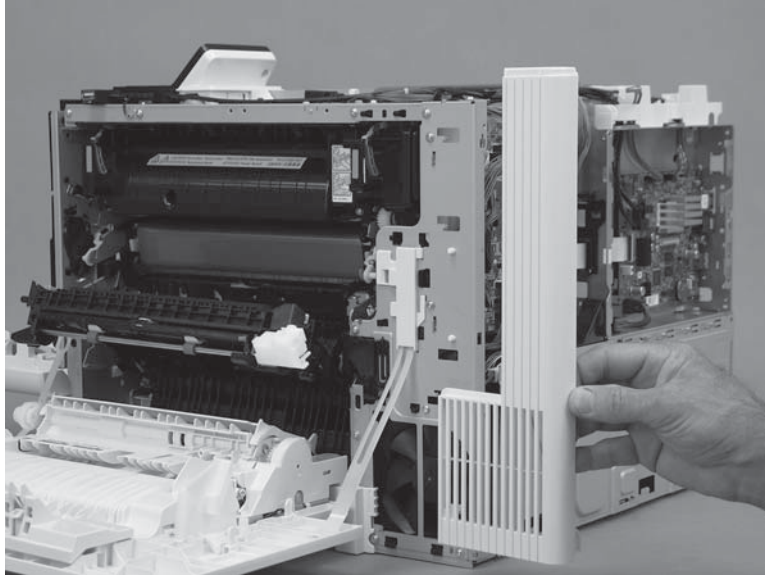

2. Slide the cover toward the right door (callout 1) to engage it with the printer, and then install one screw (callout 2).

Figure 1-3501 Install one screw

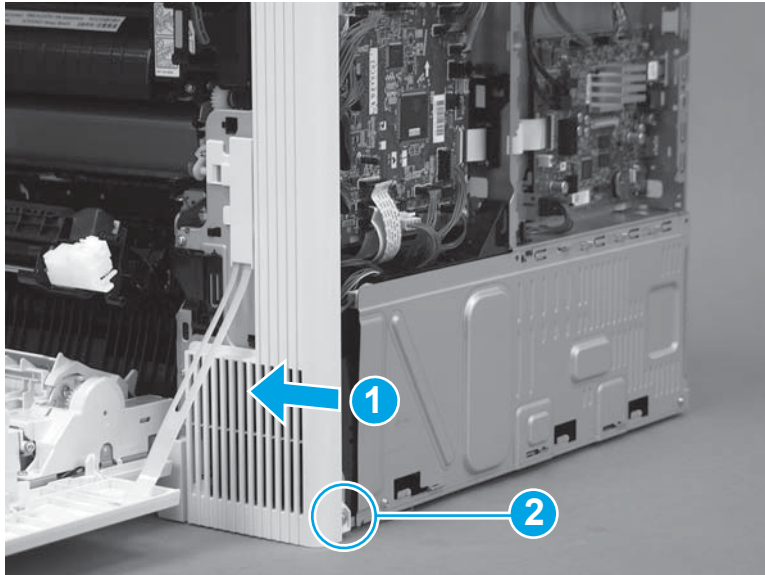

Step 43: Install the formatter case

1. Pass the wire harnesses through the opening in the formatter case.

Figure 1-3502 Pass the wire harnesses through the opening

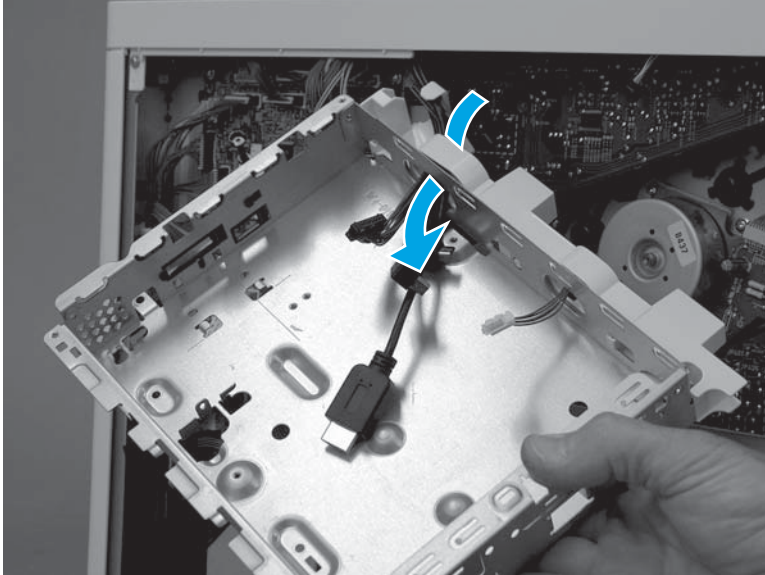

2. Position the top of the formatter case on the printer (callout 1), and then rotate the bottom of the case (callout 2) into the printer.

Figure 1-3503 Install the formatter case

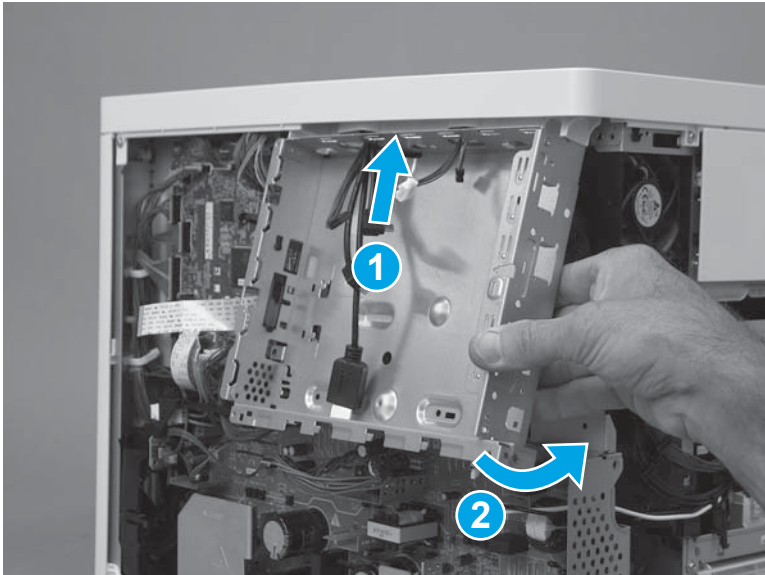

3. Install six screws (callout 1).

Figure 1-3504 Install six screws

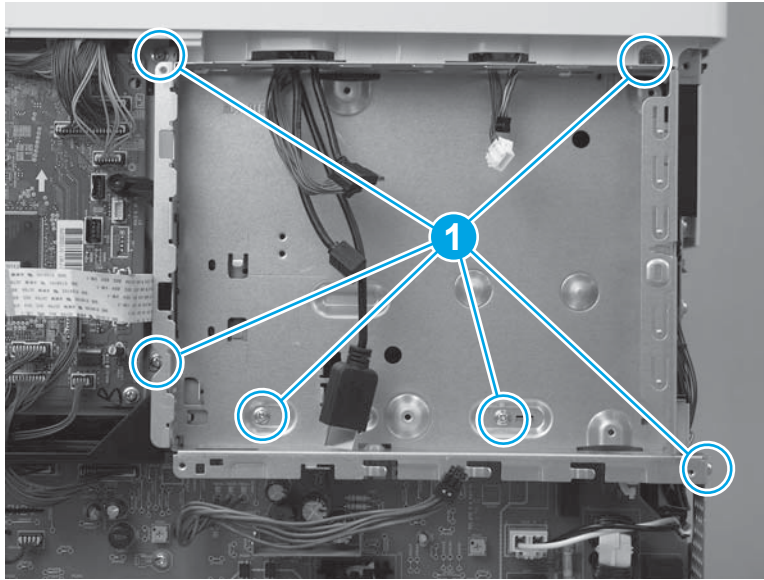

4. Pass two wire harnesses and one flat cable (callout 1) through the opening in the formatter case, and then install one wire harness in the retainer (callout 2).

 **IMPORTANT:** Make sure that the flat cable is securely fastened to the DC controller, and was not dislodged when the formatter case was removed.

Figure 1-3505 Install wire harnesses and flat cable



5. Position the LVPS cover on the printer, slide the cover to the left to install it, and then install two screws (callout 1).

Figure 1-3506 Install the LVPS cover

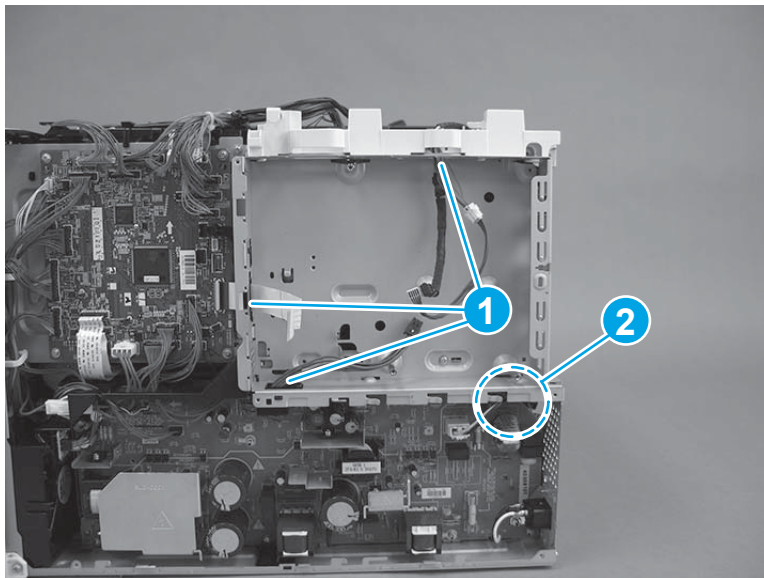
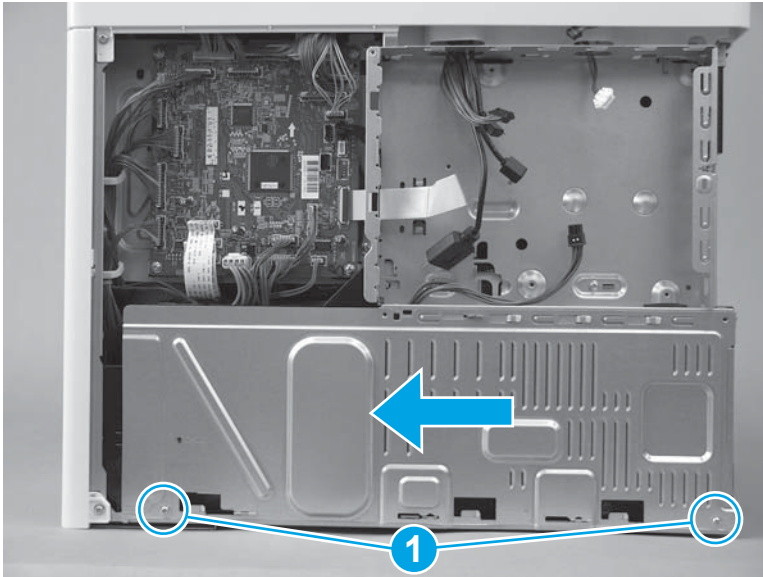

6. If no tape is affixed to the back of the flat cable, skip this step. If double-sided tape is affixed to the back of the flat cable, align the line (callout 1) on the cable with the edge (callout 2) of the opening in the sheet metal. Press to attach the flat cable to the formatter case.

Figure 1-3507 Attach the flat cable

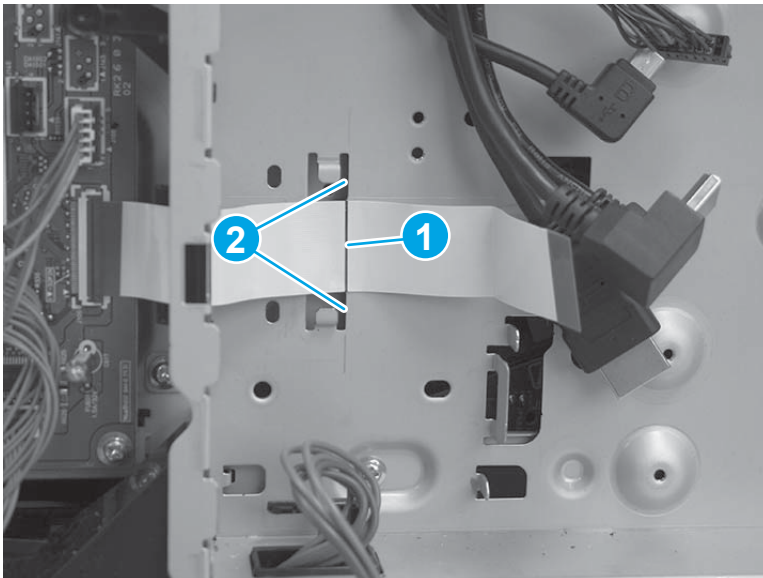

7. Position the bracket over the flat cable, and then slide the bracket to the left to install it. Make sure that the edges of the bracket fit under the sheet metal tabs (callout 1) on the formatter case and that the tabs (callout 2) snap into place.

Figure 1-3508 Position the bracket

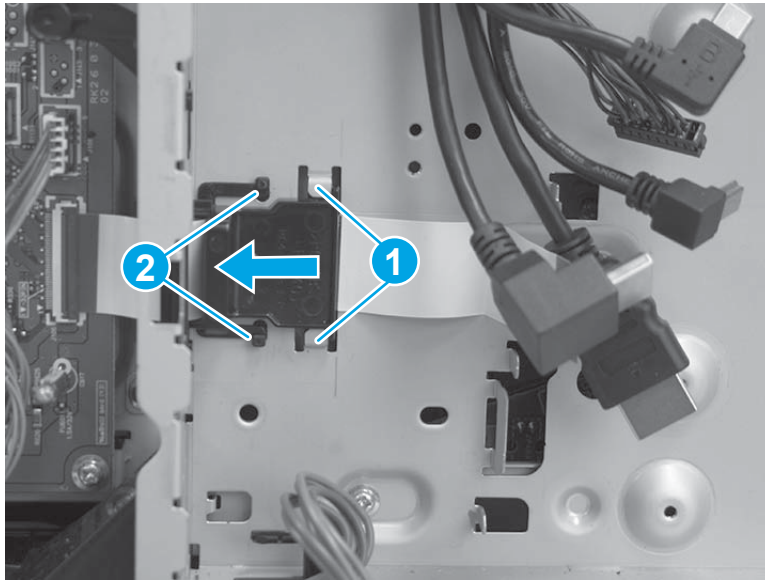

8. **M577 only:** Pass the wire harness (callout 1) through the openings in the formatter case (callout 2), and then connect one connector (callout 3).

Figure 1-3509 Connect one connector

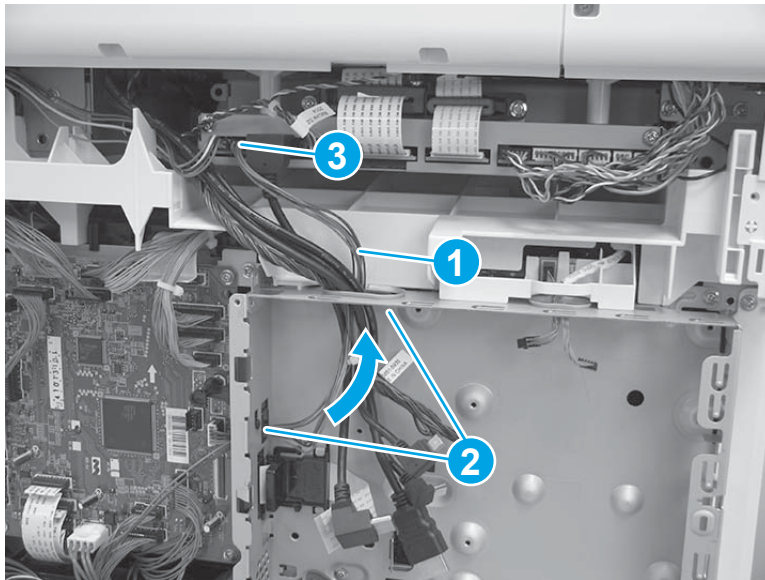

Step 44: Install the output bin

1. Position the cover near the printer.

Figure 1-3510 Install the cover

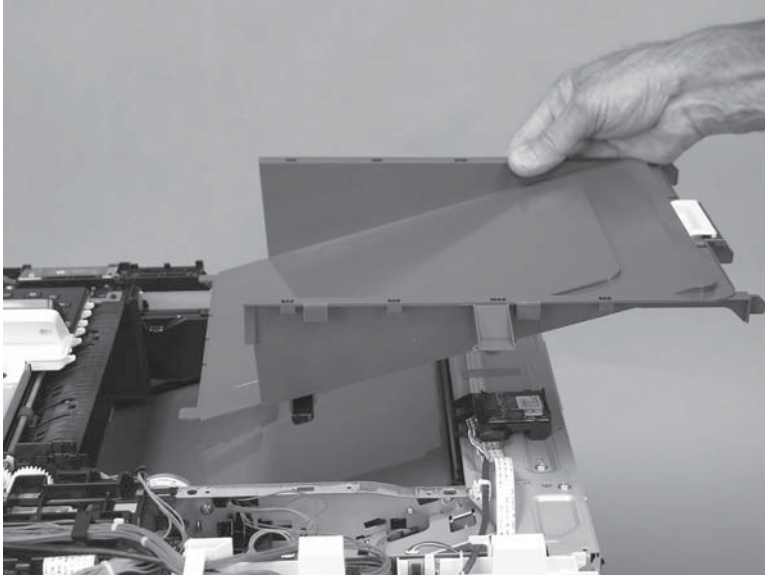

2. Align the tabs on the cover with the slots in the printer.

Figure 1-3511 Align the tabs

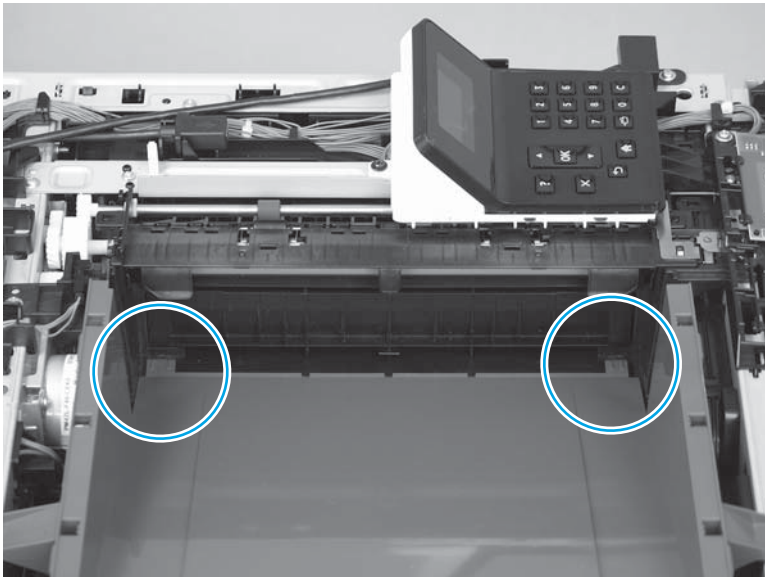

3. Slide and lower the cover onto the printer to install it.

Figure 1-3512 Release the cover

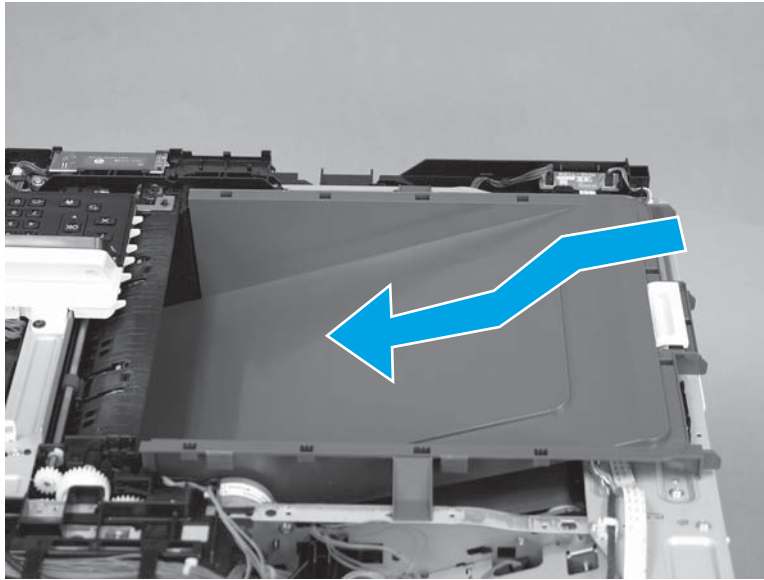

4. Verify that the tabs on the front- and rear-side of the cover are correctly installed in the slots in the chassis.

Figure 1-3513 Verify the installation

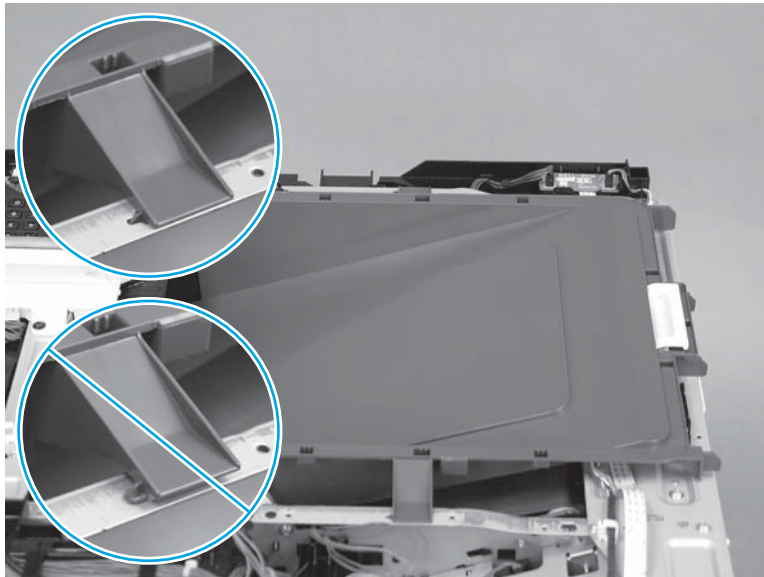

Step 45: Install the control panel (M553n/dn and M552dn only)

 **NOTE:** This step is for the M553n/dn and M552dn models. For the M553x model, skip this step and go to [Step 46: Install the upper cover \(M552 and M553\) on page 1976](#).

For the M577 models, skip this step and go to [Step 47: Install the left cover on page 1978](#).

1. Position the control panel on the printer, and then connect one connector (callout 1).

Figure 1-3514 Connect one connector

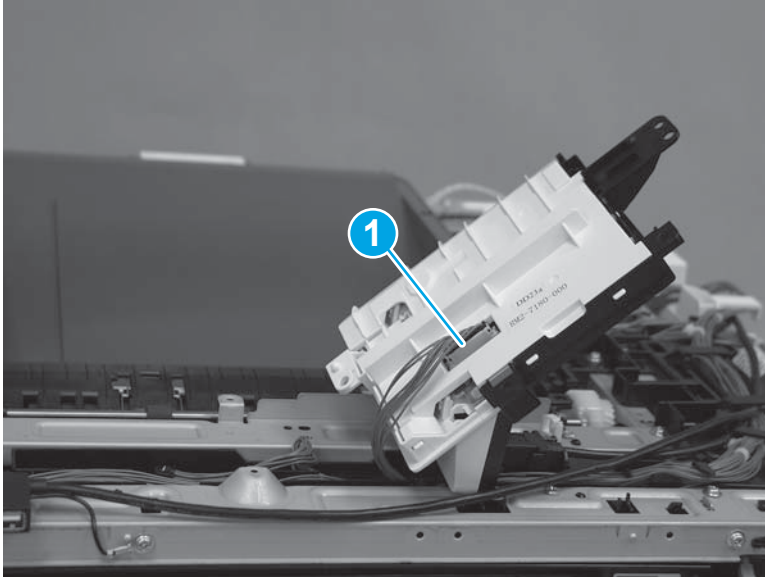

2. Turn the control panel over (callout 1), and then install four screws (callout 2).

Figure 1-3515 Install four screws

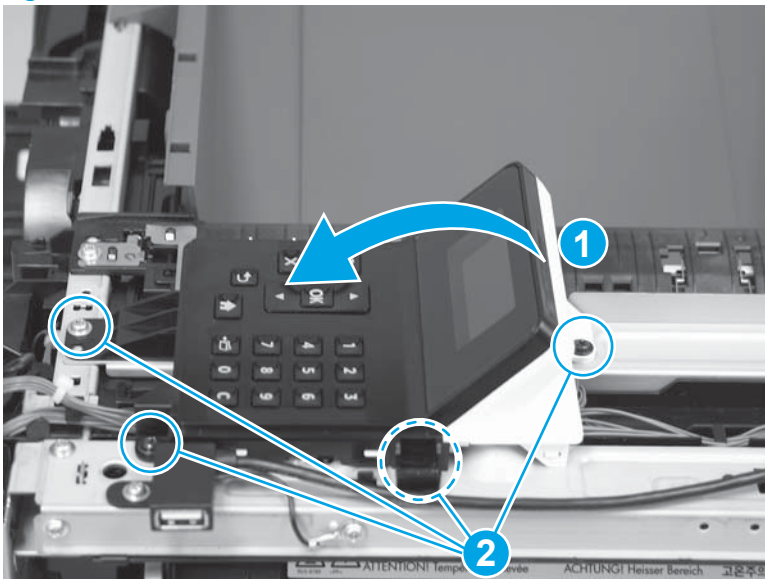

3. Place one cable in the guide.

Figure 1-3516 Place one cable in the guide



4. Install the tab on the NFC PCA holder (callout 1) in the slot (callout 2) in the chassis.

Figure 1-3517 Install the tab

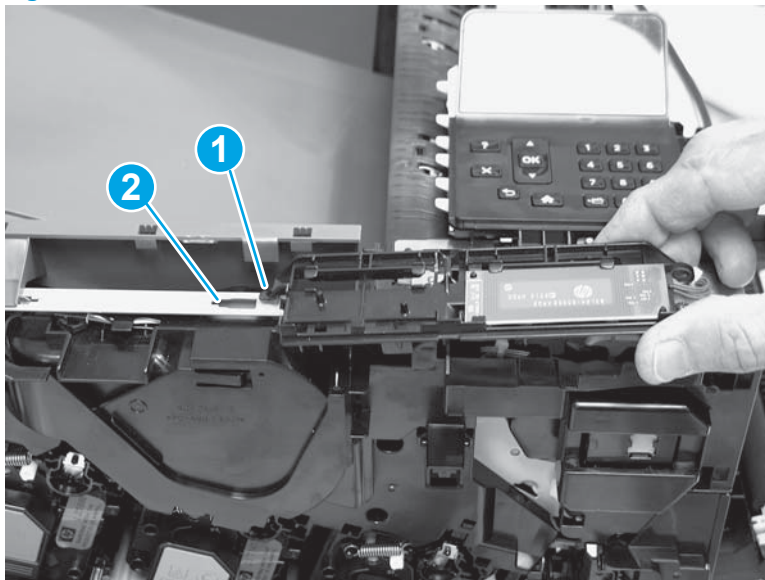

5. Rotate the NFC PCA holder down (callout 1) to install it, connect one connector (callout 2), and then install one screw (callout 3).

Figure 1-3518 Install one screw

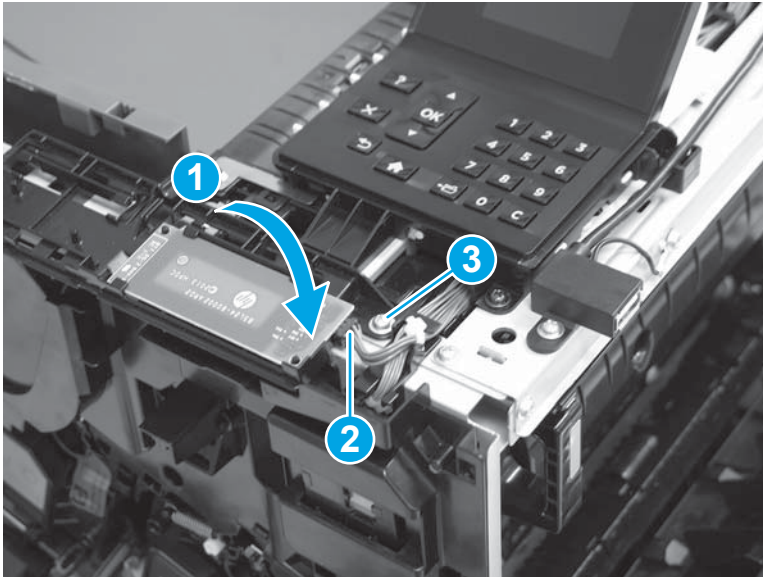

Step 46: Install the upper cover (M552 and M553)

 **NOTE:** This step is for the M552 and M553 models. For the M577 models, skip this step and go to [Step 47: Install the left cover on page 1978](#).

1. Position the cover on the printer.

 **NOTE:** For the M553x model, do not forget to pass the control-panel wire harness and USB cable through the opening in the cover.

Figure 1-3519 Install the cover



2. Push down on the rear corner of the cover to engage one tab (callout 1).

Figure 1-3520 Engage one tab

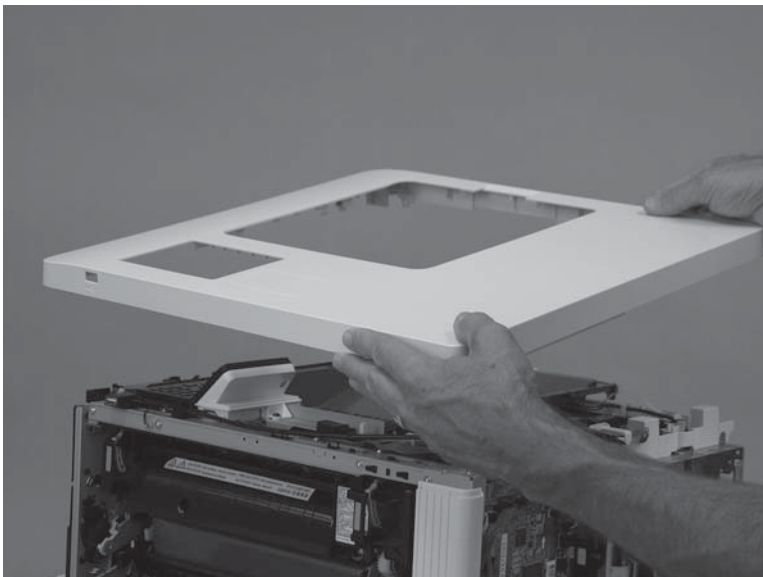
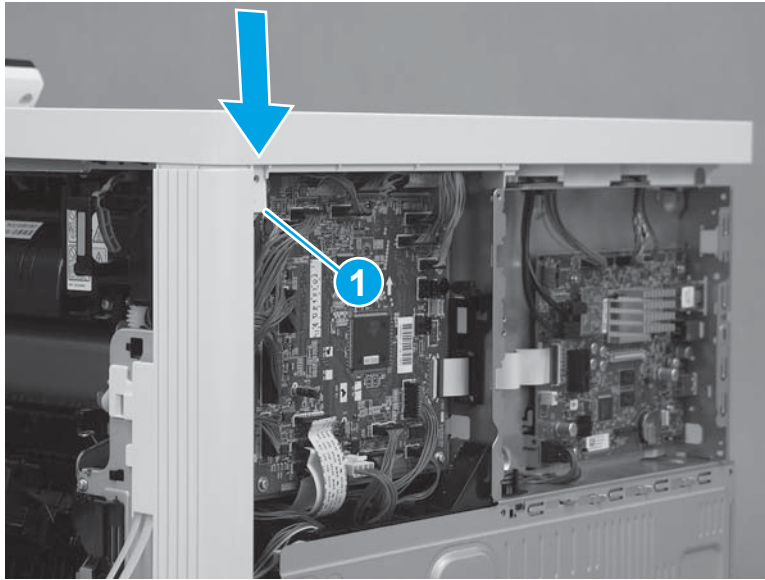

3. Push down on the front corner of the cover to engage one tab (callout 1), and then install one screw (callout 2).

 **NOTE:** This is a self-tapping plastic-thread screw. Make sure that this screw is used in this location when it is reinstalled.

Figure 1-3521 Engage one tab and install one screw



4. Install three screws (callout 1).

Figure 1-3522 Install three screws

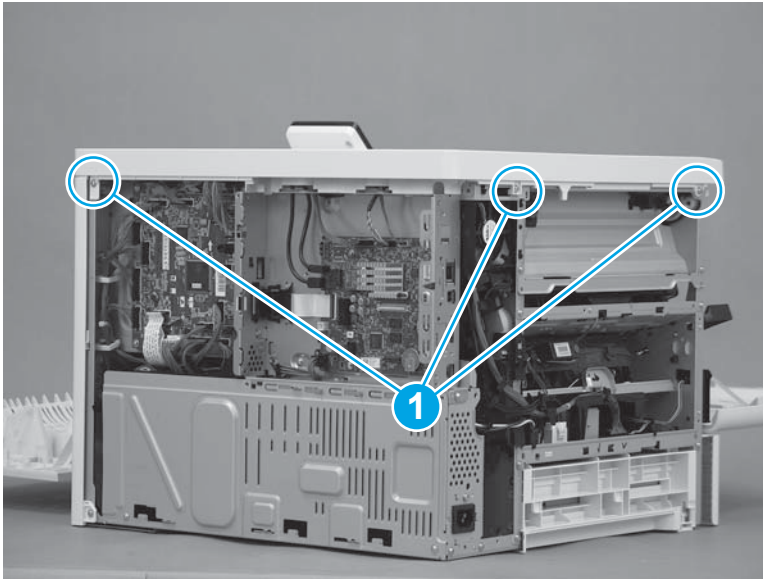

Step 47: Install the left cover

1. Position the cover on the printer.

 **NOTE:** Slightly offset the cover toward the rear of the printer.

Figure 1-3523 Install the cover

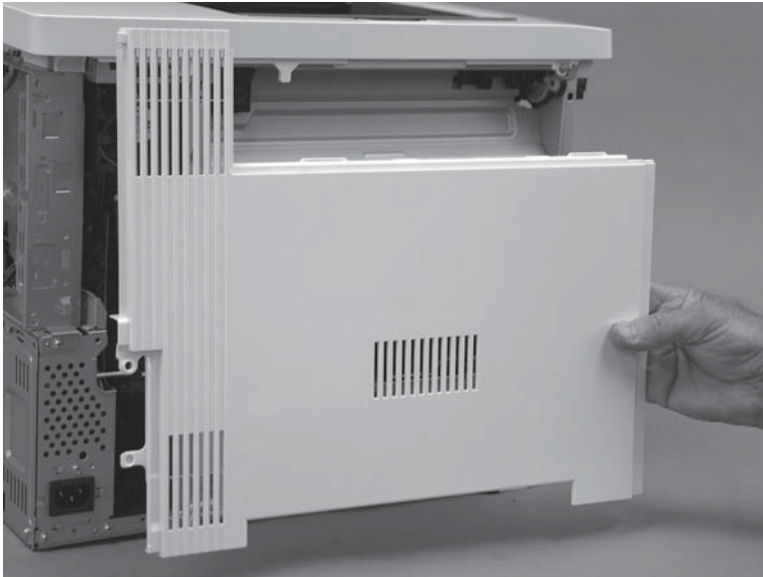

- Slide the cover (callout 1) toward the front of the printer to engage it. Make sure that the tab (callout 2) snaps into place.

 **NOTE:** Locate the alignment pin (callout 3) on the cover from the front door side of the printer, and then make sure that it is fully engaged in the slot in the chassis.

 **TIP:** While sliding the cover into place, push in on the center of the cover (callout 1) to make sure that the hooks on the back of the cover engage with the slots in the chassis.

Figure 1-3524 Engage the cover



- At the left side of the printer, install one screw (callout 1).

Figure 1-3525 Install one screw

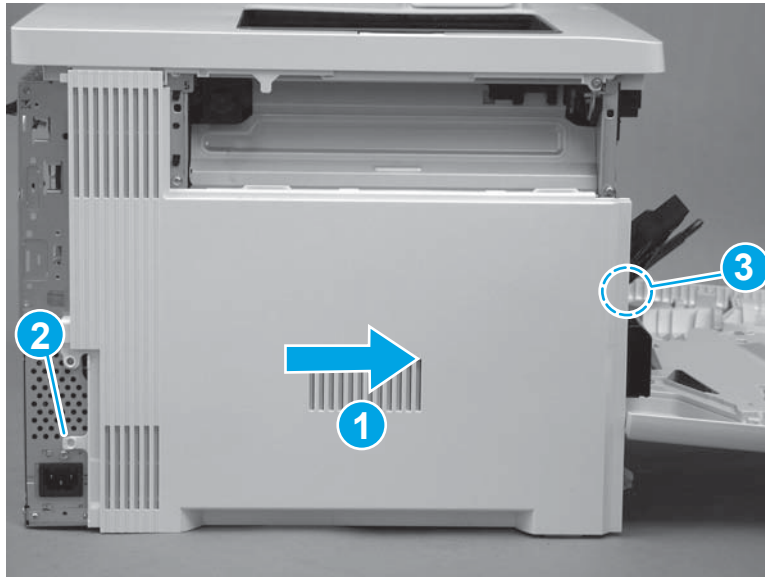

Step 48: Install the top bracket (M577)

 **NOTE:** This step is for the M577 models. For the M552 and M553 models, skip this step and go to [Step 60: Install the rear cover \(M552 and M553\) on page 2001](#).

1. Position the tabs (callout 1) on the bracket in the slots (callout 2) in the printer.

Figure 1-3526 Position the tabs in the slots

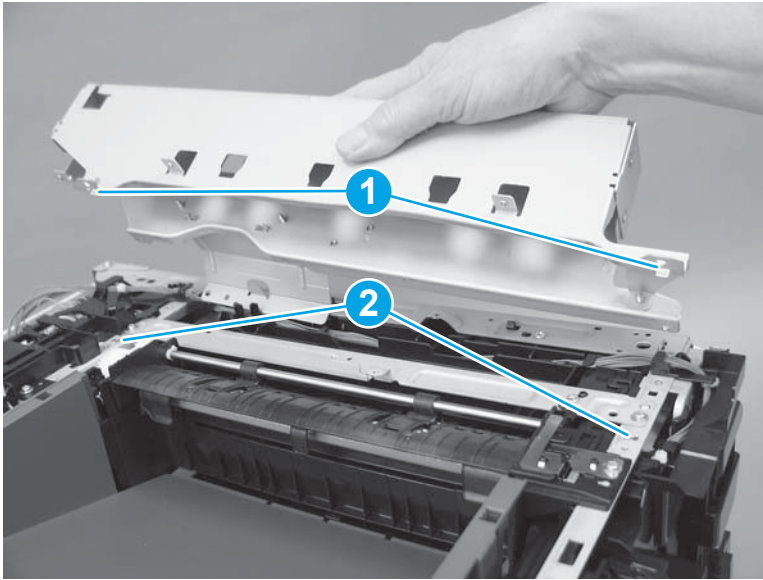

2. At the top of the printer, install two screws (callout 1).

Figure 1-3527 Install two screws

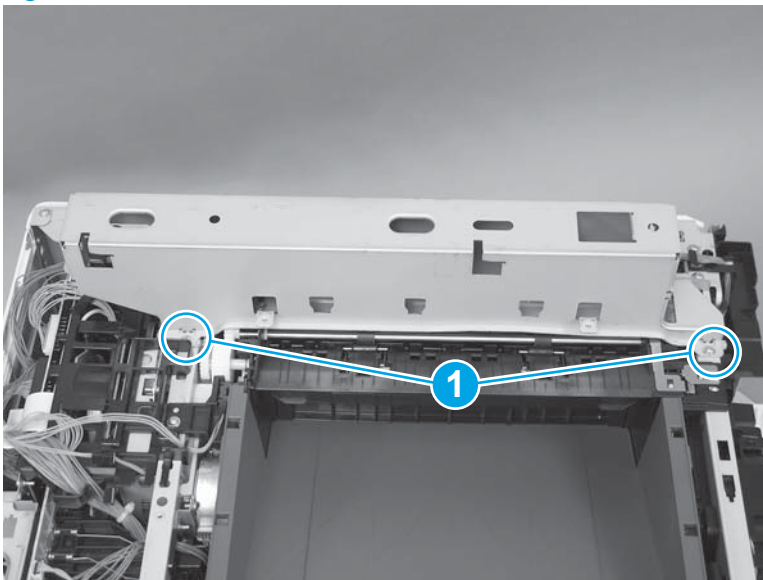

3. At the top of the printer, install three screws (callout 1).

Figure 1-3528 Install three screws

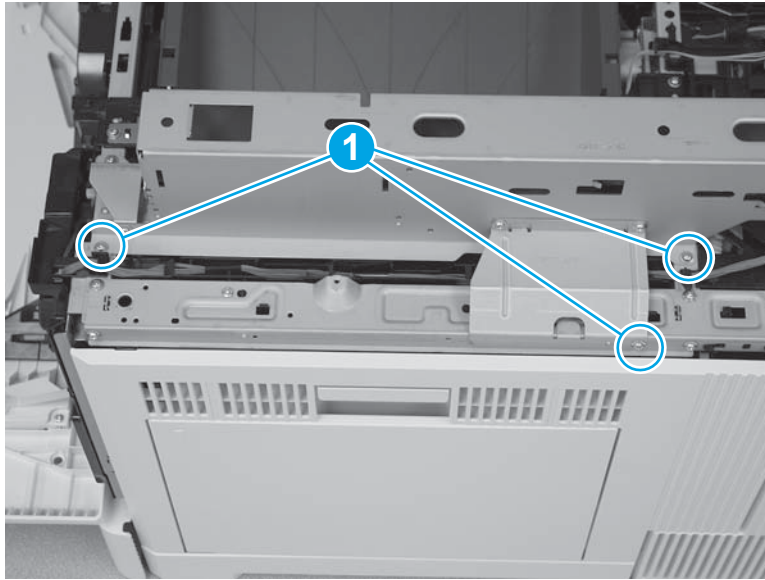

Step 49: Install the top cover (M577)

 **NOTE:** This step is for the M577 models. For the M552 and M553 models, skip this step and go to [Step 60: Install the rear cover \(M552 and M553\) on page 2001](#).

1. Position the locator pins (callout 1) on the cover in the slots (callout 2) in the printer.

Figure 1-3529 Position the locator pins

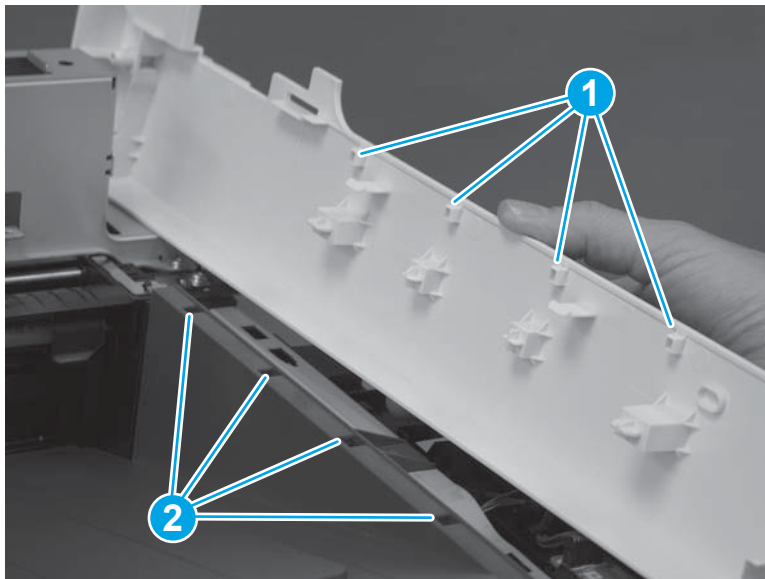

2. Press down on the cover to install it. Make sure that the tabs (callout 1) snap into place.

Figure 1-3530 Press down on the cover

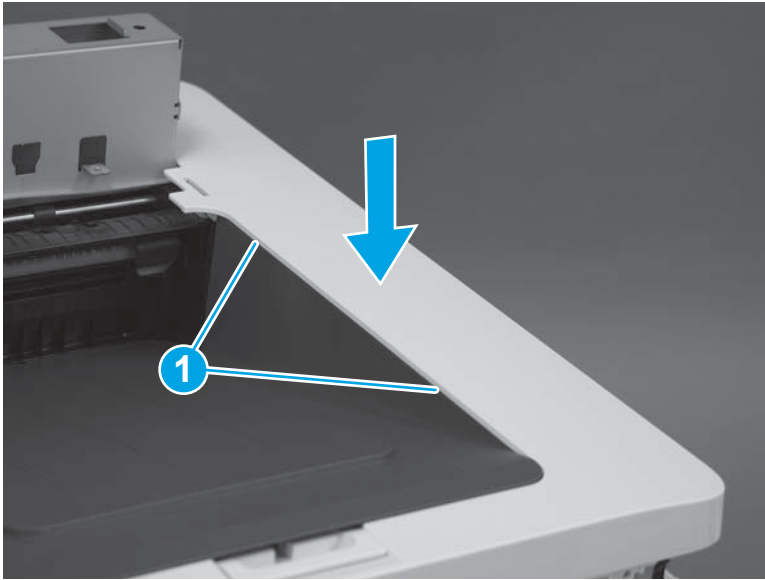

3. At the front of the printer, install one screw (callout 1).

 **Reinstallation tip:** This screw is longer and a different type of screw than the screw installed in the next step. Make sure that this screw is installed in the correct position.

Figure 1-3531 Install one screw



4. At the left side of the printer, install one screw (callout 1).

Figure 1-3532 Install one screw

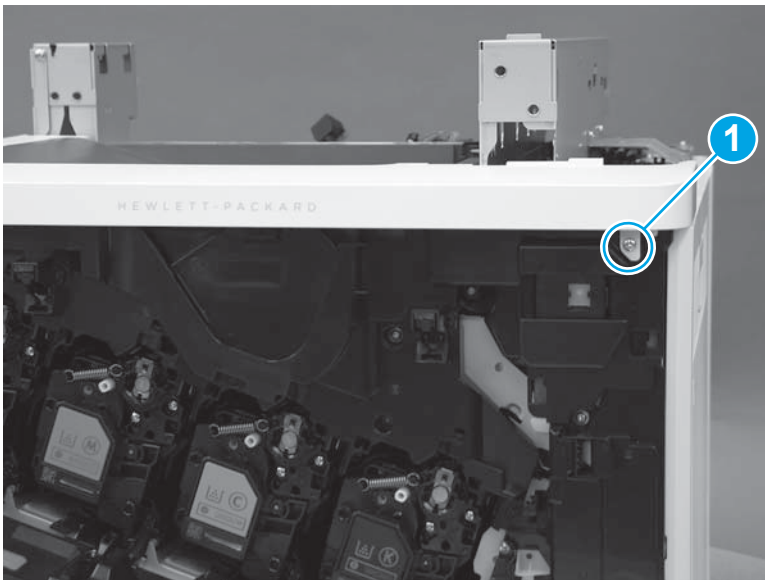
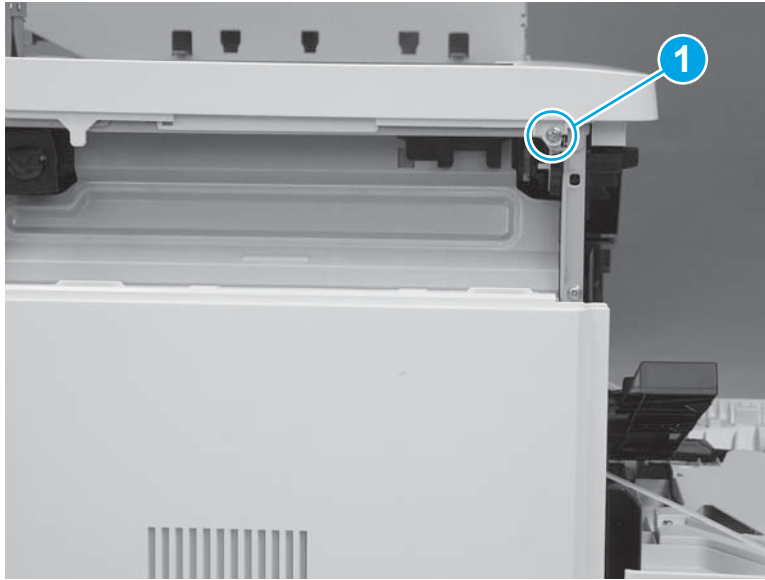

Step 50: Install the paper feed cover (M577)

 **NOTE:** This step is for the M577 models. For the M552 and M553 models, skip this step and go to [Step 60: Install the rear cover \(M552 and M553\) on page 2001](#).

1. Position the locator tabs (callout 1) on the cover in the slots (callout 2) in the printer. Press down until the cover snaps into place.

Figure 1-3533 Install the cover

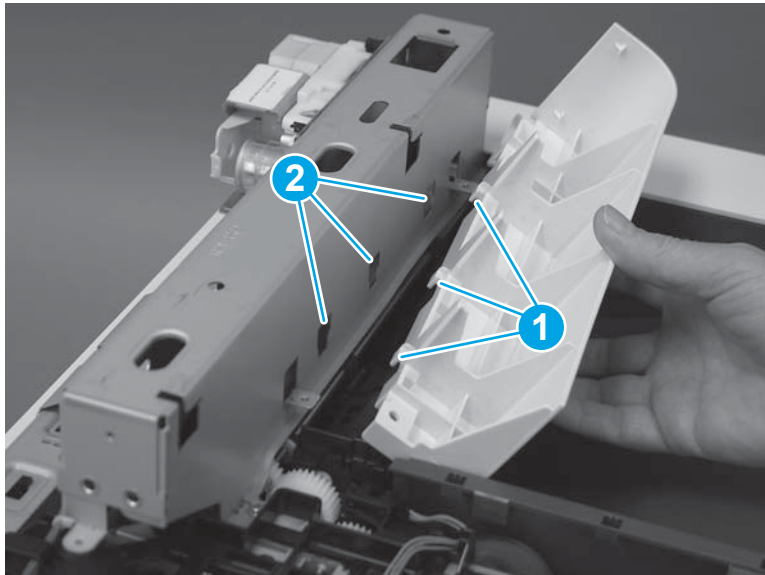

2. Install one screw (callout 1).

Figure 1-3534 Install one screw

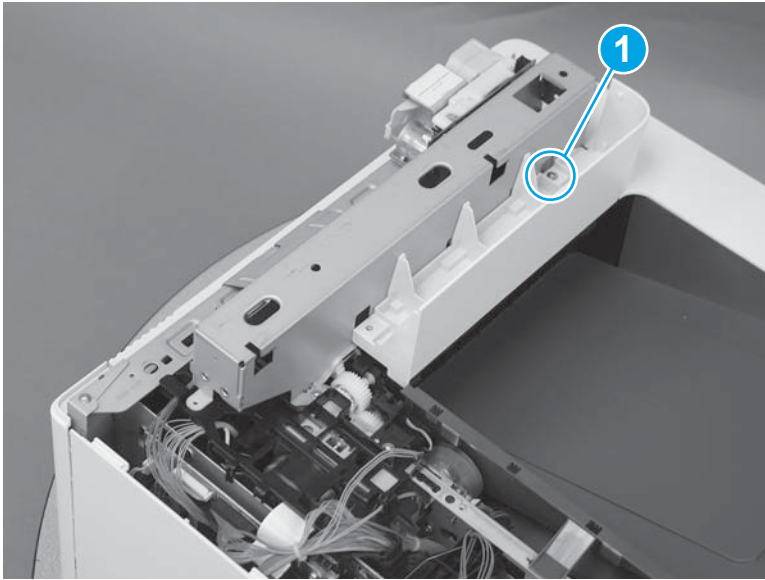

Step 51: Install the top rear cover (M577)



NOTE: This step is for the M577 models. For the M552 and M553 models, skip this step and go to [Step 60: Install the rear cover \(M552 and M553\) on page 2001](#).

1. Align the locator tabs (callout 1) on the cover with the slots (callout 2) in the printer.

Figure 1-3535 Align the locator tabs

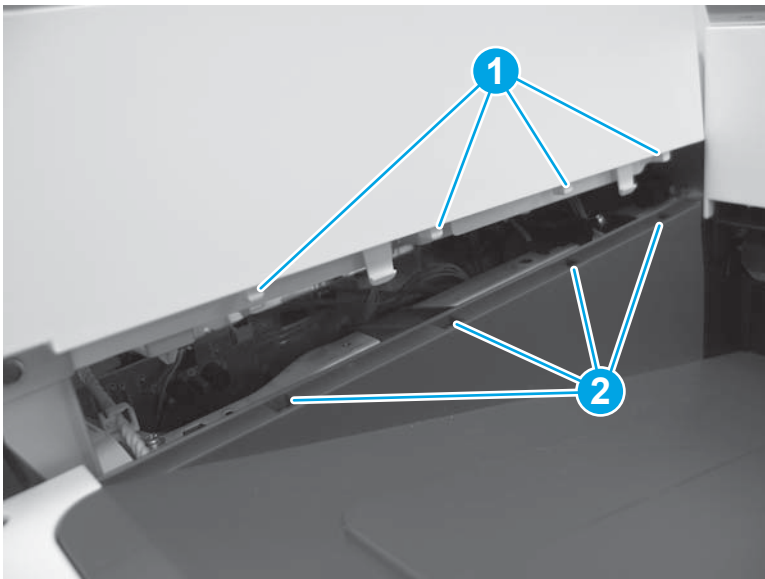

2. Press down to install the cover. Make sure that the tabs snap into place.

Figure 1-3536 Install the cover

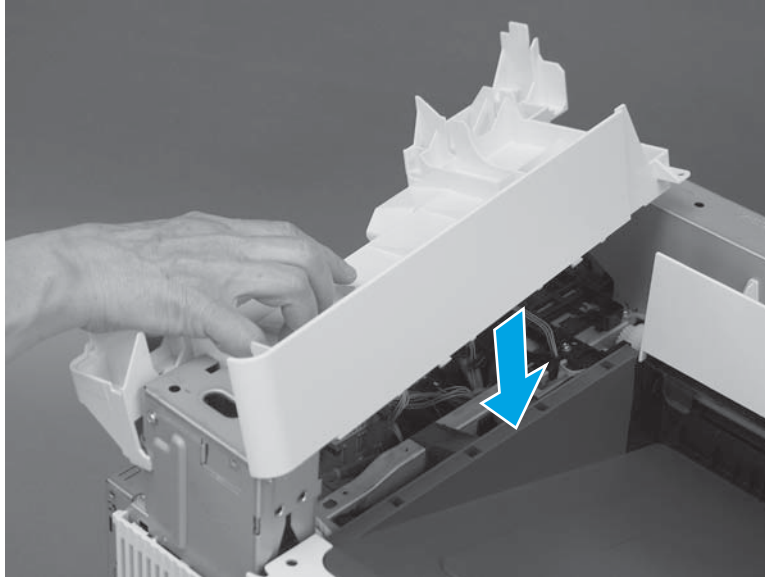

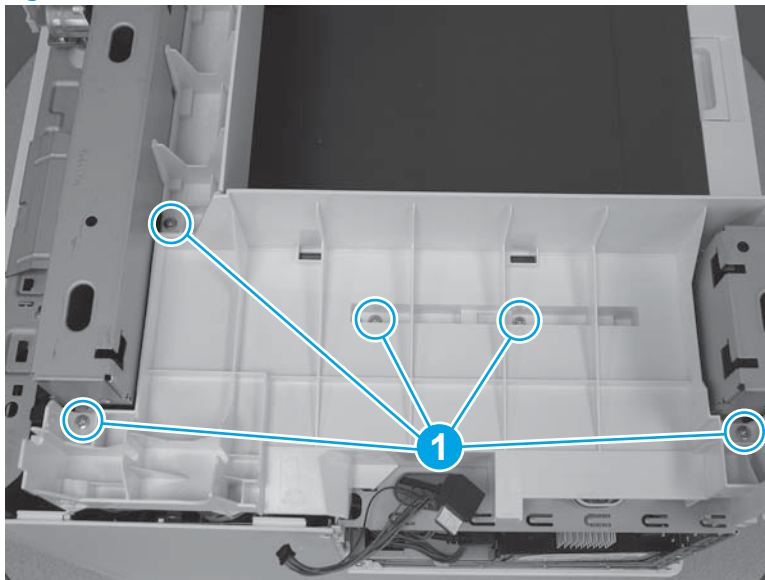

3. At the top of the printer, install five screws (callout 1).

Figure 1-3537 Install five screws



Step 52: Install the right upper cover (M577)

 **NOTE:** This step is for the M577 models. For the M552 and M553 models, skip this step and go to [Step 60: Install the rear cover \(M552 and M553\) on page 2001](#).

 **NOTE:** The figures below show the image scanner installed. The procedures for removing and installing the right upper cover are the same whether the image scanner is installed or removed."

1. **M577c/f/z only:** Install the cables (callout 1) through the slot (callout 2) in the printer.

Figure 1-3538 Install the cables

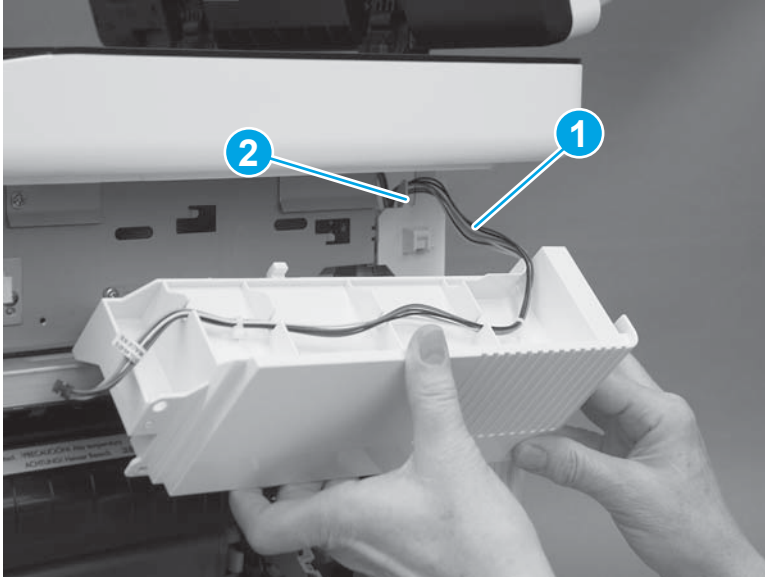

2. Position the hooks (callout 1) on the cover in the slots (callout 2) in the printer.

Figure 1-3539 Position the hooks

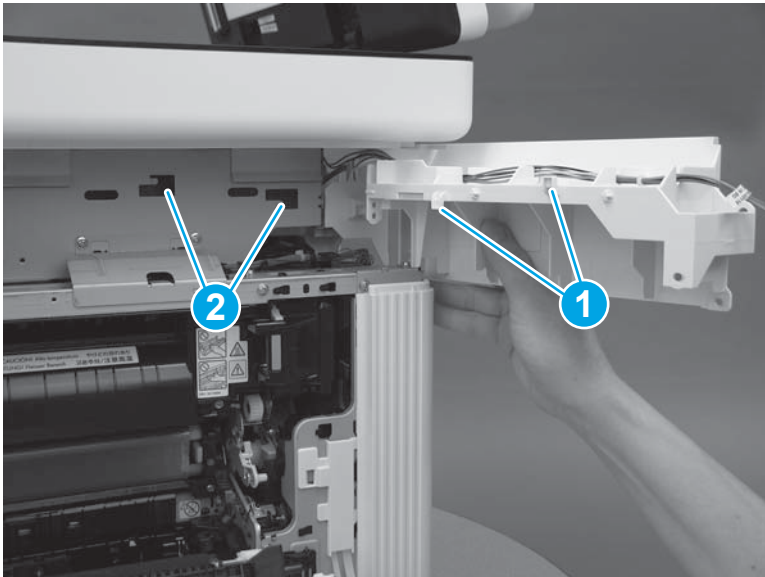

3. Slide the cover toward the front of the printer to install it.

Figure 1-3540 Install the cover

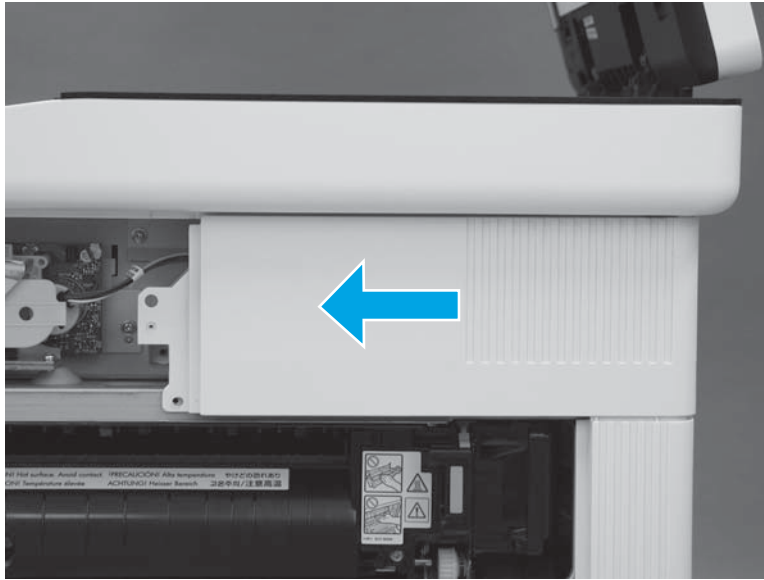

4. At the back of the printer, install one screw (callout 1).

M577c/f/z only: Connect one connector (callout 2), if the integrated scanner assembly is installed.

 **TIP:** This screw is smaller than the screws installed in the next step. Make sure that this screw is installed in the correct position.

Figure 1-3541 Install one screw and connector



5. At the right side of the printer, install two screws (callout 1).

M577c/f/z only: Connect one connector (callout 2), if the stapler is installed.

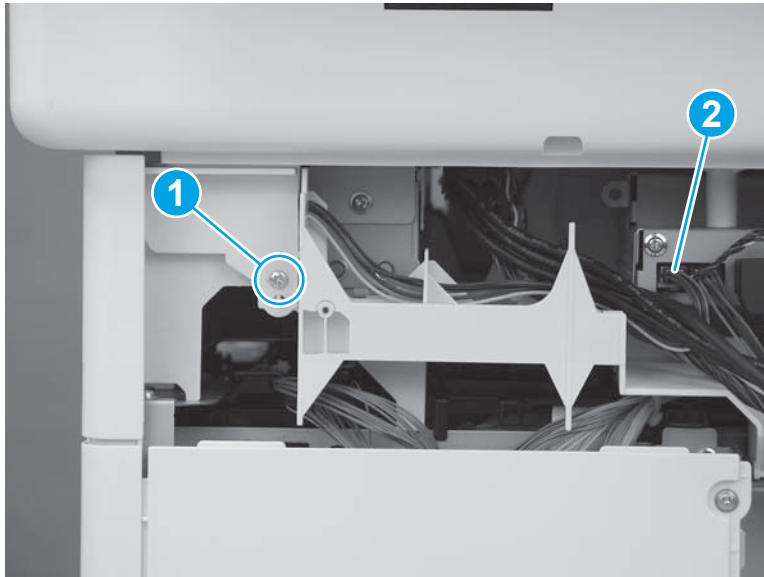
Figure 1-3542 Install one screw and connector

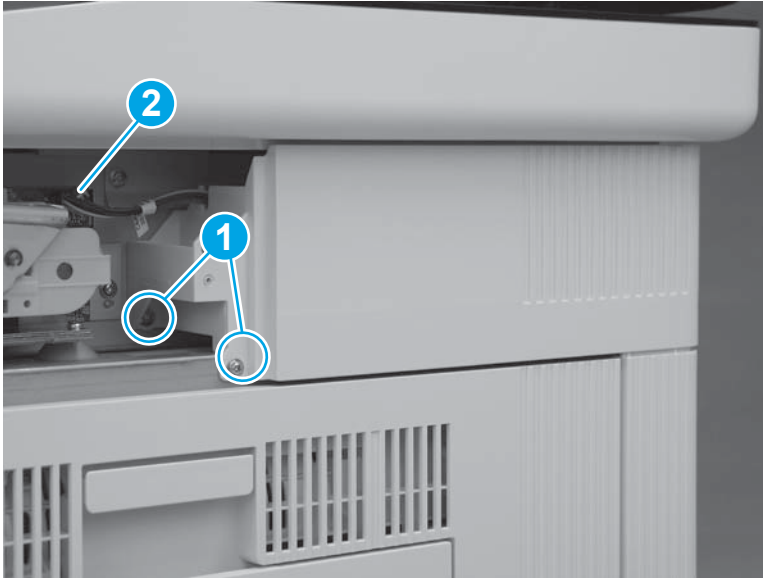

Step 53: Install the stapler unit (M577c/f/z)

 **NOTE:** This step is for the M577c/f/z models. For the M577dn model, skip this step and go to [Step 54: Install the integrated scanner assembly \(ISA\) \(M577\) on page 1989](#).

For the M552 and M553 models, skip this step and go to [Step 60: Install the rear cover \(M552 and M553\) on page 2001](#).

1. Position the hooks (callout 1) on the stapler unit in the slots (callout 2) in the printer.

Figure 1-3543 Position the hooks in the slots

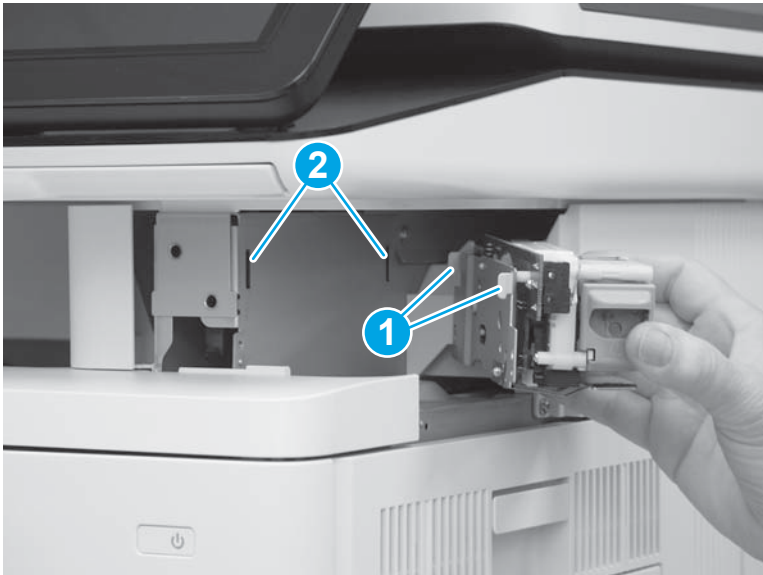

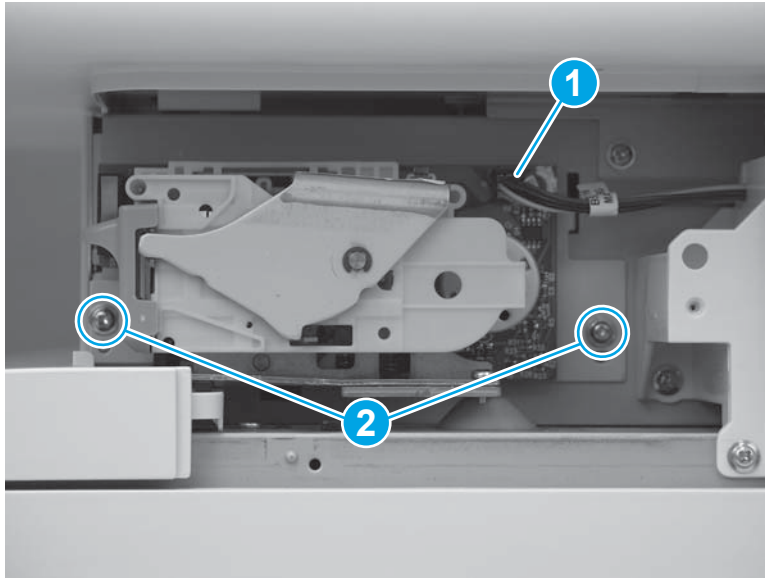

2. Connect one connector (callout 1), and then install two screws (callout 2).

Figure 1-3544 Connect connector and install screws



Step 54: Install the integrated scanner assembly (ISA) (M577)

 **NOTE:** This step is for the M577 models. For the M552 and M553 models, skip this step and go to [Step 60: Install the rear cover \(M552 and M553\) on page 2001](#).

 **NOTE:** The ISA includes the document feeder, image scanner, scanner control board (SCB), control panel, keyboard (M577c/z) and NFC PCA (M577z).

1. Before proceeding, locate the mounting pins (callout 1) on the bottom of the ISA and the slots (callout 2) on the printer base.

Figure 1-3545 Locate the ISA mounting pins and slots

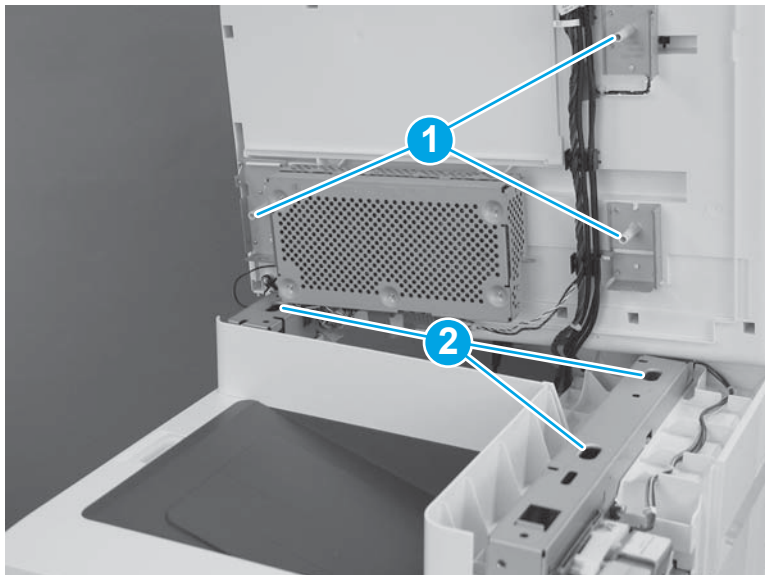

2. Position the ISA on the printer base with the pins in the slots.

 **NOTE:** To locate the pins and slots, see [Figure 1-395 Locate the ISA mounting pins and slots on page 250](#).

When installing the ISA, carefully pass the cables through the opening in the top of the formatter case.

Figure 1-3546 Install the ISA



3. Slightly slide the ISA towards the front of the printer to engage it.

Figure 1-3547 Slide the ISA towards the front of the printer

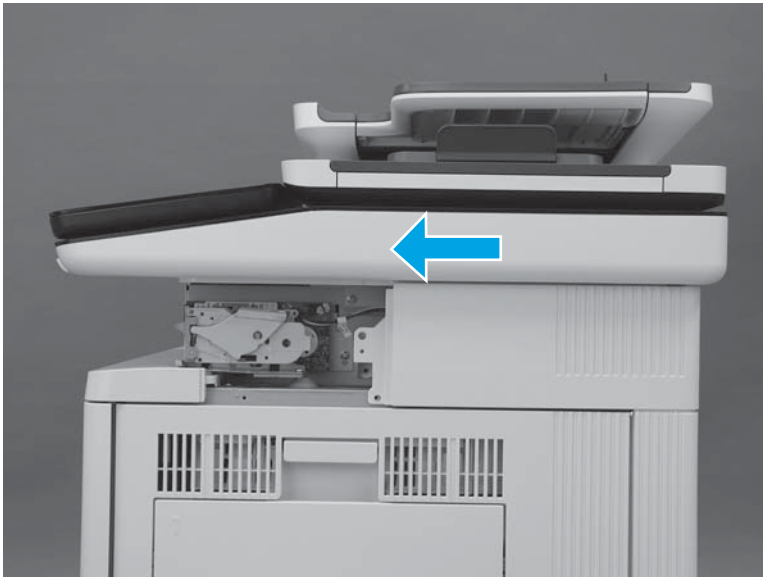

4. At the left side of the printer, install one screw (callout 1).

Figure 1-3548 Install one screw

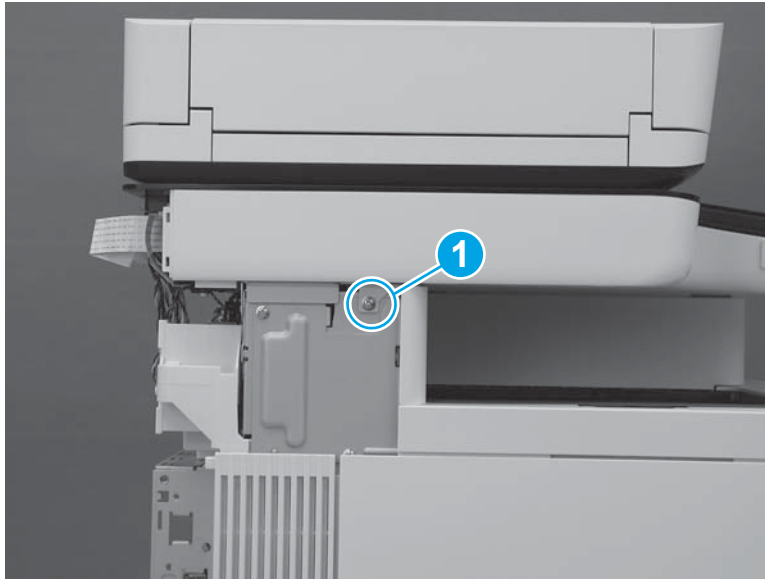

5. At the back of the printer, install two screws (callout 1).

Figure 1-3549 Install two screws

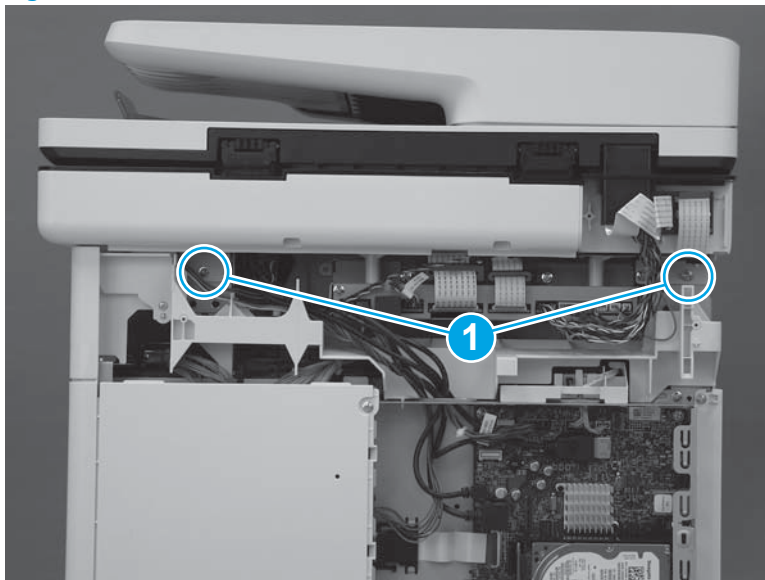

6. At the right side of the printer, install one screw (callout 1).

Figure 1-3550 Install one screw

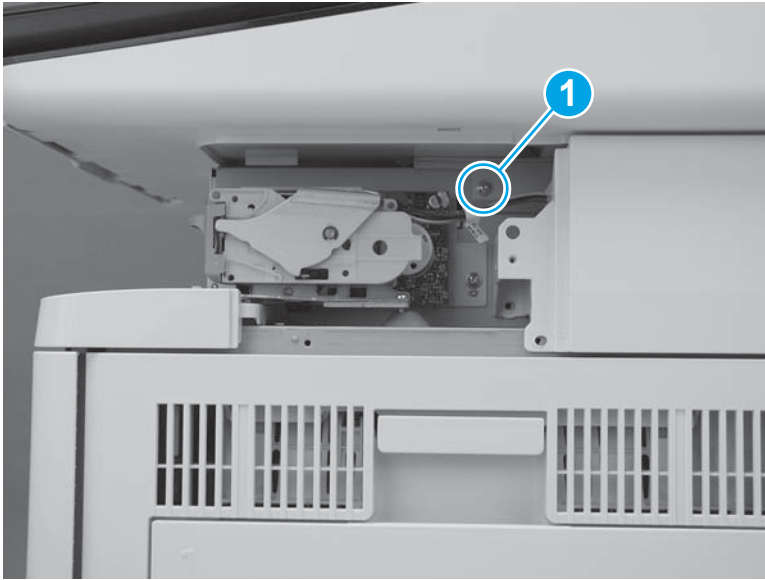

7. Connect two connectors on the scanner control board (callout 1).

M577c/f/z only: Connect one connector for the stapler on the scanner control board (callout 2).

Figure 1-3551 Connect connectors

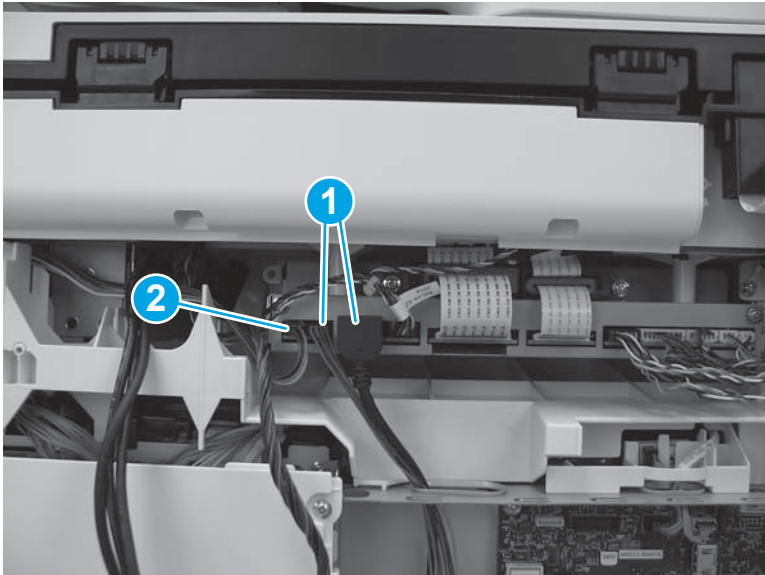

Step 55: Install the stapler cover assembly (M577c/f/z)

 **NOTE:** This step is for the M577c/f/z models only. For the M577dn model, skip this step and go to [Step 56: Install the right front upper cover \(M577dn\) on page 1994](#).

For the M552 and M553 models, skip this step and go to [Step 60: Install the rear cover \(M552 and M553\) on page 2001](#).

1. Install the tabs (callout 1) on the cover in the slots (callout 2) in the printer.

Figure 1-3552 Install two tabs



2. Press the cover toward the left side of the printer until it snaps into place.

Figure 1-3553 Install the cover assembly



3. Install one screw (callout 1).



 **IMPORTANT:** This is a self-tapping screw for plastic. Rotate it counterclockwise to align it with the existing thread pattern, and then carefully turn it clockwise to tighten. Do not overtighten. This will prevent stripping the threads inside the screw hole.

Figure 1-3554 Install one screw

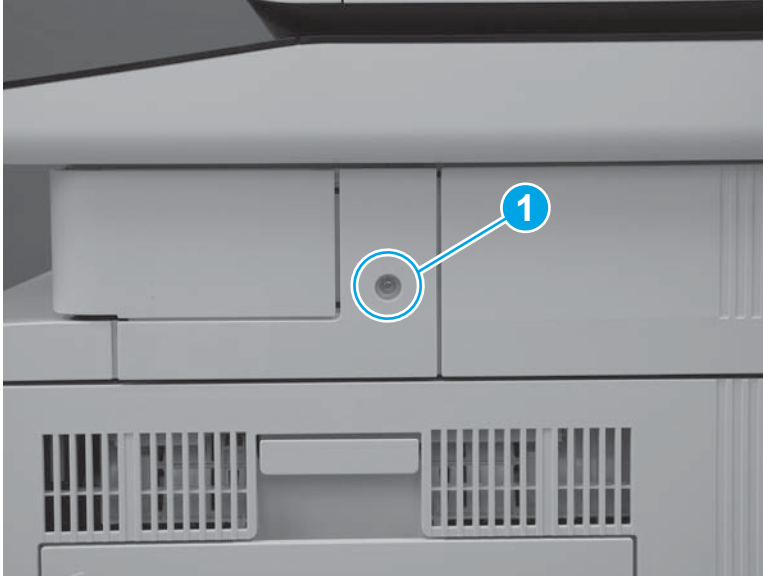

Step 56: Install the right front upper cover (M577dn)

 **NOTE:** This step is for the M577dn model only. For the M577c/f/z models, skip this step and go to [Step 57: Install the left upper cover \(M577\) on page 1996](#).

For the M552 and M553 models, skip this step and go to [Step 60: Install the rear cover \(M552 and M553\) on page 2001](#).

1. Slide the cover toward the left side of the printer to install it. Make sure that the slots (callout 1) in the cover fit over the tabs (callout 2) on the inside of the paper feeder cover.

Figure 1-3555 Install the cover



2. Press the right front upper cover (callout 1) and the paper feeder cover (callout 2) together until the tabs on the inside of the covers snap into place.

Figure 1-3556 Press the cover



3. Install one screw (callout 1).

Figure 1-3557 Install one screw

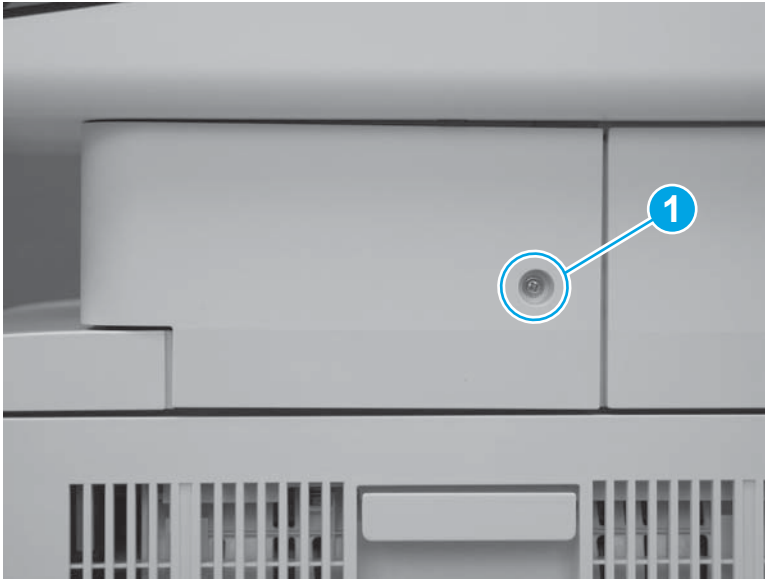

Step 57: Install the left upper cover (M577)



NOTE: This step is for the M577 models. For the M552 and M553 models, skip this step and go to [Step 60: Install the rear cover \(M552 and M553\) on page 2001](#).

1. Position the tab (callout 1) on the lower edge of the cover behind the left cover (callout 2).

Figure 1-3558 Position the tab

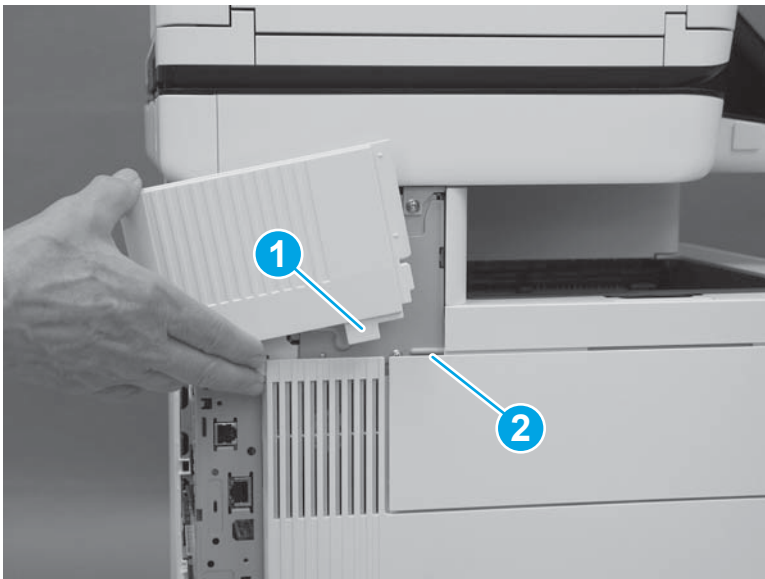

2. Slide the cover toward the front of the printer to install it. Make sure that the edge (callout 1) of the cover fits behind the edge (callout 2) of the top rear cover.

Figure 1-3559 Slide the cover

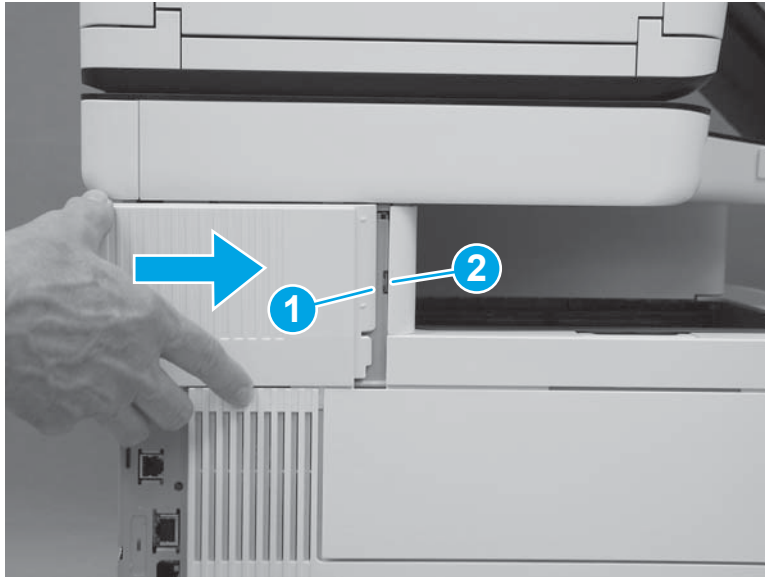

3. Make sure that the tab (callout 1) is fully installed.

Figure 1-3560 Check the tab

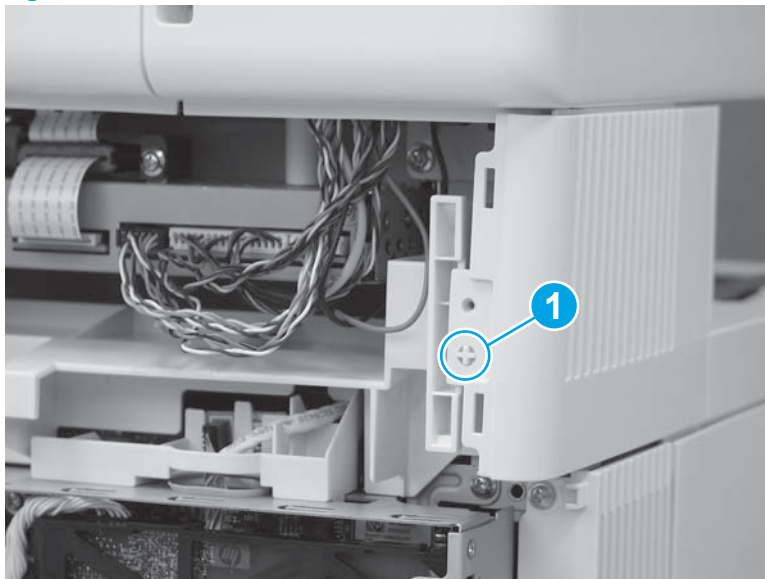

Step 58: Install the rear cover (M577)

 **NOTE:** This step is for the M577 models. For the M552 and M553 models, skip this step and go to [Step 60: Install the rear cover \(M552 and M553\) on page 2001](#).

1. Position the hooks (callout 1) on the cover in the slots (callout 2) in the printer.

Figure 1-3561 Position the hooks

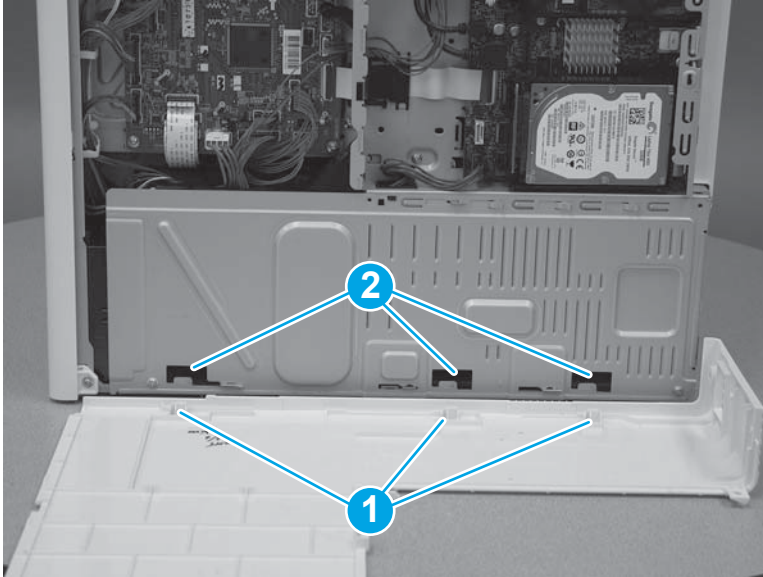

2. Position the back edge (callout 1) of the rear cover behind the edge (callout 2) of the right rear cover. Slide the cover to the left to install it.

Figure 1-3562 Install the cover

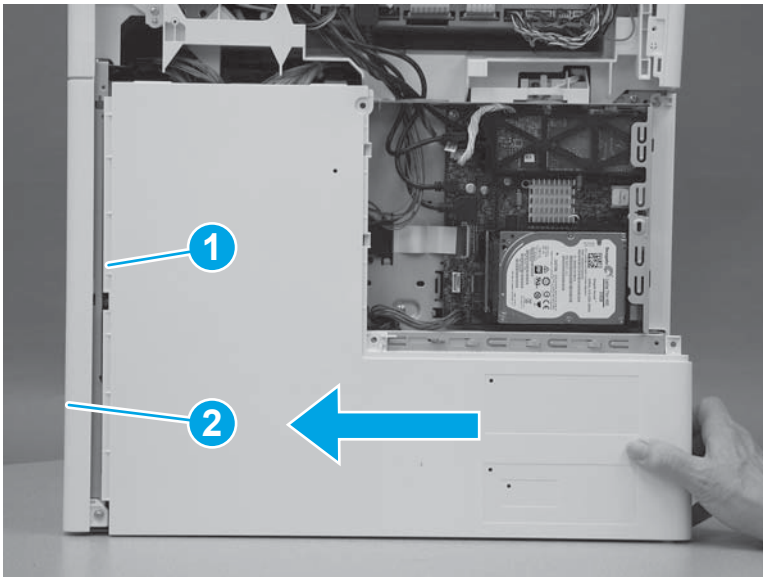

3. Install four screws (callout 1).

Figure 1-3563 Install four screws cover

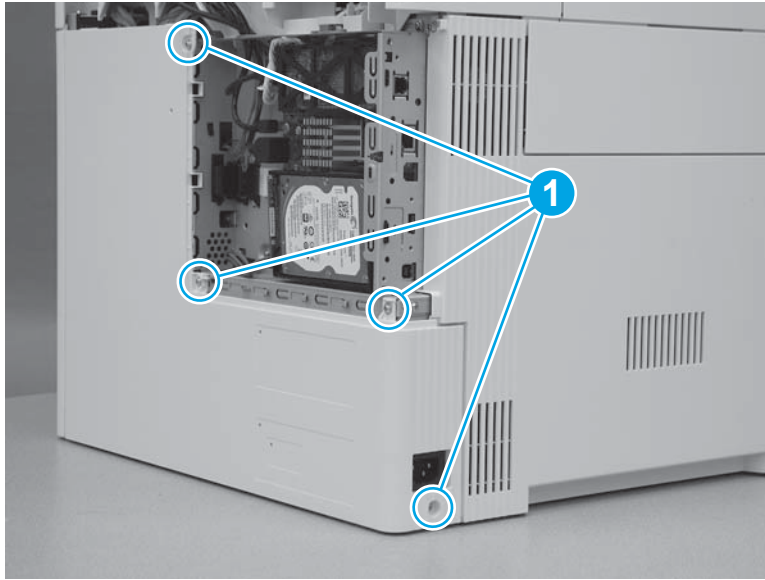

Step 59: Install the rear upper cover (M577)

 **NOTE:** This step is for the M577 models. For the M552 and M553 models, skip this step and go to [Step 60: Install the rear cover \(M552 and M553\) on page 2001](#).

1. Align the ridge (callout 1) on the lower edge of the rear upper cover in front of the tabs (callout 2) on the top edge of the rear cover.

Figure 1-3564 Align the cover

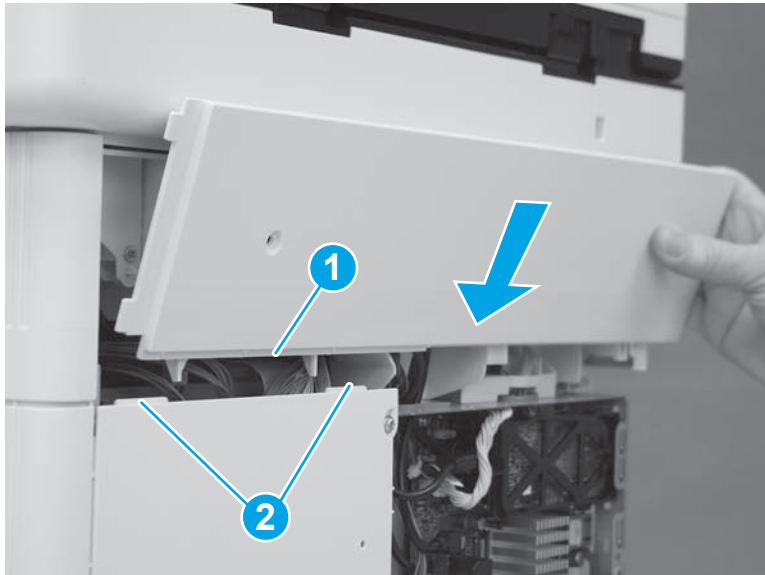

2. Rotate the top of the cover toward the printer.

Figure 1-3565 Rotate the top of the cover

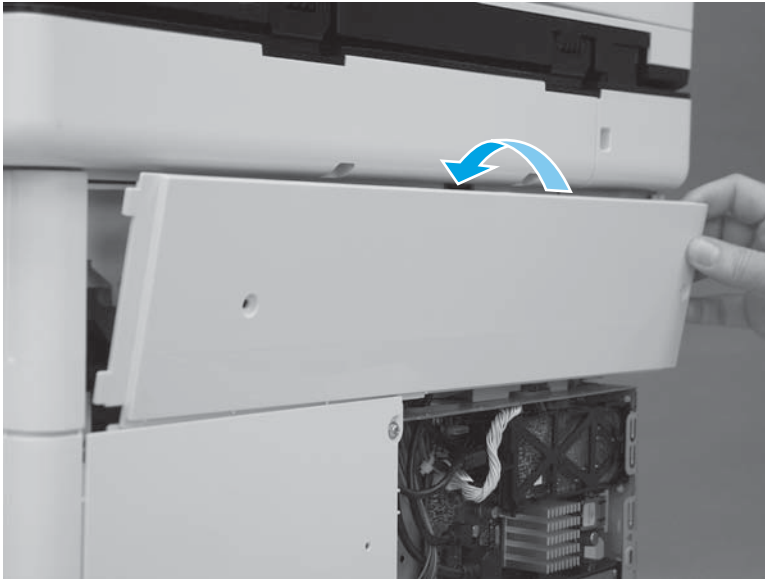

3. Slide the cover to the left (callout 1). Make sure that the tabs (callout 2) on the upper rear cover slide behind the edge (callout 3) of the right upper cover. Make sure that the cover is fully seated.

Figure 1-3566 Slide the cover

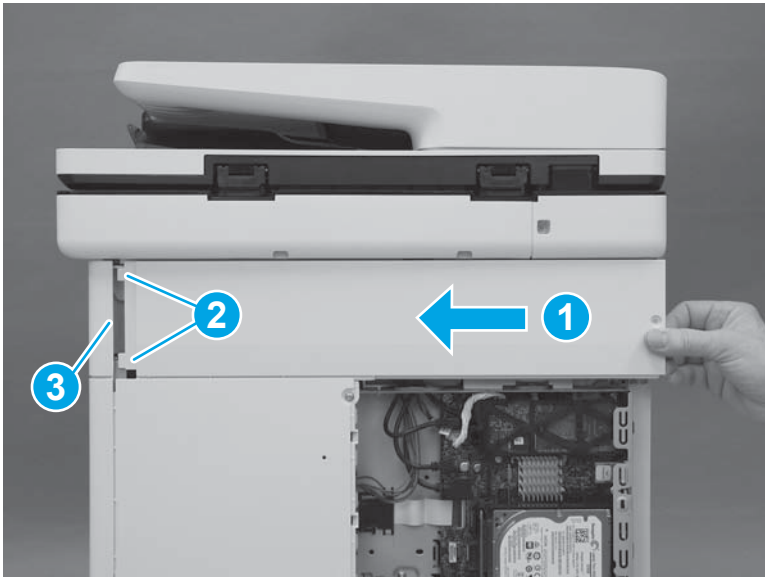

4. Install two screws (callout 1).

 **IMPORTANT:** These two screws are self-tapping screws for plastic. Rotate them counterclockwise to align them with the existing thread pattern, and then carefully turn them clockwise to tighten. Do not overtighten. This will prevent stripping the threads inside the screw holes.

Figure 1-3567 Install two screws



Step 60: Install the rear cover (M552 and M553)

 **NOTE:** This step is for the M552 and M553 models. For the M577 models, skip this step and go to [Step 61: Install the formatter \(M577\) on page 2002](#).

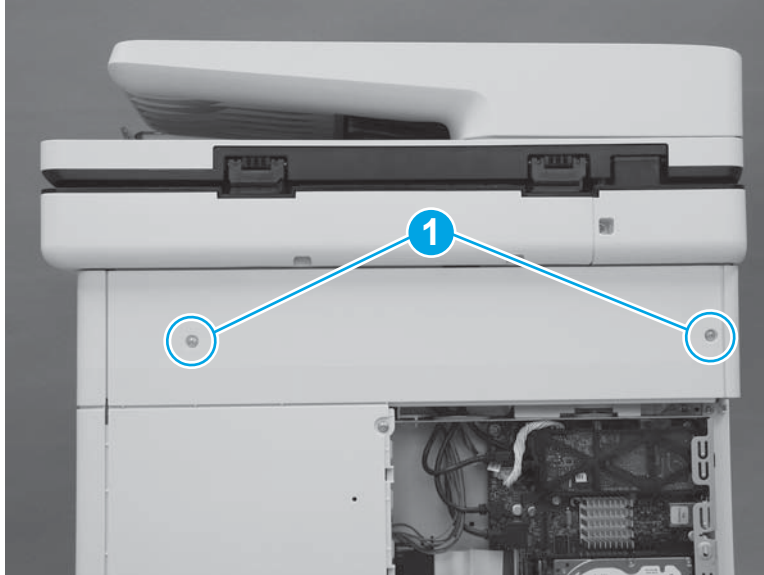
1. Position the top of the cover under the upper cover (callout 1), rotate the bottom of the cover onto the chassis (callout 2), and then slide the cover to the left (callout 3) to install it.

Figure 1-3568 Install the cover

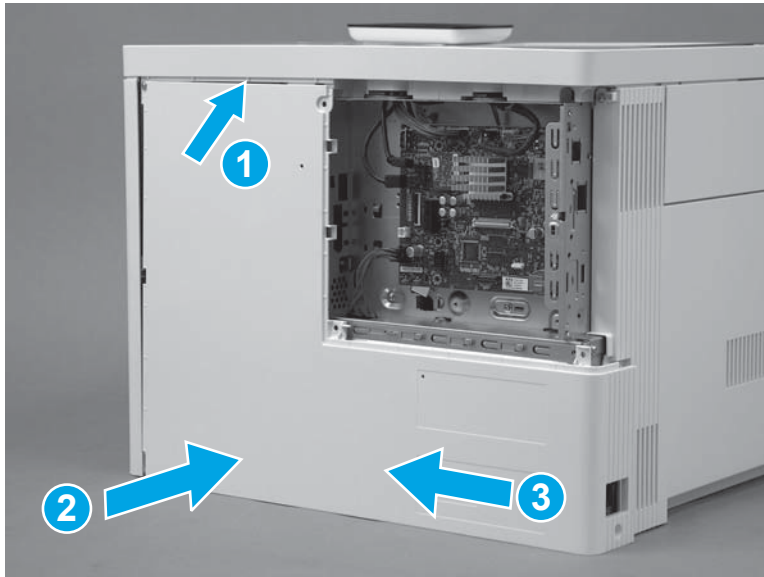

2. Install four screws (callout 1).

Figure 1-3569 Install four screws cover

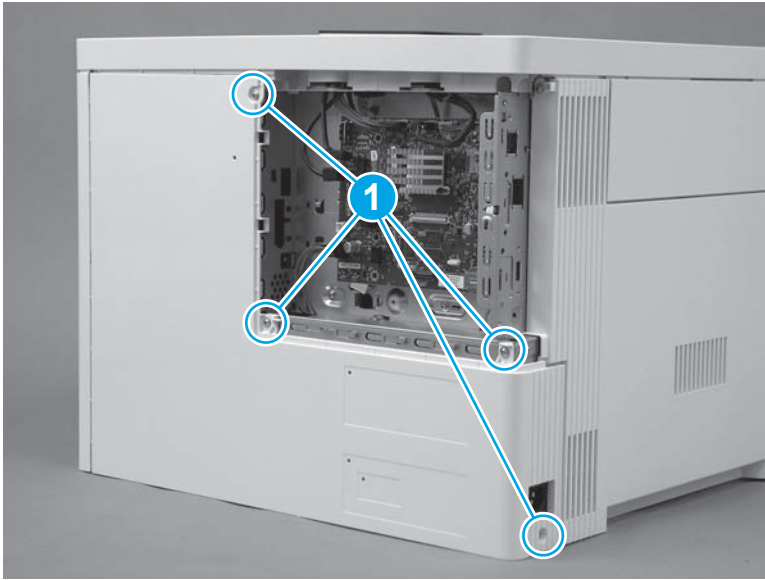

Step 61: Install the formatter (M577)



NOTE: This step is for the M577 models. For the M552 and M553 models, skip this step and to go [Step 64: Install the formatter \(M552 and M553\) on page 2007](#).



CAUTION:  ESD-sensitive part.

1. Position the formatter in the printer. Make sure that the network port (callout 1) fits through the opening (callout 2) in the formatter case.

Figure 1-3570 Install the formatter

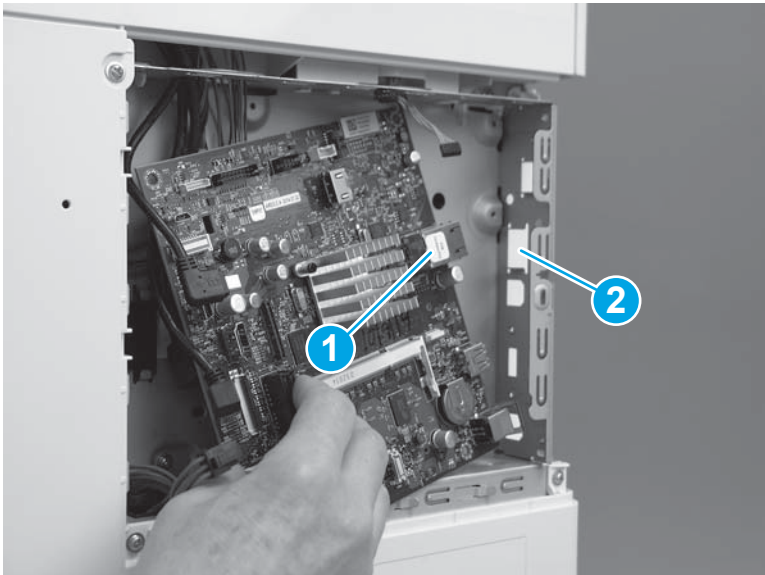

2. Install four screws (callout 1).

Figure 1-3571 Install four screws

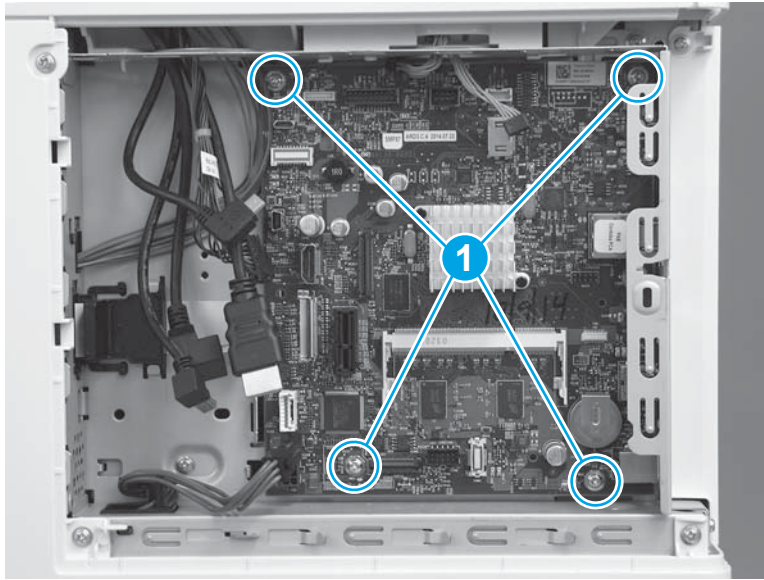

3. Connect all of the connectors on the formatter.

The following connectors are empty:

- All models: J1 (this connector is empty unless the optional DIMM is installed)
- All models: J3
- M577dn: J15 (this is the fax connector for the M577f/z/c models)
- All models: J21 (this connector is empty unless the optional internal USB ports component is installed)
- All models: J23
- All models: J24
- All models: J51
- All models: J57
- All models: J97
- All models: J98 (this connector is empty unless the optional trusted platform module (TPM) is installed)

 **IMPORTANT:** The flat-cable connector (callout 1) is a Zero Insertion Force (ZIF) connector that uses a hinged retainer to secure the flat cable. The hinged retainer must be opened to install the flat cable, and then closed after the cable is installed.

Figure 1-3572 Connect all connectors



Step 62: Install the fax PCA (M577c/f/z)

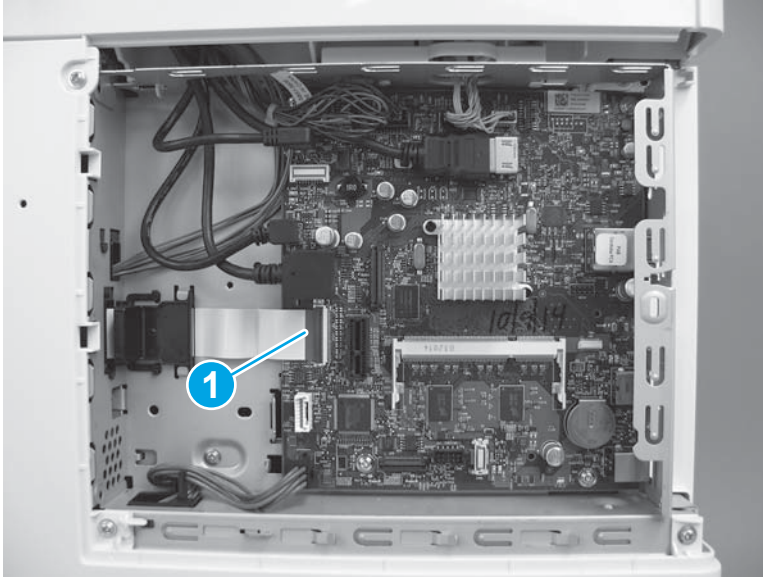

NOTE: This step is for the M577c/f/z models. For the M577n model, skip this step and go to [Step 63: Install the HDD \(M577\) on page 2005](#).

For the M552 and M553 models, skip this step and go to [Step 64: Install the formatter \(M552 and M553\) on page 2007](#).



CAUTION:  ESD-sensitive part.

1. Position the tab and telephone port (callout 1) on the fax PCA in the slots (callout 2) in the formatter case.

Figure 1-3573 Position the fax PCA

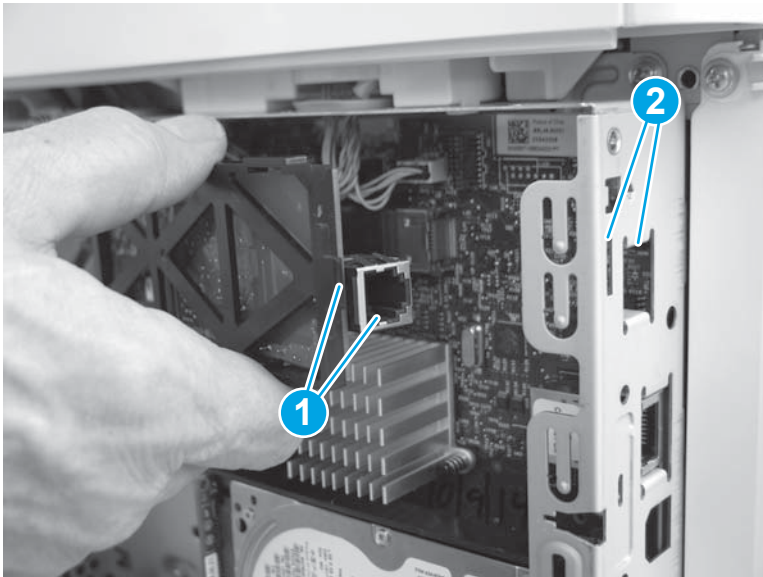

2. Slide the fax PCA to the right (callout 1) until the tab and telephone port described in the previous step and seated in the formatter case. Position the retainer (callout 2) in the slot (callout 3) in the formatter. Rotate the end of the fax PCA toward the formatter (callout 4) until the retainer snaps into place.

Figure 1-3574 Install the fax PCA

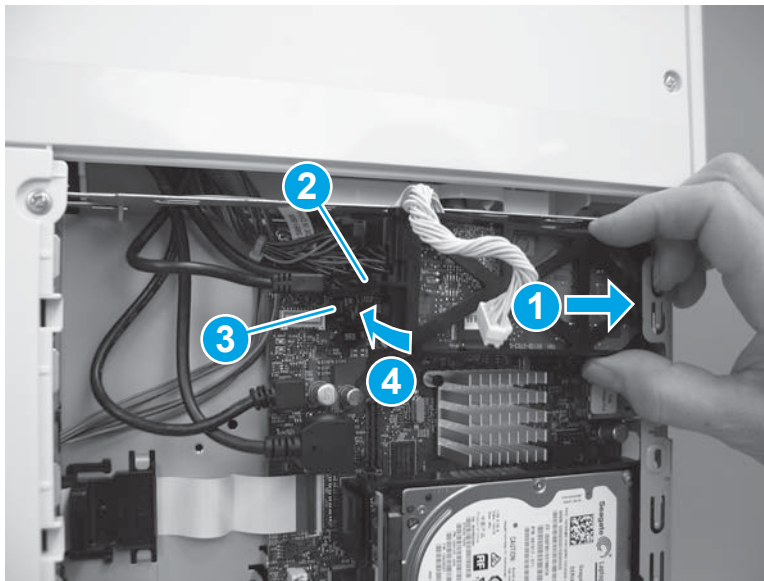

3. Position the cable (callout 1) in the guide (callout 2), and then connect one connector (callout 3).

Figure 1-3575 Connect the connector

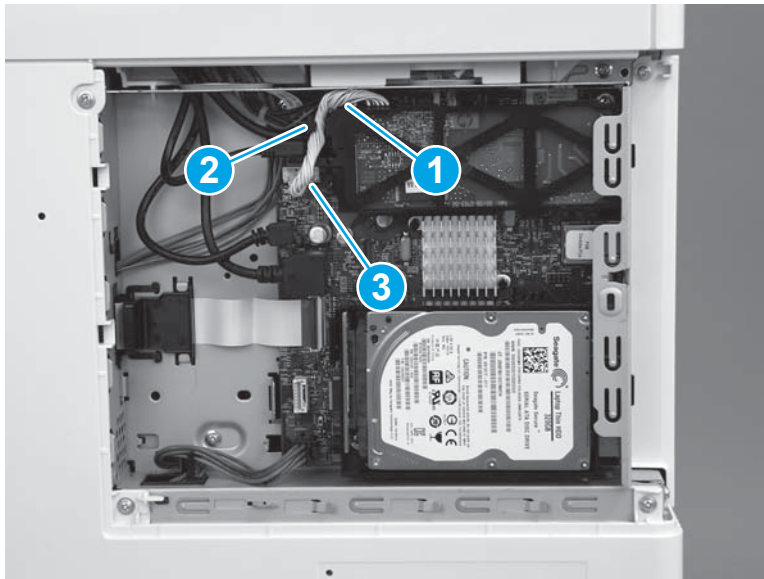

Step 63: Install the HDD (M577)

 **NOTE:** This step is for the M577 models. For the M552 and M553 models, skip this step and go to [Step 64: Install the formatter \(M552 and M553\) on page 2007](#).

 **CAUTION:**  ESD-sensitive part.

1. Align the end of the bracket (callout 1) with the slot in the chassis (callout 2), and then slide the HDD into the printer (callout 3) to engage the bracket with the chassis.

Figure 1-3576 Install the holder

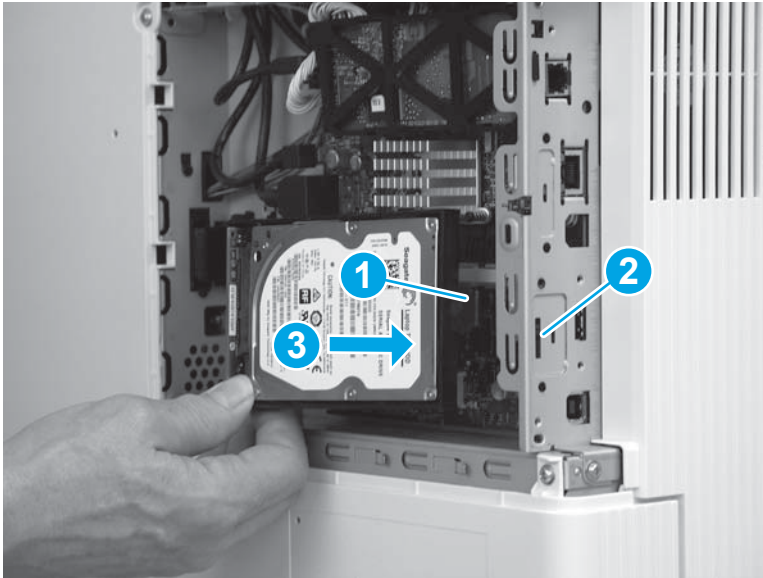

2. Hold the HDD connector latch (callout 1) in the released position, and then rotate the HDD down and into the connector on the formatter to install it.

 **NOTE:** Make sure that the tab (callout 2) snaps into place, and that the HDD is securely installed.

Figure 1-3577 Release the HDD

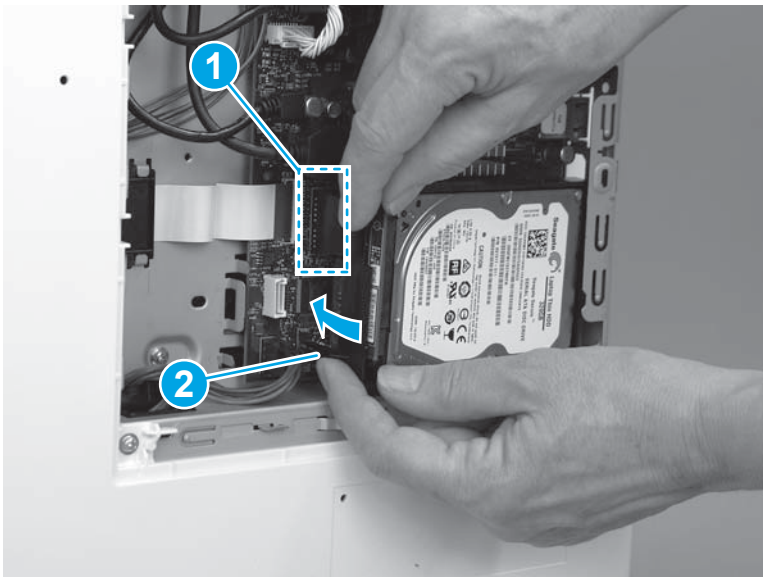

Step 64: Install the formatter (M552 and M553)

 **NOTE:** This step is for the M552 and M553 models. For the M577 models, skip this step and go to [Step 65: Install the formatter cover on page 2008](#).

If the optional hard-disk drive (HDD) was removed, do not forget to reinstall it after the formatter is reinstalled.

Engage the HDD holder with the chassis, rotate the HDD connector down and into the connector on the formatter. Make sure that the tabs snap into place.

 **CAUTION:**  ESD-sensitive part.

1. Position the formatter in the printer, and then install four screws (callout 1).

Figure 1-3578 Install the formatter

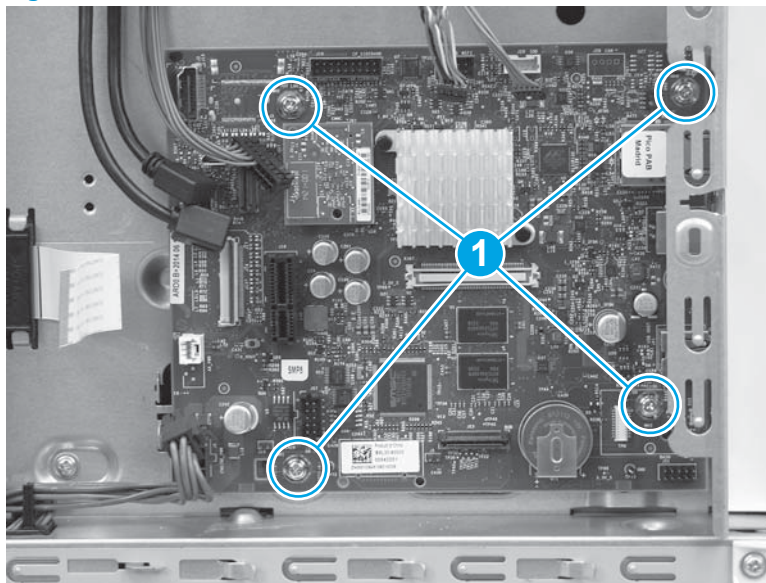

2. Connect all of the connectors on the formatter.

The following connectors are empty:

- All models: J1 (this connector is empty unless the optional DIMM is installed)
- M553n/dn and M552dn: J2 (callout 1; this is the touchscreen connector for the M553x model)
- All models: J9 (this connector is empty unless the optional internal USB ports component is installed)
- All models: J18 (this connector is empty unless the optional hard-disk-drive (HDD) is installed)
- All models: J23
- All models: J24
- M553n/dn and M552dn: J25 (this is the wireless connector for the M553x model)

- All models: J57
- All models: J98 (this connector is empty unless the optional trusted platform module (TPM) is installed)



 **IMPORTANT:** The flat-cable connector (callout 2) is a Zero Insertion Force (ZIF) connector that uses a hinged retainer to secure the flat cable. The hinged retainer must be opened to install the flat cable.

Figure 1-3579 Connect all connectors

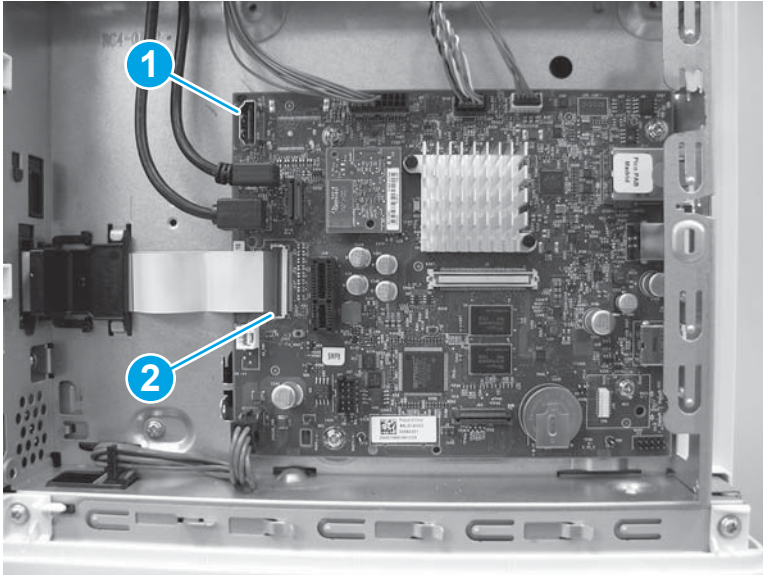

Step 65: Install the formatter cover

- ▲ Slide the cover onto the printer (callout 1) to install it.

 **NOTE:** Make sure that the tabs on the formatter cover align with the slots provided in the printer (callout 2). Tighten the two thumbscrews (callout 3).

 **TIP:** If needed, use the edge of a coin to turn the thumbscrews.

Figure 1-3580 Install the cover



Step 66: Install the TCU

1. Verify that the toner collection hatch cover is in the closed position on the TCU.

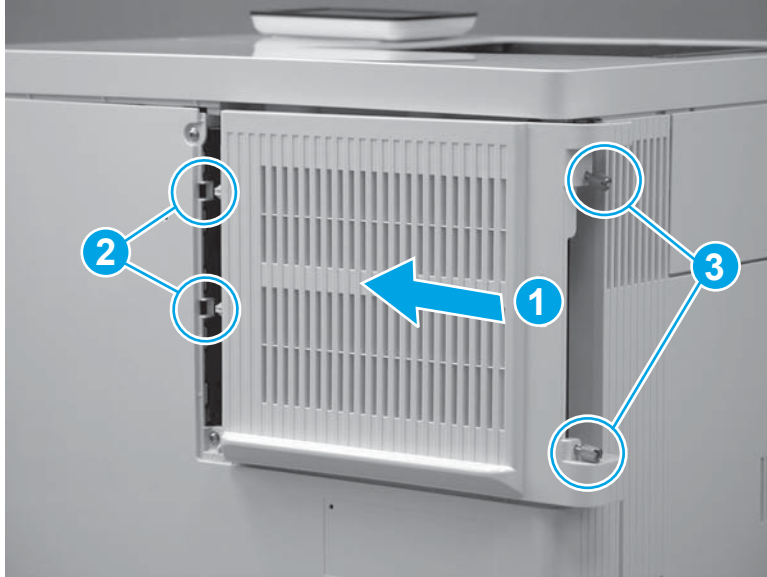
Figure 1-3581 Verify that the toner collection hatch cover is closed

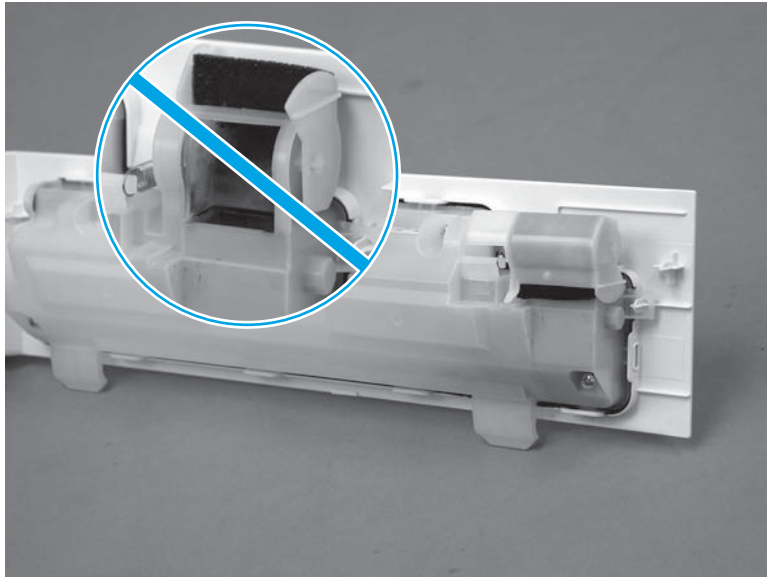

2. Position the TCU with the hinges in the slots provided in the printer (callout 1), and then rotate the TCU up and into the closed position.

 **NOTE:** The toner collection hatch cover automatically opens when the TCU is closed.

Figure 1-3582 Install the TCU



3. Close the front door.

Figure 1-3583 Close the front door

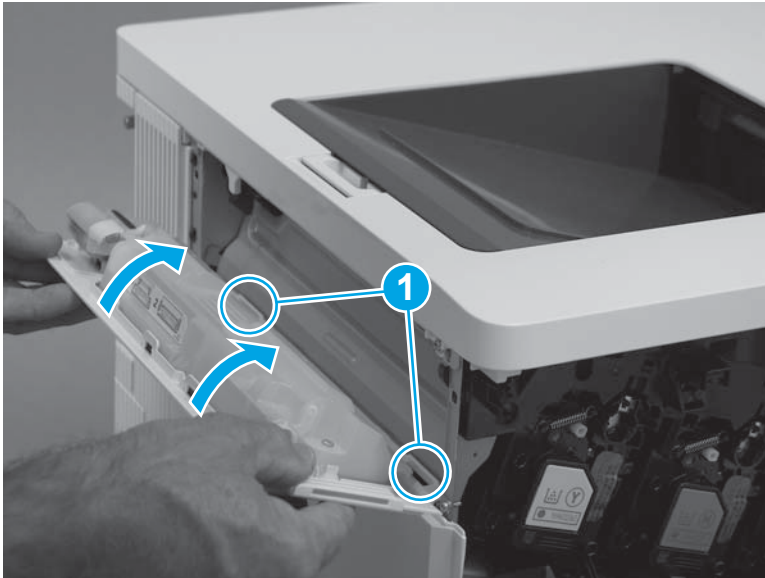

Step 67: Install the tray

1. With the front of the tray slightly lifted, align the sides of the tray with the rails in the printer, and then carefully slide the tray into the printer.

 **TIP:** As the tray slides into the printer, lower the front of it.

Figure 1-3584 Install the tray



2. Close the tray.

Figure 1-3585 Close the tray



Step 68: Install the control-panel assembly (M553x only)

 **NOTE:** For the M553n/dn and M552dn models, skip this step and go to [Step 69: Install the USB cover \(M552 and M553\) on page 2014](#).

For the M577 models, skip this step.

1. Place the control panel on the printer as shown.

Figure 1-3586 Place the control panel on the product

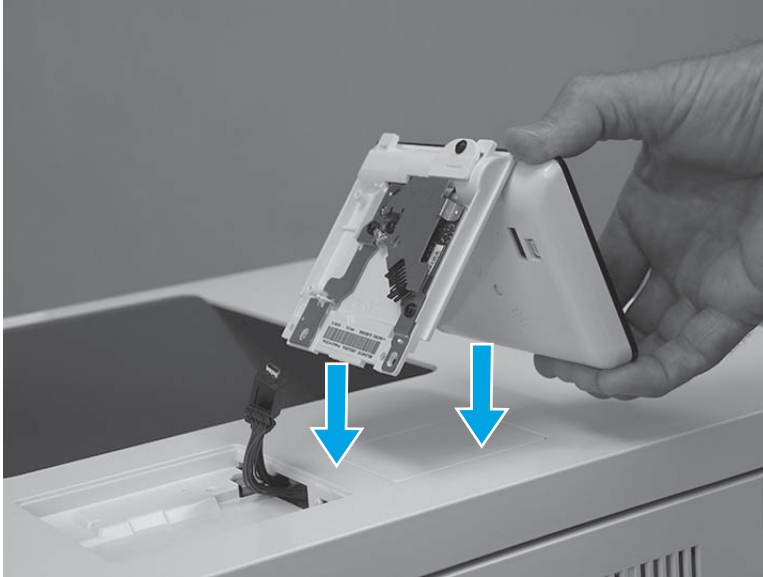

2. Connect one USB cable (callout 1), and one connector (callout 2).

 **IMPORTANT:** Take note of the location of the two mounting tabs (callout 3) on the control-panel assembly.

Figure 1-3587 Connect two connectors



3. Turn the control panel over, and then position the front edge tabs in the slots in the top cover.

Figure 1-3588 Turn the control panel over

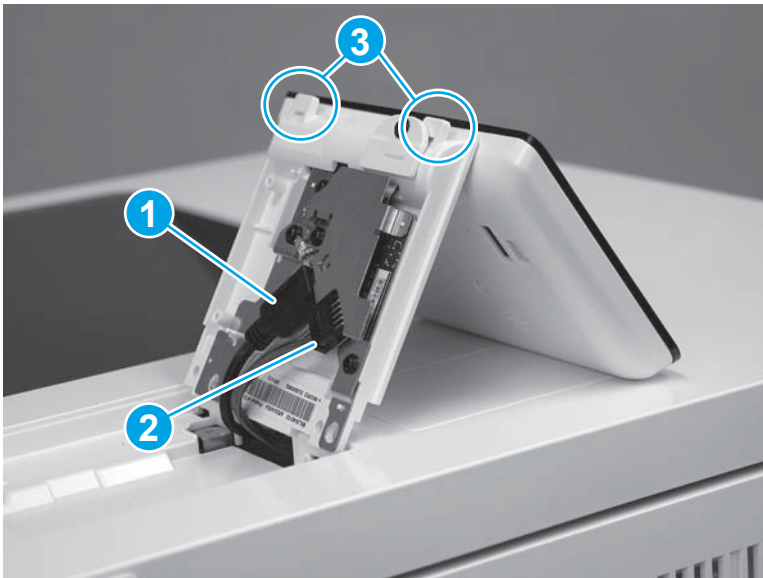
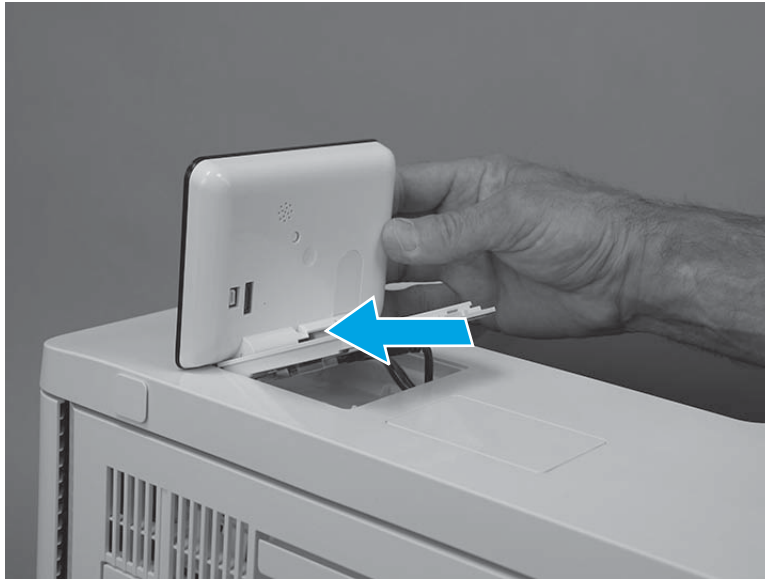

4. Rotate the control-panel base down onto the printer.

Figure 1-3589 Rotate the control-panel base down



5. Use a small Phillips screwdriver to install two screws (callout 1).

Figure 1-3590 Install two screws

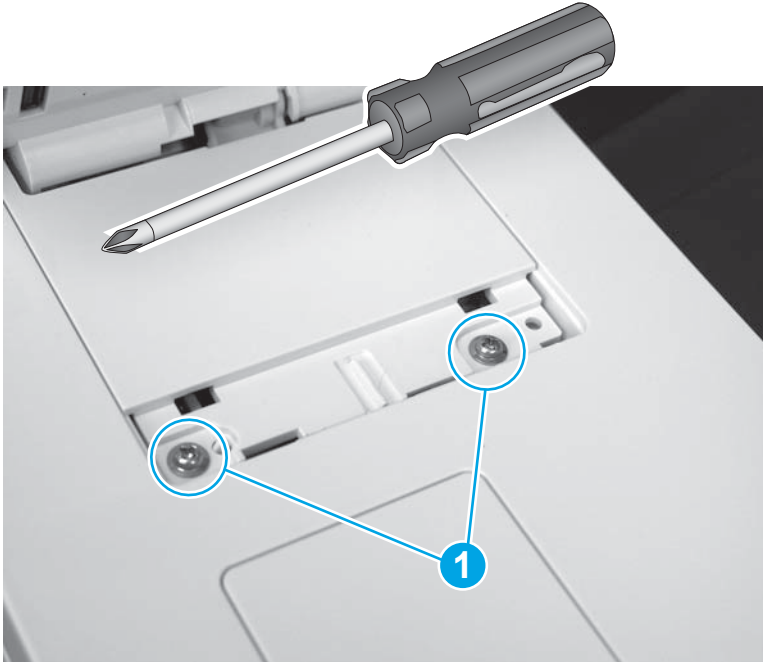

6. Position the screw cover mounting feet into the slots in the top cover (callout 1), and then rotate the cover down (callout 2) to install it.



 **NOTE:** Press down on the cover firmly to make sure that the tabs on the cover (callout 3) snap into place.

Figure 1-3591 Install the cover

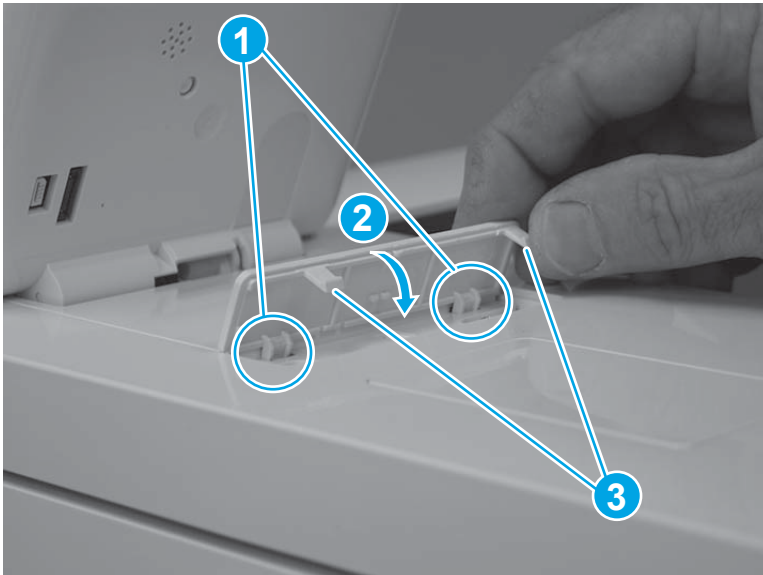

Step 69: Install the USB cover (M552 and M553)

 **NOTE:** This step is for the M552 and M553 models. For the M577 models, skip this step.

1. Push the cover into the USB port to install it.

Figure 1-3592 Install the cover



2. Make sure that the USB cover is fully seated after installing it.

Figure 1-3593 Check the installation

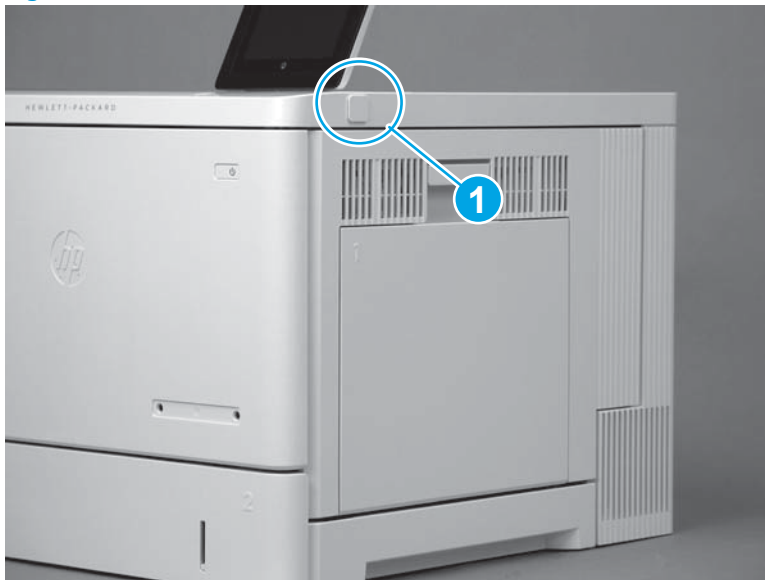

Step 70: Install the ITB

CAUTION: Do not touch the grey-plastic belt. Skin oils and fingerprints on the belt can cause print-quality problems.

1. Handle the ITB by the edges. Do not touch the grey-plastic belt. Skin oils and fingerprints on the belt can cause print-quality problems.

Figure 1-3594 Handle the ITB by the edges

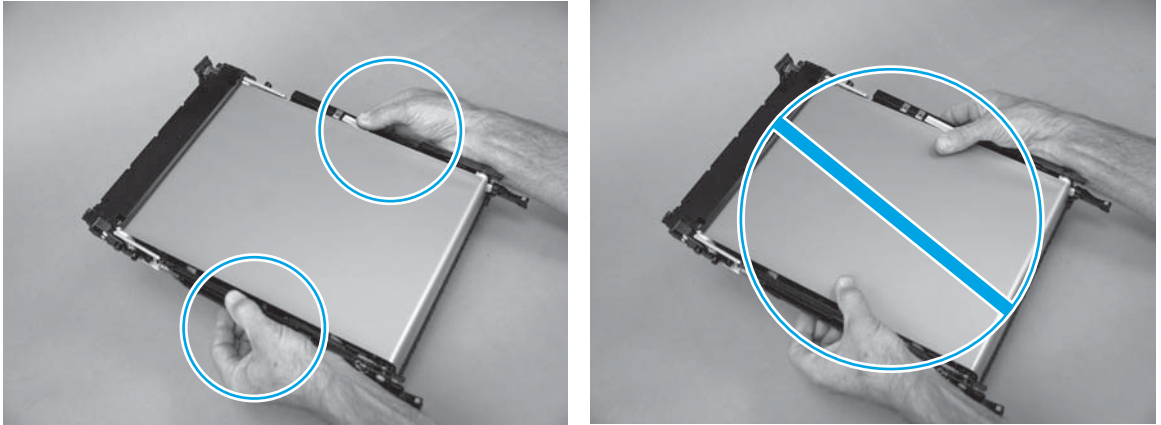

2. Align the ITB with the slots in the printer, and then carefully push it into the printer.

 **NOTE:** Be careful. Do not dislodge the ITB retainer springs from the holders on the chassis. The springs can interfere with installing the ITB.

Figure 1-3595 Align the ITB with the slots in the product

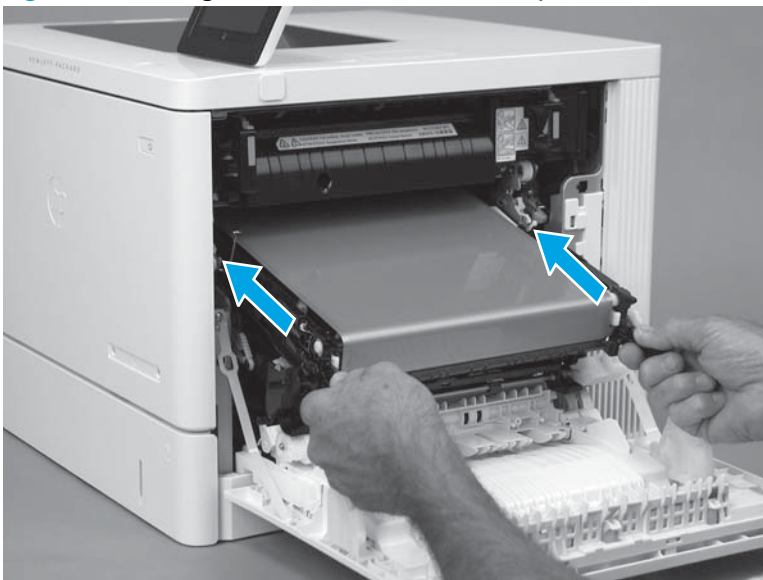

3. Continue to carefully push the ITB into the printer until it is fully installed.

Figure 1-3596 Install the ITB

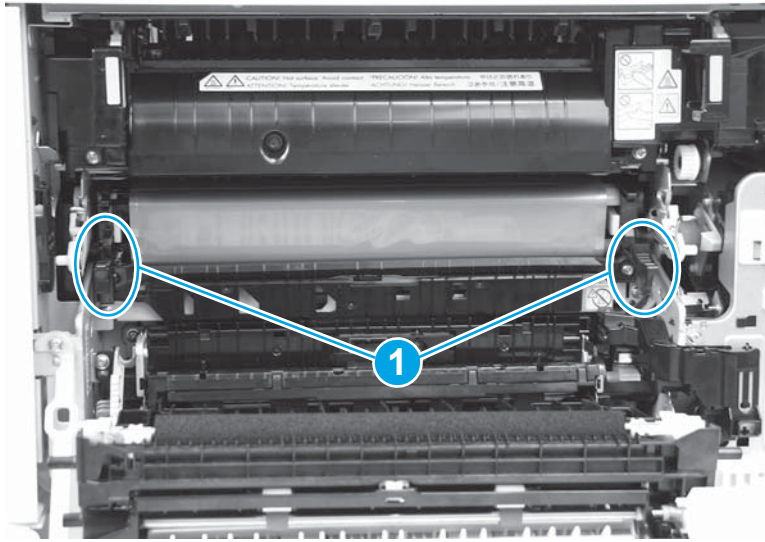

4. Remove the right-side ITB spring from the holder.

Figure 1-3597 Remove the spring from the holder



5. Fasten the right-side ITB spring (callout 1) under the tab (callout 2).

Figure 1-3598 Fasten the rear-side ITB spring

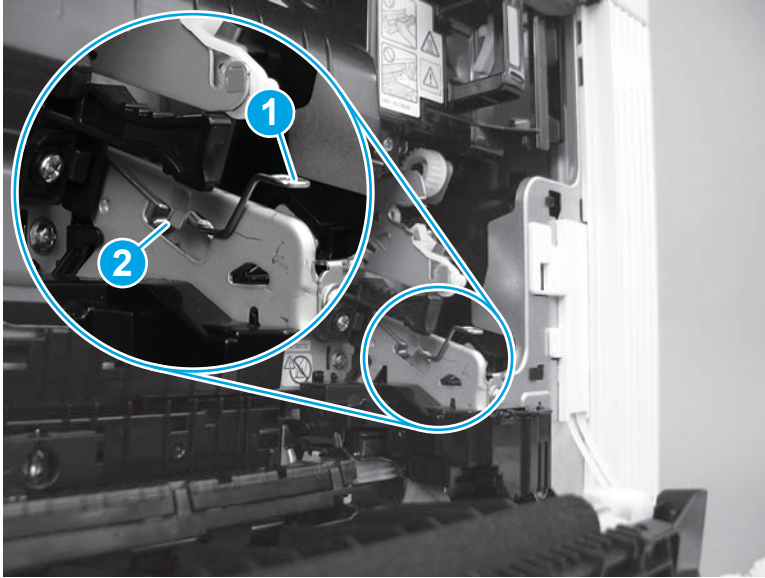

6. Remove the left-side ITB spring from the holder.

Figure 1-3599 Remove the spring from the holder

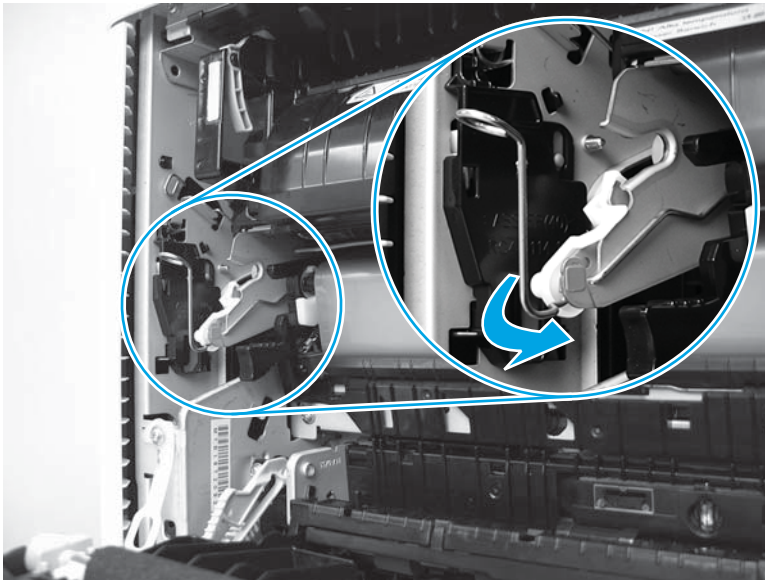

7. Fasten the left-side ITB spring (callout 1) under the tab (callout 2).

Figure 1-3600 Fasten the front-side ITB spring

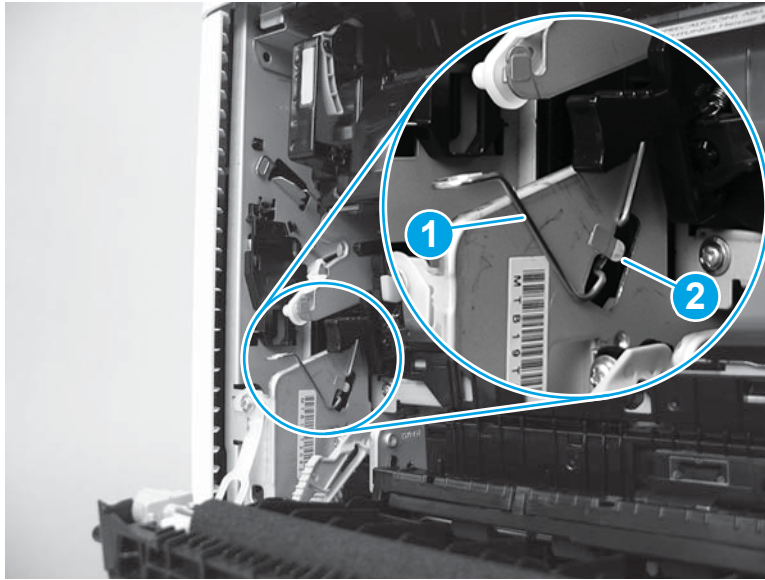

8. Push in the blue lever to engage the ITB drive coupling.

Figure 1-3601 Engage the ITB drive coupling

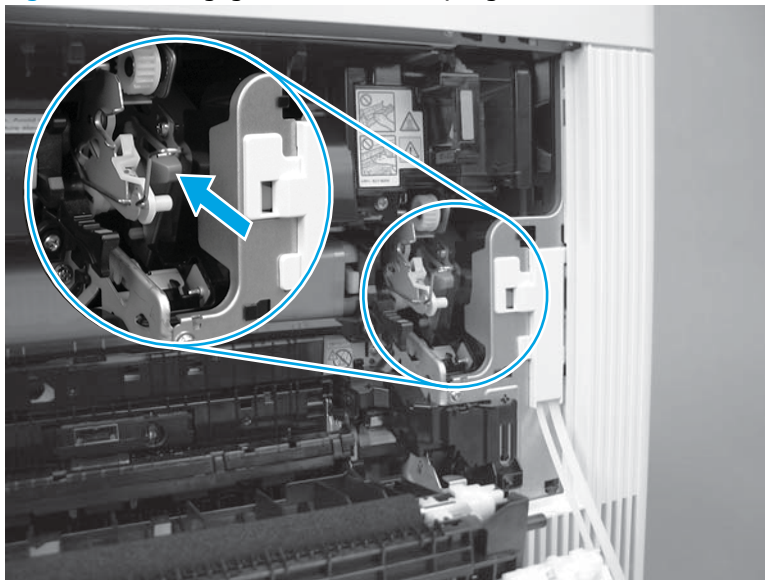

9. Close the right door.

 **TIP:** The right door should close easily if the ITB assembly is correctly installed.

Figure 1-3602 Close the right door



Step 71: Install the fuser

1. Align the fuser with the opening in the printer.

Figure 1-3603 Align the fuser with the opening

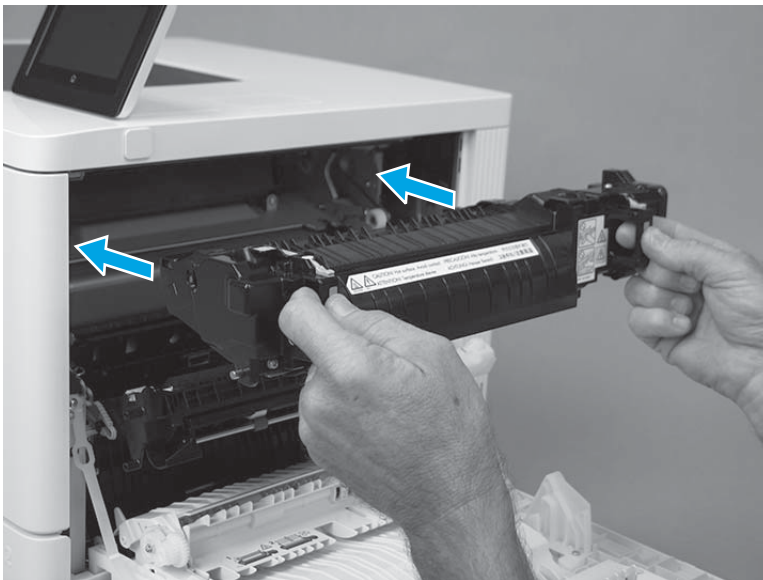

2. Slide the fuser into the printer, push in to install it, and then make sure that it is fully seated.

 **TIP:** When the fuser is fully seated, the two blue triggers on the handles make an audible click.

Figure 1-3604 Install the fuser

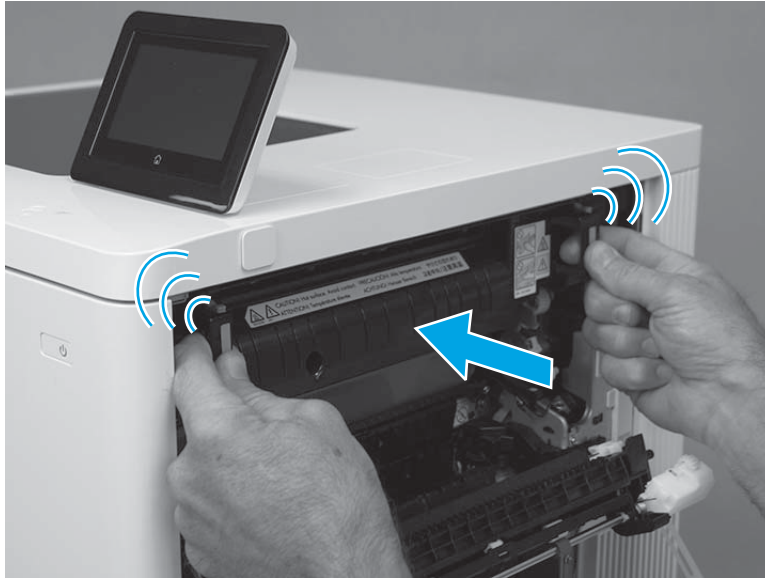

3. Close the right door.

Figure 1-3605 Close the right door



Removal and replacement: Pickup drive assembly and motor (M5)

- [Introduction](#)
- [Step 1: Remove the toner collection unit \(TCU\)](#)
- [Step 2: Remove the formatter cover](#)
- [Step 3: Remove the USB cover \(M552 and M553\)](#)
- [Step 4: Remove the control panel \(M553x only\)](#)
- [Step 5: Remove the formatter \(M552 and M553\)](#)
- [Step 6: Remove the hard-disk drive \(HDD\) \(M577\)](#)
- [Step 7: Remove the fax PCA \(M577c/f/z\)](#)
- [Step 8: Remove the formatter \(M577\)](#)
- [Step 9: Remove the rear cover \(M552 and M553\)](#)
- [Step 10: Remove the rear upper cover \(M577\)](#)
- [Step 11: Remove the rear cover \(M577\)](#)
- [Step 12: Remove the left upper cover \(M577\)](#)
- [Step 13: Remove the right front upper cover \(M577dn\)](#)
- [Step 14: Remove the stapler cover assembly \(M577c/f/z\)](#)
- [Step 15: Remove the integrated scanner assembly \(ISA\) \(M577\)](#)
- [Step 16: Remove the right upper cover \(M577\)](#)
- [Step 17: Remove the left cover](#)
- [Step 18: Remove the upper cover \(M552 and M553\)](#)
- [Step 19: Remove the right rear cover](#)
- [Step 20: Remove the formatter case](#)
- [Step 21: Remove the low-voltage power supply \(LVPS\)](#)
- [Step 22: Remove the power supply fan \(FM1\)](#)
- [Step 23: Remove the high-voltage power supply D \(HVPSD\)](#)
- [Step 24: Remove the lifter drive assembly](#)
- [Step 25: Remove the DC controller and sheet-metal bracket](#)
- [Step 26: Remove the pickup drive assembly and motor \(M5\)](#)
- [Step 27: Unpack the replacement assembly](#)
- [Step 28: Install the pickup drive assembly and motor \(M5\)](#)
- [Step 29: Install the DC controller and sheet-metal bracket](#)

- [Step 30: Install the lifter drive assembly](#)
- [Step 31: Install the HVPSD](#)
- [Step 32: Install the power-supply fan \(FM1\)](#)
- [Step 33: Install the LVPS](#)
- [Step 34: Install the formatter case](#)
- [Step 35: Install the right rear cover](#)
- [Step 36: Install the upper cover \(M552 and M553\)](#)
- [Step 37: Install the left cover](#)
- [Step 38: Install the right upper cover \(M577\)](#)
- [Step 39: Install the integrated scanner assembly \(ISA\) \(M577\)](#)
- [Step 40: Install the stapler cover assembly \(M577c/f/z\)](#)
- [Step 41: Install the right front upper cover \(M577dn\)](#)
- [Step 42: Install the left upper cover \(M577\)](#)
- [Step 43: Install the rear cover \(M577\)](#)
- [Step 44: Install the rear upper cover \(M577\)](#)
- [Step 45: Install the rear cover \(M552 and M553\)](#)
- [Step 46: Install the formatter \(M577\)](#)
- [Step 47: Install the fax PCA \(M577c/f/z\)](#)
- [Step 48: Install the HDD \(M577\)](#)
- [Step 49: Install the formatter \(M552 and M553\)](#)
- [Step 50: Install the control-panel assembly \(M553x only\)](#)
- [Step 51: Install the USB cover \(M552 and M553\)](#)
- [Step 52: Install the formatter cover](#)
- [Step 53: Install the TCU](#)

Introduction

This document provides the procedures to remove and replace the pickup drive assembly and pickup motor (M8).

Before performing service

 **TIP:** Some figures might show assemblies removed or installed that have not yet been removed or installed at that specific step. However, the procedures are correct for this printer and the target assembly. Always thoroughly read the instructions that accompany each figure.

Turn the printer power off

- Disconnect the power cable.

⚠ WARNING! To avoid damage to the printer, turn the printer off, wait 30 seconds, and then remove the power cord before attempting to service the printer.

Use the table below to identify the correct part number for your printer, and then go to <http://h20141.www2.hp.com/hpparts> to order the part.

Pickup drive assembly and motor (M5) part number

RM2-0008-000CN

Pickup drive assembly and motor (M5)

Required tools

- #2 Phillips screwdriver with a magnetic tip

After performing service

Turn the printer power on

- Connect the power cable.
- Use the power switch to turn the power on.

Post service test

Use the components test to test the (pickup) motor. For more information, see the printer troubleshooting manual.

Step 1: Remove the toner collection unit (TCU)

1. Open the front door.

Figure 1-3606 Open the front door



2. Open the TCU.



NOTE: The toner collection hatch cover automatically closes when the TCU is opened.

Figure 1-3607 Open the TCU



3. Pull the TCU away from the printer at an angle to remove it.

⚠ CAUTION: Do not open the toner collection hatch cover when handling the TCU. If toner gets on clothing, wipe it off by using a dry cloth and wash the clothes in cold water. Hot water sets toner into fabric.

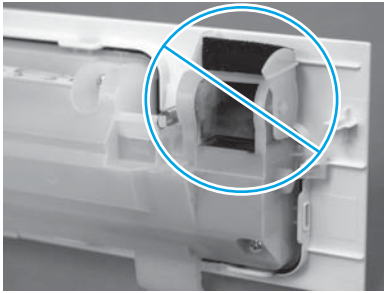
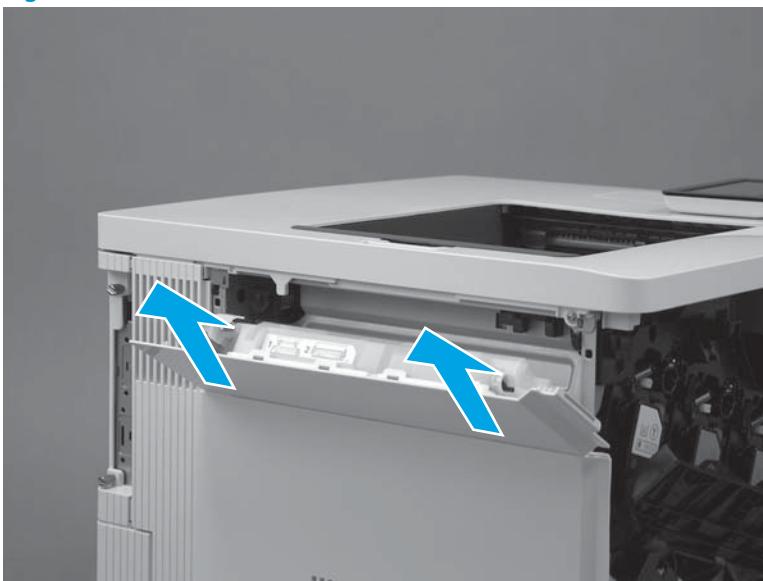

Figure 1-3608 Remove the TCU



Step 2: Remove the formatter cover

1. Locate the formatter cover.

Figure 1-3609 Locate the formatter cover

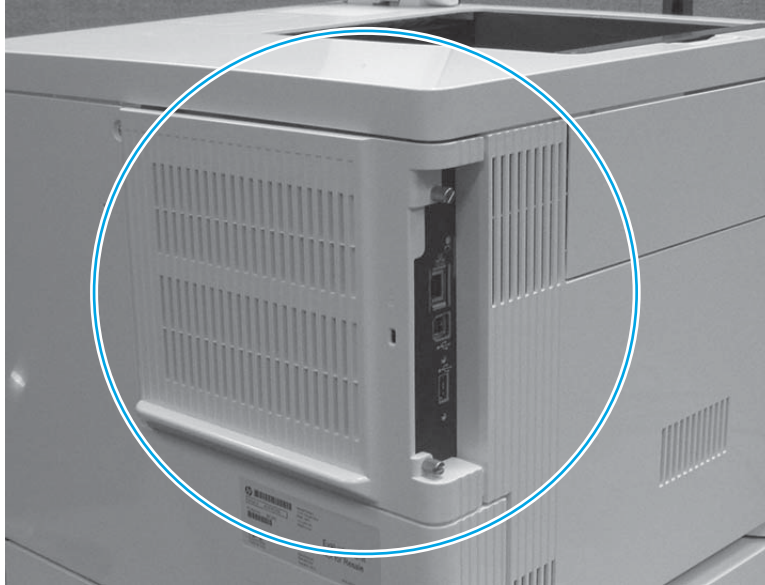

2. Loosen the two thumbscrews (callout 1). Grasp the two thumbscrews, and then slide the cover away from the printer (callout 2) to remove it.

 **TIP:** If needed, use the edge of a coin to turn the thumbscrews.

Figure 1-3610 Loosen the thumbscrews



Step 3: Remove the USB cover (M552 and M553)

 **NOTE:** This step is for the M552 and M553 models. For the M577 models, skip this step and go to [Step 6: Remove the hard-disk drive \(HDD\) \(M577\) on page 2033](#).

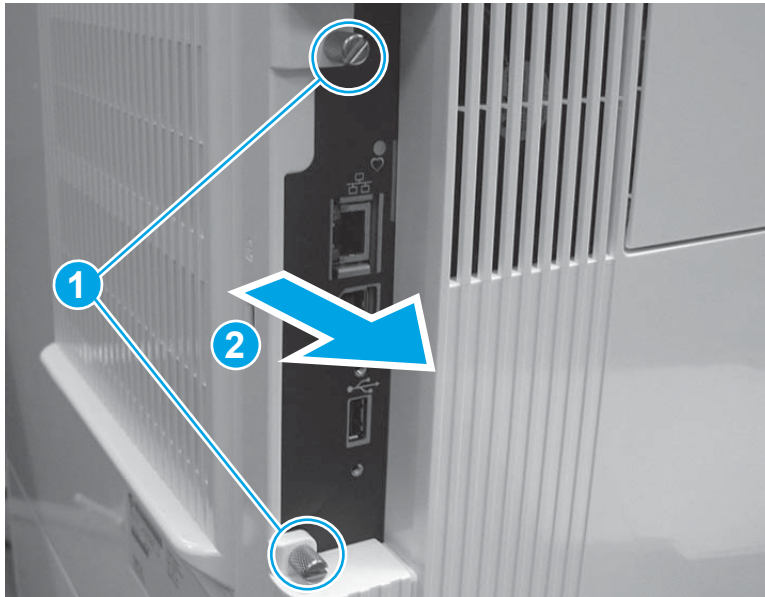
1. Locate the USB cover.

Figure 1-3611 Locate the USB cover



2. Pull the cover off of the printer to remove it.

Figure 1-3612 Remove the cover



Step 4: Remove the control panel (M553x only)

 **NOTE:** For the M553n/dn and M552dn models, skip this step and go to [Step 5: Remove the formatter \(M552 and M553\) on page 2032](#).

For the M577 models, skip this step and go to [Step 6: Remove the hard-disk drive \(HDD\) \(M577\) on page 2033](#).

1. Tilt the control panel up.

Figure 1-3613 Tilt the control panel up



2. Use a small flat-blade screwdriver to release the control-panel screws cover tabs.

Figure 1-3614 Release the control-panel screws cover tabs



3. Rotate the cover up to remove it.

Figure 1-3615 Remove the cover

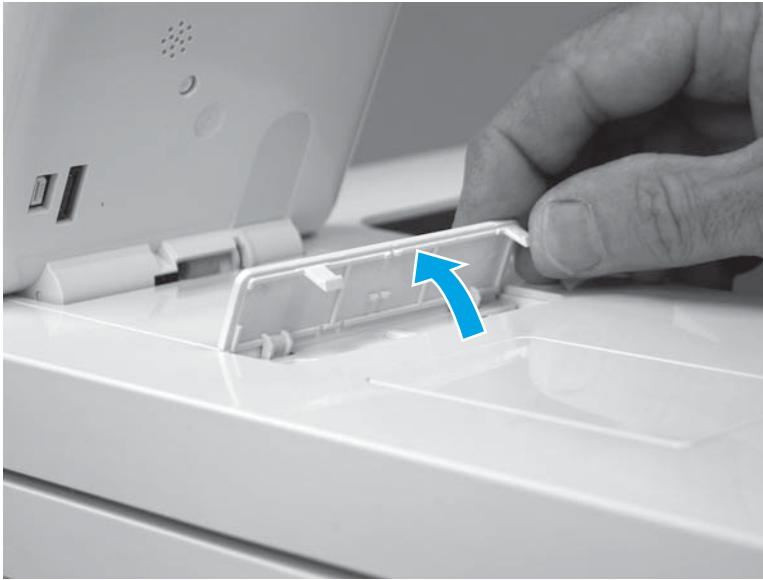

4. Use a small Phillips screwdriver to remove two screws (callout 1).

 **IMPORTANT:** Store the screws in a secure place where they cannot fall down into the printer.

Figure 1-3616 Remove two screws

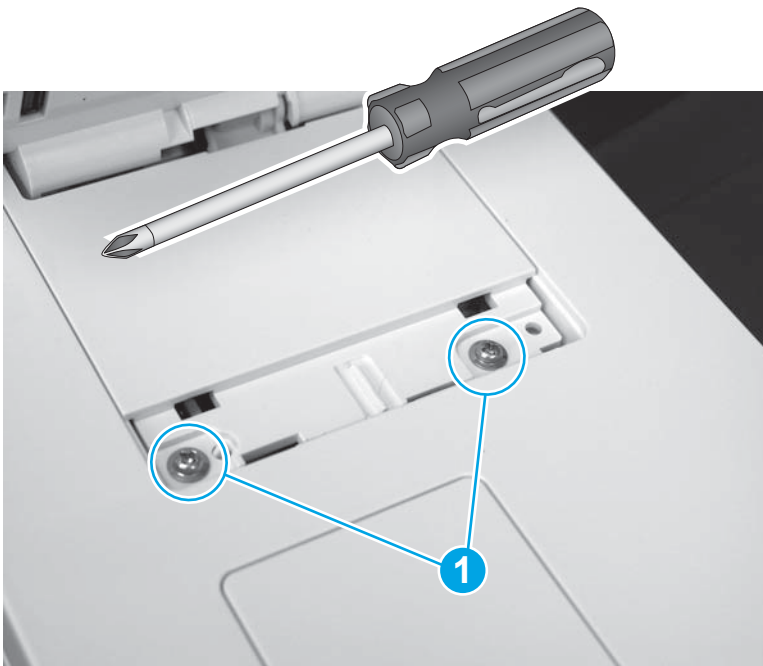

5. Rotate the control-panel base toward the front of the printer.

Figure 1-3617 Rotate the control-panel base up



6. Slightly slide the control-panel base toward the rear of the printer (callout 1) to release it, and then turn the control panel over (callout 2) to access the bottom side.

⚠ CAUTION: The control panel is still attached to the printer. Do not attempt to completely remove the control panel.

Figure 1-3618 Turn the control panel over

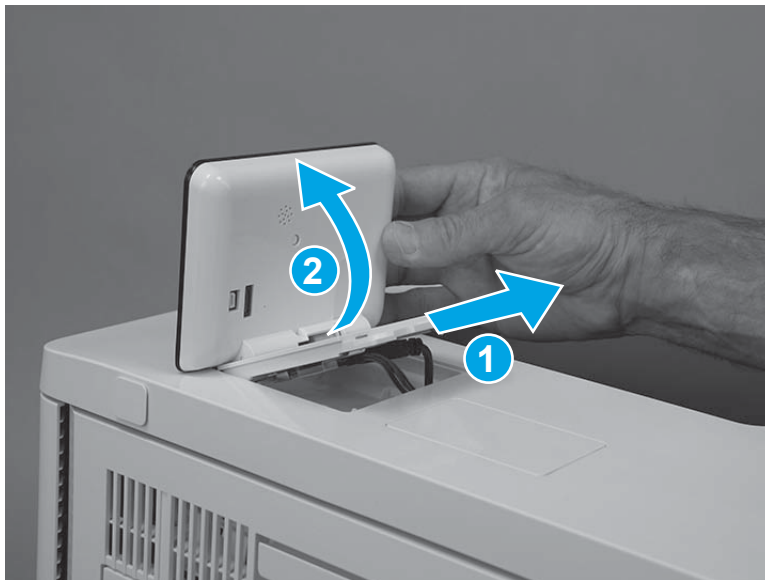

7. Disconnect one USB cable (callout 1), one connector (callout 2), and then remove the control panel.

Figure 1-3619 Disconnect two connectors

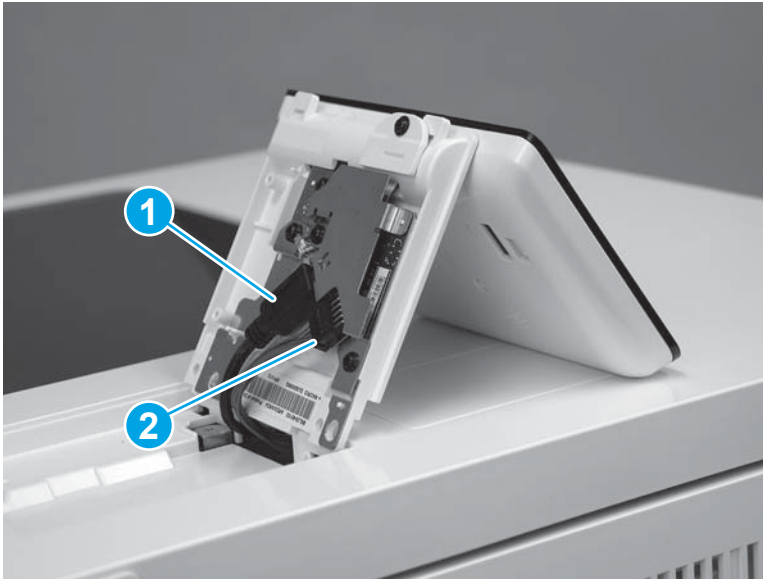

Step 5: Remove the formatter (M552 and M553)



NOTE: This step is for the M552 and M553 models. For the M577 models, skip this step and go to [Step 6: Remove the hard-disk drive \(HDD\) \(M577\) on page 2033](#).

If the optional hard-disk drive (HDD) is installed, it must be removed to gain access to the formatter mounting screws.

Release two tabs along the left edge of the HDD, rotate the left edge away from the product, and then slide the HDD to the left to remove it.



CAUTION:  ESD-sensitive part.

1. Disconnect all of the connectors on the formatter.

The following connectors are empty:

- All models: J1 (this connector is empty unless the optional DIMM is installed)
- M553n/dn and M552dn: J2 (callout 1; this is the touchscreen connector for the M553x model)
- All models: J9 (this connector is empty unless the optional internal USB ports component is installed)
- All models: J18 (this connector is empty unless the optional hard-disk-drive (HDD) is installed)
- All models: J23
- All models: J24
- M553n/dn and M552dn: J25 (this is the wireless connector for the M553x model)

- All models: J57
- All models: J98 (this connector is empty unless the optional trusted platform module (TPM) is installed)

 **IMPORTANT:** The flat-cable connector (callout 2) is a Zero Insertion Force (ZIF) connector that uses a hinged retainer to secure the flat cable. The hinged retainer must be opened to release the flat cable.

Figure 1-3620 Disconnect all connectors



2. Remove four screws (callout 1), and then remove the formatter.

Figure 1-3621 Remove the formatter

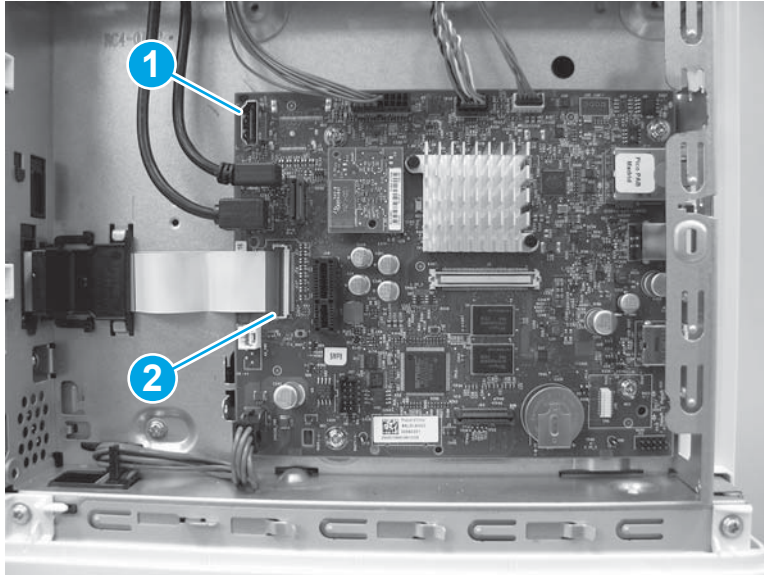
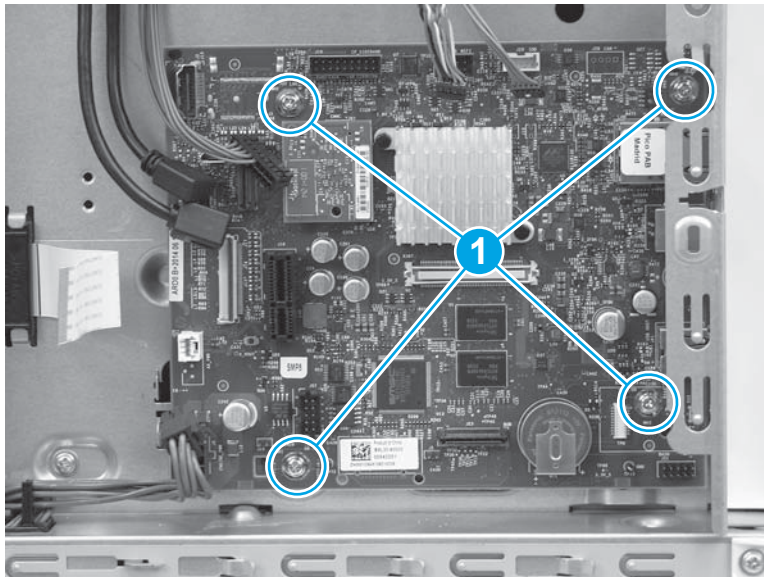

Step 6: Remove the hard-disk drive (HDD) (M577)

 **NOTE:** This step is for the M577 models. For the M552 and M553 models, skip this step and go to [Step 9: Remove the rear cover \(M552 and M553\) on page 2038](#).

 **CAUTION:**  ESD-sensitive part.

1. Release two tabs (callout 1). Hold the tabs in the released position, and then rotate the hard disk drive (HDD) up (callout 2) to release the connector from the formatter.

Figure 1-3622 Release the HDD

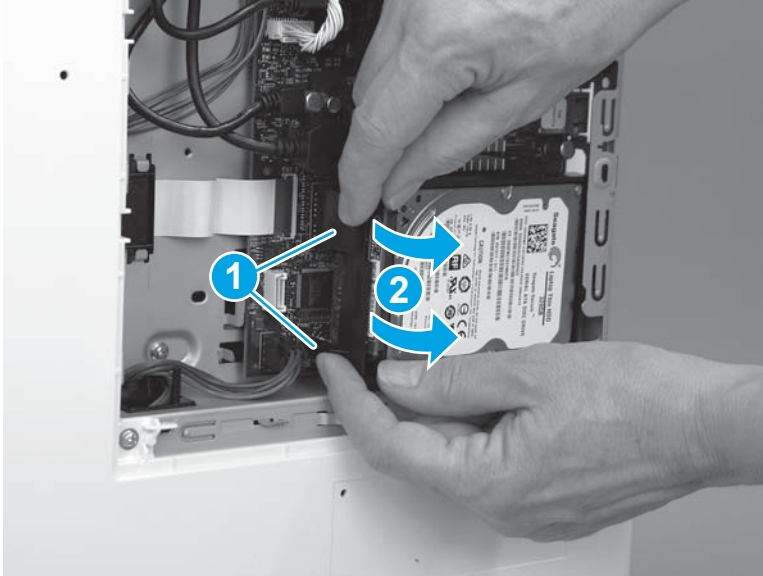

2. Slide the HDD away from the printer to remove it.

Figure 1-3623 Remove the HDD

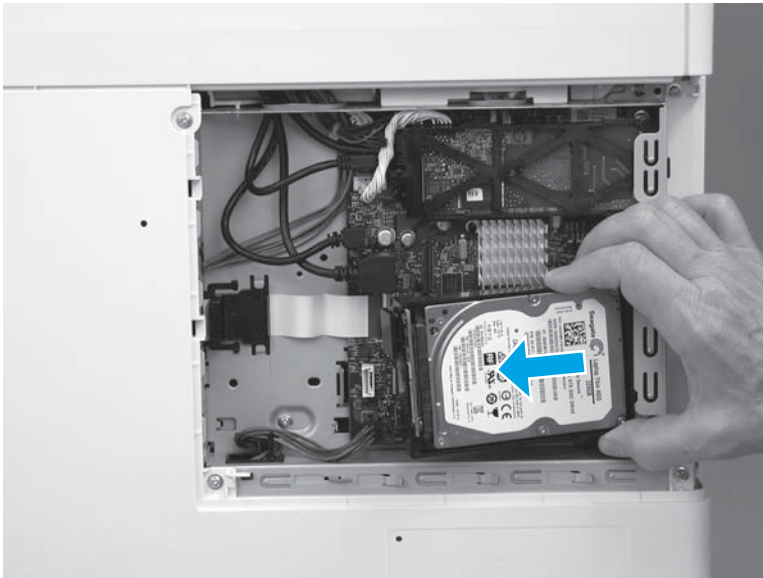

Step 7: Remove the fax PCA (M577c/f/z)

 **NOTE:** This step is for the M577c/f/z models. For the M577n model, skip this step and go to [Step 8: Remove the formatter \(M577\) on page 2036](#).

For the M552 and M553 models, skip this step and go to [Step 9: Remove the rear cover \(M552 and M553\) on page 2038](#).

 **CAUTION:**  ESD-sensitive part.

1. Locate the fax PCA component on the formatter.

Figure 1-3624 Locate the fax PCA

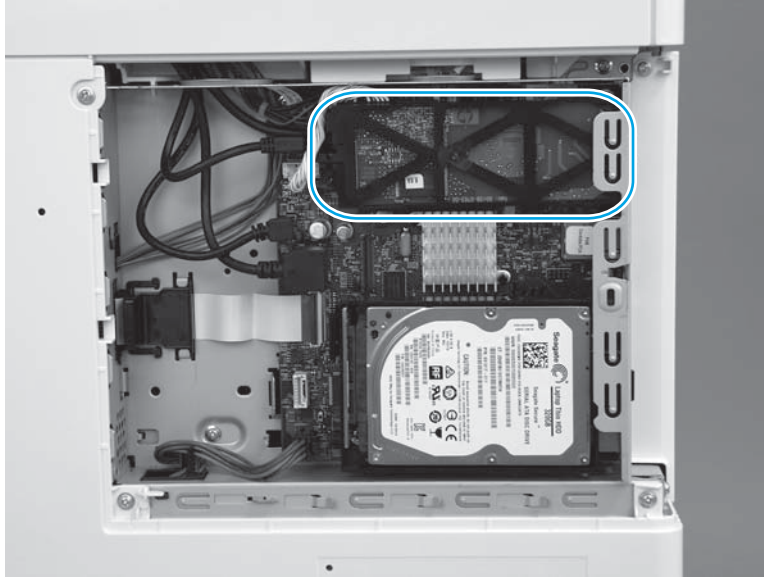

2. Release the connector latch (callout 1), and then pull the connector away from the formatter (callout 2) to disconnect it.

Figure 1-3625 Disconnect one connector

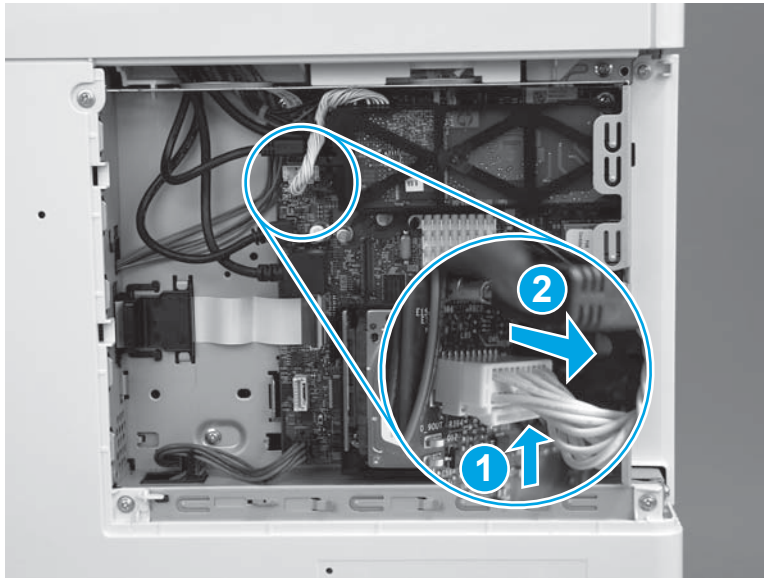

3. Release one retainer (callout 1) by pressing the bracket arms together.

Figure 1-3626 Release one latch

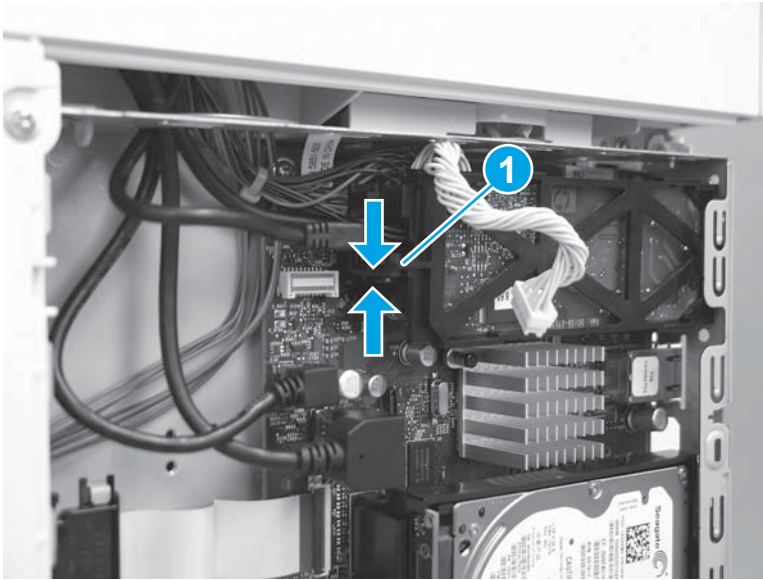

4. Rotate the end of the fax PCA (callout 1) away from the formatter, and then slide the PCA left (callout 2) to remove it.

Figure 1-3627 Remove the fax PCA

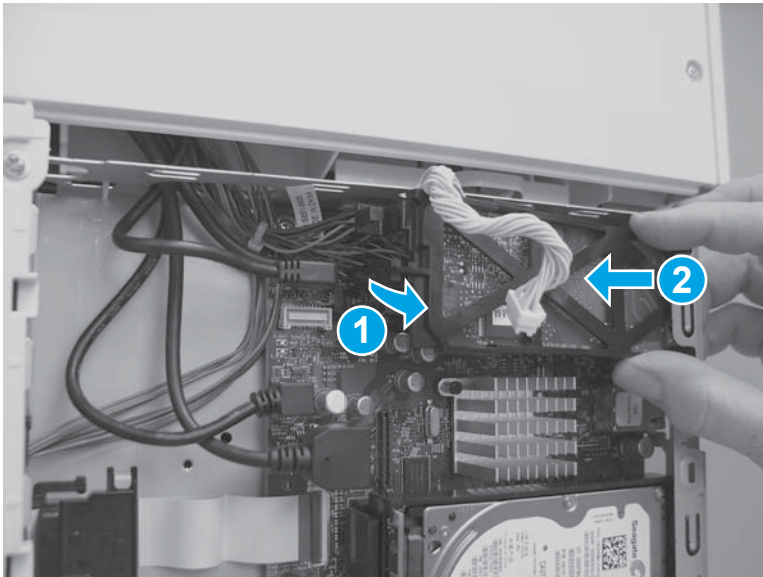

Step 8: Remove the formatter (M577)

 **NOTE:** This step is for the M577 models. For the M552 and M553 models, skip this step and go to [Step 9: Remove the rear cover \(M552 and M553\) on page 2038.](#)

 **CAUTION:**  ESD-sensitive part.

1. Disconnect all of the connectors on the formatter.

The following connectors are empty:

- All models: J1 (this connector is empty unless the optional DIMM is installed)
- All models: J3
- M577dn: J15 (this is the fax connector for the M577f/z/c models)
- All models: J21 (this connector is empty unless the optional internal USB ports component is installed)
- All models: J23
- All models: J24
- All models: J51
- All models: J57
- All models: J97
- All models: J98 (this connector is empty unless the optional trusted platform module (TPM) is installed)

 **IMPORTANT:** The flat-cable connector (callout 1) is a Zero Insertion Force (ZIF) connector that uses a hinged retainer to secure the flat cable. The hinged retainer must be opened to release the flat cable.

Figure 1-3628 Disconnect all connectors



2. Remove four screws (callout 1).

Figure 1-3629 Remove four screws

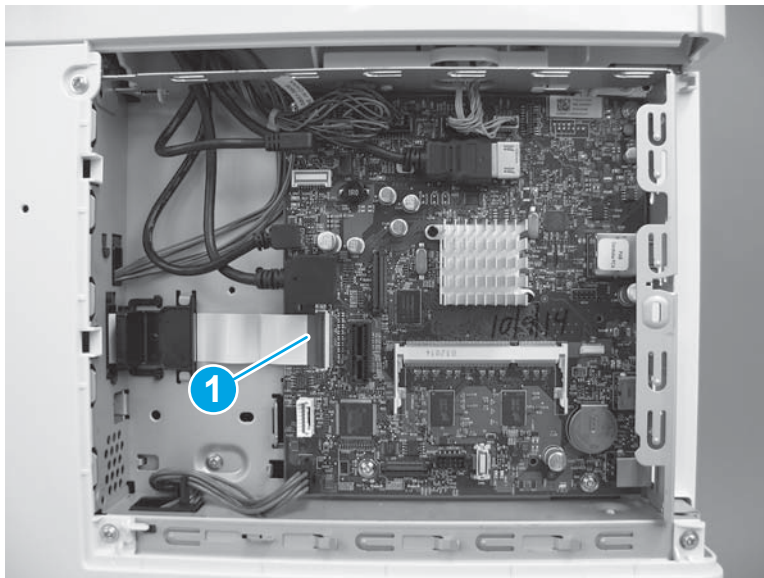
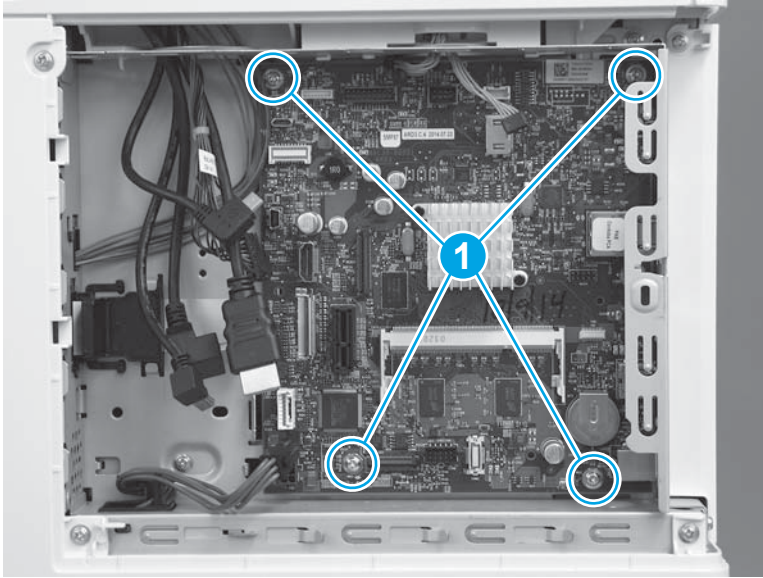

3. Remove the formatter.

Figure 1-3630 Remove the formatter

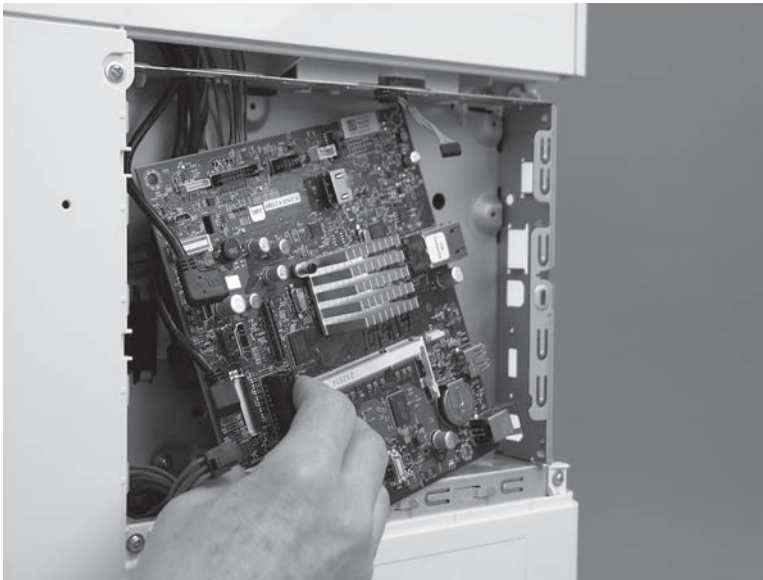

Step 9: Remove the rear cover (M552 and M553)



NOTE: This step is for the M552 and M553 models. For the M577 models, skip this step and go to [Step 10: Remove the rear upper cover \(M577\) on page 2039](#).

1. Remove four screws (callout 1).

Figure 1-3631 Remove four screws

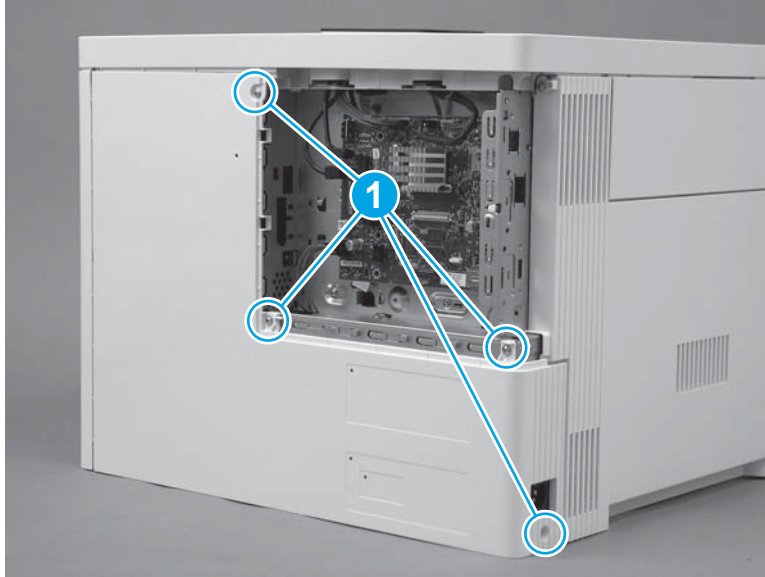

2. Slightly slide the cover to the right (callout 1), rotate the bottom of the cover away from the printer (callout 2), and then pull the top of the cover away from the printer (callout 3) to remove the cover.

Figure 1-3632 Remove the cover

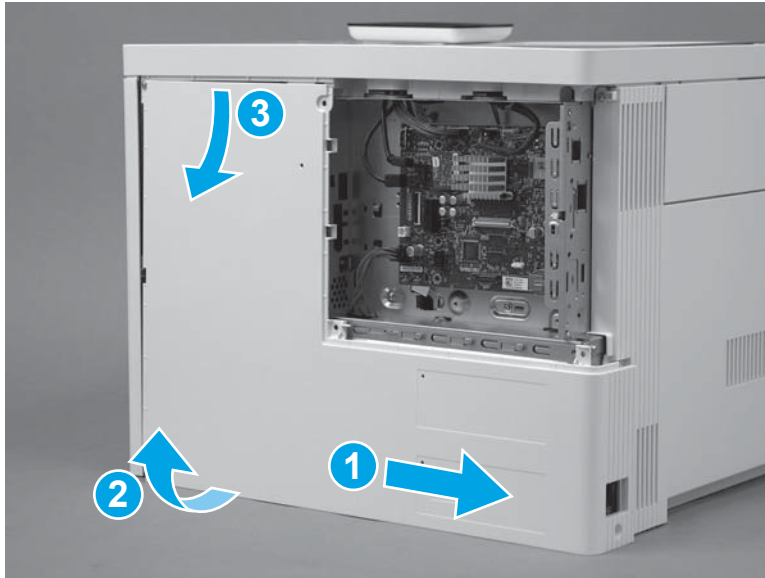

Step 10: Remove the rear upper cover (M577)



NOTE: This step is for the M577 models. For the M552 and M553 models, skip this step and go to [Step 17: Remove the left cover on page 2052](#).

1. Remove two screws (callout 1).



Reinstallation tip: These two screws are self-tapping screws for plastic. When reinstalling them, rotate the screws counterclockwise to align them with the existing thread pattern, and then carefully turn them clockwise to tighten. Do not overtighten. This will prevent stripping the threads inside the screw holes.

Figure 1-3633 Remove two screws

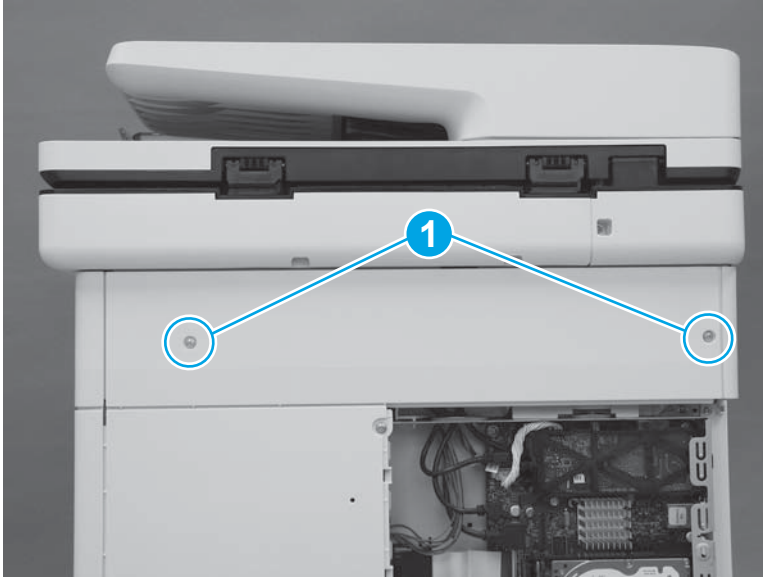

2. Use a small, flat blade screwdriver to release the right edge of the cover.

Figure 1-3634 Release the right edge

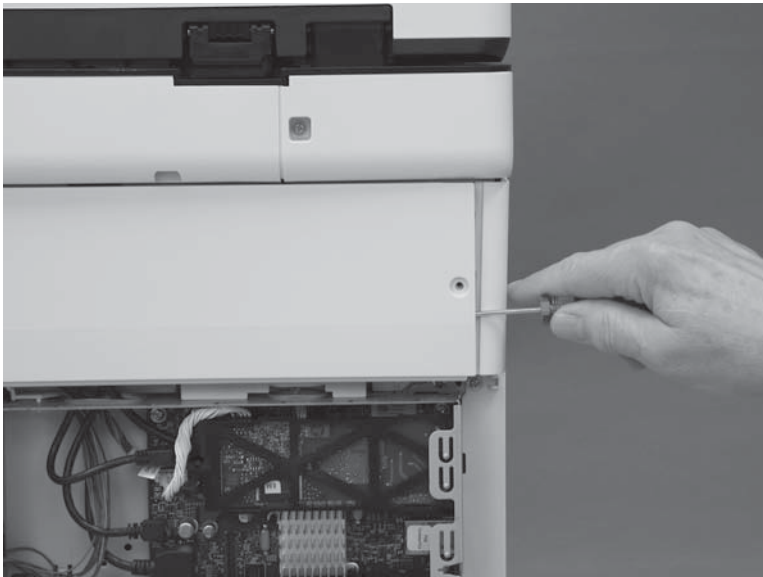

3. Pull the right edge of the cover (callout 1) away from the printer, and then slide the cover to the right (callout 2).

Figure 1-3635 Slide the cover right

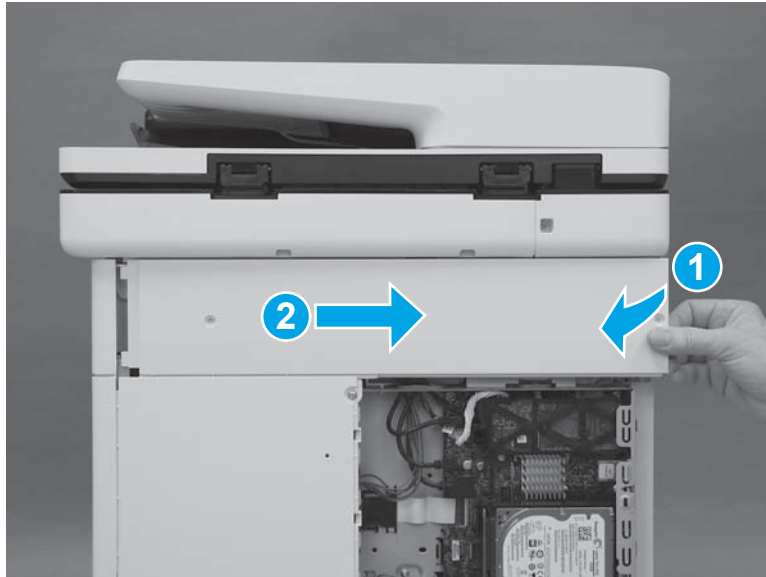

4. Remove the cover.

Figure 1-3636 Remove the cover

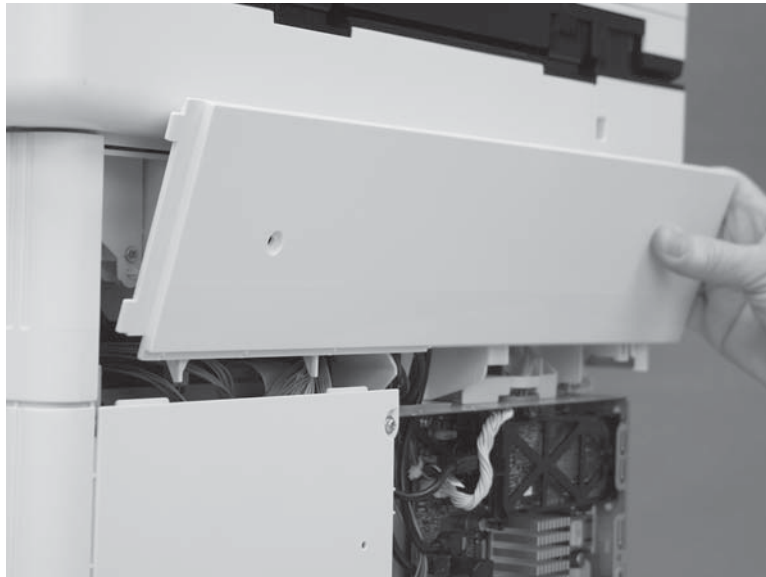

Step 11: Remove the rear cover (M577)

 **NOTE:** This step is for the M577 models. For the M552 and M553 models, skip this step and go to [Step 17: Remove the left cover on page 2052](#).

1. Remove four screws (callout 1).

Figure 1-3637 Remove four screws

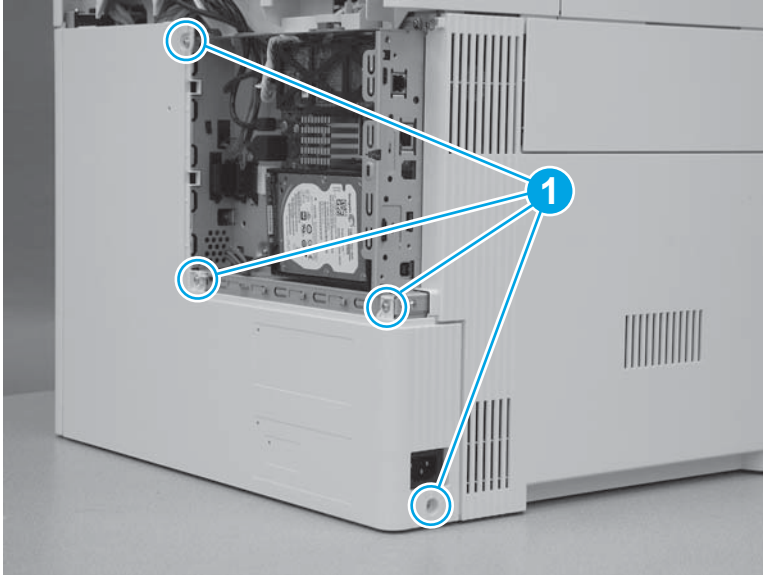

2. Slide the cover to the right to remove it.

Figure 1-3638 Remove the cover

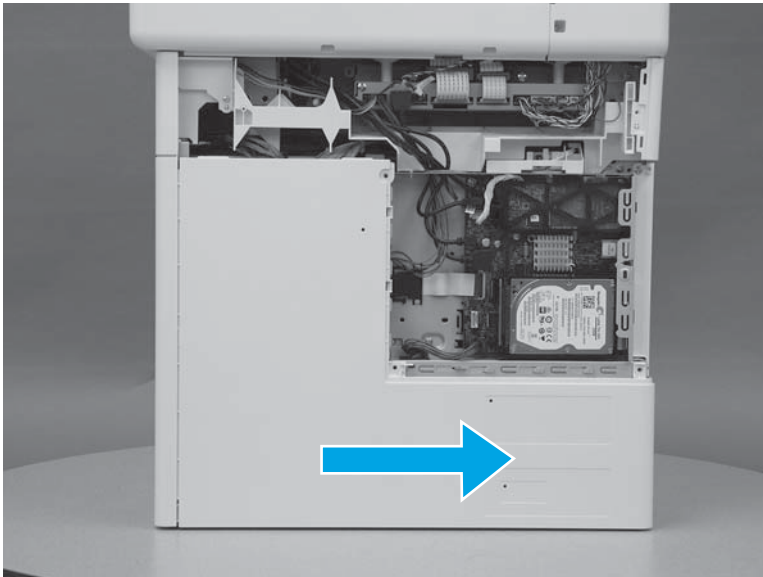

Step 12: Remove the left upper cover (M577)



NOTE: This step is for the M577 models. For the M552 and M553 models, skip this step and go to [Step 17: Remove the left cover on page 2052](#).

1. At the left side of the printer, release one tab (callout 1).

Figure 1-3639 Release one tab

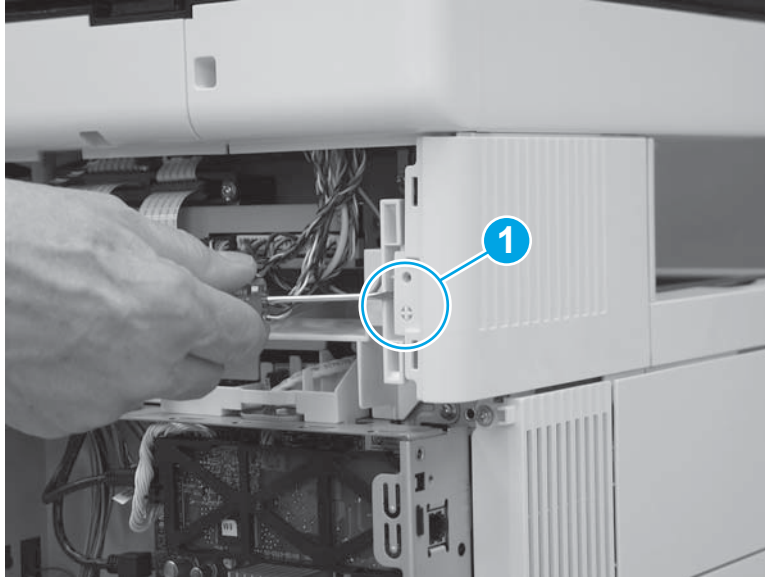

2. Slide the left upper cover toward the back of the printer.

Figure 1-3640 Slide the cover back

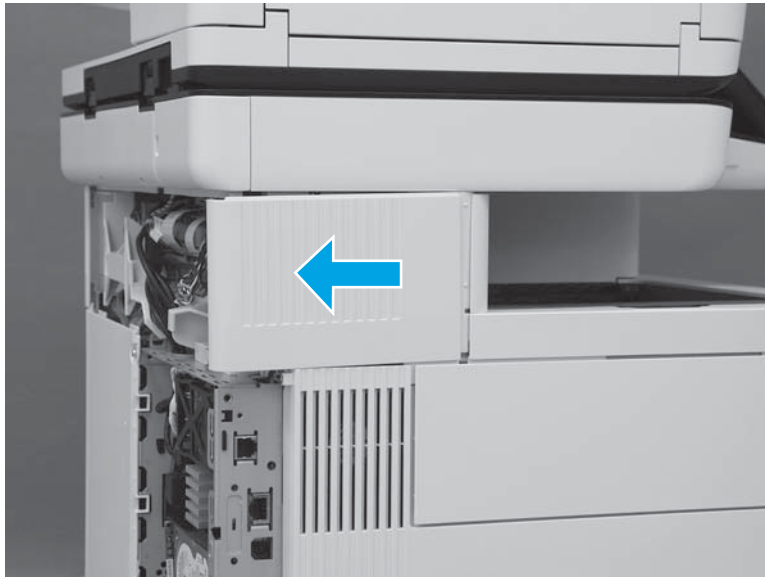

3. Rotate the cover up to remove it.

Figure 1-3641 Remove the left upper cover

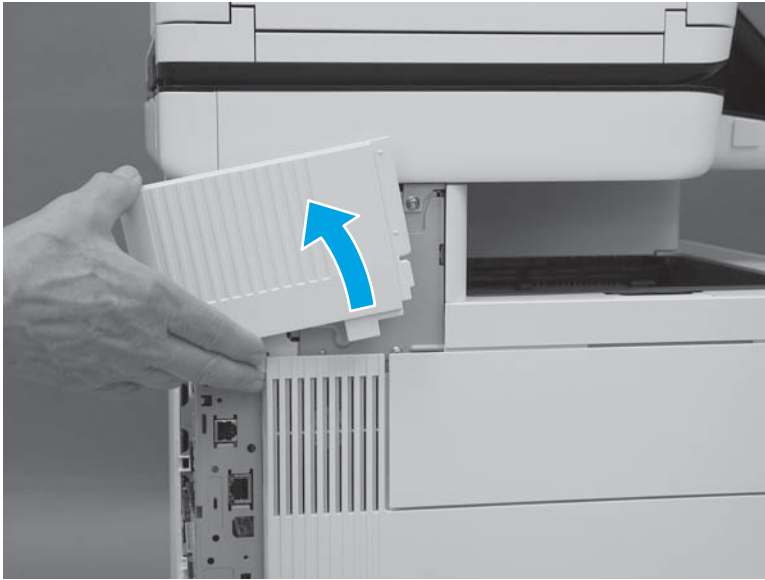

Step 13: Remove the right front upper cover (M577dn)



NOTE: This step is for the M577dn model. For the M577c/f/z models, skip this step and to go [Step 14: Remove the stapler cover assembly \(M577c/f/z\) on page 2045.](#)

For the M552 and M553 models, skip this step and go to [Step 17: Remove the left cover on page 2052.](#)

1. Remove one screw (callout 1).

Figure 1-3642 Remove one screw

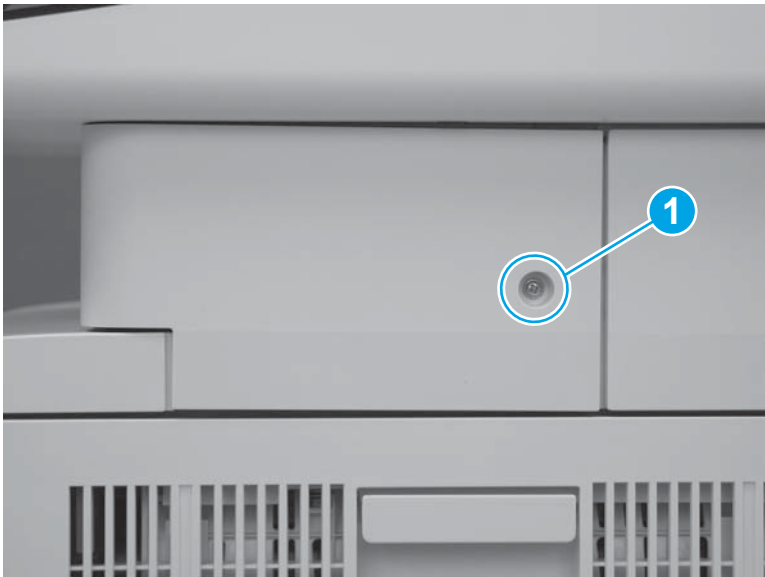

2. Release two tabs at the front edge of the cover (callout 1).

Figure 1-3643 Release two tabs



3. Rotate the front of the cover to the right to remove it.

Figure 1-3644 Rotate the cover



Step 14: Remove the stapler cover assembly (M577c/f/z)

 **NOTE:** This step is for the M577c/f/z models. For the M577dn model, skip this step and to go [Step 16: Remove the right upper cover \(M577\) on page 2050.](#)

For the M552 and M553 models, skip this step and go to [Step 17: Remove the left cover on page 2052.](#)

1. Remove one screw (callout 1).

 **Reinstallation tip:** This is a self-tapping screw for plastic. When reinstalling, rotate the screw counterclockwise to align it with the existing thread pattern, and then carefully turn it clockwise to tighten. Do not overtighten. This will prevent stripping the threads inside the screw hole.

Figure 1-3645 Remove one screw



2. Release two tabs at the front edge of the cover (callout 1).

Figure 1-3646 Release two tabs

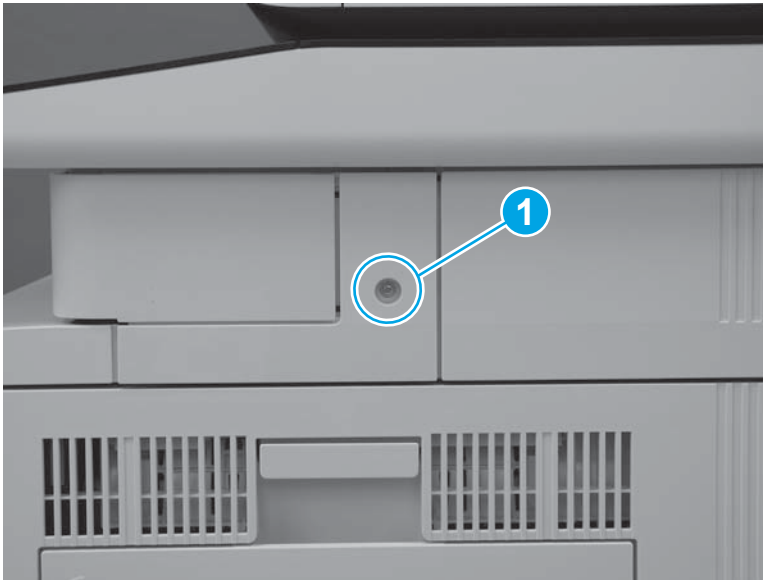

3. Release the back edge of the cover.

Figure 1-3647 Release the back edge of the cover





4. Rotate the cover away from the printer to remove it.

Figure 1-3648 Remove the cover



Step 15: Remove the integrated scanner assembly (ISA) (M577)

 **NOTE:** This step is for the M577 models. For the M552 and M553 models, skip this step and go to [Step 17: Remove the left cover on page 2052](#).

 **NOTE:** The ISA includes the document feeder, image scanner, scanner control board (SCB), control panel, keyboard (M577c/z) and NFC PCA (M577z).

1. At the left side of the printer, remove one screw (callout 1).

Figure 1-3649 Remove one screw

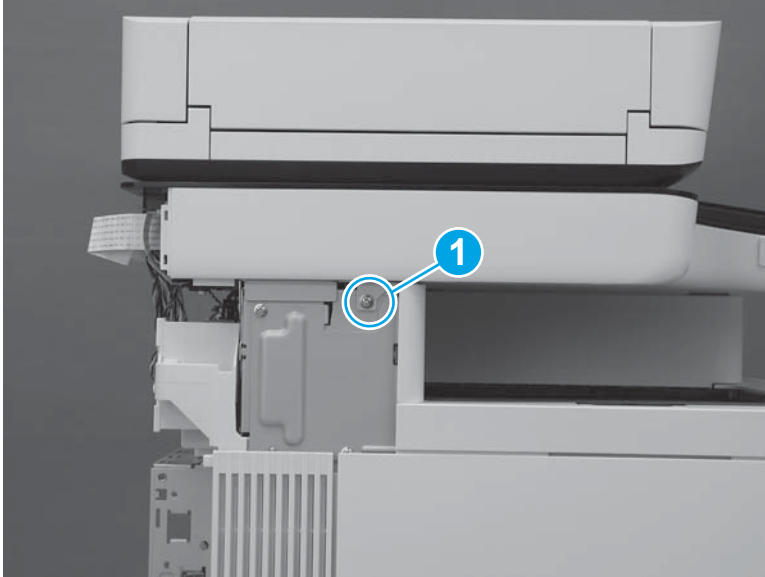

2. At the back side of the printer, remove two screws (callout 1).

Figure 1-3650 Remove two screws

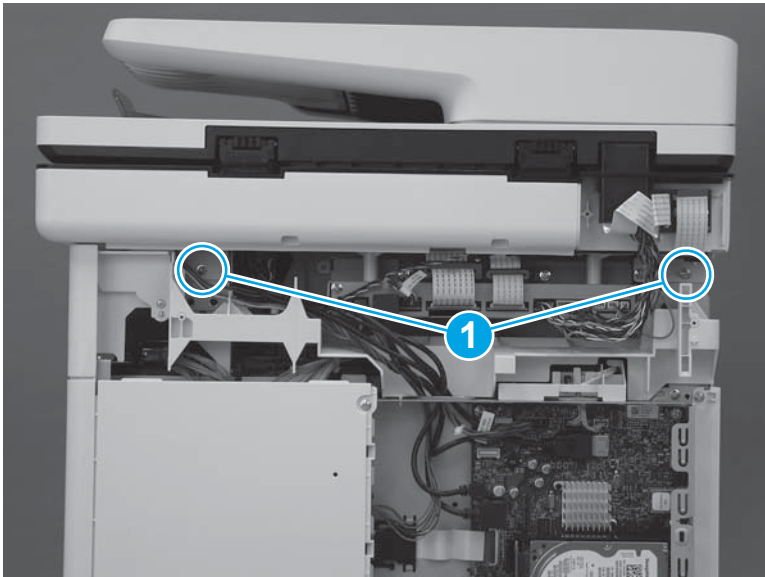

3. At the right side of the printer, remove one screw (callout 1).

Figure 1-3651 Remove one screw

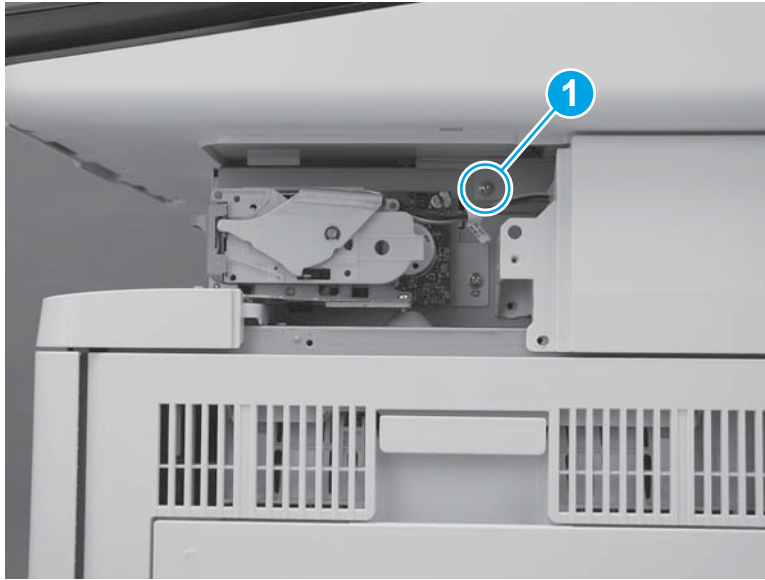

4. Disconnect two connectors on the scanner control board (callout 1).

M577c/f/z only: Disconnect one connector for the stapler on the scanner control board (callout 2).

Figure 1-3652 Disconnect connectors

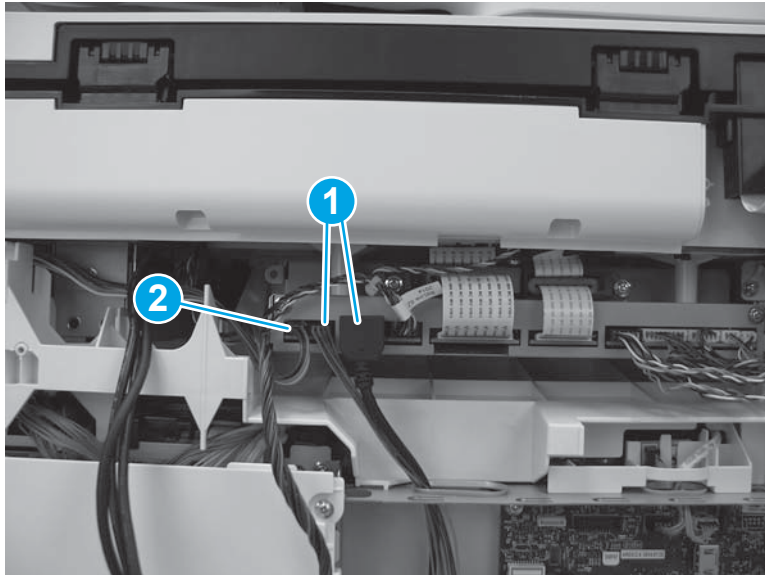

5. Slightly slide the ISA towards the back of the printer to release it.

Figure 1-3653 Slide the ISA towards the back of the printer

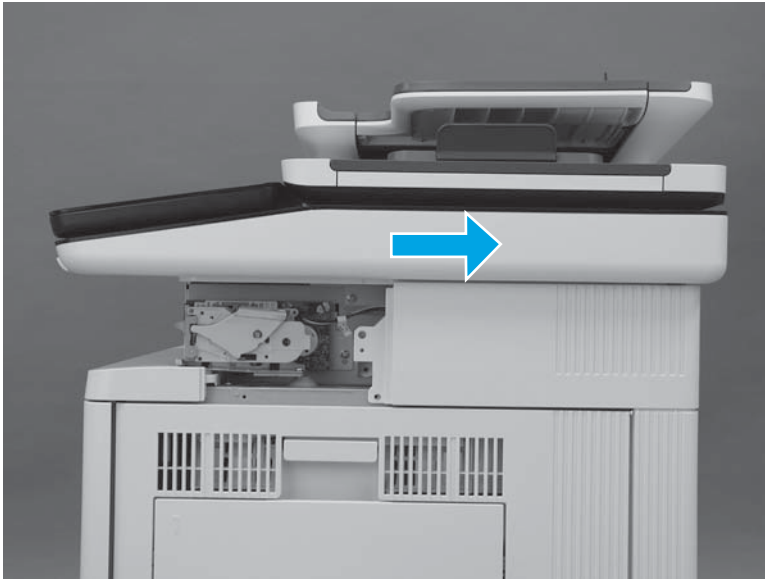

6. Lift the ISA up to remove it.



 **NOTE:** When lifting the ISA, carefully pass the cables through the opening in the top of the formatter case.

Figure 1-3654 Remove the ISA

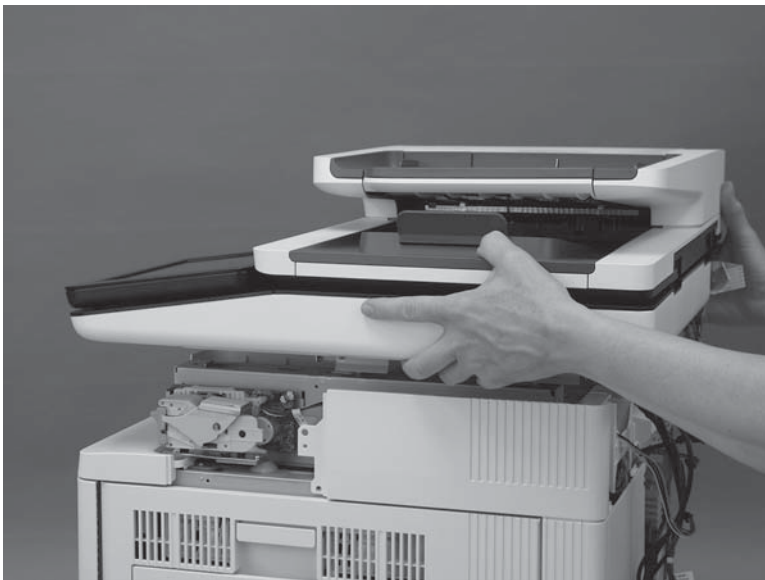

Step 16: Remove the right upper cover (M577)

 **NOTE:** This step is for the M577 models. For the M552 and M553 models, skip this step and go to [Step 17: Remove the left cover on page 2052.](#)

 **NOTE:** The figures below show the image scanner installed. The procedures for removing and installing the right upper cover are the same whether the image scanner is installed or removed."

1. At the right side of the printer, remove two screws (callout 1).

M577c/f/z only: Disconnect one connector (callout 2), if it was not already disconnected in a previous step.

Figure 1-3655 Remove two screws and one connector

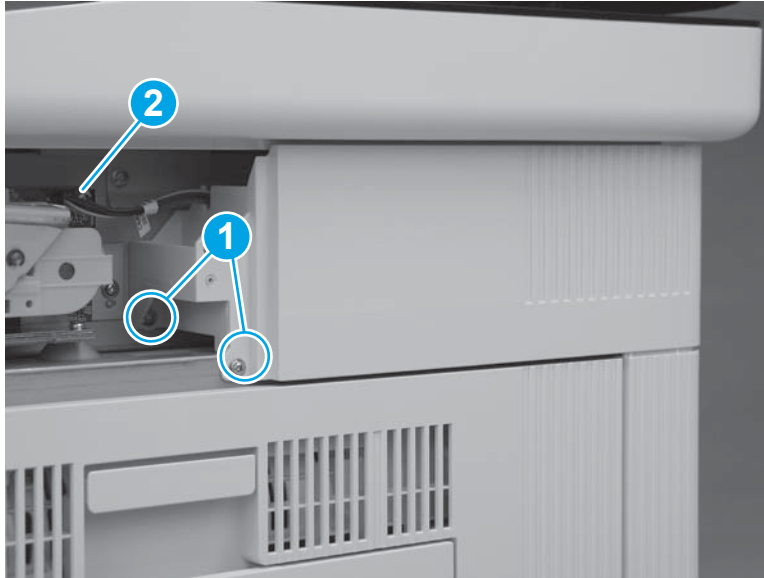

2. At the back of the printer, remove one screw (callout 1).

M577c/f/z only: Disconnect one connector (callout 2), if it was not already disconnected in a previous step.

 **Reinstallation tip:** This screw is smaller than the screws removed in the previous step. When reinstalling the right upper cover, make sure that this screw is installed in the correct position.

Figure 1-3656 Remove one screw and connector



3. Slide the cover toward the back of the printer.

Figure 1-3657 Slide the cover

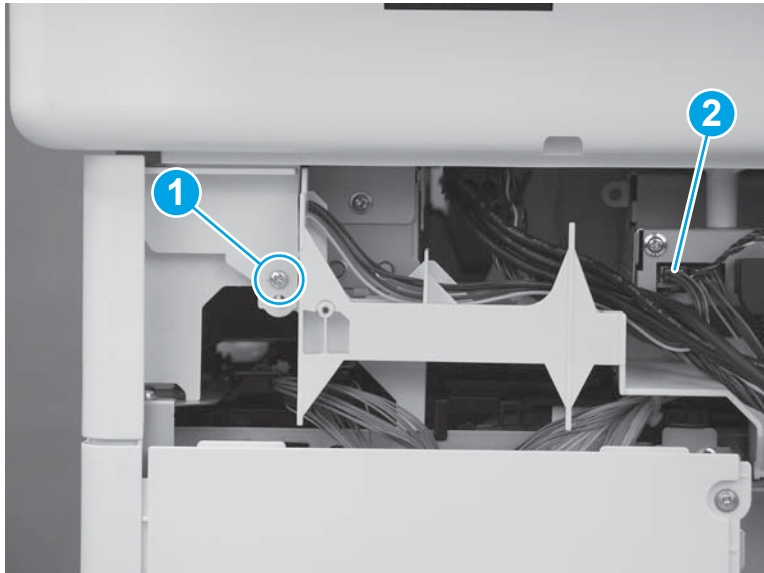
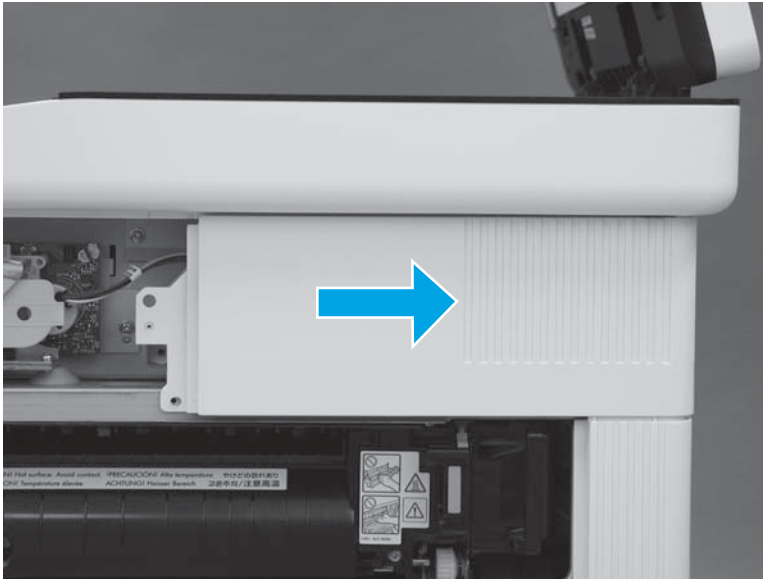

4. Lift the cover away from the printer to remove it.

M577c/f/z only: Release the cables (callout 1) through the slot (callout 2) in the printer.

Figure 1-3658 Remove the cover

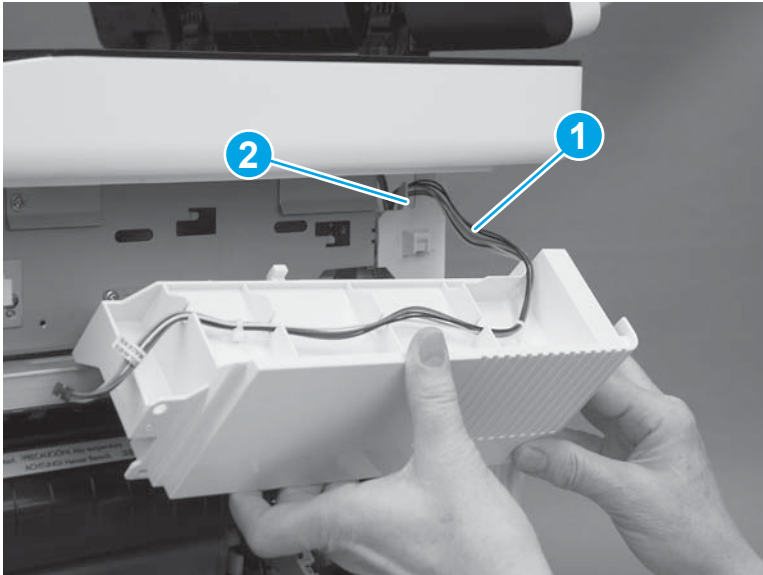

Step 17: Remove the left cover

1. At the left side of the printer, remove one screw (callout 1).

Figure 1-3659 Remove one screw



2. Release one tab (callout 1), rotate the front edge of the cover away from the printer (callout 2), and then slide the cover (callout 3) toward the rear of the printer to release it.

Figure 1-3660 Release the cover

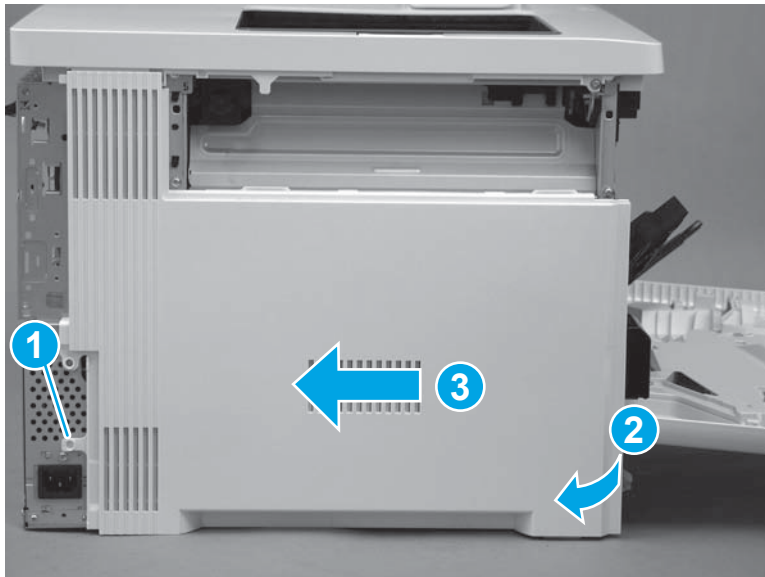

3. Remove the cover.

Figure 1-3661 Remove the cover

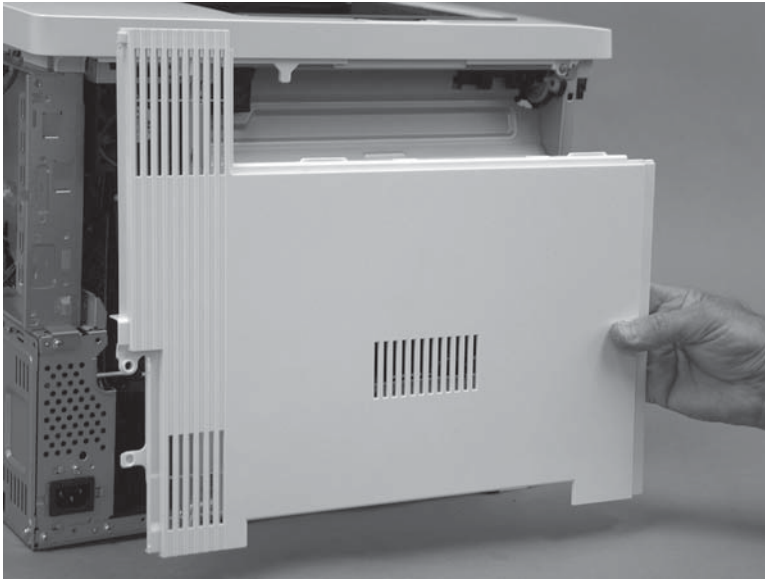

Step 18: Remove the upper cover (M552 and M553)



NOTE: This step is for the M552 and M553 models. For the M577 models, skip this step and go to [Step 19: Remove the right rear cover on page 2056](#).

1. Remove three screws (callout 1).

Figure 1-3662 Remove three screws

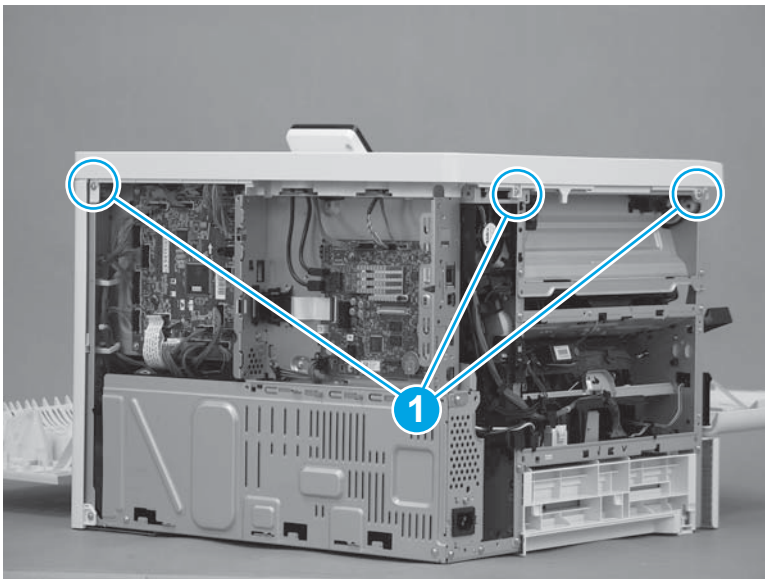

2. Remove one screw (callout 1), release one tab (callout 2), and then slightly separate the corner of the cover from the chassis.

 **NOTE:** This is a self-tapping plastic-thread screw. Make sure that this screw is used in this location when it is reinstalled.

Figure 1-3663 Remove one screw and release one tab



3. Release one tab (callout 1), and then lift up on the cover to release it.

 **NOTE:** If the cover does not release, check for additional tabs by locating the triangles embossed in the cover at tab locations.

Figure 1-3664 Release the cover



4. Remove the cover.

Figure 1-3665 Remove the cover

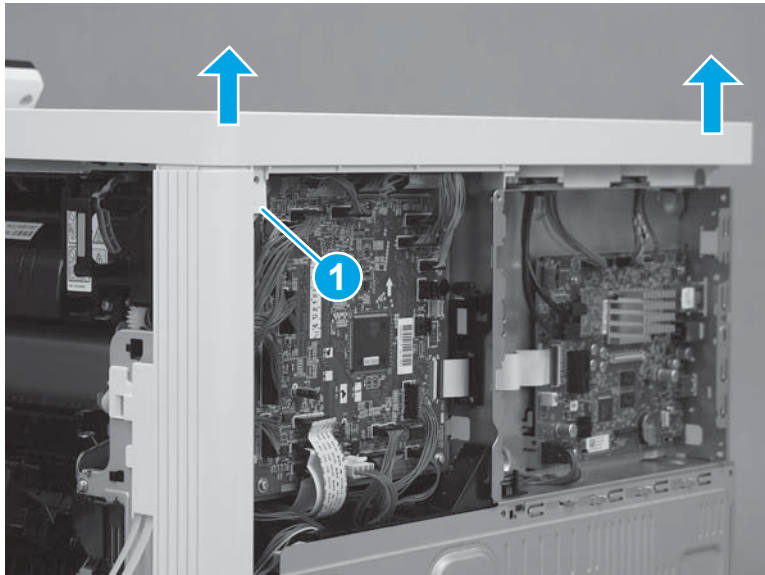
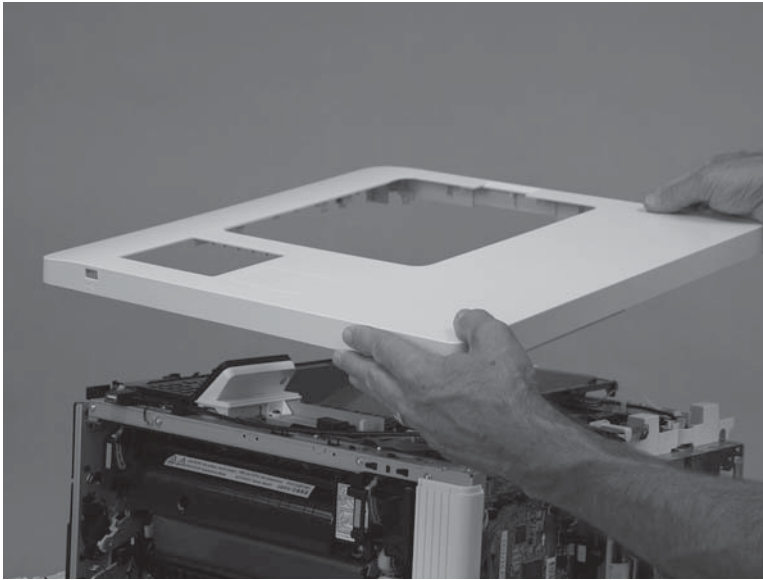

Step 19: Remove the right rear cover

1. Remove one screw (callout 1), and then slide the cover toward the rear of the printer (callout 2) to release it.

 **TIP:** If the right door is closed, open it now.

Figure 1-3666 Release the cover

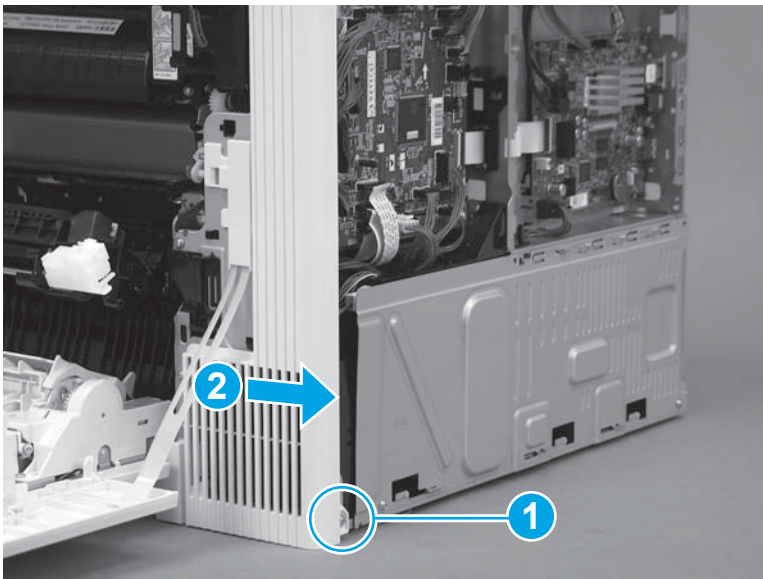

2. Remove the cover.

Figure 1-3667 Remove the cover

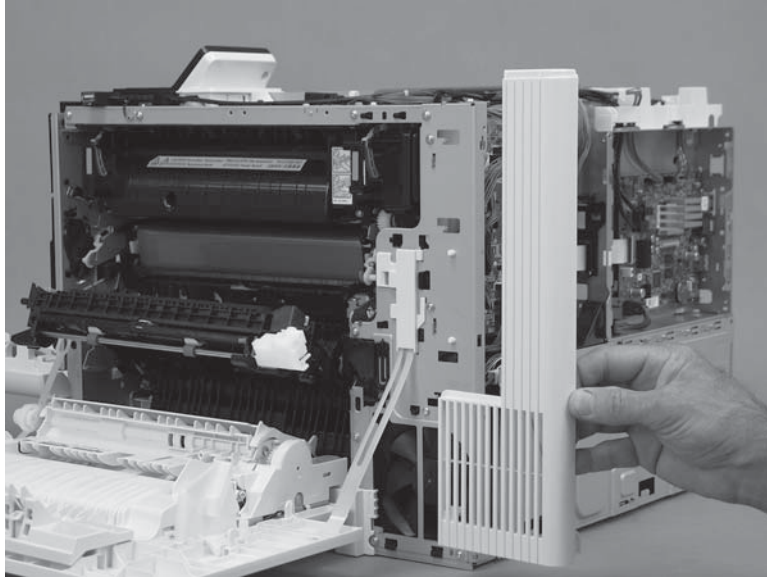

Step 20: Remove the formatter case

1. **M577 only:** Disconnect one connector (callout 1), and then pass the wire harness (callout 2) through two openings in the formatter case (callout 3).

Figure 1-3668 Disconnect one connector

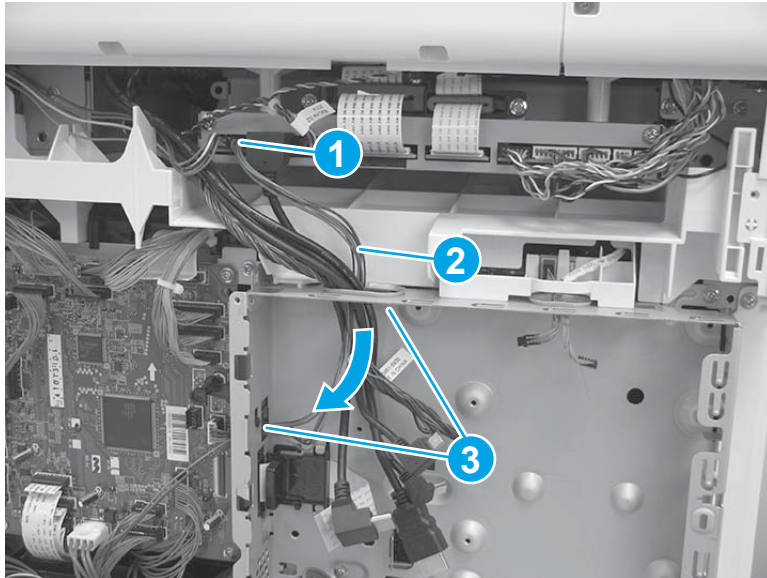

2. Release two tabs (callout 1) on the black plastic bracket. Hold the tabs in the released position, and then slide the bracket (callout 2) to the right to remove it from the formatter case.

Figure 1-3669 Remove the bracket

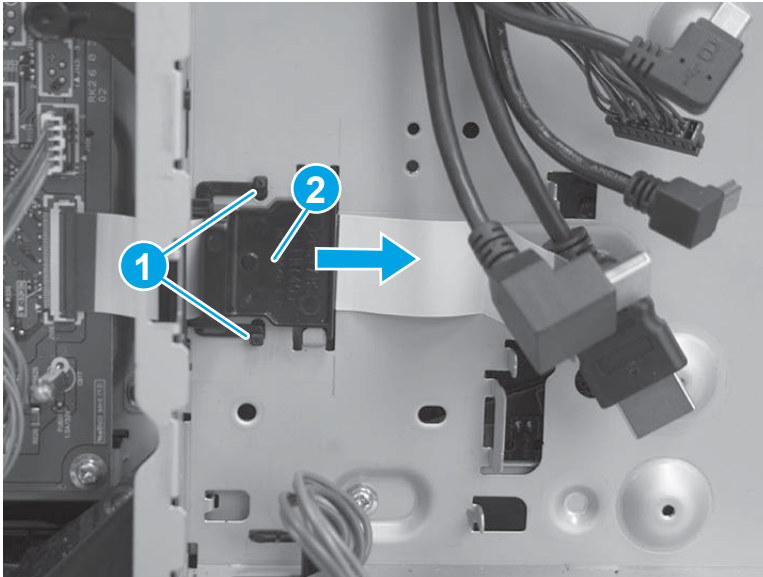

3. Remove two screws (callout 1), and then slide the low-voltage power supply (LVPS) cover to the right to remove it.

Figure 1-3670 Remove the LVPS cover

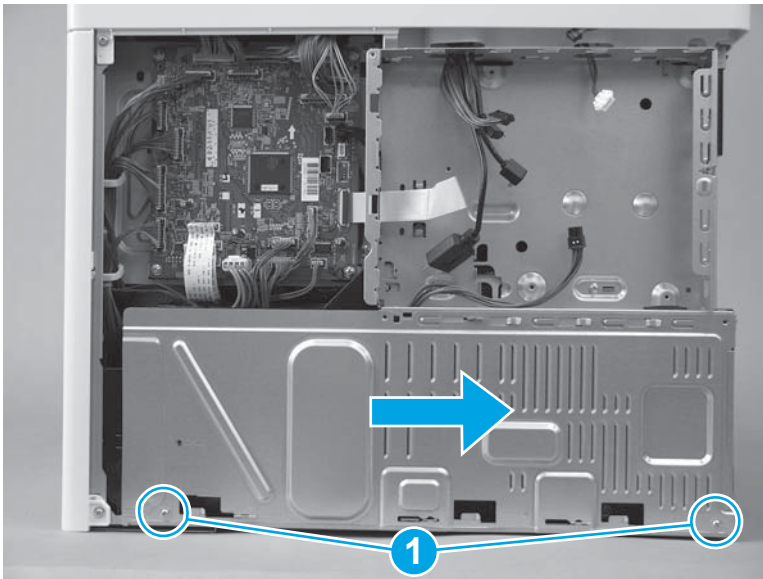

4. Pass two wire harnesses and one flat cable (callout 1) through the opening in the formatter case, and then release one wire harness from the retainer (callout 2).

CAUTION: The flat cable might be attached to the formatter case with double-sided tape. Make sure that this tape is released, so that the flat cable is not damaged when the formatter case is removed.

Figure 1-3671 Release wire harnesses and flat cable

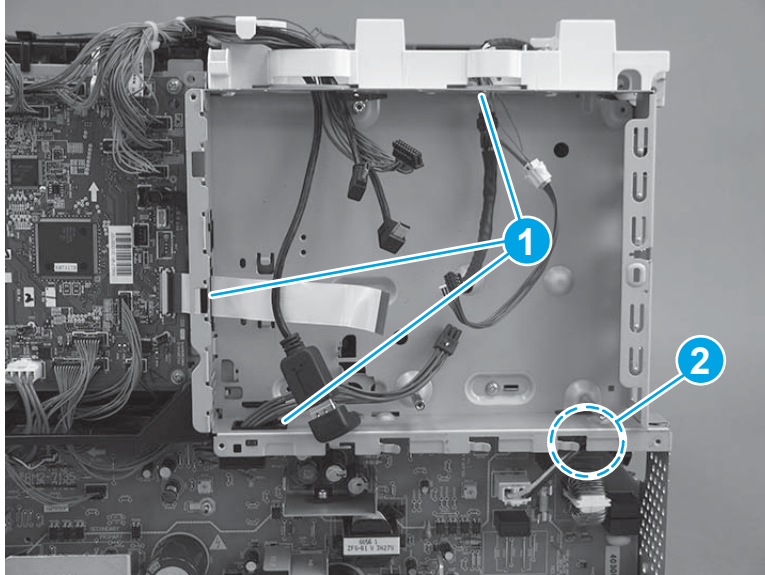

5. Remove six screws (callout 1).

Figure 1-3672 Remove six screws

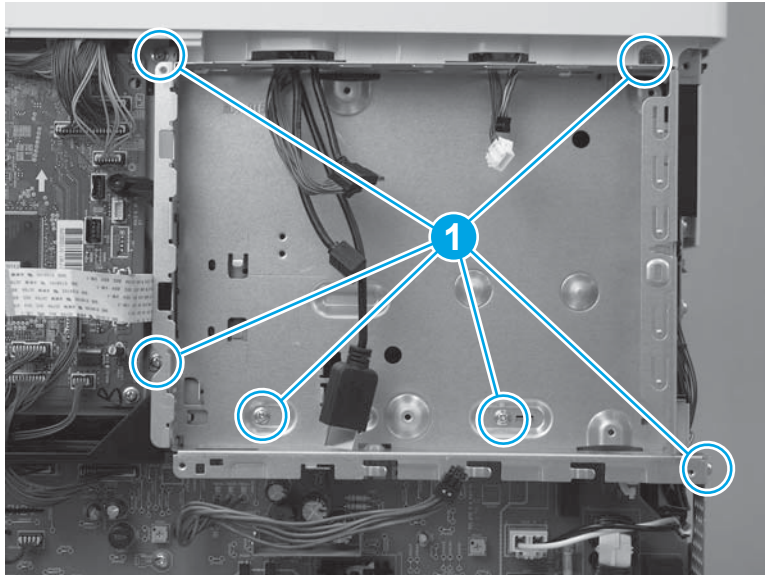

6. Rotate the bottom of the formatter case away from the printer (callout 1), and then pull it down (callout 2) to release it.

Figure 1-3673 Release the formatter case

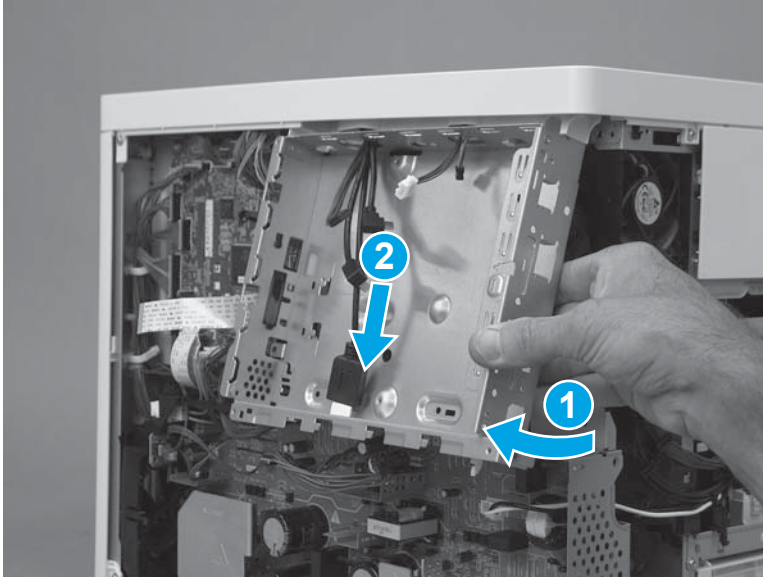

7. Pass the wire harnesses through the opening in the formatter case to remove it.

 **IMPORTANT:** If the formatter case is removed so that it can be replaced, make sure to transfer the memory PCA (island of data) and plastic bracket (callout 1) to the replacement case.

Figure 1-3674 Remove the formatter case



Step 21: Remove the low-voltage power supply (LVPS)

 **CAUTION:**  ESD-sensitive part.

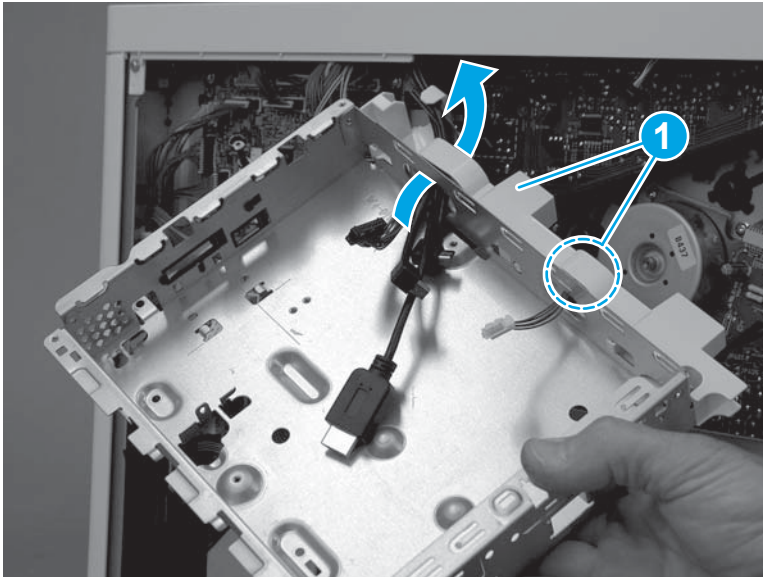
1. Disconnect one wire harness (callout 1), and then pass the wire harness through the opening (callout 2) in the chassis.

Figure 1-3675 Disconnect one wire harness

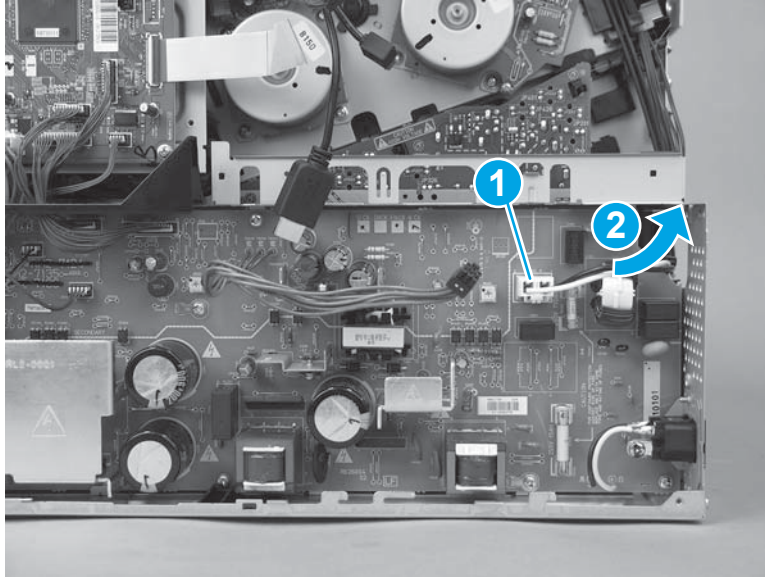

2. Disconnect three connectors on the DC controller (callout 1), and then disconnect four connectors (callout 2) on the LVPS.

Figure 1-3676 Disconnect seven connectors

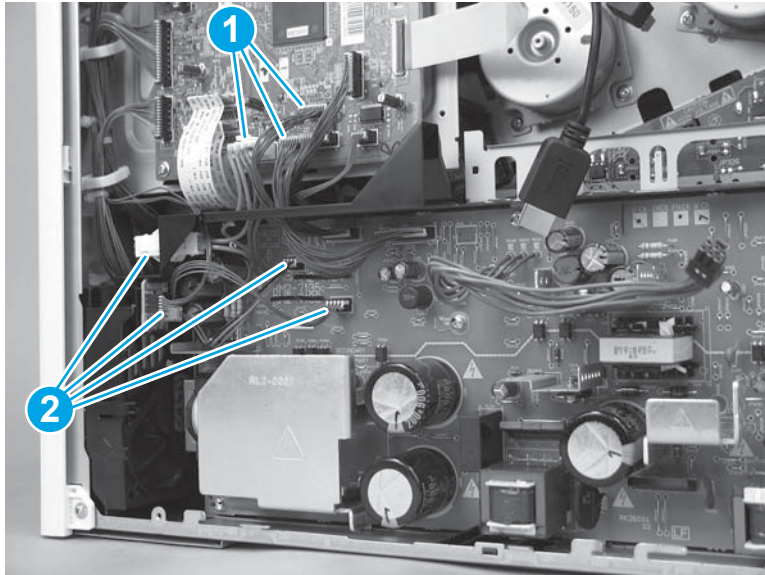

5. Rotate the top of the LVPS away from the printer (callout 1), and then slide it up and out (callout 2) of the printer to remove it.

Figure 1-3679 Remove the LVPS

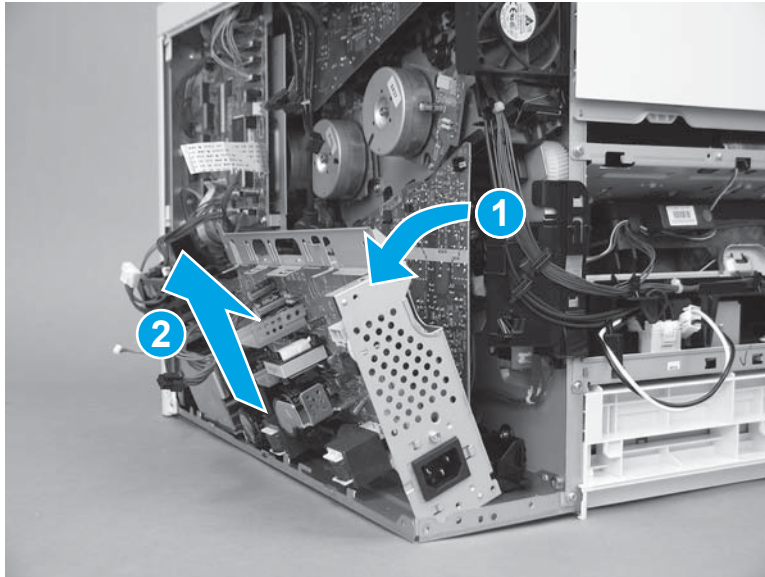

Step 22: Remove the power supply fan (FM1)

1. Remove one screw (callout 1).

Figure 1-3680 Remove one screw

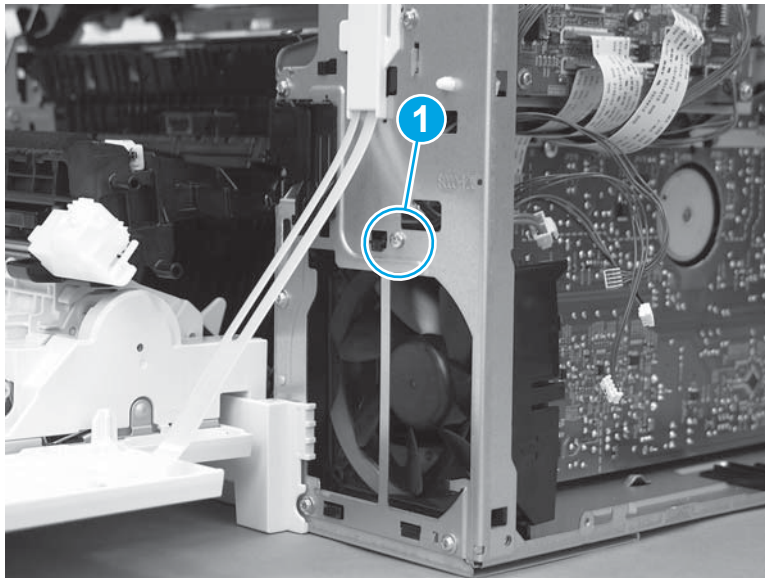

2. Release the wire harnesses from the retainer on the top of the fan bracket.

Figure 1-3681 Release the wire harnesses

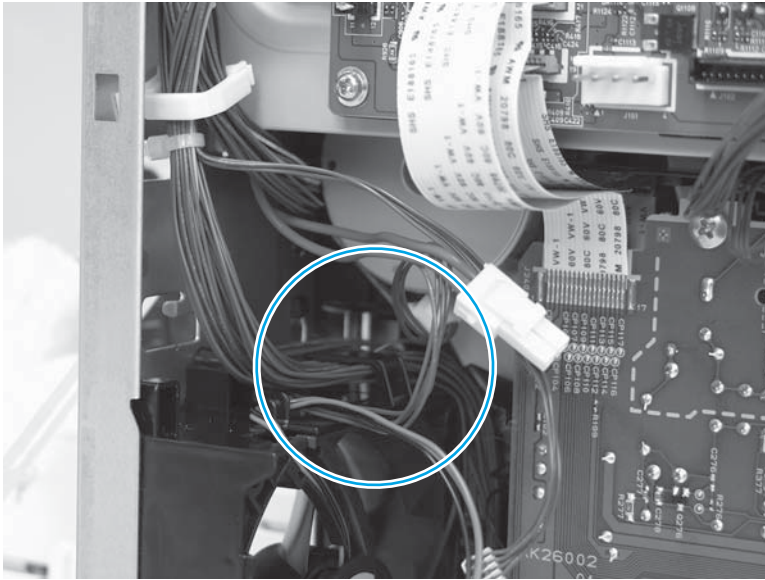

3. Lift the fan up (callout 1), and then slide it out of the printer (callout 2) to remove it.

Figure 1-3682 Remove the fan

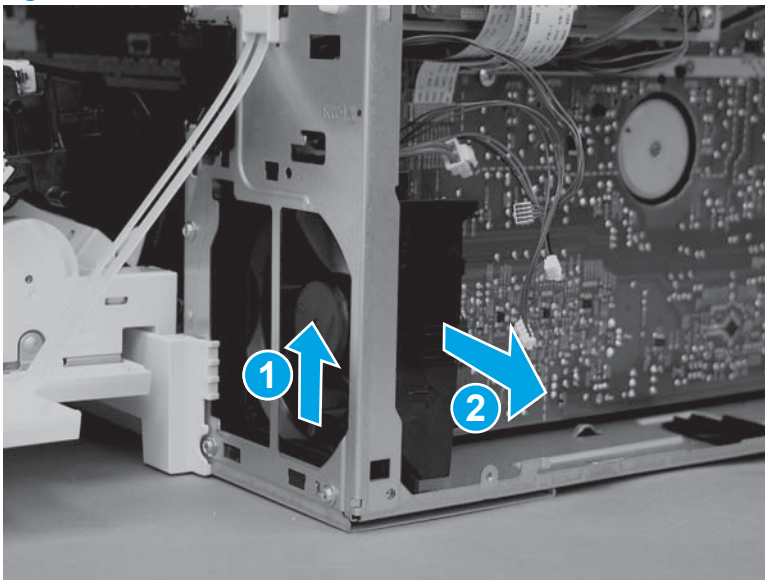

Step 23: Remove the high-voltage power supply D (HVPSD)

 **CAUTION:**  ESD-sensitive part.

1. Disconnect one flat cable (callout 1) on the DC controller.

Figure 1-3683 Disconnect one flat cable

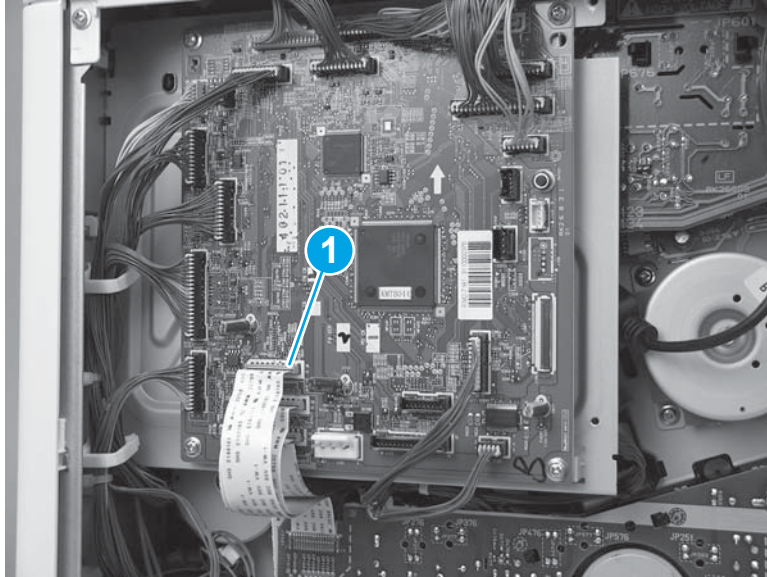

2. Remove two screws (callout 1), and then remove one self tapping screw (callout 2) on the HVPSD.

Figure 1-3684 Remove three screws

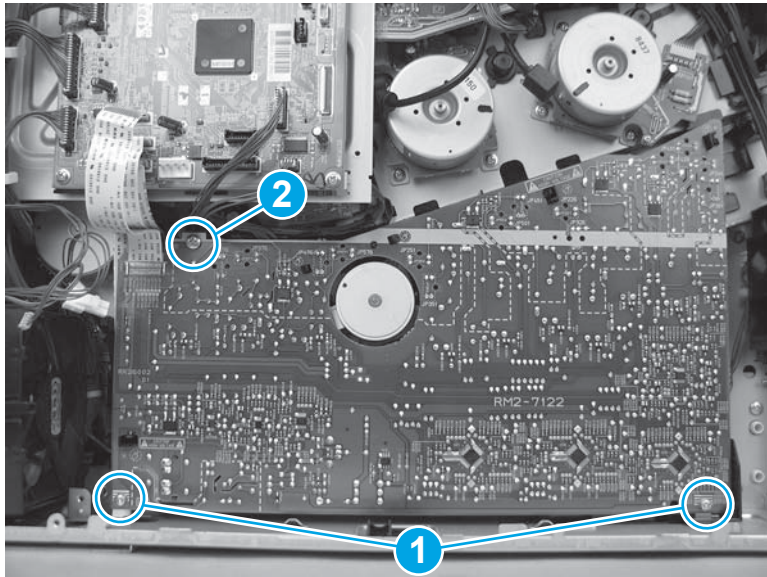

3. Release five tabs (callout 1), and then remove the HVPSD (callout 2).

Figure 1-3685 Remove the HVPSD

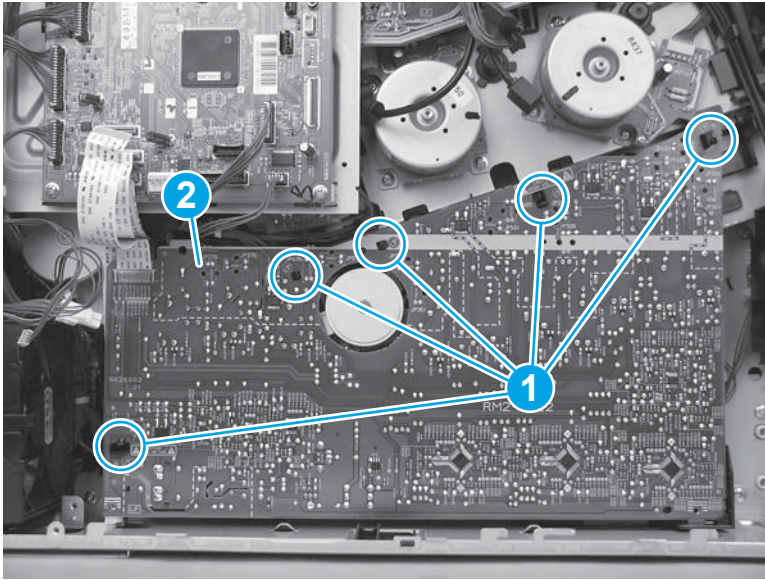

Step 24: Remove the lifter drive assembly

1. Disconnect two connectors (callout 1).

Figure 1-3686 Disconnect two connectors

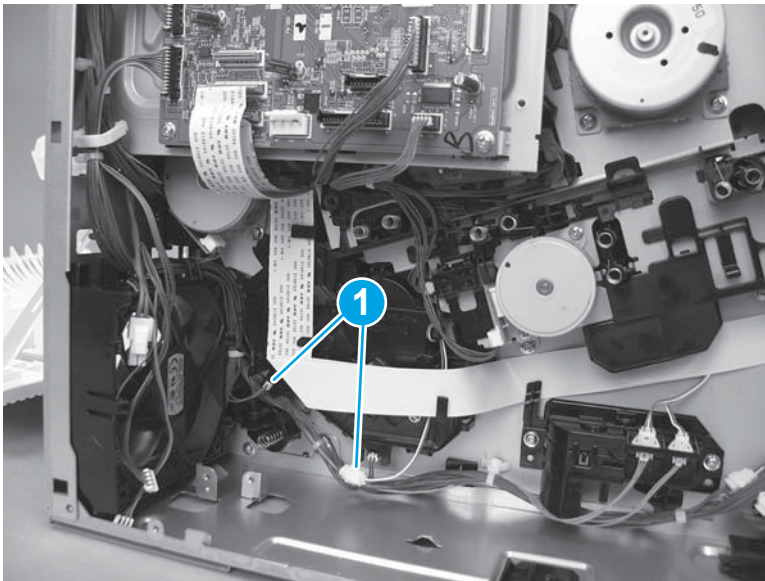

2. Disconnect two flat cables (callout 1), and then release them from the retainers (callout 2).

Figure 1-3687 Disconnect two flat cables

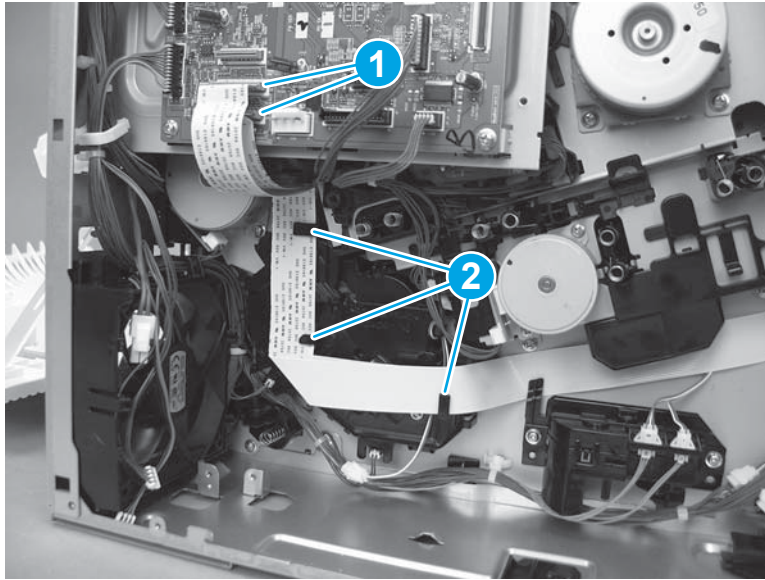

3. Remove two screws (callout 1), release one tab (callout 2), and then remove the lifter drive assembly (callout 3).

 **NOTE:** Release one wire harness from the retainer (callout 4) as the assembly is removed.

Figure 1-3688 Remove the assembly



Step 25: Remove the DC controller and sheet-metal bracket

 **CAUTION:**  ESD sensitive part.

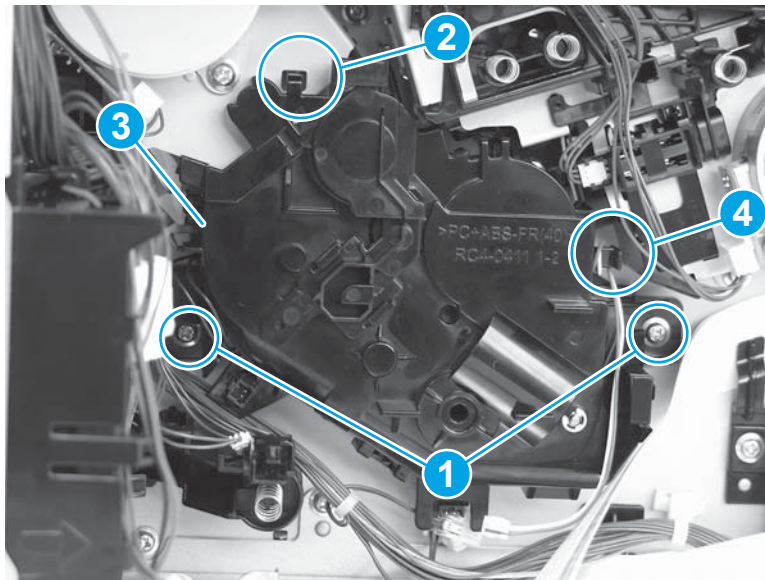
1. Disconnect all of the connectors, and then remove two screws (callout 1).

The following connectors are empty:

- J140, J141, and J143

Figure 1-3689 Remove two screws

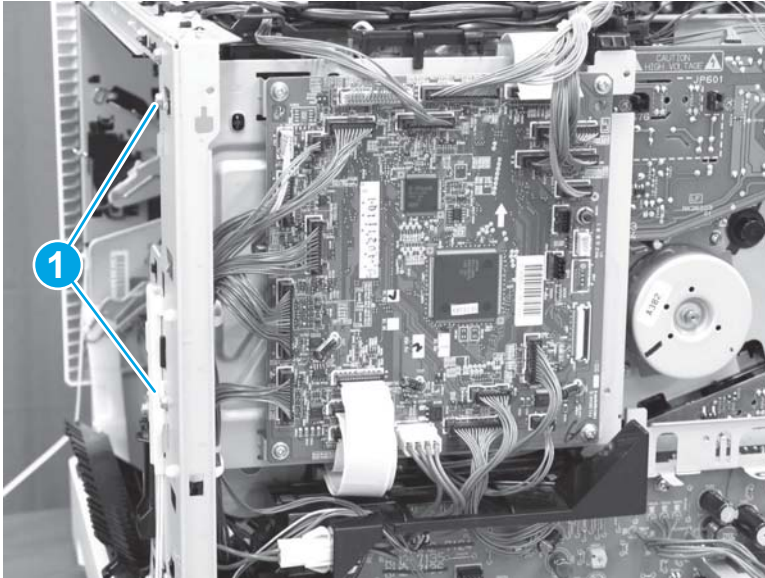

2. Lift up on the DC controller and sheet-metal plate to remove it.

Figure 1-3690 Remove the plate

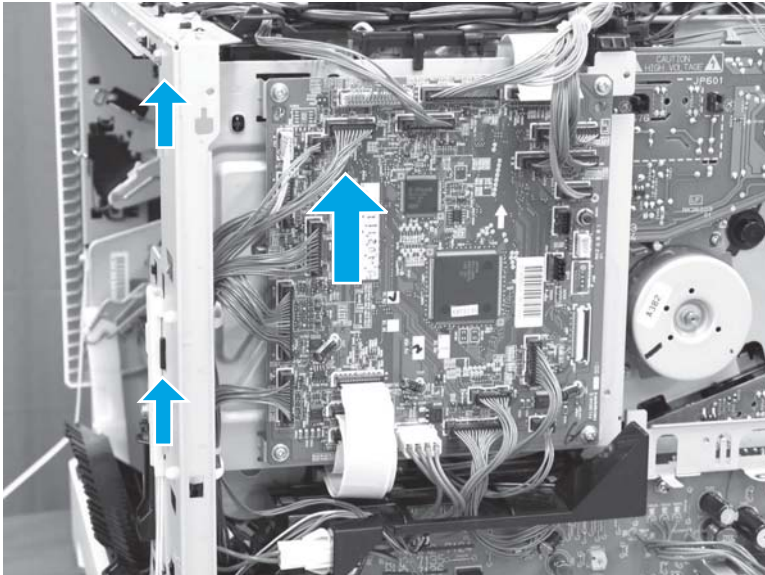

Step 26: Remove the pickup drive assembly and motor (M5)

1. Release one tab (callout 1), and then move the guide (callout 2) out of the way.

Figure 1-3691 Move the guide out of the way

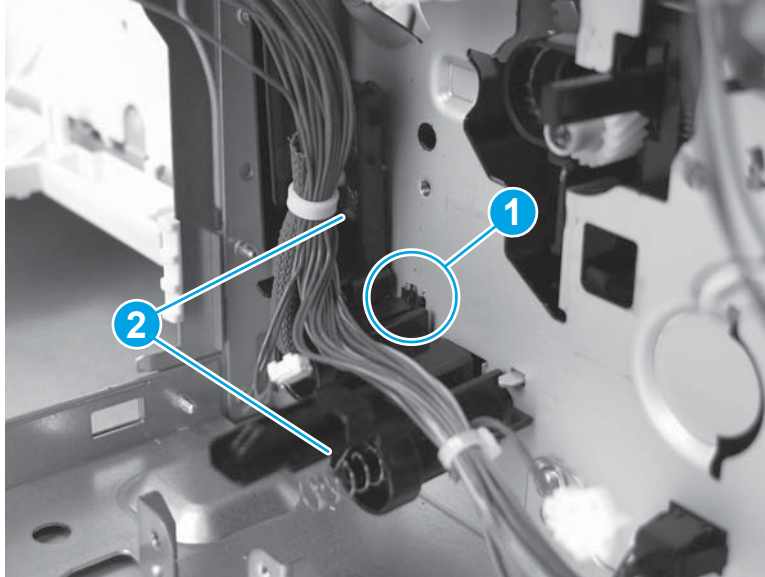

2. Remove three screws (callout 1).

Figure 1-3692 Remove three screws

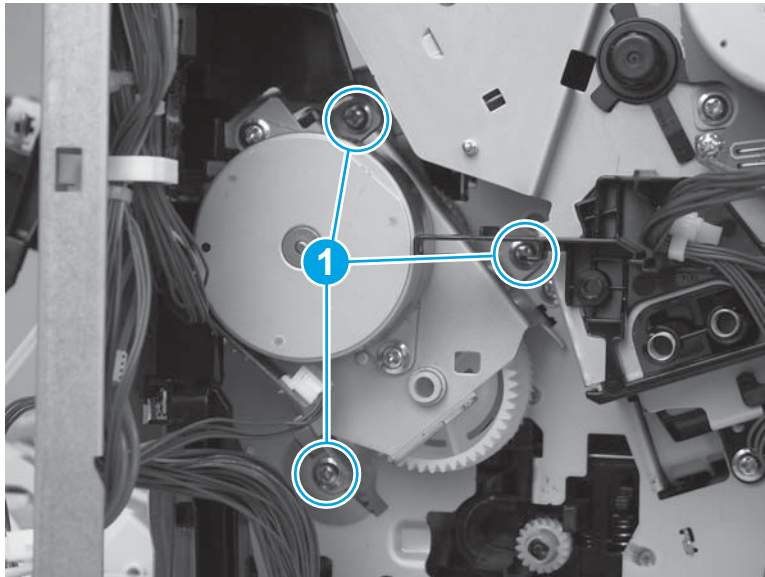

3. Remove the assembly.

CAUTION: One gear on the back side of the assembly is not captive. Handle the assembly carefully.

Figure 1-3693 Remove the assembly

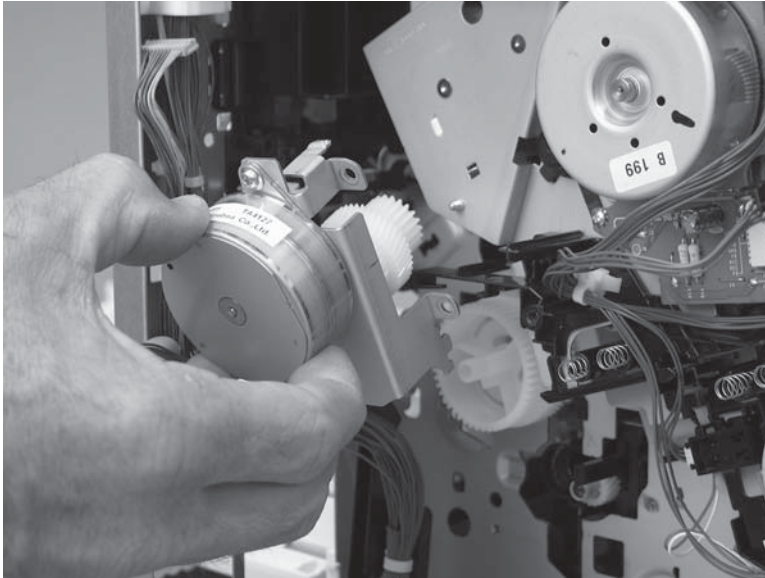

4. If the gear (callout 1) was not removed with the assembly in the previous step, remove it now.

Figure 1-3694 Remove the gear if installed

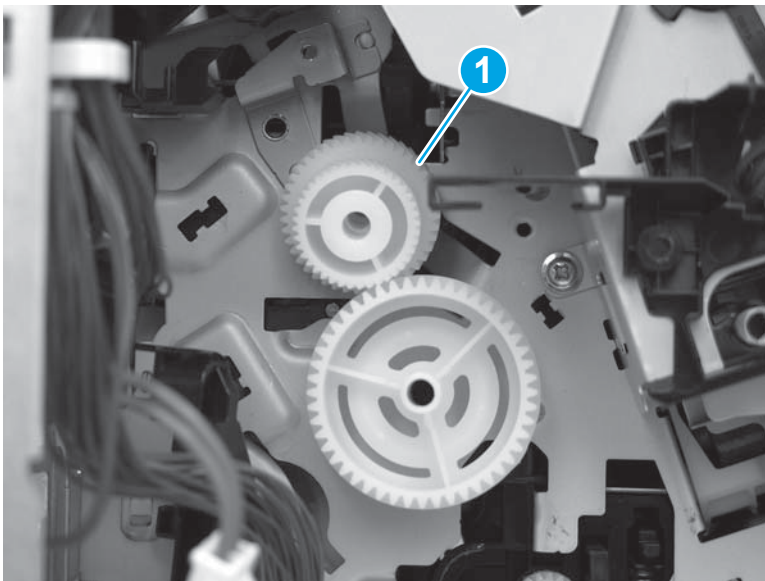

Step 27: Unpack the replacement assembly

Unpack the replacement assembly from the packaging.

For complete information on HP's recycling programs, go to [Product return and recycling](#).

CAUTION: One gear (callout 1) on the back side of the assembly is not captive. Handle the assembly carefully.

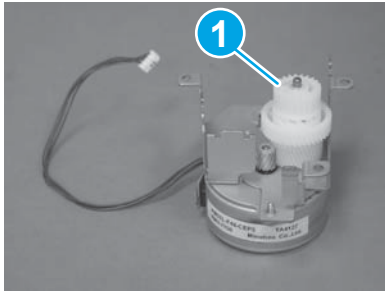

NOTE: HP recommends responsible disposal of the defective assembly.

Figure 1-3695 Recycle and unpack

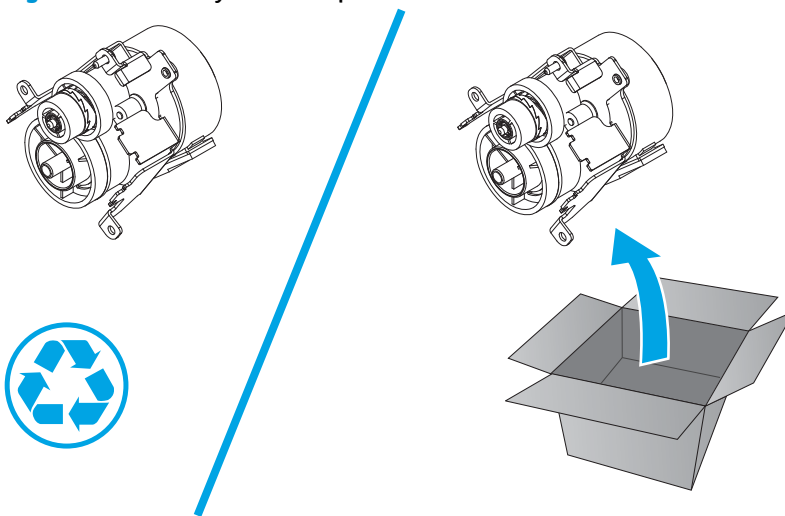

Step 28: Install the pickup drive assembly and motor (M5)

1. Before installing the assembly, check to see if a gap exists (callout 1) between the gears.

NOTE: If no gap exists, go to step [3](#) in this section.

Figure 1-3696 Check the gears for a gap

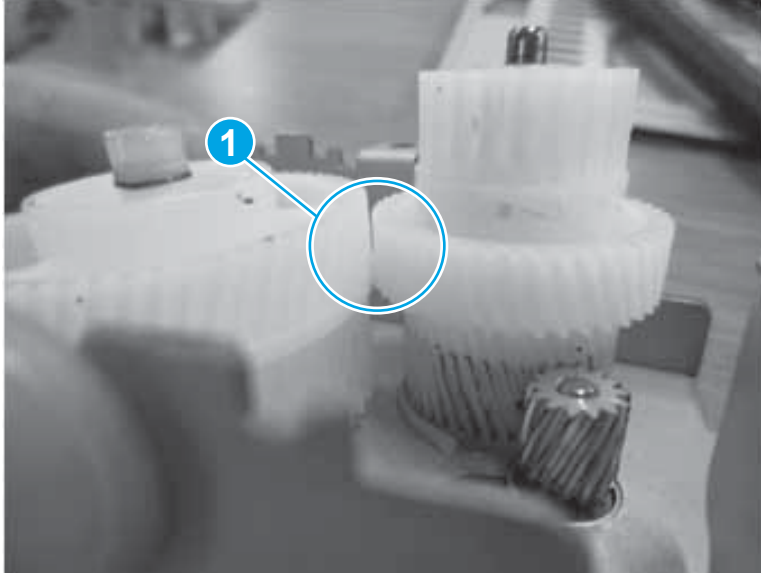

2. Adjust the gears on the assembly to remove the gap (callout 1).

Figure 1-3697 Adjust the gears

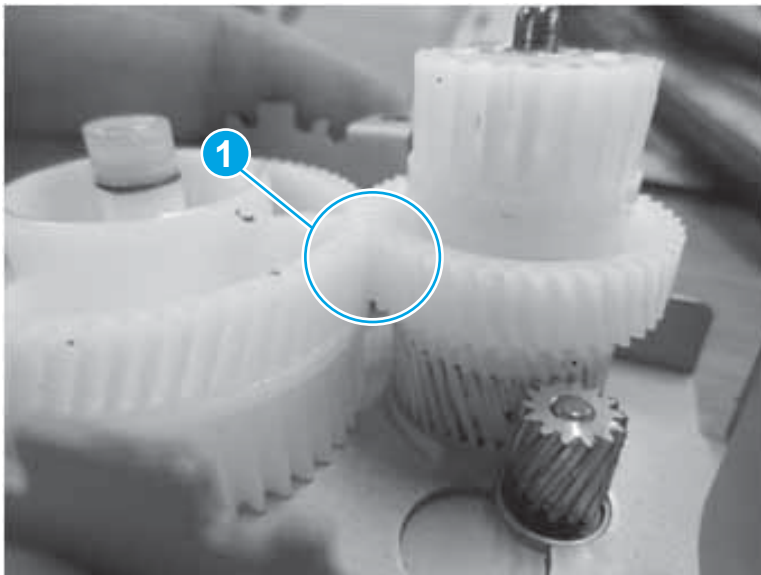

3. Align the tabs on the pickup drive assembly with the slots in the chassis, and then install the assembly on the printer.

 **IMPORTANT:** The figure below shows the large gear of the assembly already installed on the printer chassis. However it is easier to install the pickup drive assembly if the gear is installed on the assembly.

 **TIP:** With the right door open, look into the printer and verify that the mounting bracket for the assembly is correctly installed against the chassis.

Figure 1-3698 Install the assembly



4. Install three screws (callout 1).

Figure 1-3699 Install three screws

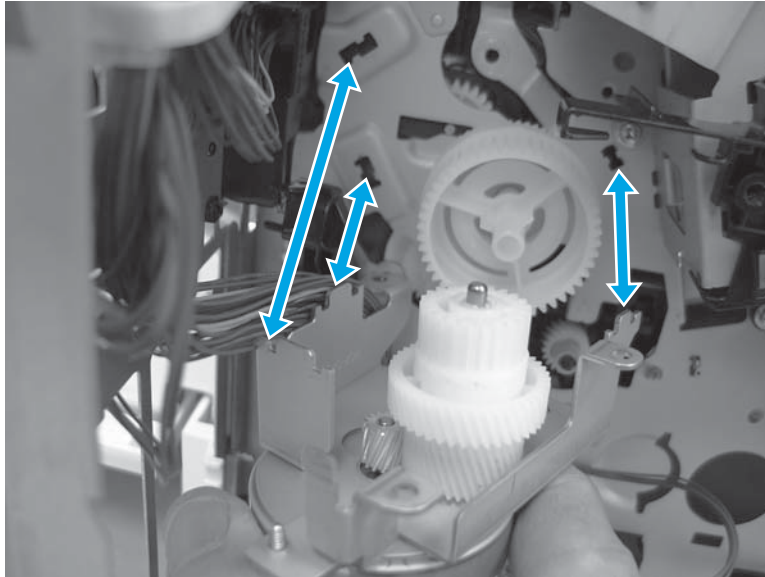
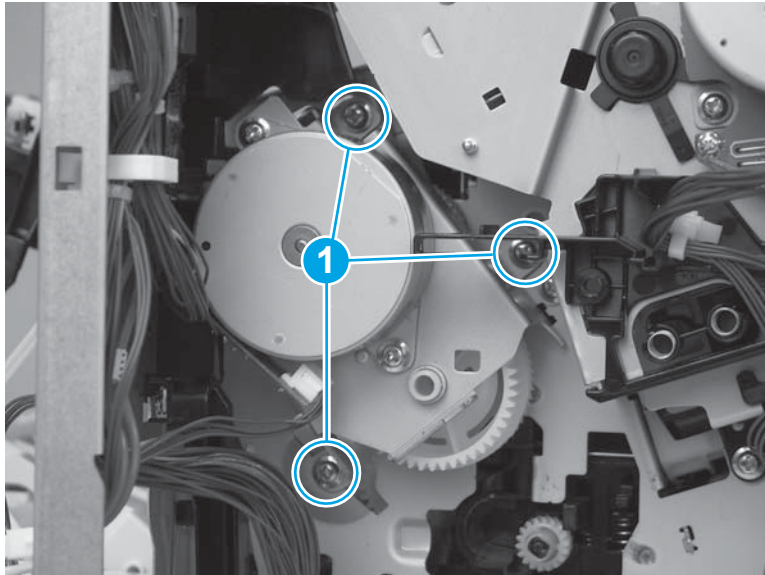

5. Install the guide (callout 1). Make sure that the tab (callout 2) snaps into place.

Figure 1-3700 Install the guide

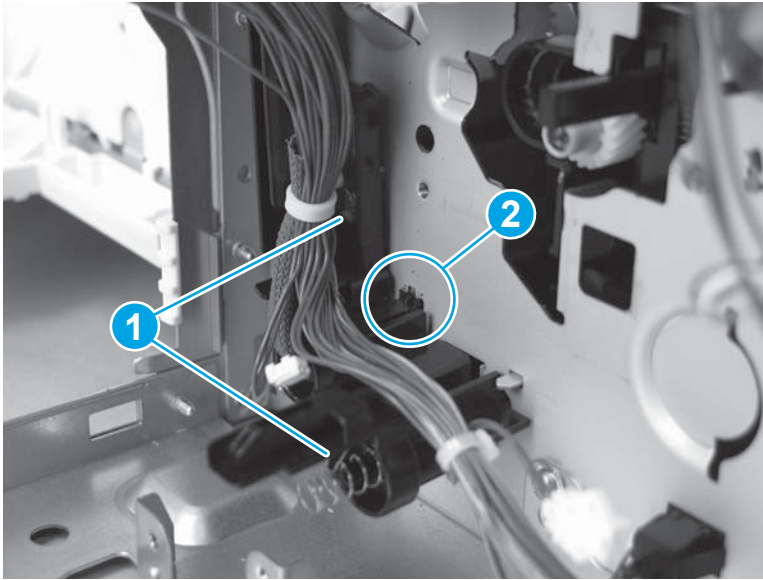

Step 29: Install the DC controller and sheet-metal bracket

 **CAUTION:**  ESD-sensitive part.

1. Position the DC controller and sheet-metal plate on the printer, and then push down to engage the plate with the chassis.

Figure 1-3701 Install the plate

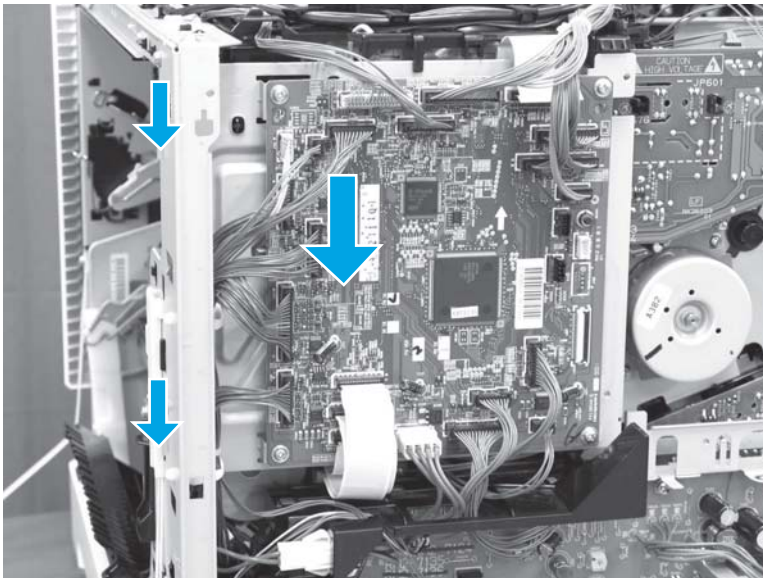

2. Install two screws (callout 1), and then connect all of the connectors.

The following connectors are empty:

- J140, J141, and J143

Figure 1-3702 Install two screws

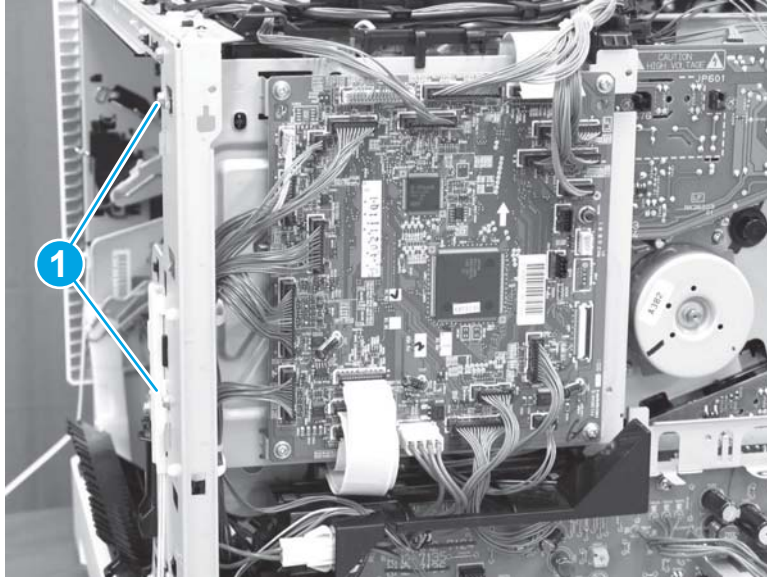

Step 30: Install the lifter drive assembly

1. Install one wire harness on the retainer (callout 1), position the lifter drive assembly in the printer (make sure that one tab (callout 2) snaps into place), and then install two screws (callout 3).

 **TIP:** It might be easier to install the assembly if the bottom of the assembly is installed first, and then the top of the assembly is rotated into place.

Figure 1-3703 Install the lifter drive



2. Connect two flat cables (callout 1), and then place them in the retainers (callout 2).

Figure 1-3704 Connect two flat cables

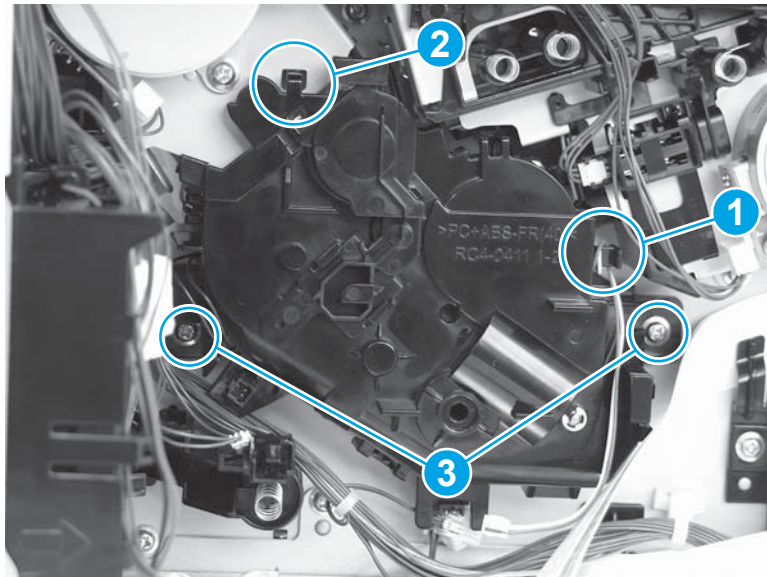
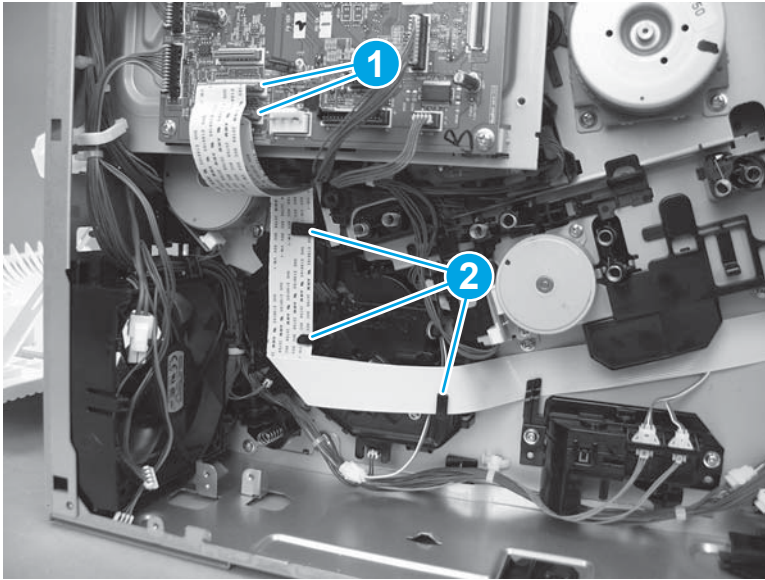

3. Connect two connectors (callout 1).

Figure 1-3705 Connect two connectors

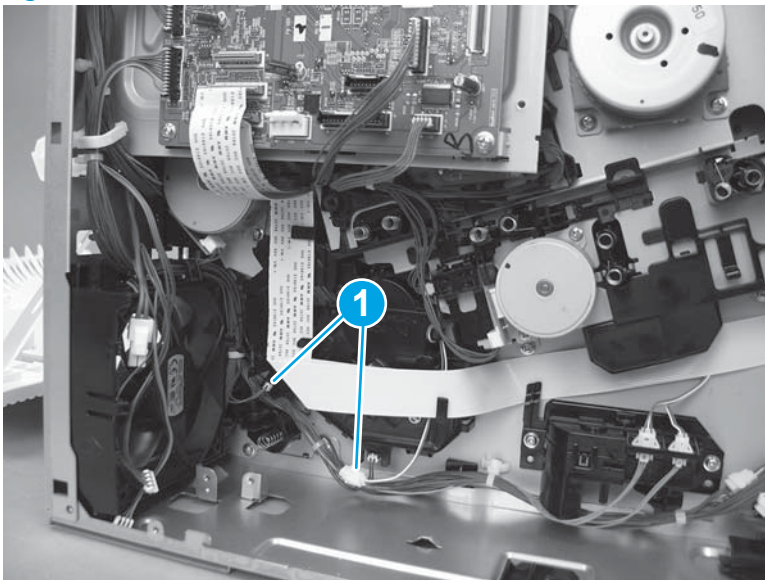

Step 31: Install the HVPSD

 **CAUTION:**  ESD-sensitive part.

1. Position the bottom right corner of the HVPSD (callout 1) behind the black tab, and then rotate it up and onto the printer (callout 2).

Figure 1-3706 Install the HVPSD

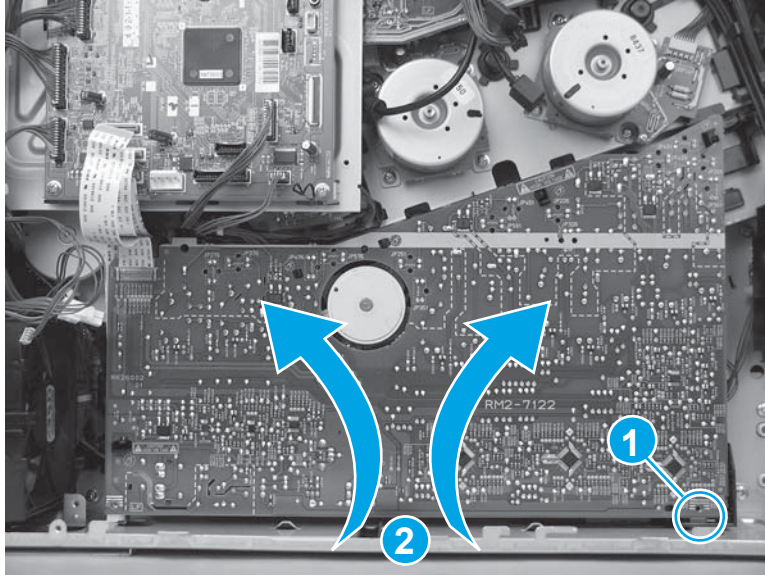

2. Press it onto five tabs (callout 2).

 **IMPORTANT:** Make sure that all five tabs snap into place.

Figure 1-3707 Press the tabs



3. Install two screws (callout 1), and then install one self tapping screw (callout 2) on the HVPSD.

Figure 1-3708 Install three screws

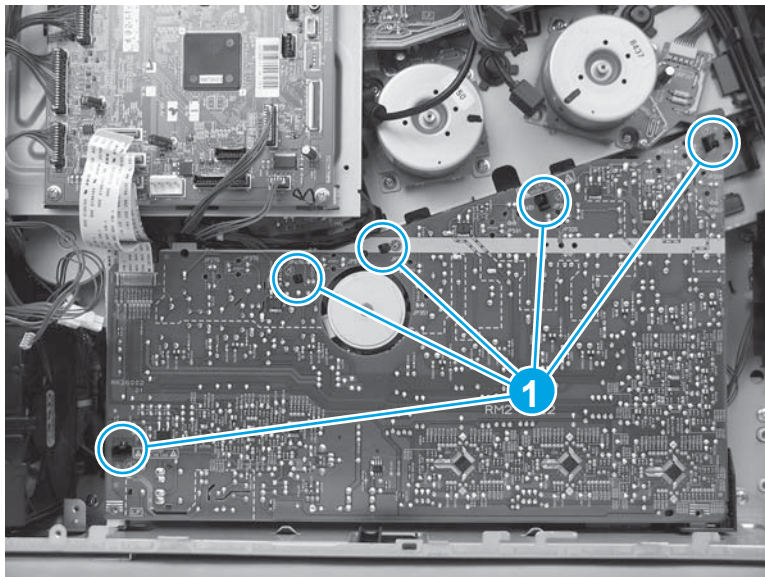
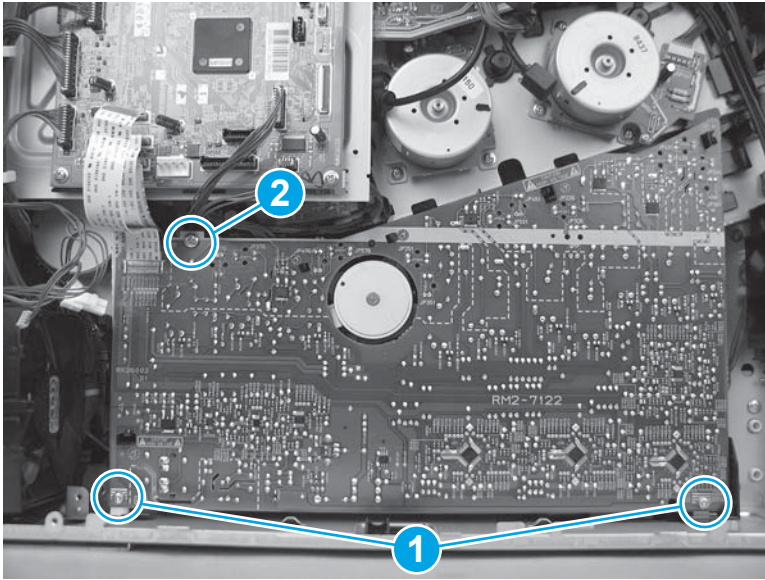

4. Connect one flat cable (callout 1) on the DC controller.

Figure 1-3709 Connect one flat cable

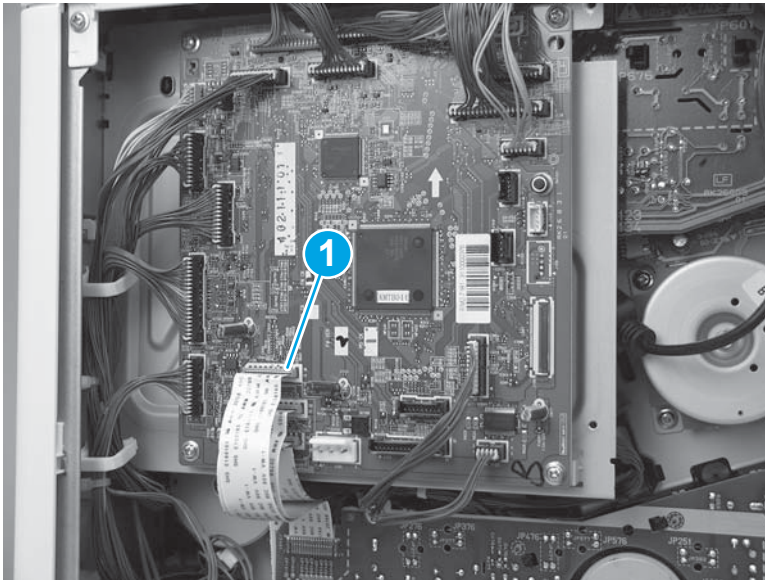

Step 32: Install the power-supply fan (FM1)

1. Slide the fan in (callout 1) and then down (callout 2) into the printer to install it.



NOTE: Make sure that the arrow (callout 3) embossed on the fan holder faces into the printer.

Figure 1-3710 Install the fan

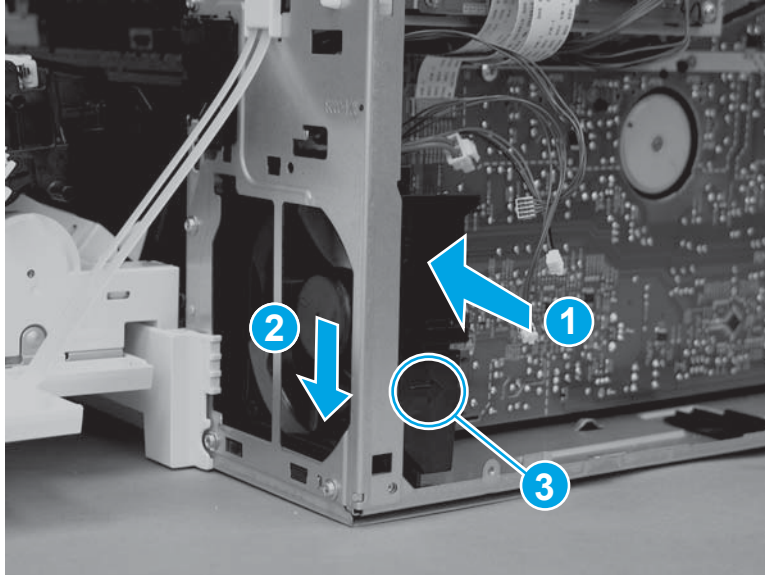

2. Place the wire harnesses in the retainer on the top of the fan bracket.

Figure 1-3711 Place the wire harnesses in the retainer

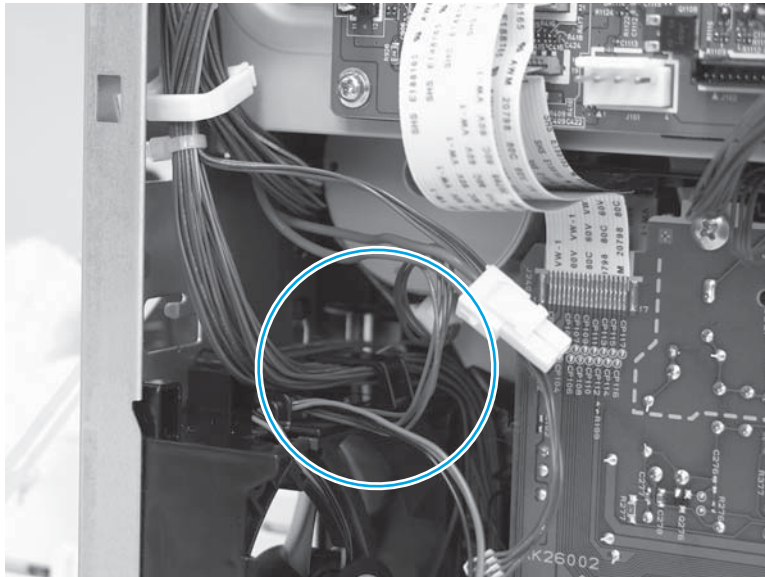

3. Install one screw (callout 1).

Figure 1-3712 Install one screw

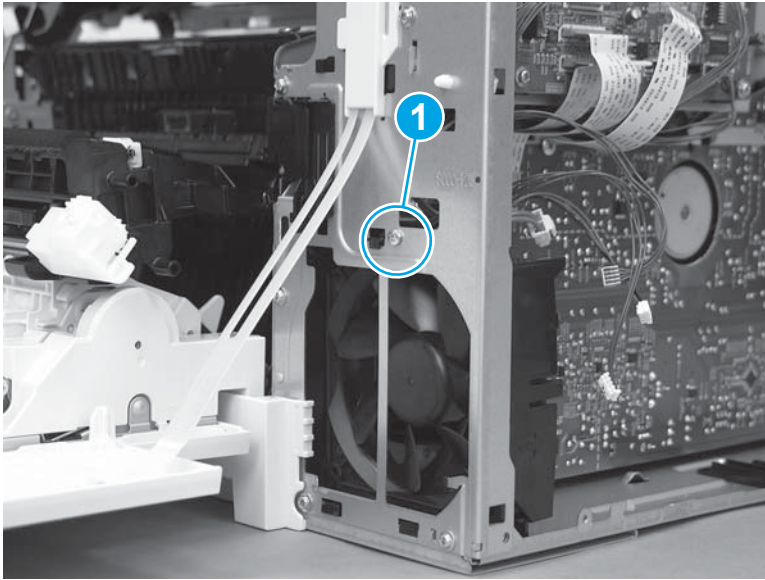

Step 33: Install the LVPS

 **CAUTION:**  ESD-sensitive part.

1. Position the bottom of the LVPS in the printer (callout 1) at a slight angle, and then rotate the top of it into the printer (callout 2) to install it.

Figure 1-3713 Install the LVPS

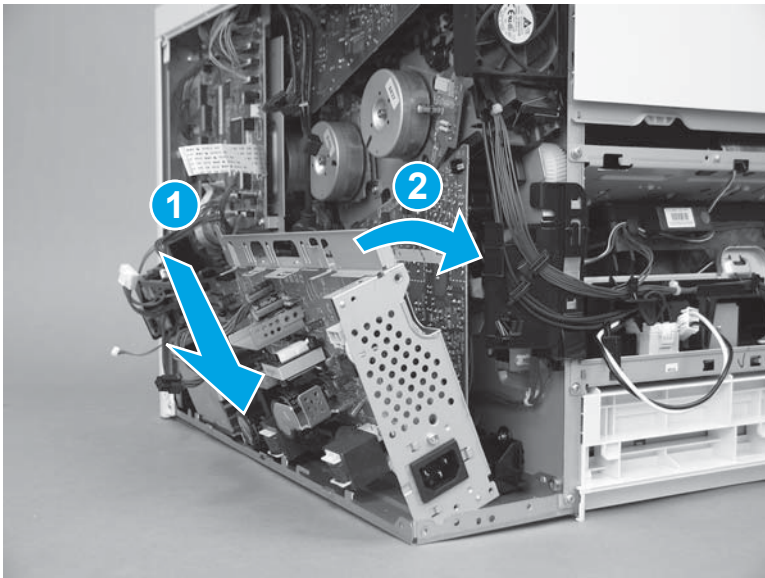

2. Install three screws (callout 1).

Figure 1-3714 Install three screws

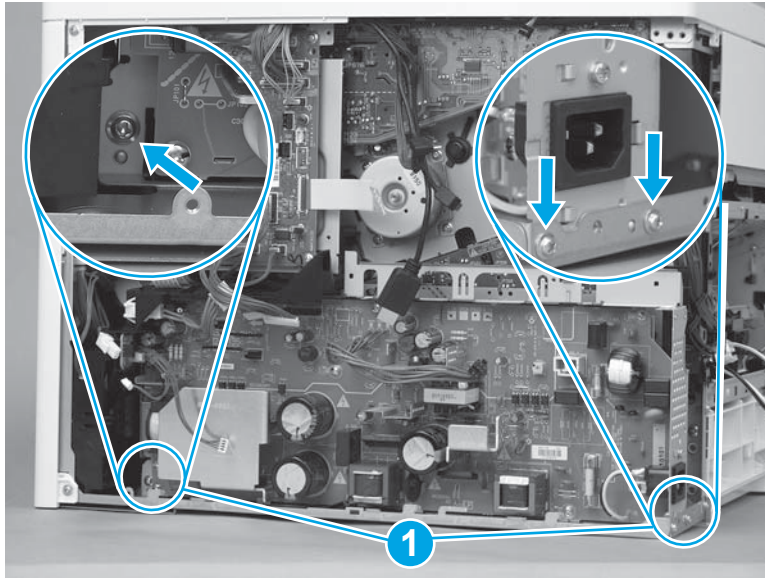

3. Pass the wire harnesses from the DC controller to the LVPS through the opening in the chassis (callout 1), and then install the wire harnesses in the retainer (callout 2).

Figure 1-3715 Pass the wire harnesses through the opening

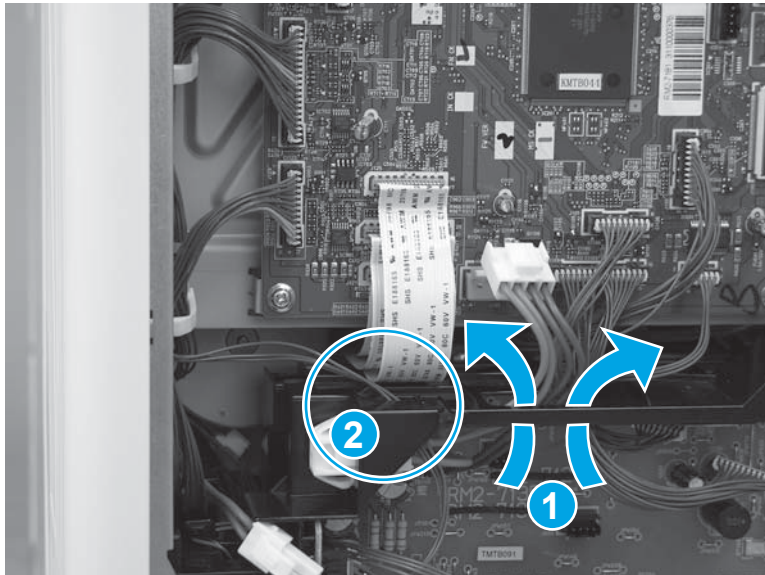

4. Connect three connectors on the DC controller (callout 1), and then connect four connectors (callout 2) on the LVPS.

Figure 1-3716 Connect seven connectors

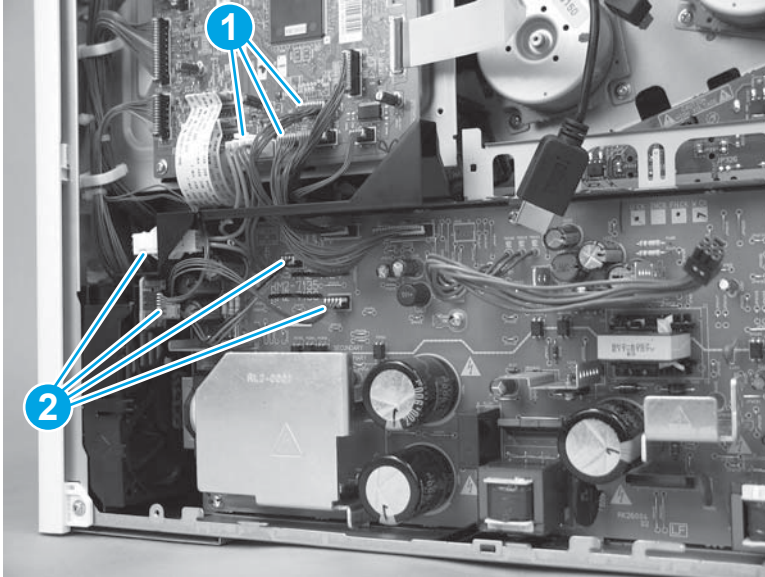

5. Pass the wire harness through the opening (callout 1) in the chassis, and then connect one wire harness (callout 2).

Figure 1-3717 Connect one wire harness

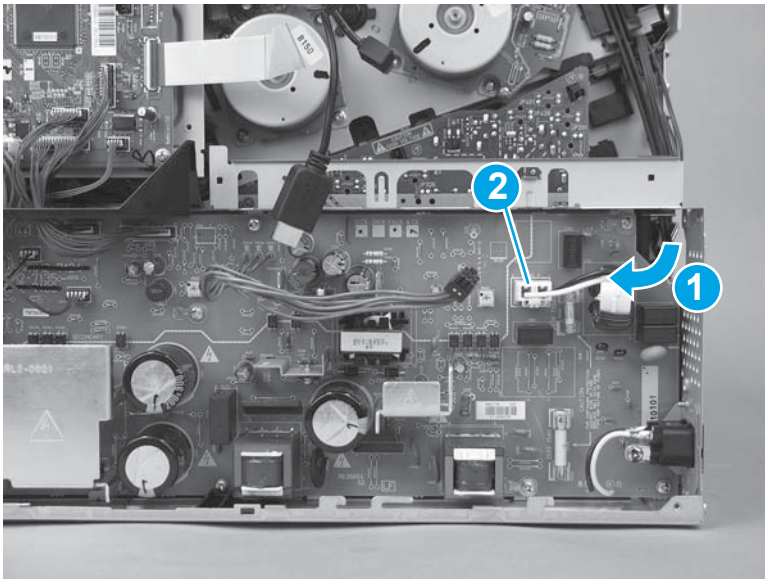

Step 34: Install the formatter case

1. Pass the wire harnesses through the opening in the formatter case.

Figure 1-3718 Pass the wire harnesses through the opening

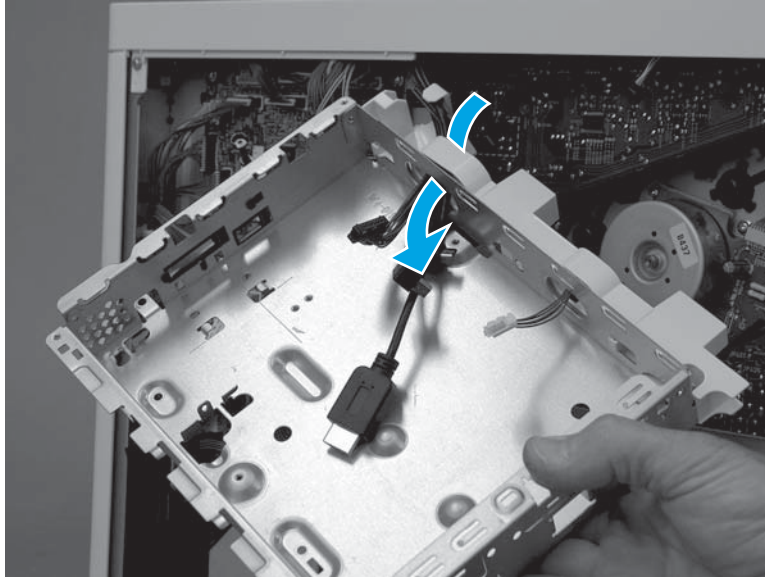

2. Position the top of the formatter case on the printer (callout 1), and then rotate the bottom of the case (callout 2) into the printer.

Figure 1-3719 Install the formatter case

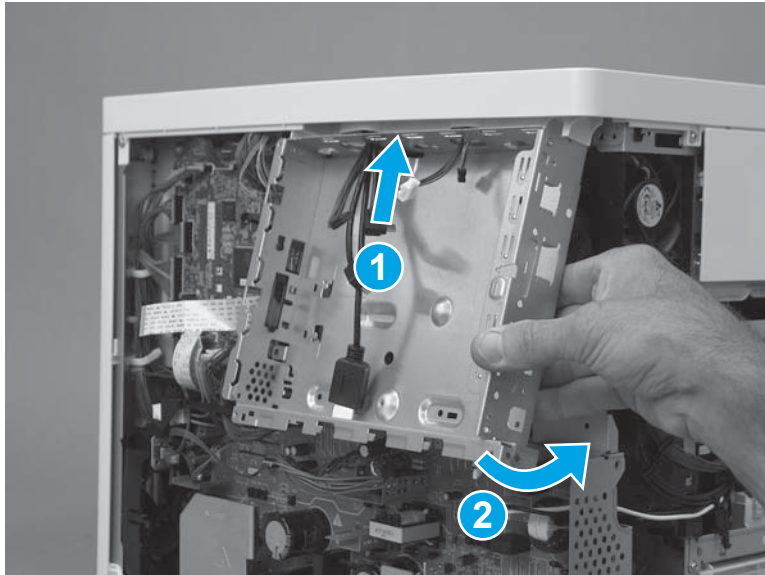

3. Install six screws (callout 1).

Figure 1-3720 Install six screws

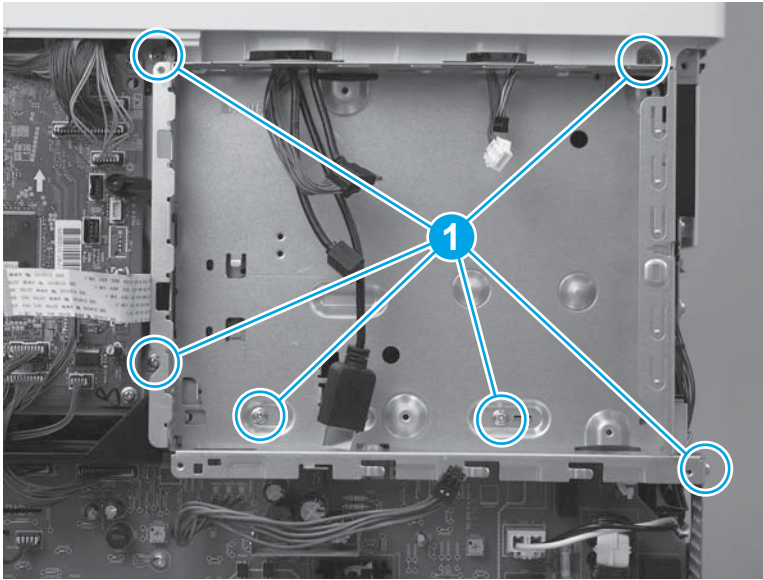

4. Pass two wire harnesses and one flat cable (callout 1) through the opening in the formatter case, and then install one wire harness in the retainer (callout 2).

 **IMPORTANT:** Make sure that the flat cable is securely fastened to the DC controller, and was not dislodged when the formatter case was removed.

Figure 1-3721 Install wire harnesses and flat cable



5. Position the LVPS cover on the printer, slide the cover to the left to install it, and then install two screws (callout 1).

Figure 1-3722 Install the LVPS cover

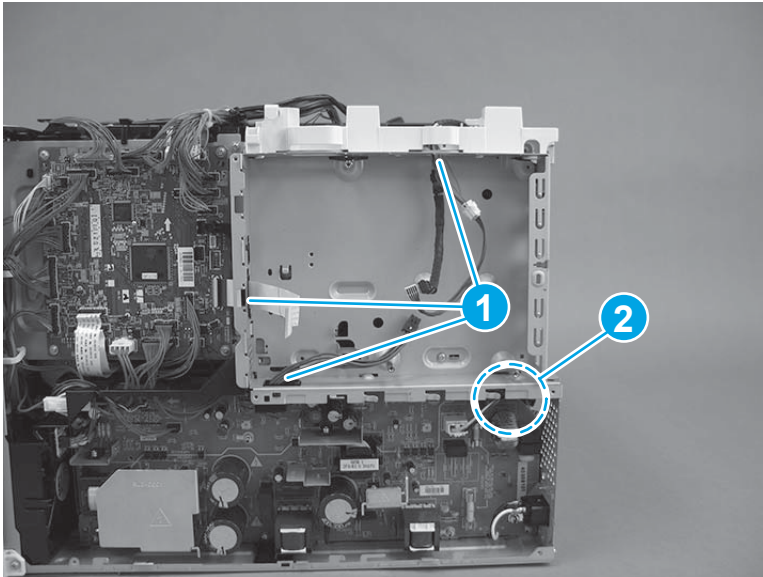
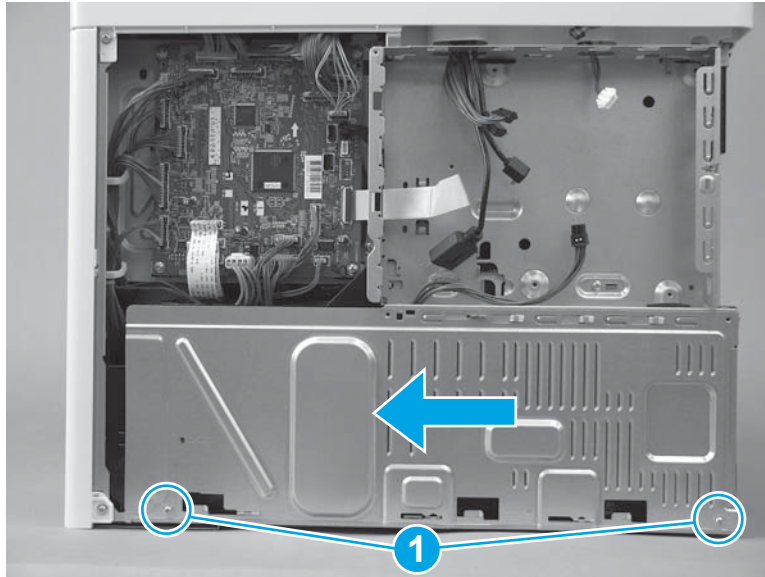

6. If no tape is affixed to the back of the flat cable, skip this step. If double-sided tape is affixed to the back of the flat cable, align the line (callout 1) on the cable with the edge (callout 2) of the opening in the sheet metal. Press to attach the flat cable to the formatter case.

Figure 1-3723 Attach the flat cable

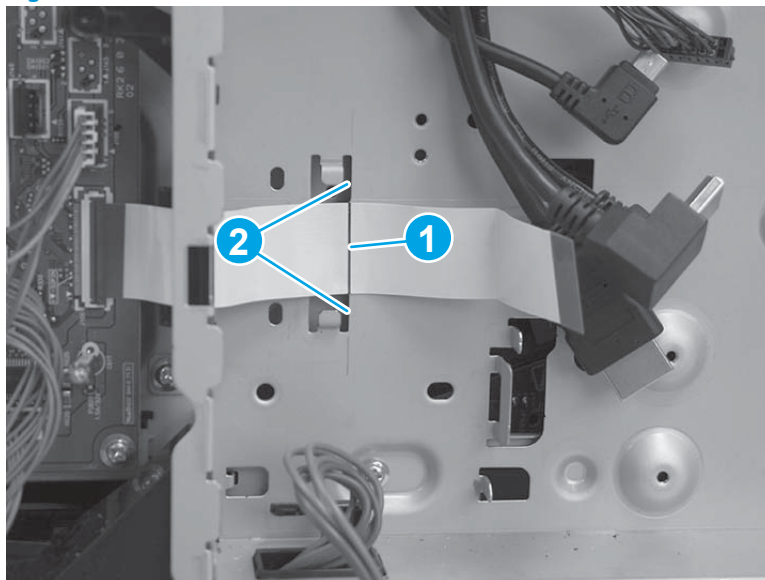

7. Position the bracket over the flat cable, and then slide the bracket to the left to install it. Make sure that the edges of the bracket fit under the sheet metal tabs (callout 1) on the formatter case and that the tabs (callout 2) snap into place.

Figure 1-3724 Position the bracket

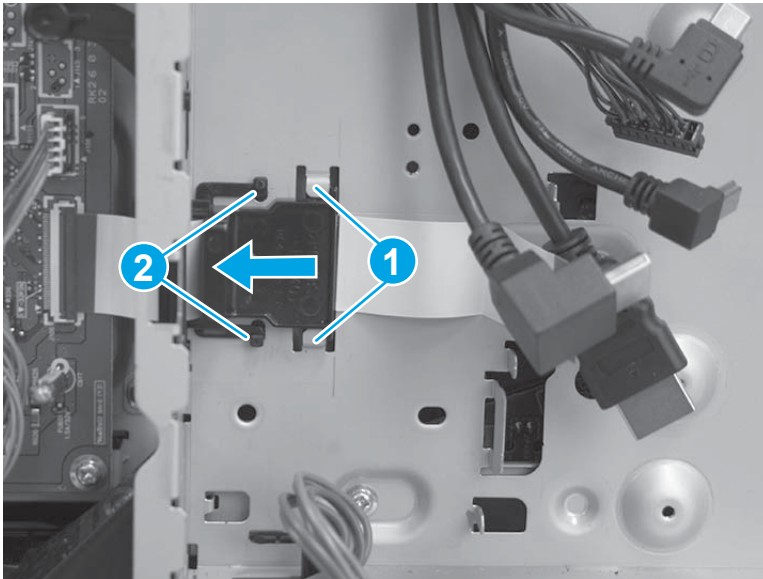

8. **M577 only:** Pass the wire harness (callout 1) through the openings in the formatter case (callout 2), and then connect one connector (callout 3).

Figure 1-3725 Connect one connector

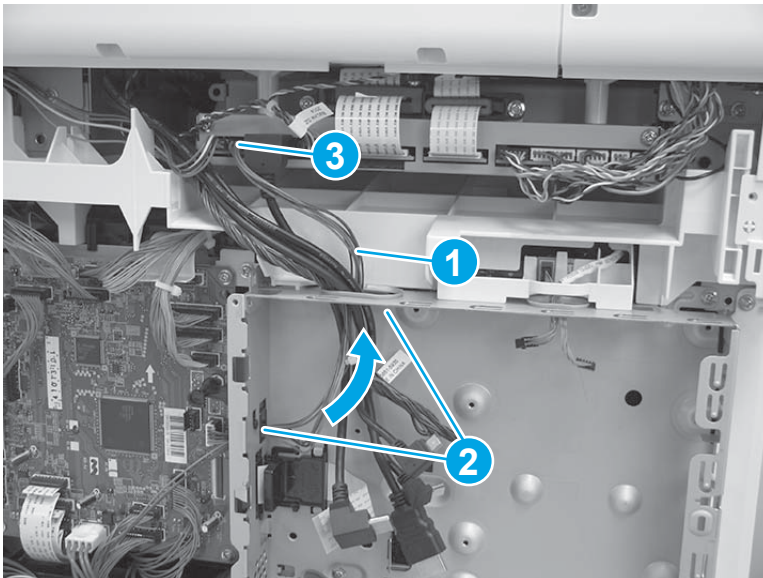

Step 35: Install the right rear cover

1. Position the cover on the printer.

Figure 1-3726 Install the cover

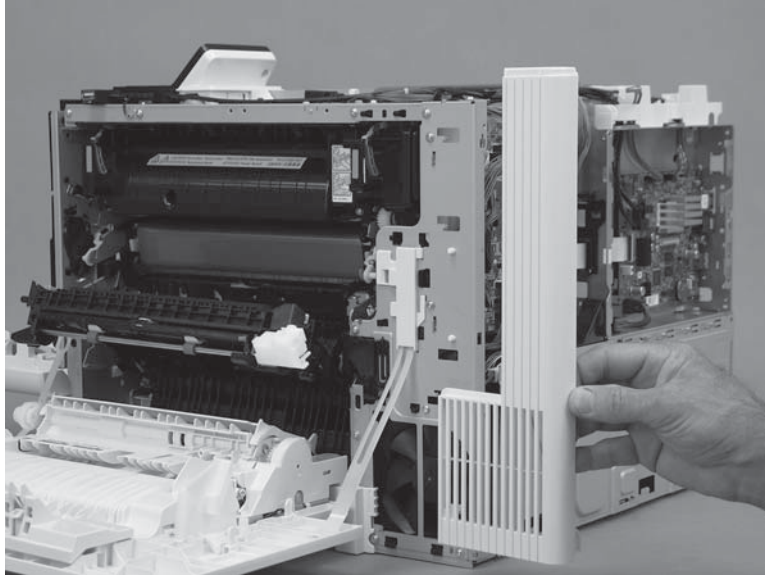

2. Slide the cover toward the right door (callout 1) to engage it with the printer, and then install one screw (callout 2).

Figure 1-3727 Install one screw

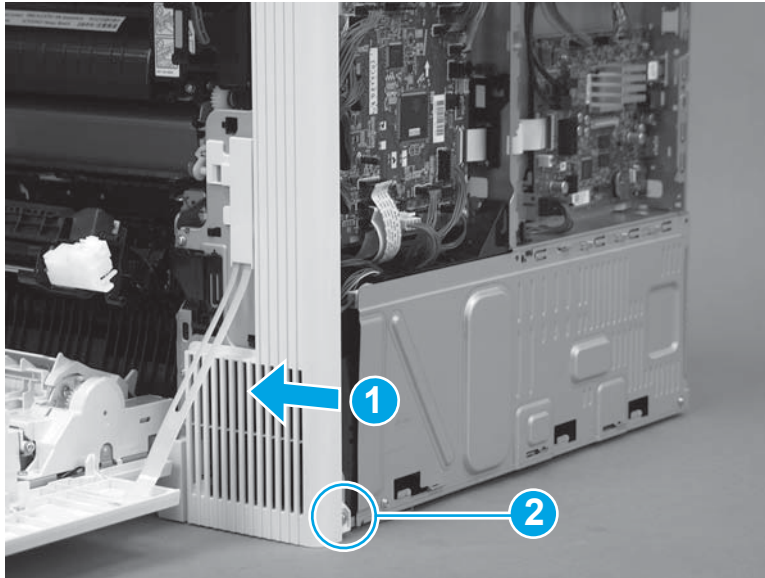

Step 36: Install the upper cover (M552 and M553)

 **NOTE:** This step is for the M552 and M553 models. For the M577 models, skip this step and go to [Step 37: Install the left cover on page 2089](#).

1. Position the cover on the printer.

 **NOTE:** For the M553x model, do not forget to pass the control-panel wire harness and USB cable through the opening in the cover.

Figure 1-3728 Install the cover



2. Push down on the rear corner of the cover to engage one tab (callout 1).

Figure 1-3729 Engage one tab

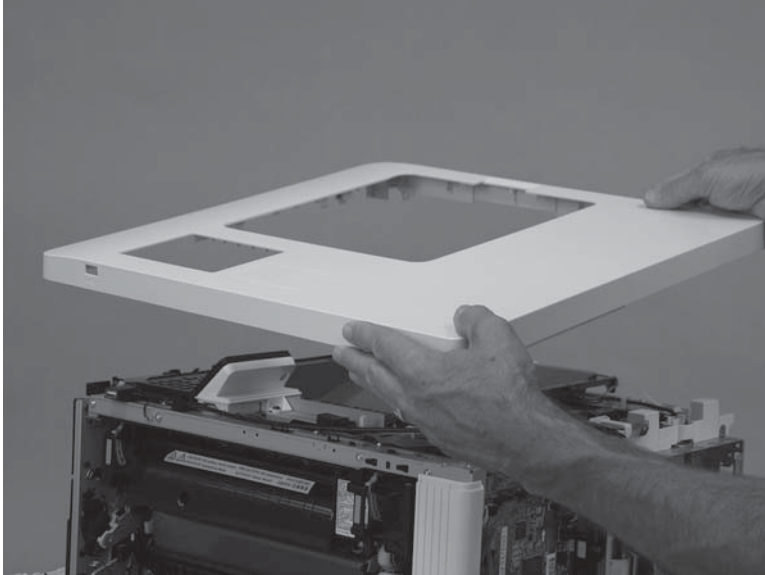
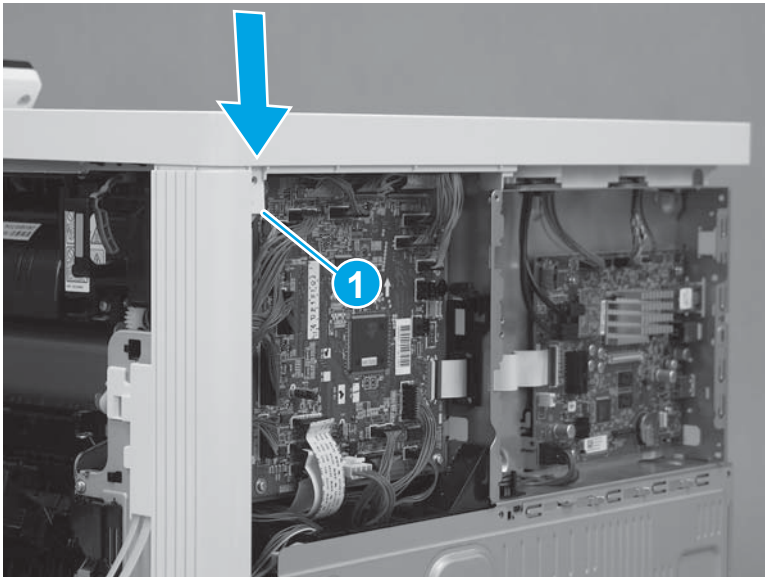

3. Push down on the front corner of the cover to engage one tab (callout 1), and then install one screw (callout 2).

 **NOTE:** This is a self-tapping plastic-thread screw. Make sure that this screw is used in this location when it is reinstalled.

Figure 1-3730 Engage one tab and install one screw



4. Install three screws (callout 1).

Figure 1-3731 Install three screws

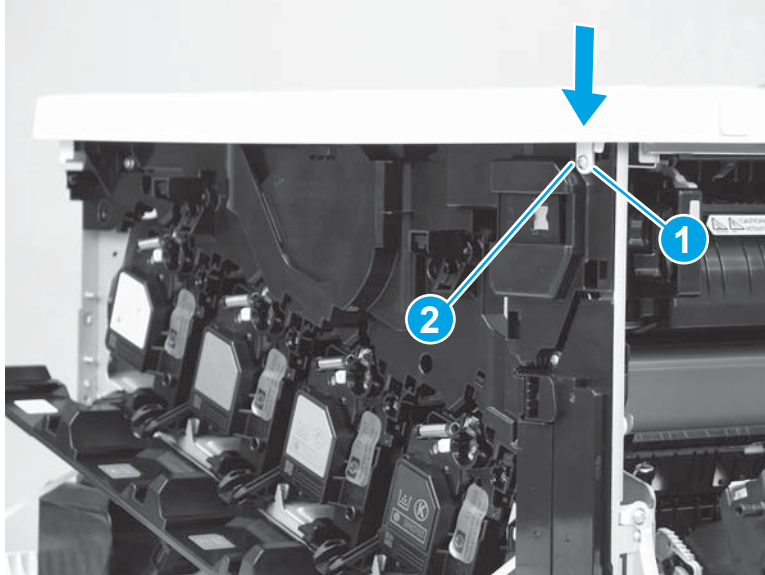
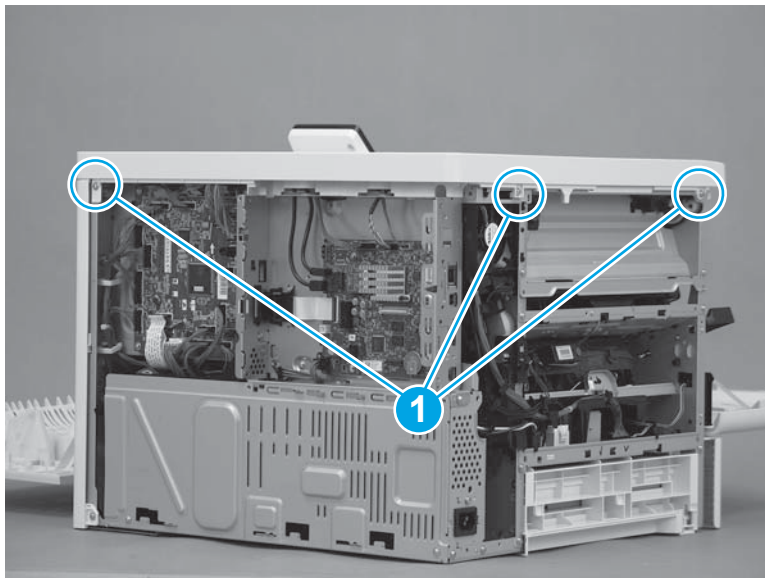

Step 37: Install the left cover

1. Position the cover on the printer.

 **NOTE:** Slightly offset the cover toward the rear of the printer.

Figure 1-3732 Install the cover

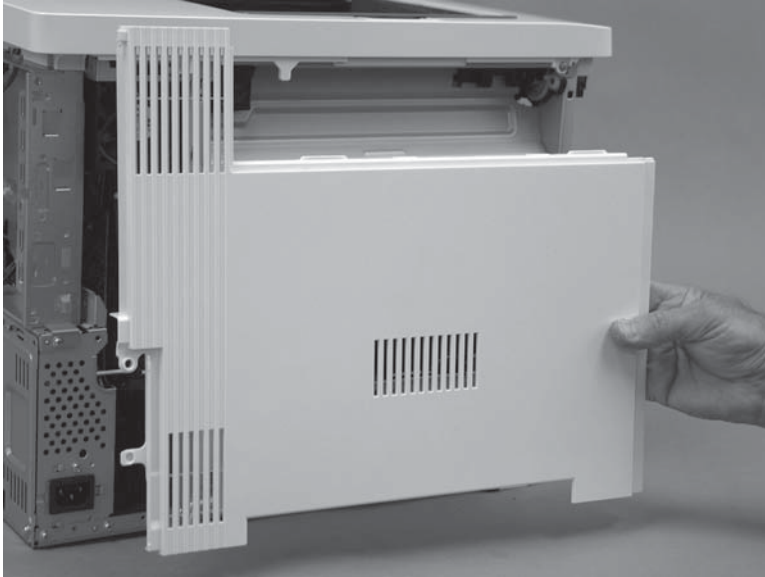

2. Slide the cover (callout 1) toward the front of the printer to engage it. Make sure that the tab (callout 2) snaps into place.

 **NOTE:** Locate the alignment pin (callout 3) on the cover from the front door side of the printer, and then make sure that it is fully engaged in the slot in the chassis.

 **TIP:** While sliding the cover into place, push in on the center of the cover (callout 1) to make sure that the hooks on the back of the cover engage with the slots in the chassis.

Figure 1-3733 Engage the cover



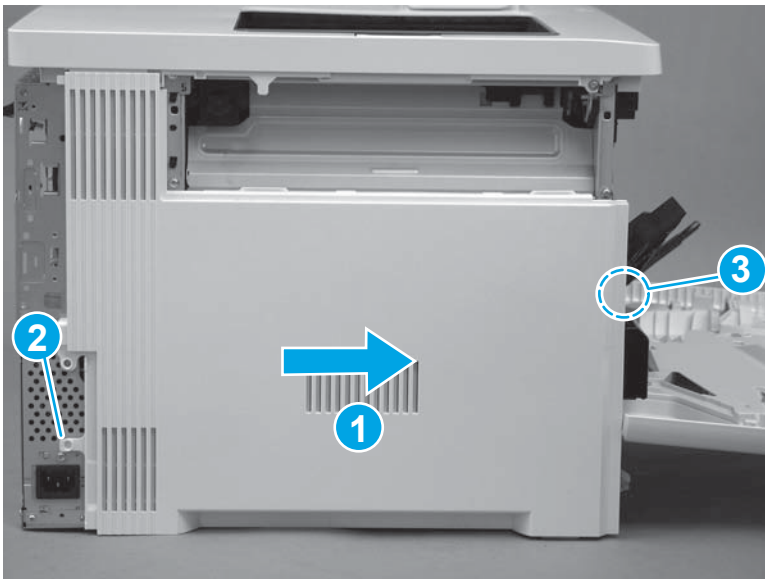

3. At the left side of the printer, install one screw (callout 1).

Figure 1-3734 Install one screw



Step 38: Install the right upper cover (M577)

 **NOTE:** This step is for the M577 models. For the M552 and M553 models, skip this step and go to [Step 45: Install the rear cover \(M552 and M553\) on page 2105](#).

 **NOTE:** The figures below show the image scanner installed. The procedures for removing and installing the right upper cover are the same whether the image scanner is installed or removed."

1. **M577c/f/z only:** Install the cables (callout 1) through the slot (callout 2) in the printer.

Figure 1-3735 Install the cables

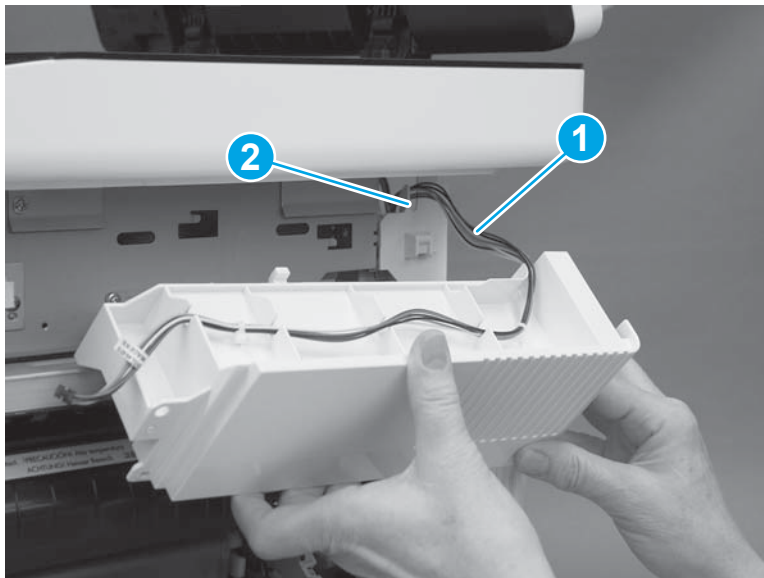

2. Position the hooks (callout 1) on the cover in the slots (callout 2) in the printer.

Figure 1-3736 Position the hooks

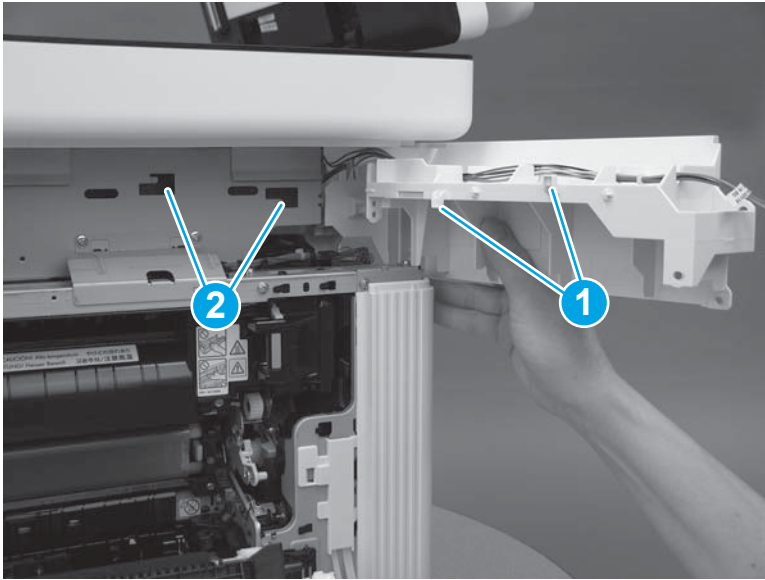

3. Slide the cover toward the front of the printer to install it.

Figure 1-3737 Install the cover

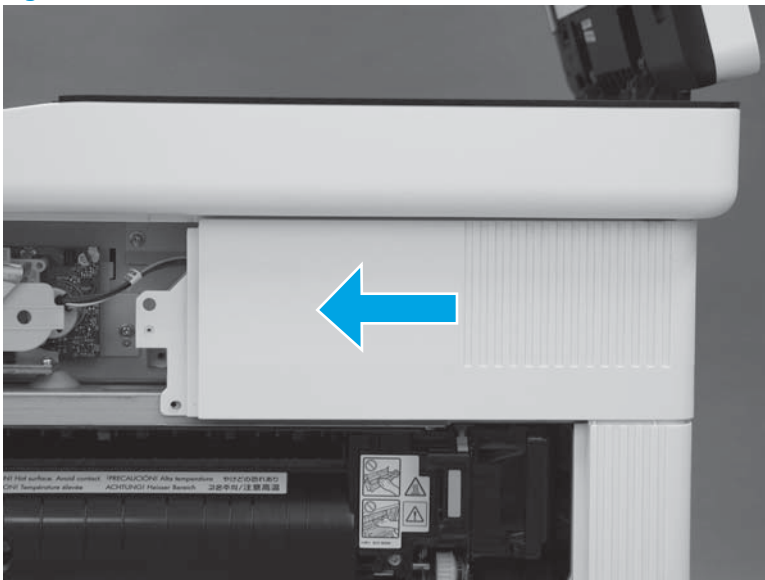

4. At the back of the printer, install one screw (callout 1).

M577c/f/z only: Connect one connector (callout 2), if the integrated scanner assembly is installed.

 **TIP:** This screw is smaller than the screws installed in the next step. Make sure that this screw is installed in the correct position.

Figure 1-3738 Install one screw and connector



5. At the right side of the printer, install two screws (callout 1).

M577c/f/z only: Connect one connector (callout 2), if the stapler is installed.

Figure 1-3739 Install one screw and connector

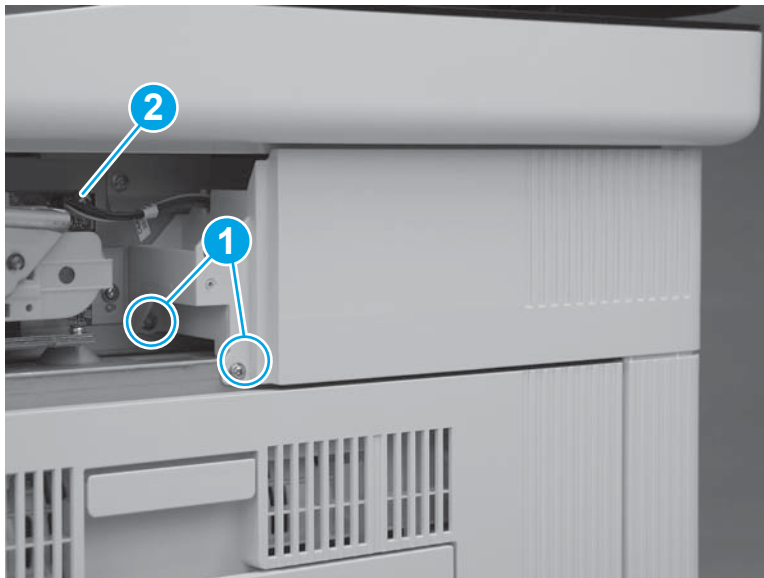

Step 39: Install the integrated scanner assembly (ISA) (M577)

 **NOTE:** This step is for the M577 models. For the M552 and M553 models, skip this step and go to [Step 45: Install the rear cover \(M552 and M553\) on page 2105](#).



NOTE: The ISA includes the document feeder, image scanner, scanner control board (SCB), control panel, keyboard (M577c/z) and NFC PCA (M577z).

1. Before proceeding, locate the mounting pins (callout 1) on the bottom of the ISA and the slots (callout 2) on the printer base.

Figure 1-3740 Locate the ISA mounting pins and slots

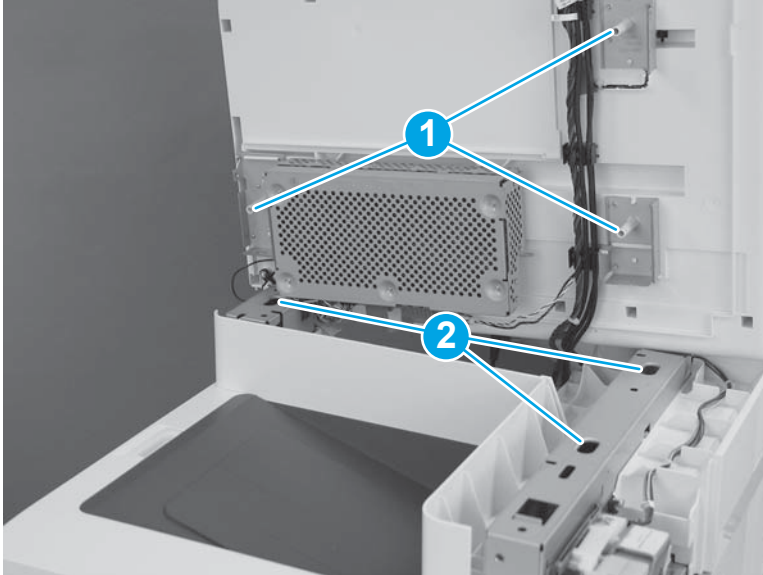

2. Position the ISA on the printer base with the pins in the slots.



NOTE: To locate the pins and slots, see [Figure 1-395 Locate the ISA mounting pins and slots on page 250](#).

When installing the ISA, carefully pass the cables through the opening in the top of the formatter case.

Figure 1-3741 Install the ISA

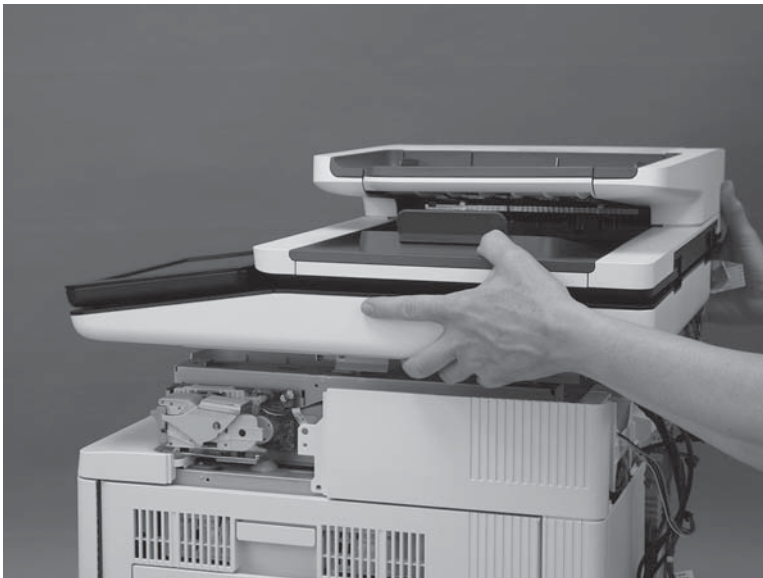

3. Slightly slide the ISA towards the front of the printer to engage it.

Figure 1-3742 Slide the ISA towards the front of the printer

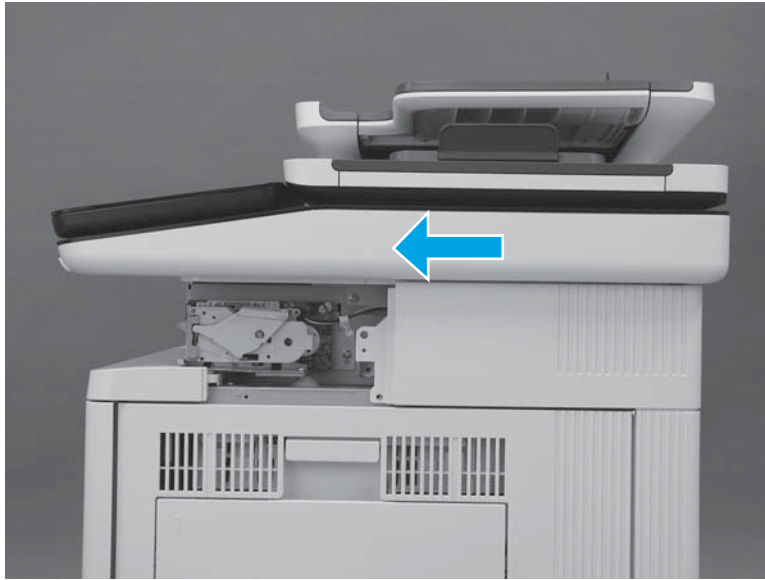

4. At the left side of the printer, install one screw (callout 1).

Figure 1-3743 Install one screw

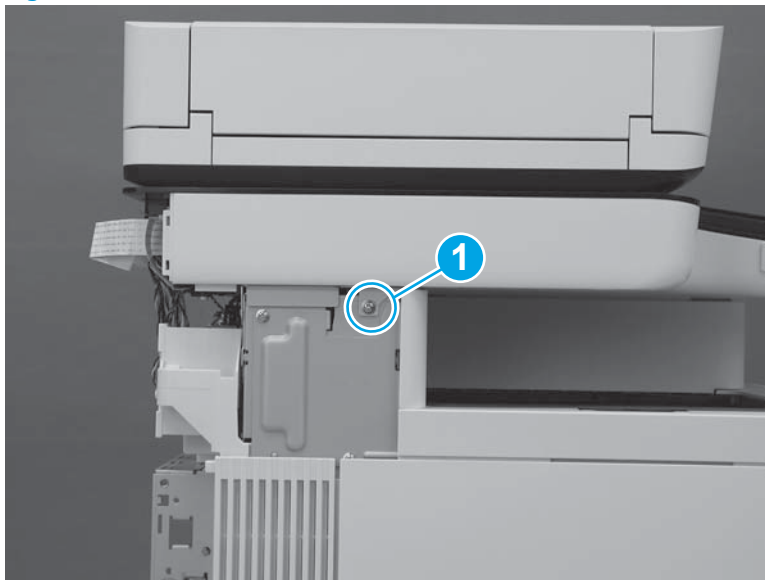

5. At the back of the printer, install two screws (callout 1).

Figure 1-3744 Install two screws

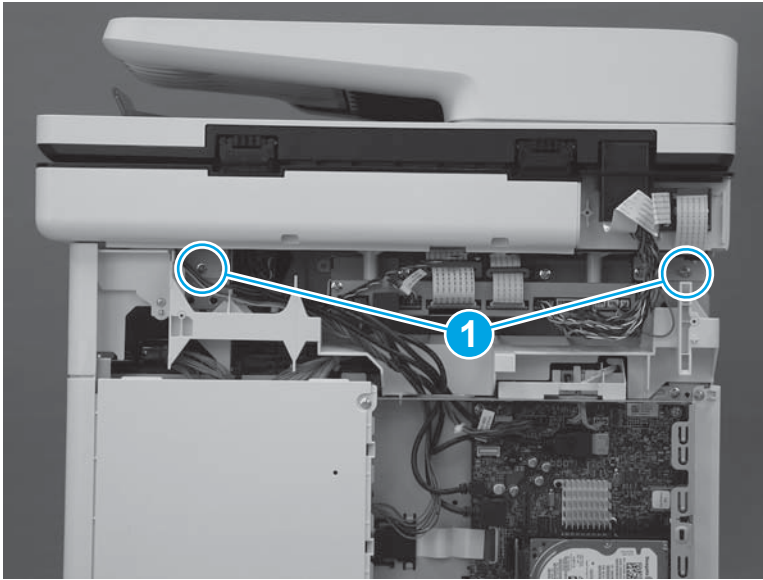

6. At the right side of the printer, install one screw (callout 1).

Figure 1-3745 Install one screw

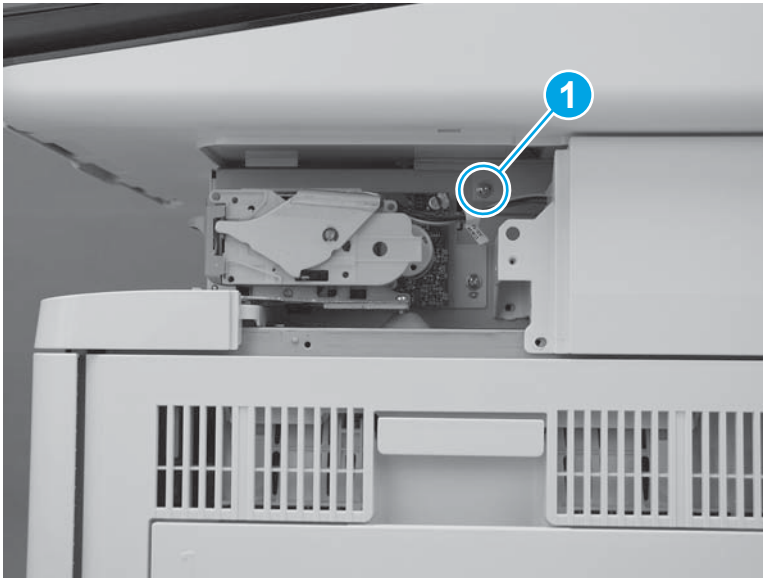

7. Connect two connectors on the scanner control board (callout 1).

M577c/f/z only: Connect one connector for the stapler on the scanner control board (callout 2).

Figure 1-3746 Connect connectors

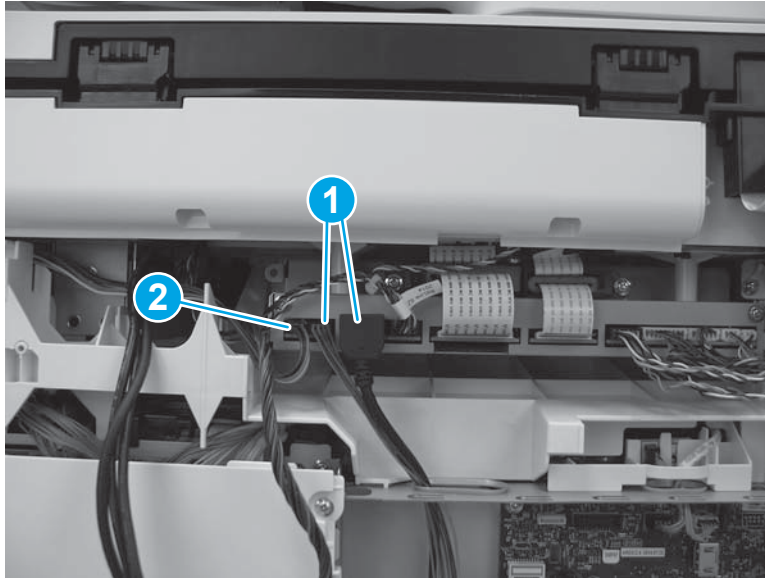

Step 40: Install the stapler cover assembly (M577c/f/z)

 **NOTE:** This step is for the M577c/f/z models only. For the M577dn model, skip this step and go to [Step 41: Install the right front upper cover \(M577dn\) on page 2098](#).

For the M552 and M553 models, skip this step and go to [Step 45: Install the rear cover \(M552 and M553\) on page 2105](#).

1. Install the tabs (callout 1) on the cover in the slots (callout 2) in the printer.

Figure 1-3747 Install two tabs



2. Press the cover toward the left side of the printer until it snaps into place.

Figure 1-3748 Install the cover assembly



3. Install one screw (callout 1).



 **IMPORTANT:** This is a self-tapping screw for plastic. Rotate it counterclockwise to align it with the existing thread pattern, and then carefully turn it clockwise to tighten. Do not overtighten. This will prevent stripping the threads inside the screw hole.

Figure 1-3749 Install one screw

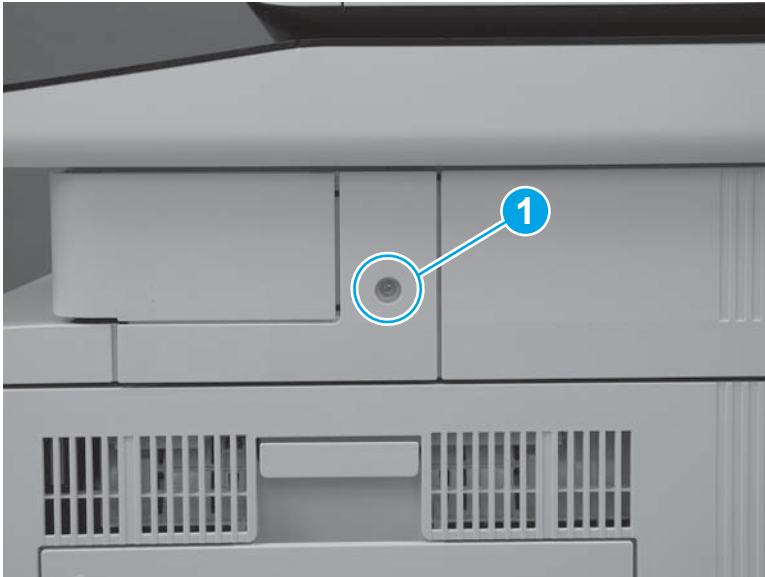

Step 41: Install the right front upper cover (M577dn)

 **NOTE:** This step is for the M577dn model only. For the M577c/f/z models, skip this step and go to [Step 42: Install the left upper cover \(M577\) on page 2100](#).

For the M552 and M553 models, skip this step and go to [Step 45: Install the rear cover \(M552 and M553\) on page 2105](#).

1. Slide the cover toward the left side of the printer to install it. Make sure that the slots (callout 1) in the cover fit over the tabs (callout 2) on the inside of the paper feeder cover.

Figure 1-3750 Install the cover

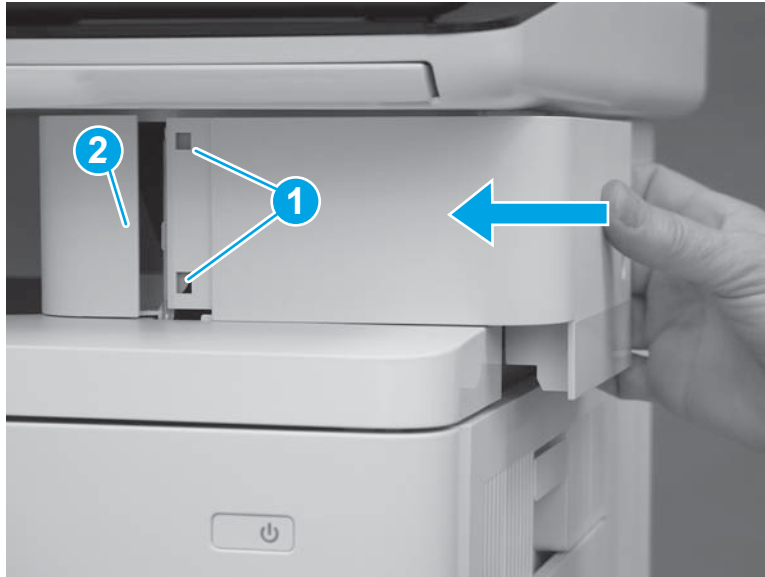

2. Press the right front upper cover (callout 1) and the paper feeder cover (callout 2) together until the tabs on the inside of the covers snap into place.

Figure 1-3751 Press the cover



3. Install one screw (callout 1).

Figure 1-3752 Install one screw

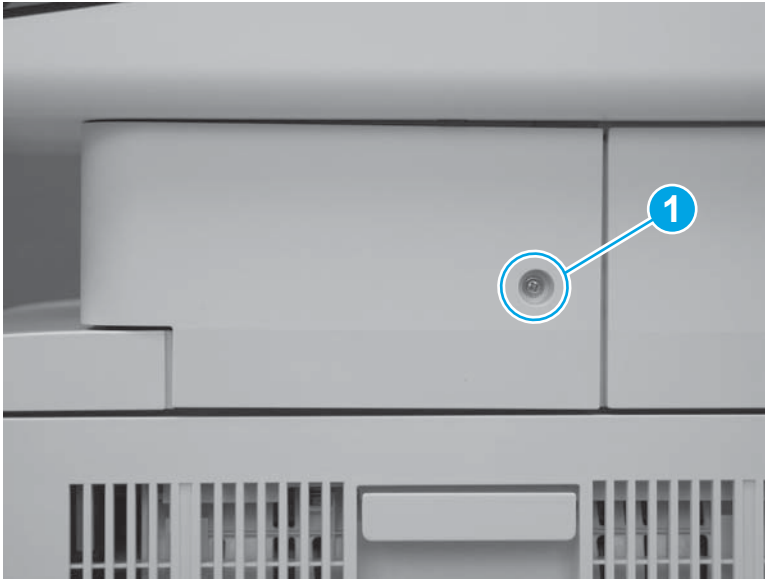

Step 42: Install the left upper cover (M577)



NOTE: This step is for the M577 models. For the M552 and M553 models, skip this step and go to [Step 45: Install the rear cover \(M552 and M553\) on page 2105](#).

1. Position the tab (callout 1) on the lower edge of the cover behind the left cover (callout 2).

Figure 1-3753 Position the tab

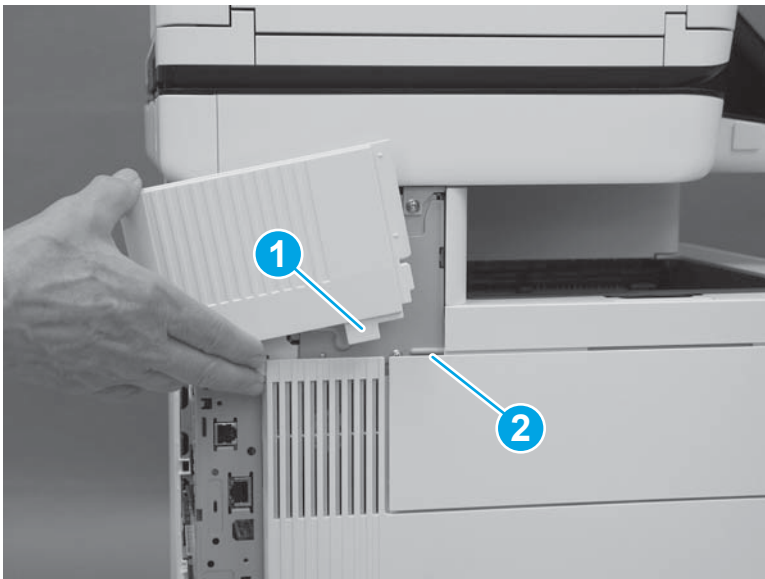

2. Slide the cover toward the front of the printer to install it. Make sure that the edge (callout 1) of the cover fits behind the edge (callout 2) of the top rear cover.

Figure 1-3754 Slide the cover

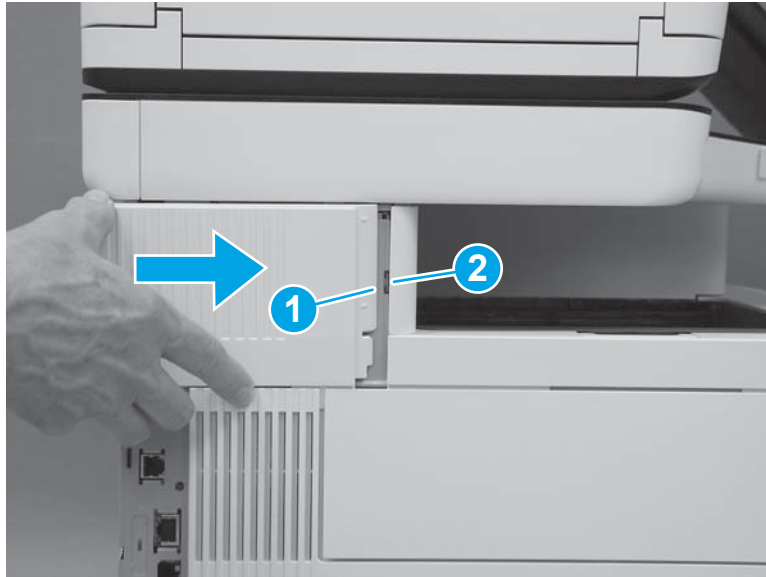

3. Make sure that the tab (callout 1) is fully installed.

Figure 1-3755 Check the tab

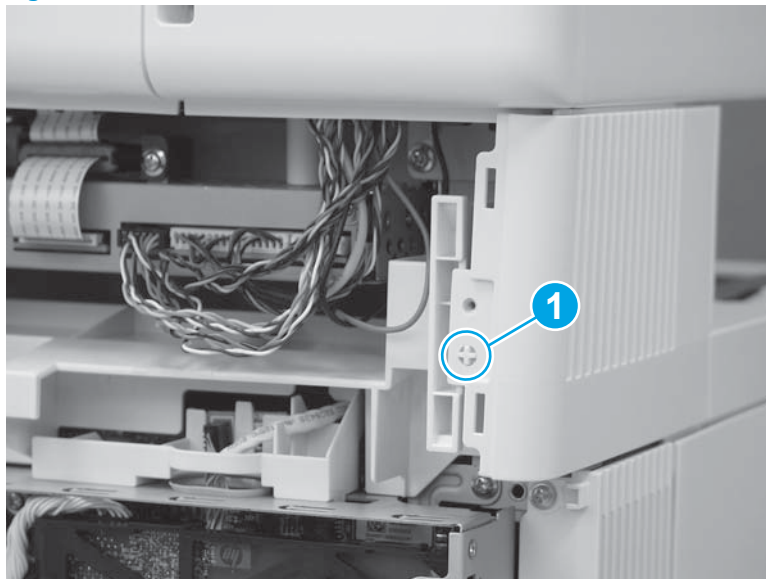

Step 43: Install the rear cover (M577)

 **NOTE:** This step is for the M577 models. For the M552 and M553 models, skip this step and go to [Step 45: Install the rear cover \(M552 and M553\) on page 2105](#).

1. Position the hooks (callout 1) on the cover in the slots (callout 2) in the printer.

Figure 1-3756 Position the hooks

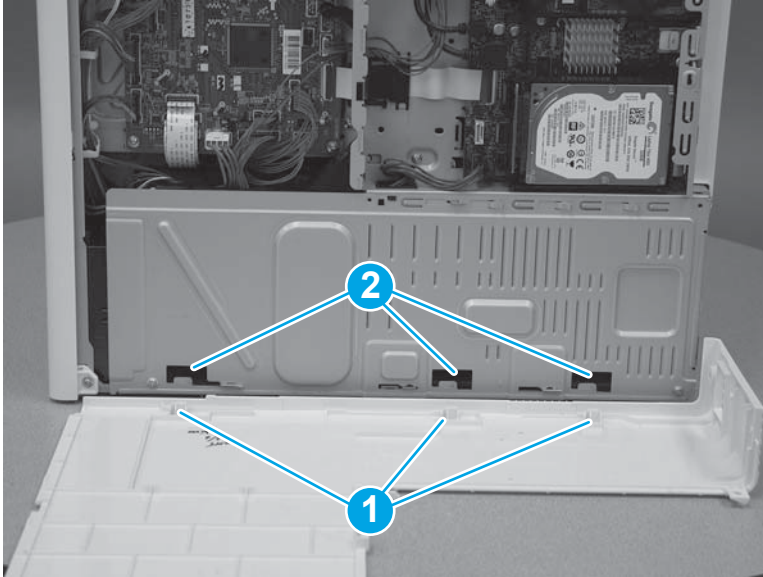

2. Position the back edge (callout 1) of the rear cover behind the edge (callout 2) of the right rear cover. Slide the cover to the left to install it.

Figure 1-3757 Install the cover

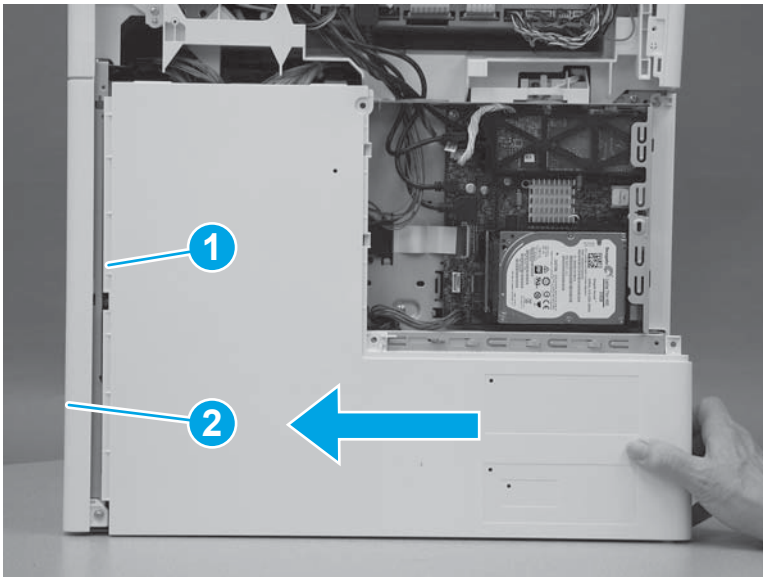

3. Install four screws (callout 1).

Figure 1-3758 Install four screws cover

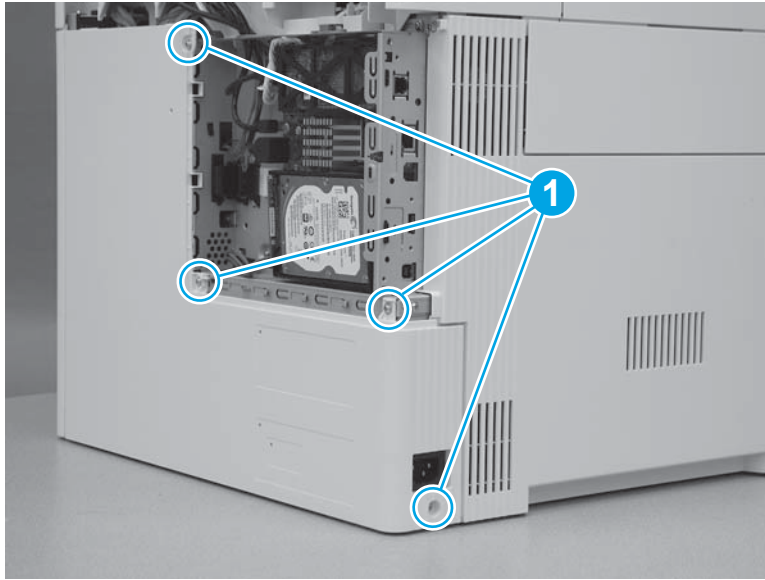

Step 44: Install the rear upper cover (M577)

 **NOTE:** This step is for the M577 models. For the M552 and M553 models, skip this step and go to [Step 45: Install the rear cover \(M552 and M553\) on page 2105](#).

1. Align the ridge (callout 1) on the lower edge of the rear upper cover in front of the tabs (callout 2) on the top edge of the rear cover.

Figure 1-3759 Align the cover

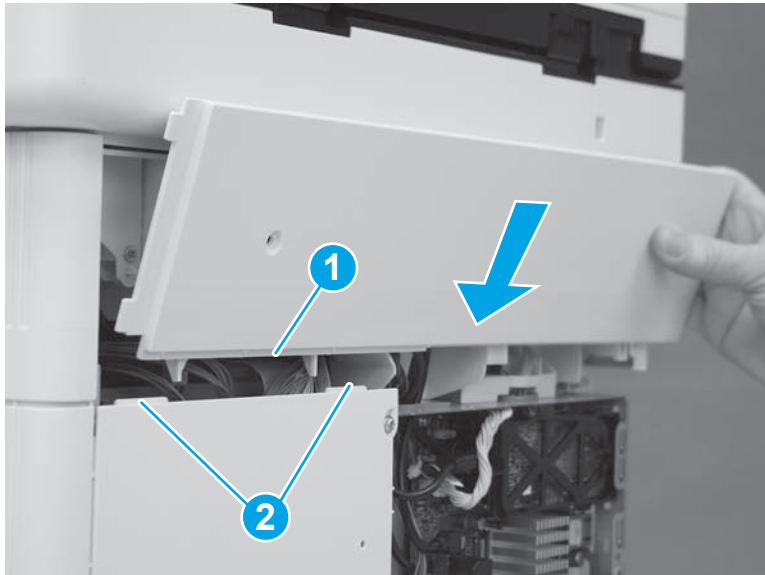

2. Rotate the top of the cover toward the printer.

Figure 1-3760 Rotate the top of the cover

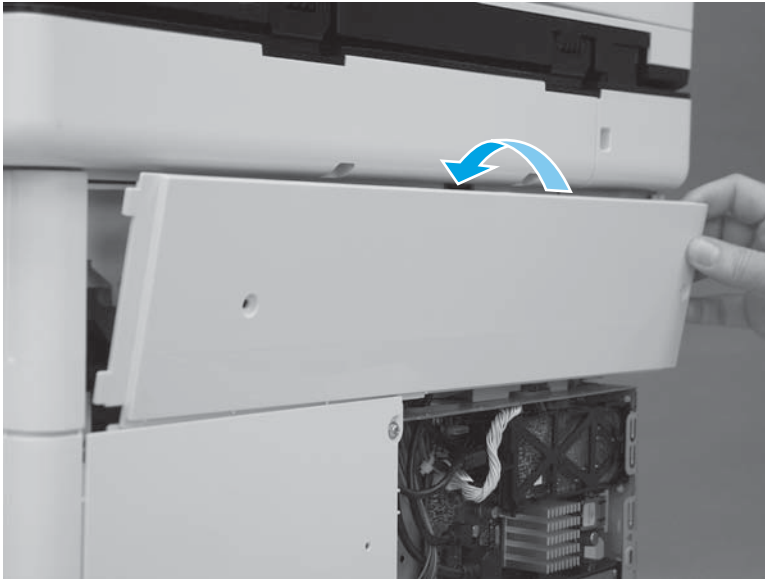

3. Slide the cover to the left (callout 1). Make sure that the tabs (callout 2) on the upper rear cover slide behind the edge (callout 3) of the right upper cover. Make sure that the cover is fully seated.

Figure 1-3761 Slide the cover

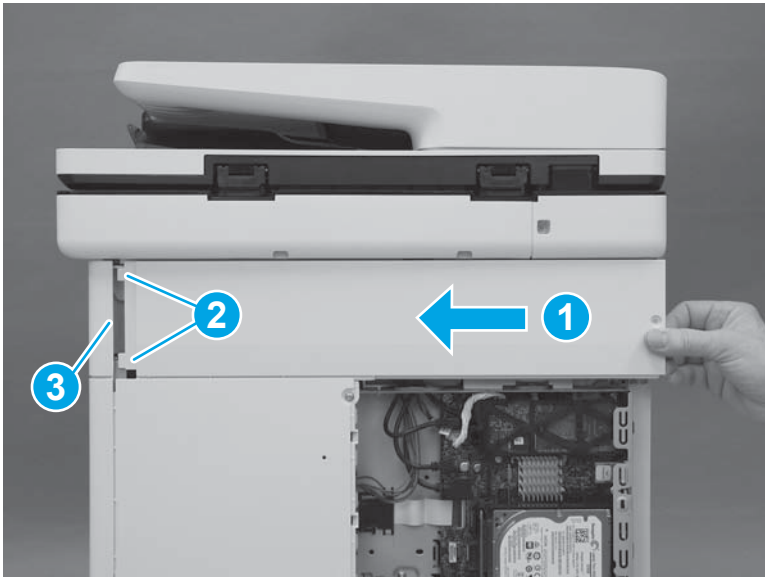

4. Install two screws (callout 1).

 **IMPORTANT:** These two screws are self-tapping screws for plastic. Rotate them counterclockwise to align them with the existing thread pattern, and then carefully turn them clockwise to tighten. Do not overtighten. This will prevent stripping the threads inside the screw holes.

Figure 1-3762 Install two screws



Step 45: Install the rear cover (M552 and M553)

 **NOTE:** This step is for the M552 and M553 models. For the M577 models, skip this step and go to [Step 46: Install the formatter \(M577\) on page 2106](#).

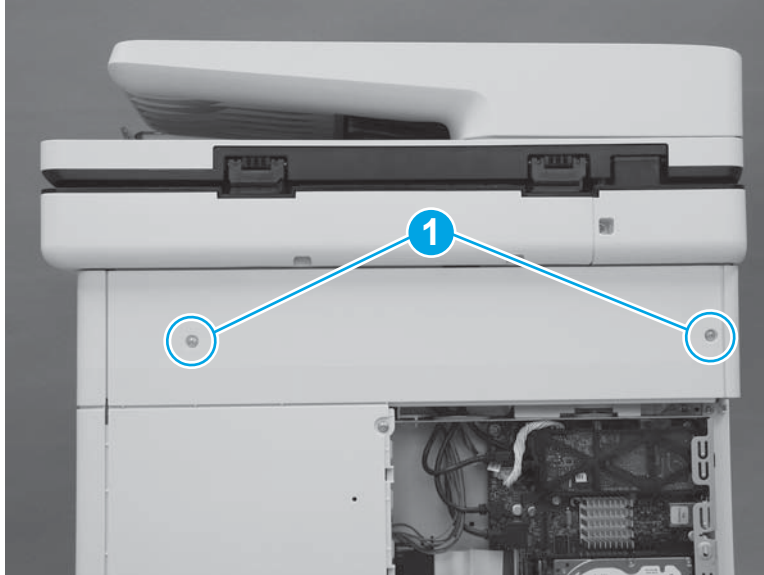
1. Position the top of the cover under the upper cover (callout 1), rotate the bottom of the cover onto the chassis (callout 2), and then slide the cover to the left (callout 3) to install it.

Figure 1-3763 Install the cover

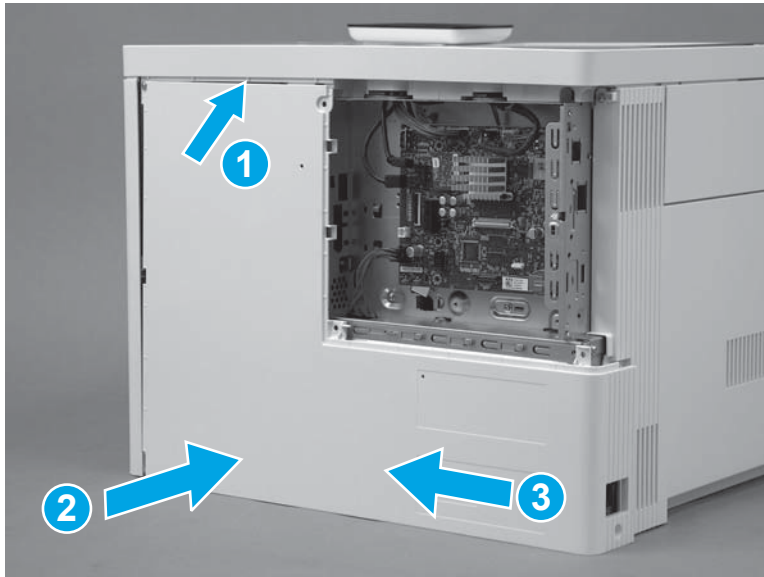

2. Install four screws (callout 1).

Figure 1-3764 Install four screws cover

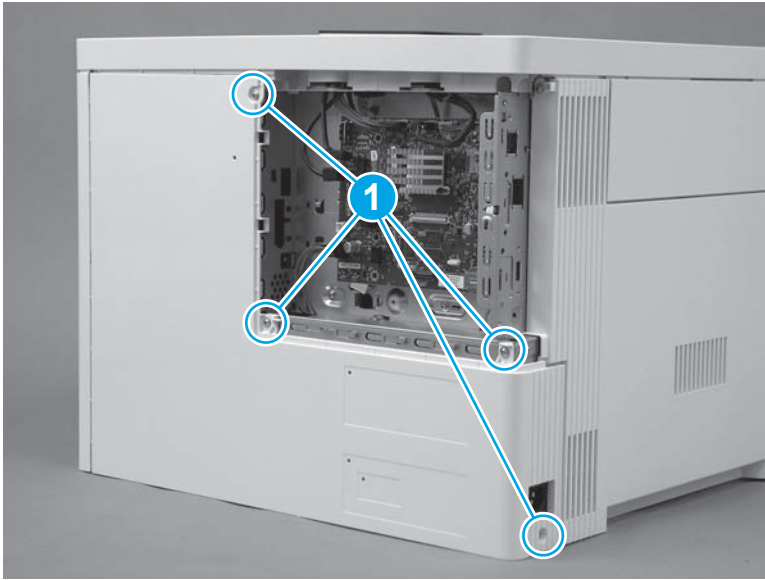

Step 46: Install the formatter (M577)



NOTE: This step is for the M577 models. For the M552 and M553 models, skip this step and to go [Step 49: Install the formatter \(M552 and M553\) on page 2111](#).



CAUTION:  ESD-sensitive part.

1. Position the formatter in the printer. Make sure that the network port (callout 1) fits through the opening (callout 2) in the formatter case.

Figure 1-3765 Install the formatter

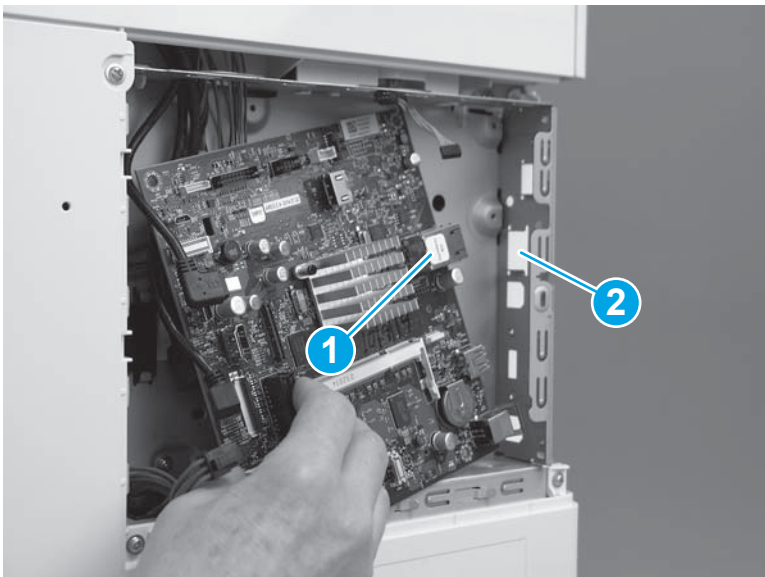

2. Install four screws (callout 1).

Figure 1-3766 Install four screws

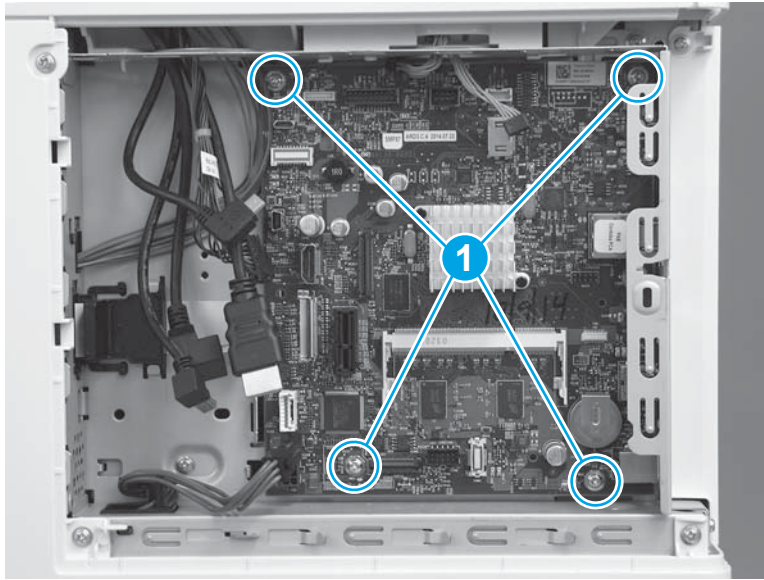

3. Connect all of the connectors on the formatter.

The following connectors are empty:

- All models: J1 (this connector is empty unless the optional DIMM is installed)
- All models: J3
- M577dn: J15 (this is the fax connector for the M577f/z/c models)
- All models: J21 (this connector is empty unless the optional internal USB ports component is installed)
- All models: J23
- All models: J24
- All models: J51
- All models: J57
- All models: J97
- All models: J98 (this connector is empty unless the optional trusted platform module (TPM) is installed)

 **IMPORTANT:** The flat-cable connector (callout 1) is a Zero Insertion Force (ZIF) connector that uses a hinged retainer to secure the flat cable. The hinged retainer must be opened to install the flat cable, and then closed after the cable is installed.

Figure 1-3767 Connect all connectors



Step 47: Install the fax PCA (M577c/f/z)

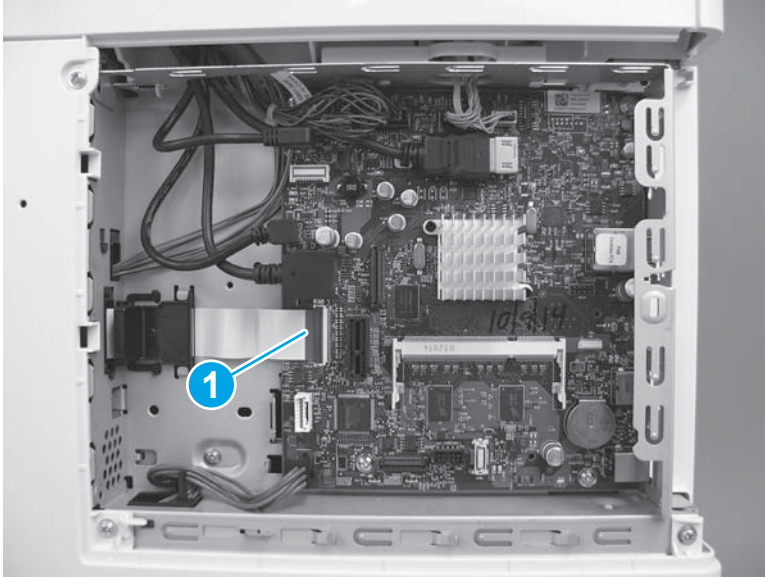

NOTE: This step is for the M577c/f/z models. For the M577n model, skip this step and go to [Step 48: Install the HDD \(M577\) on page 2109](#).

For the M552 and M553 models, skip this step and go to [Step 49: Install the formatter \(M552 and M553\) on page 2111](#).



CAUTION:  ESD-sensitive part.

1. Position the tab and telephone port (callout 1) on the fax PCA in the slots (callout 2) in the formatter case.

Figure 1-3768 Position the fax PCA

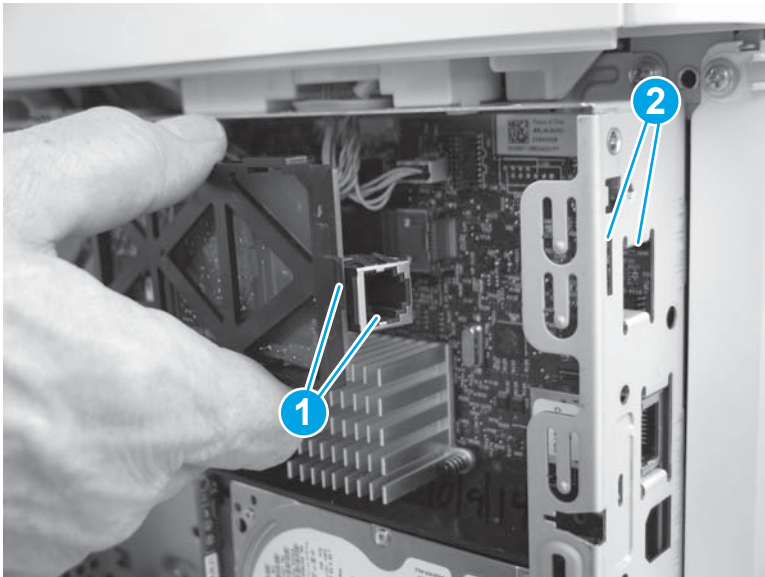

2. Slide the fax PCA to the right (callout 1) until the tab and telephone port described in the previous step and seated in the formatter case. Position the retainer (callout 2) in the slot (callout 3) in the formatter. Rotate the end of the fax PCA toward the formatter (callout 4) until the retainer snaps into place.

Figure 1-3769 Install the fax PCA

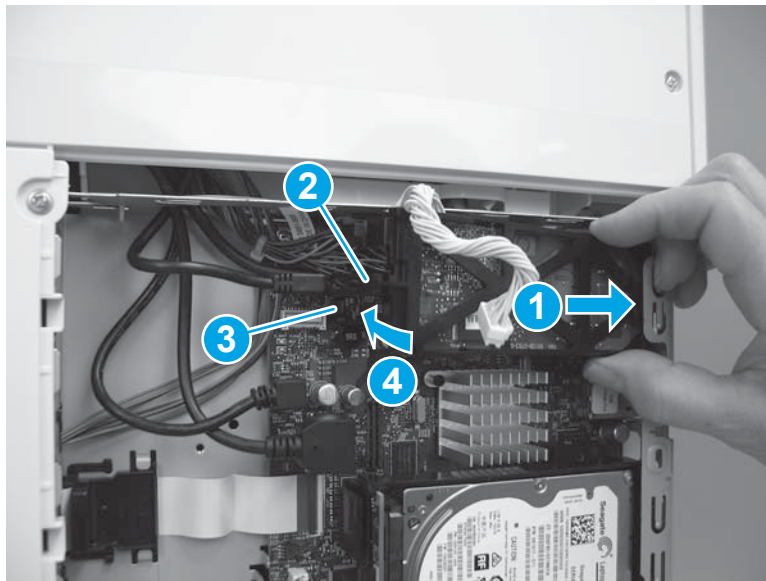

3. Position the cable (callout 1) in the guide (callout 2), and then connect one connector (callout 3).

Figure 1-3770 Connect the connector

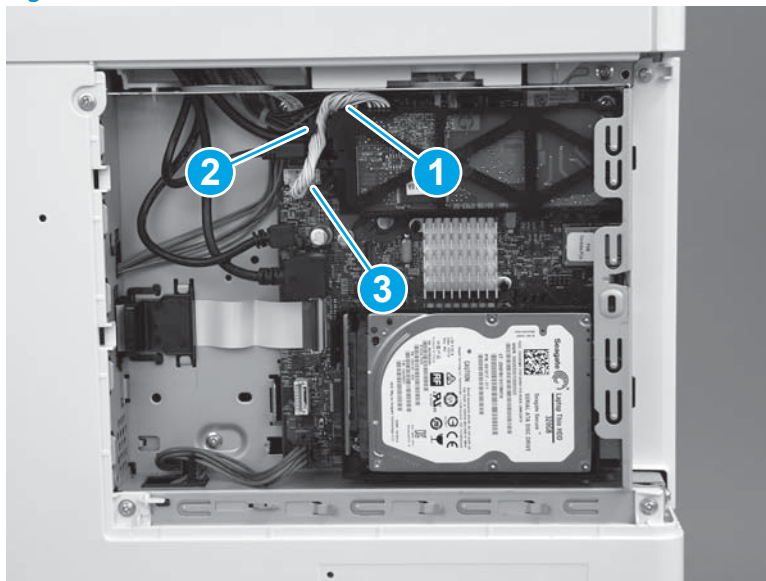

Step 48: Install the HDD (M577)

 **NOTE:** This step is for the M577 models. For the M552 and M553 models, skip this step and go to [Step 49: Install the formatter \(M552 and M553\) on page 2111](#).

 **CAUTION:**  ESD-sensitive part.

1. Align the end of the bracket (callout 1) with the slot in the chassis (callout 2), and then slide the HDD into the printer (callout 3) to engage the bracket with the chassis.

Figure 1-3771 Install the holder

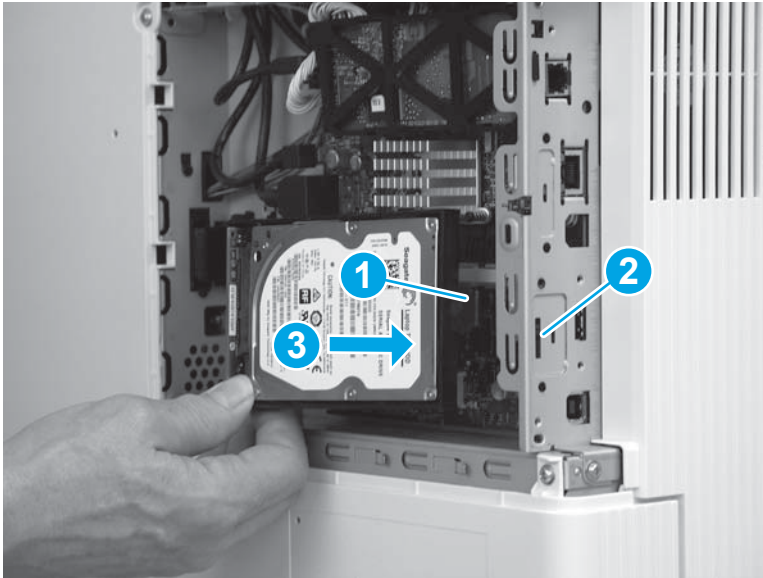

2. Hold the HDD connector latch (callout 1) in the released position, and then rotate the HDD down and into the connector on the formatter to install it.

 **NOTE:** Make sure that the tab (callout 2) snaps into place, and that the HDD is securely installed.

Figure 1-3772 Release the HDD

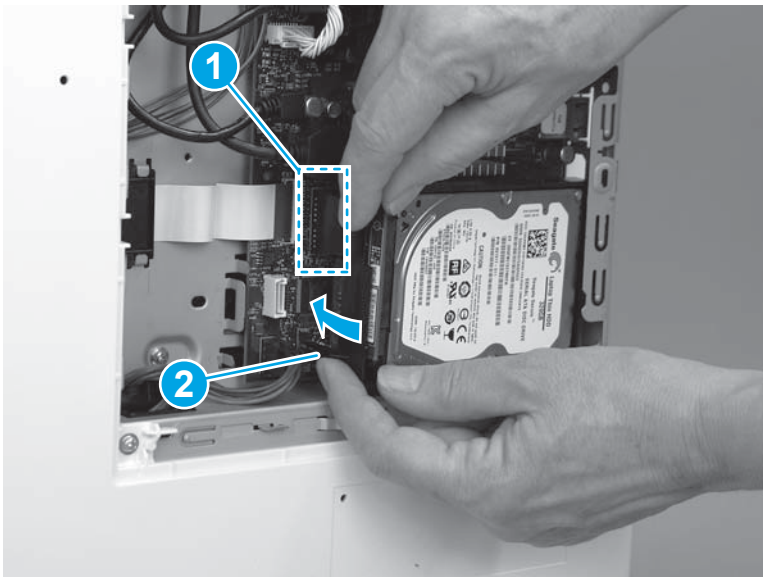

Step 49: Install the formatter (M552 and M553)

 **NOTE:** This step is for the M552 and M553 models. For the M577 models, skip this step and go to [Step 52: Install the formatter cover on page 2116](#).

If the optional hard-disk drive (HDD) was removed, do not forget to reinstall it after the formatter is reinstalled.

Engage the HDD holder with the chassis, rotate the HDD connector down and into the connector on the formatter. Make sure that the tabs snap into place.

 **CAUTION:**  ESD-sensitive part.

1. Position the formatter in the printer, and then install four screws (callout 1).

Figure 1-3773 Install the formatter

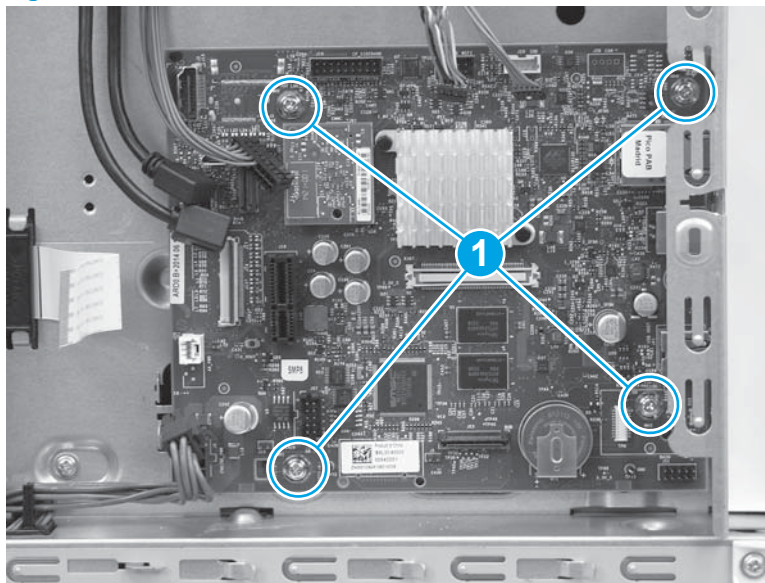

2. Connect all of the connectors on the formatter.

The following connectors are empty:

- All models: J1 (this connector is empty unless the optional DIMM is installed)
- M553n/dn and M552dn: J2 (callout 1; this is the touchscreen connector for the M553x model)
- All models: J9 (this connector is empty unless the optional internal USB ports component is installed)
- All models: J18 (this connector is empty unless the optional hard-disk-drive (HDD) is installed)
- All models: J23
- All models: J24
- M553n/dn and M552dn: J25 (this is the wireless connector for the M553x model)

- All models: J57
- All models: J98 (this connector is empty unless the optional trusted platform module (TPM) is installed)



 **IMPORTANT:** The flat-cable connector (callout 2) is a Zero Insertion Force (ZIF) connector that uses a hinged retainer to secure the flat cable. The hinged retainer must be opened to install the flat cable.

Figure 1-3774 Connect all connectors

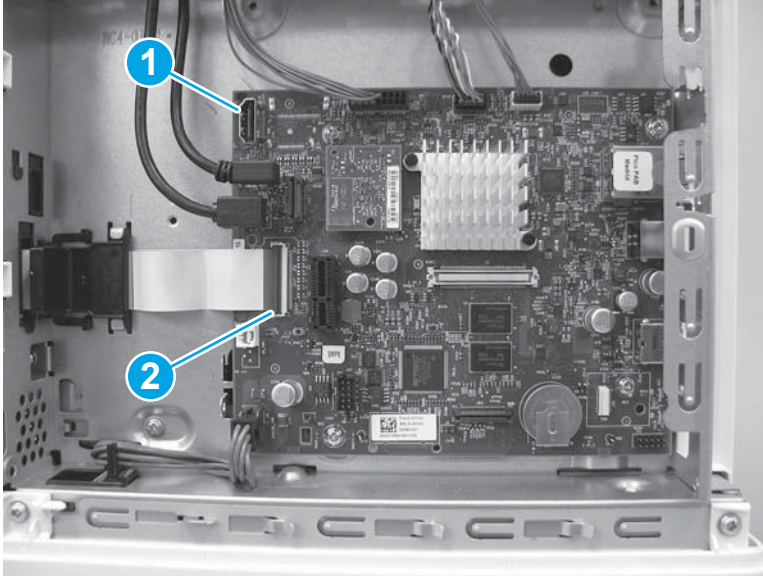

Step 50: Install the control-panel assembly (M553x only)

 **NOTE:** This step is for the M553x model. For the M553n/dn and M552dn models, skip this step and go to [Step 51: Install the USB cover \(M552 and M553\) on page 2115](#).

For the M577 models, skip this step and go to [Step 52: Install the formatter cover on page 2116](#).

1. Place the control panel on the printer as shown.

Figure 1-3775 Place the control panel on the product

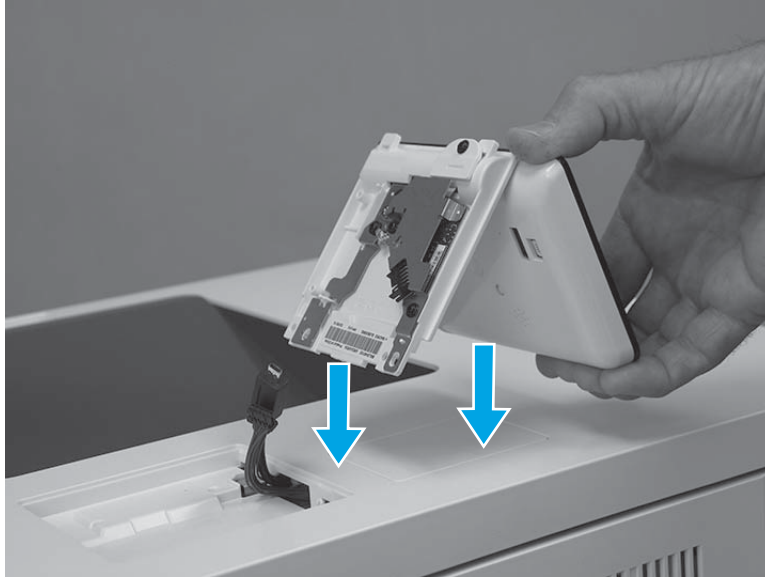

2. Connect one USB cable (callout 1), and one connector (callout 2).

 **IMPORTANT:** Take note of the location of the two mounting tabs (callout 3) on the control-panel assembly.

Figure 1-3776 Connect two connectors



3. Turn the control panel over, and then position the front edge tabs in the slots in the top cover.

Figure 1-3777 Turn the control panel over

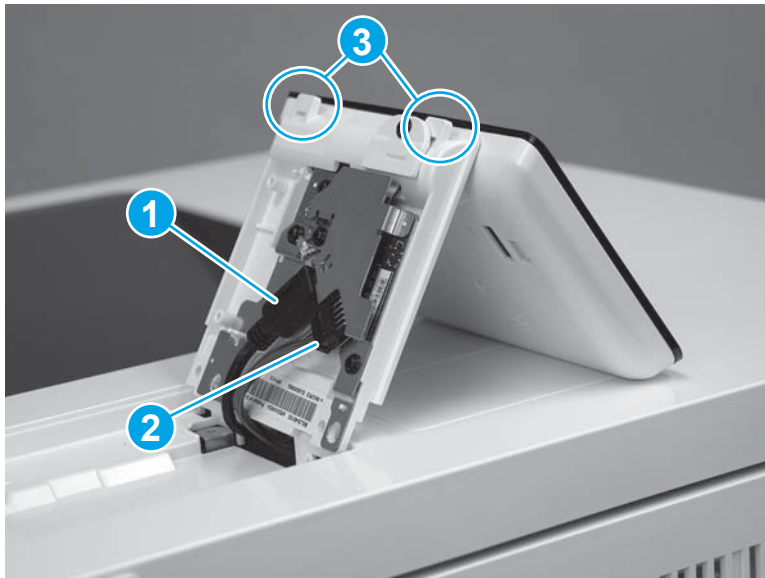
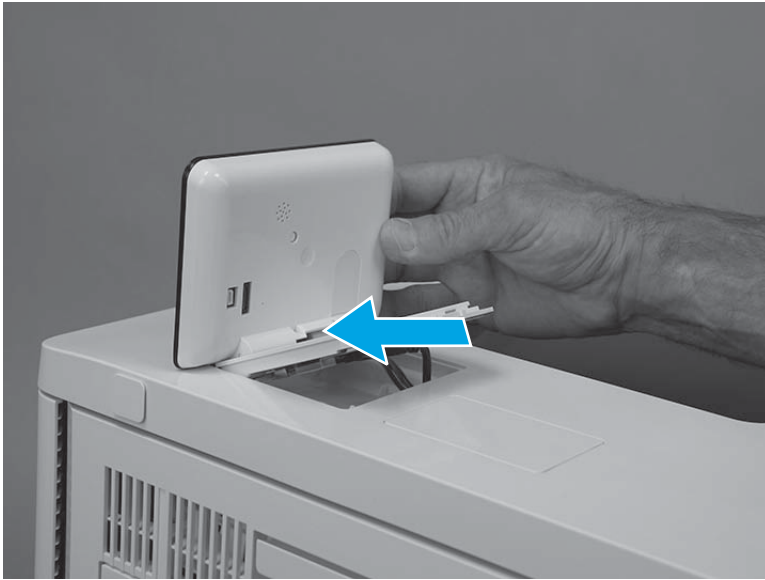

4. Rotate the control-panel base down onto the printer.

Figure 1-3778 Rotate the control-panel base down



5. Use a small Phillips screwdriver to install two screws (callout 1).

Figure 1-3779 Install two screws

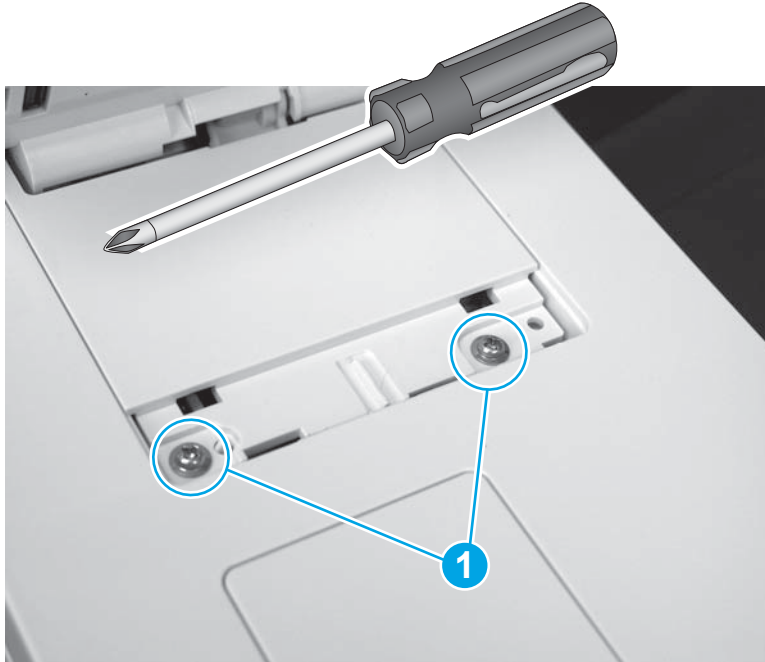

6. Position the screw cover mounting feet into the slots in the top cover (callout 1), and then rotate the cover down (callout 2) to install it.

 **NOTE:** Press down on the cover firmly to make sure that the tabs on the cover (callout 3) snap into place.

Figure 1-3780 Install the cover



Step 51: Install the USB cover (M552 and M553)

 **NOTE:** This step is for the M552 and M553 models. For the M577 models, skip this step and go to [Step 52: Install the formatter cover on page 2116](#).

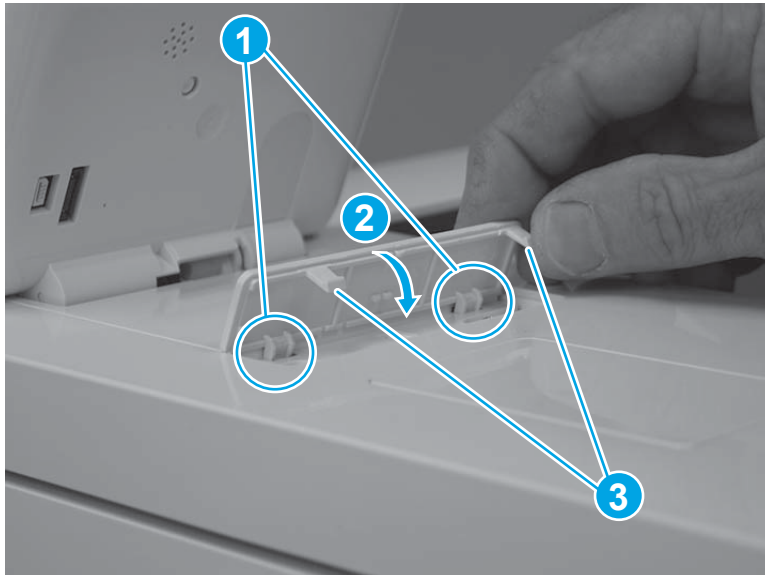
1. Push the cover into the USB port to install it.

Figure 1-3781 Install the cover



2. Make sure that the USB cover is fully seated after installing it.

Figure 1-3782 Check the installation



Step 52: Install the formatter cover

- ▲ Slide the cover onto the printer (callout 1) to install it.

 **NOTE:** Make sure that the tabs on the formatter cover align with the slots provided in the printer (callout 2). Tighten the two thumbscrews (callout 3).

 **TIP:** If needed, use the edge of a coin to turn the thumbscrews.

Figure 1-3783 Install the cover



Step 53: Install the TCU

1. Verify that the toner collection hatch cover is in the closed position on the TCU.

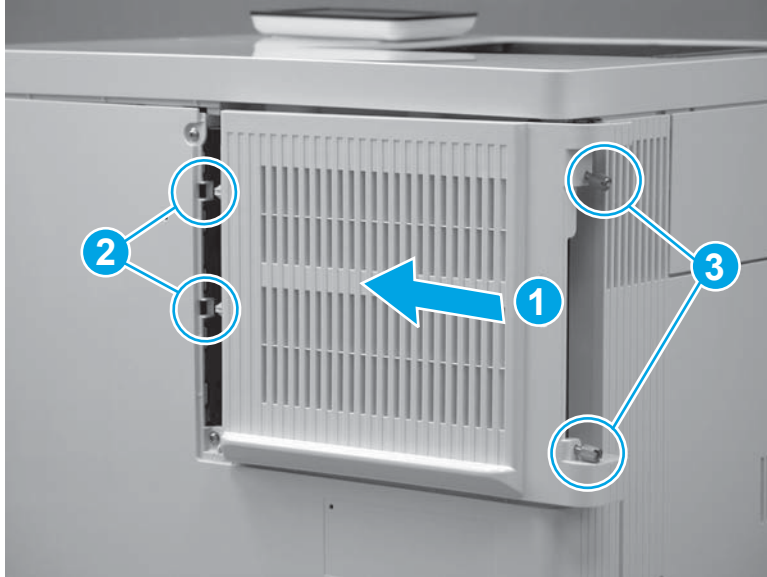
Figure 1-3784 Verify that the toner collection hatch cover is closed

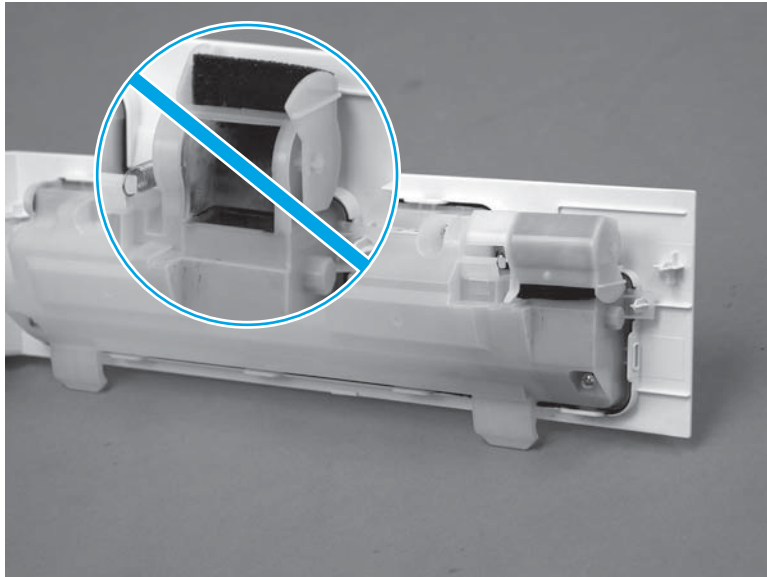

2. Position the TCU with the hinges in the slots provided in the printer (callout 1), and then rotate the TCU up and into the closed position.

 **NOTE:** The toner collection hatch cover automatically opens when the TCU is closed.

Figure 1-3785 Install the TCU



3. Close the front door.

Figure 1-3786 Close the front door

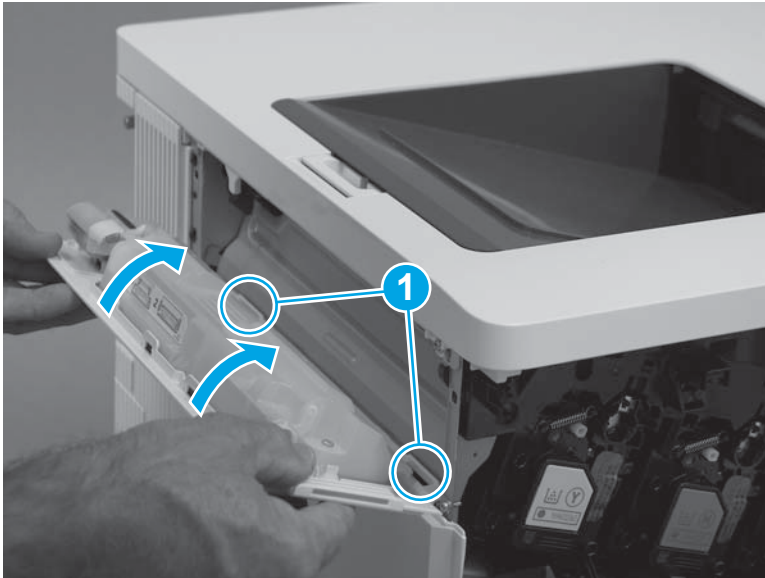

Removal and replacement: Registration assembly

- [Introduction](#)
- [Step 1: Remove the secondary transfer assembly](#)
- [Step 2: Remove the ITB](#)
- [Step 3: Remove the tray](#)
- [Step 4: Remove the toner collection unit \(TCU\)](#)
- [Step 5: Remove the formatter cover](#)
- [Step 6: Remove the USB cover \(M552 and M553\)](#)
- [Step 7: Remove the control panel \(M553x only\)](#)
- [Step 8: Remove the formatter \(M552 and M553\)](#)
- [Step 9: Remove the hard-disk drive \(HDD\) \(M577\)](#)
- [Step 10: Remove the fax PCA \(M577c/f/z\)](#)
- [Step 11: Remove the formatter \(M577\)](#)
- [Step 12: Remove the rear cover \(M552 and M553\)](#)
- [Step 13: Remove the rear upper cover \(M577\)](#)
- [Step 14: Remove the rear cover \(M577\)](#)
- [Step 15: Remove the left upper cover \(M577\)](#)
- [Step 16: Remove the right front upper cover \(M577dn\)](#)
- [Step 17: Remove the stapler cover assembly \(M577c/f/z\)](#)
- [Step 18: Remove the integrated scanner assembly \(ISA\) \(M577\)](#)
- [Step 19: Remove the right upper cover \(M577\)](#)
- [Step 20: Remove the left cover](#)
- [Step 21: Remove the upper cover \(M552 and M553\)](#)
- [Step 22: Remove the right rear cover](#)
- [Step 23: Remove the formatter case](#)
- [Step 24: Remove the low-voltage power supply \(LVPS\)](#)
- [Step 25: Remove the power supply fan \(FM1\)](#)
- [Step 26: Remove the high-voltage power supply D \(HVPSD\)](#)
- [Step 27: Remove the lifter drive assembly](#)
- [Step 28: Remove the DC controller and sheet-metal bracket](#)
- [Step 29: Remove the pickup drive assembly and motor \(M5\)](#)

- [Step 30: Remove the registration assembly](#)
- [Step 31: Unpack the replacement assembly](#)
- [Step 32: Install the registration assembly](#)
- [Step 33: Install the pickup drive assembly and motor \(M5\)](#)
- [Step 34: Install the DC controller and sheet-metal bracket](#)
- [Step 35: Install the lifter drive assembly](#)
- [Step 36: Install the HVPSD](#)
- [Step 37: Install the power-supply fan \(FM1\)](#)
- [Step 38: Install the LVPS](#)
- [Step 39: Install the formatter case](#)
- [Step 40: Install the right rear cover](#)
- [Step 41: Install the upper cover \(M552 and M553\)](#)
- [Step 42: Install the left cover](#)
- [Step 43: Install the right upper cover \(M577\)](#)
- [Step 44: Install the integrated scanner assembly \(ISA\) \(M577\)](#)
- [Step 45: Install the stapler cover assembly \(M577c/f/z\)](#)
- [Step 46: Install the right front upper cover \(M577dn\)](#)
- [Step 47: Install the left upper cover \(M577\)](#)
- [Step 48: Install the rear cover \(M577\)](#)
- [Step 49: Install the rear upper cover \(M577\)](#)
- [Step 50: Install the rear cover \(M552 and M553\)](#)
- [Step 51: Install the formatter \(M577\)](#)
- [Step 52: Install the fax PCA \(M577c/f/z\)](#)
- [Step 53: Install the HDD \(M577\)](#)
- [Step 54: Install the formatter \(M552 and M553\)](#)
- [Step 55: Install the control-panel assembly \(M553x only\)](#)
- [Step 56: Install the USB cover \(M552 and M553\)](#)
- [Step 57: Install the formatter cover](#)
- [Step 58: Install the TCU](#)
- [Step 59: Install the tray](#)
- [Step 60: Install the ITB](#)

- [Step 61: Install the secondary transfer roller assembly](#)

Introduction

This document provides the procedures to remove and replace the registration assembly.

Before performing service

 **TIP:** Some figures might show assemblies removed or installed that have not yet been removed or installed at that specific step. However, the procedures are correct for this printer and the target assembly. Always thoroughly read the instructions that accompany each figure.

Turn the printer power off

- Disconnect the power cable.

 **WARNING!** To avoid damage to the printer, turn the printer off, wait 30 seconds, and then remove the power cord before attempting to service the printer.

Use the table below to identify the correct part number for your printer, and then go to <http://h20141.www2.hp.com/hpparts> to order the part.

Registration assembly part number	
RM2-0093-000CN	Registration assembly (M553n)
RM20018-000CN	Registration assembly (M552dn, M553dn, M553x, M577)

Required tools

- #2 Phillips screwdriver with a magnetic tip

After performing service

Make sure that all of the connectors on the LVPS are fully seated.

Make sure that all of the connectors on the DC controller are fully seated.

Make sure that the TCU is fully closed after replacing it.

Make sure that all of the connectors on the formatter are fully seated.

Make sure that the formatter cover is fully seated, and that the thumbscrews are finger tight after replacing it.

Turn the printer power on

- Connect the power cable.
- Use the power switch to turn the power on.

Post service test

Print a configuration page to make sure that the printer is functioning correctly.

Step 1: Remove the secondary transfer assembly

1. Open the right door.

Figure 1-3787 Open the right door



2. Release the blue arm, and then let the secondary transfer assembly rotate down to the half-way open position.



NOTE: The assembly should stop at the halfway down point—the pin will stop at the notch in the slot in the blue arm.

Figure 1-3788 Release the secondary transfer roller assembly

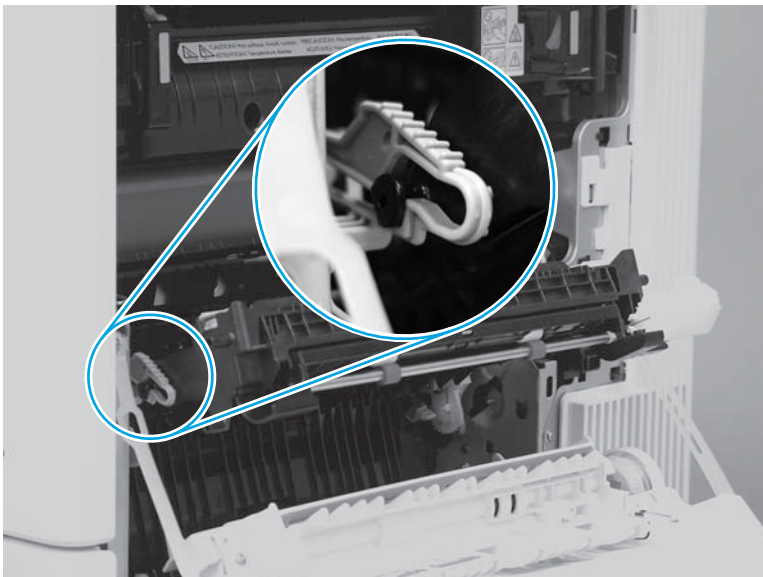

3. Carefully flex the top portion of the blue arm—as shown in the figure—to start to disengage it from the pin.

Figure 1-3789 Carefully flex the top portion of the blue arm



4. Continue to flex the blue arm until it disengages from the pin.

Figure 1-3790 Disengage the blue arm and pin



5. Slide the assembly toward the front of the printer to release it (callout 1), and then rotate it down and away from the printer to remove it (callout 2).

 **Reinstallation tip:** Before removing the assembly, take note of where the assembly hinge pins fit into the holes provided in the printer.

Figure 1-3791 Remove the secondary transfer roller assembly



Step 2: Remove the ITB

 **CAUTION:** Do not touch the grey-plastic belt. Skin oils and fingerprints on the belt can cause print-quality problems.

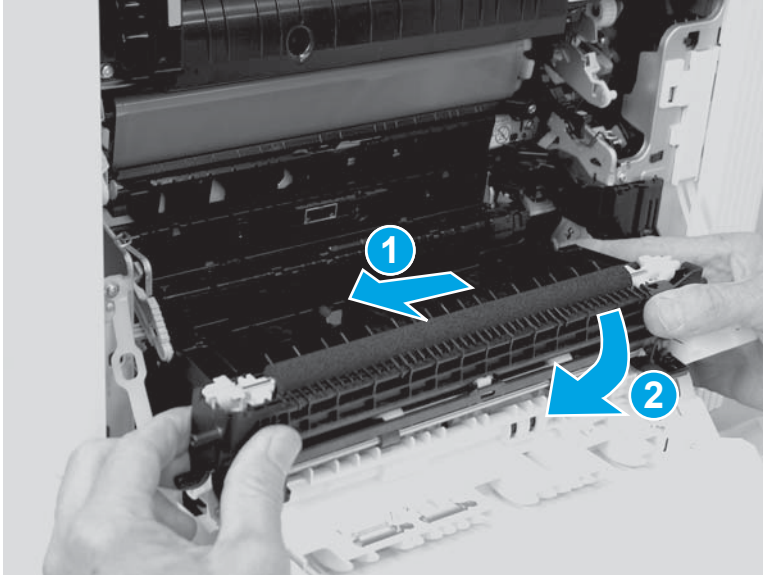
1. Open the right door.

Figure 1-3792 Open the right door



2. Pull the blue lever to release the ITB drive coupling.

Figure 1-3793 Release the ITB drive coupling

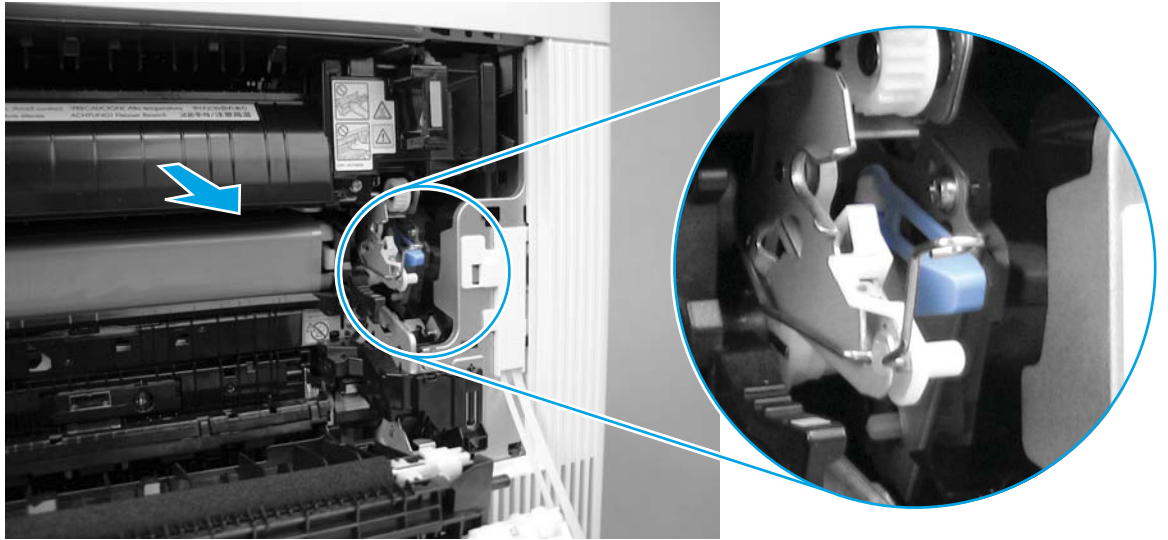

3. Push in on the blue arm to release the secondary transfer roller assembly, and then completely lower the assembly.

 **NOTE:** Press the blue arm on the secondary transfer roller assembly a second time to release the roller assembly when it stops at the halfway open position.

Figure 1-3794 Lower the secondary transfer roller assembly



4. Release the left-side ITB spring (callout 1) from the tab (callout 2).

Figure 1-3795 Release the front-side ITB spring

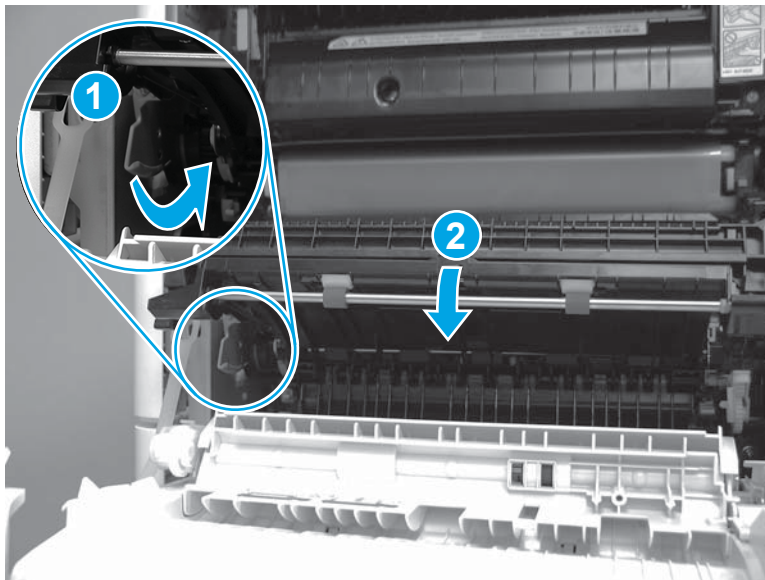
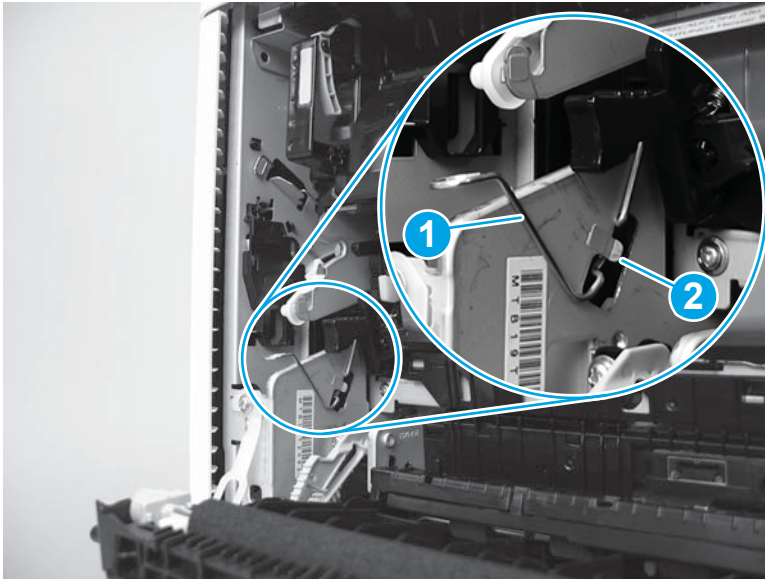

5. Place the left-side ITB spring on the holder to keep it out of the way.

 **TIP:** The holder is colored blue to help locate it.

Figure 1-3796 Place the spring on the holder

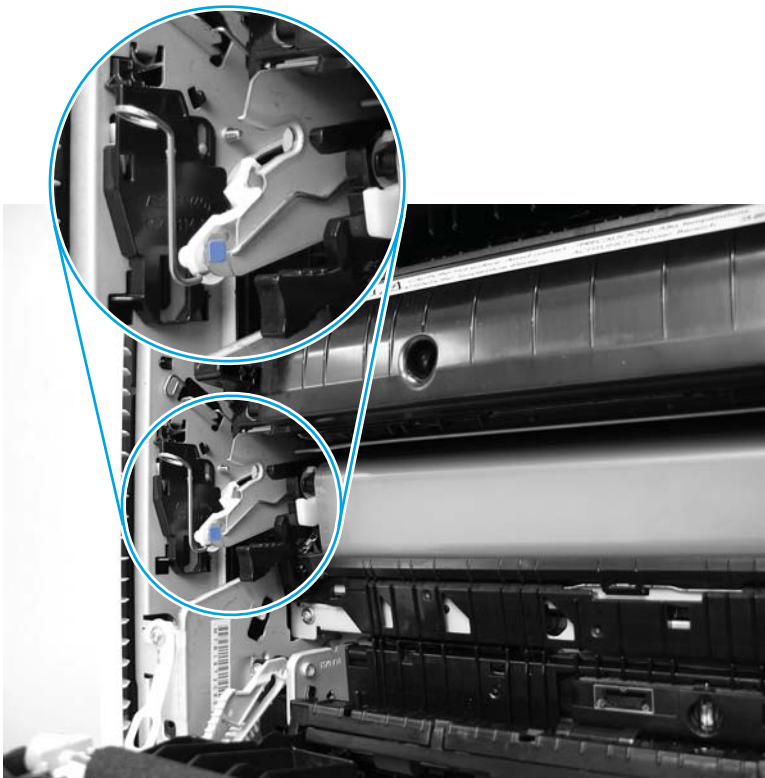

6. Release the right-side ITB spring (callout 1) from the tab (callout 2).

Figure 1-3797 Release the rear-side ITB spring

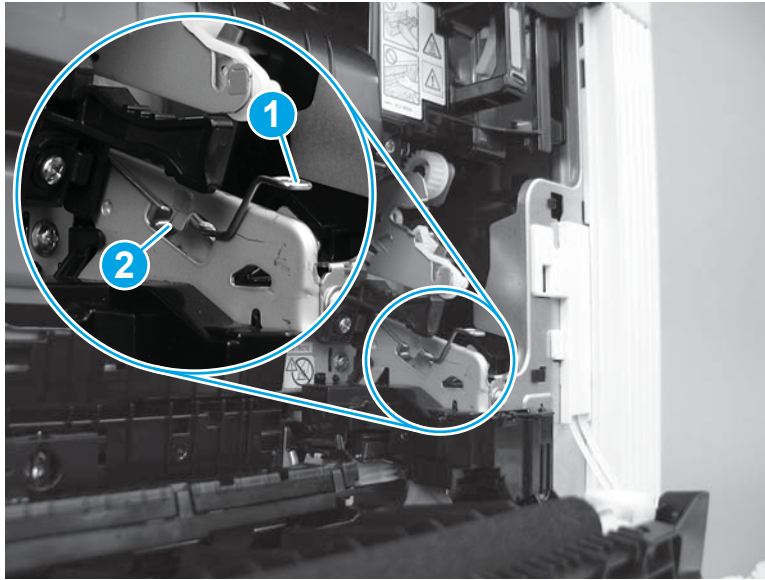

7. Place the right-side ITB spring on the holder to keep it out of the way.

 **TIP:** The holder is colored blue to help locate it.

Figure 1-3798 Place the spring on the holder

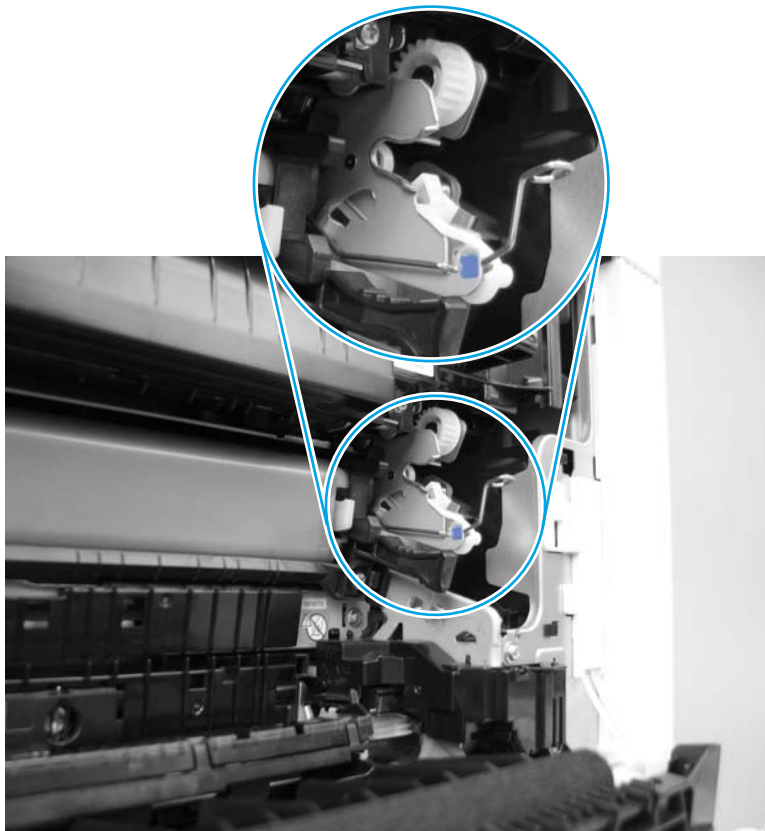

8. Grasp the two blue handles on the ITB.

⚠ CAUTION: If the ITB is removed to access other assemblies in the printer, use care. The ITB is a sensitive assembly. Be careful when handling the ITB so that it is not damaged. Always place the ITB in a safe and protected location.

Figure 1-3799 Grasp the ITB handles

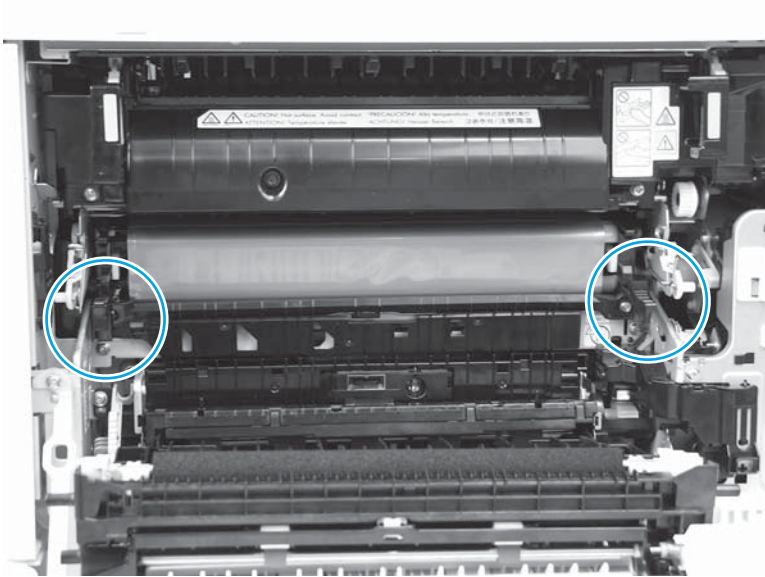

9. Pull the ITB out of the printer to remove it.

⚠ CAUTION: Do not touch the grey-plastic belt. Skin oils and fingerprints on the belt can cause print-quality problems.

Figure 1-3800 Remove the ITB

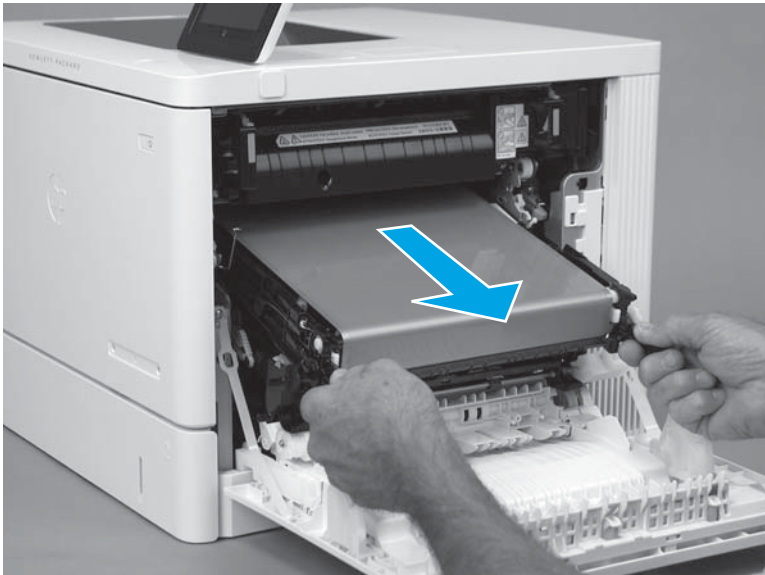

Step 3: Remove the tray

1. Pull the tray out until it stops.

Figure 1-3801 Pull the tray out



2. Lift the front of the tray, and then pull it out of the printer to remove it.

Figure 1-3802 Remove the tray

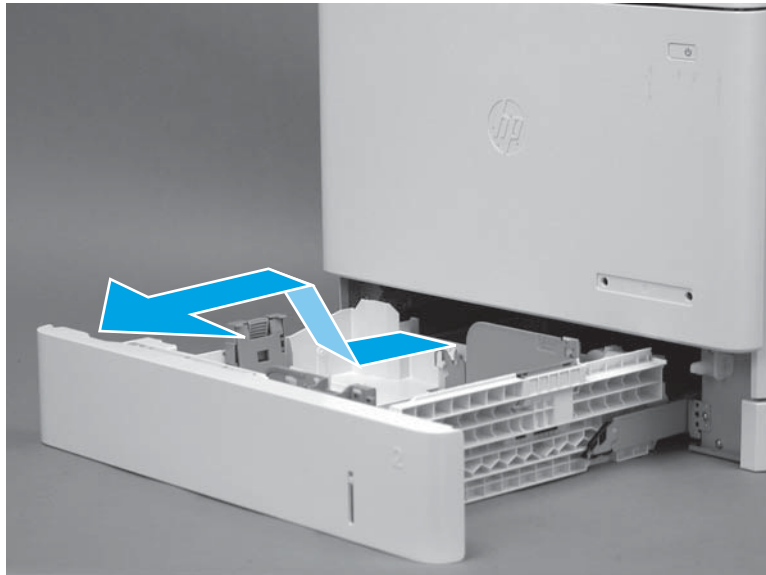

Step 4: Remove the toner collection unit (TCU)

1. Open the front door.

Figure 1-3803 Open the front door



2. Open the TCU.



NOTE: The toner collection hatch cover automatically closes when the TCU is opened.

Figure 1-3804 Open the TCU



3. Pull the TCU away from the printer at an angle to remove it.

CAUTION: Do not open the toner collection hatch cover when handling the TCU. If toner gets on clothing, wipe it off by using a dry cloth and wash the clothes in cold water. Hot water sets toner into fabric.

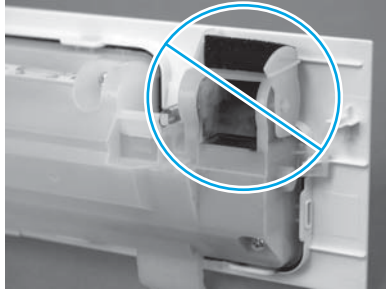
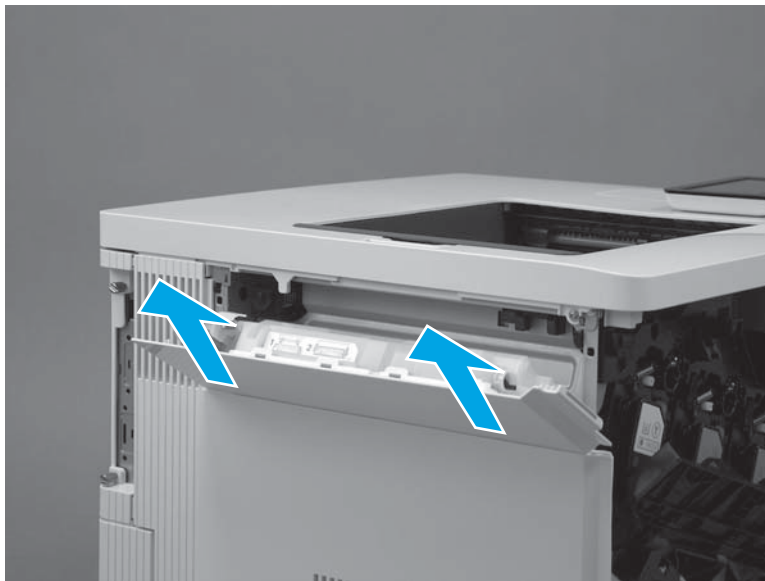

Figure 1-3805 Remove the TCU



Step 5: Remove the formatter cover

1. Locate the formatter cover.

Figure 1-3806 Locate the formatter cover

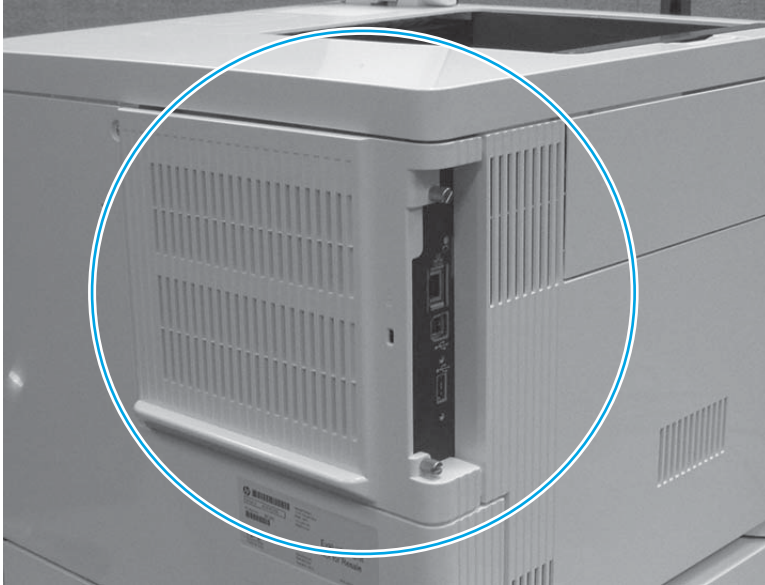

2. Loosen the two thumbscrews (callout 1). Grasp the two thumbscrews, and then slide the cover away from the printer (callout 2) to remove it.

 **TIP:** If needed, use the edge of a coin to turn the thumbscrews.

Figure 1-3807 Loosen the thumbscrews



Step 6: Remove the USB cover (M552 and M553)

 **NOTE:** This step is for the M552 and M553 models. For the M577 models, skip this step and go to [Step 9: Remove the hard-disk drive \(HDD\) \(M577\) on page 2138.](#)

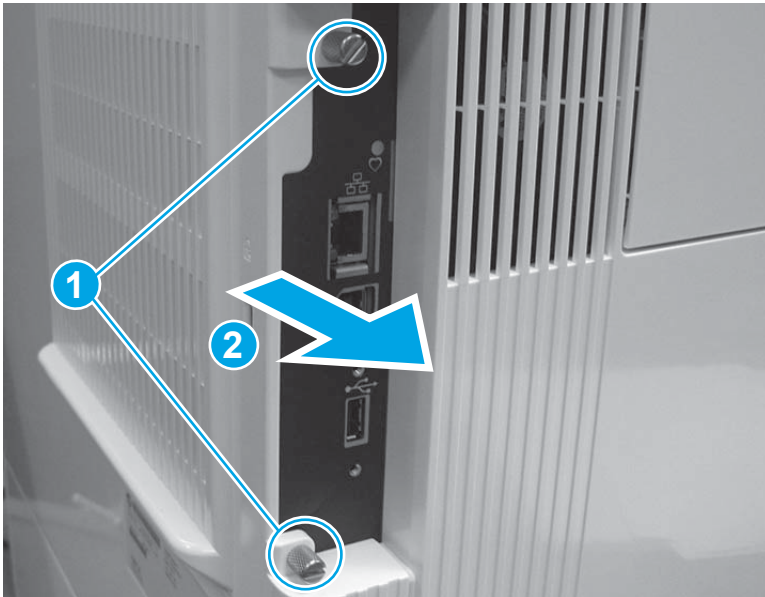
1. Locate the USB cover.

Figure 1-3808 Locate the USB cover



2. Pull the cover off of the printer to remove it.

Figure 1-3809 Remove the cover



Step 7: Remove the control panel (M553x only)

 **NOTE:** For the M553n/dn and M552dn models, skip this step and go to [Step 8: Remove the formatter \(M552 and M553\) on page 2137](#).

For the M577 models, skip this step and go to [Step 9: Remove the hard-disk drive \(HDD\) \(M577\) on page 2138](#).

1. Tilt the control panel up.

Figure 1-3810 Tilt the control panel up



2. Use a small flat-blade screwdriver to release the control-panel screws cover tabs.

Figure 1-3811 Release the control-panel screws cover tabs



3. Rotate the cover up to remove it.

Figure 1-3812 Remove the cover



4. Use a small Phillips screwdriver to remove two screws (callout 1).

 **IMPORTANT:** Store the screws in a secure place where they cannot fall down into the printer.

Figure 1-3813 Remove two screws



5. Rotate the control-panel base toward the front of the printer.

Figure 1-3814 Rotate the control-panel base up

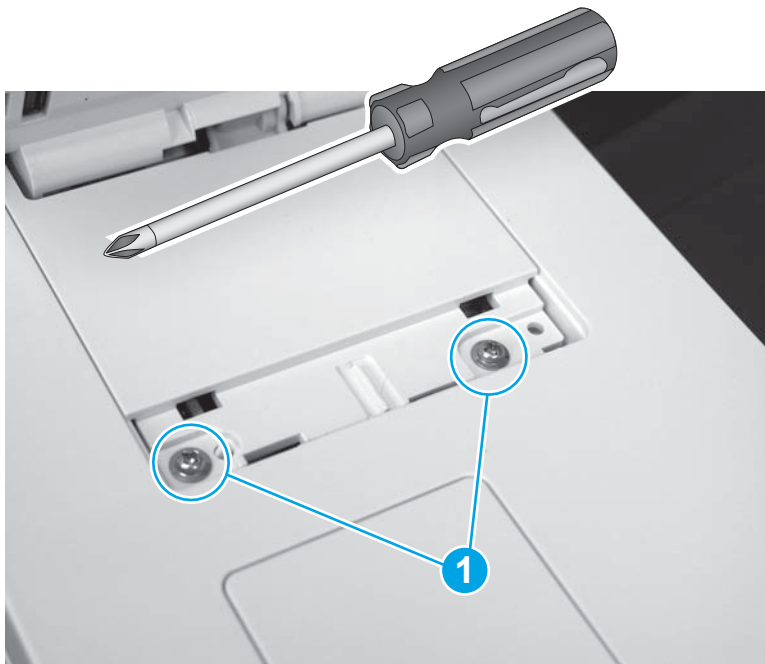

6. Slightly slide the control-panel base toward the rear of the printer (callout 1) to release it, and then turn the control panel over (callout 2) to access the bottom side.

CAUTION: The control panel is still attached to the printer. Do not attempt to completely remove the control panel.

Figure 1-3815 Turn the control panel over

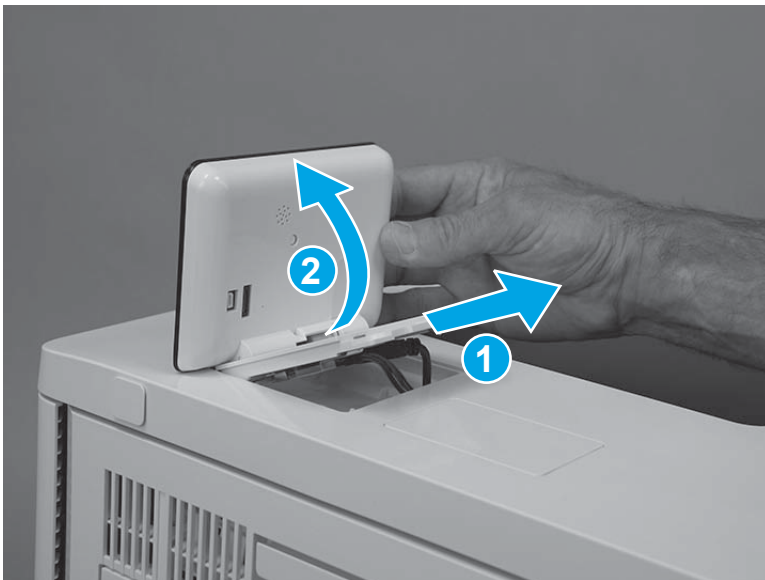

7. Disconnect one USB cable (callout 1), one connector (callout 2), and then remove the control panel.

Figure 1-3816 Disconnect two connectors

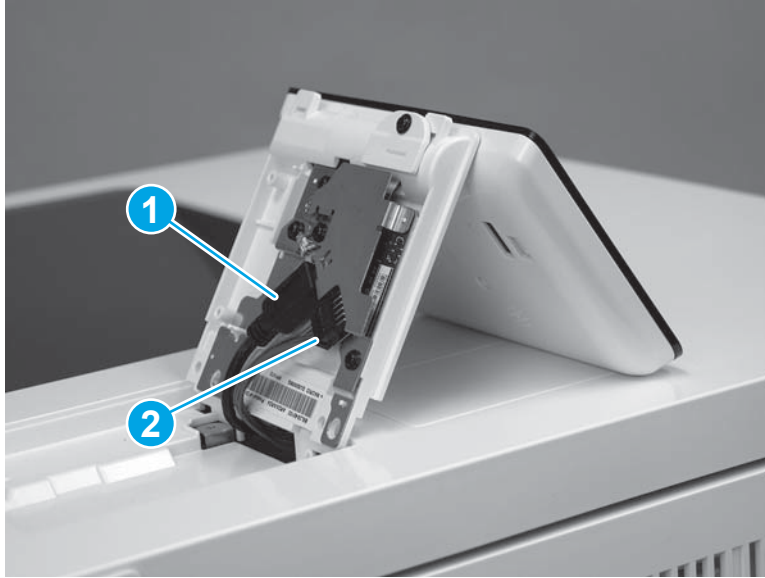

Step 8: Remove the formatter (M552 and M553)



NOTE: This step is for the M552 and M553 models. For the M577 models, skip this step and go to [Step 9: Remove the hard-disk drive \(HDD\) \(M577\) on page 2138](#).

If the optional hard-disk drive (HDD) is installed, it must be removed to gain access to the formatter mounting screws.

Release two tabs along the left edge of the HDD, rotate the left edge away from the product, and then slide the HDD to the left to remove it.



CAUTION:  ESD-sensitive part.

1. Disconnect all of the connectors on the formatter.

The following connectors are empty:

- All models: J1 (this connector is empty unless the optional DIMM is installed)
- M553n/dn and M552dn: J2 (callout 1; this is the touchscreen connector for the M553x model)
- All models: J9 (this connector is empty unless the optional internal USB ports component is installed)
- All models: J18 (this connector is empty unless the optional hard-disk-drive (HDD) is installed)
- All models: J23
- All models: J24
- M553n/dn and M552dn: J25 (this is the wireless connector for the M553x model)

- All models: J57
- All models: J98 (this connector is empty unless the optional trusted platform module (TPM) is installed)

 **IMPORTANT:** The flat-cable connector (callout 2) is a Zero Insertion Force (ZIF) connector that uses a hinged retainer to secure the flat cable. The hinged retainer must be opened to release the flat cable.

Figure 1-3817 Disconnect all connectors



2. Remove four screws (callout 1), and then remove the formatter.

Figure 1-3818 Remove the formatter

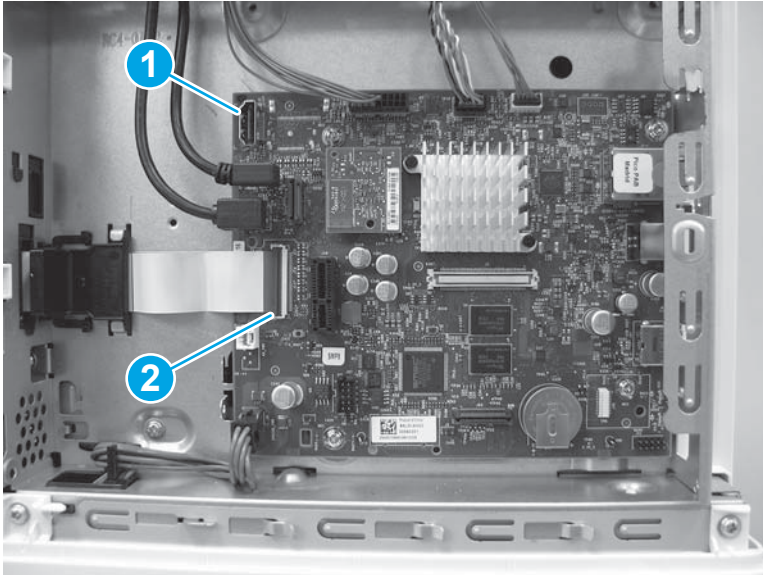
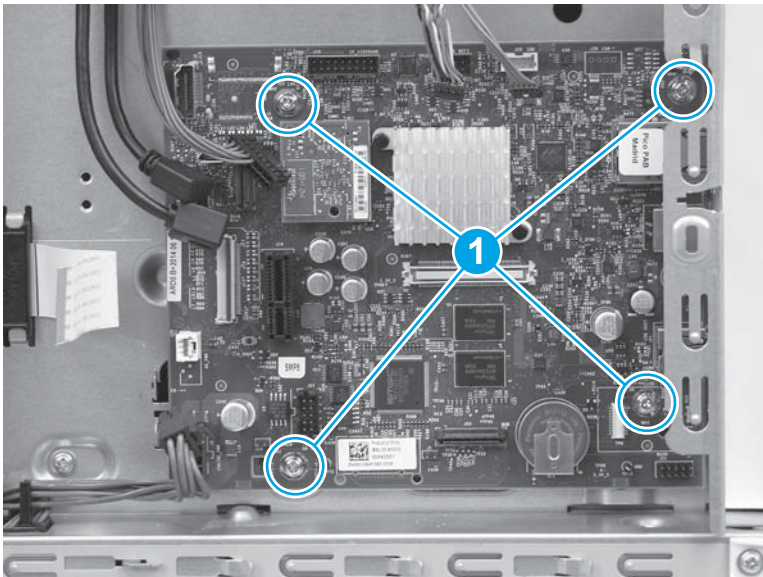

Step 9: Remove the hard-disk drive (HDD) (M577)

 **NOTE:** This step is for the M577 models. For the M552 and M553 models, skip this step and go to [Step 12: Remove the rear cover \(M552 and M553\)](#) on page 2143.

 **CAUTION:**  ESD-sensitive part.

1. Release two tabs (callout 1). Hold the tabs in the released position, and then rotate the hard disk drive (HDD) up (callout 2) to release the connector from the formatter.

Figure 1-3819 Release the HDD

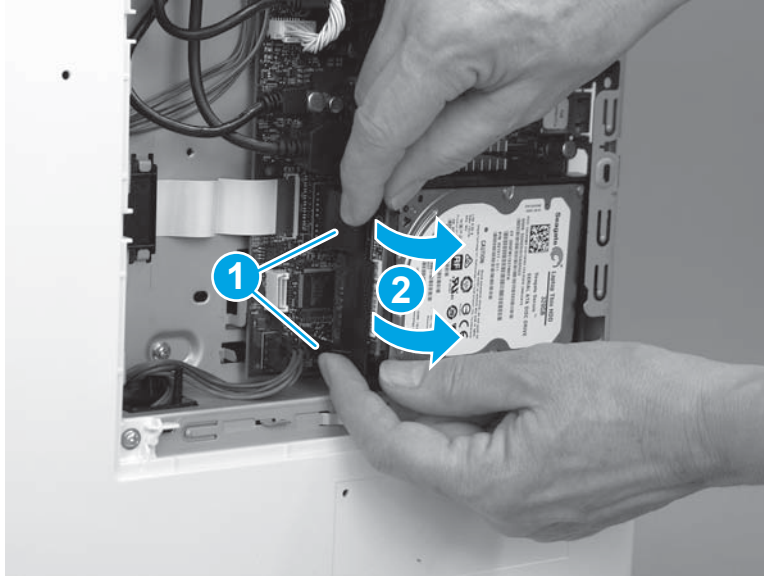

2. Slide the HDD away from the printer to remove it.

Figure 1-3820 Remove the HDD

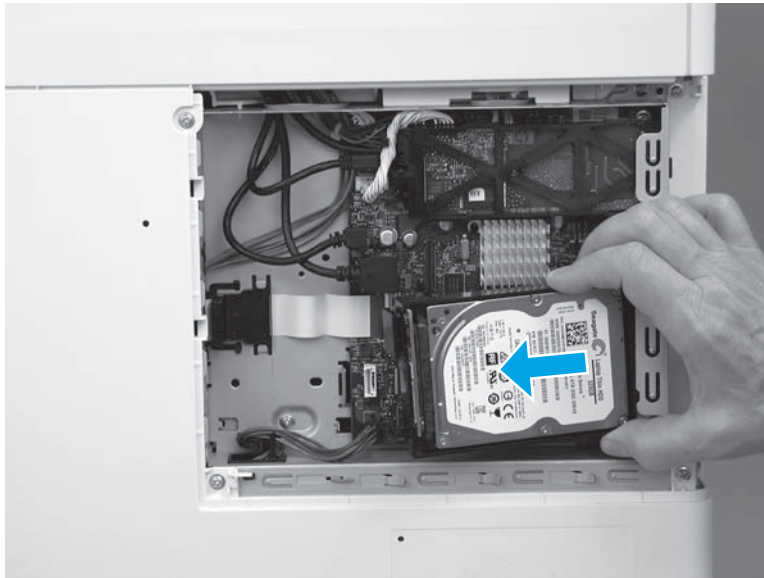

Step 10: Remove the fax PCA (M577c/f/z)

 **NOTE:** This step is for the M577c/f/z models. For the M577n model, skip this step and go to [Step 11: Remove the formatter \(M577\) on page 2141.](#)

For the M552 and M553 models, skip this step and go to [Step 12: Remove the rear cover \(M552 and M553\) on page 2143.](#)

 **CAUTION:**  ESD-sensitive part.

1. Locate the fax PCA component on the formatter.

Figure 1-3821 Locate the fax PCA

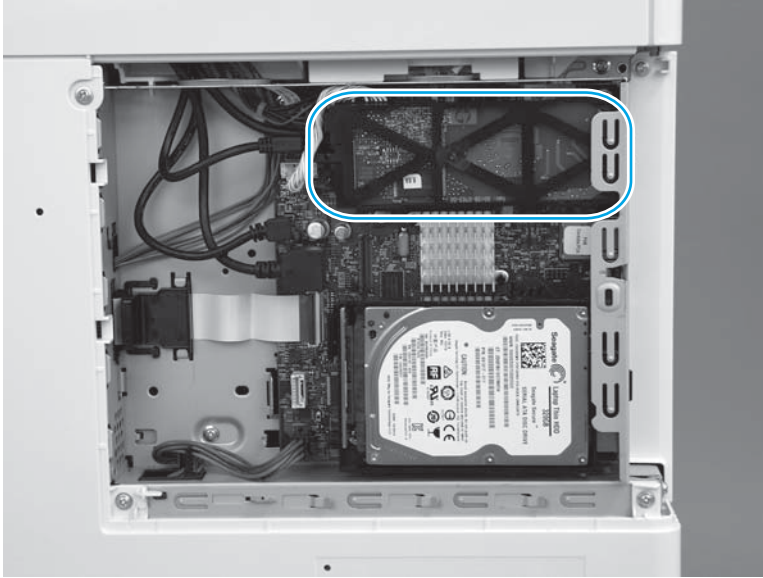

2. Release the connector latch (callout 1), and then pull the connector away from the formatter (callout 2) to disconnect it.

Figure 1-3822 Disconnect one connector

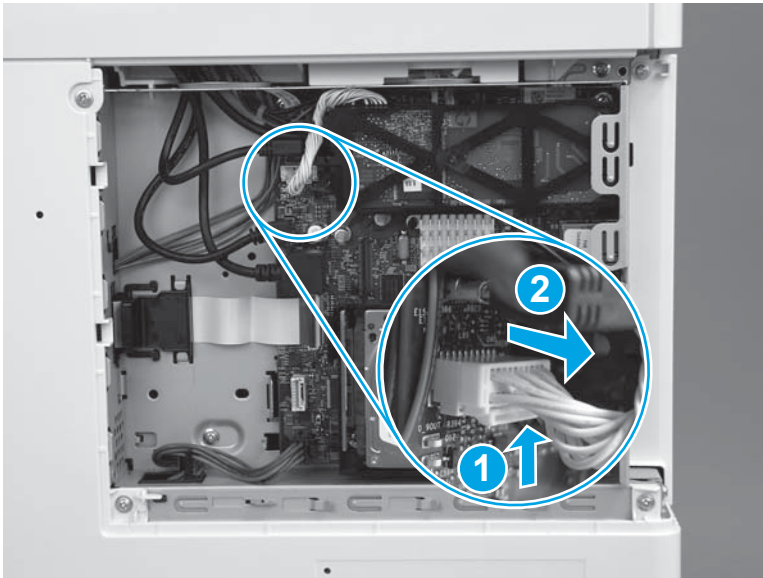

3. Release one retainer (callout 1) by pressing the bracket arms together.

Figure 1-3823 Release one latch

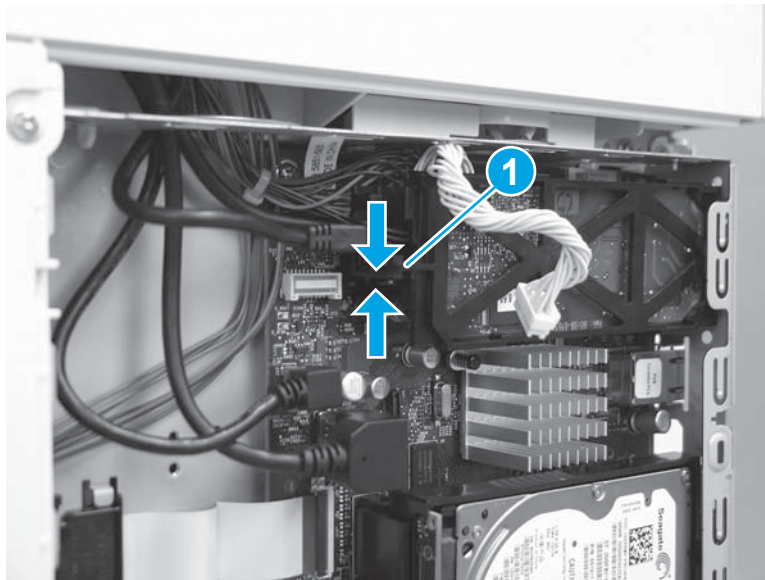

4. Rotate the end of the fax PCA (callout 1) away from the formatter, and then slide the PCA left (callout 2) to remove it.

Figure 1-3824 Remove the fax PCA

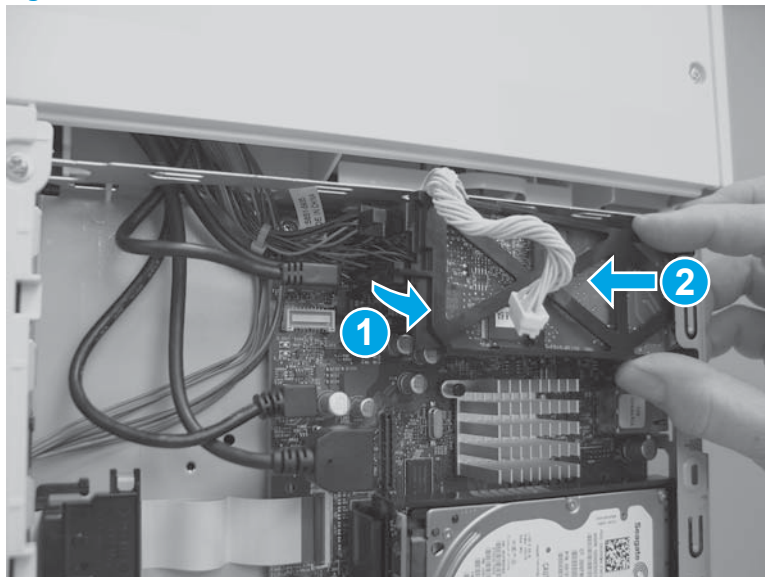

Step 11: Remove the formatter (M577)

 **NOTE:** This step is for the M577 models. For the M552 and M553 models, skip this step and go to [Step 12: Remove the rear cover \(M552 and M553\) on page 2143.](#)

 **CAUTION:**  ESD-sensitive part.

1. Disconnect all of the connectors on the formatter.

The following connectors are empty:

- All models: J1 (this connector is empty unless the optional DIMM is installed)
- All models: J3
- M577dn: J15 (this is the fax connector for the M577f/z/c models)
- All models: J21 (this connector is empty unless the optional internal USB ports component is installed)
- All models: J23
- All models: J24
- All models: J51
- All models: J57
- All models: J97
- All models: J98 (this connector is empty unless the optional trusted platform module (TPM) is installed)

 **IMPORTANT:** The flat-cable connector (callout 1) is a Zero Insertion Force (ZIF) connector that uses a hinged retainer to secure the flat cable. The hinged retainer must be opened to release the flat cable.

Figure 1-3825 Disconnect all connectors



2. Remove four screws (callout 1).

Figure 1-3826 Remove four screws

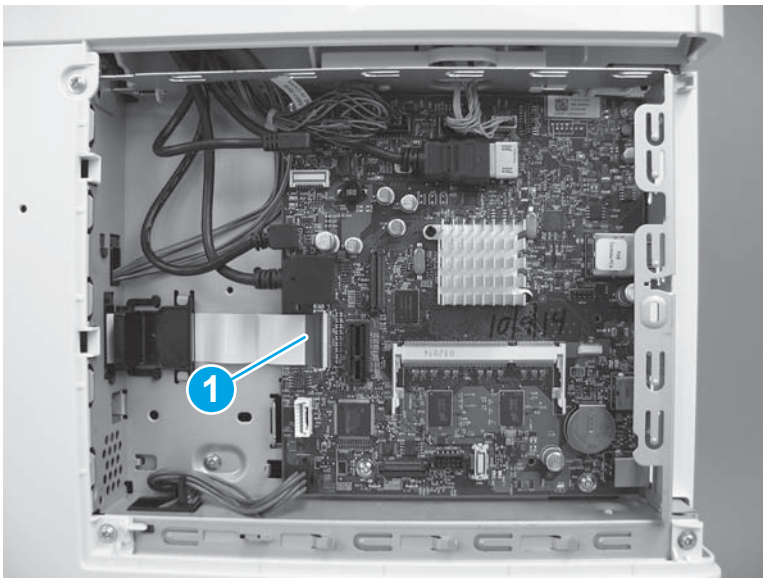
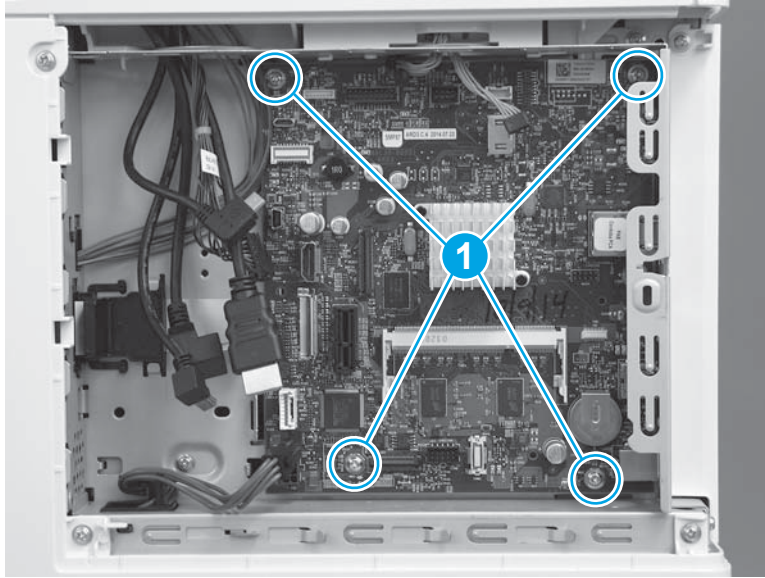

3. Remove the formatter.

Figure 1-3827 Remove the formatter

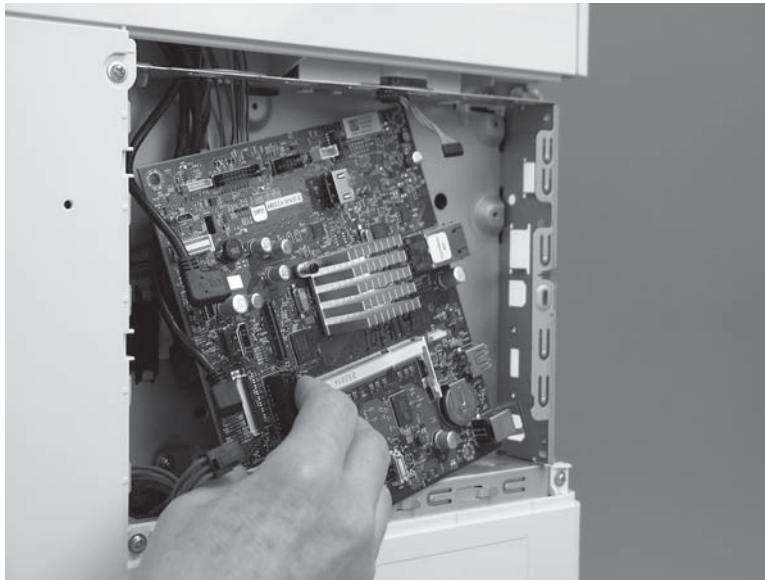

Step 12: Remove the rear cover (M552 and M553)

 **NOTE:** This step is for the M552 and M553 models. For the M577 models, skip this step and go to [Step 13: Remove the rear upper cover \(M577\) on page 2144.](#)

1. Remove four screws (callout 1).

Figure 1-3828 Remove four screws

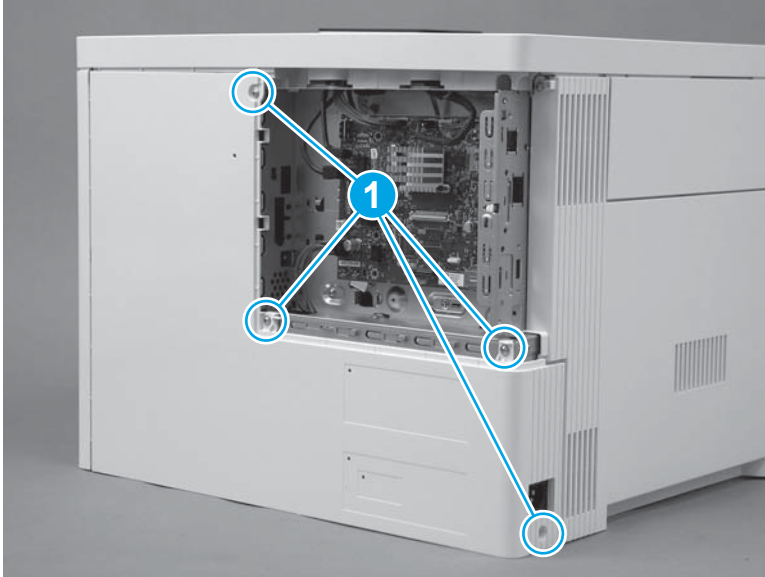

2. Slightly slide the cover to the right (callout 1), rotate the bottom of the cover away from the printer (callout 2), and then pull the top of the cover away from the printer (callout 3) to remove the cover.

Figure 1-3829 Remove the cover

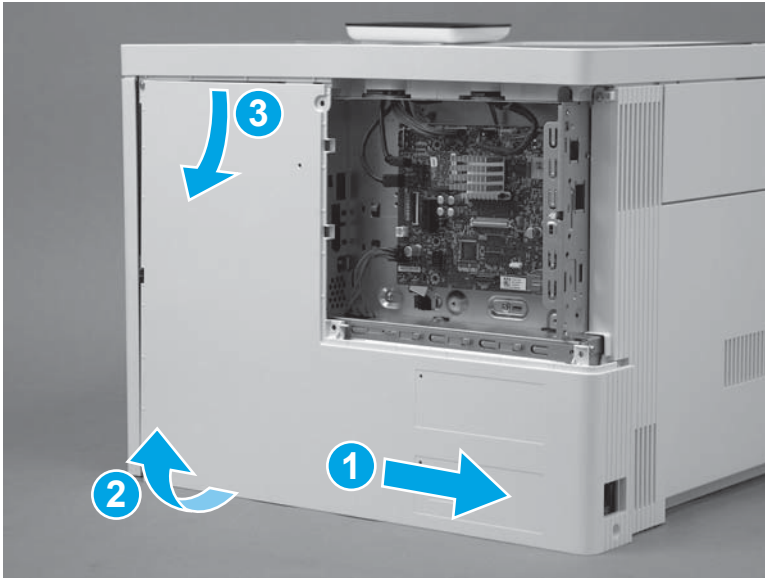

Step 13: Remove the rear upper cover (M577)



NOTE: This step is for the M577 models. For the M552 and M553 models, skip this step and go to [Step 20: Remove the left cover on page 2157](#).

1. Remove two screws (callout 1).



Reinstallation tip: These two screws are self-tapping screws for plastic. When reinstalling them, rotate the screws counterclockwise to align them with the existing thread pattern, and then carefully turn them clockwise to tighten. Do not overtighten. This will prevent stripping the threads inside the screw holes.

Figure 1-3830 Remove two screws

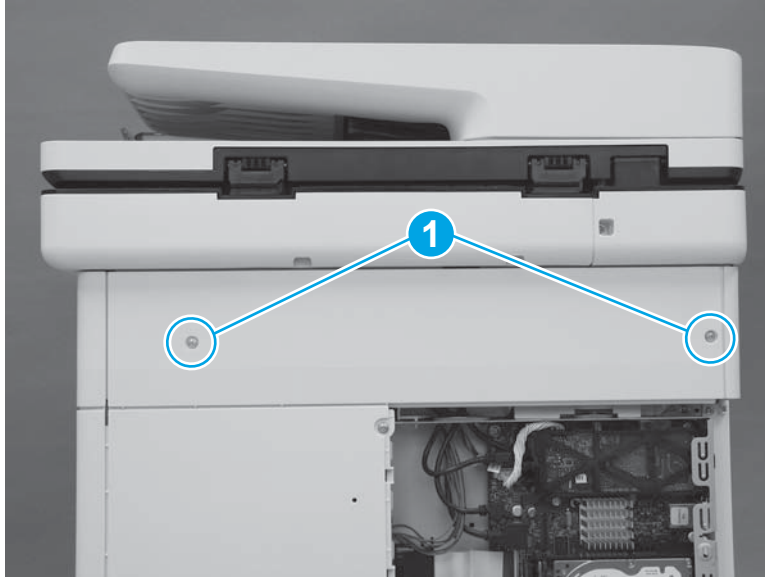

2. Use a small, flat blade screwdriver to release the right edge of the cover.

Figure 1-3831 Release the right edge

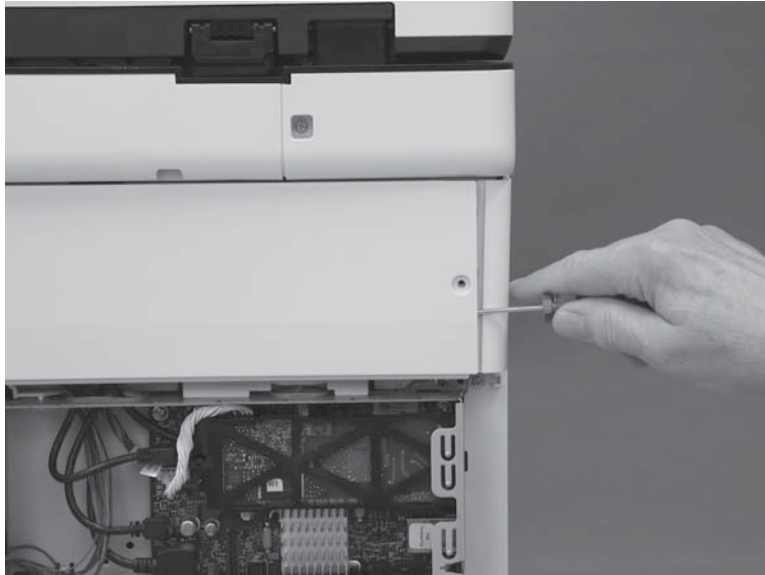

3. Pull the right edge of the cover (callout 1) away from the printer, and then slide the cover to the right (callout 2).

Figure 1-3832 Slide the cover right

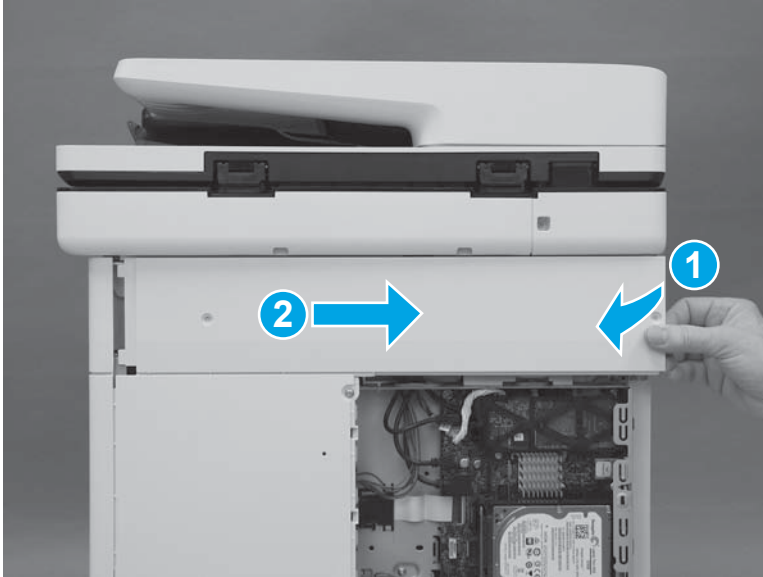

4. Remove the cover.

Figure 1-3833 Remove the cover

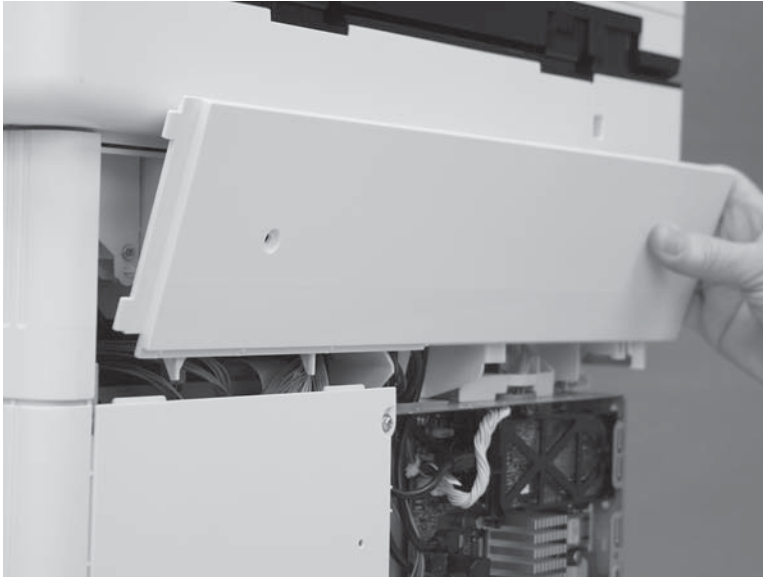

Step 14: Remove the rear cover (M577)



NOTE: This step is for the M577 models. For the M552 and M553 models, skip this step and go to [Step 20: Remove the left cover on page 2157](#).

1. Remove four screws (callout 1).

Figure 1-3834 Remove four screws

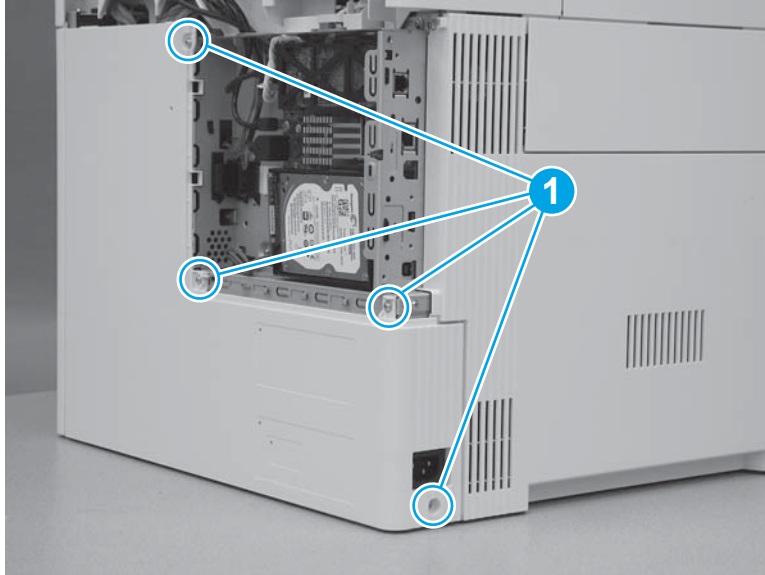

2. Slide the cover to the right to remove it.

Figure 1-3835 Remove the cover

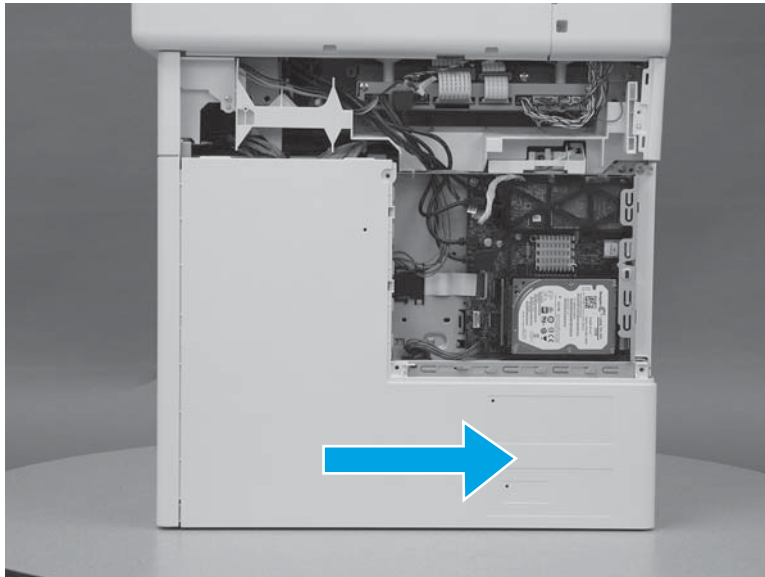

Step 15: Remove the left upper cover (M577)



NOTE: This step is for the M577 models. For the M552 and M553 models, skip this step and go to [Step 20: Remove the left cover on page 2157](#).

1. At the left side of the printer, release one tab (callout 1).

Figure 1-3836 Release one tab

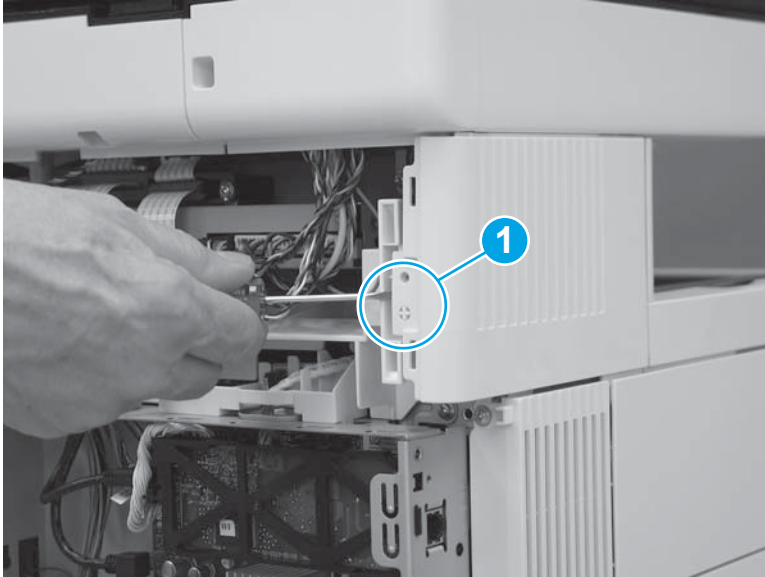

2. Slide the left upper cover toward the back of the printer.

Figure 1-3837 Slide the cover back

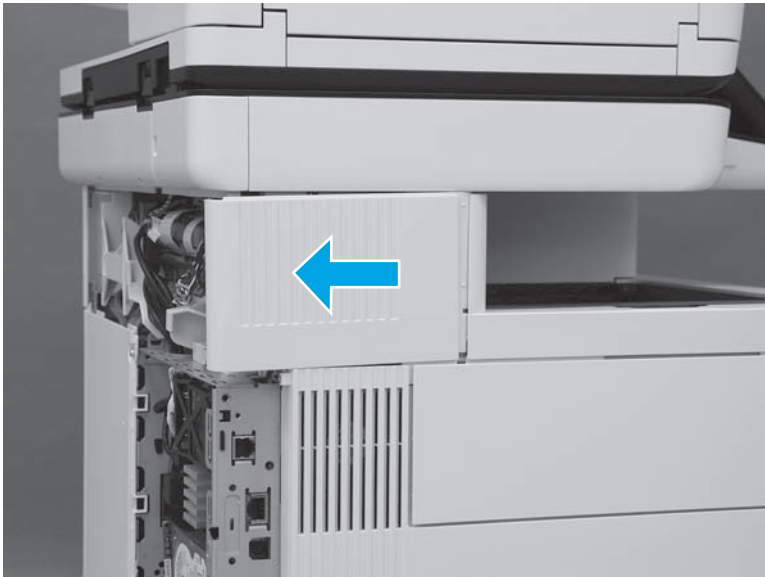

3. Rotate the cover up to remove it.

Figure 1-3838 Remove the left upper cover



Step 16: Remove the right front upper cover (M577dn)

 **NOTE:** This step is for the M577dn model. For the M577c/f/z models, skip this step and go to [Step 17: Remove the stapler cover assembly \(M577c/f/z\) on page 2150.](#)

For the M552 and M553 models, skip this step and go to [Step 20: Remove the left cover on page 2157.](#)

1. Remove one screw (callout 1).

Figure 1-3839 Remove one screw

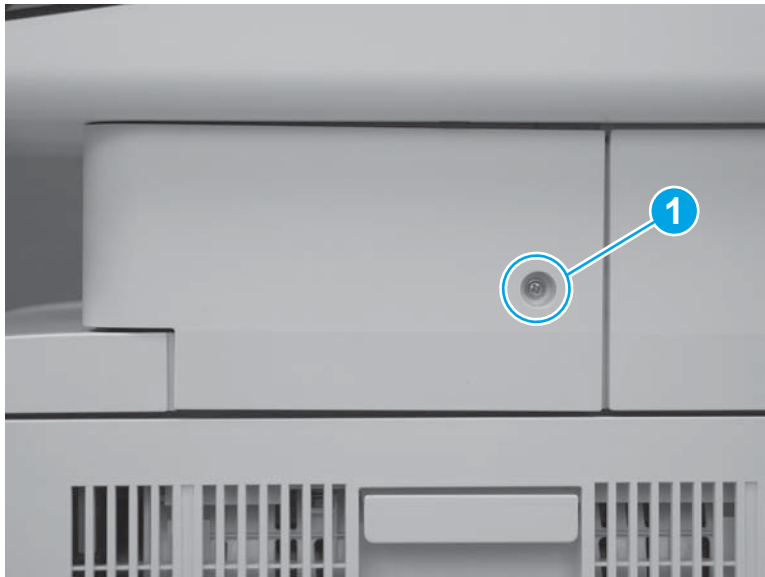

2. Release two tabs at the front edge of the cover (callout 1).

Figure 1-3840 Release two tabs



3. Rotate the front of the cover to the right to remove it.

Figure 1-3841 Rotate the cover



Step 17: Remove the stapler cover assembly (M577c/f/z)

 **NOTE:** This step is for the M577c/f/z models. For the M577dn model, skip this step and go to [Step 19: Remove the right upper cover \(M577\) on page 2155.](#)

For the M552 and M553 models, skip this step and go to [Step 20: Remove the left cover on page 2157.](#)

1. Remove one screw (callout 1).

 **Reinstallation tip:** This is a self-tapping screw for plastic. When reinstalling, rotate the screw counterclockwise to align it with the existing thread pattern, and then carefully turn it clockwise to tighten. Do not overtighten. This will prevent stripping the threads inside the screw hole.

Figure 1-3842 Remove one screw



2. Release two tabs at the front edge of the cover (callout 1).

Figure 1-3843 Release two tabs

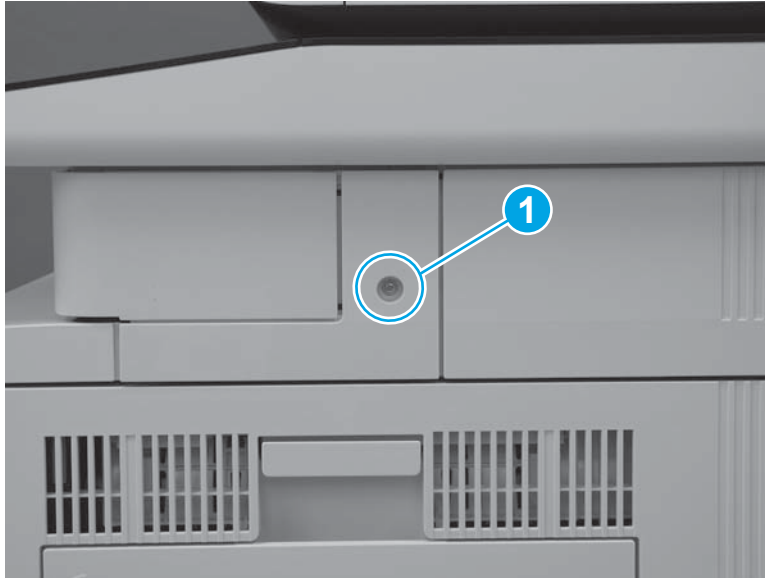

3. Release the back edge of the cover.

Figure 1-3844 Release the back edge of the cover

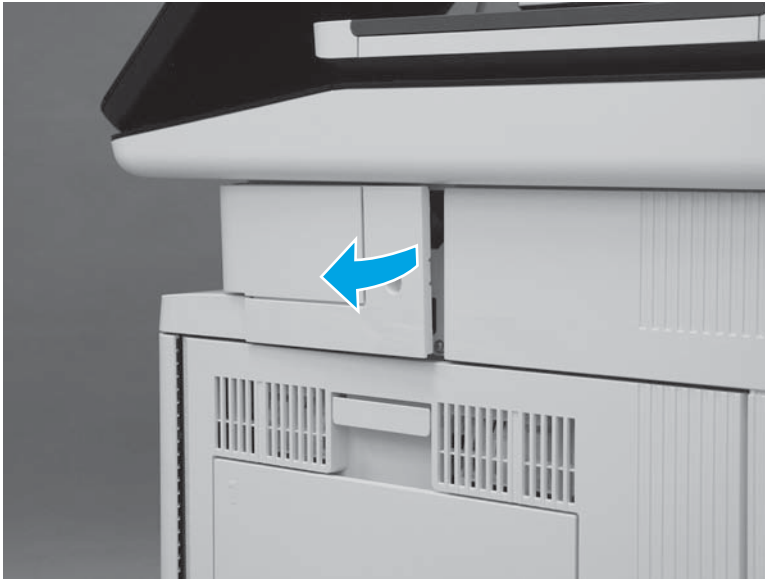



4. Rotate the cover away from the printer to remove it.

Figure 1-3845 Remove the cover



Step 18: Remove the integrated scanner assembly (ISA) (M577)

 **NOTE:** This step is for the M577 models. For the M552 and M553 models, skip this step and go to [Step 20: Remove the left cover on page 2157](#).

 **NOTE:** The ISA includes the document feeder, image scanner, scanner control board (SCB), control panel, keyboard (M577c/z) and NFC PCA (M577z).

1. At the left side of the printer, remove one screw (callout 1).

Figure 1-3846 Remove one screw

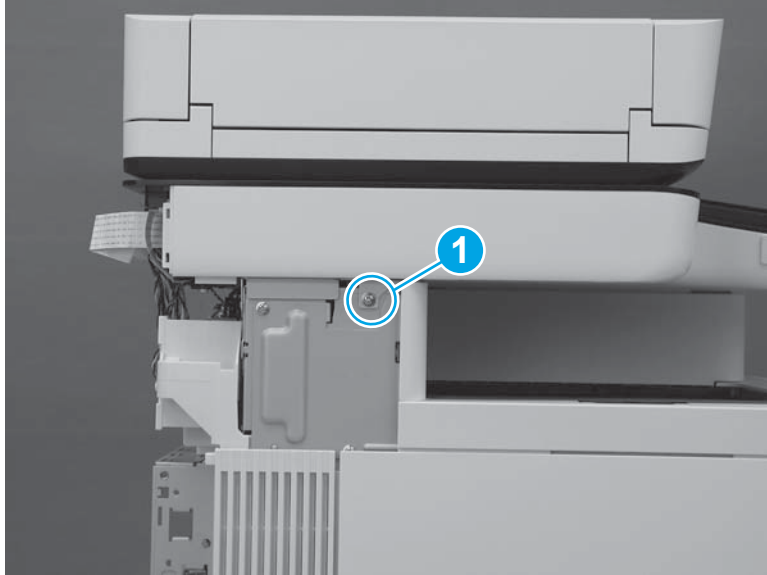

2. At the back side of the printer, remove two screws (callout 1).

Figure 1-3847 Remove two screws

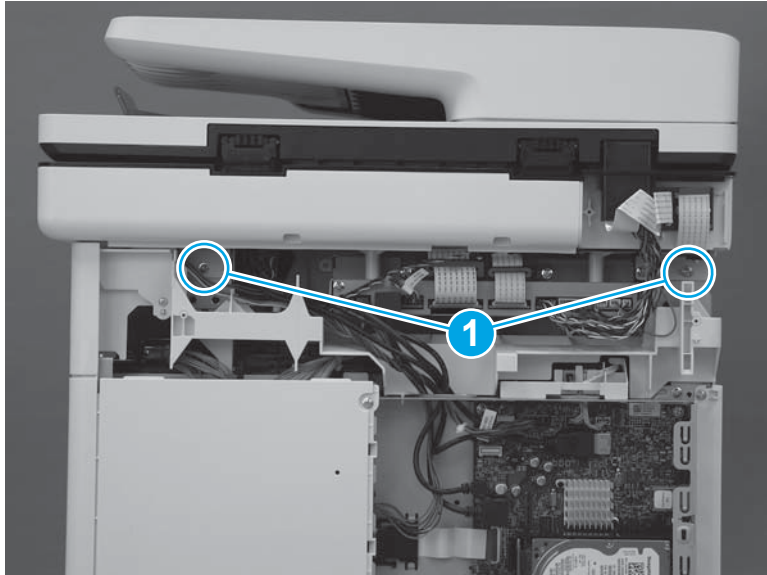

3. At the right side of the printer, remove one screw (callout 1).

Figure 1-3848 Remove one screw

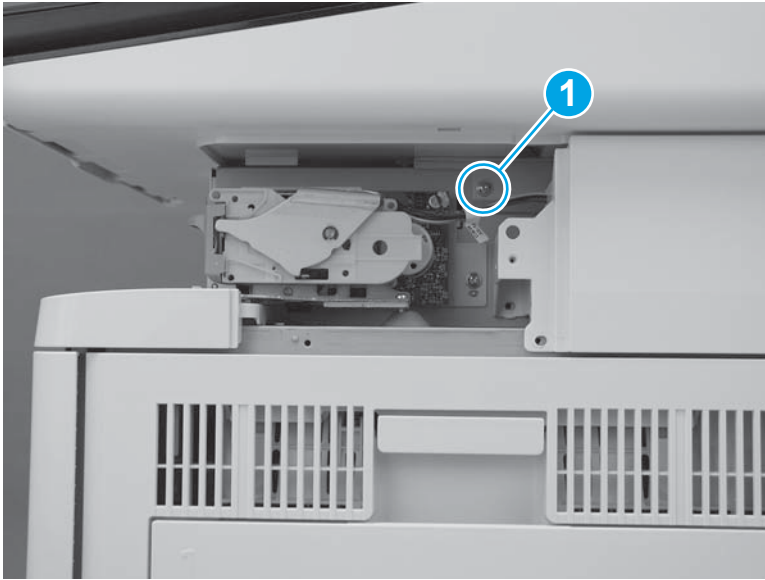

4. Disconnect two connectors on the scanner control board (callout 1).

M577c/f/z only: Disconnect one connector for the stapler on the scanner control board (callout 2).

Figure 1-3849 Disconnect connectors

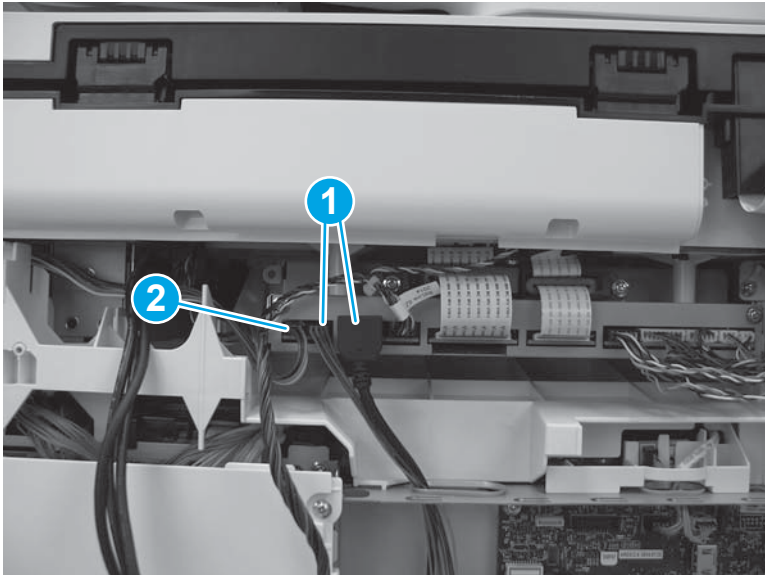

5. Slightly slide the ISA towards the back of the printer to release it.

Figure 1-3850 Slide the ISA towards the back of the printer

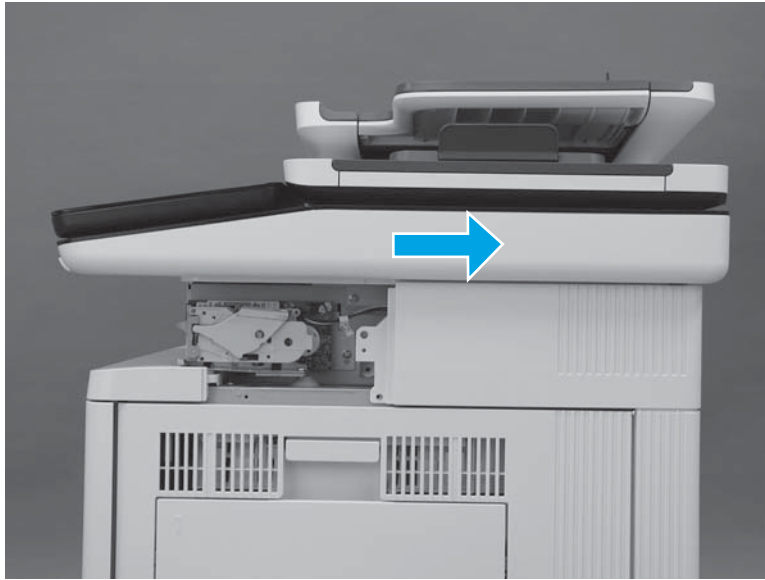

6. Lift the ISA up to remove it.



NOTE: When lifting the ISA, carefully pass the cables through the opening in the top of the formatter case.

Figure 1-3851 Remove the ISA

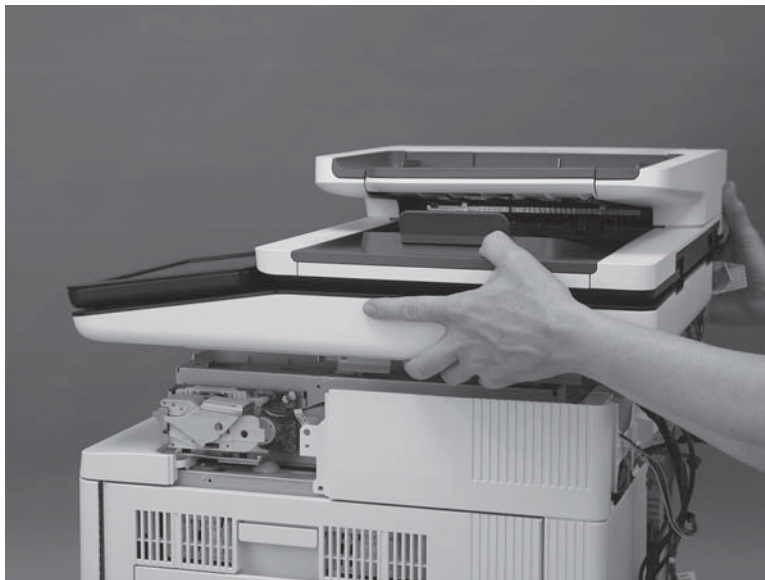

Step 19: Remove the right upper cover (M577)



NOTE: This step is for the M577 models. For the M552 and M553 models, skip this step and go to [Step 20: Remove the left cover on page 2157](#).

 **NOTE:** The figures below show the image scanner installed. The procedures for removing and installing the right upper cover are the same whether the image scanner is installed or removed."

1. At the right side of the printer, remove two screws (callout 1).

M577c/f/z only: Disconnect one connector (callout 2), if it was not already disconnected in a previous step.

Figure 1-3852 Remove two screws and one connector

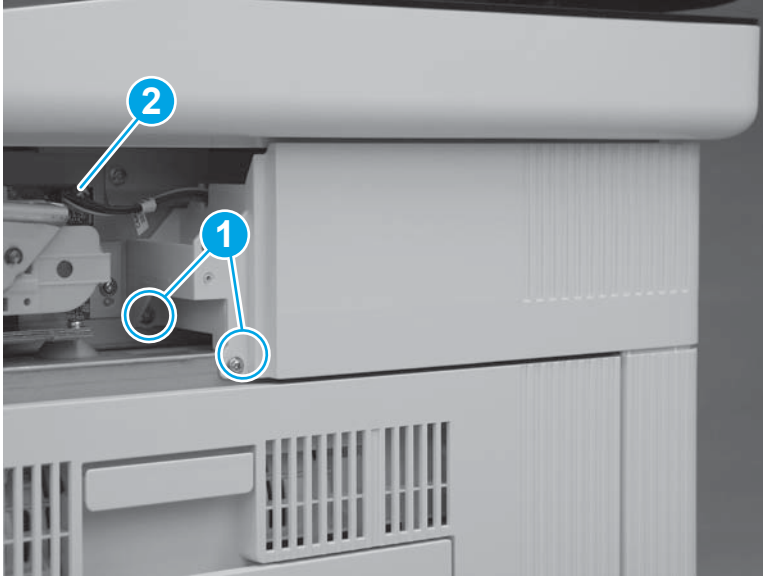

2. At the back of the printer, remove one screw (callout 1).

M577c/f/z only: Disconnect one connector (callout 2), if it was not already disconnected in a previous step.

 **Reinstallation tip:** This screw is smaller than the screws removed in the previous step. When reinstalling the right upper cover, make sure that this screw is installed in the correct position.

Figure 1-3853 Remove one screw and connector



3. Slide the cover toward the back of the printer.

Figure 1-3854 Slide the cover

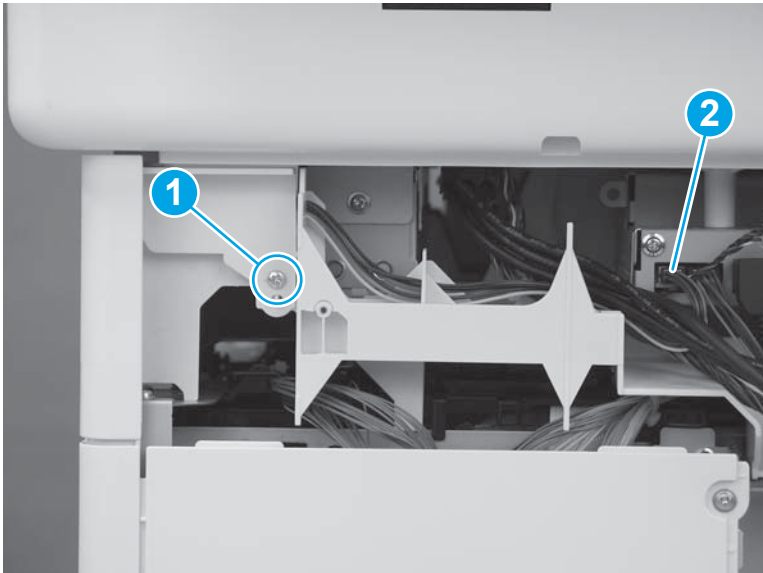
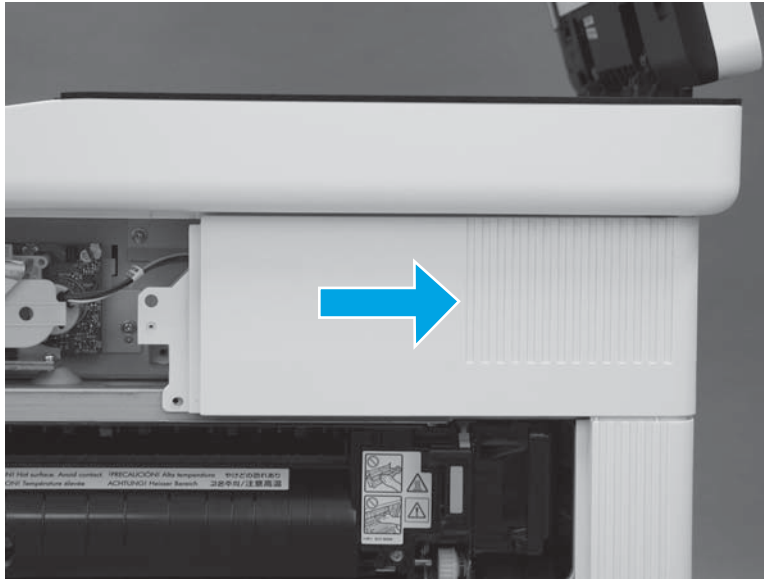

4. Lift the cover away from the printer to remove it.

M577c/f/z only: Release the cables (callout 1) through the slot (callout 2) in the printer.

Figure 1-3855 Remove the cover

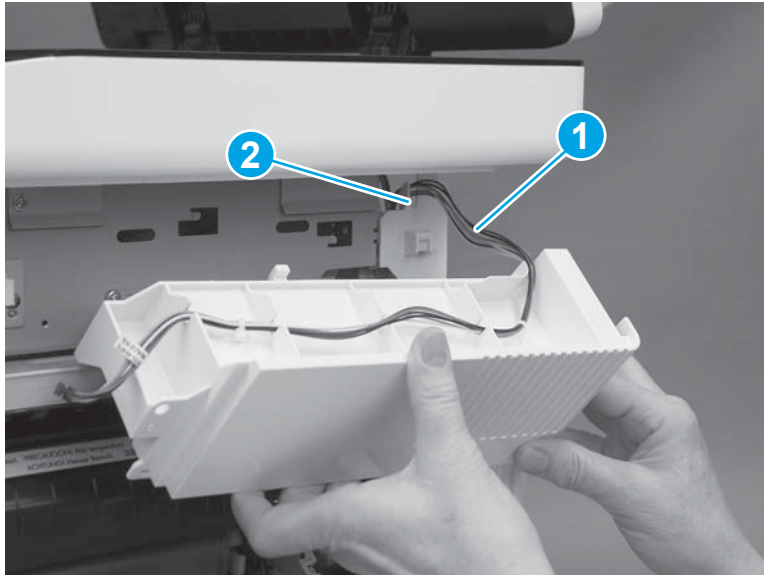

Step 20: Remove the left cover

1. At the left side of the printer, remove one screw (callout 1).

Figure 1-3856 Remove one screw



2. Release one tab (callout 1), rotate the front edge of the cover away from the printer (callout 2), and then slide the cover (callout 3) toward the rear of the printer to release it.

Figure 1-3857 Release the cover

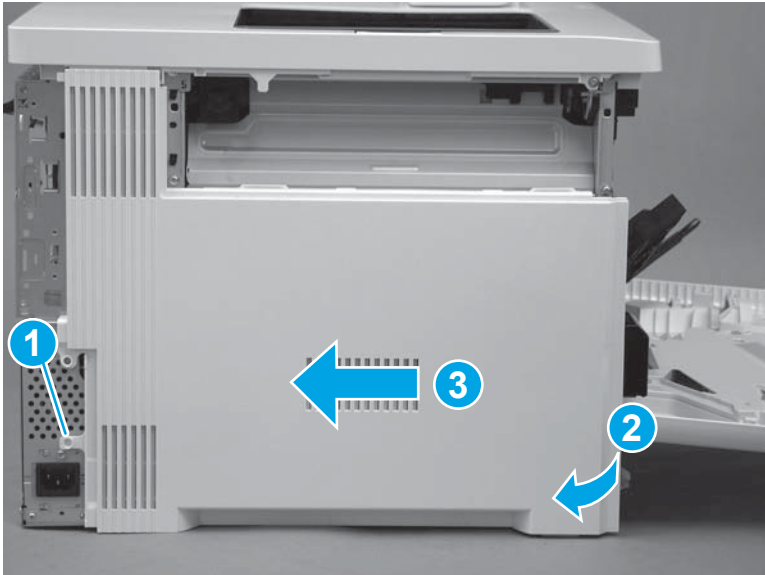

3. Remove the cover.

Figure 1-3858 Remove the cover

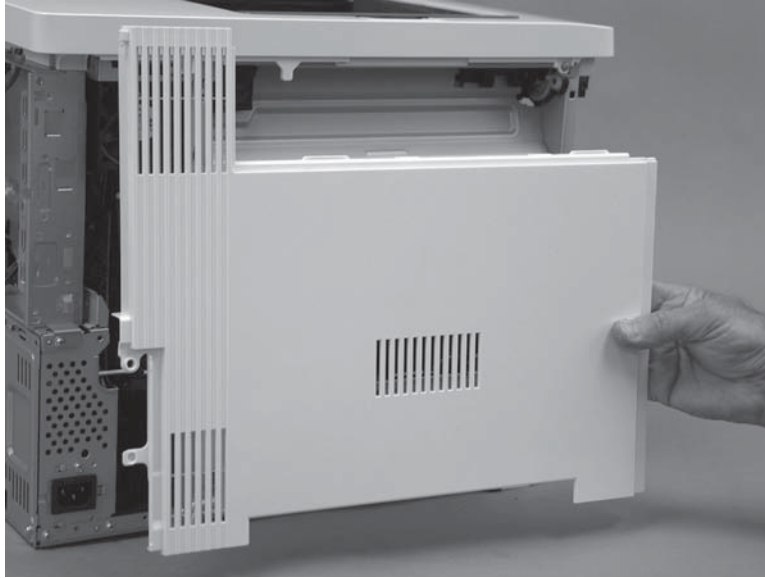

Step 21: Remove the upper cover (M552 and M553)

 **NOTE:** This step is for the M552 and M553 models. For the M577 models, skip this step and go to [Step 22: Remove the right rear cover on page 2161](#).

1. Remove three screws (callout 1).

Figure 1-3859 Remove three screws

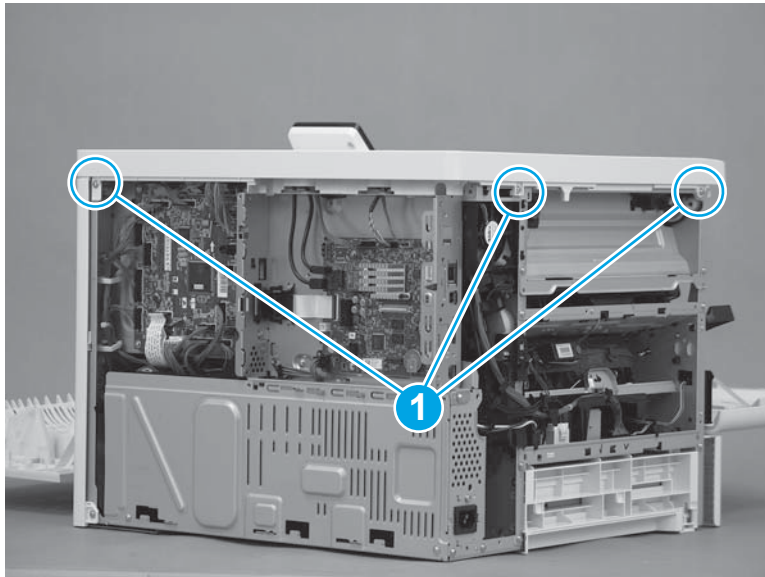

2. Remove one screw (callout 1), release one tab (callout 2), and then slightly separate the corner of the cover from the chassis.

 **NOTE:** This is a self-tapping plastic-thread screw. Make sure that this screw is used in this location when it is reinstalled.

Figure 1-3860 Remove one screw and release one tab



3. Release one tab (callout 1), and then lift up on the cover to release it.

 **NOTE:** If the cover does not release, check for additional tabs by locating the triangles embossed in the cover at tab locations.

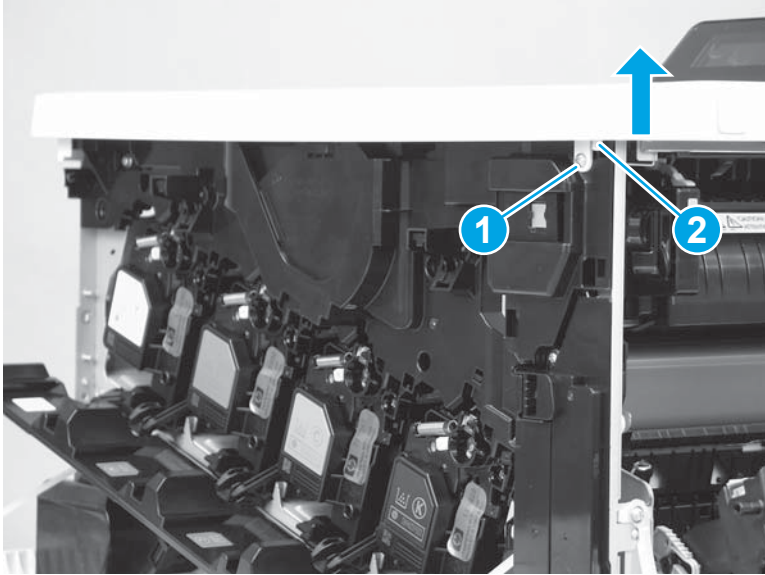
Figure 1-3861 Release the cover



4. Remove the cover.

Figure 1-3862 Remove the cover

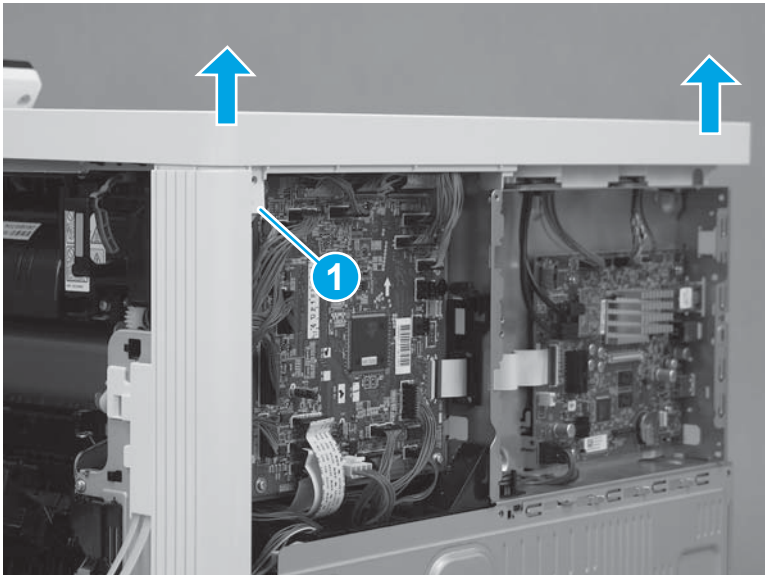
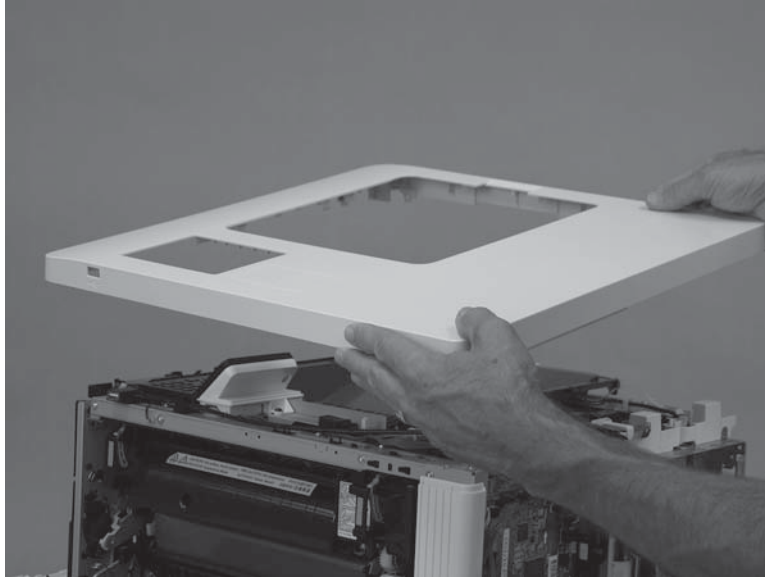

Step 22: Remove the right rear cover

1. Remove one screw (callout 1), and then slide the cover toward the rear of the printer (callout 2) to release it.

 **TIP:** If the right door is closed, open it now.

Figure 1-3863 Release the cover

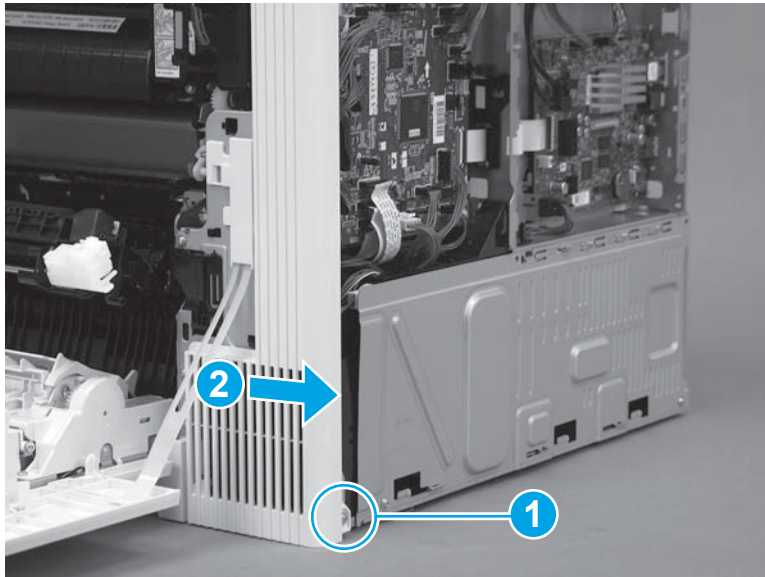

2. Remove the cover.

Figure 1-3864 Remove the cover

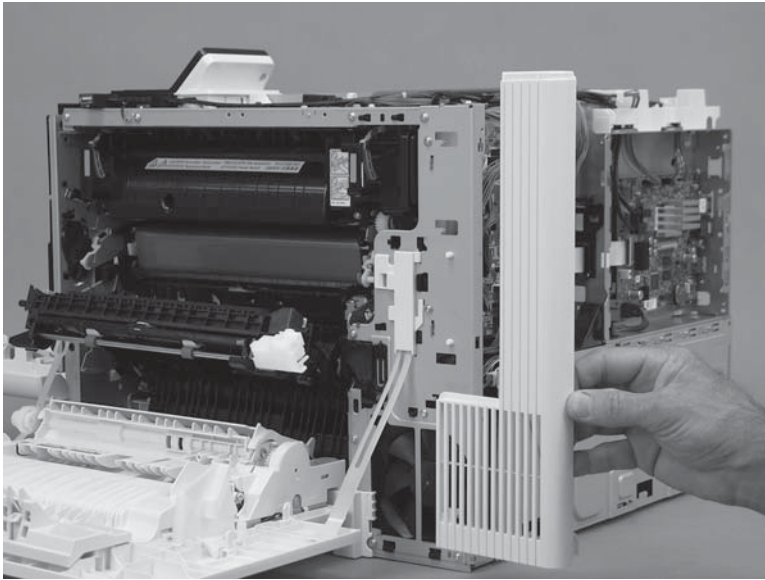

Step 23: Remove the formatter case

1. **M577 only:** Disconnect one connector (callout 1), and then pass the wire harness (callout 2) through two openings in the formatter case (callout 3).

Figure 1-3865 Disconnect one connector

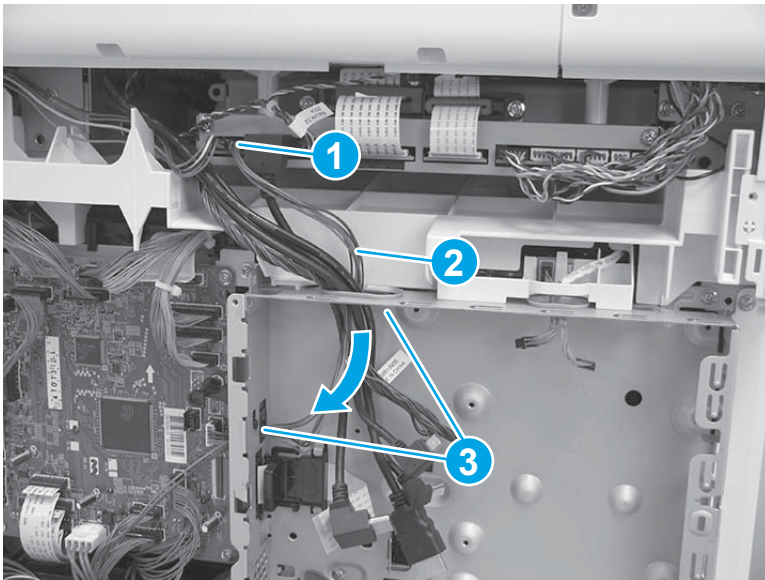

2. Release two tabs (callout 1) on the black plastic bracket. Hold the tabs in the released position, and then slide the bracket (callout 2) to the right to remove it from the formatter case.

Figure 1-3866 Remove the bracket

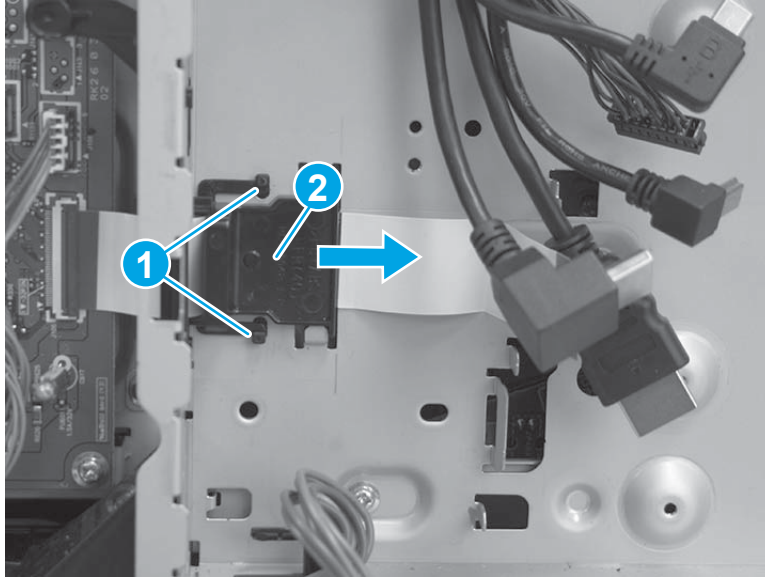

3. Remove two screws (callout 1), and then slide the low-voltage power supply (LVPS) cover to the right to remove it.

Figure 1-3867 Remove the LVPS cover

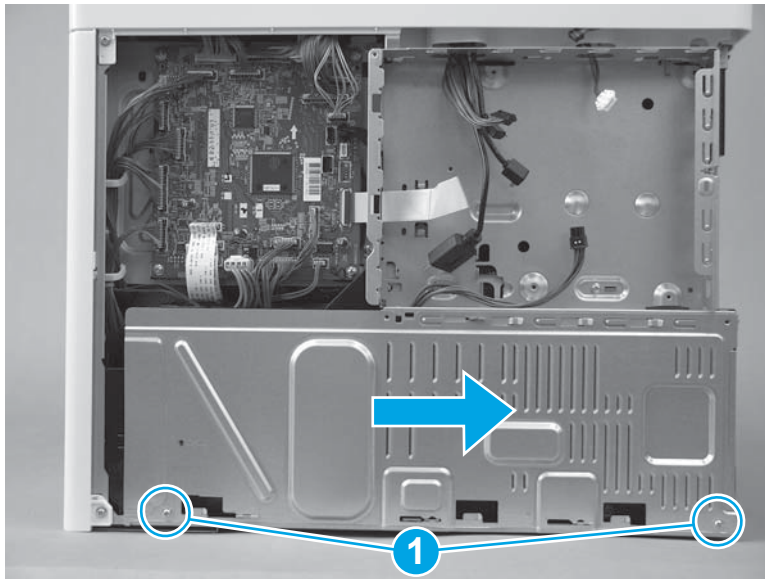

4. Pass two wire harnesses and one flat cable (callout 1) through the opening in the formatter case, and then release one wire harness from the retainer (callout 2).

⚠ CAUTION: The flat cable might be attached to the formatter case with double-sided tape. Make sure that this tape is released, so that the flat cable is not damaged when the formatter case is removed.

Figure 1-3868 Release wire harnesses and flat cable

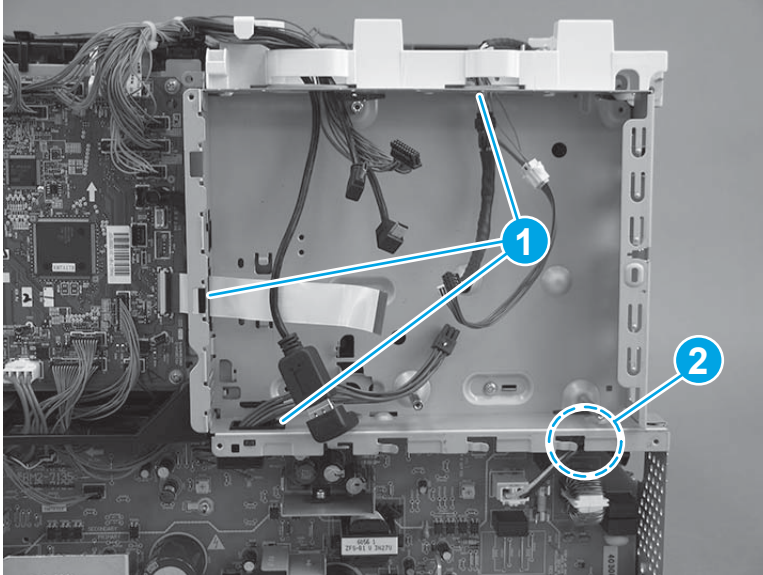

5. Remove six screws (callout 1).

Figure 1-3869 Remove six screws

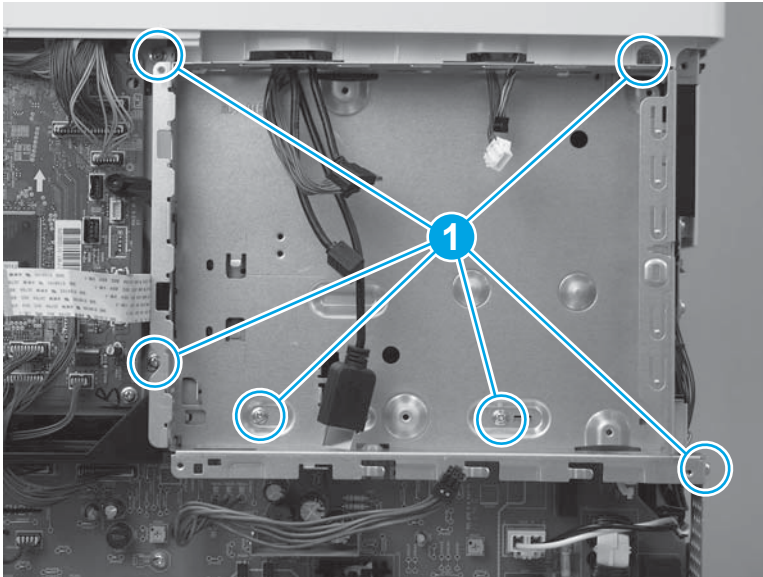

6. Rotate the bottom of the formatter case away from the printer (callout 1), and then pull it down (callout 2) to release it.

Figure 1-3870 Release the formatter case

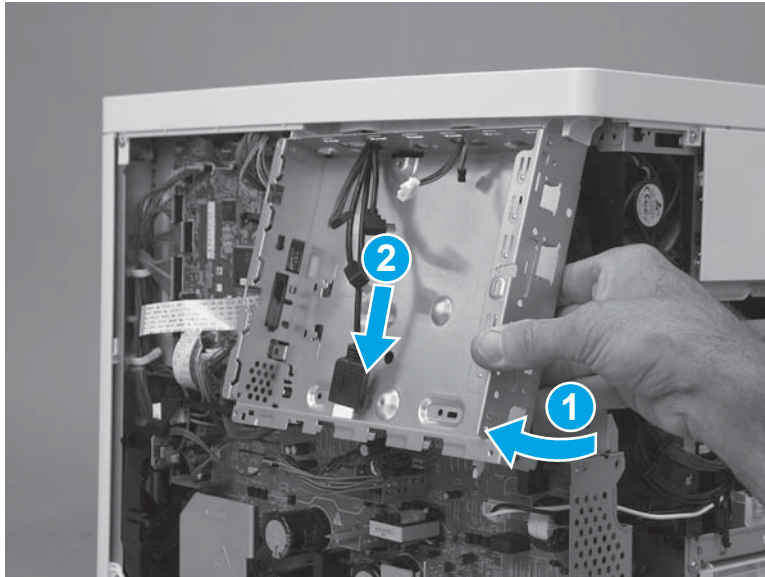

7. Pass the wire harnesses through the opening in the formatter case to remove it.

 **IMPORTANT:** If the formatter case is removed so that it can be replaced, make sure to transfer the memory PCA (island of data) and plastic bracket (callout 1) to the replacement case.

Figure 1-3871 Remove the formatter case



Step 24: Remove the low-voltage power supply (LVPS)

 **CAUTION:**  ESD-sensitive part.

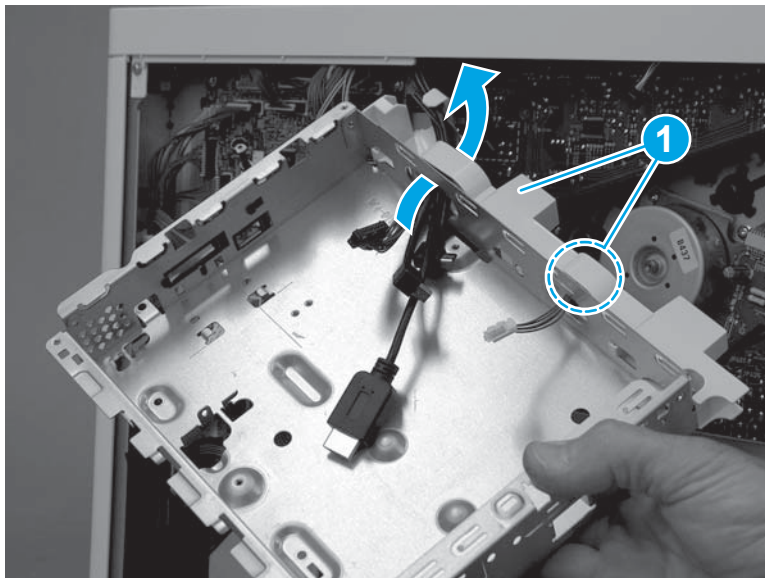
1. Disconnect one wire harness (callout 1), and then pass the wire harness through the opening (callout 2) in the chassis.

Figure 1-3872 Disconnect one wire harness

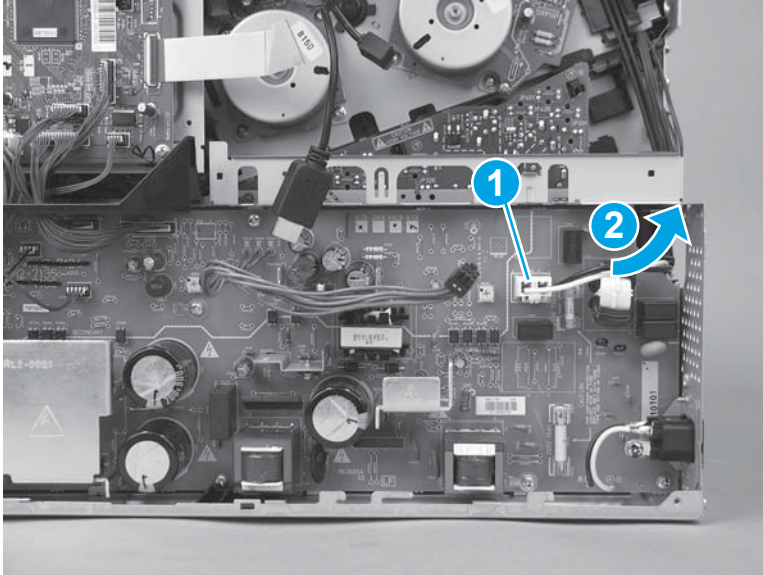

2. Disconnect three connectors on the DC controller (callout 1), and then disconnect four connectors (callout 2) on the LVPS.

Figure 1-3873 Disconnect seven connectors

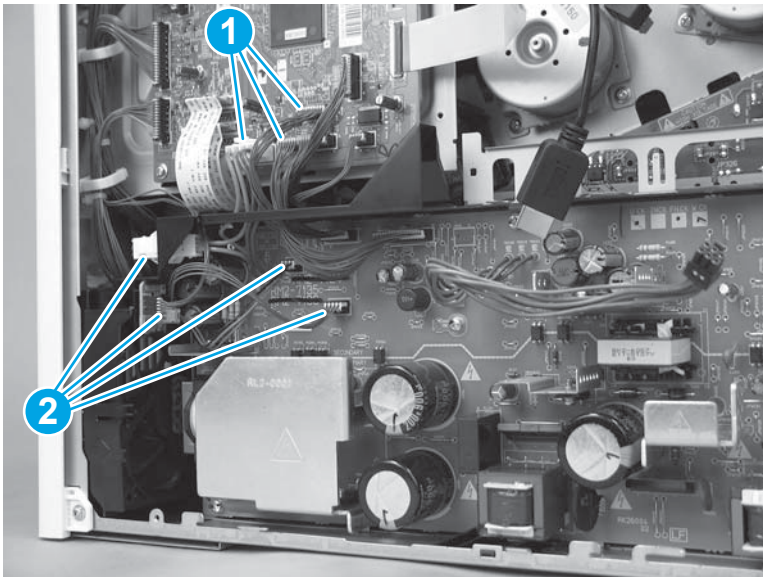

3. Pass the wire harnesses from the DC controller to the LVPS through the opening in the chassis (callout 1), and then release the wire harnesses from the retainer (callout 2).

Figure 1-3874 Pass the wire harnesses through the opening

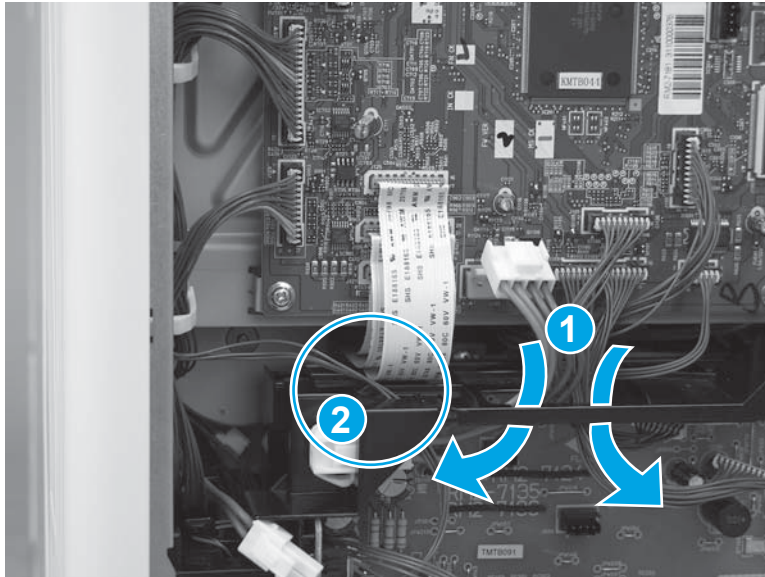

4. Remove three screws (callout 1).

Figure 1-3875 Remove three screws

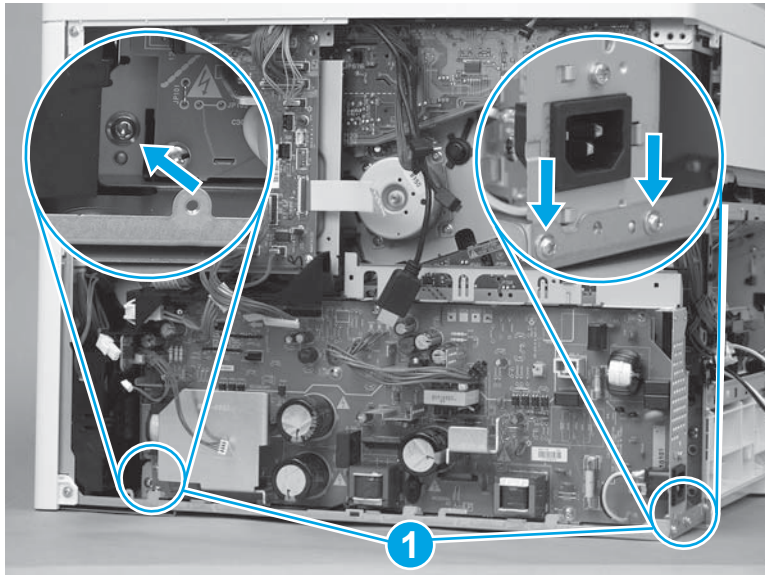

5. Rotate the top of the LVPS away from the printer (callout 1), and then slide it up and out (callout 2) of the printer to remove it.

Figure 1-3876 Remove the LVPS

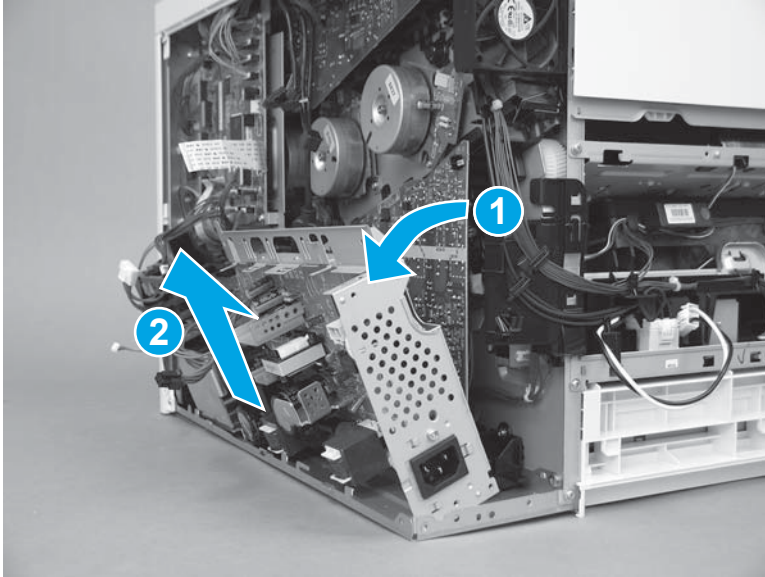

Step 25: Remove the power supply fan (FM1)

1. Remove one screw (callout 1).

Figure 1-3877 Remove one screw

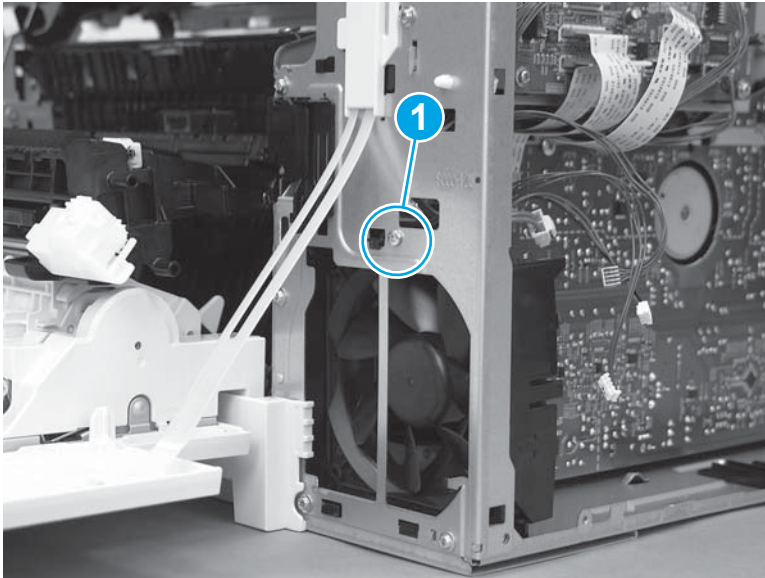

2. Release the wire harnesses from the retainer on the top of the fan bracket.

Figure 1-3878 Release the wire harnesses

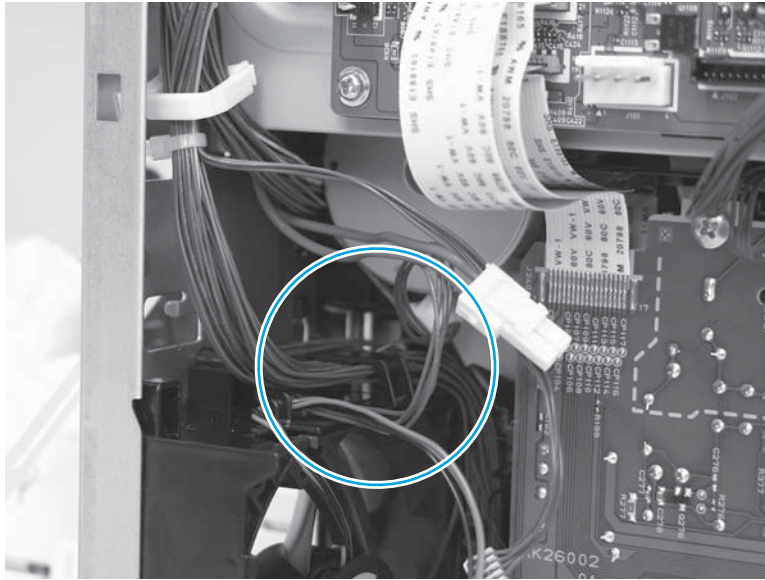

3. Lift the fan up (callout 1), and then slide it out of the printer (callout 2) to remove it.

Figure 1-3879 Remove the fan

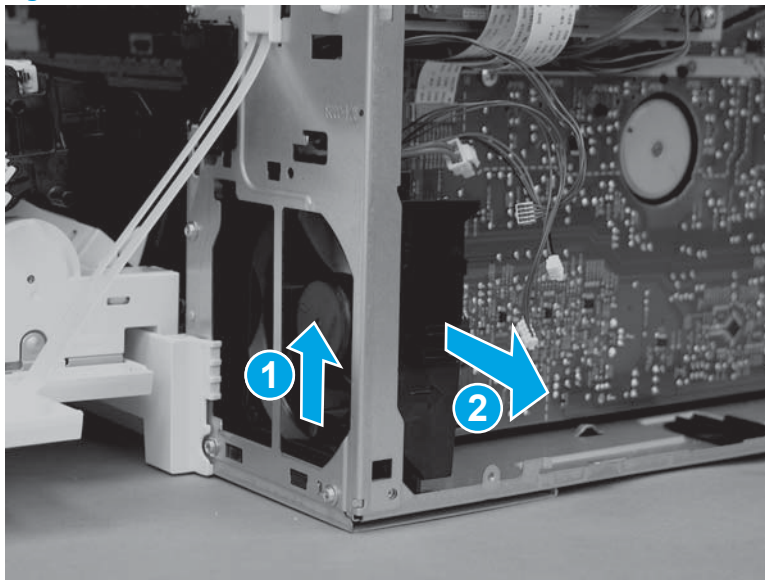

Step 26: Remove the high-voltage power supply D (HVPSD)

 **CAUTION:**  ESD-sensitive part.

1. Disconnect one flat cable (callout 1) on the DC controller.

Figure 1-3880 Disconnect one flat cable

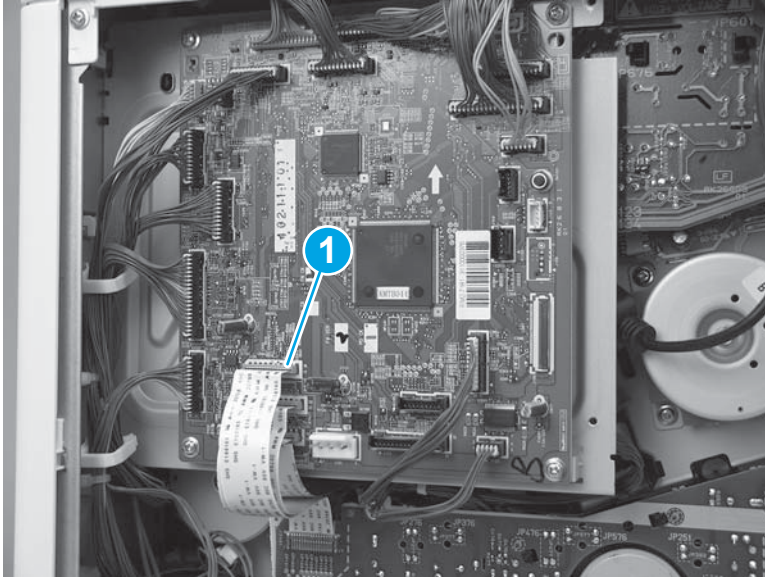

2. Remove two screws (callout 1), and then remove one self tapping screw (callout 2) on the HVPSD.

Figure 1-3881 Remove three screws

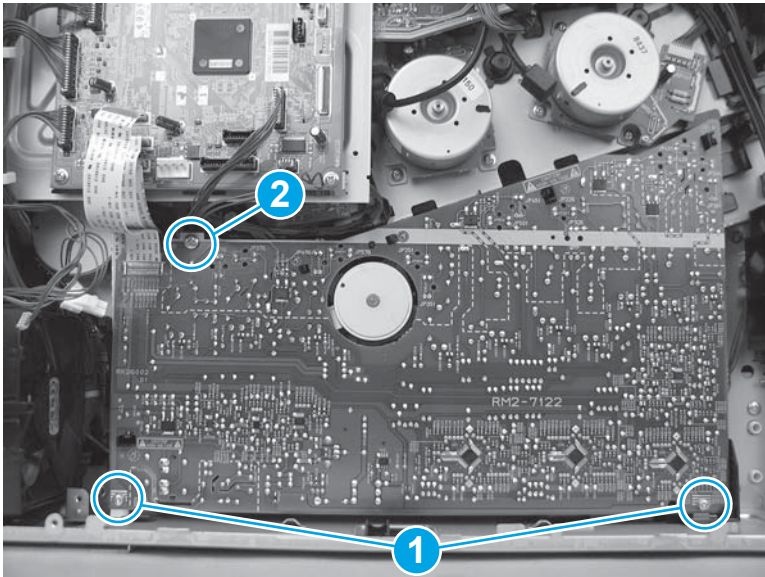

3. Release five tabs (callout 1), and then remove the HVPSD (callout 2).

Figure 1-3882 Remove the HVPSD

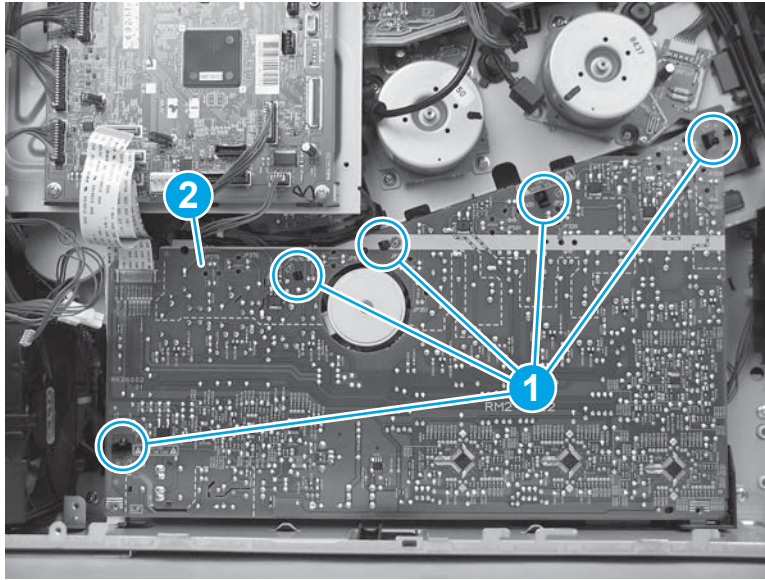

Step 27: Remove the lifter drive assembly

1. Disconnect two connectors (callout 1).

Figure 1-3883 Disconnect two connectors

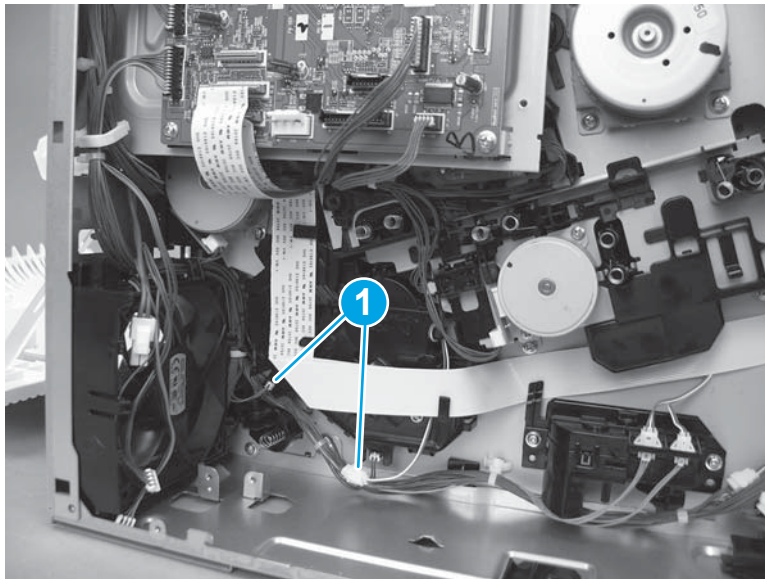

2. Disconnect two flat cables (callout 1), and then release them from the retainers (callout 2).

Figure 1-3884 Disconnect two flat cables

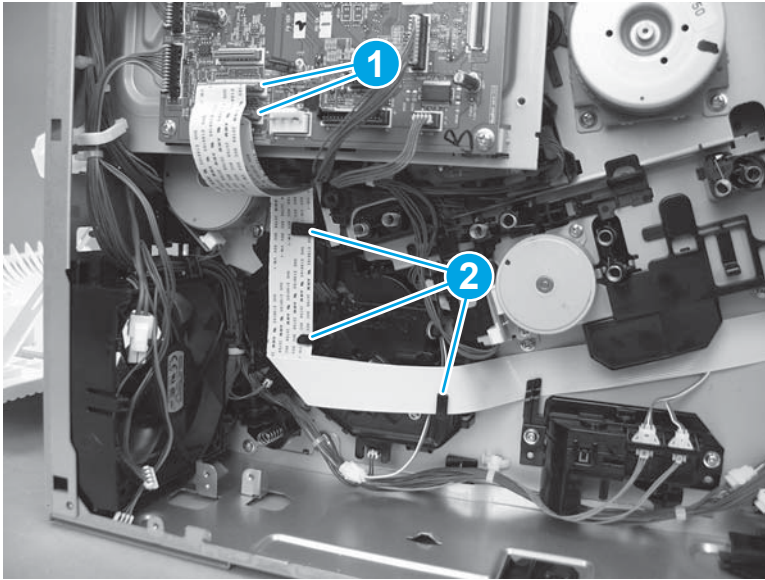

3. Remove two screws (callout 1), release one tab (callout 2), and then remove the lifter drive assembly (callout 3).

 **NOTE:** Release one wire harness from the retainer (callout 4) as the assembly is removed.

Figure 1-3885 Remove the assembly



Step 28: Remove the DC controller and sheet-metal bracket

 **CAUTION:**  ESD sensitive part.

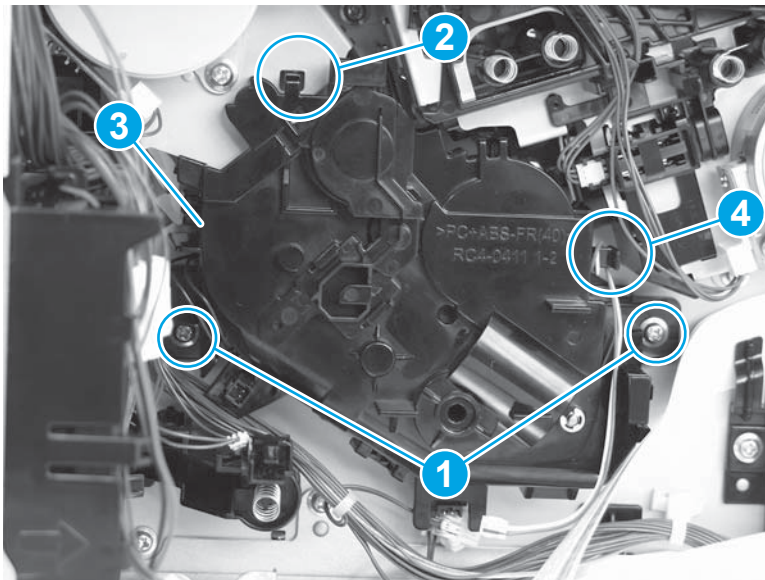
1. Disconnect all of the connectors, and then remove two screws (callout 1).

The following connectors are empty:

- J140, J141, and J143

Figure 1-3886 Remove two screws

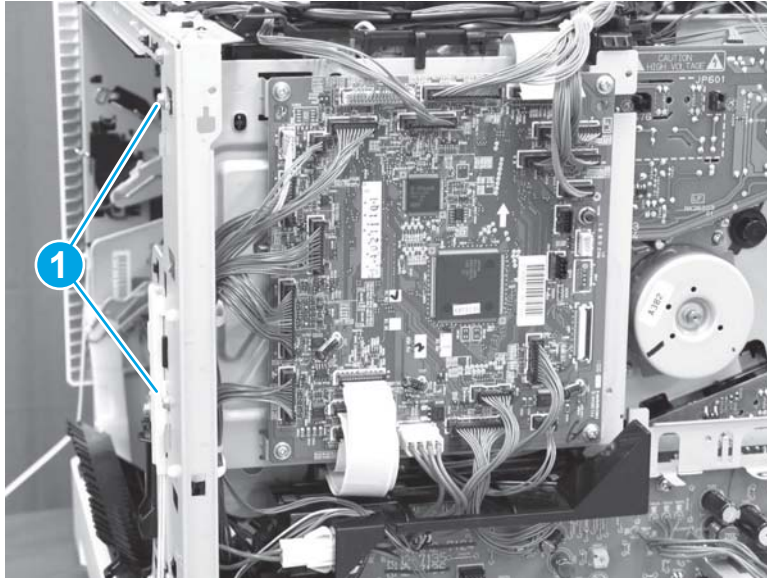

2. Lift up on the DC controller and sheet-metal plate to remove it.

Figure 1-3887 Remove the plate

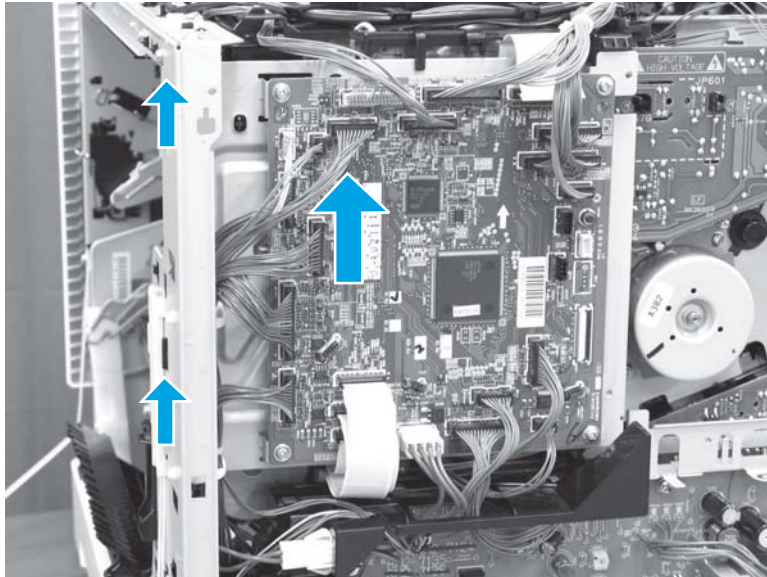

Step 29: Remove the pickup drive assembly and motor (M5)

1. Release one tab (callout 1), and then move the guide (callout 2) out of the way.

Figure 1-3888 Move the guide out of the way

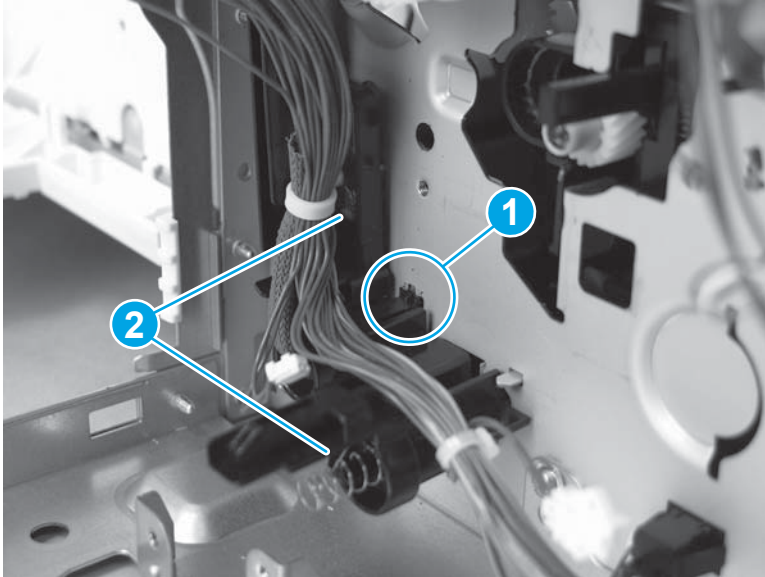

2. Remove three screws (callout 1).

Figure 1-3889 Remove three screws

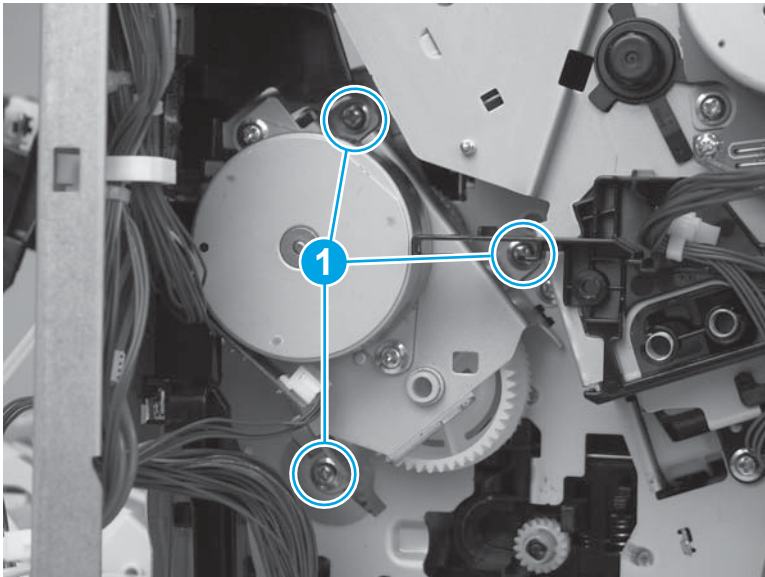

3. Remove the assembly.

CAUTION: One gear on the back side of the assembly is not captive. Handle the assembly carefully.

Figure 1-3890 Remove the assembly

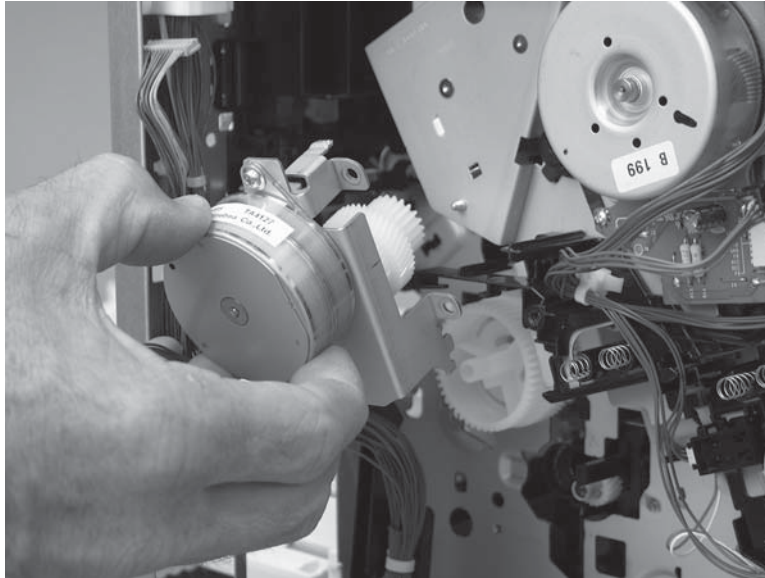

4. If the gear (callout 1) was not removed with the assembly in the previous step, remove it now.

Figure 1-3891 Remove the gear if installed

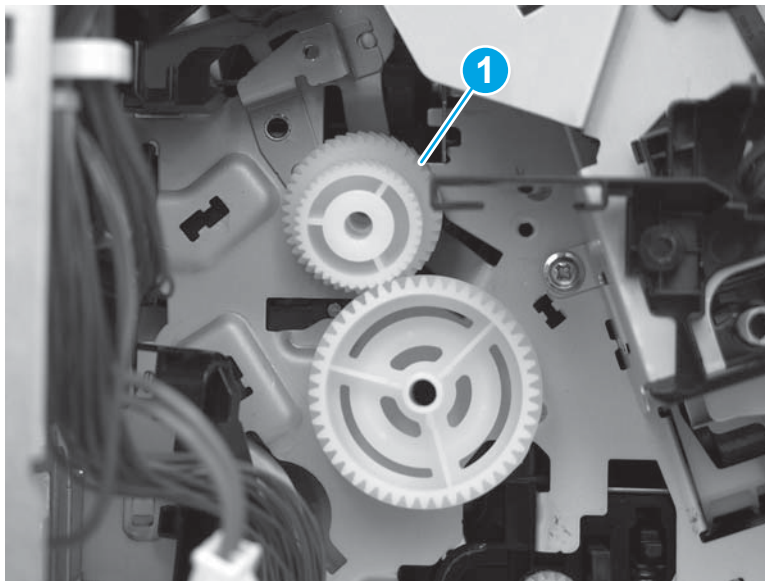

Step 30: Remove the registration assembly

1. At the right side of the printer, release one tab (callout 1).

Figure 1-3892 Release one tab

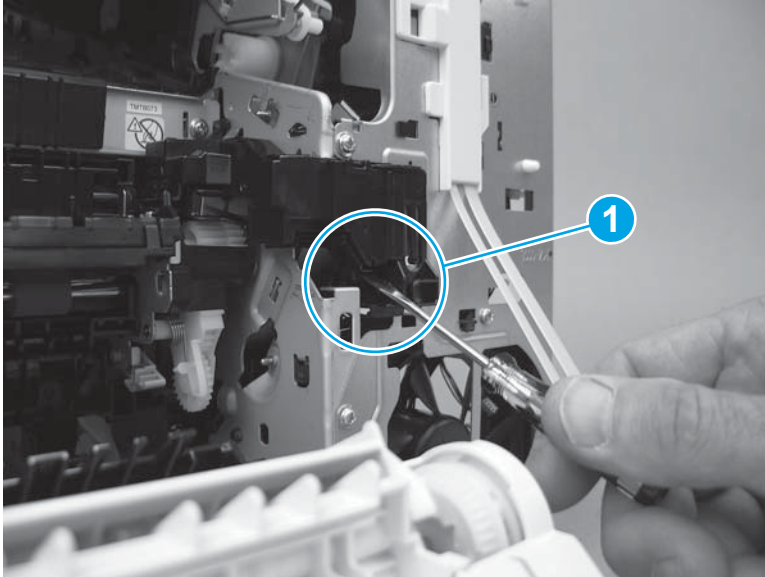

2. Remove the cover.

Figure 1-3893 Remove the cover

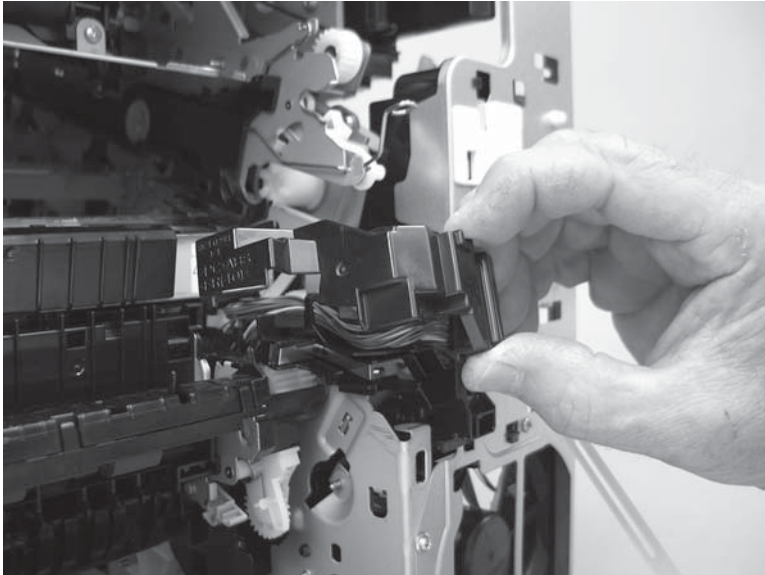

3. Release one tab (callout 1), and then push down on the guide (callout 2) to release it.

Figure 1-3894 Release the guide

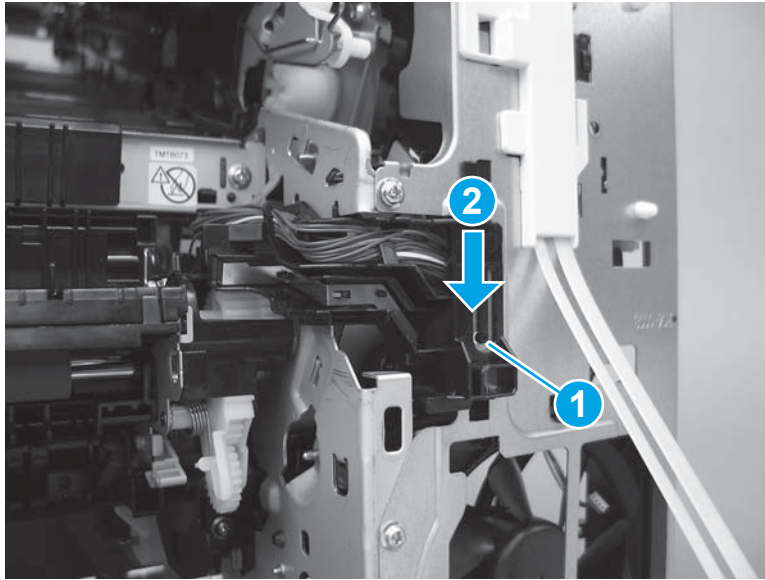

4. Move the guide out of the way.

Figure 1-3895 Move the guide out of the way

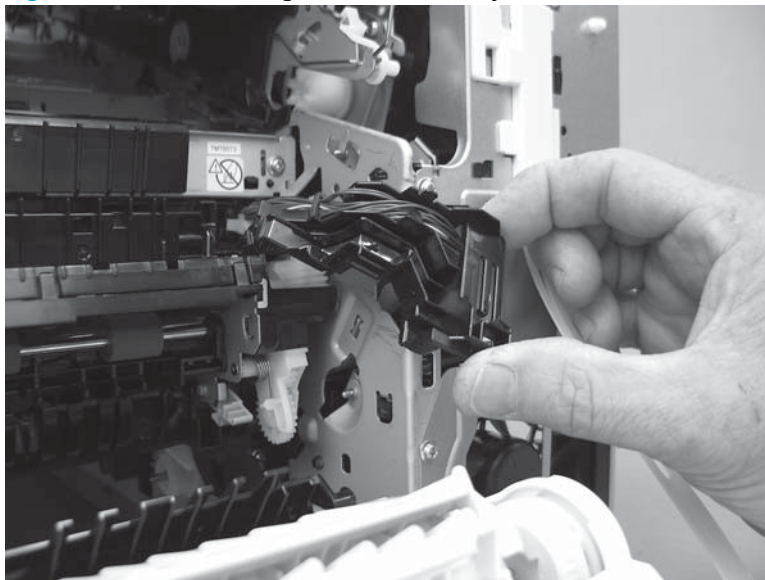

5. Remove three screws (callout 1).

Figure 1-3896 Remove three screws

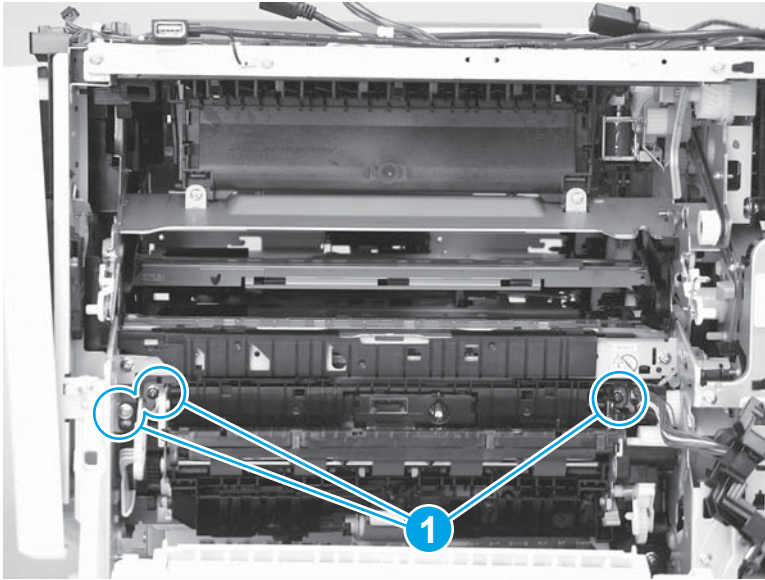

6. Before proceeding, locate the sheet metal portion (callout 1) of the assembly. When handling the assembly, use the sheet metal as handles.

Figure 1-3897 Locate the sheet metal portion of the assembly

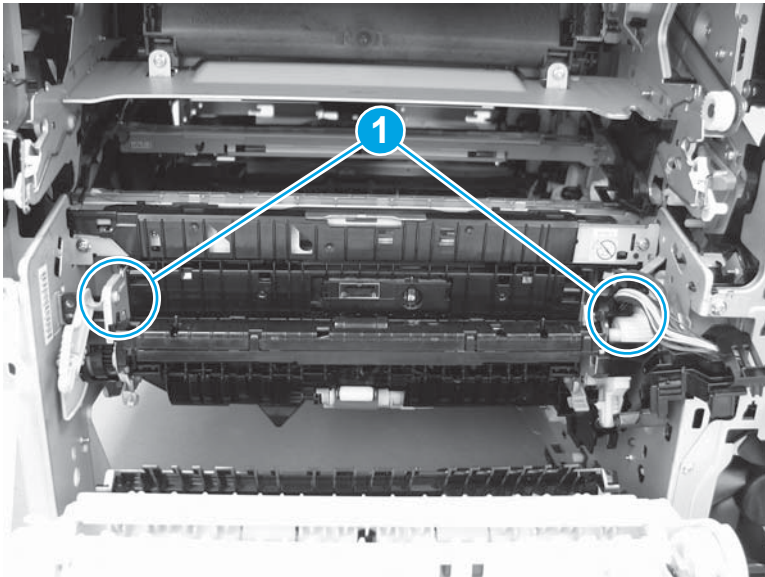

7. Before proceeding, take note of the sheet-metal tabs (callout 1) on the back of the assembly—the figure shows the assembly removed so the tabs can be viewed—that fasten it to the chassis.

Figure 1-3898 Take note of the sheet-metal tabs

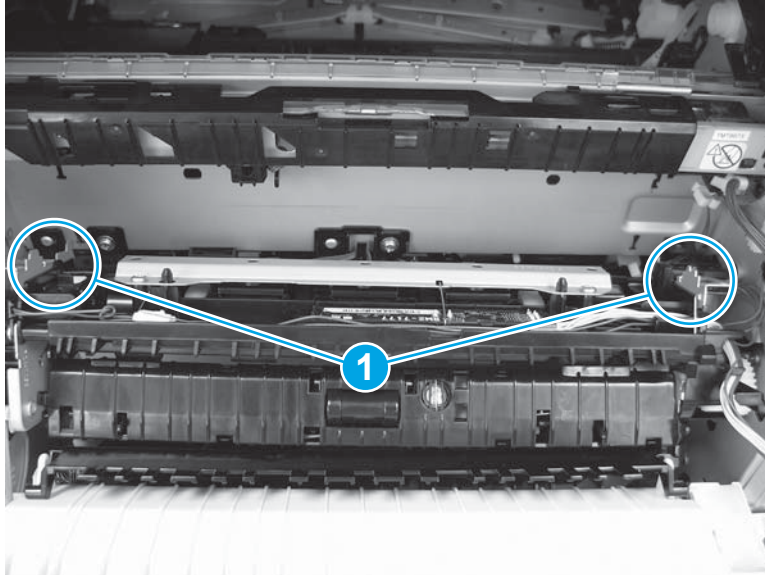

8. Grasp the sheet-metal handles (callout 1), and then rotate the top of the assembly away from the chassis (callout 2) to release the top tabs.

Figure 1-3899 Rotate the top of the assembly away from the chassis

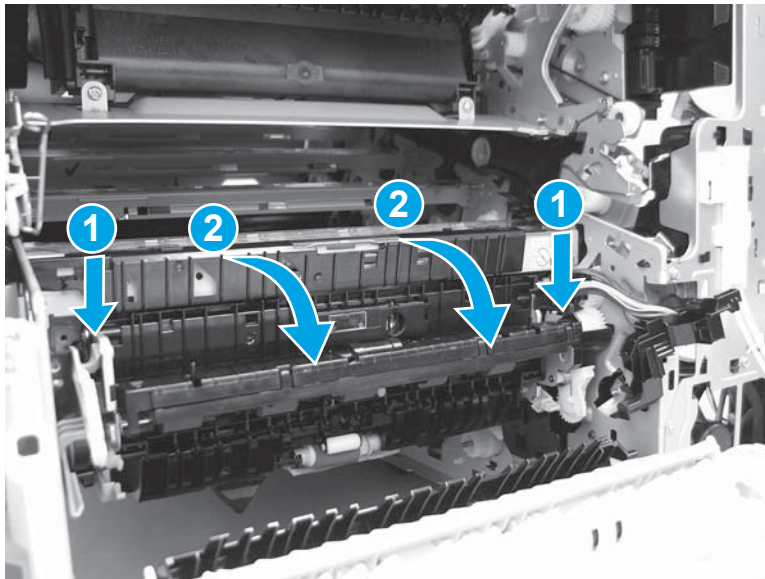

9. Pull up on the assembly to release the bottom tabs.

CAUTION: The assembly is still attached to the printer by a wire harness. Do not attempt to completely remove the assembly.

Figure 1-3900 Release the bottom tabs

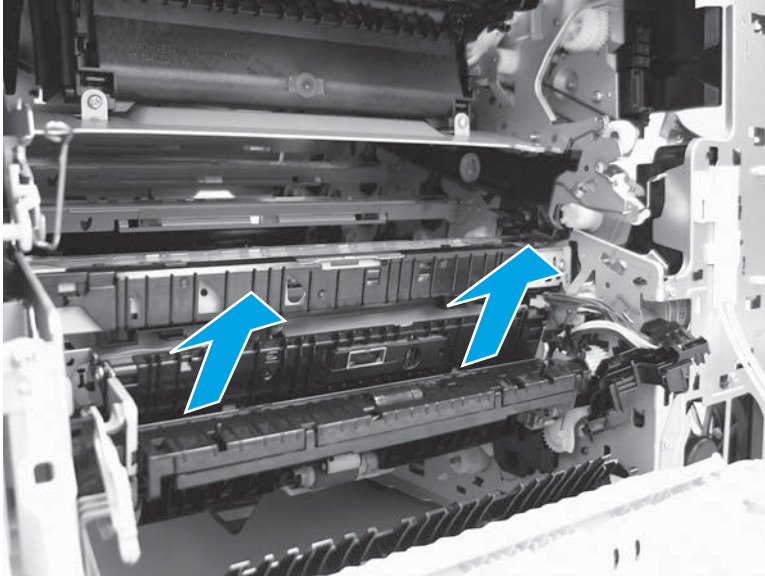

10. Turn the registration assembly over to access the back side, disconnect three connectors (callout 1), and then remove the assembly.

Figure 1-3901 Remove the assembly

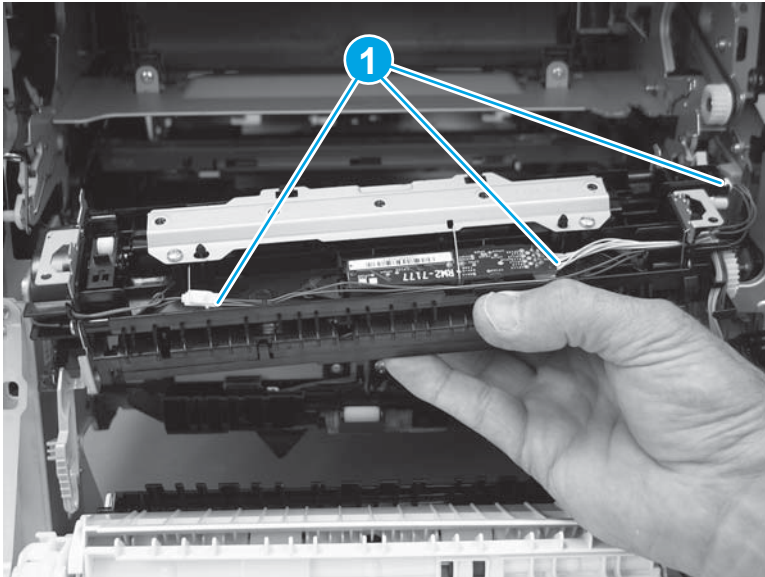

Step 31: Unpack the replacement assembly

Unpack the replacement assembly from the packaging.

For complete information on HP's recycling programs, go to [Product return and recycling](#).

NOTE: HP recommends responsible disposal of the defective assembly.

Figure 1-3902 Recycle and unpack

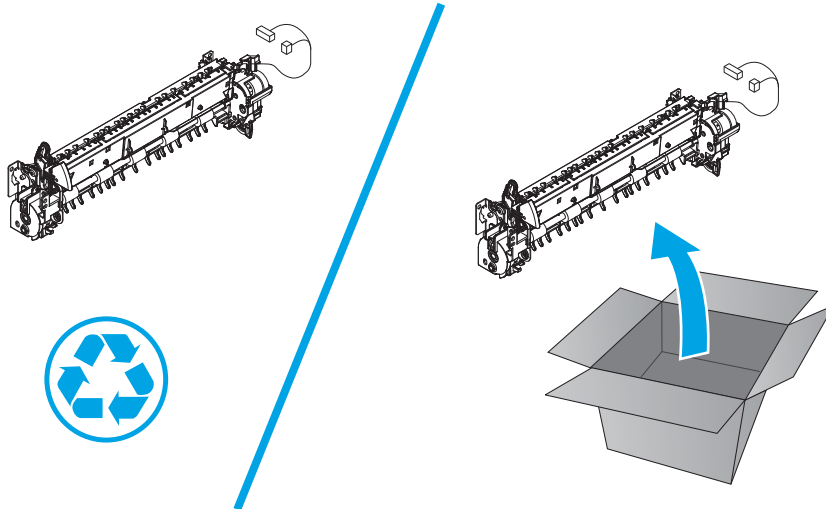

Step 32: Install the registration assembly

1. Turn the registration assembly over to access the back side, and then connect three connectors (callout 1).

Figure 1-3903 Connect three connectors

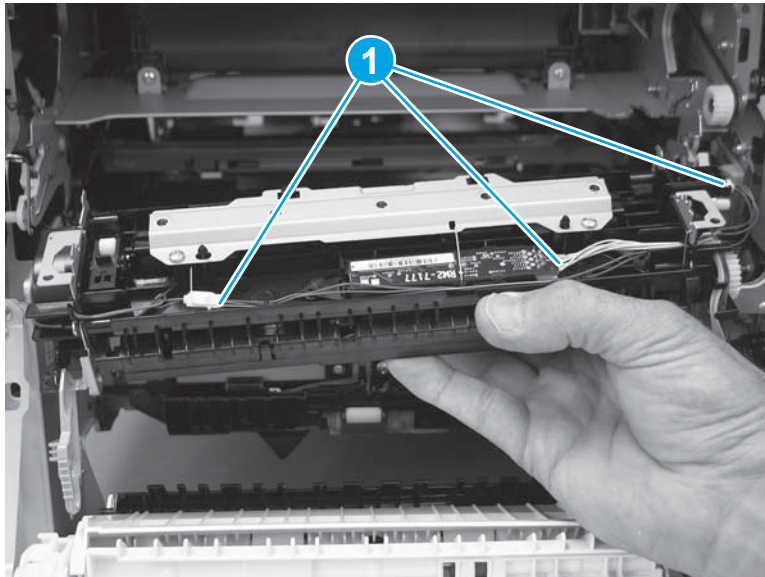

2. Align the tabs on the assembly with the slots in the chassis.

Figure 1-3904 Align the tabs on the assembly with the slots

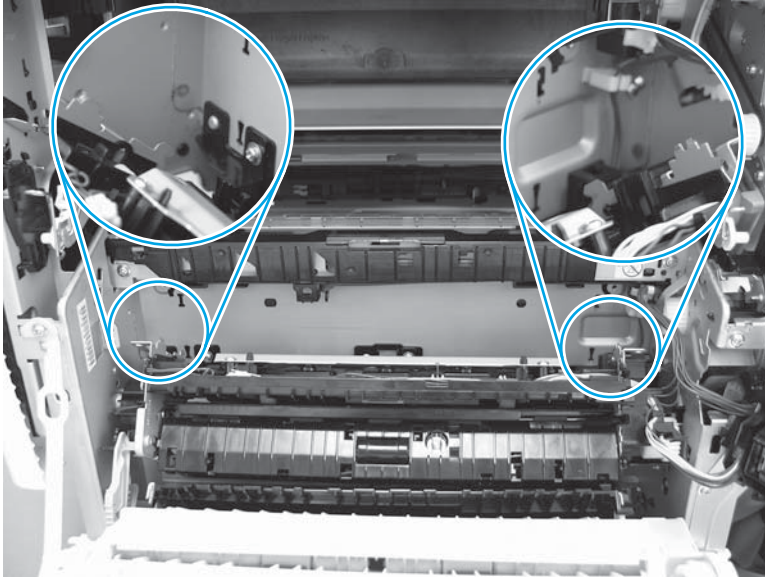

3. Position the bottom tabs in the appropriate slots, and then push down on the assembly to engage them.

Figure 1-3905 Install the bottom tabs

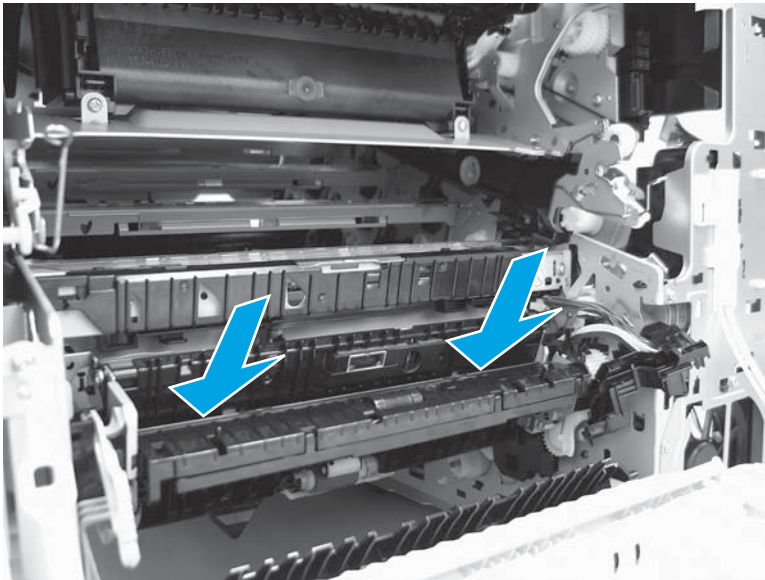

4. Grasp the sheet-metal handles (callout 1) to rotate the top of the assembly toward the chassis (callout 2) to install the top tabs.

Figure 1-3906 Install the top tabs

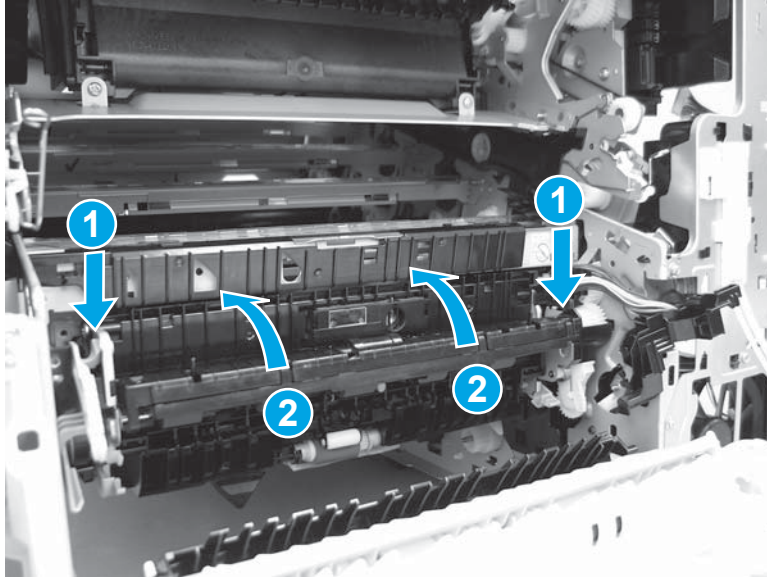

5. Install three screws (callout 1).

Figure 1-3907 Install three screws

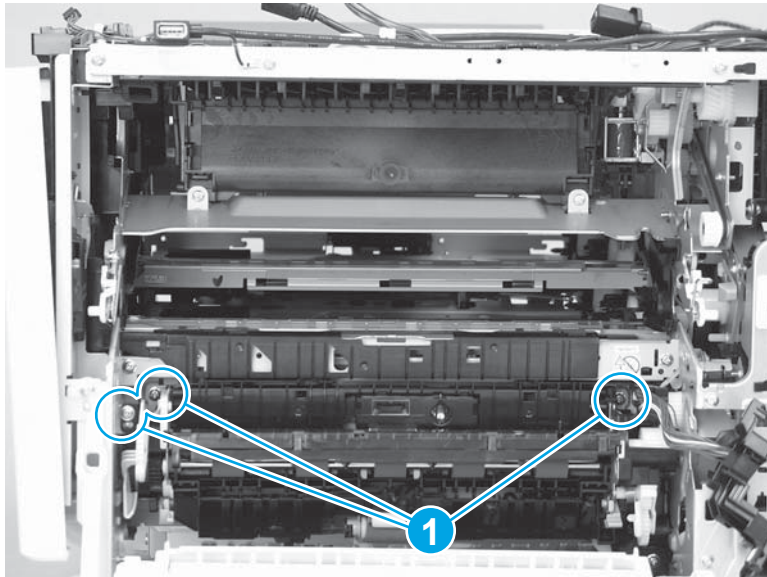

6. Position the guide on the chassis.

Figure 1-3908 Position the guide on the product

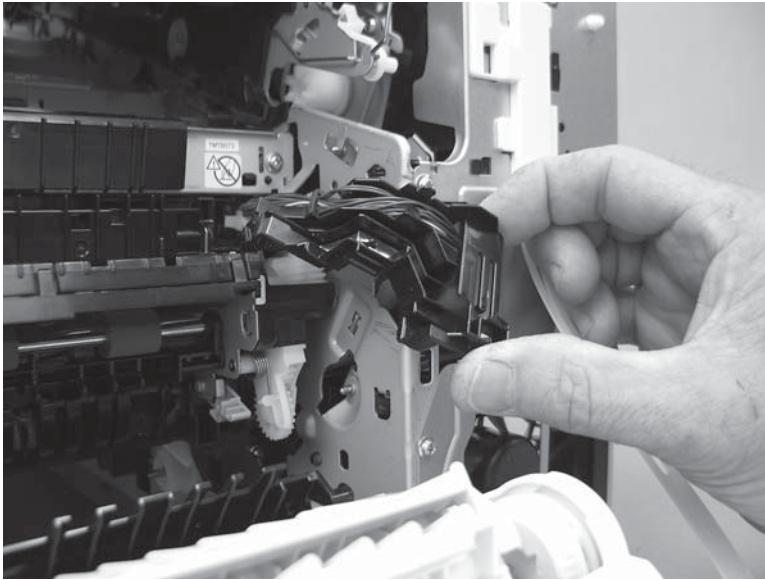

7. Slide the guide up to install it (callout 1), and then make sure that the tab (callout 2) snaps into place.

Figure 1-3909 Install the guide

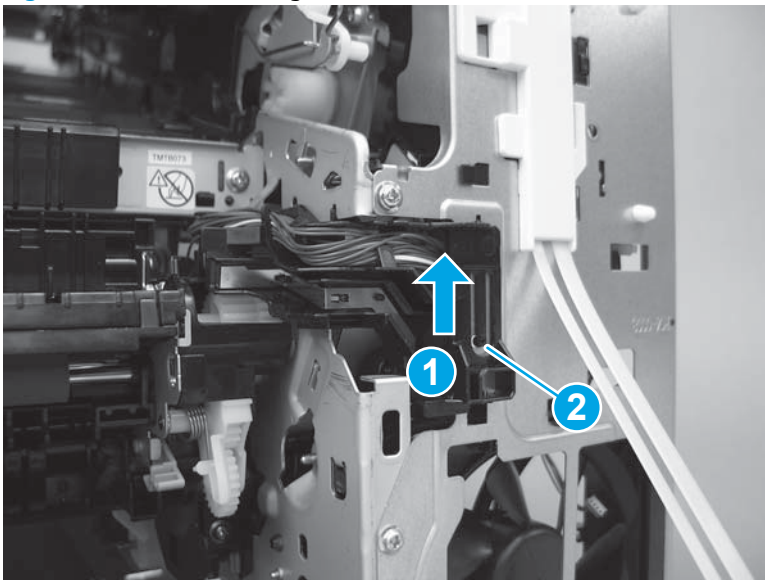

8. Position the cover on the printer.

Figure 1-3910 Position the cover on the product

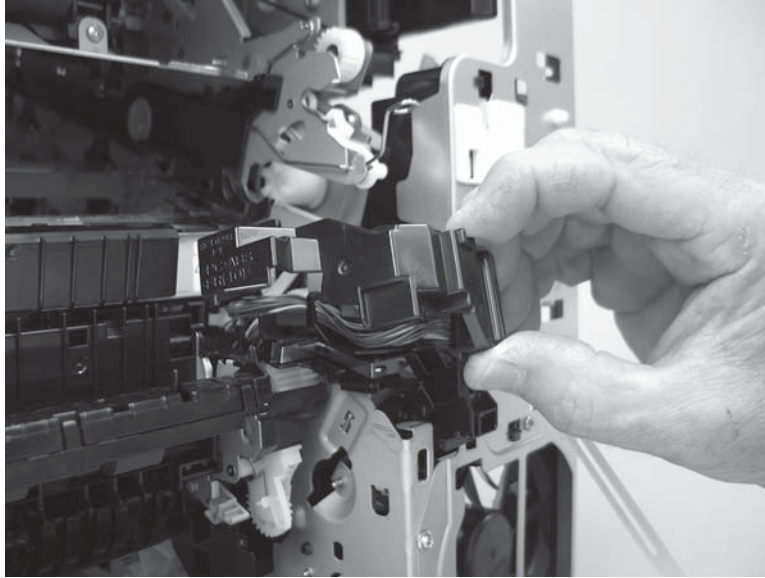

9. Install the cover, and then make sure that the tab (callout 1) snaps into place.

Figure 1-3911 Install the cover

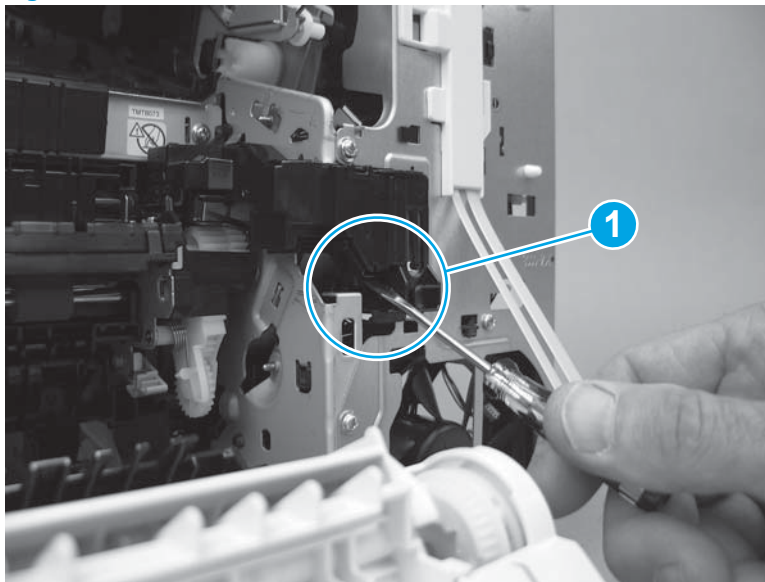

Step 33: Install the pickup drive assembly and motor (M5)

1. Before installing the assembly, check to see if a gap exists (callout 1) between the gears.

 **NOTE:** If no gap exists, go to step 3 in this section.

Figure 1-3912 Check the gears for a gap



2. Adjust the gears on the assembly to remove the gap (callout 1).

Figure 1-3913 Adjust the gears

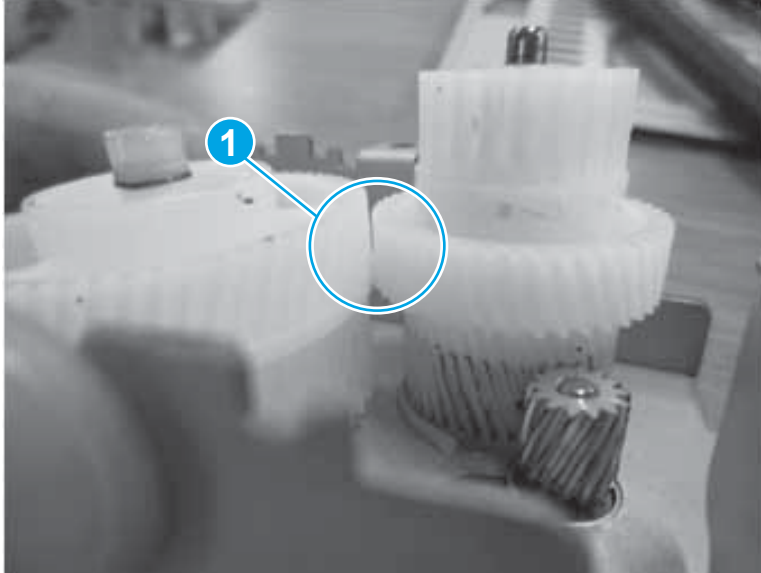
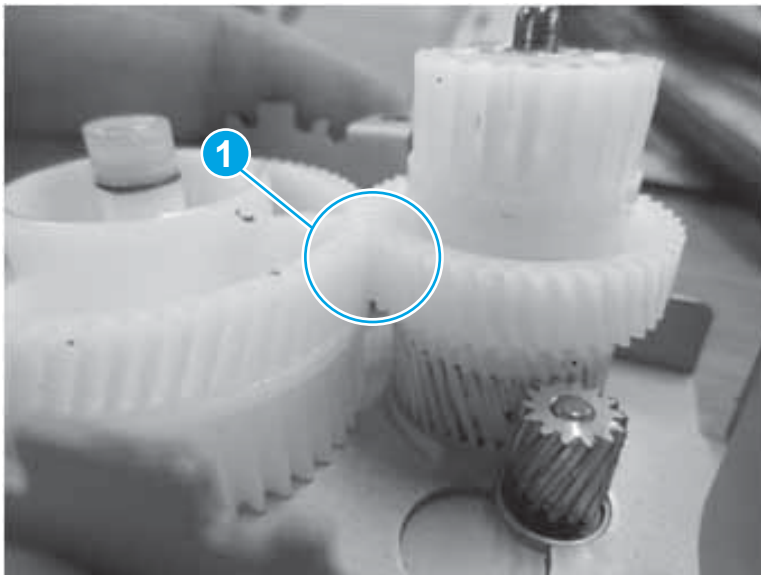

3. Align the tabs on the pickup drive assembly with the slots in the chassis, and then install the assembly on the printer.

 **IMPORTANT:** The figure below shows the large gear of the assembly already installed on the printer chassis. However it is easier to install the pickup drive assembly if the gear is installed on the assembly.

 **TIP:** With the right door open, look into the printer and verify that the mounting bracket for the assembly is correctly installed against the chassis.

Figure 1-3914 Install the assembly



4. Install three screws (callout 1).

Figure 1-3915 Install three screws

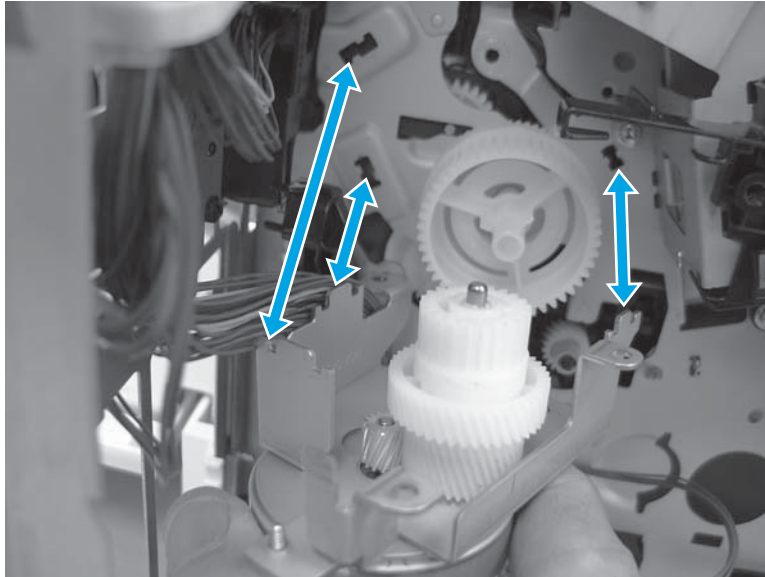
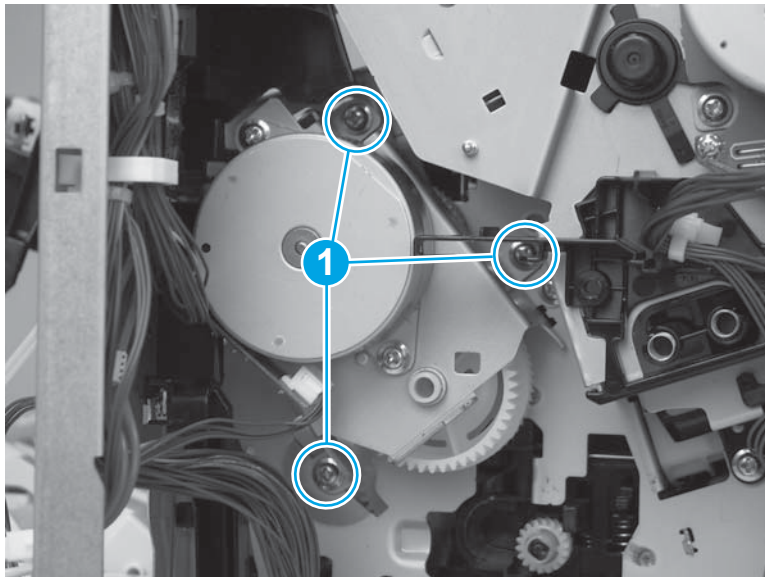

5. Install the guide (callout 1). Make sure that the tab (callout 2) snaps into place.

Figure 1-3916 Install the guide

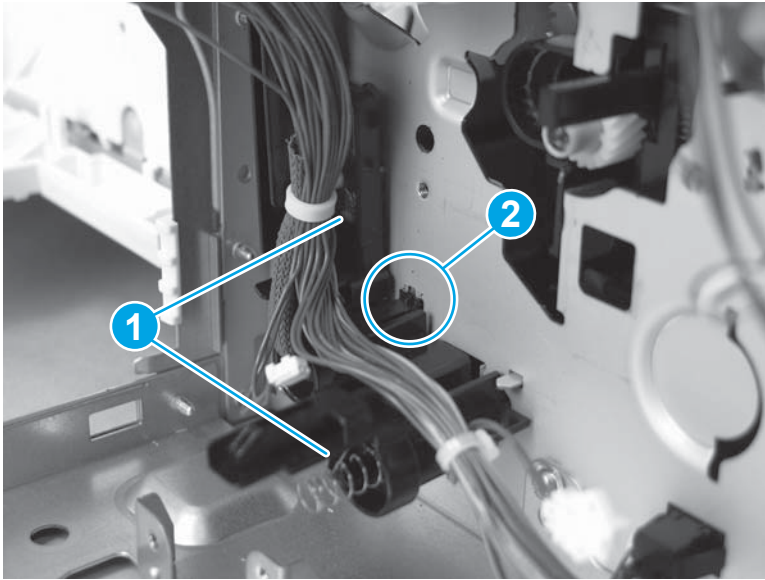

Step 34: Install the DC controller and sheet-metal bracket

 **CAUTION:**  ESD-sensitive part.

1. Position the DC controller and sheet-metal plate on the printer, and then push down to engage the plate with the chassis.

Figure 1-3917 Install the plate

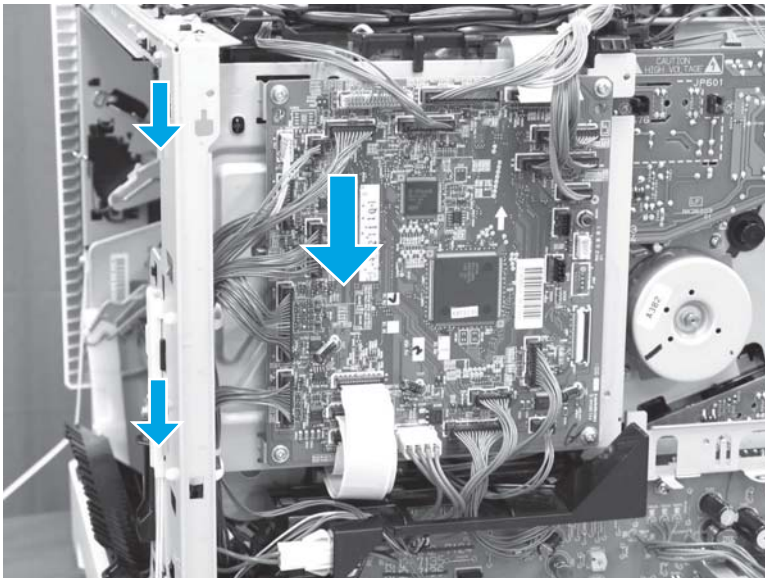

2. Install two screws (callout 1), and then connect all of the connectors.

The following connectors are empty:

- J140, J141, and J143

Figure 1-3918 Install two screws

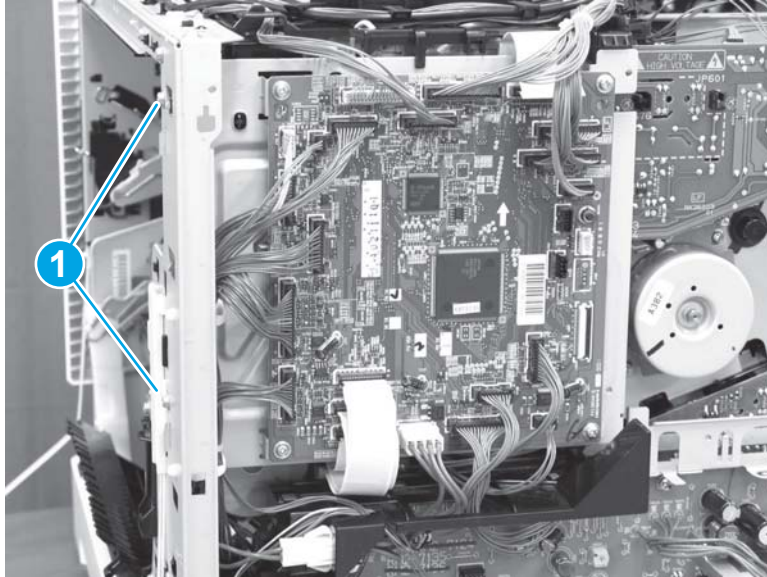

Step 35: Install the lifter drive assembly

1. Install one wire harness on the retainer (callout 1), position the lifter drive assembly in the printer (make sure that one tab (callout 2) snaps into place), and then install two screws (callout 3).

 **TIP:** It might be easier to install the assembly if the bottom of the assembly is installed first, and then the top of the assembly is rotated into place.

Figure 1-3919 Install the lifter drive



2. Connect two flat cables (callout 1), and then place them in the retainers (callout 2).

Figure 1-3920 Connect two flat cables

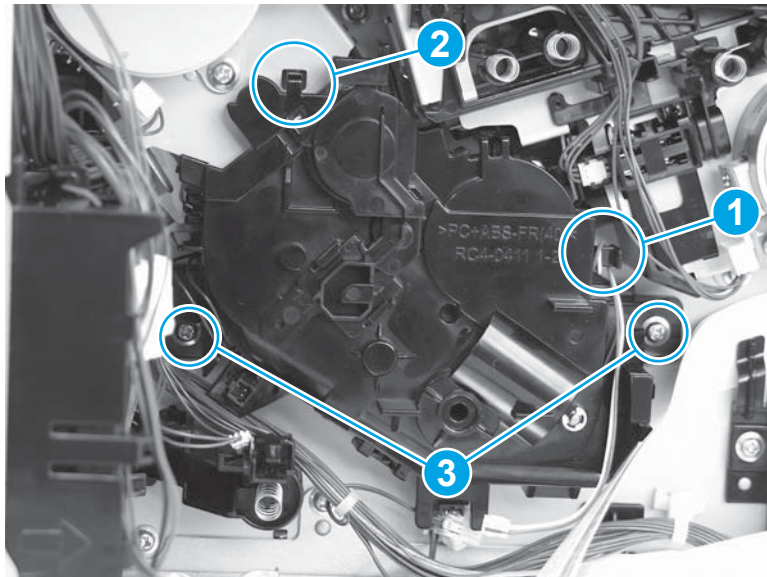
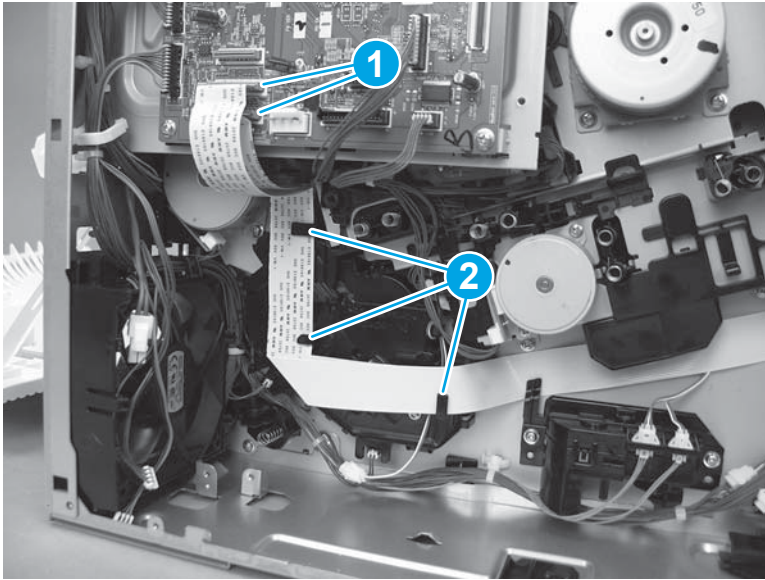

3. Connect two connectors (callout 1).

Figure 1-3921 Connect two connectors

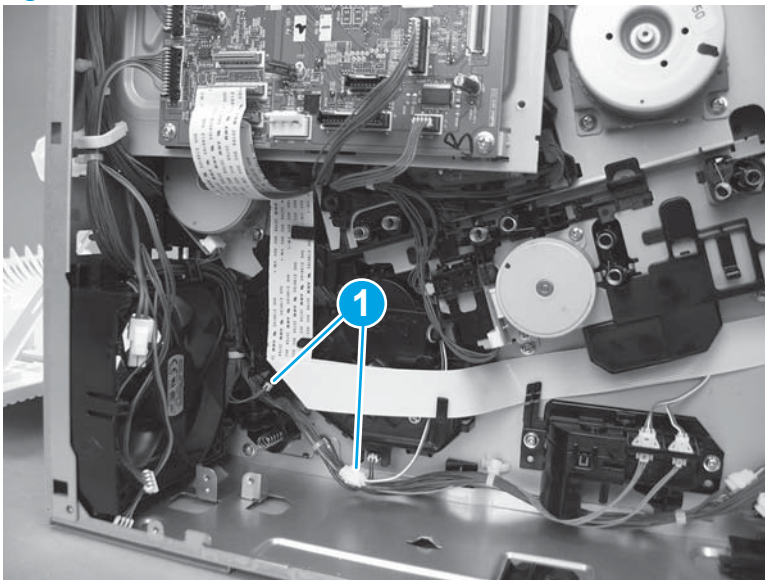

Step 36: Install the HVPSD

 **CAUTION:**  ESD-sensitive part.

1. Position the bottom right corner of the HVPSD (callout 1) behind the black tab, and then rotate it up and onto the printer (callout 2).

Figure 1-3922 Install the HVPSD

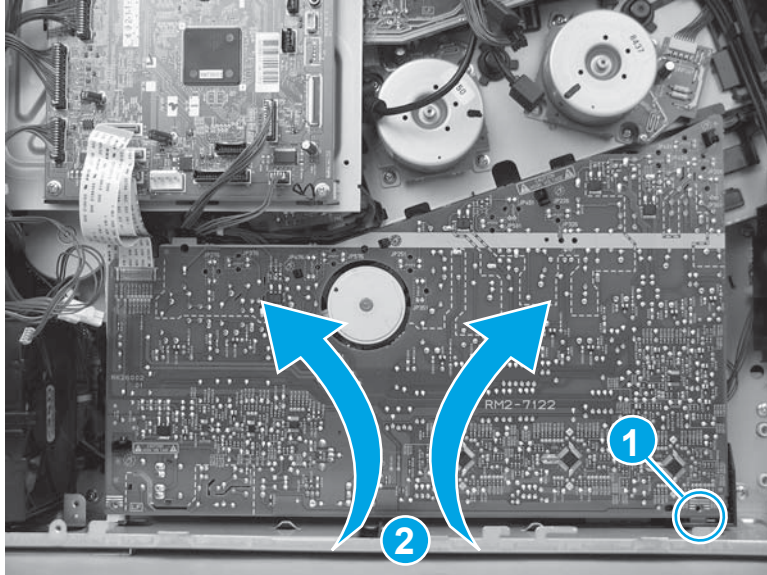

2. Press it onto five tabs (callout 2).

 **IMPORTANT:** Make sure that all five tabs snap into place.

Figure 1-3923 Press the tabs



3. Install two screws (callout 1), and then install one self tapping screw (callout 2) on the HVPSD.

Figure 1-3924 Install three screws

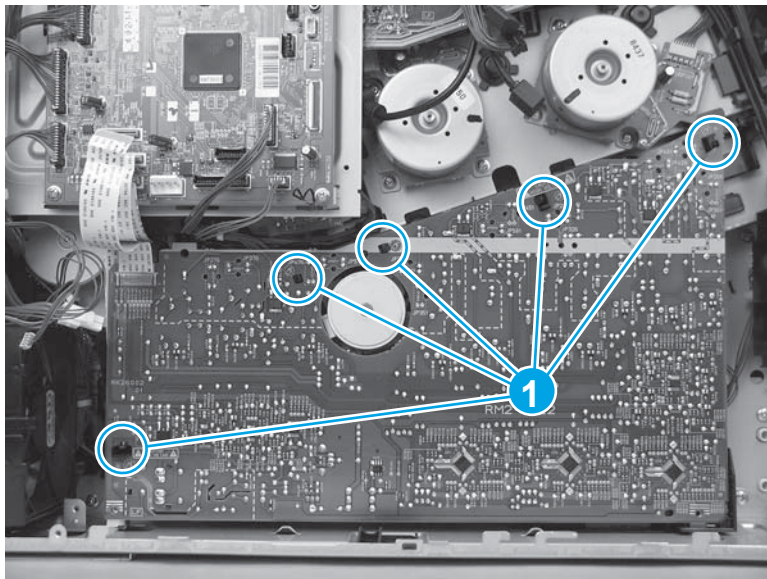
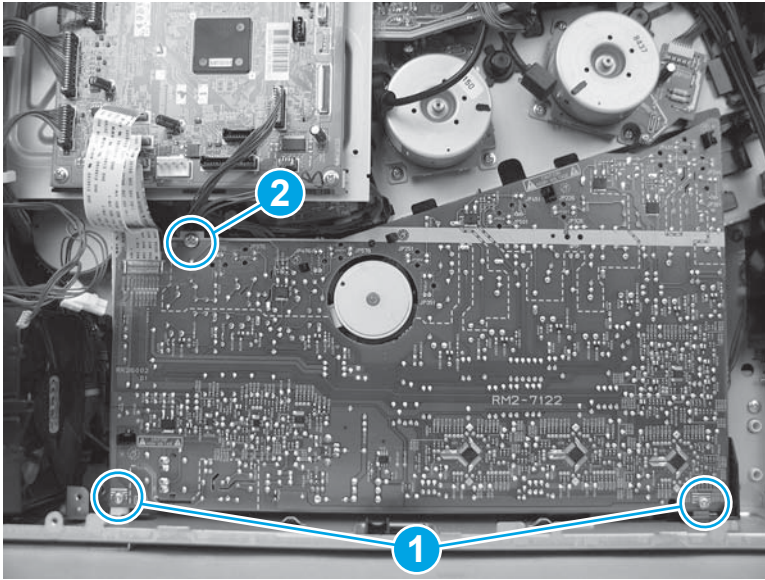

4. Connect one flat cable (callout 1) on the DC controller.

Figure 1-3925 Connect one flat cable

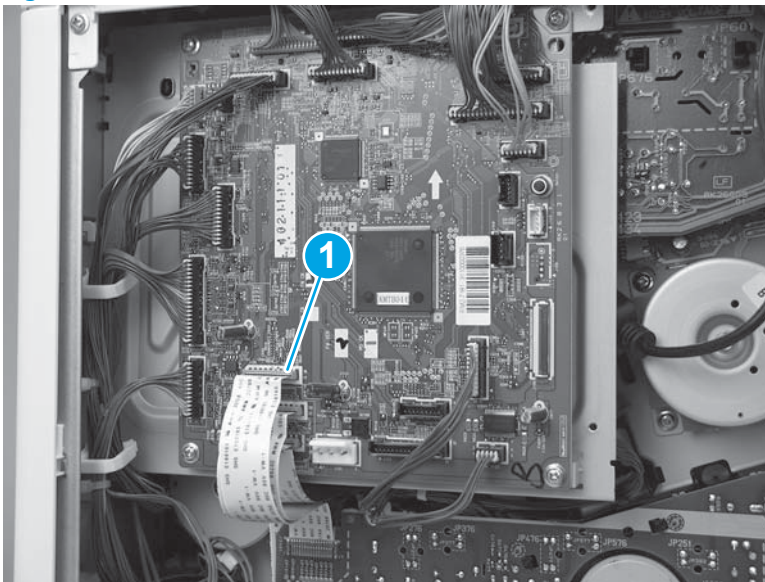

Step 37: Install the power-supply fan (FM1)

1. Slide the fan in (callout 1) and then down (callout 2) into the printer to install it.



NOTE: Make sure that the arrow (callout 3) embossed on the fan holder faces into the printer.

Figure 1-3926 Install the fan

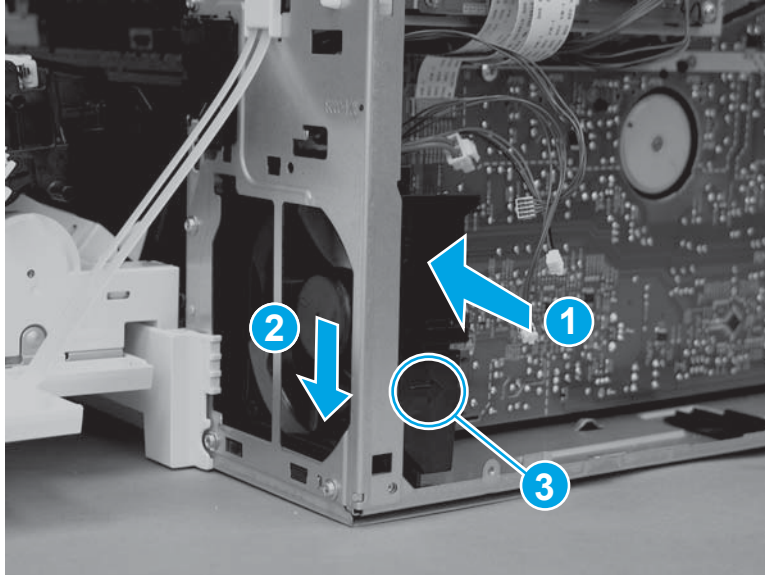

2. Place the wire harnesses in the retainer on the top of the fan bracket.

Figure 1-3927 Place the wire harnesses in the retainer

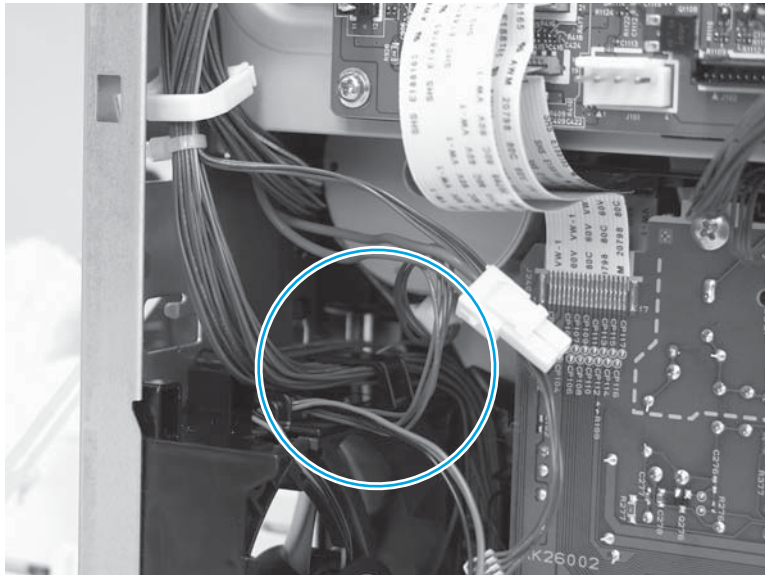

3. Install one screw (callout 1).

Figure 1-3928 Install one screw

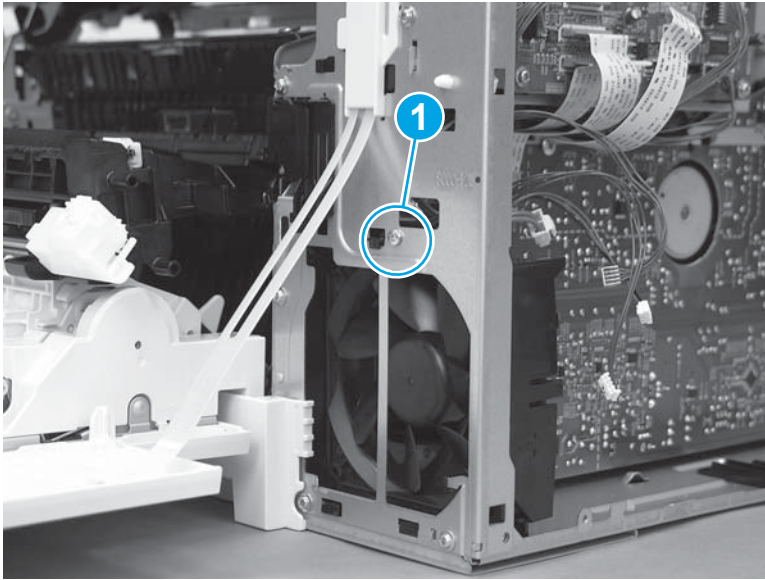

Step 38: Install the LVPS

 **CAUTION:**  ESD-sensitive part.

1. Position the bottom of the LVPS in the printer (callout 1) at a slight angle, and then rotate the top of it into the printer (callout 2) to install it.

Figure 1-3929 Install the LVPS

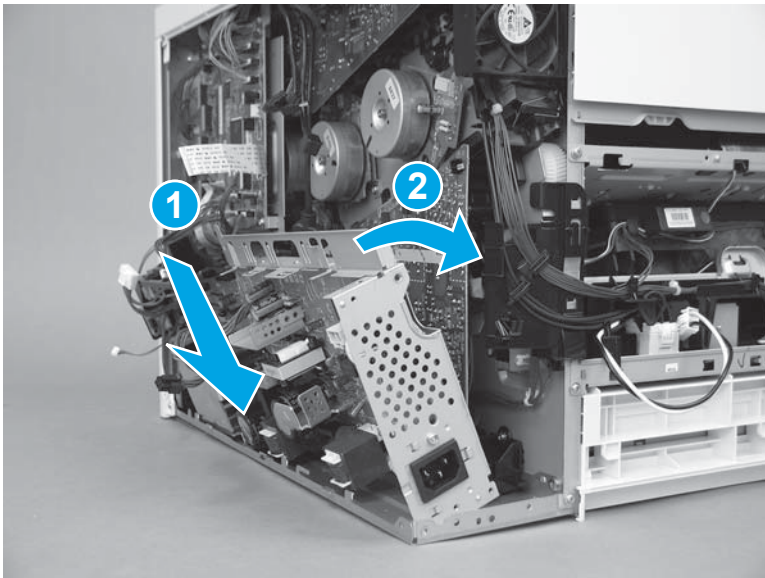

2. Install three screws (callout 1).

Figure 1-3930 Install three screws

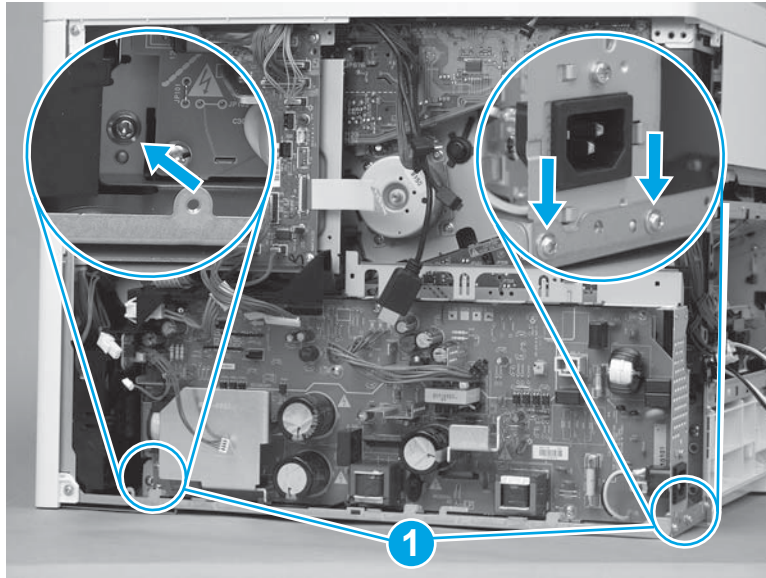

3. Pass the wire harnesses from the DC controller to the LVPS through the opening in the chassis (callout 1), and then install the wire harnesses in the retainer (callout 2).

Figure 1-3931 Pass the wire harnesses through the opening

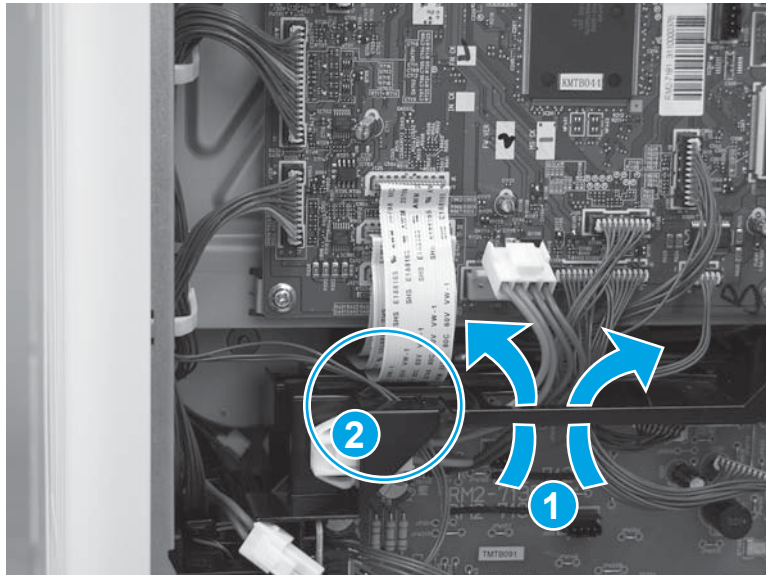

4. Connect three connectors on the DC controller (callout 1), and then connect four connectors (callout 2) on the LVPS.

Figure 1-3932 Connect seven connectors

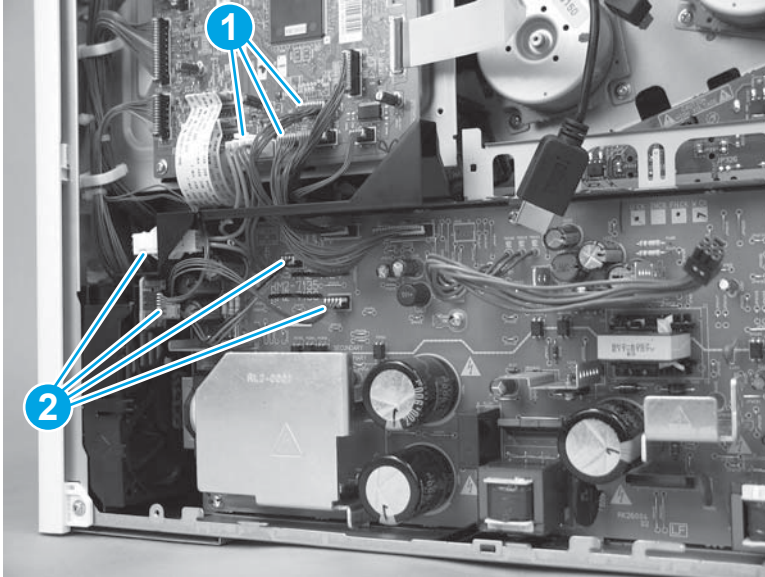

5. Pass the wire harness through the opening (callout 1) in the chassis, and then connect one wire harness (callout 2).

Figure 1-3933 Connect one wire harness

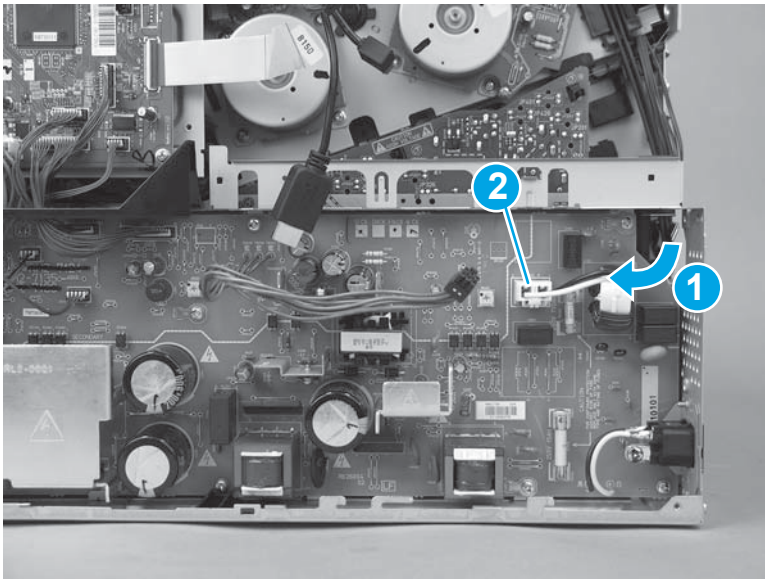

Step 39: Install the formatter case

1. Pass the wire harnesses through the opening in the formatter case.

Figure 1-3934 Pass the wire harnesses through the opening

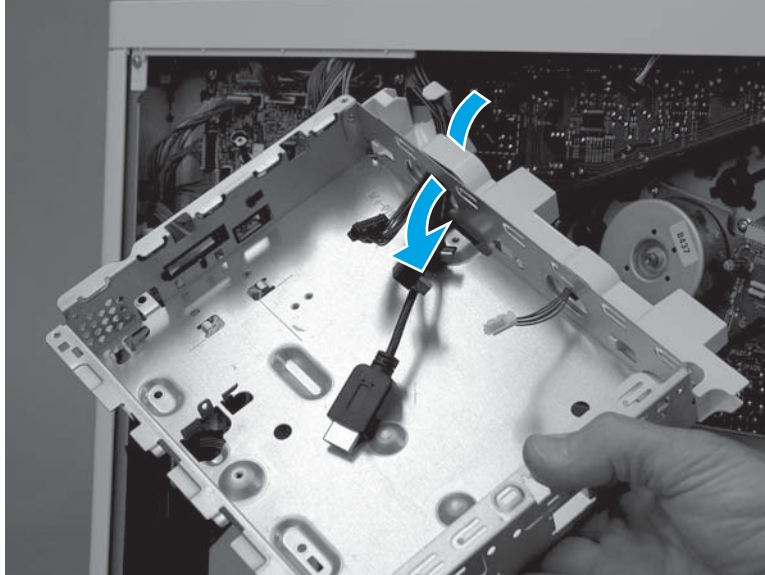

2. Position the top of the formatter case on the printer (callout 1), and then rotate the bottom of the case (callout 2) into the printer.

Figure 1-3935 Install the formatter case

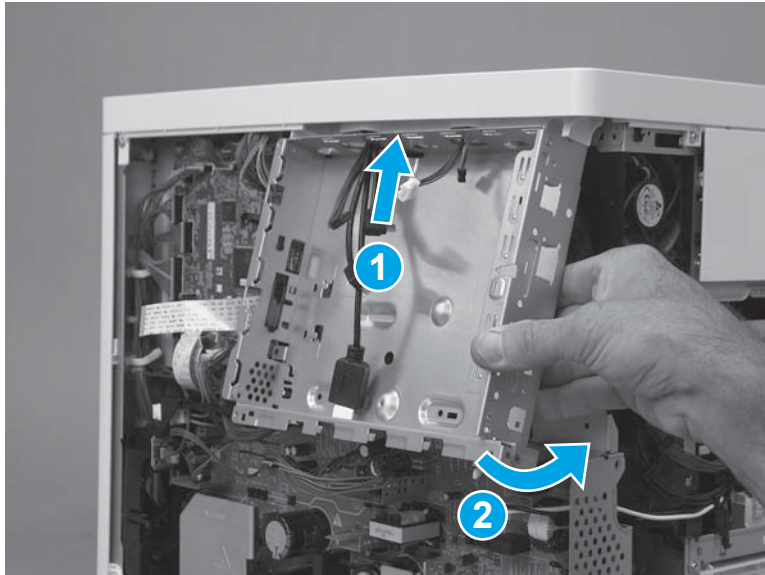

3. Install six screws (callout 1).

Figure 1-3936 Install six screws

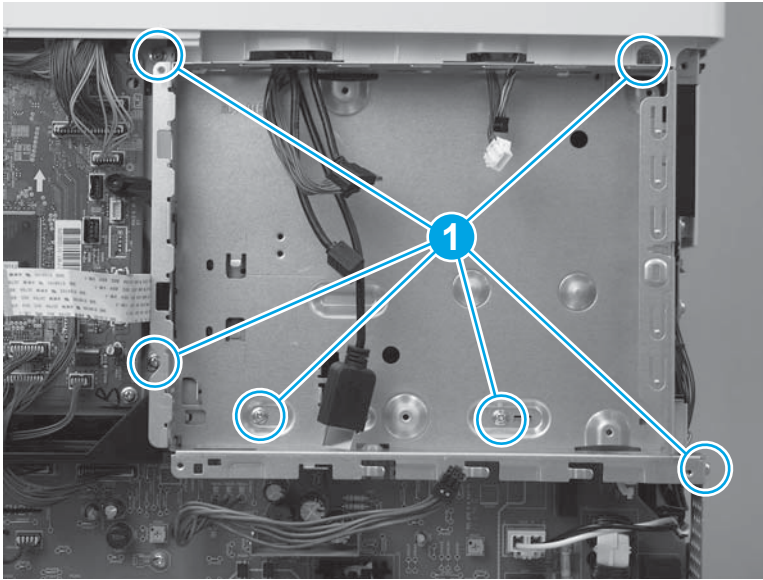

4. Pass two wire harnesses and one flat cable (callout 1) through the opening in the formatter case, and then install one wire harness in the retainer (callout 2).

 **IMPORTANT:** Make sure that the flat cable is securely fastened to the DC controller, and was not dislodged when the formatter case was removed.

Figure 1-3937 Install wire harnesses and flat cable



5. Position the LVPS cover on the printer, slide the cover to the left to install it, and then install two screws (callout 1).

Figure 1-3938 Install the LVPS cover

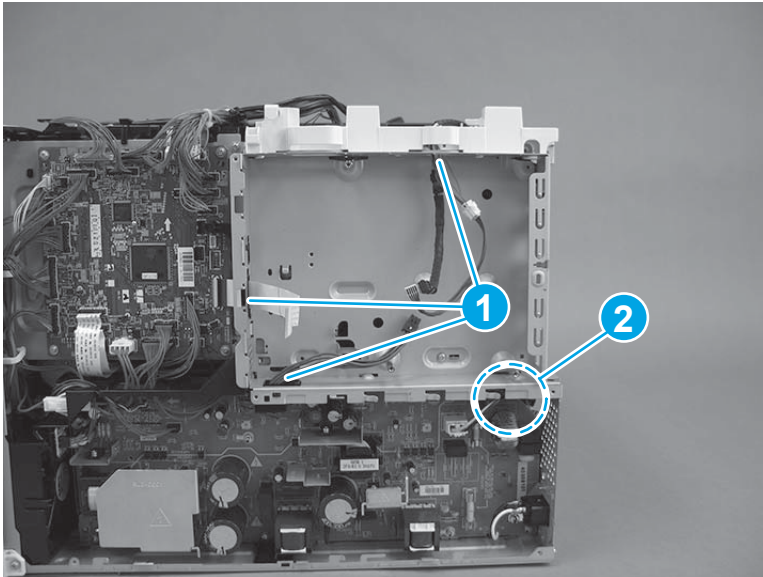
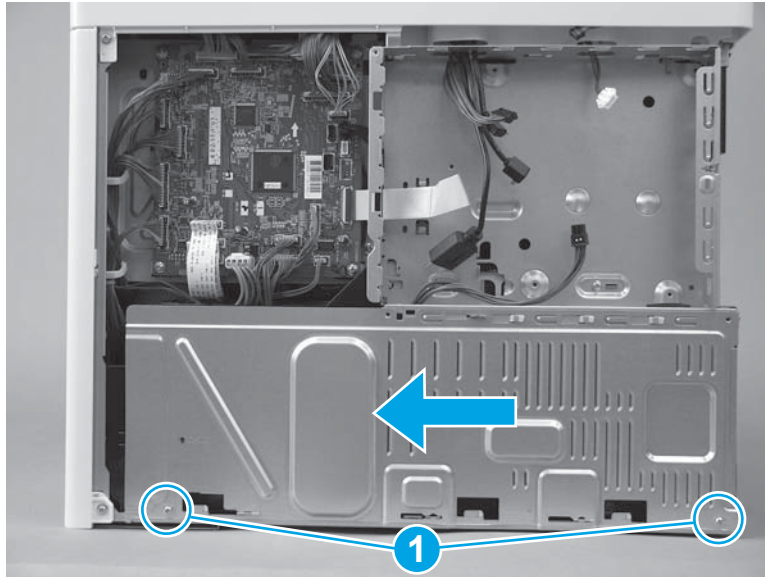

6. If no tape is affixed to the back of the flat cable, skip this step. If double-sided tape is affixed to the back of the flat cable, align the line (callout 1) on the cable with the edge (callout 2) of the opening in the sheet metal. Press to attach the flat cable to the formatter case.

Figure 1-3939 Attach the flat cable

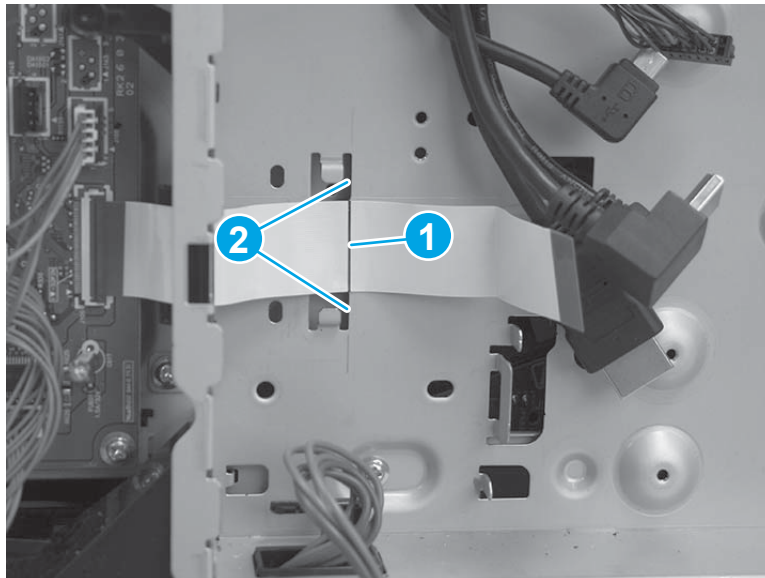

7. Position the bracket over the flat cable, and then slide the bracket to the left to install it. Make sure that the edges of the bracket fit under the sheet metal tabs (callout 1) on the formatter case and that the tabs (callout 2) snap into place.

Figure 1-3940 Position the bracket

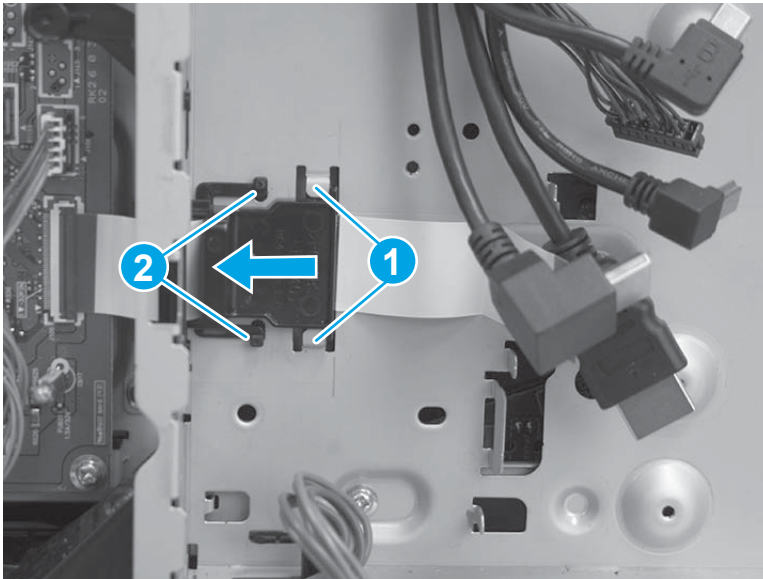

8. **M577 only:** Pass the wire harness (callout 1) through the openings in the formatter case (callout 2), and then connect one connector (callout 3).

Figure 1-3941 Connect one connector

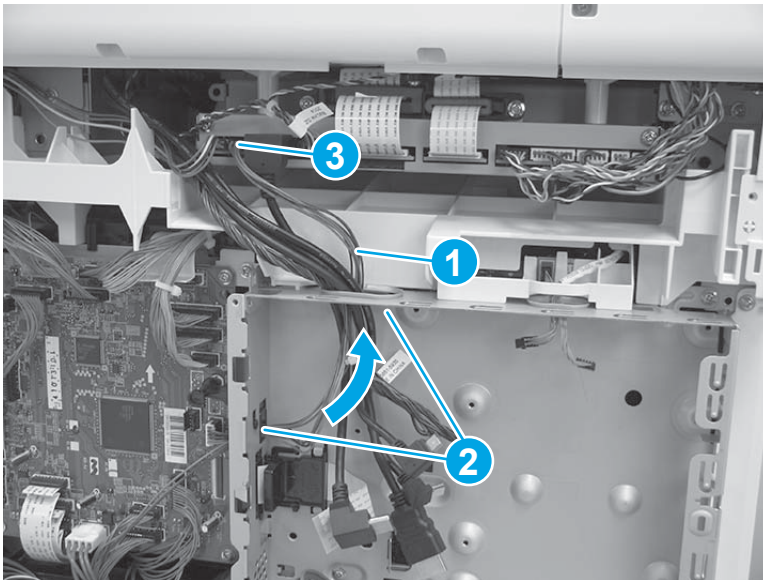

Step 40: Install the right rear cover

1. Position the cover on the printer.

Figure 1-3942 Install the cover

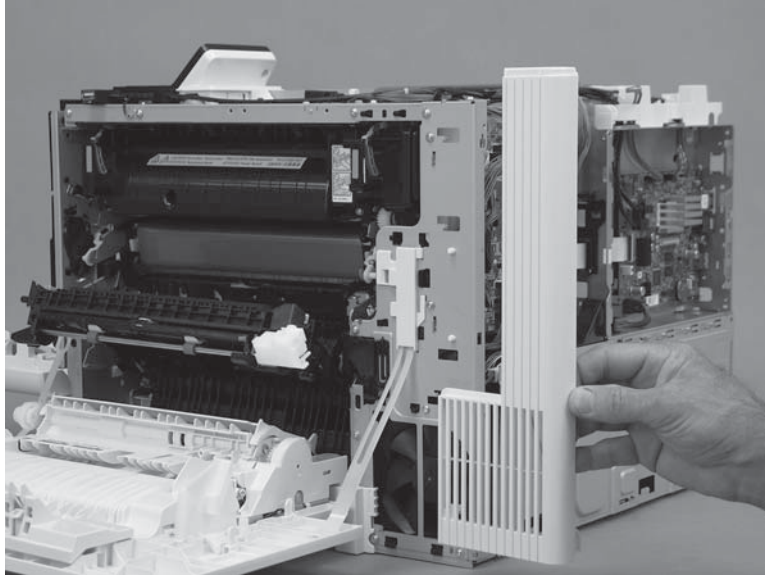

2. Slide the cover toward the right door (callout 1) to engage it with the printer, and then install one screw (callout 2).

Figure 1-3943 Install one screw

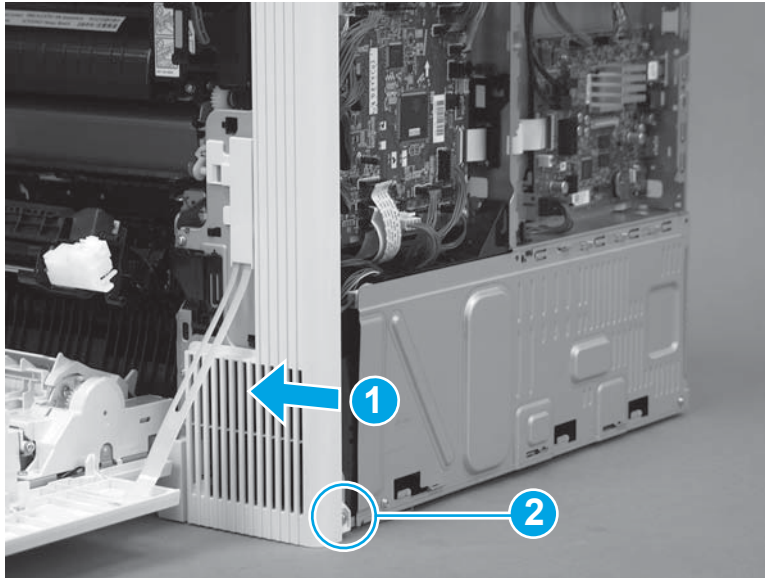

Step 41: Install the upper cover (M552 and M553)

 **NOTE:** This step is for the M552 and M553 models. For the M577 models, skip this step and go to [Step 42: Install the left cover on page 2203](#).

1. Position the cover on the printer.

 **NOTE:** For the M553x model, do not forget to pass the control-panel wire harness and USB cable through the opening in the cover.

Figure 1-3944 Install the cover



2. Push down on the rear corner of the cover to engage one tab (callout 1).

Figure 1-3945 Engage one tab

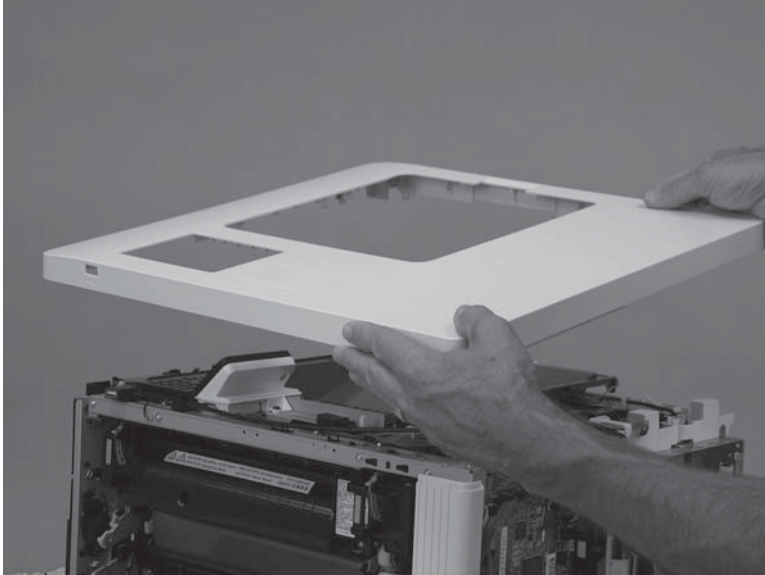
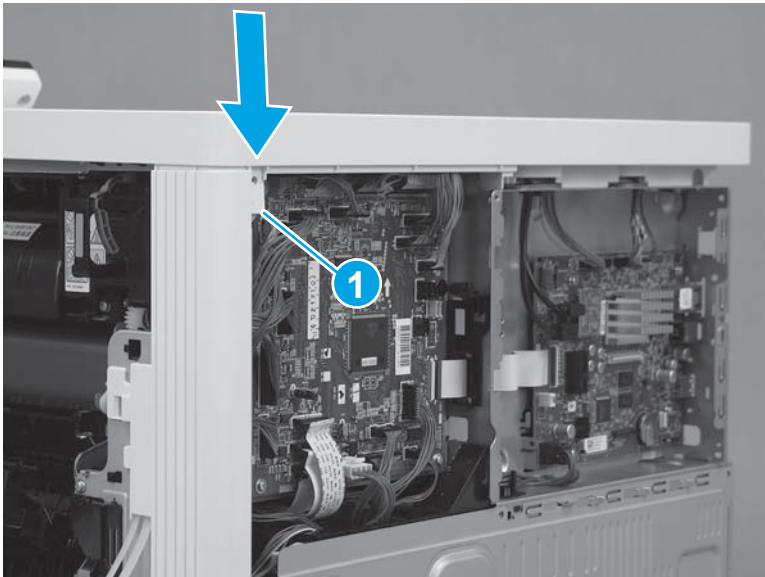

3. Push down on the front corner of the cover to engage one tab (callout 1), and then install one screw (callout 2).

 **NOTE:** This is a self-tapping plastic-thread screw. Make sure that this screw is used in this location when it is reinstalled.

Figure 1-3946 Engage one tab and install one screw



4. Install three screws (callout 1).

Figure 1-3947 Install three screws

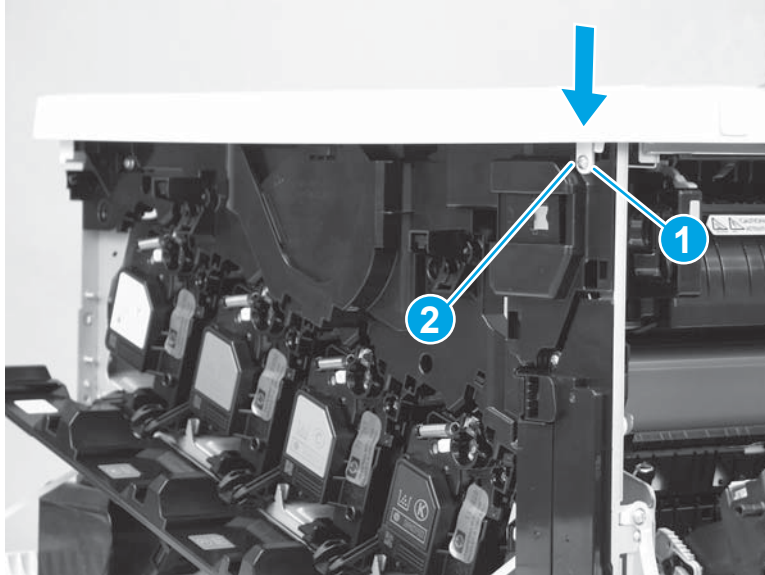
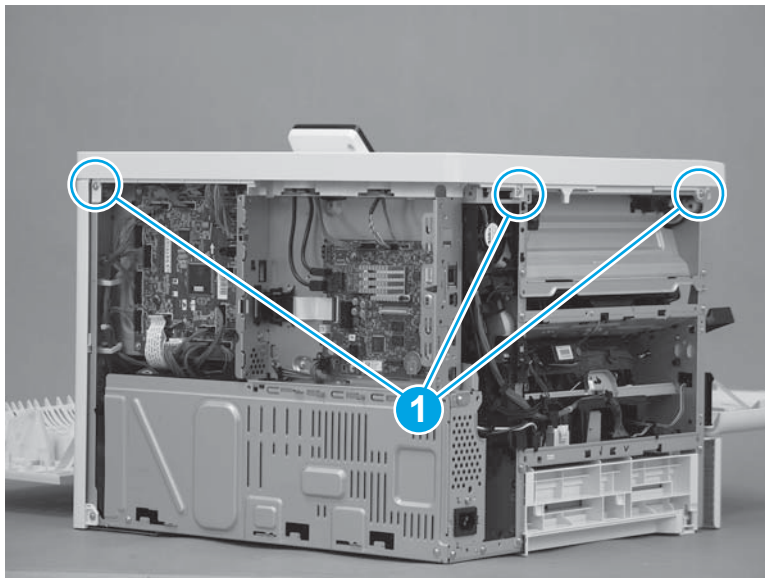

Step 42: Install the left cover

1. Position the cover on the printer.

 **NOTE:** Slightly offset the cover toward the rear of the printer.

Figure 1-3948 Install the cover

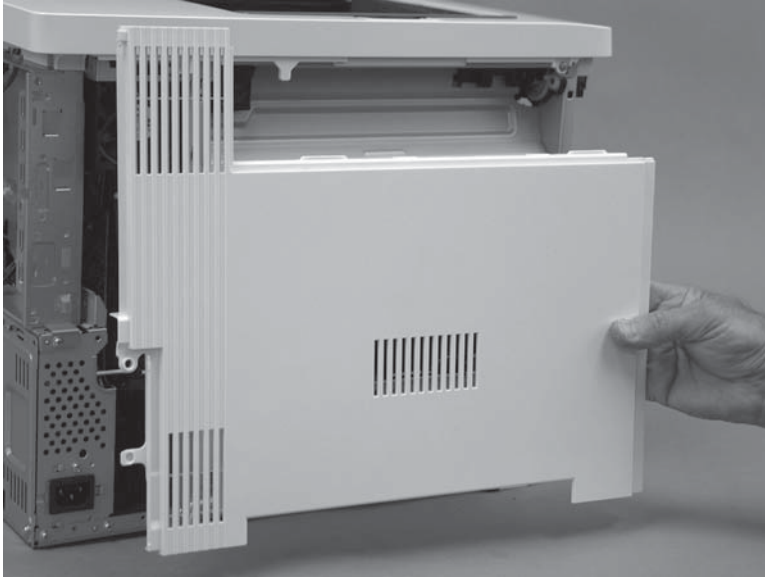

2. Slide the cover (callout 1) toward the front of the printer to engage it. Make sure that the tab (callout 2) snaps into place.

 **NOTE:** Locate the alignment pin (callout 3) on the cover from the front door side of the printer, and then make sure that it is fully engaged in the slot in the chassis.

 **TIP:** While sliding the cover into place, push in on the center of the cover (callout 1) to make sure that the hooks on the back of the cover engage with the slots in the chassis.

Figure 1-3949 Engage the cover



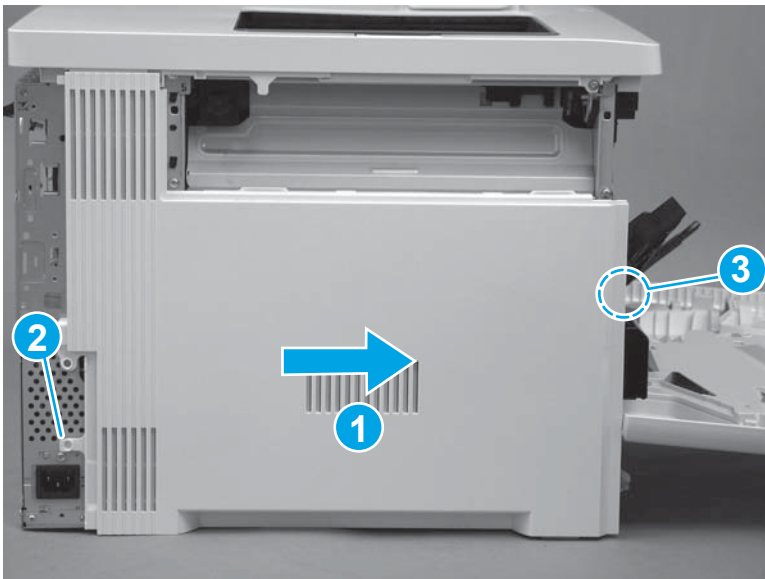

3. At the left side of the printer, install one screw (callout 1).

Figure 1-3950 Install one screw



Step 43: Install the right upper cover (M577)

 **NOTE:** This step is for the M577 models. For the M552 and M553 models, skip this step and go to [Step 50: Install the rear cover \(M552 and M553\) on page 2219](#).

 **NOTE:** The figures below show the image scanner installed. The procedures for removing and installing the right upper cover are the same whether the image scanner is installed or removed."

1. **M577c/f/z only:** Install the cables (callout 1) through the slot (callout 2) in the printer.

Figure 1-3951 Install the cables

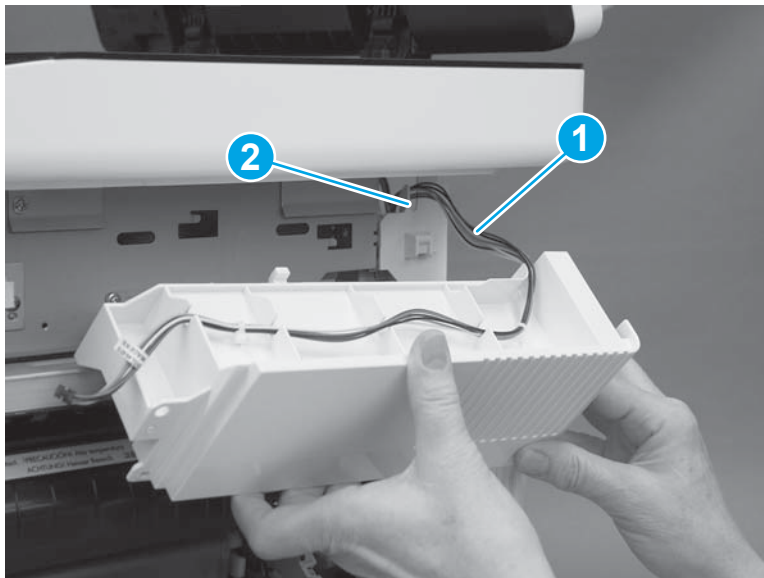

2. Position the hooks (callout 1) on the cover in the slots (callout 2) in the printer.

Figure 1-3952 Position the hooks

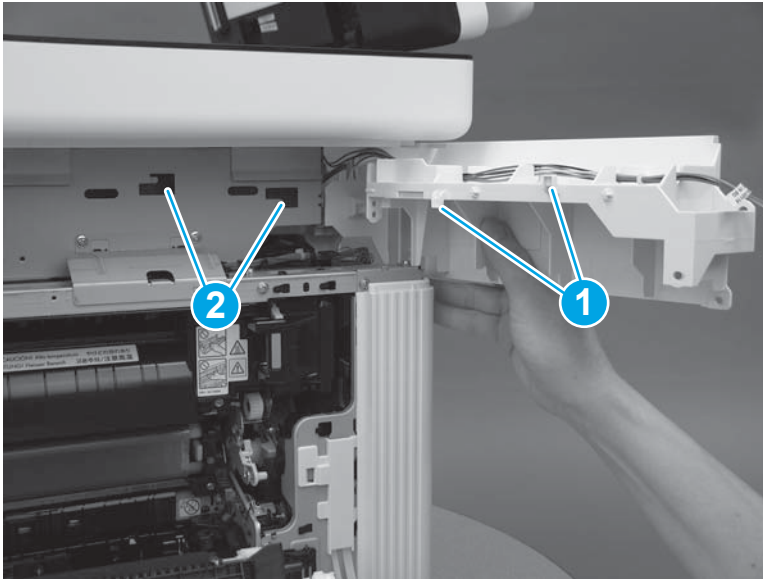

3. Slide the cover toward the front of the printer to install it.

Figure 1-3953 Install the cover

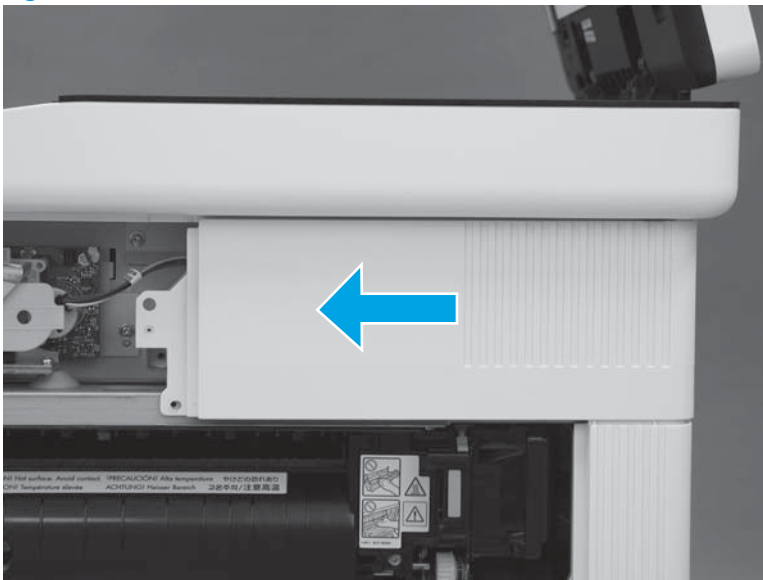

4. At the back of the printer, install one screw (callout 1).

M577c/f/z only: Connect one connector (callout 2), if the integrated scanner assembly is installed.

 **TIP:** This screw is smaller than the screws installed in the next step. Make sure that this screw is installed in the correct position.

Figure 1-3954 Install one screw and connector



5. At the right side of the printer, install two screws (callout 1).

M577c/f/z only: Connect one connector (callout 2), if the stapler is installed.

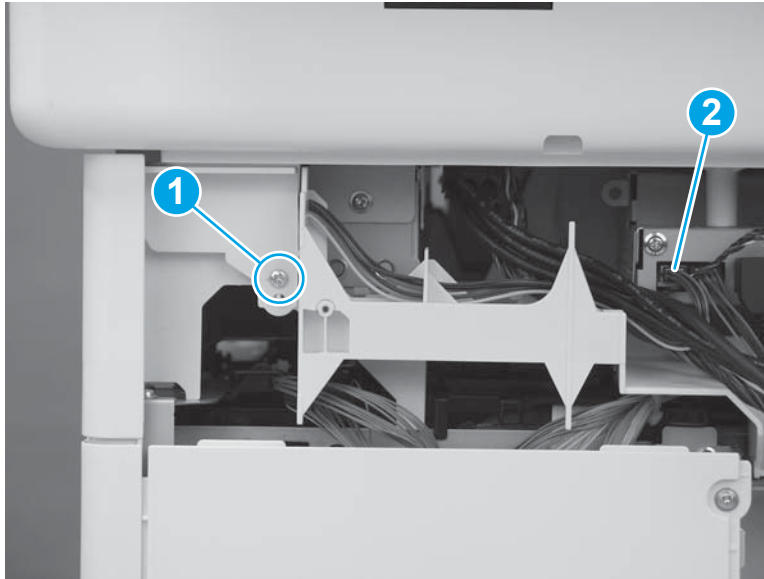
Figure 1-3955 Install one screw and connector

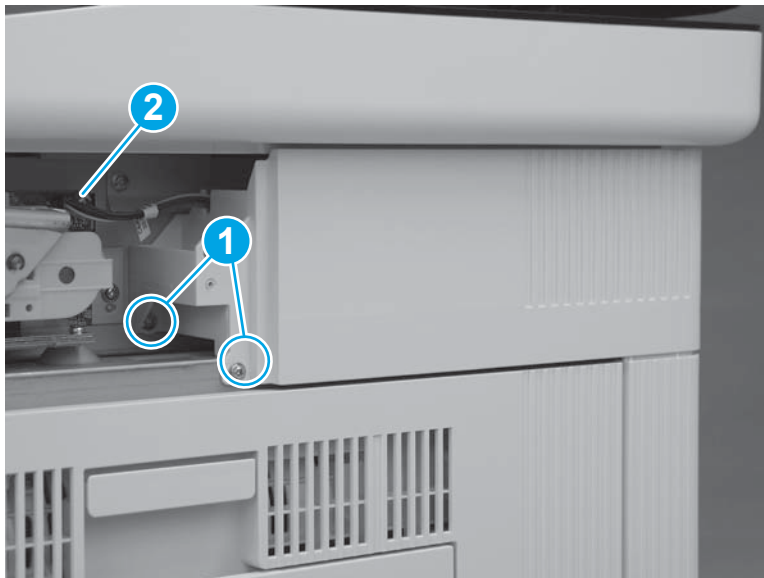

Step 44: Install the integrated scanner assembly (ISA) (M577)

 **NOTE:** This step is for the M577 models. For the M552 and M553 models, skip this step and go to [Step 50: Install the rear cover \(M552 and M553\) on page 2219.](#)



NOTE: The ISA includes the document feeder, image scanner, scanner control board (SCB), control panel, keyboard (M577c/z) and NFC PCA (M577z).

1. Before proceeding, locate the mounting pins (callout 1) on the bottom of the ISA and the slots (callout 2) on the printer base.

Figure 1-3956 Locate the ISA mounting pins and slots

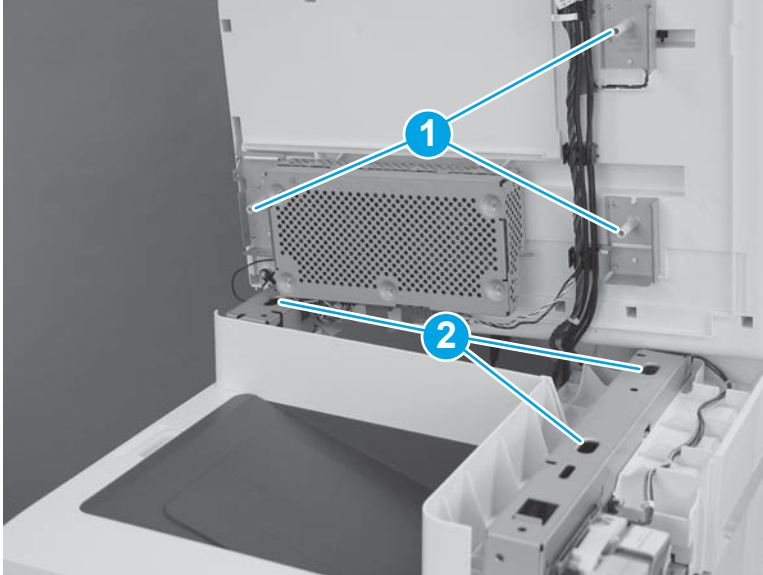

2. Position the ISA on the printer base with the pins in the slots.



NOTE: To locate the pins and slots, see [Figure 1-395 Locate the ISA mounting pins and slots on page 250](#).

When installing the ISA, carefully pass the cables through the opening in the top of the formatter case.

Figure 1-3957 Install the ISA

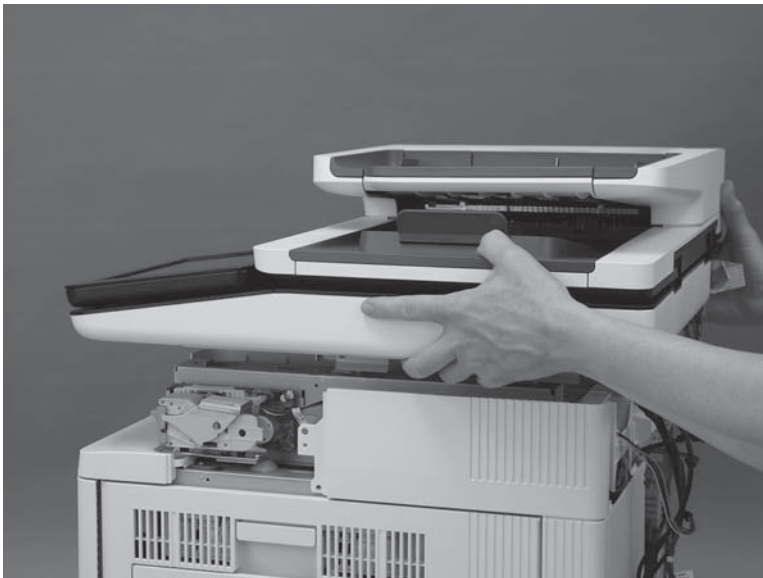

3. Slightly slide the ISA towards the front of the printer to engage it.

Figure 1-3958 Slide the ISA towards the front of the printer

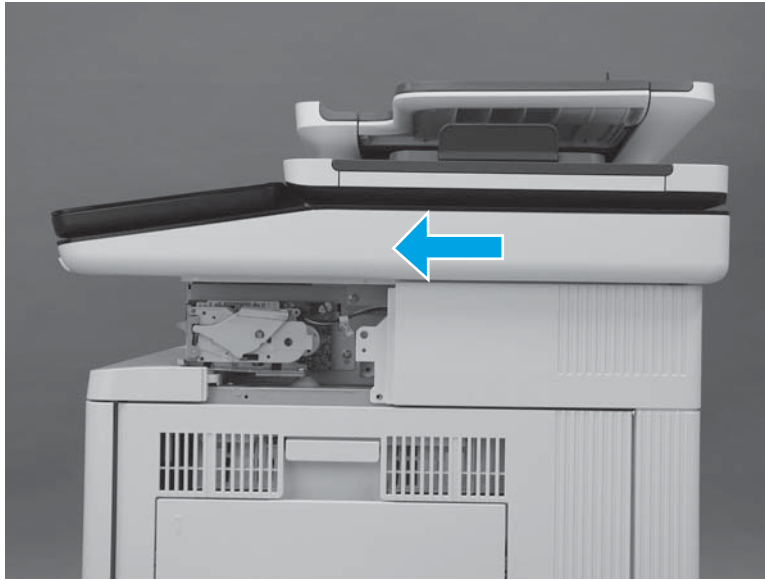

4. At the left side of the printer, install one screw (callout 1).

Figure 1-3959 Install one screw

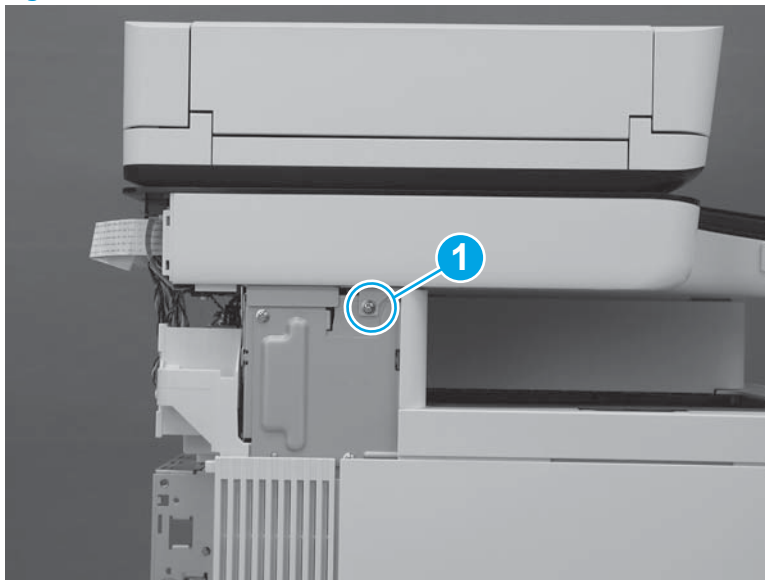

5. At the back of the printer, install two screws (callout 1).

Figure 1-3960 Install two screws

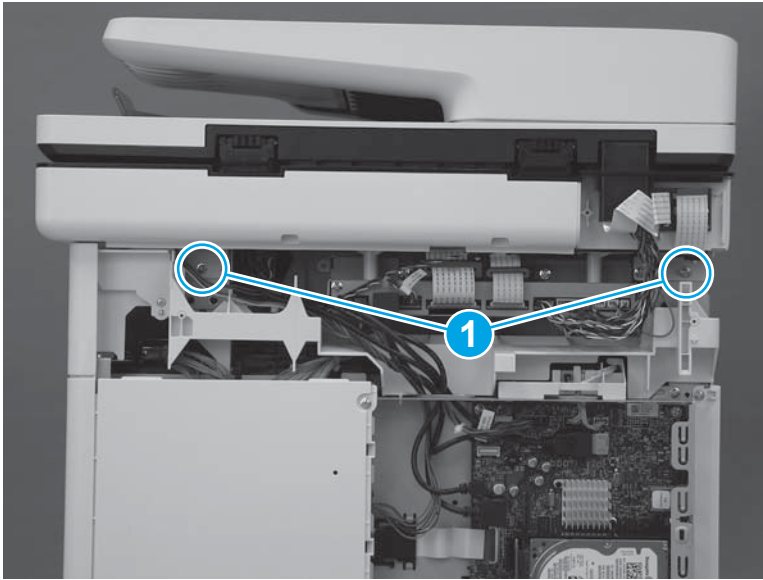

6. At the right side of the printer, install one screw (callout 1).

Figure 1-3961 Install one screw

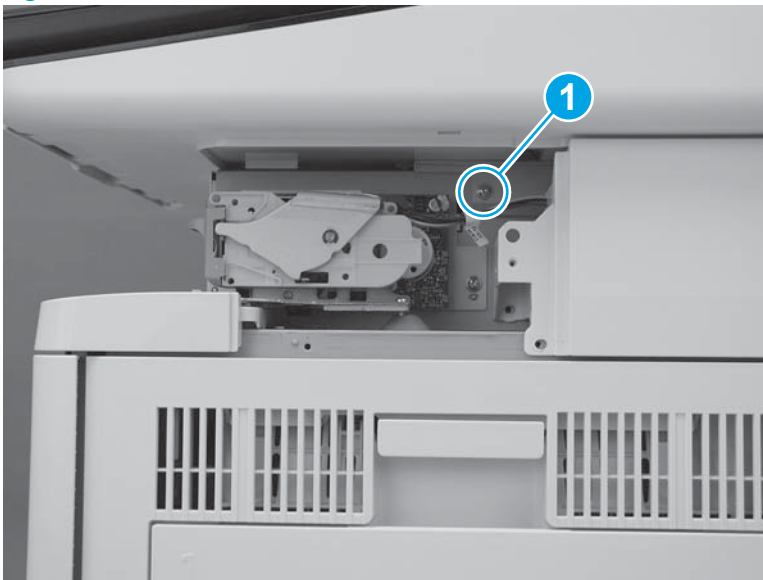

7. Connect two connectors on the scanner control board (callout 1).

M577c/f/z only: Connect one connector for the stapler on the scanner control board (callout 2).

Figure 1-3962 Connect connectors

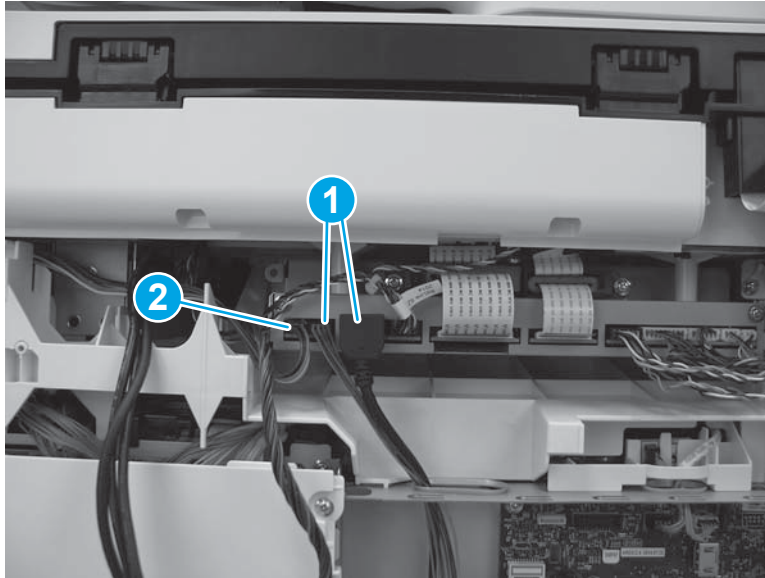

Step 45: Install the stapler cover assembly (M577c/f/z)

 **NOTE:** This step is for the M577c/f/z models only. For the M577dn model, skip this step and go to [Step 46: Install the right front upper cover \(M577dn\) on page 2212](#).

For the M552 and M553 models, skip this step and go to [Step 50: Install the rear cover \(M552 and M553\) on page 2219](#).

1. Install the tabs (callout 1) on the cover in the slots (callout 2) in the printer.

Figure 1-3963 Install two tabs



2. Press the cover toward the left side of the printer until it snaps into place.

Figure 1-3964 Install the cover assembly



3. Install one screw (callout 1).

 **IMPORTANT:** This is a self-tapping screw for plastic. Rotate it counterclockwise to align it with the existing thread pattern, and then carefully turn it clockwise to tighten. Do not overtighten. This will prevent stripping the threads inside the screw hole.

Figure 1-3965 Install one screw



Step 46: Install the right front upper cover (M577dn)

 **NOTE:** This step is for the M577dn model only. For the M577c/f/z models, skip this step and go to [Step 47: Install the left upper cover \(M577\) on page 2214](#).

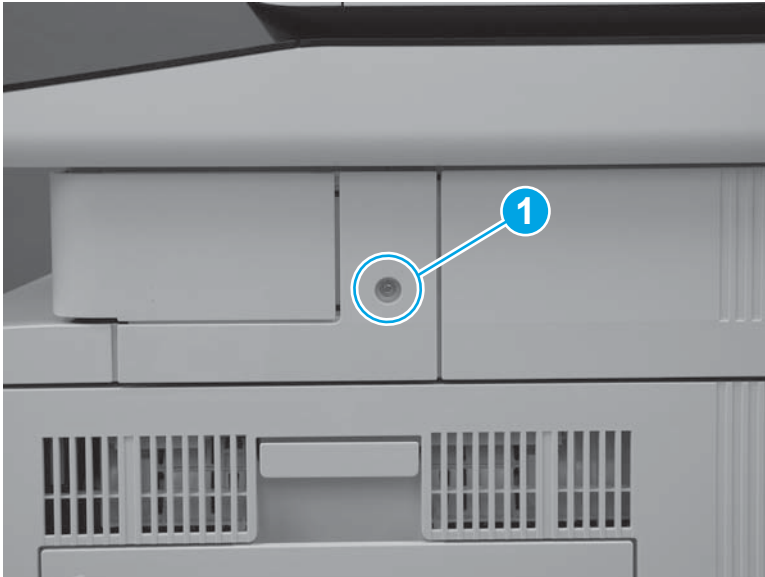
For the M552 and M553 models, skip this step and go to [Step 50: Install the rear cover \(M552 and M553\) on page 2219](#).

1. Slide the cover toward the left side of the printer to install it. Make sure that the slots (callout 1) in the cover fit over the tabs (callout 2) on the inside of the paper feeder cover.

Figure 1-3966 Install the cover

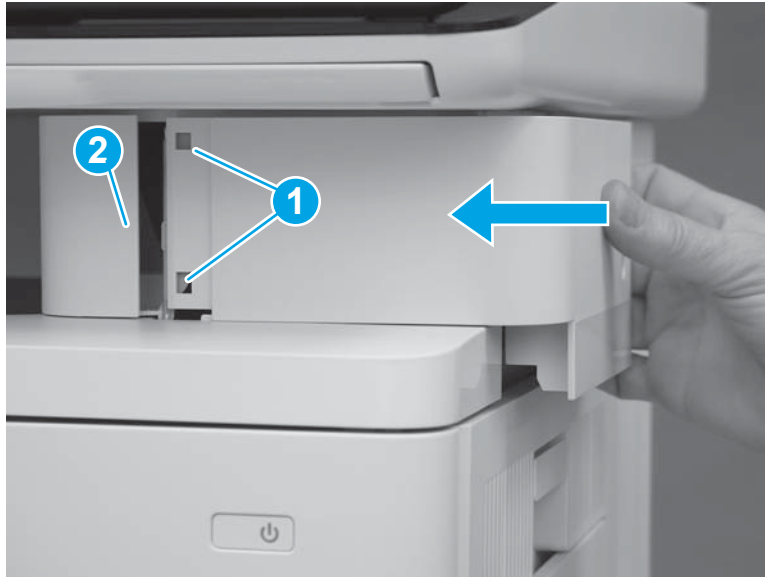

2. Press the right front upper cover (callout 1) and the paper feeder cover (callout 2) together until the tabs on the inside of the covers snap into place.

Figure 1-3967 Press the cover



3. Install one screw (callout 1).

Figure 1-3968 Install one screw

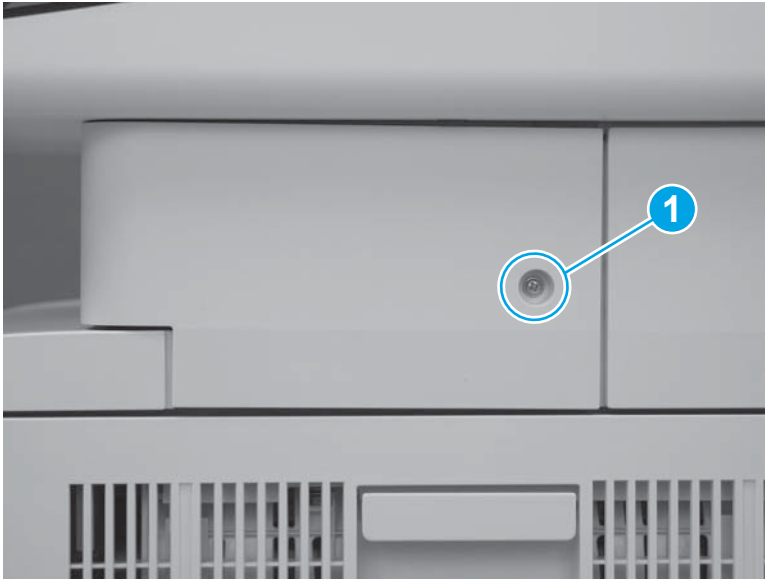

Step 47: Install the left upper cover (M577)



NOTE: This step is for the M577 models. For the M552 and M553 models, skip this step and go to [Step 50: Install the rear cover \(M552 and M553\) on page 2219](#).

1. Position the tab (callout 1) on the lower edge of the cover behind the left cover (callout 2).

Figure 1-3969 Position the tab

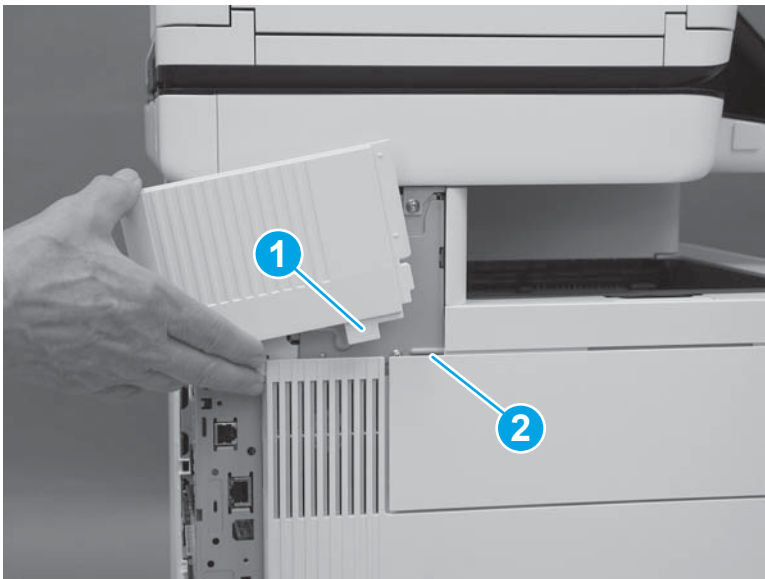

2. Slide the cover toward the front of the printer to install it. Make sure that the edge (callout 1) of the cover fits behind the edge (callout 2) of the top rear cover.

Figure 1-3970 Slide the cover

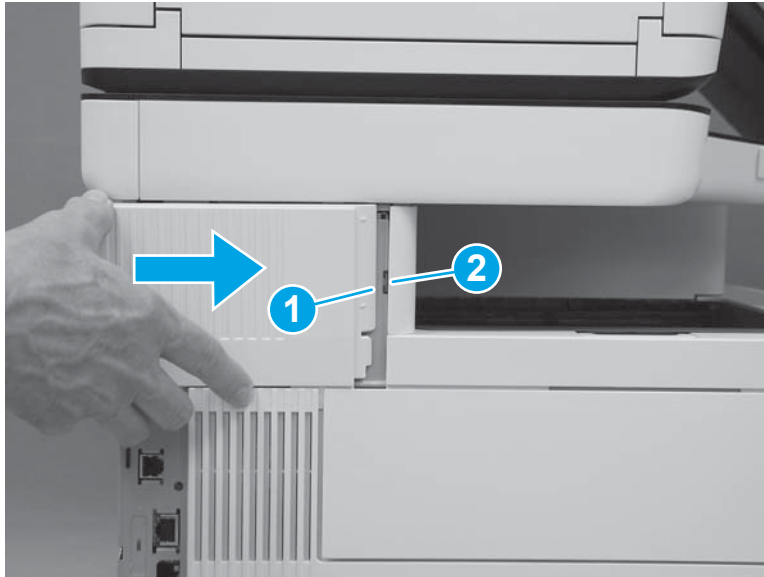

3. Make sure that the tab (callout 1) is fully installed.

Figure 1-3971 Check the tab

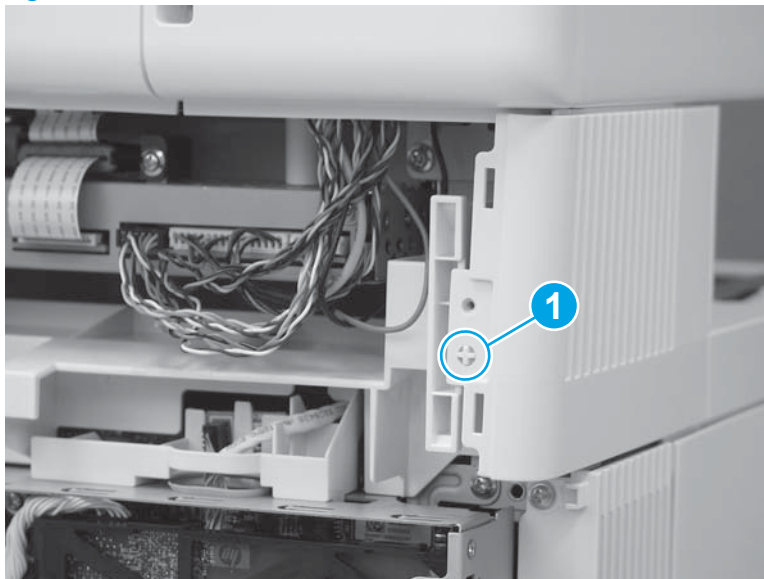

Step 48: Install the rear cover (M577)

 **NOTE:** This step is for the M577 models. For the M552 and M553 models, skip this step and go to [Step 50: Install the rear cover \(M552 and M553\) on page 2219](#).

1. Position the hooks (callout 1) on the cover in the slots (callout 2) in the printer.

Figure 1-3972 Position the hooks

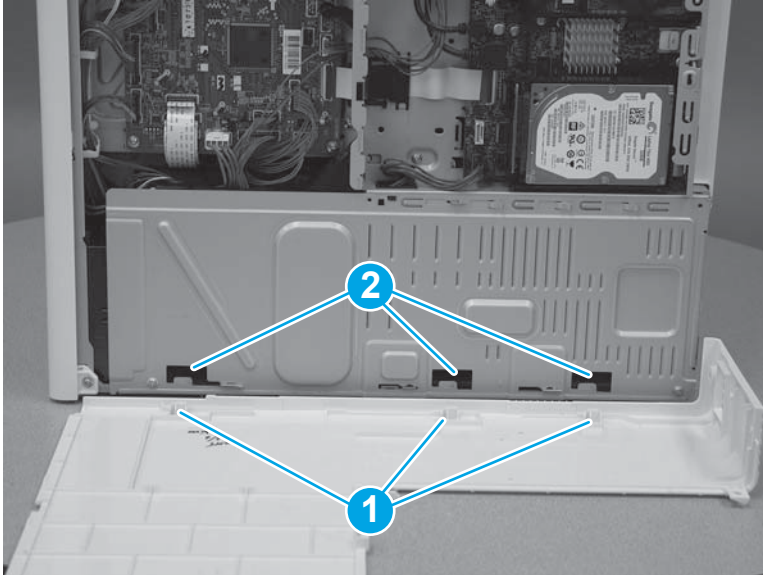

2. Position the back edge (callout 1) of the rear cover behind the edge (callout 2) of the right rear cover. Slide the cover to the left to install it.

Figure 1-3973 Install the cover

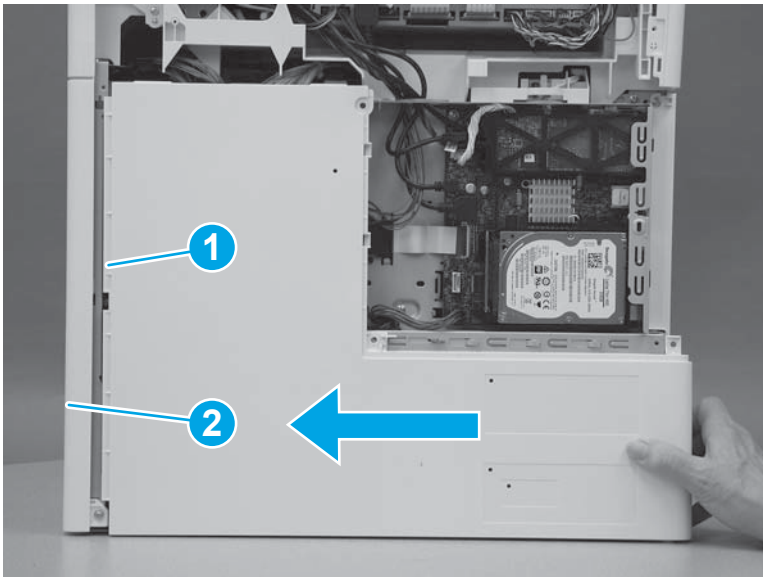

3. Install four screws (callout 1).

Figure 1-3974 Install four screws cover

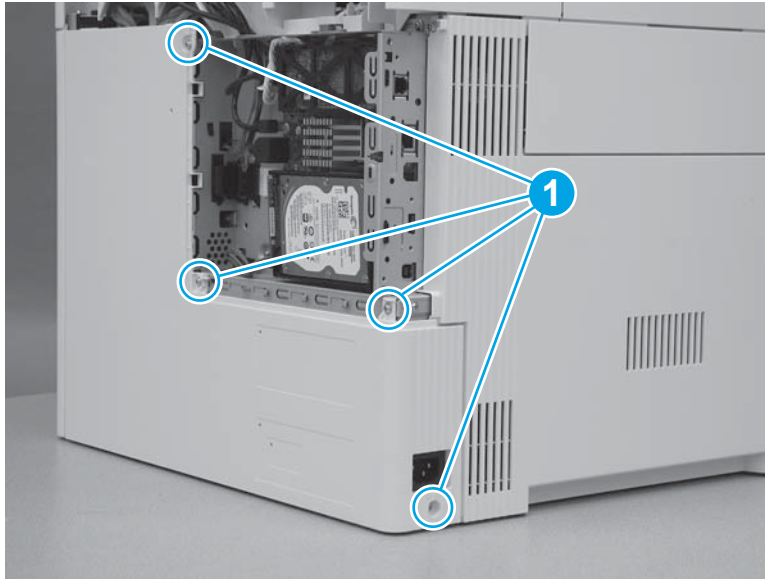

Step 49: Install the rear upper cover (M577)

 **NOTE:** This step is for the M577 models. For the M552 and M553 models, skip this step and go to [Step 50: Install the rear cover \(M552 and M553\) on page 2219](#).

1. Align the ridge (callout 1) on the lower edge of the rear upper cover in front of the tabs (callout 2) on the top edge of the rear cover.

Figure 1-3975 Align the cover

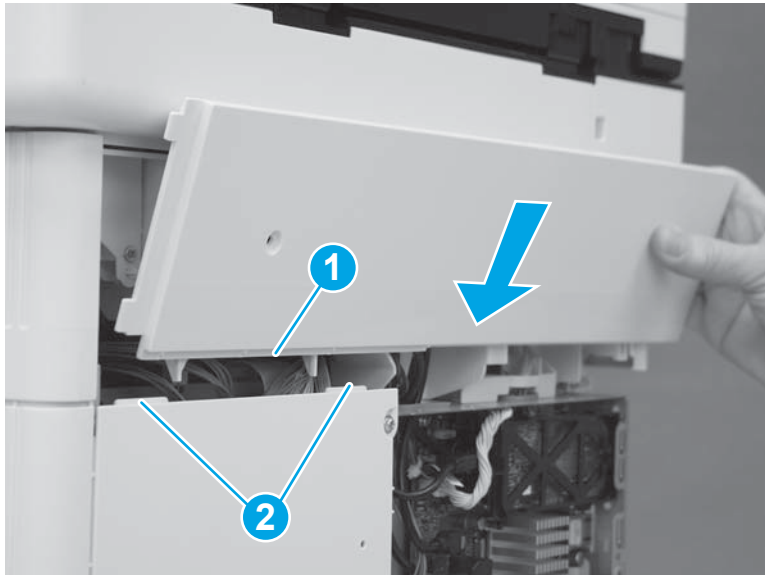

2. Rotate the top of the cover toward the printer.

Figure 1-3976 Rotate the top of the cover

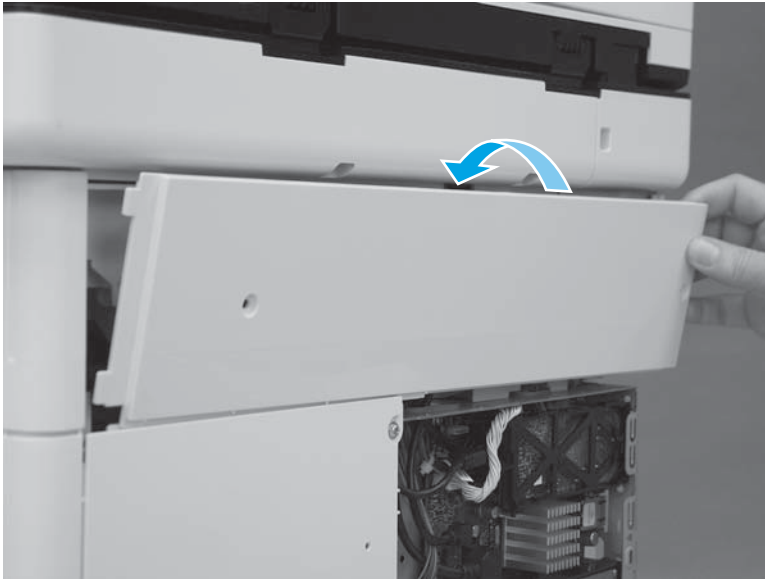

3. Slide the cover to the left (callout 1). Make sure that the tabs (callout 2) on the upper rear cover slide behind the edge (callout 3) of the right upper cover. Make sure that the cover is fully seated.

Figure 1-3977 Slide the cover

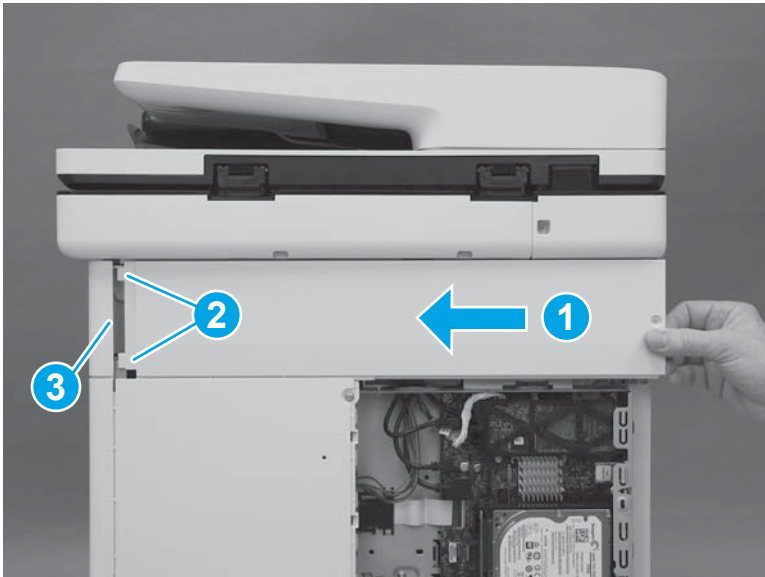

4. Install two screws (callout 1).

 **IMPORTANT:** These two screws are self-tapping screws for plastic. Rotate them counterclockwise to align them with the existing thread pattern, and then carefully turn them clockwise to tighten. Do not overtighten. This will prevent stripping the threads inside the screw holes.

Figure 1-3978 Install two screws



Step 50: Install the rear cover (M552 and M553)

 **NOTE:** This step is for the M552 and M553 models. For the M577 models, skip this step and go to [Step 51: Install the formatter \(M577\) on page 2220](#).

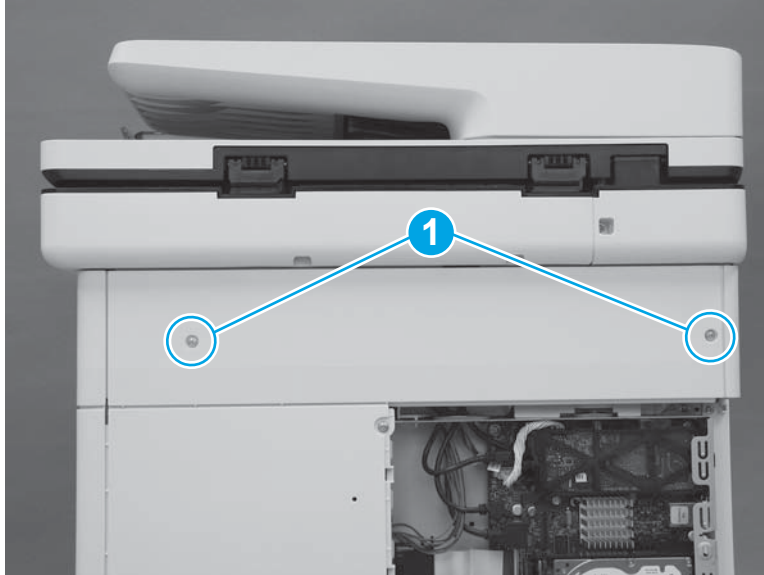
1. Position the top of the cover under the upper cover (callout 1), rotate the bottom of the cover onto the chassis (callout 2), and then slide the cover to the left (callout 3) to install it.

Figure 1-3979 Install the cover

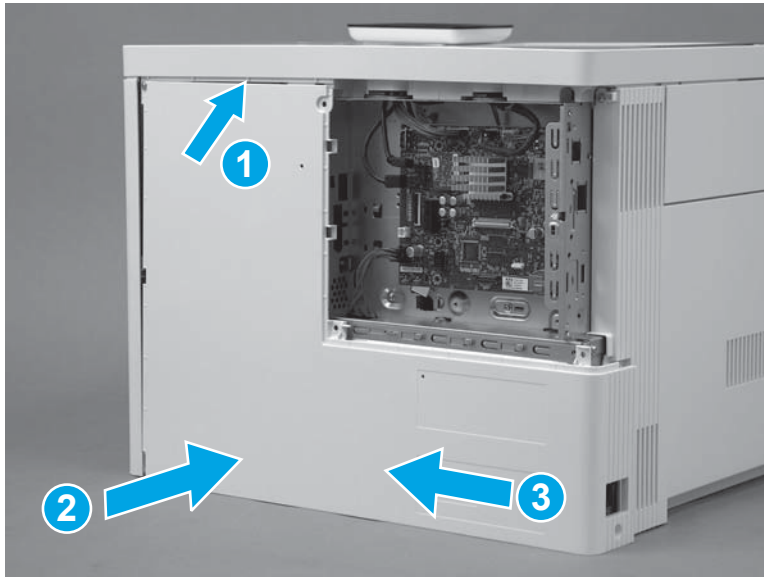

2. Install four screws (callout 1).

Figure 1-3980 Install four screws cover

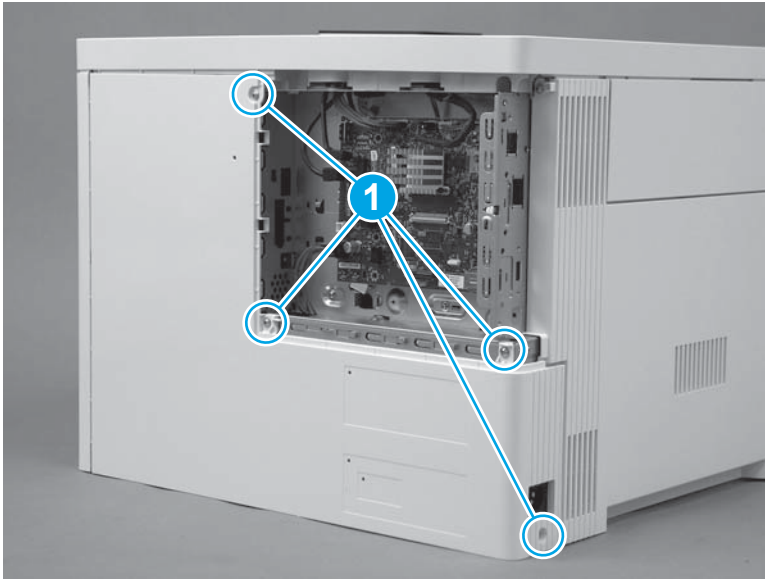

Step 51: Install the formatter (M577)



NOTE: This step is for the M577 models. For the M552 and M553 models, skip this step and to go [Step 54: Install the formatter \(M552 and M553\) on page 2225](#).



CAUTION:  ESD-sensitive part.

1. Position the formatter in the printer. Make sure that the network port (callout 1) fits through the opening (callout 2) in the formatter case.

Figure 1-3981 Install the formatter

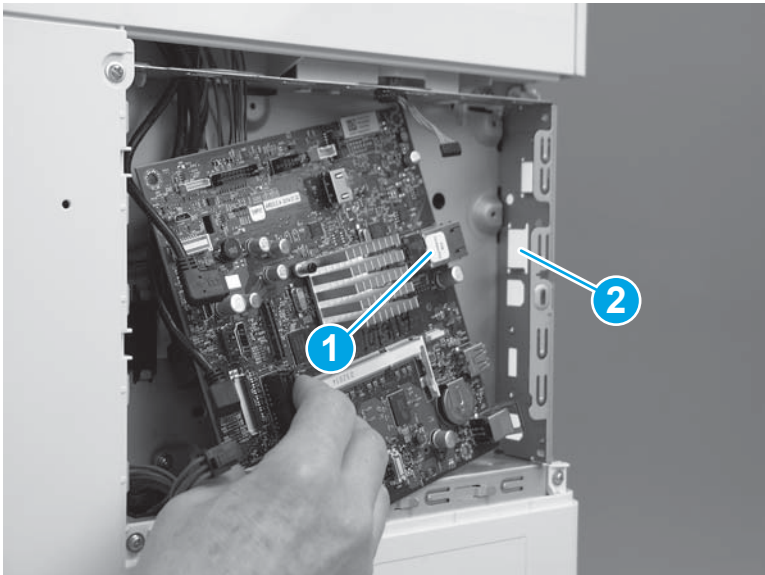

2. Install four screws (callout 1).

Figure 1-3982 Install four screws

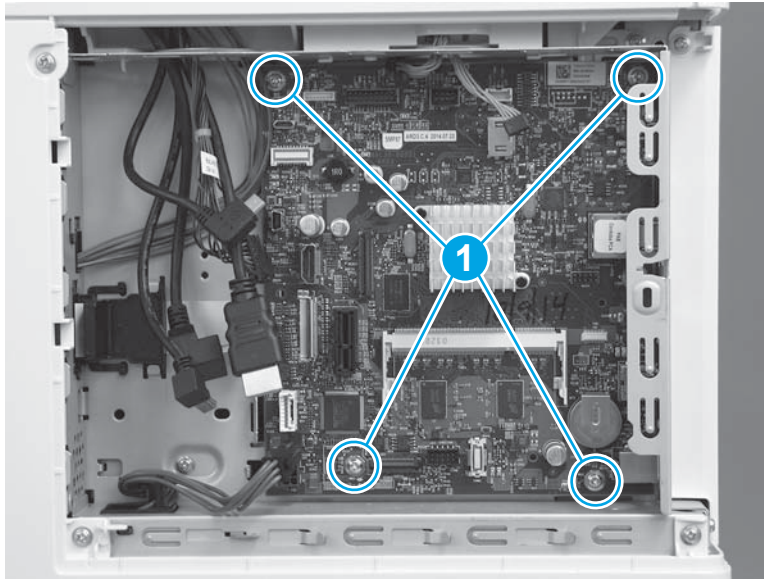

3. Connect all of the connectors on the formatter.

The following connectors are empty:

- All models: J1 (this connector is empty unless the optional DIMM is installed)
- All models: J3
- M577dn: J15 (this is the fax connector for the M577f/z/c models)
- All models: J21 (this connector is empty unless the optional internal USB ports component is installed)
- All models: J23
- All models: J24
- All models: J51
- All models: J57
- All models: J97
- All models: J98 (this connector is empty unless the optional trusted platform module (TPM) is installed)

 **IMPORTANT:** The flat-cable connector (callout 1) is a Zero Insertion Force (ZIF) connector that uses a hinged retainer to secure the flat cable. The hinged retainer must be opened to install the flat cable, and then closed after the cable is installed.

Figure 1-3983 Connect all connectors



Step 52: Install the fax PCA (M577c/f/z)

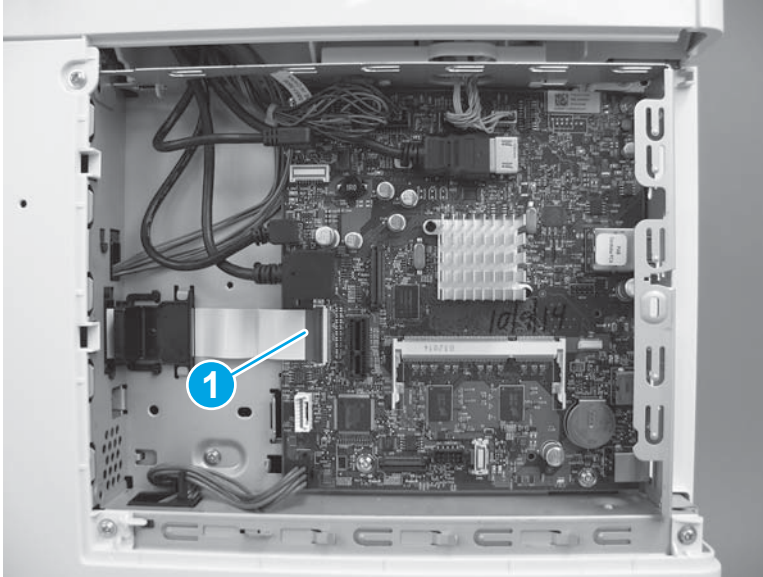

NOTE: This step is for the M577c/f/z models. For the M577n model, skip this step and go to [Step 53: Install the HDD \(M577\) on page 2223](#).

For the M552 and M553 models, skip this step and go to [Step 54: Install the formatter \(M552 and M553\) on page 2225](#).



CAUTION:  ESD-sensitive part.

1. Position the tab and telephone port (callout 1) on the fax PCA in the slots (callout 2) in the formatter case.

Figure 1-3984 Position the fax PCA

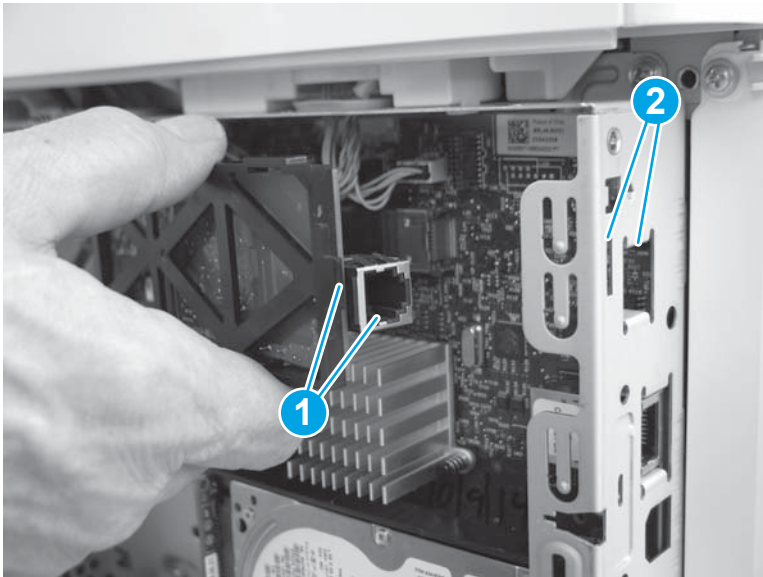

2. Slide the fax PCA to the right (callout 1) until the tab and telephone port described in the previous step and seated in the formatter case. Position the retainer (callout 2) in the slot (callout 3) in the formatter. Rotate the end of the fax PCA toward the formatter (callout 4) until the retainer snaps into place.

Figure 1-3985 Install the fax PCA

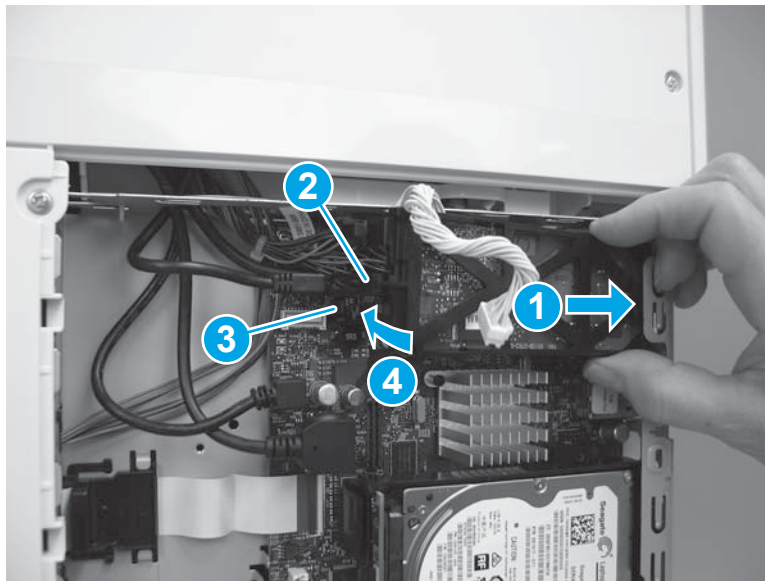

3. Position the cable (callout 1) in the guide (callout 2), and then connect one connector (callout 3).

Figure 1-3986 Connect the connector

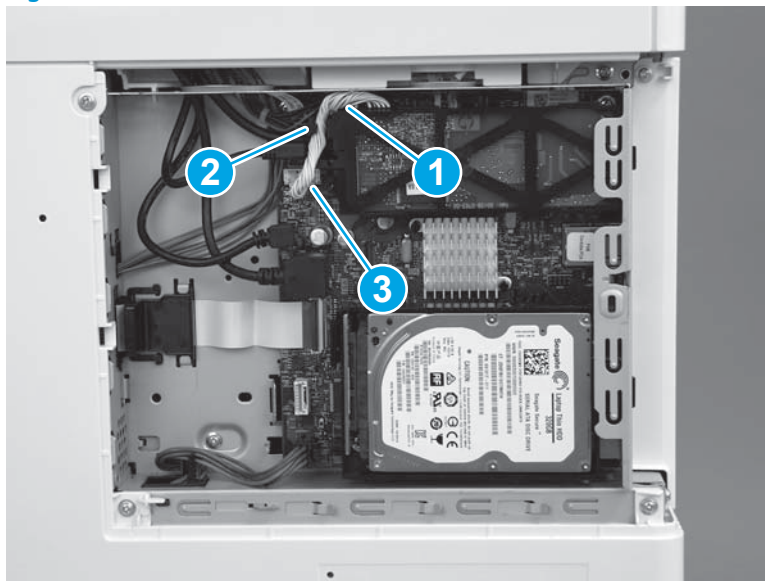

Step 53: Install the HDD (M577)

 **NOTE:** This step is for the M577 models. For the M552 and M553 models, skip this step and go to [Step 54: Install the formatter \(M552 and M553\) on page 2225](#).

 **CAUTION:**  ESD-sensitive part.

1. Align the end of the bracket (callout 1) with the slot in the chassis (callout 2), and then slide the HDD into the printer (callout 3) to engage the bracket with the chassis.

Figure 1-3987 Install the holder

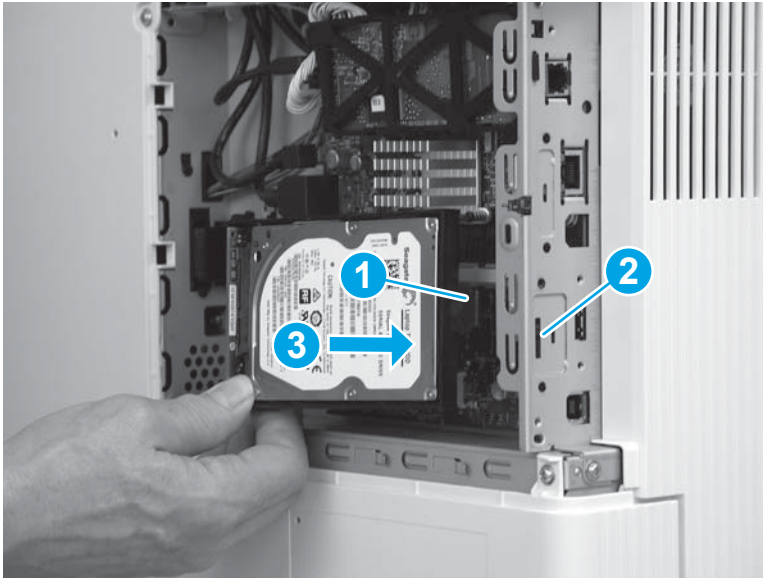

2. Hold the HDD connector latch (callout 1) in the released position, and then rotate the HDD down and into the connector on the formatter to install it.

 **NOTE:** Make sure that the tab (callout 2) snaps into place, and that the HDD is securely installed.

Figure 1-3988 Release the HDD

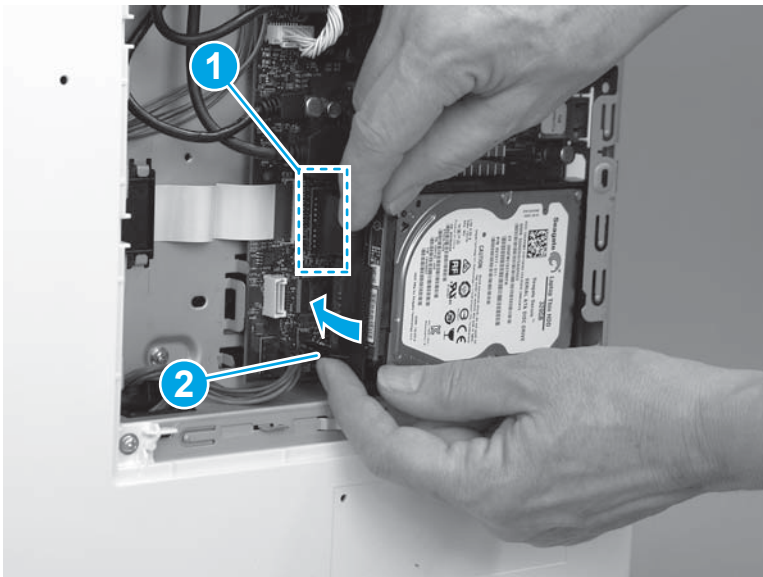

Step 54: Install the formatter (M552 and M553)

 **NOTE:** This step is for the M552 and M553 models. For the M577 models, skip this step and go to [Step 57: Install the formatter cover on page 2230](#).

If the optional hard-disk drive (HDD) was removed, do not forget to reinstall it after the formatter is reinstalled.

Engage the HDD holder with the chassis, rotate the HDD connector down and into the connector on the formatter. Make sure that the tabs snap into place.

 **CAUTION:**  ESD-sensitive part.

1. Position the formatter in the printer, and then install four screws (callout 1).

Figure 1-3989 Install the formatter

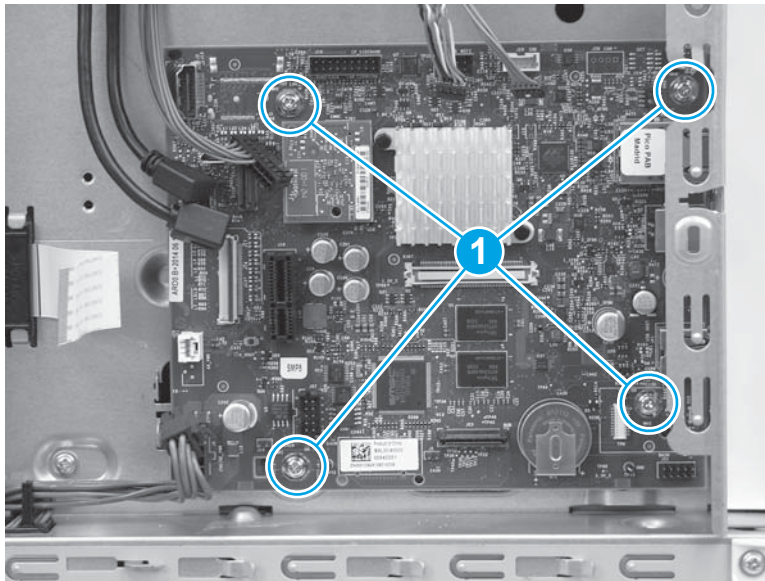

2. Connect all of the connectors on the formatter.

The following connectors are empty:

- All models: J1 (this connector is empty unless the optional DIMM is installed)
- M553n/dn and M552dn: J2 (callout 1; this is the touchscreen connector for the M553x model)
- All models: J9 (this connector is empty unless the optional internal USB ports component is installed)
- All models: J18 (this connector is empty unless the optional hard-disk-drive (HDD) is installed)
- All models: J23
- All models: J24
- M553n/dn and M552dn: J25 (this is the wireless connector for the M553x model)

- All models: J57
- All models: J98 (this connector is empty unless the optional trusted platform module (TPM) is installed)



 **IMPORTANT:** The flat-cable connector (callout 2) is a Zero Insertion Force (ZIF) connector that uses a hinged retainer to secure the flat cable. The hinged retainer must be opened to install the flat cable.

Figure 1-3990 Connect all connectors

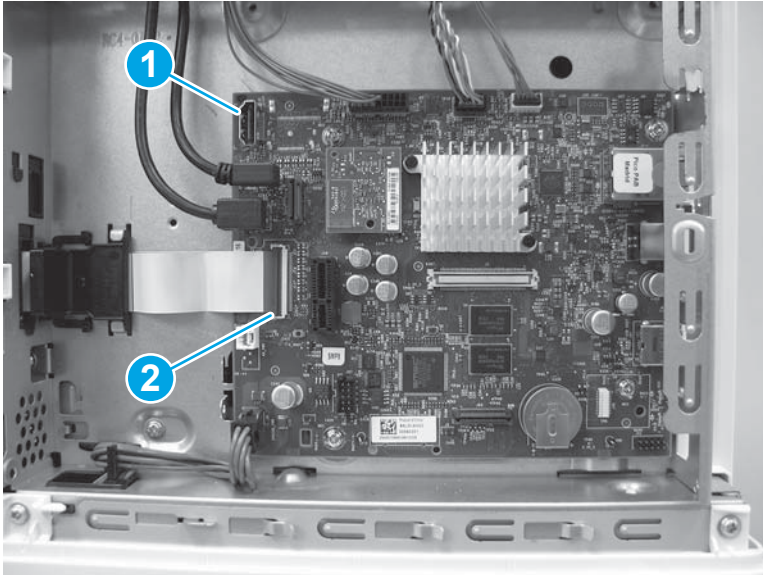

Step 55: Install the control-panel assembly (M553x only)

 **NOTE:** This step is for the M553x model. For the M553n/dn and M552dn models, skip this step and go to [Step 56: Install the USB cover \(M552 and M553\) on page 2229](#).

For the M577 models, skip this step and go to [Step 57: Install the formatter cover on page 2230](#).

1. Place the control panel on the printer as shown.

Figure 1-3991 Place the control panel on the product

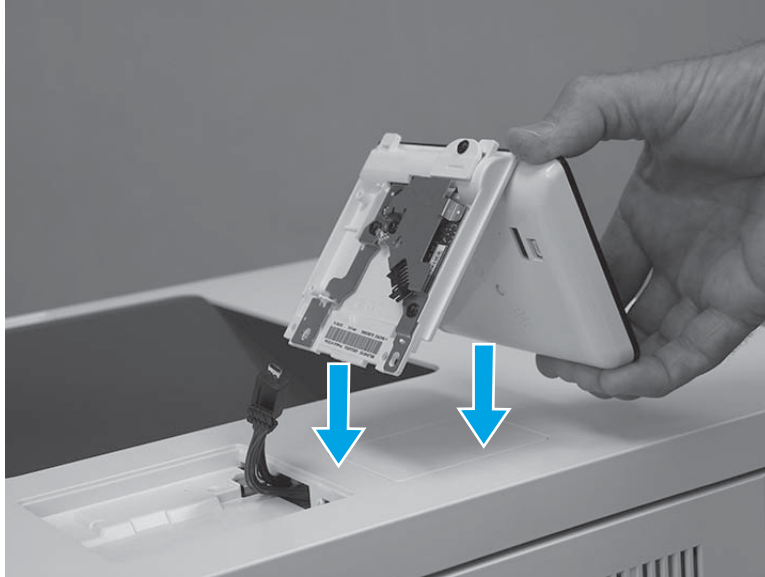

2. Connect one USB cable (callout 1), and one connector (callout 2).

 **IMPORTANT:** Take note of the location of the two mounting tabs (callout 3) on the control-panel assembly.

Figure 1-3992 Connect two connectors



3. Turn the control panel over, and then position the front edge tabs in the slots in the top cover.

Figure 1-3993 Turn the control panel over

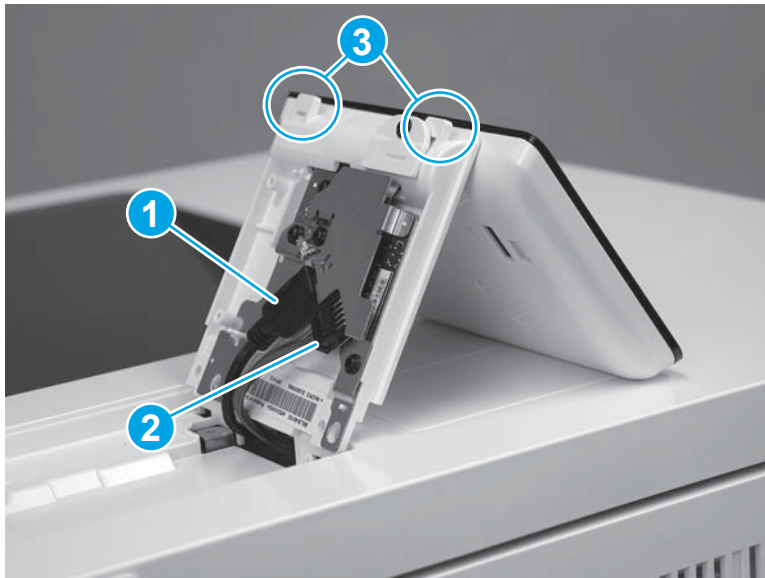
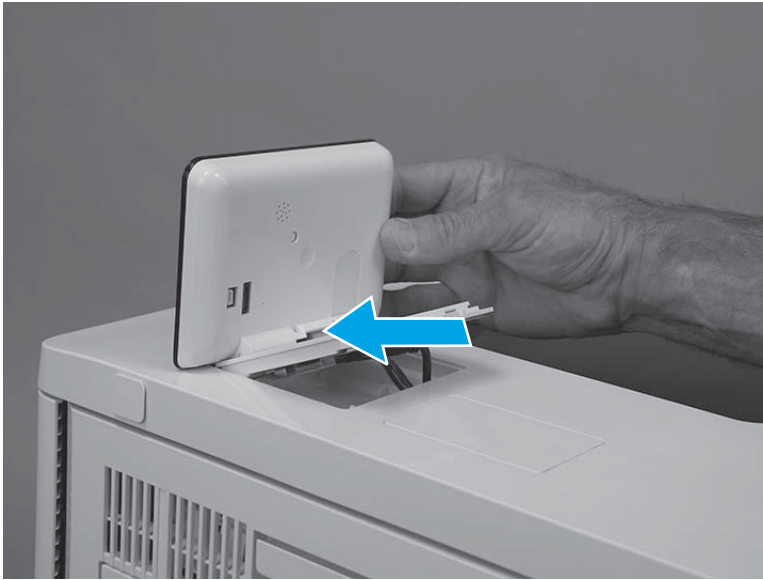

4. Rotate the control-panel base down onto the printer.

Figure 1-3994 Rotate the control-panel base down



5. Use a small Phillips screwdriver to install two screws (callout 1).

Figure 1-3995 Install two screws

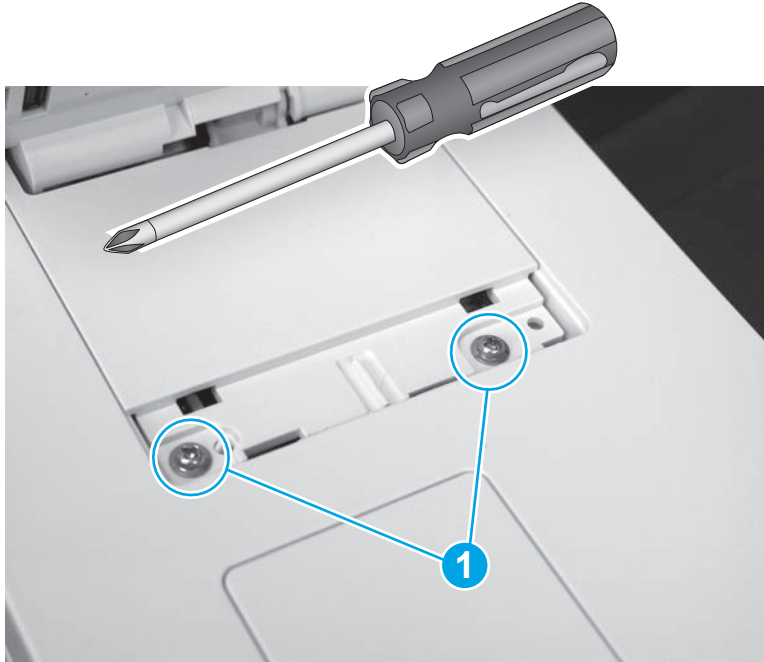

6. Position the screw cover mounting feet into the slots in the top cover (callout 1), and then rotate the cover down (callout 2) to install it.

 **NOTE:** Press down on the cover firmly to make sure that the tabs on the cover (callout 3) snap into place.

Figure 1-3996 Install the cover



Step 56: Install the USB cover (M552 and M553)

 **NOTE:** This step is for the M552 and M553 models. For the M577 models, skip this step and go to [Step 57: Install the formatter cover on page 2230](#).

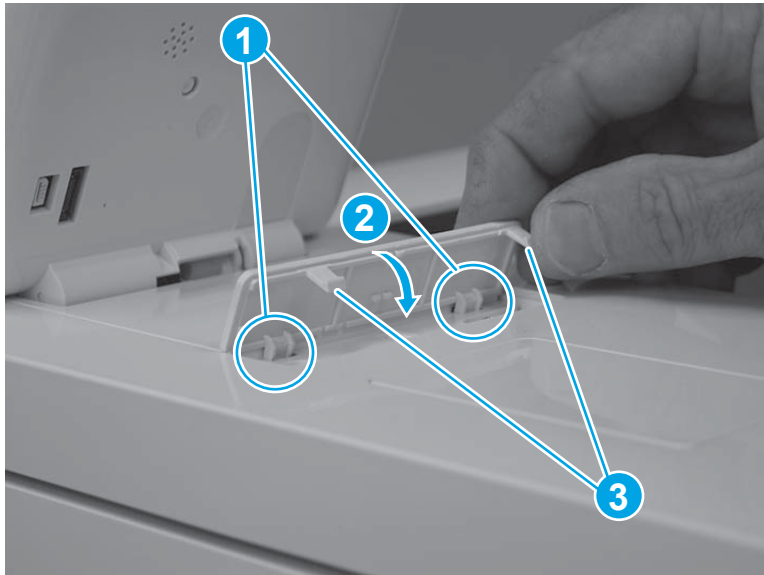
1. Push the cover into the USB port to install it.

Figure 1-3997 Install the cover



2. Make sure that the USB cover is fully seated after installing it.

Figure 1-3998 Check the installation

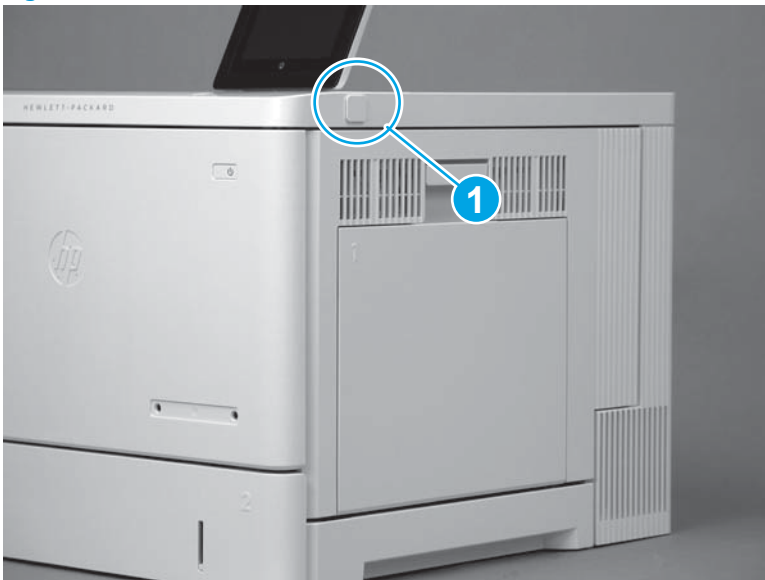

Step 57: Install the formatter cover

- ▲ Slide the cover onto the printer (callout 1) to install it.

 **NOTE:** Make sure that the tabs on the formatter cover align with the slots provided in the printer (callout 2). Tighten the two thumbscrews (callout 3).

 **TIP:** If needed, use the edge of a coin to turn the thumbscrews.

Figure 1-3999 Install the cover



Step 58: Install the TCU

1. Verify that the toner collection hatch cover is in the closed position on the TCU.

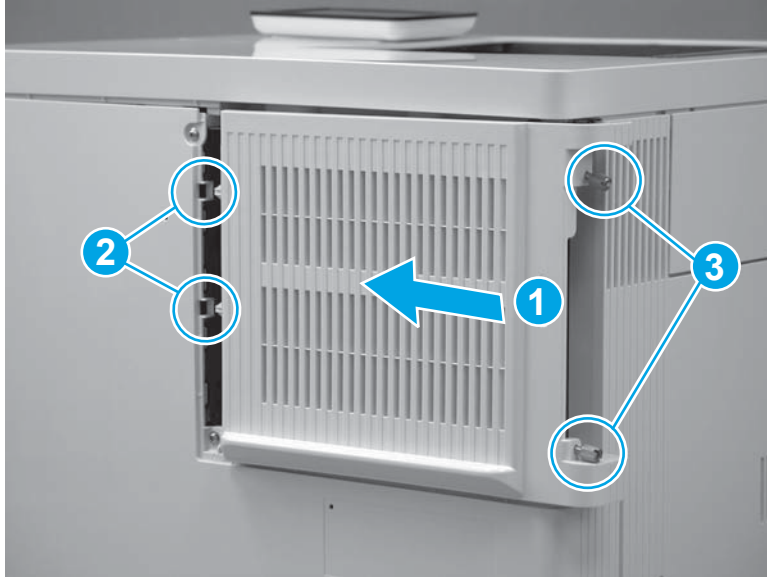
Figure 1-4000 Verify that the toner collection hatch cover is closed

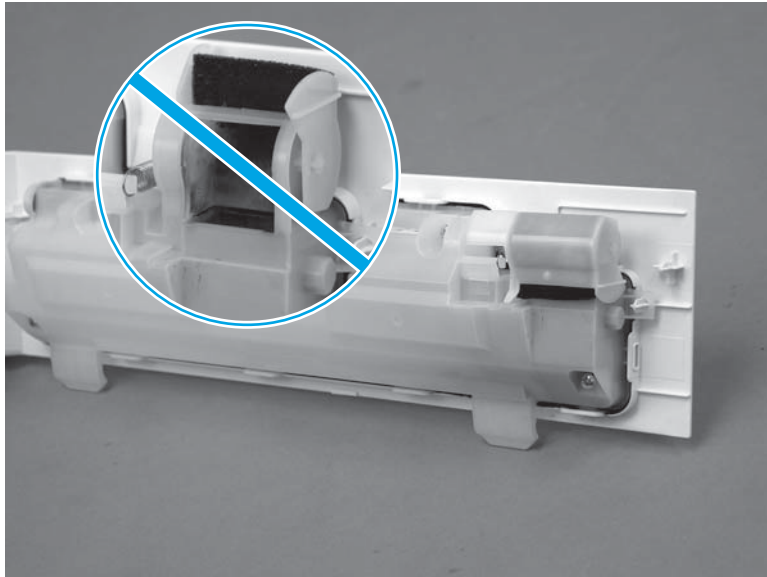

2. Position the TCU with the hinges in the slots provided in the printer (callout 1), and then rotate the TCU up and into the closed position.

 **NOTE:** The toner collection hatch cover automatically opens when the TCU is closed.

Figure 1-4001 Install the TCU



3. Close the front door.

Figure 1-4002 Close the front door

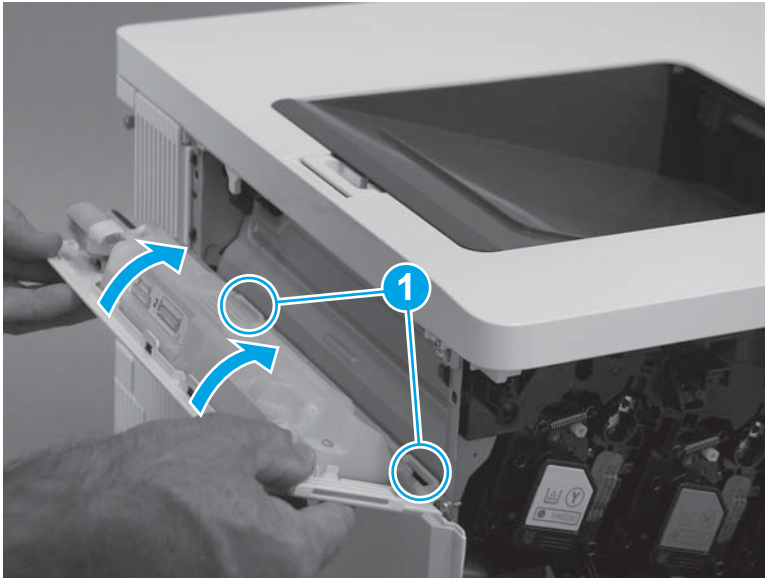

Step 59: Install the tray

1. With the front of the tray slightly lifted, align the sides of the tray with the rails in the printer, and then carefully slide the tray into the printer.

 **TIP:** As the tray slides into the printer, lower the front of it.

Figure 1-4003 Install the tray



2. Close the tray.

Figure 1-4004 Close the tray



Step 60: Install the ITB

CAUTION: Do not touch the grey-plastic belt. Skin oils and fingerprints on the belt can cause print-quality problems.

1. Handle the ITB by the edges. Do not touch the grey-plastic belt. Skin oils and fingerprints on the belt can cause print-quality problems.

Figure 1-4005 Handle the ITB by the edges

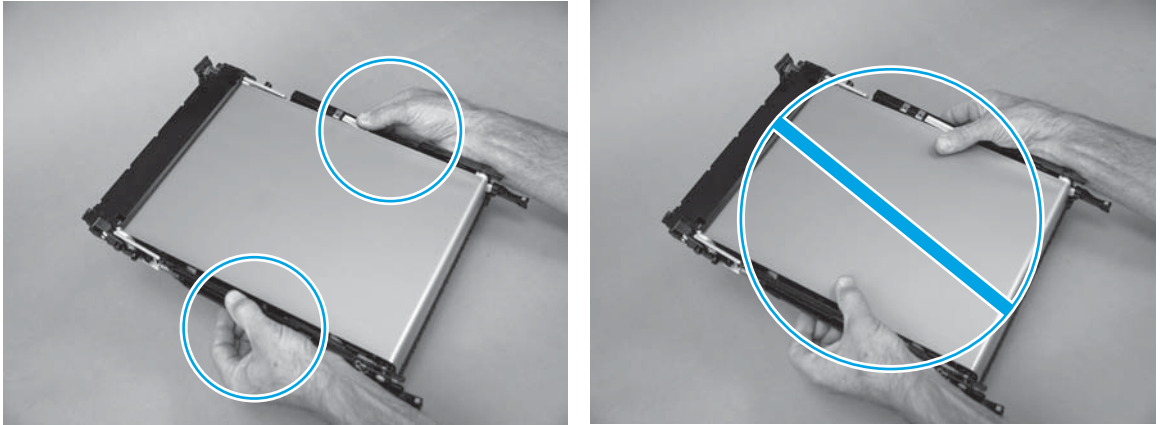

2. Align the ITB with the slots in the printer, and then carefully push it into the printer.

 **NOTE:** Be careful. Do not dislodge the ITB retainer springs from the holders on the chassis. The springs can interfere with installing the ITB.

Figure 1-4006 Align the ITB with the slots in the product

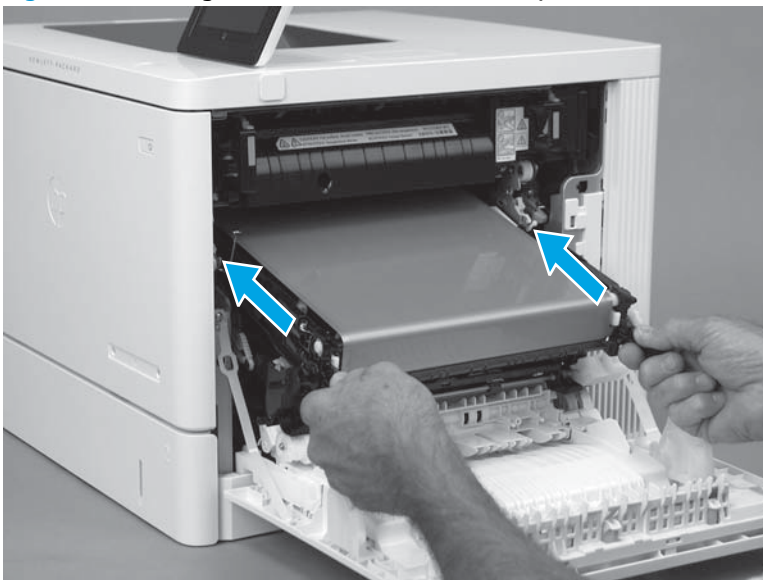

3. Continue to carefully push the ITB into the printer until it is fully installed.

Figure 1-4007 Install the ITB

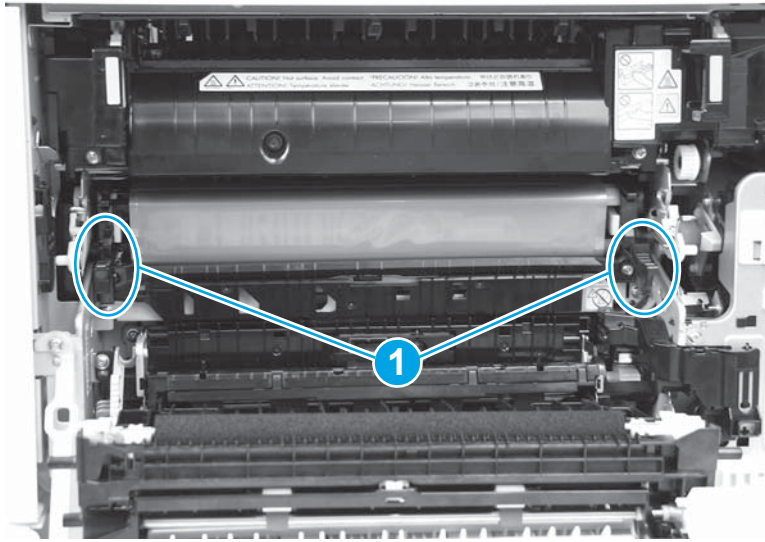

4. Remove the right-side ITB spring from the holder.

Figure 1-4008 Remove the spring from the holder



5. Fasten the right-side ITB spring (callout 1) under the tab (callout 2).

Figure 1-4009 Fasten the rear-side ITB spring

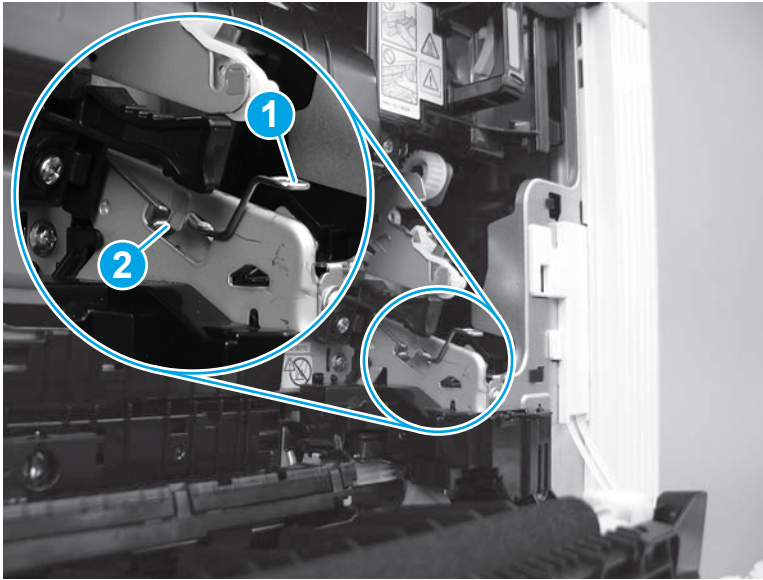

6. Remove the left-side ITB spring from the holder.

Figure 1-4010 Remove the spring from the holder

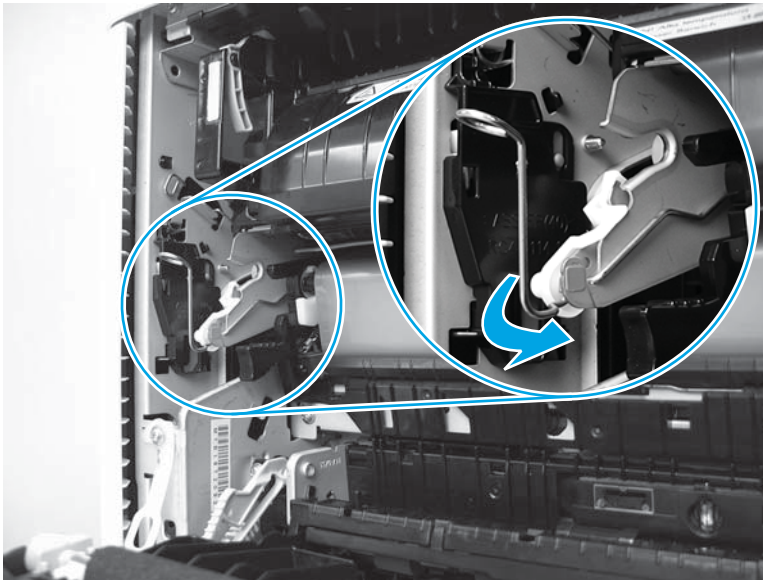

7. Fasten the left-side ITB spring (callout 1) under the tab (callout 2).

Figure 1-4011 Fasten the front-side ITB spring

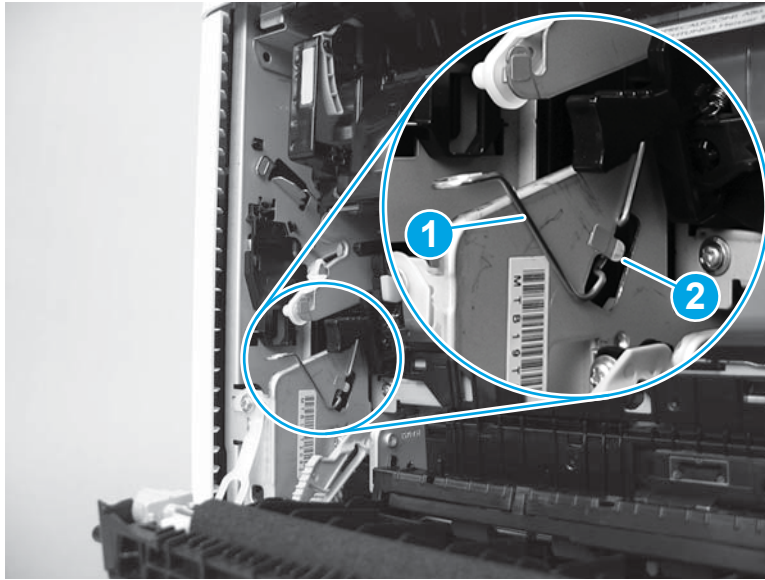

8. Push in the blue lever to engage the ITB drive coupling.

Figure 1-4012 Engage the ITB drive coupling

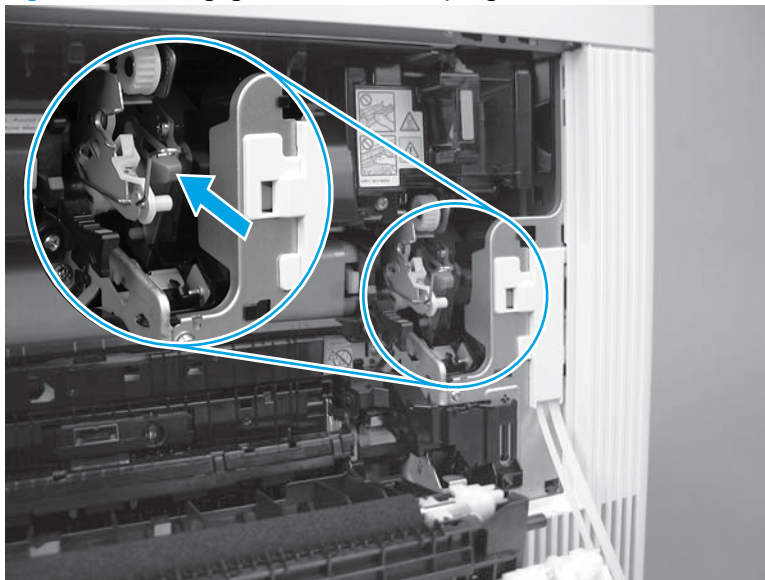

9. Close the right door.

 **TIP:** The right door should close easily if the ITB assembly is correctly installed.

Figure 1-4013 Close the right door



Step 61: Install the secondary transfer roller assembly

1. Move the registration sensor assembly (callout 1) out of the way, and then position the secondary transfer assembly right hinge (callout 2) into the hole provided in the printer.

Figure 1-4014 Install the right hinge

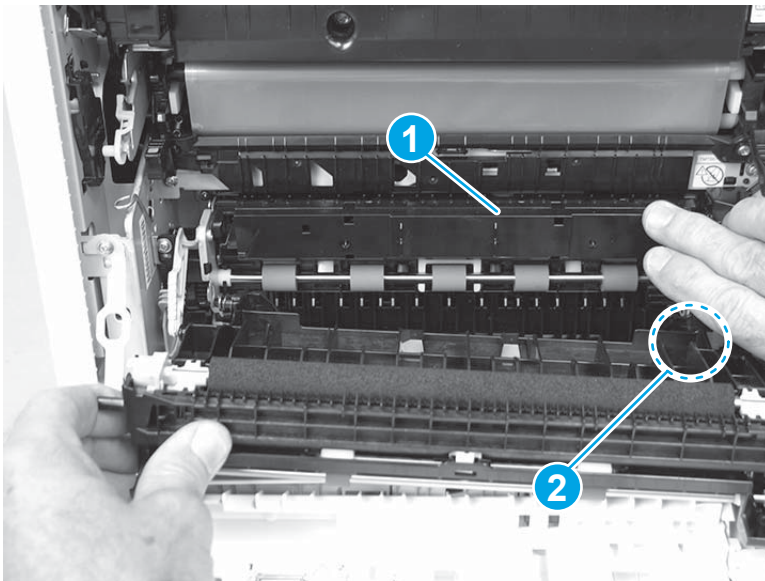

2. Position the assembly left-side hinge near the hole provided in the printer, and then slide the assembly toward the front of the printer to install the hinge in the hole.

Figure 1-4015 Install the left hinge

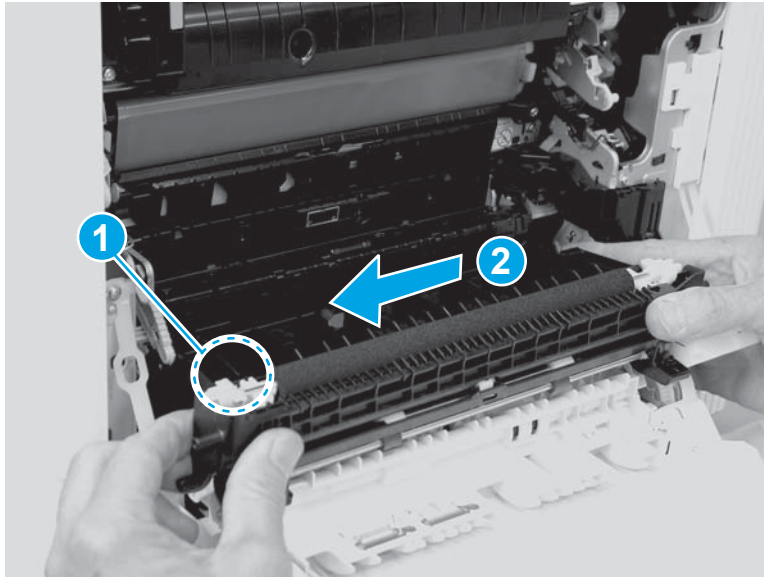

3. Carefully flex the blue arm, and then push it over the pin on the assembly to engage it.

 **NOTE:** Make sure that the pin is correctly installed in the slot on the blue arm.

Figure 1-4016 Engage the blue arm with the pin

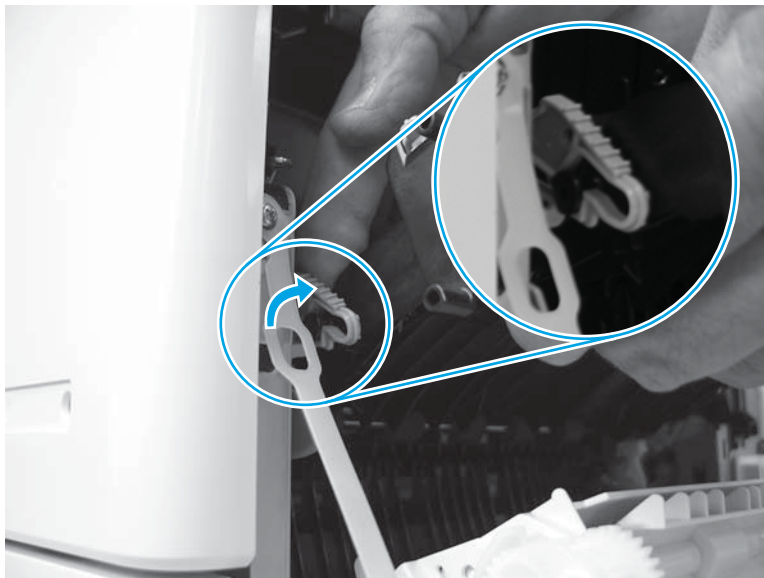

4. Close the right door.

 **TIP:** The right door should close easily if the secondary transfer assembly is correctly installed.

Figure 1-4017 Close the right door



Removal and replacement: Paper pickup assembly

- [Introduction](#)
- [Step 1: Remove the secondary transfer assembly](#)
- [Step 2: Remove the ITB](#)
- [Step 3: Remove the tray](#)
- [Step 4: Remove the toner collection unit \(TCU\)](#)
- [Step 5: Remove the formatter cover](#)
- [Step 6: Remove the USB cover \(M552 and M553\)](#)
- [Step 7: Remove the control panel \(M553x only\)](#)
- [Step 8: Remove the formatter \(M552 and M553\)](#)
- [Step 9: Remove the hard-disk drive \(HDD\) \(M577\)](#)
- [Step 10: Remove the fax PCA \(M577c/f/z\)](#)
- [Step 11: Remove the formatter \(M577\)](#)
- [Step 12: Remove the rear cover \(M552 and M553\)](#)
- [Step 13: Remove the rear upper cover \(M577\)](#)
- [Step 14: Remove the rear cover \(M577\)](#)
- [Step 15: Remove the left upper cover \(M577\)](#)
- [Step 16: Remove the right front upper cover \(M577dn\)](#)
- [Step 17: Remove the stapler cover assembly \(M577c/f/z\)](#)
- [Step 18: Remove the integrated scanner assembly \(ISA\) \(M577\)](#)
- [Step 19: Remove the right upper cover \(M577\)](#)
- [Step 20: Remove the left cover](#)
- [Step 21: Remove the upper cover \(M552 and M553\)](#)
- [Step 22: Remove the right rear cover](#)
- [Step 23: Remove the formatter case](#)
- [Step 24: Remove the low-voltage power supply \(LVPS\)](#)
- [Step 25: Remove the power supply fan \(FM1\)](#)
- [Step 26: Remove the high-voltage power supply D \(HVPSD\)](#)
- [Step 27: Remove the lifter drive assembly](#)
- [Step 28: Remove the DC controller and sheet-metal bracket](#)
- [Step 29: Remove the pickup drive assembly and motor \(M5\)](#)

- [Step 30: Remove the registration assembly](#)
- [Step 31: Remove the paper pickup assembly](#)
- [Step 32: Unpack the replacement assembly](#)
- [Step 33: Install the paper pickup assembly](#)
- [Step 34: Install the registration assembly](#)
- [Step 35: Install the pickup drive assembly and motor \(M5\)](#)
- [Step 36: Install the DC controller and sheet-metal bracket](#)
- [Step 37: Install the lifter drive assembly](#)
- [Step 38: Install the HVPSD](#)
- [Step 39: Install the power-supply fan \(FM1\)](#)
- [Step 40: Install the LVPS](#)
- [Step 41: Install the formatter case](#)
- [Step 42: Install the right rear cover](#)
- [Step 43: Install the upper cover \(M552 and M553\)](#)
- [Step 44: Install the left cover](#)
- [Step 45: Install the right upper cover \(M577\)](#)
- [Step 46: Install the integrated scanner assembly \(ISA\) \(M577\)](#)
- [Step 47: Install the stapler cover assembly \(M577c/f/z\)](#)
- [Step 48: Install the right front upper cover \(M577dn\)](#)
- [Step 49: Install the left upper cover \(M577\)](#)
- [Step 50: Install the rear cover \(M577\)](#)
- [Step 51: Install the rear upper cover \(M577\)](#)
- [Step 52: Install the rear cover \(M552 and M553\)](#)
- [Step 53: Install the formatter \(M577\)](#)
- [Step 54: Install the fax PCA \(M577c/f/z\)](#)
- [Step 55: Install the HDD \(M577\)](#)
- [Step 56: Install the formatter \(M552 and M553\)](#)
- [Step 57: Install the control-panel assembly \(M553x only\)](#)
- [Step 58: Install the USB cover \(M552 and M553\)](#)
- [Step 59: Install the formatter cover](#)
- [Step 60: Install the TCU](#)

- [Step 61: Install the tray](#)
- [Step 62: Install the ITB](#)
- [Step 63: Install the secondary transfer roller assembly](#)

Introduction

This document provides the procedures to remove and replace the paper pickup assembly.

Before performing service

 **TIP:** Some figures might show assemblies removed or installed that have not yet been removed or installed at that specific step. However, the procedures are correct for this printer and the target assembly. Always thoroughly read the instructions that accompany each figure.

Turn the printer power off

- Disconnect the power cable.

 **WARNING!** To avoid damage to the printer, turn the printer off, wait 30 seconds, and then remove the power cord before attempting to service the printer.

Use the table below to identify the correct part number for your printer, and then go to <http://h20141.www2.hp.com/hpparts> to order the part.

Paper pickup assembly part number	
RM2-0017-000CN	Paper pickup assembly (includes the Tray 2 paper pickup roller assembly)

Required tools

- #2 Phillips screwdriver with a magnetic tip

After performing service

Make sure that all of the connectors on the LVPS are fully seated.

Make sure that all of the connectors on the DC controller are fully seated.

Make sure that the TCU is fully closed after replacing it.

Make sure that all of the connectors on the formatter are fully seated.

Make sure that the formatter cover is fully seated, and that the thumbscrews are finger tight after replacing it.

Turn the printer power on

- Connect the power cable.
- Use the power switch to turn the power on.

Post service test

Print a configuration page to make sure that the printer is functioning correctly.

Step 1: Remove the secondary transfer assembly

1. Open the right door.

Figure 1-4018 Open the right door



2. Release the blue arm, and then let the secondary transfer assembly rotate down to the half-way open position.



NOTE: The assembly should stop at the halfway down point—the pin will stop at the notch in the slot in the blue arm.

Figure 1-4019 Release the secondary transfer roller assembly

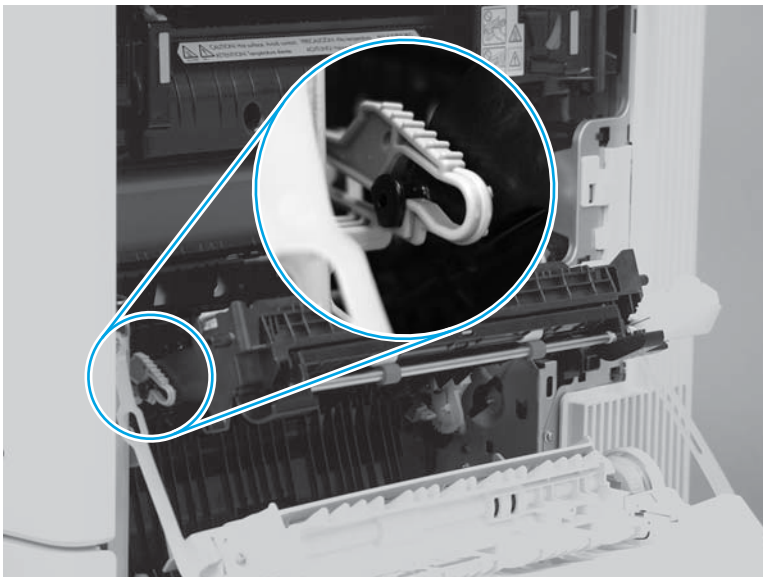

3. Carefully flex the top portion of the blue arm—as shown in the figure—to start to disengage it from the pin.

Figure 1-4020 Carefully flex the top portion of the blue arm



4. Continue to flex the blue arm until it disengages from the pin.

Figure 1-4021 Disengage the blue arm and pin



5. Slide the assembly toward the front of the printer to release it (callout 1), and then rotate it down and away from the printer to remove it (callout 2).

 **Reinstallation tip:** Before removing the assembly, take note of where the assembly hinge pins fit into the holes provided in the printer.

Figure 1-4022 Remove the secondary transfer roller assembly



Step 2: Remove the ITB

 **CAUTION:** Do not touch the grey-plastic belt. Skin oils and fingerprints on the belt can cause print-quality problems.

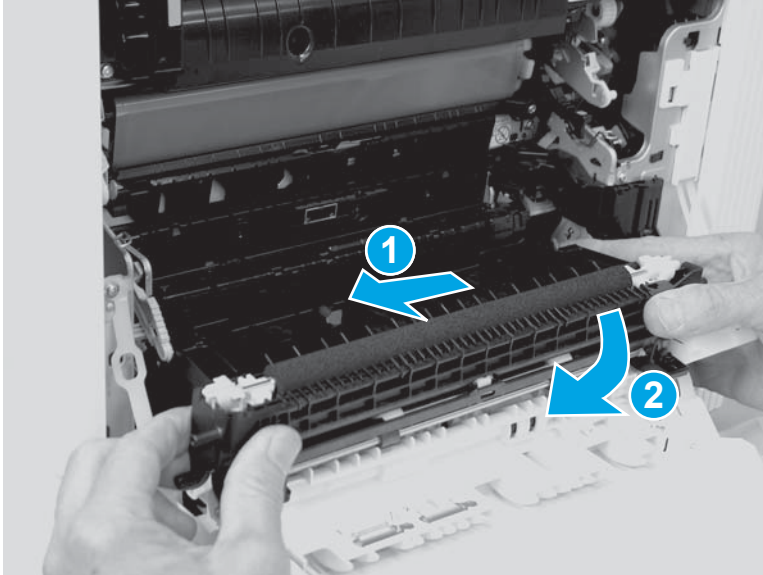
1. Open the right door.

Figure 1-4023 Open the right door



2. Pull the blue lever to release the ITB drive coupling.

Figure 1-4024 Release the ITB drive coupling

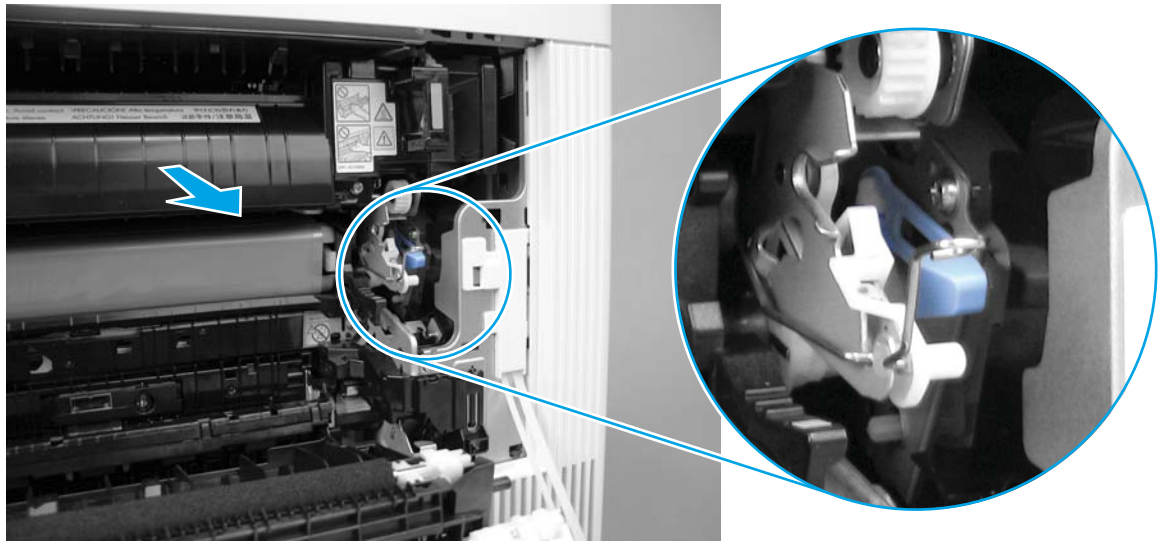

3. Push in on the blue arm to release the secondary transfer roller assembly, and then completely lower the assembly.

 **NOTE:** Press the blue arm on the secondary transfer roller assembly a second time to release the roller assembly when it stops at the halfway open position.

Figure 1-4025 Lower the secondary transfer roller assembly



4. Release the left-side ITB spring (callout 1) from the tab (callout 2).

Figure 1-4026 Release the front-side ITB spring

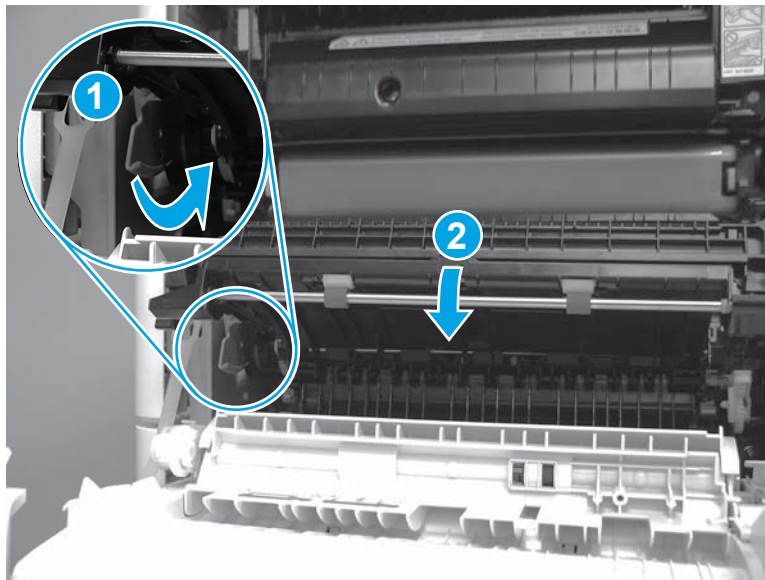
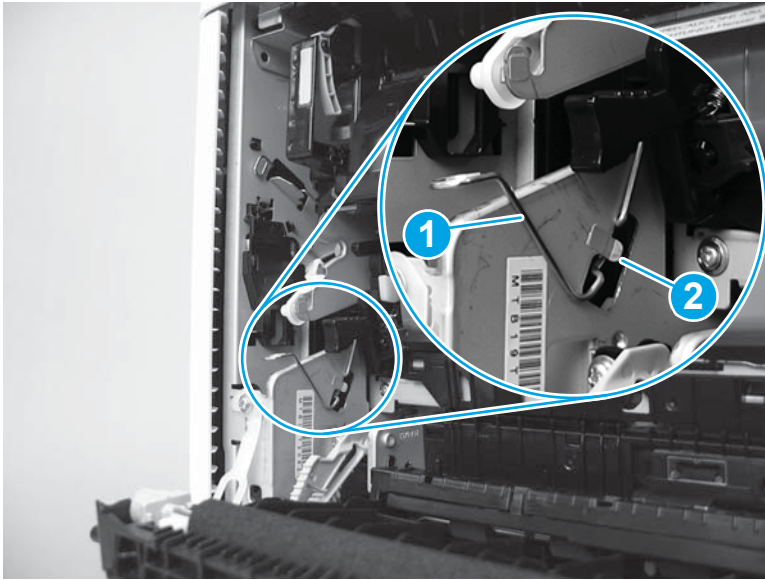

5. Place the left-side ITB spring on the holder to keep it out of the way.

 **TIP:** The holder is colored blue to help locate it.

Figure 1-4027 Place the spring on the holder

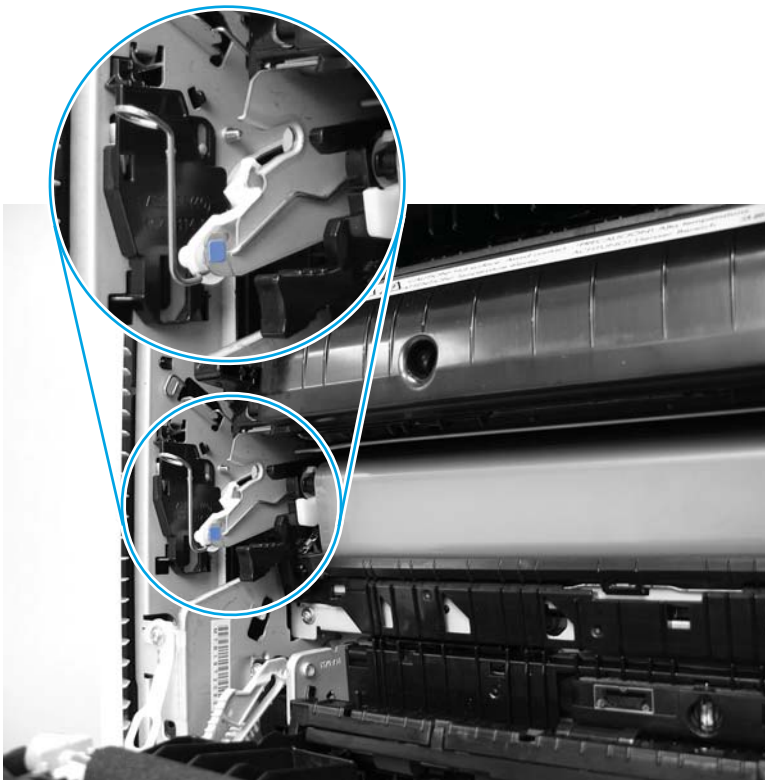

6. Release the right-side ITB spring (callout 1) from the tab (callout 2).

Figure 1-4028 Release the rear-side ITB spring

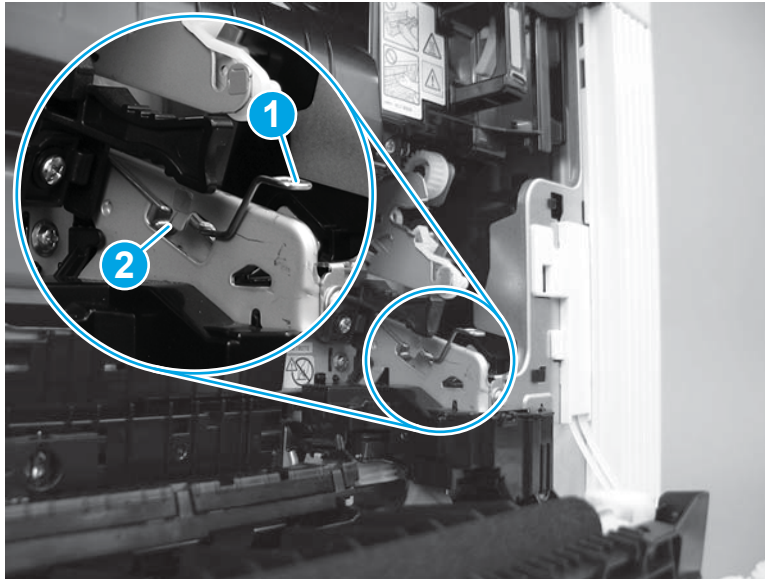

7. Place the right-side ITB spring on the holder to keep it out of the way.

 **TIP:** The holder is colored blue to help locate it.

Figure 1-4029 Place the spring on the holder

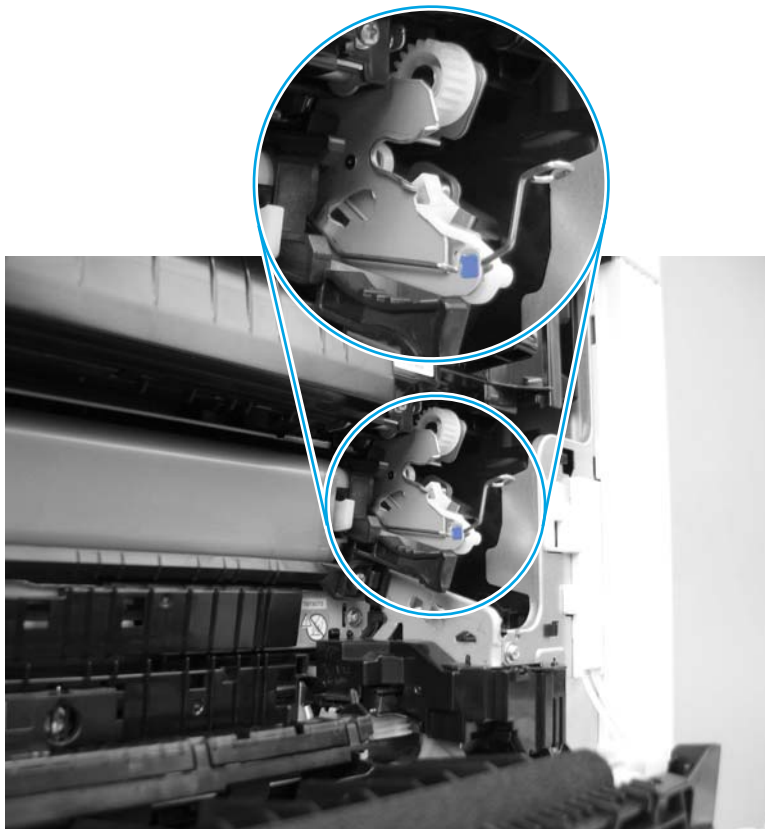

8. Grasp the two blue handles on the ITB.

⚠ CAUTION: If the ITB is removed to access other assemblies in the printer, use care. The ITB is a sensitive assembly. Be careful when handling the ITB so that it is not damaged. Always place the ITB in a safe and protected location.

Figure 1-4030 Grasp the ITB handles

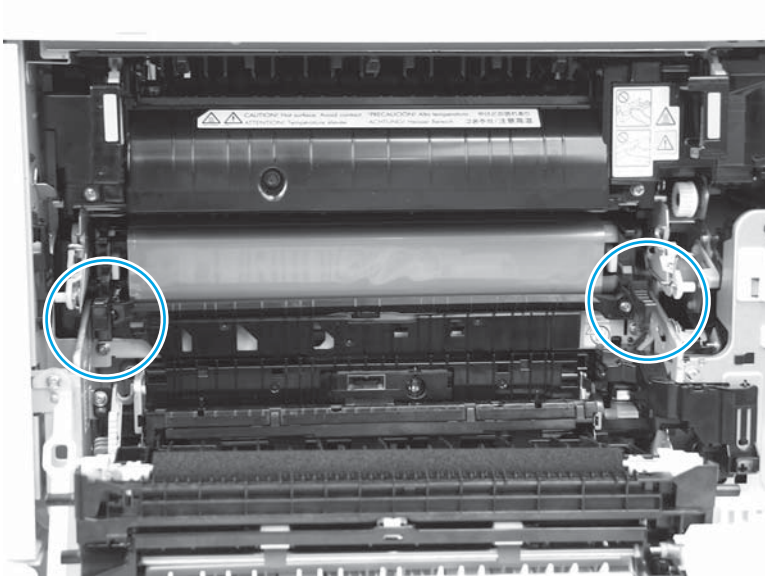

9. Pull the ITB out of the printer to remove it.

⚠ CAUTION: Do not touch the grey-plastic belt. Skin oils and fingerprints on the belt can cause print-quality problems.

Figure 1-4031 Remove the ITB



Step 3: Remove the tray

1. Pull the tray out until it stops.

Figure 1-4032 Pull the tray out



2. Lift the front of the tray, and then pull it out of the printer to remove it.

Figure 1-4033 Remove the tray

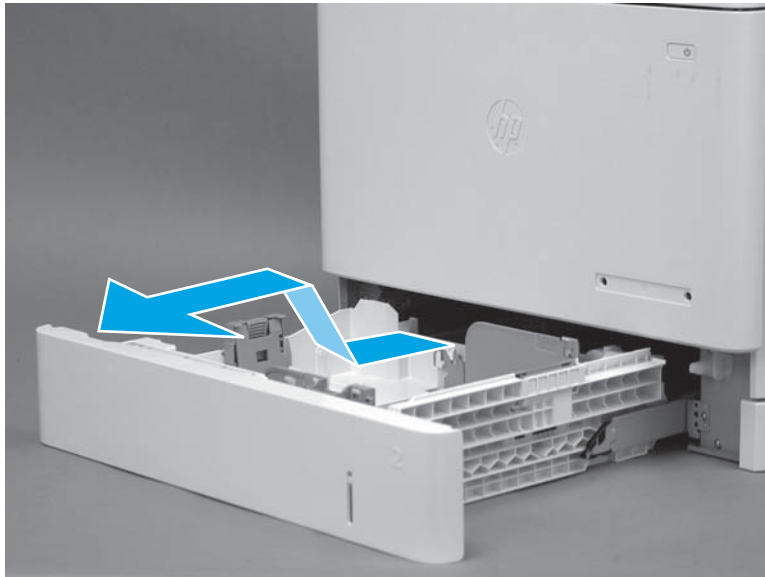

Step 4: Remove the toner collection unit (TCU)

1. Open the front door.

Figure 1-4034 Open the front door



2. Open the TCU.



NOTE: The toner collection hatch cover automatically closes when the TCU is opened.

Figure 1-4035 Open the TCU



3. Pull the TCU away from the printer at an angle to remove it.

⚠ CAUTION: Do not open the toner collection hatch cover when handling the TCU. If toner gets on clothing, wipe it off by using a dry cloth and wash the clothes in cold water. Hot water sets toner into fabric.

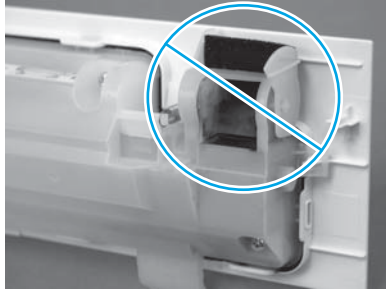
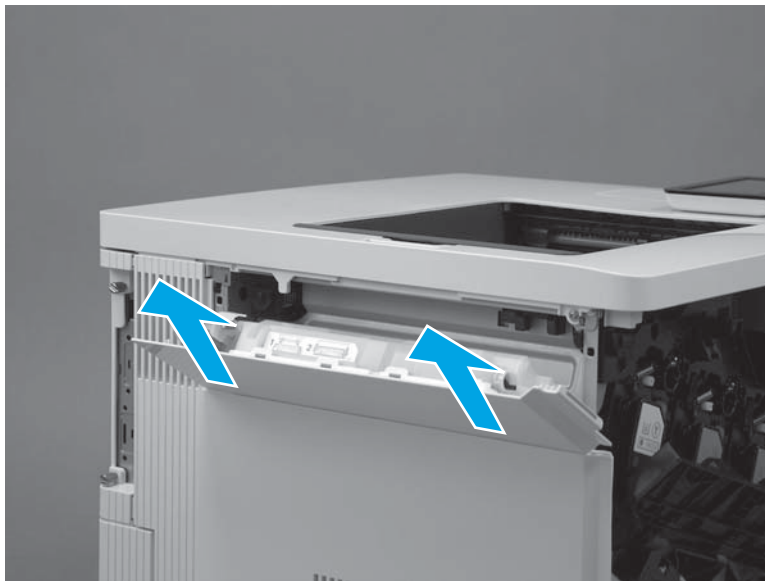

Figure 1-4036 Remove the TCU



Step 5: Remove the formatter cover

1. Locate the formatter cover.

Figure 1-4037 Locate the formatter cover

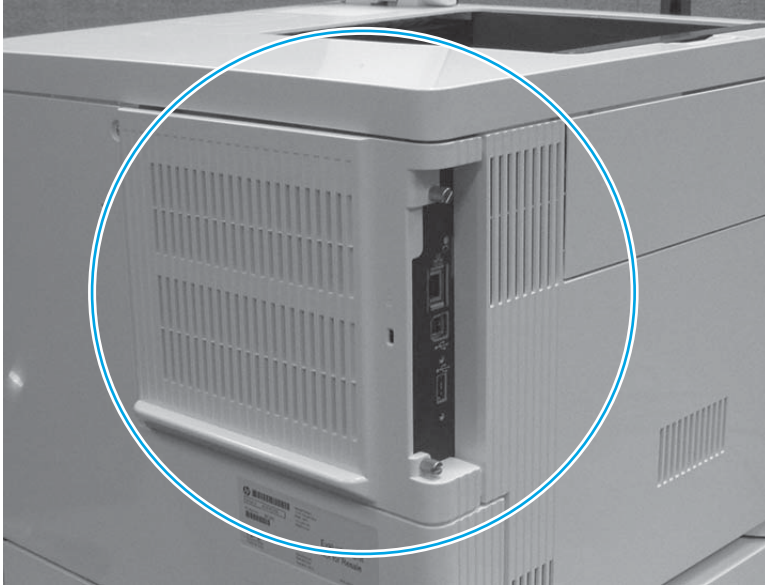

2. Loosen the two thumbscrews (callout 1). Grasp the two thumbscrews, and then slide the cover away from the printer (callout 2) to remove it.



 **TIP:** If needed, use the edge of a coin to turn the thumbscrews.

Figure 1-4038 Loosen the thumbscrews

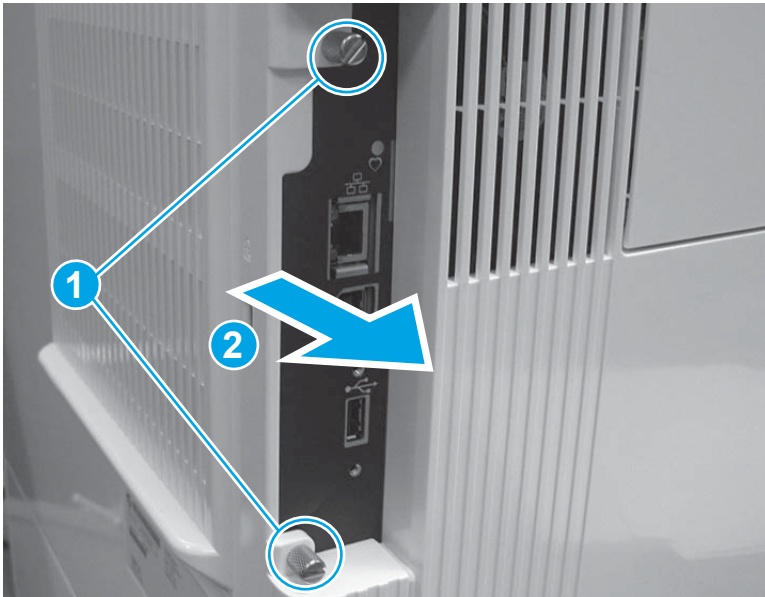

Step 6: Remove the USB cover (M552 and M553)

 **NOTE:** This step is for the M552 and M553 models. For the M577 models, skip this step and go to [Step 9: Remove the hard-disk drive \(HDD\) \(M577\) on page 2260.](#)

1. Locate the USB cover.

Figure 1-4039 Locate the USB cover



2. Pull the cover off of the printer to remove it.

Figure 1-4040 Remove the cover



Step 7: Remove the control panel (M553x only)

 **NOTE:** For the M553n/dn and M552dn models, skip this step and go to [Step 8: Remove the formatter \(M552 and M553\)](#) on page 2259.

For the M577 models, skip this step and go to [Step 9: Remove the hard-disk drive \(HDD\) \(M577\)](#) on page 2260.

1. Tilt the control panel up.

Figure 1-4041 Tilt the control panel up



2. Use a small flat-blade screwdriver to release the control-panel screws cover tabs.

Figure 1-4042 Release the control-panel screws cover tabs



3. Rotate the cover up to remove it.

Figure 1-4043 Remove the cover



4. Use a small Phillips screwdriver to remove two screws (callout 1).

 **IMPORTANT:** Store the screws in a secure place where they cannot fall down into the printer.

Figure 1-4044 Remove two screws



5. Rotate the control-panel base toward the front of the printer.

Figure 1-4045 Rotate the control-panel base up

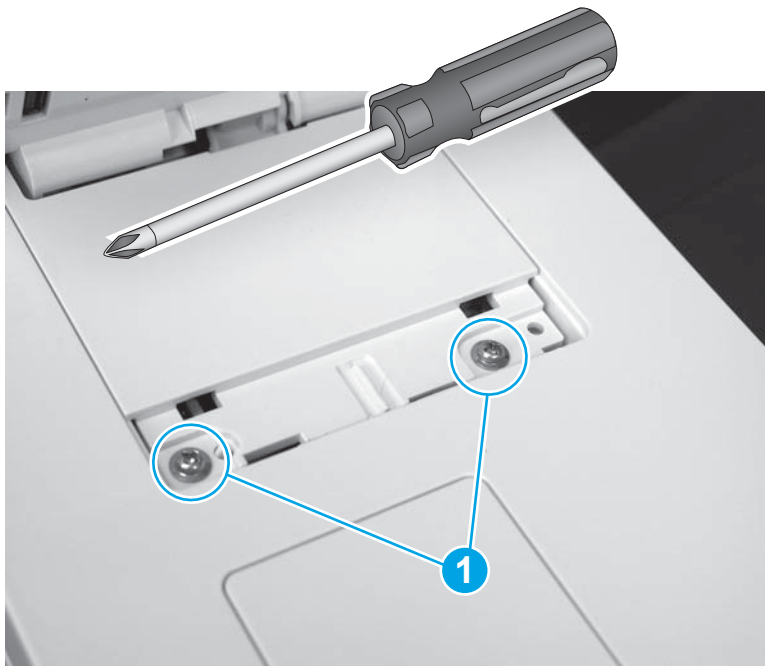

6. Slightly slide the control-panel base toward the rear of the printer (callout 1) to release it, and then turn the control panel over (callout 2) to access the bottom side.

CAUTION: The control panel is still attached to the printer. Do not attempt to completely remove the control panel.

Figure 1-4046 Turn the control panel over

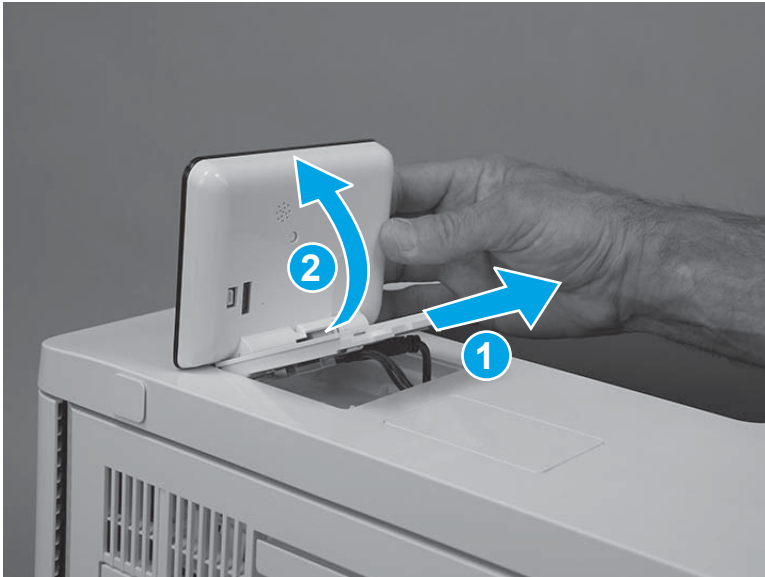

7. Disconnect one USB cable (callout 1), one connector (callout 2), and then remove the control panel.

Figure 1-4047 Disconnect two connectors

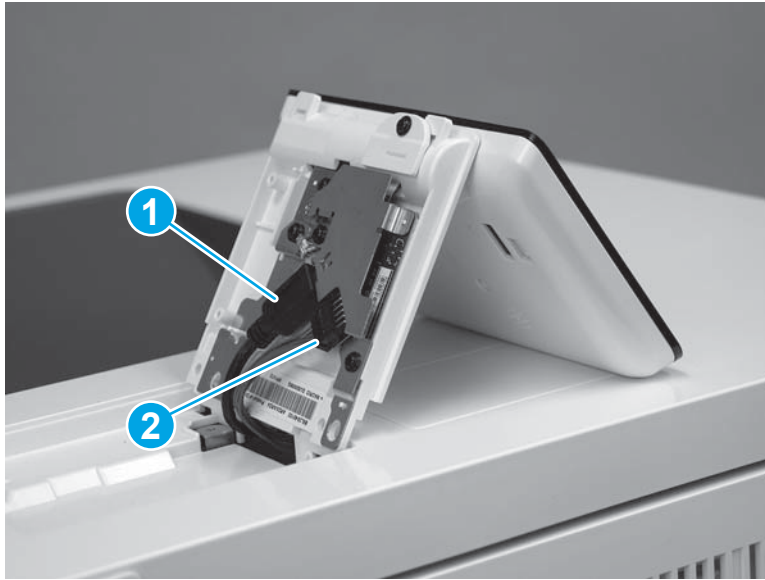

Step 8: Remove the formatter (M552 and M553)



NOTE: This step is for the M552 and M553 models. For the M577 models, skip this step and go to [Step 9: Remove the hard-disk drive \(HDD\) \(M577\) on page 2260](#).

If the optional hard-disk drive (HDD) is installed, it must be removed to gain access to the formatter mounting screws.

Release two tabs along the left edge of the HDD, rotate the left edge away from the product, and then slide the HDD to the left to remove it.



CAUTION:  ESD-sensitive part.

1. Disconnect all of the connectors on the formatter.

The following connectors are empty:

- All models: J1 (this connector is empty unless the optional DIMM is installed)
- M553n/dn and M552dn: J2 (callout 1; this is the touchscreen connector for the M553x model)
- All models: J9 (this connector is empty unless the optional internal USB ports component is installed)
- All models: J18 (this connector is empty unless the optional hard-disk-drive (HDD) is installed)
- All models: J23
- All models: J24
- M553n/dn and M552dn: J25 (this is the wireless connector for the M553x model)

- All models: J57
- All models: J98 (this connector is empty unless the optional trusted platform module (TPM) is installed)

 **IMPORTANT:** The flat-cable connector (callout 2) is a Zero Insertion Force (ZIF) connector that uses a hinged retainer to secure the flat cable. The hinged retainer must be opened to release the flat cable.

Figure 1-4048 Disconnect all connectors



2. Remove four screws (callout 1), and then remove the formatter.

Figure 1-4049 Remove the formatter

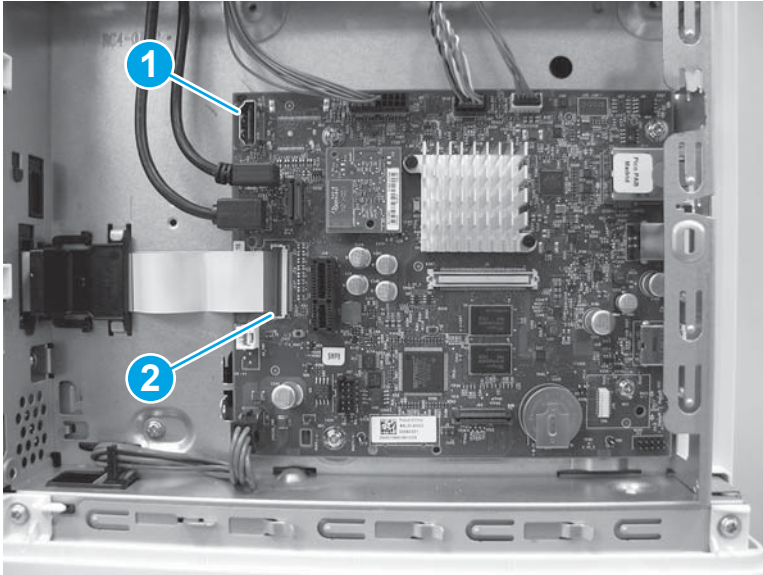
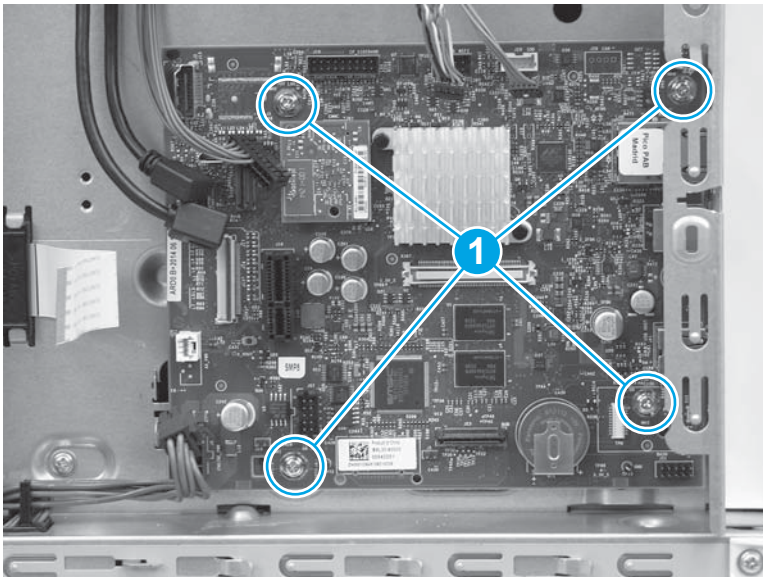

Step 9: Remove the hard-disk drive (HDD) (M577)

 **NOTE:** This step is for the M577 models. For the M552 and M553 models, skip this step and go to [Step 12: Remove the rear cover \(M552 and M553\)](#) on page 2265.

 **CAUTION:**  ESD-sensitive part.

1. Release two tabs (callout 1). Hold the tabs in the released position, and then rotate the hard disk drive (HDD) up (callout 2) to release the connector from the formatter.

Figure 1-4050 Release the HDD

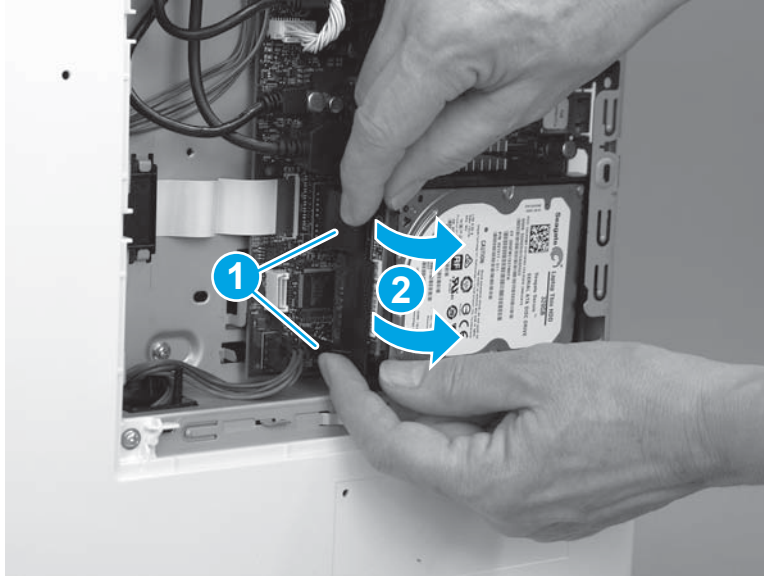

2. Slide the HDD away from the printer to remove it.

Figure 1-4051 Remove the HDD



Step 10: Remove the fax PCA (M577c/f/z)

 **NOTE:** This step is for the M577c/f/z models. For the M577n model, skip this step and go to [Step 11: Remove the formatter \(M577\) on page 2263.](#)

For the M552 and M553 models, skip this step and go to [Step 12: Remove the rear cover \(M552 and M553\) on page 2265.](#)

 **CAUTION:**  ESD-sensitive part.

1. Locate the fax PCA component on the formatter.

Figure 1-4052 Locate the fax PCA

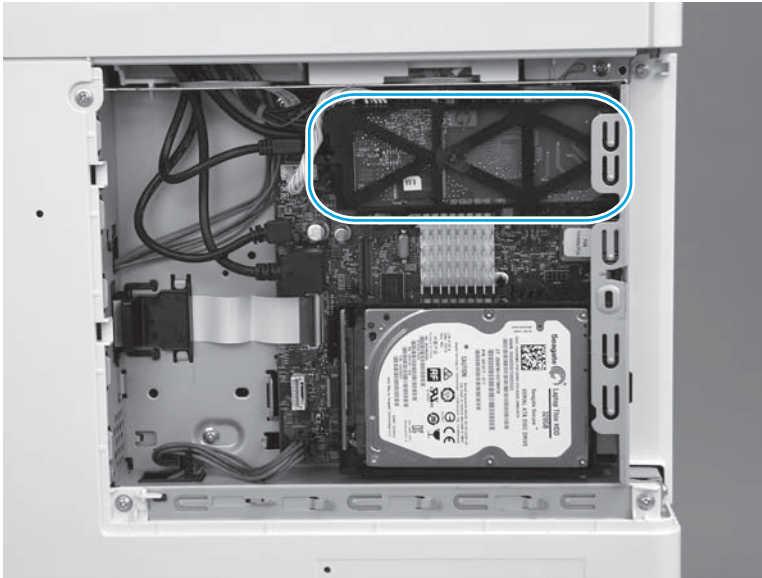

2. Release the connector latch (callout 1), and then pull the connector away from the formatter (callout 2) to disconnect it.

Figure 1-4053 Disconnect one connector

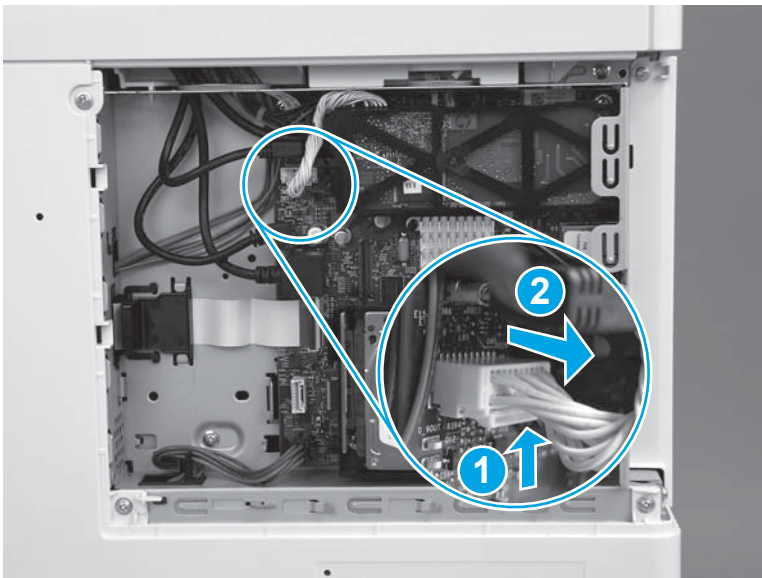

3. Release one retainer (callout 1) by pressing the bracket arms together.

Figure 1-4054 Release one latch

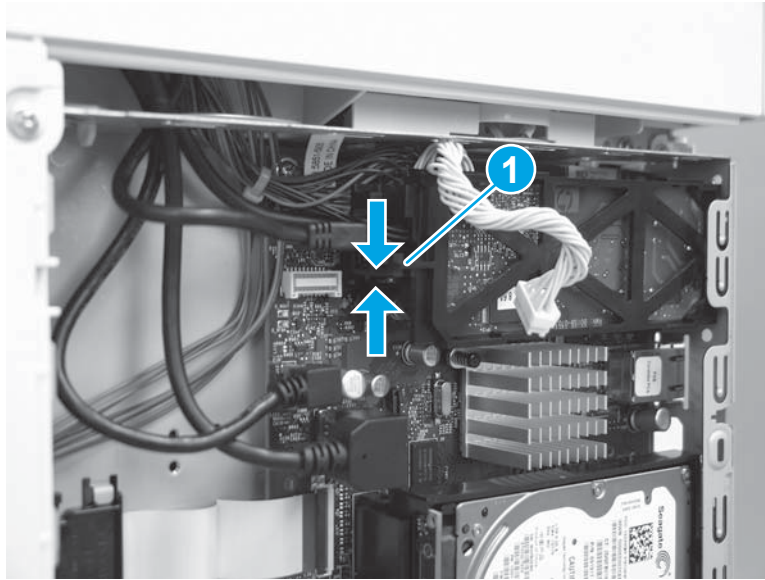

4. Rotate the end of the fax PCA (callout 1) away from the formatter, and then slide the PCA left (callout 2) to remove it.

Figure 1-4055 Remove the fax PCA

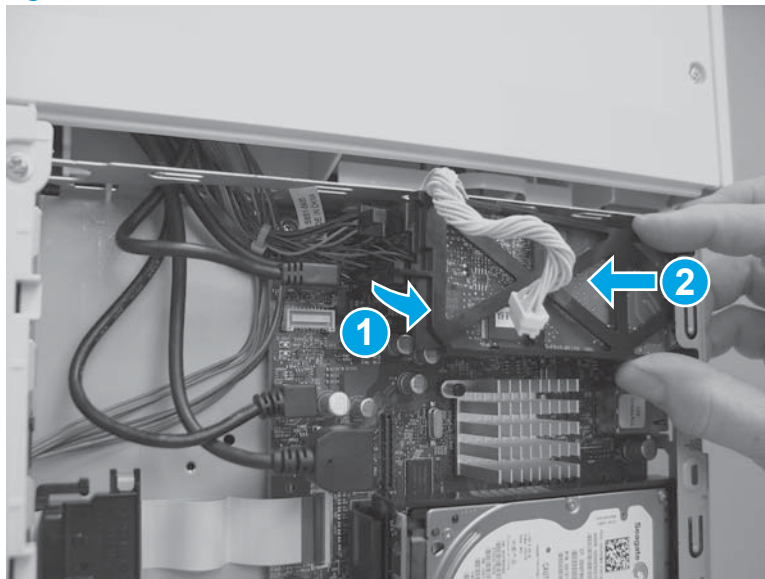

Step 11: Remove the formatter (M577)

 **NOTE:** This step is for the M577 models. For the M552 and M553 models, skip this step and go to [Step 12: Remove the rear cover \(M552 and M553\) on page 2265.](#)

 **CAUTION:**  ESD-sensitive part.

1. Disconnect all of the connectors on the formatter.

The following connectors are empty:

- All models: J1 (this connector is empty unless the optional DIMM is installed)
- All models: J3
- M577dn: J15 (this is the fax connector for the M577f/z/c models)
- All models: J21 (this connector is empty unless the optional internal USB ports component is installed)
- All models: J23
- All models: J24
- All models: J51
- All models: J57
- All models: J97
- All models: J98 (this connector is empty unless the optional trusted platform module (TPM) is installed)

 **IMPORTANT:** The flat-cable connector (callout 1) is a Zero Insertion Force (ZIF) connector that uses a hinged retainer to secure the flat cable. The hinged retainer must be opened to release the flat cable.

Figure 1-4056 Disconnect all connectors



2. Remove four screws (callout 1).

Figure 1-4057 Remove four screws

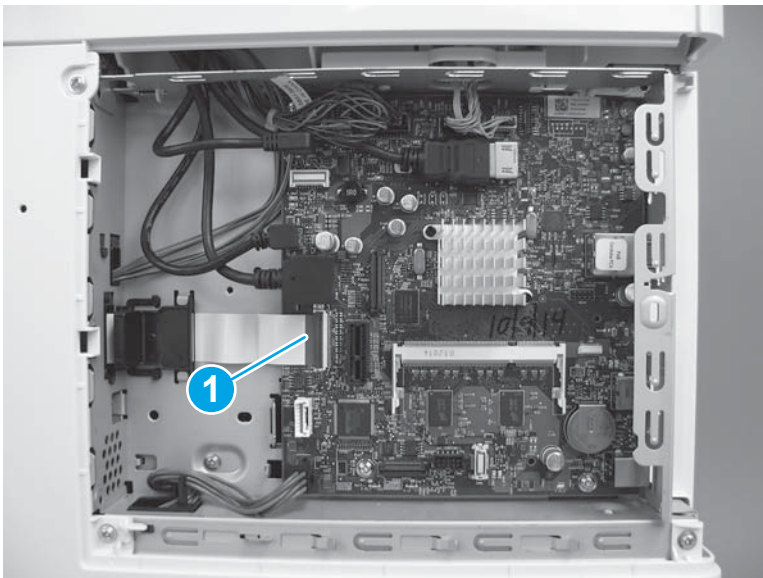
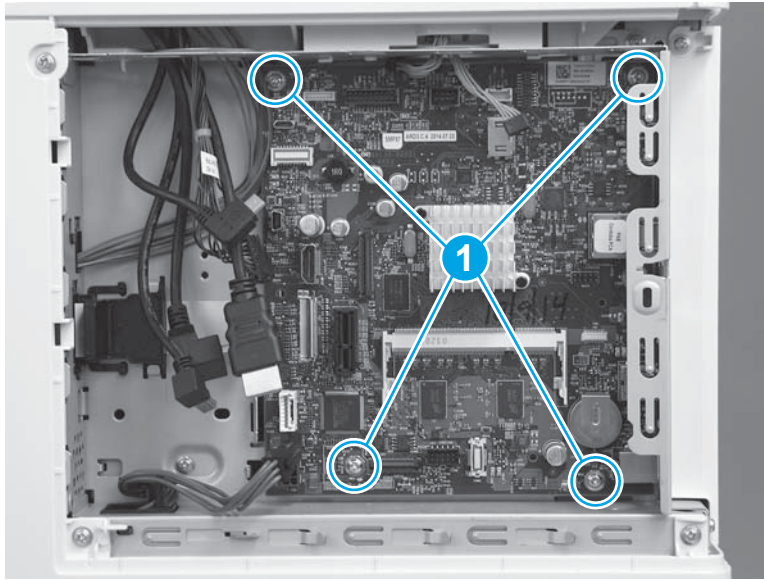

3. Remove the formatter.

Figure 1-4058 Remove the formatter

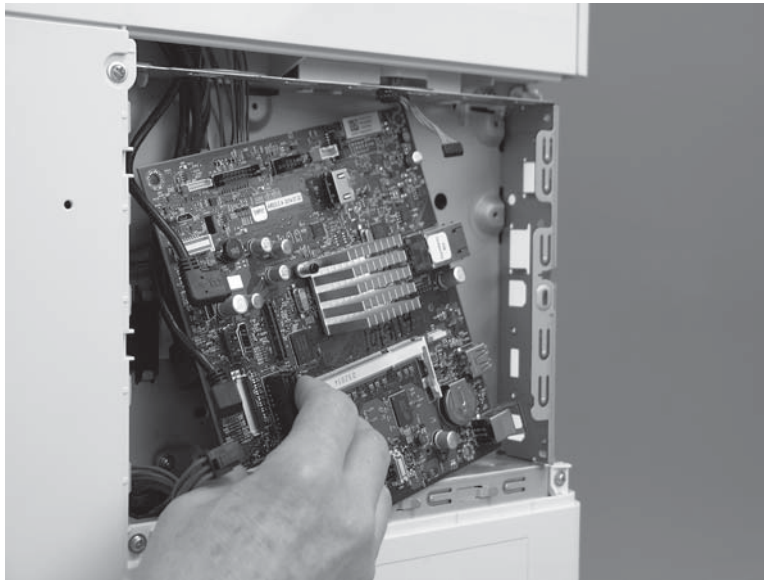

Step 12: Remove the rear cover (M552 and M553)

 **NOTE:** This step is for the M552 and M553 models. For the M577 models, skip this step and go to [Step 13: Remove the rear upper cover \(M577\) on page 2266.](#)

1. Remove four screws (callout 1).

Figure 1-4059 Remove four screws

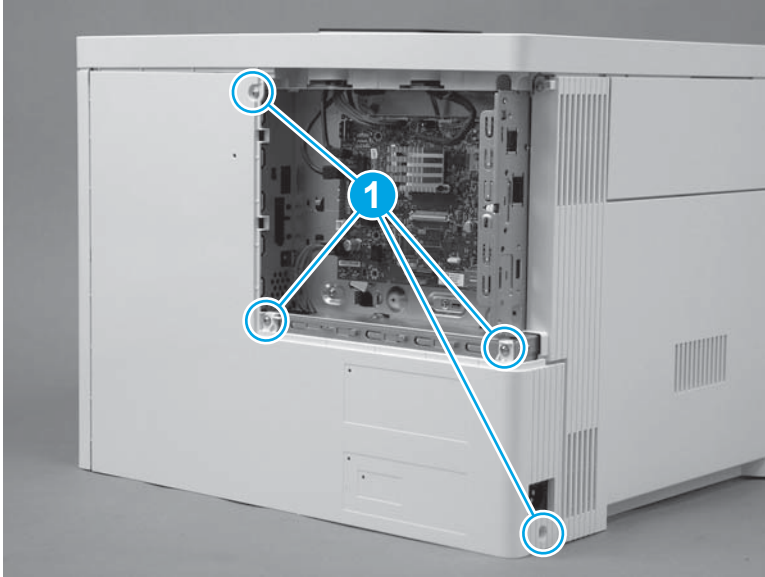

2. Slightly slide the cover to the right (callout 1), rotate the bottom of the cover away from the printer (callout 2), and then pull the top of the cover away from the printer (callout 3) to remove the cover.

Figure 1-4060 Remove the cover

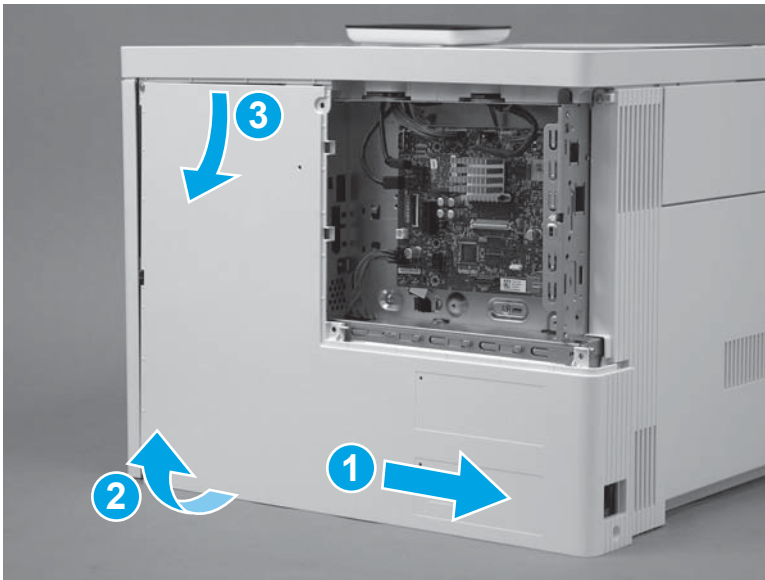

Step 13: Remove the rear upper cover (M577)



NOTE: This step is for the M577 models. For the M552 and M553 models, skip this step and go to [Step 20: Remove the left cover on page 2279](#).

1. Remove two screws (callout 1).



Reinstallation tip: These two screws are self-tapping screws for plastic. When reinstalling them, rotate the screws counterclockwise to align them with the existing thread pattern, and then carefully turn them clockwise to tighten. Do not overtighten. This will prevent stripping the threads inside the screw holes.

Figure 1-4061 Remove two screws

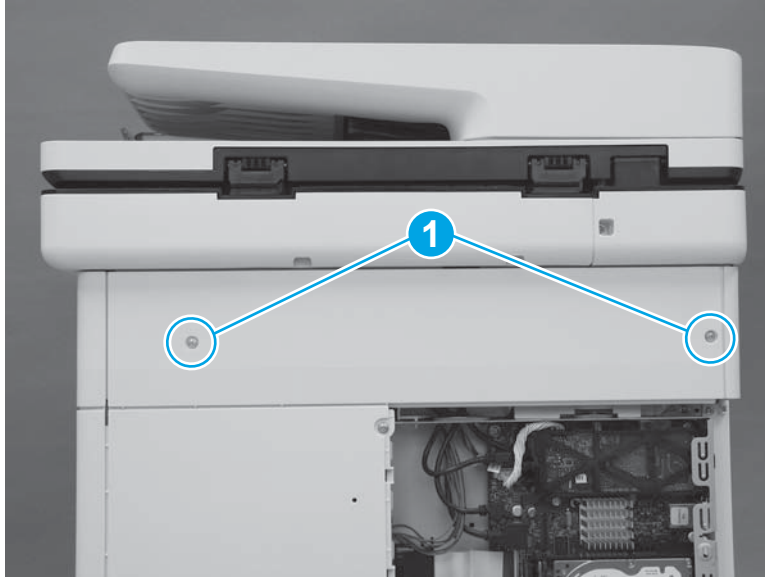

2. Use a small, flat blade screwdriver to release the right edge of the cover.

Figure 1-4062 Release the right edge

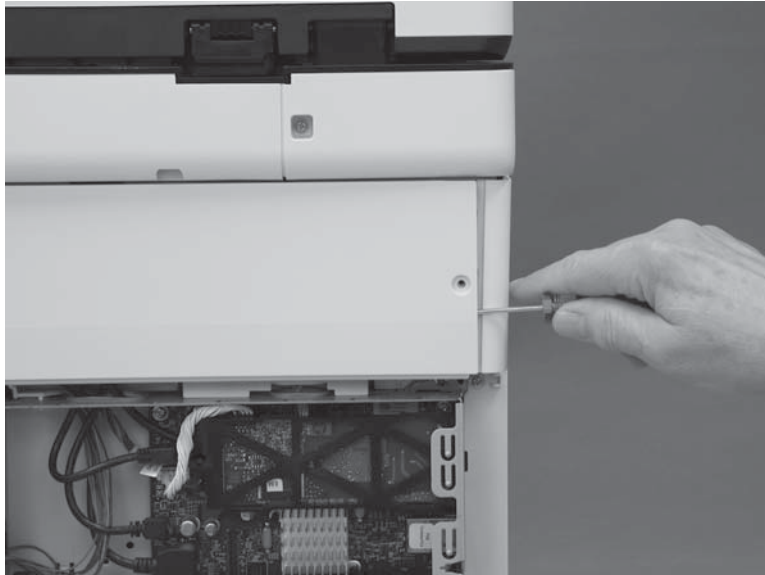

3. Pull the right edge of the cover (callout 1) away from the printer, and then slide the cover to the right (callout 2).

Figure 1-4063 Slide the cover right

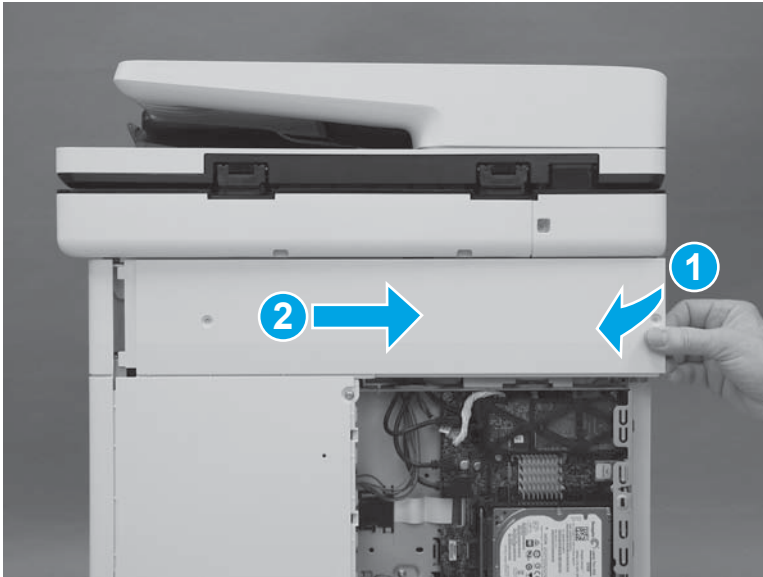

4. Remove the cover.

Figure 1-4064 Remove the cover

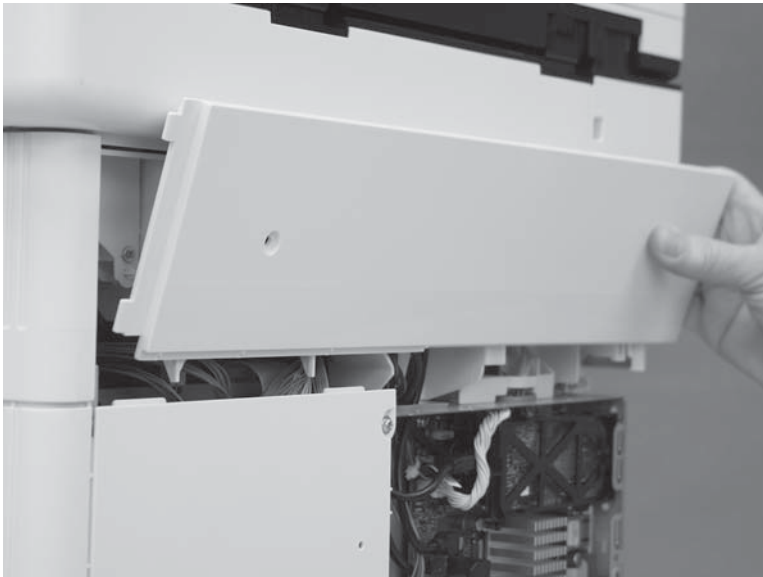

Step 14: Remove the rear cover (M577)



NOTE: This step is for the M577 models. For the M552 and M553 models, skip this step and go to [Step 20: Remove the left cover on page 2279](#).

1. Remove four screws (callout 1).

Figure 1-4065 Remove four screws

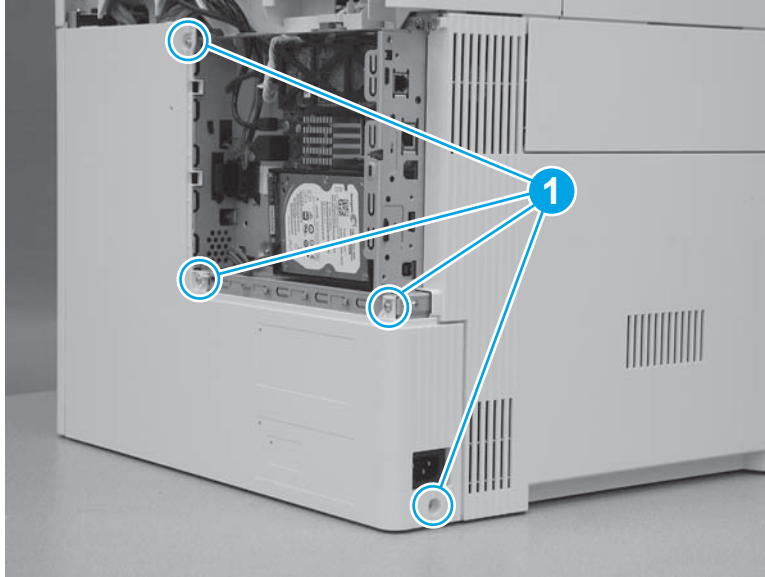

2. Slide the cover to the right to remove it.

Figure 1-4066 Remove the cover

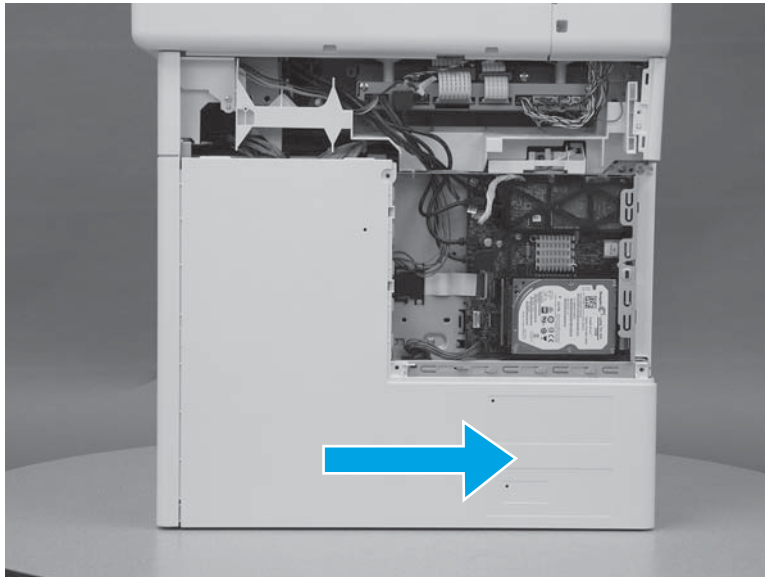

Step 15: Remove the left upper cover (M577)



NOTE: This step is for the M577 models. For the M552 and M553 models, skip this step and go to [Step 20: Remove the left cover on page 2279](#).

1. At the left side of the printer, release one tab (callout 1).

Figure 1-4067 Release one tab

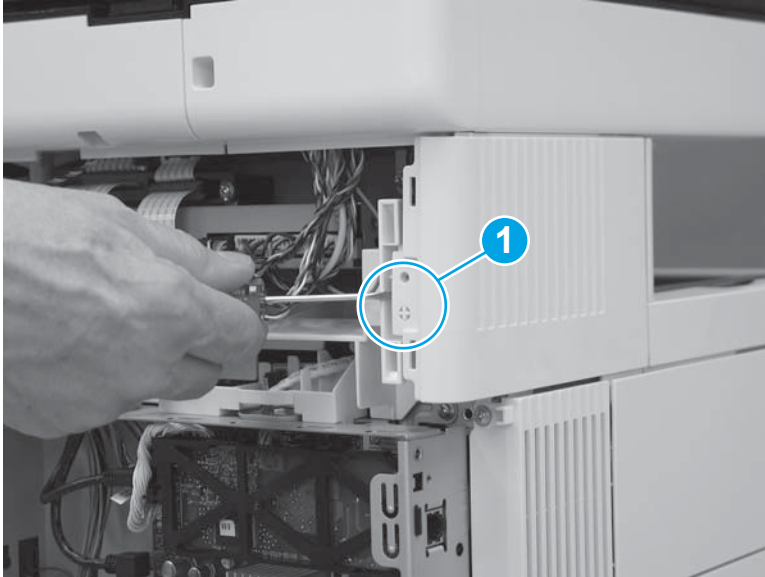

2. Slide the left upper cover toward the back of the printer.

Figure 1-4068 Slide the cover back

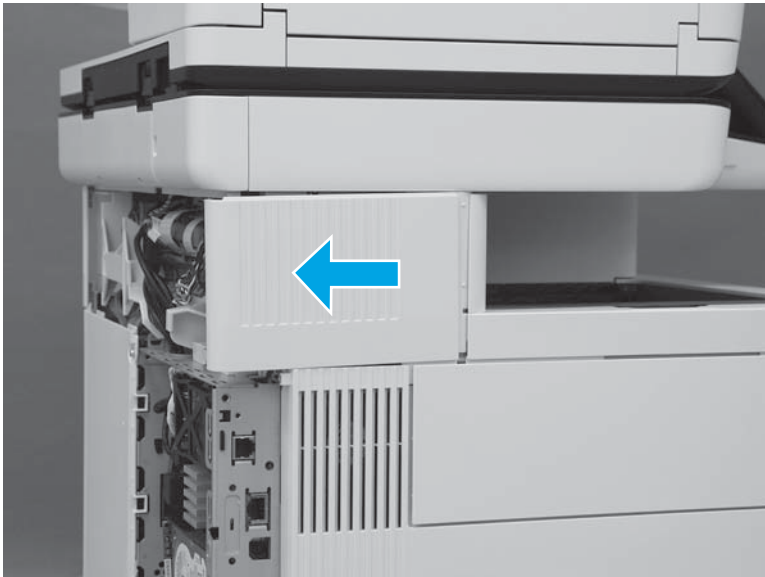

3. Rotate the cover up to remove it.

Figure 1-4069 Remove the left upper cover



Step 16: Remove the right front upper cover (M577dn)

 **NOTE:** This step is for the M577dn model. For the M577c/f/z models, skip this step and go to [Step 17: Remove the stapler cover assembly \(M577c/f/z\) on page 2272.](#)

For the M552 and M553 models, skip this step and go to [Step 20: Remove the left cover on page 2279.](#)

1. Remove one screw (callout 1).

Figure 1-4070 Remove one screw

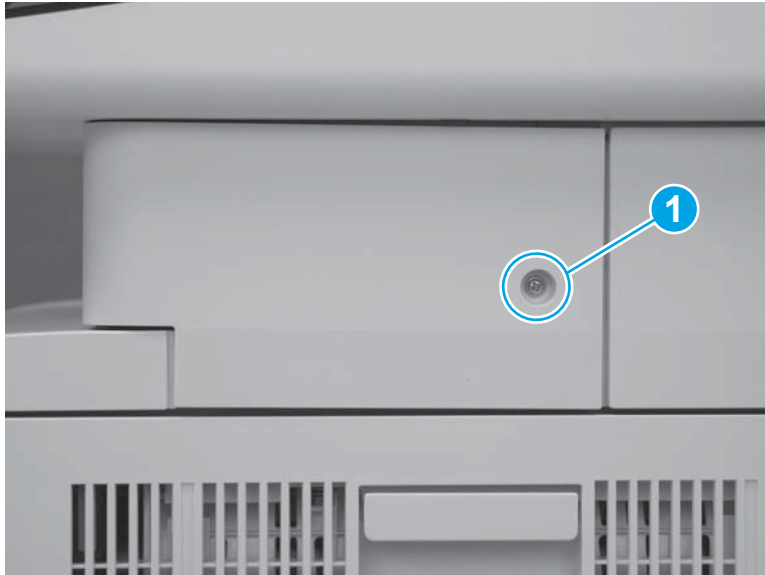

2. Release two tabs at the front edge of the cover (callout 1).

Figure 1-4071 Release two tabs



3. Rotate the front of the cover to the right to remove it.

Figure 1-4072 Rotate the cover



Step 17: Remove the stapler cover assembly (M577c/f/z)

 **NOTE:** This step is for the M577c/f/z models. For the M577dn model, skip this step and go to [Step 19: Remove the right upper cover \(M577\) on page 2277](#).

For the M552 and M553 models, skip this step and go to [Step 20: Remove the left cover on page 2279](#).

1. Remove one screw (callout 1).

 **Reinstallation tip:** This is a self-tapping screw for plastic. When reinstalling, rotate the screw counterclockwise to align it with the existing thread pattern, and then carefully turn it clockwise to tighten. Do not overtighten. This will prevent stripping the threads inside the screw hole.

Figure 1-4073 Remove one screw



2. Release two tabs at the front edge of the cover (callout 1).

Figure 1-4074 Release two tabs

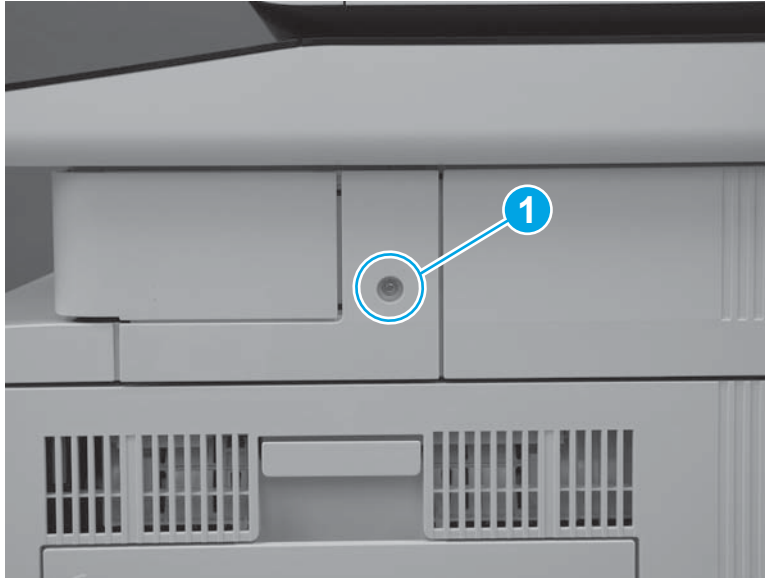

3. Release the back edge of the cover.

Figure 1-4075 Release the back edge of the cover

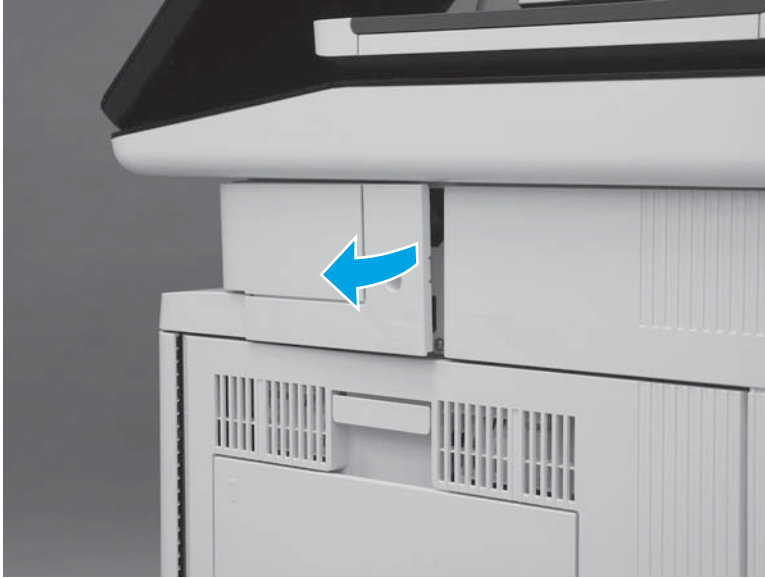



4. Rotate the cover away from the printer to remove it.

Figure 1-4076 Remove the cover



Step 18: Remove the integrated scanner assembly (ISA) (M577)

 **NOTE:** This step is for the M577 models. For the M552 and M553 models, skip this step and go to [Step 20: Remove the left cover on page 2279](#).

 **NOTE:** The ISA includes the document feeder, image scanner, scanner control board (SCB), control panel, keyboard (M577c/z) and NFC PCA (M577z).

1. At the left side of the printer, remove one screw (callout 1).

Figure 1-4077 Remove one screw

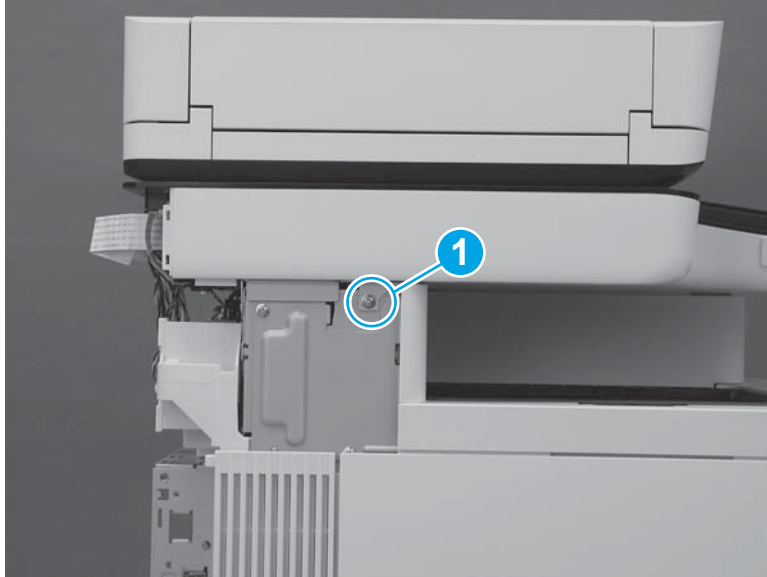

2. At the back side of the printer, remove two screws (callout 1).

Figure 1-4078 Remove two screws

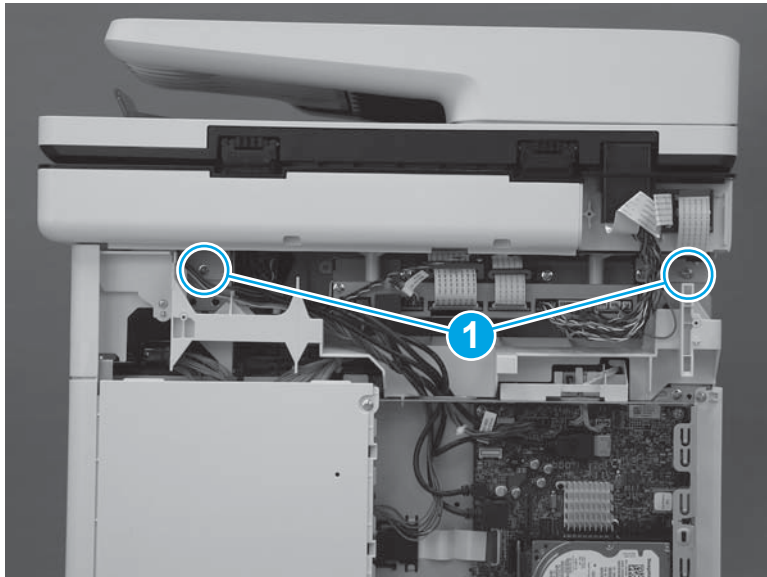

3. At the right side of the printer, remove one screw (callout 1).

Figure 1-4079 Remove one screw

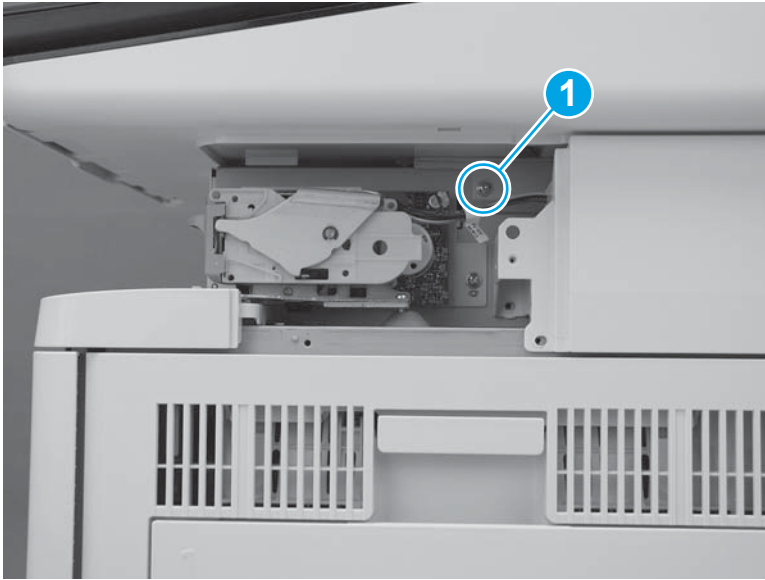

4. Disconnect two connectors on the scanner control board (callout 1).

M577c/f/z only: Disconnect one connector for the stapler on the scanner control board (callout 2).

Figure 1-4080 Disconnect connectors

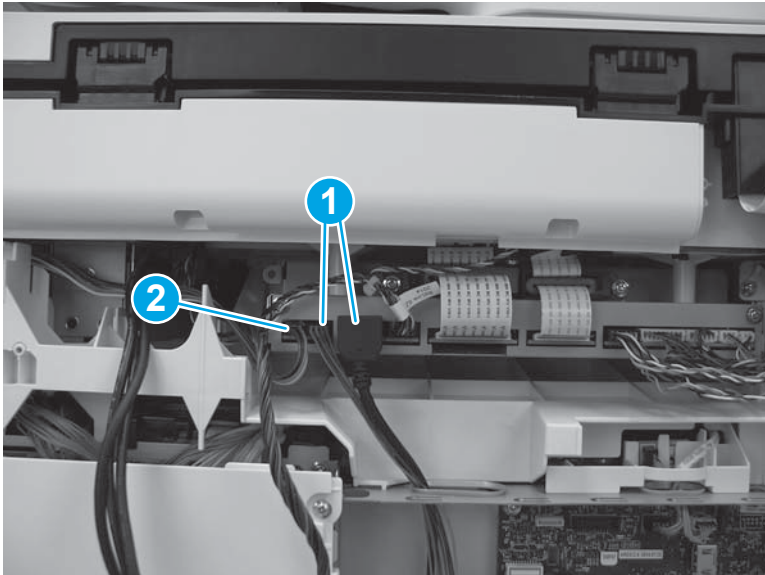

5. Slightly slide the ISA towards the back of the printer to release it.

Figure 1-4081 Slide the ISA towards the back of the printer

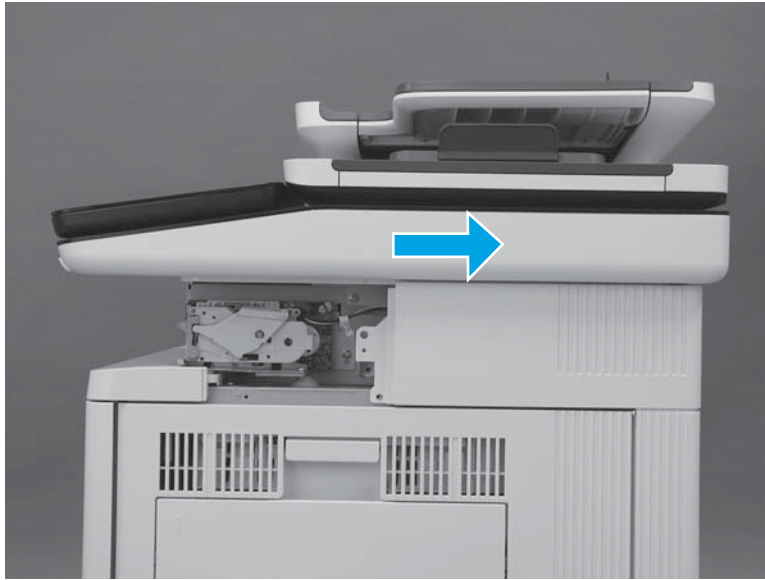

6. Lift the ISA up to remove it.



 **NOTE:** When lifting the ISA, carefully pass the cables through the opening in the top of the formatter case.

Figure 1-4082 Remove the ISA

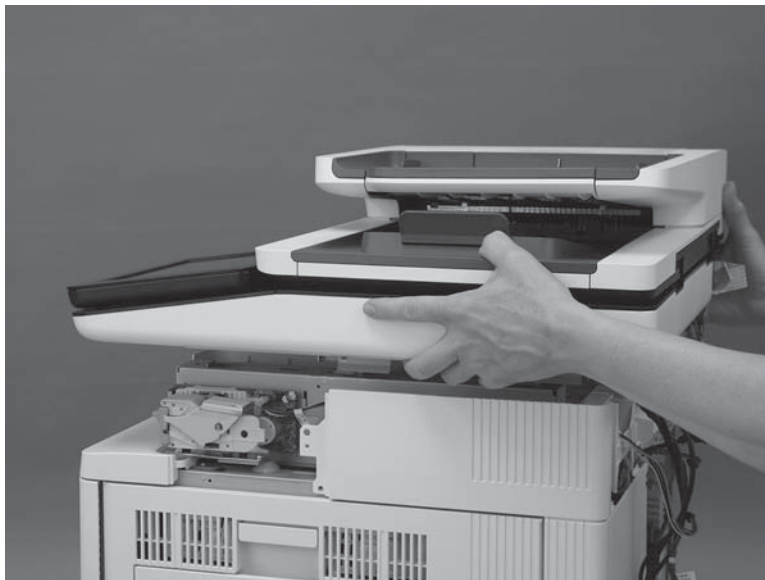

Step 19: Remove the right upper cover (M577)

 **NOTE:** This step is for the M577 models. For the M552 and M553 models, skip this step and go to [Step 20: Remove the left cover on page 2279](#).



NOTE: The figures below show the image scanner installed. The procedures for removing and installing the right upper cover are the same whether the image scanner is installed or removed."

1. At the right side of the printer, remove two screws (callout 1).

M577c/f/z only: Disconnect one connector (callout 2), if it was not already disconnected in a previous step.

Figure 1-4083 Remove two screws and one connector

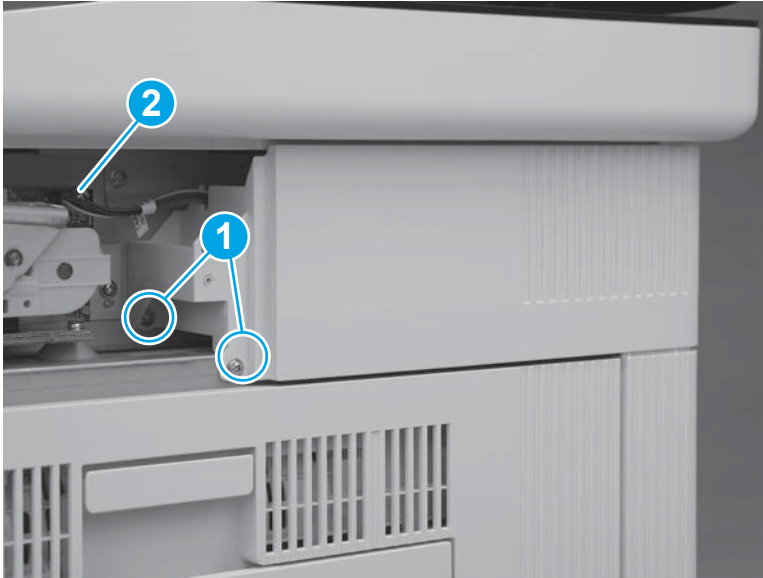

2. At the back of the printer, remove one screw (callout 1).

M577c/f/z only: Disconnect one connector (callout 2), if it was not already disconnected in a previous step.



Reinstallation tip: This screw is smaller than the screws removed in the previous step. When reinstalling the right upper cover, make sure that this screw is installed in the correct position.

Figure 1-4084 Remove one screw and connector

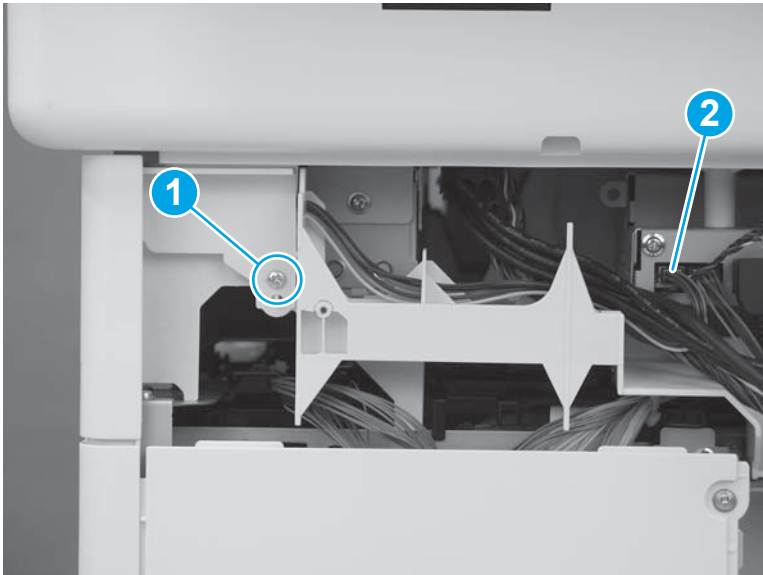

3. Slide the cover toward the back of the printer.

Figure 1-4085 Slide the cover

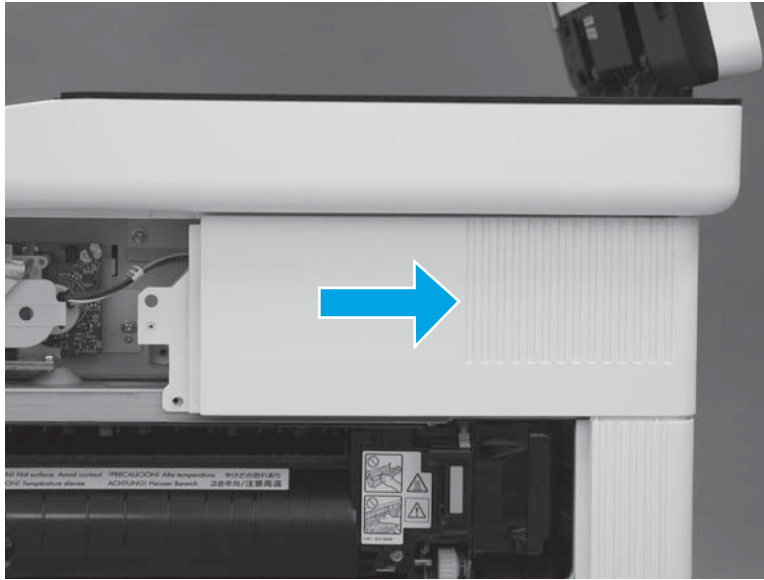

4. Lift the cover away from the printer to remove it.

M577c/f/z only: Release the cables (callout 1) through the slot (callout 2) in the printer.

Figure 1-4086 Remove the cover

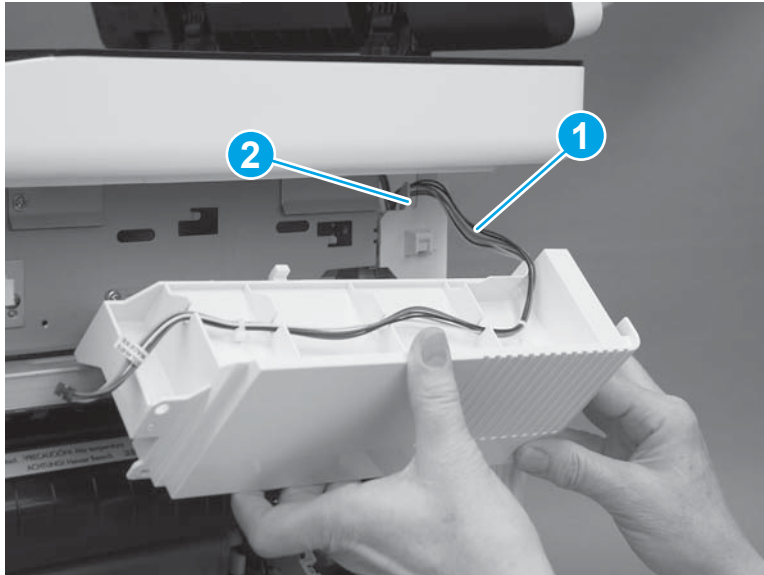

Step 20: Remove the left cover

1. At the left side of the printer, remove one screw (callout 1).

Figure 1-4087 Remove one screw



2. Release one tab (callout 1), rotate the front edge of the cover away from the printer (callout 2), and then slide the cover (callout 3) toward the rear of the printer to release it.

Figure 1-4088 Release the cover

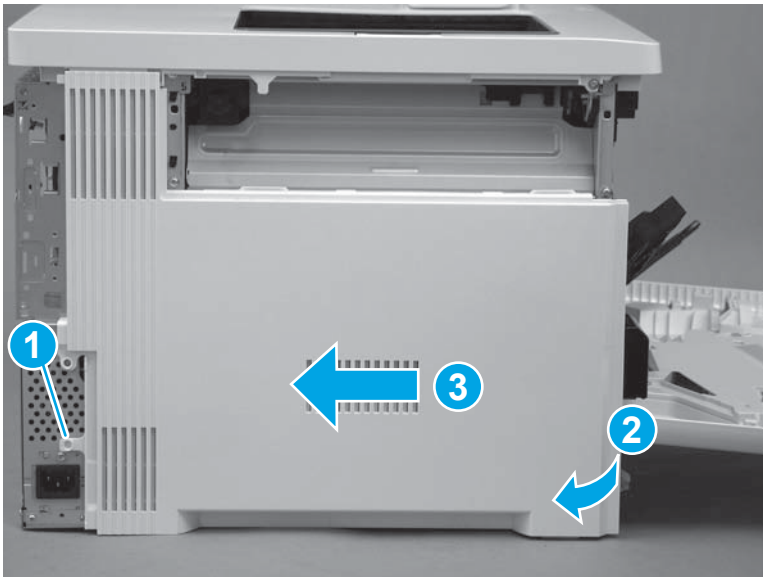

3. Remove the cover.

Figure 1-4089 Remove the cover

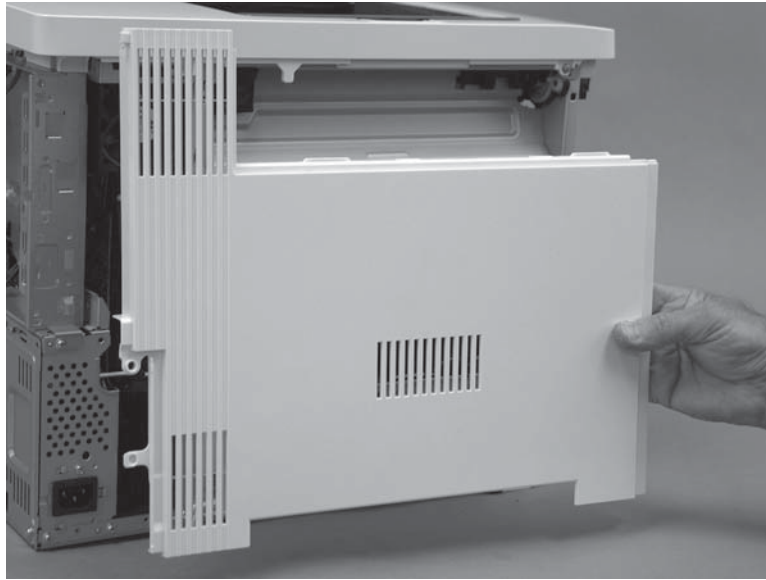

Step 21: Remove the upper cover (M552 and M553)

 **NOTE:** This step is for the M552 and M553 models. For the M577 models, skip this step and go to [Step 22: Remove the right rear cover on page 2283](#).

1. Remove three screws (callout 1).

Figure 1-4090 Remove three screws

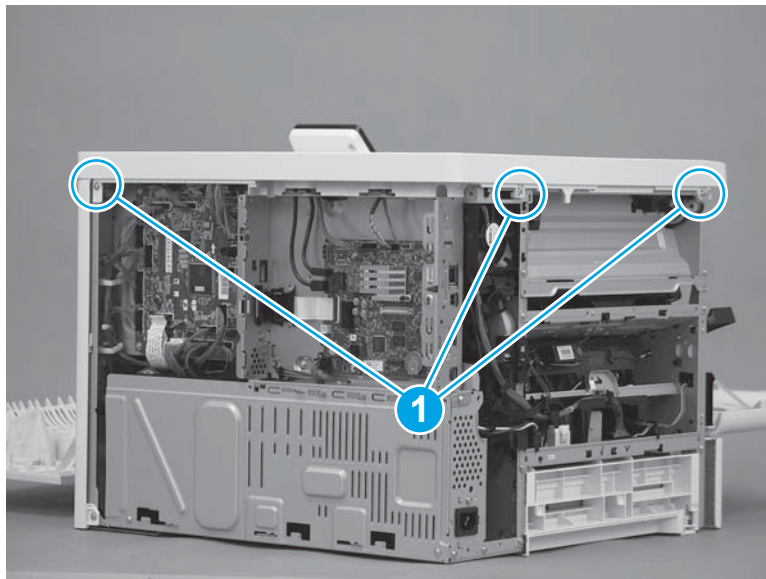

2. Remove one screw (callout 1), release one tab (callout 2), and then slightly separate the corner of the cover from the chassis.

 **NOTE:** This is a self-tapping plastic-thread screw. Make sure that this screw is used in this location when it is reinstalled.

Figure 1-4091 Remove one screw and release one tab



3. Release one tab (callout 1), and then lift up on the cover to release it.

 **NOTE:** If the cover does not release, check for addition tabs by locating the triangles embossed in the cover at tab locations.

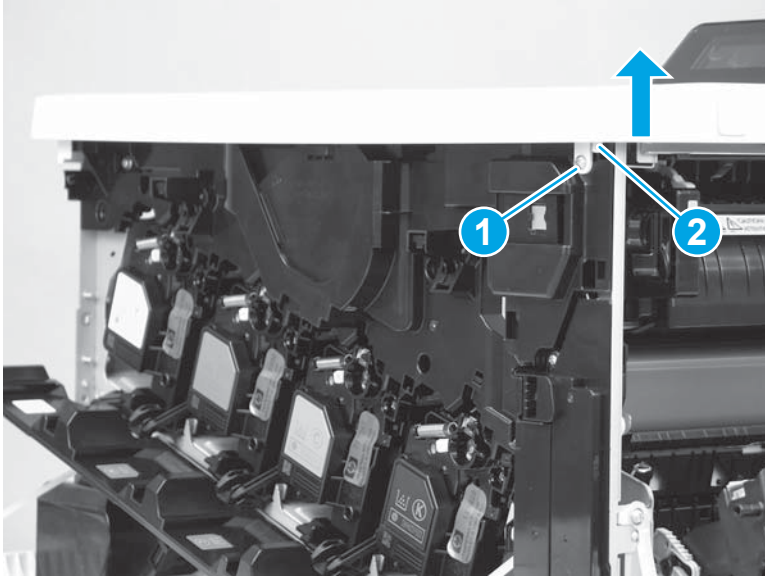
Figure 1-4092 Release the cover



4. Remove the cover.

Figure 1-4093 Remove the cover

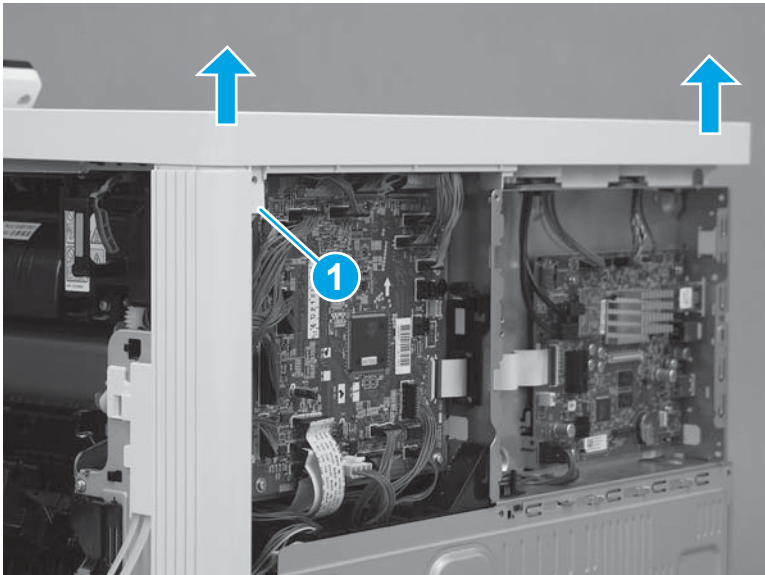
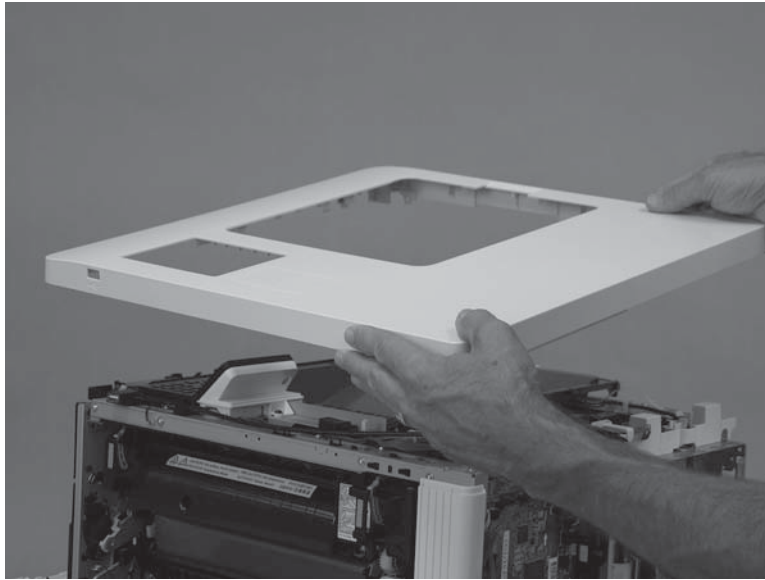

Step 22: Remove the right rear cover

1. Remove one screw (callout 1), and then slide the cover toward the rear of the printer (callout 2) to release it.

 **TIP:** If the right door is closed, open it now.

Figure 1-4094 Release the cover

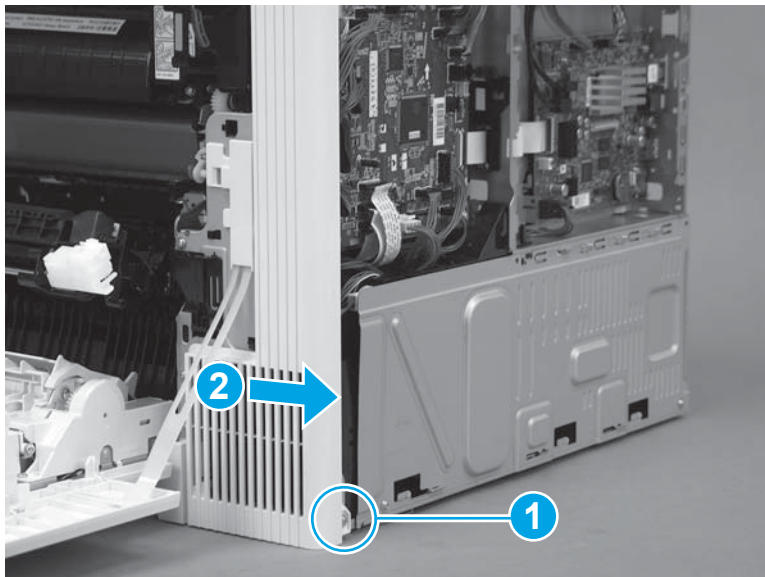

2. Remove the cover.

Figure 1-4095 Remove the cover

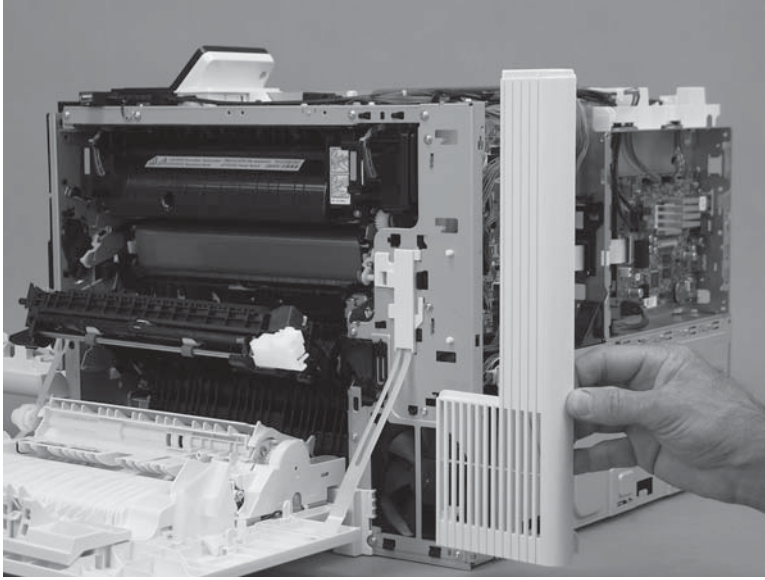

Step 23: Remove the formatter case

1. **M577 only:** Disconnect one connector (callout 1), and then pass the wire harness (callout 2) through two openings in the formatter case (callout 3).

Figure 1-4096 Disconnect one connector

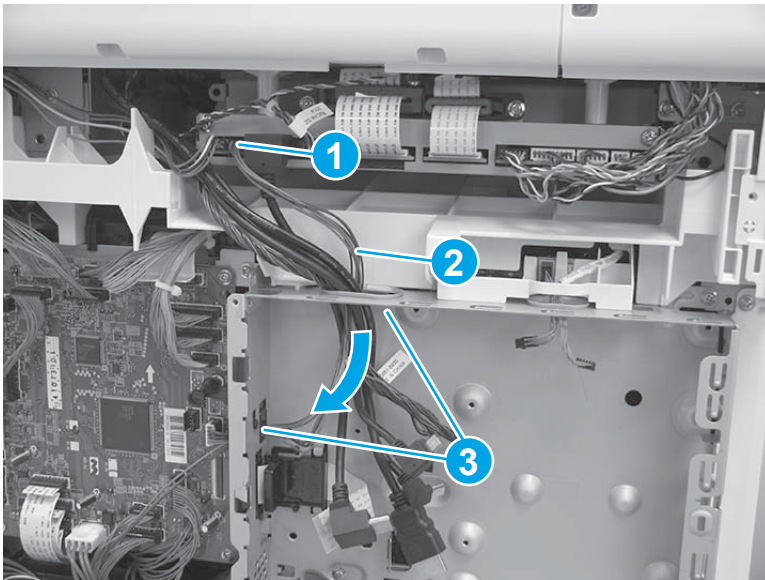

2. Release two tabs (callout 1) on the black plastic bracket. Hold the tabs in the released position, and then slide the bracket (callout 2) to the right to remove it from the formatter case.

Figure 1-4097 Remove the bracket

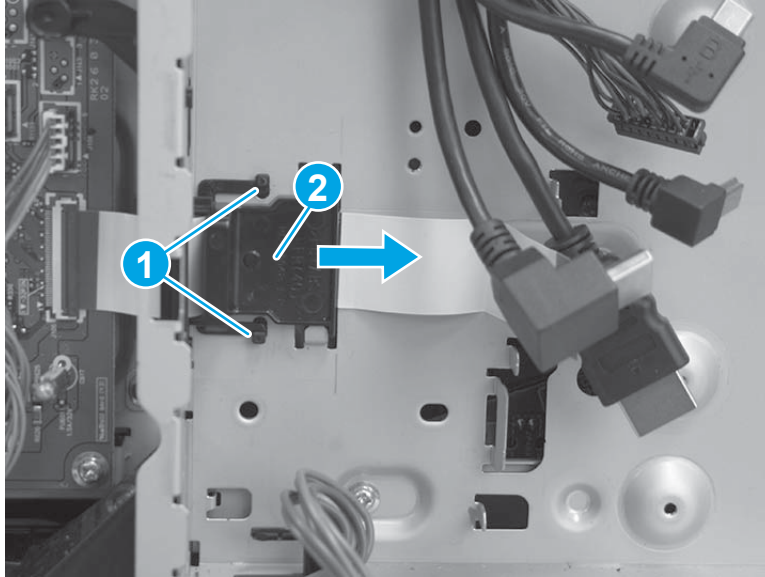

3. Remove two screws (callout 1), and then slide the low-voltage power supply (LVPS) cover to the right to remove it.

Figure 1-4098 Remove the LVPS cover

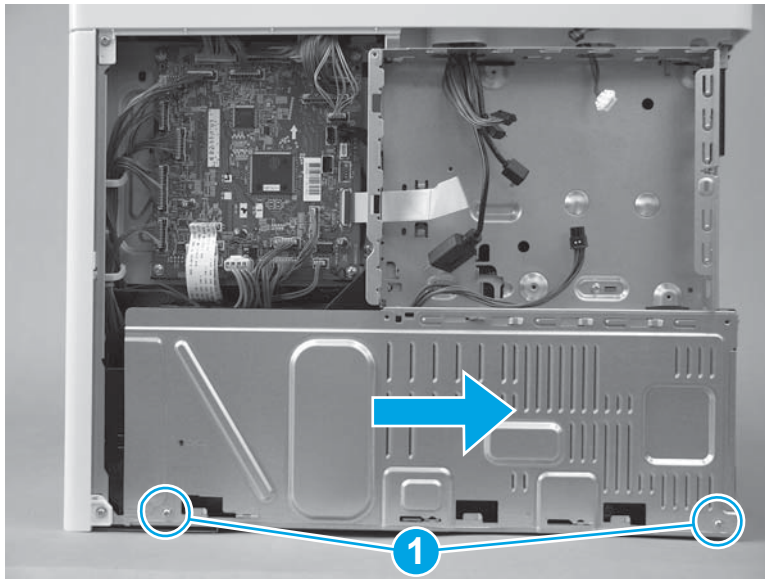

4. Pass two wire harnesses and one flat cable (callout 1) through the opening in the formatter case, and then release one wire harness from the retainer (callout 2).

⚠ CAUTION: The flat cable might be attached to the formatter case with double-sided tape. Make sure that this tape is released, so that the flat cable is not damaged when the formatter case is removed.

Figure 1-4099 Release wire harnesses and flat cable

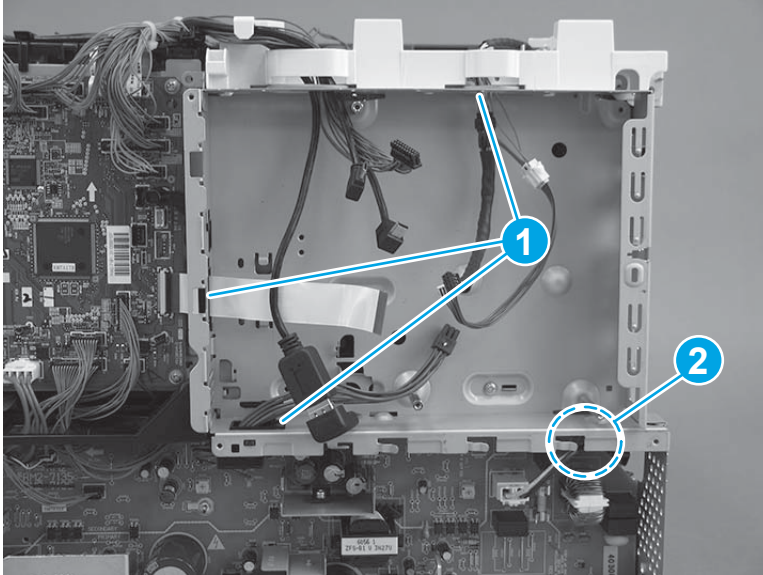

5. Remove six screws (callout 1).

Figure 1-4100 Remove six screws

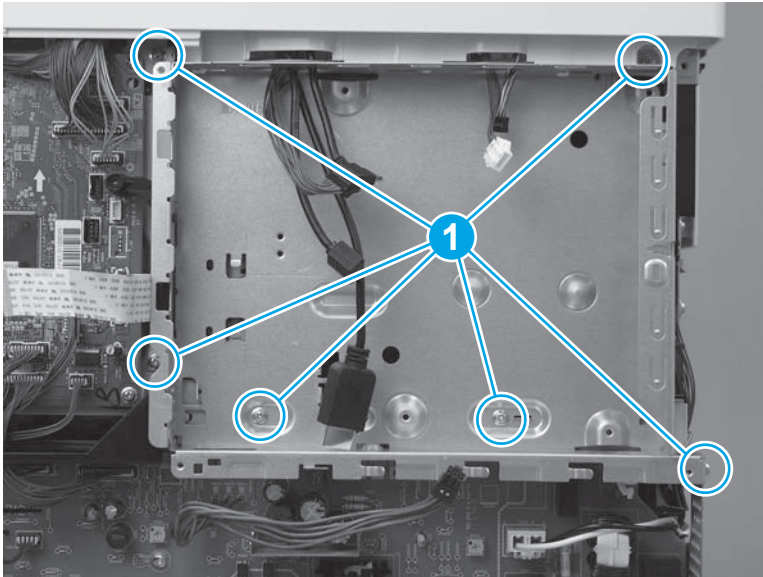

6. Rotate the bottom of the formatter case away from the printer (callout 1), and then pull it down (callout 2) to release it.

Figure 1-4101 Release the formatter case

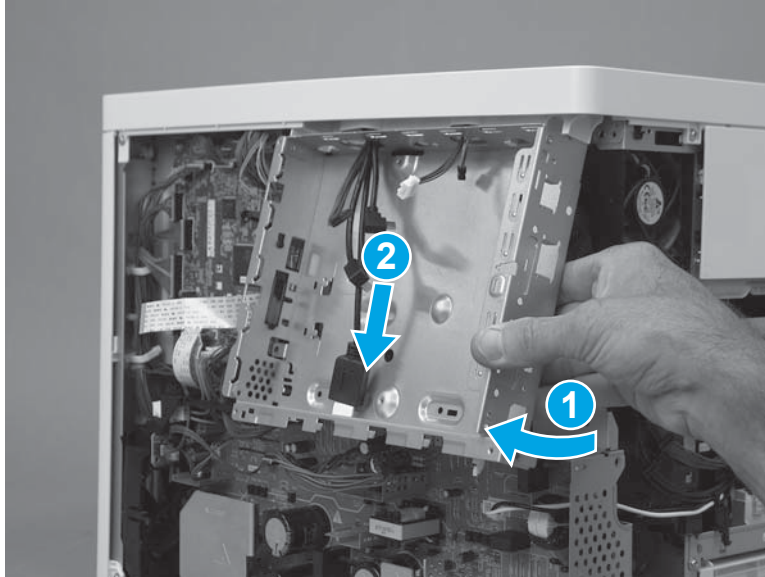

7. Pass the wire harnesses through the opening in the formatter case to remove it.

 **IMPORTANT:** If the formatter case is removed so that it can be replaced, make sure to transfer the memory PCA (island of data) and plastic bracket (callout 1) to the replacement case.

Figure 1-4102 Remove the formatter case



Step 24: Remove the low-voltage power supply (LVPS)

 **CAUTION:**  ESD-sensitive part.

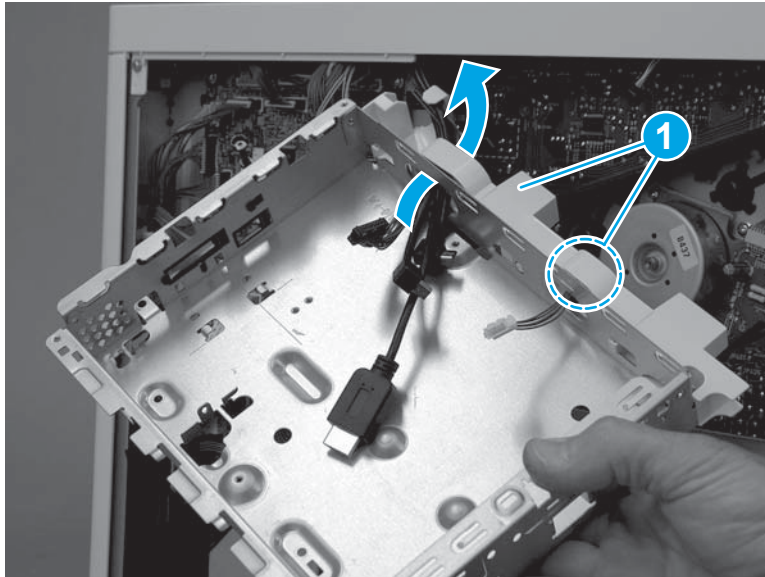
1. Disconnect one wire harness (callout 1), and then pass the wire harness through the opening (callout 2) in the chassis.

Figure 1-4103 Disconnect one wire harness

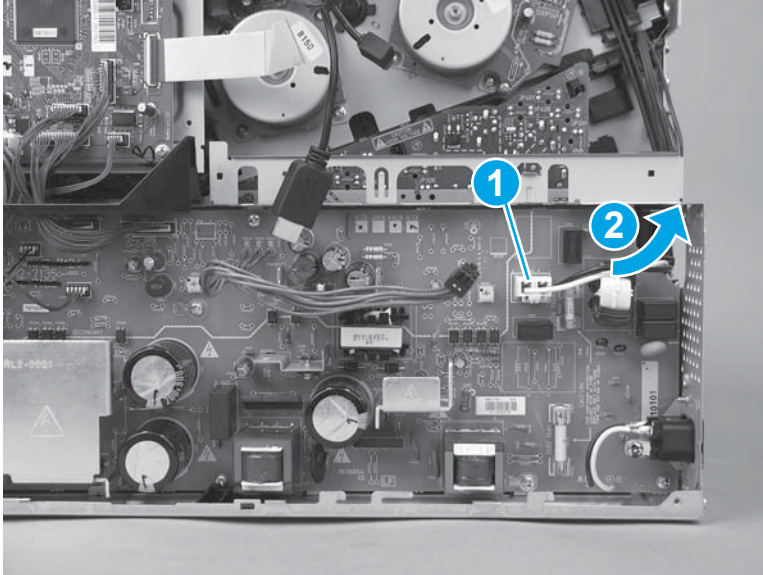

2. Disconnect three connectors on the DC controller (callout 1), and then disconnect four connectors (callout 2) on the LVPS.

Figure 1-4104 Disconnect seven connectors

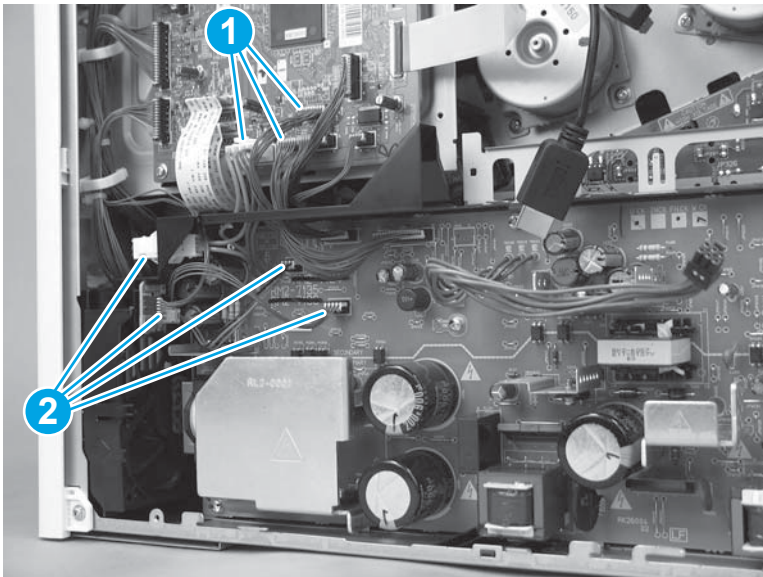

3. Pass the wire harnesses from the DC controller to the LVPS through the opening in the chassis (callout 1), and then release the wire harnesses from the retainer (callout 2).

Figure 1-4105 Pass the wire harnesses through the opening

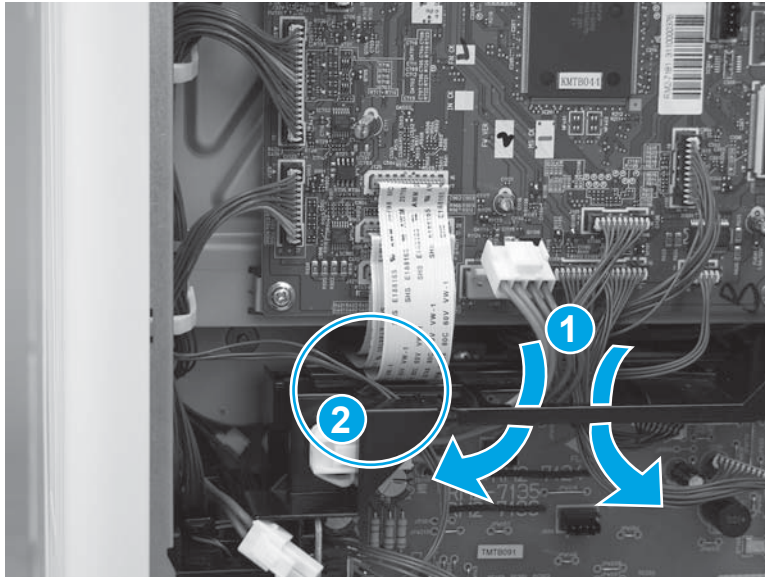

4. Remove three screws (callout 1).

Figure 1-4106 Remove three screws

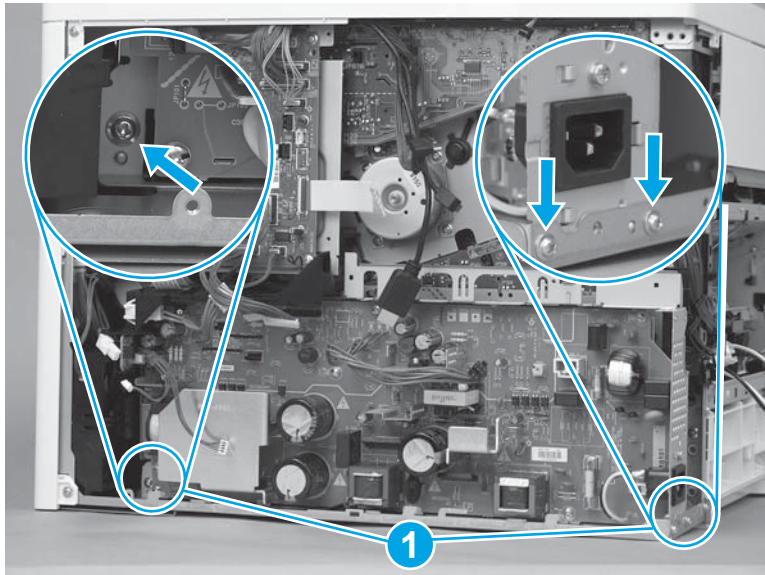

5. Rotate the top of the LVPS away from the printer (callout 1), and then slide it up and out (callout 2) of the printer to remove it.

Figure 1-4107 Remove the LVPS

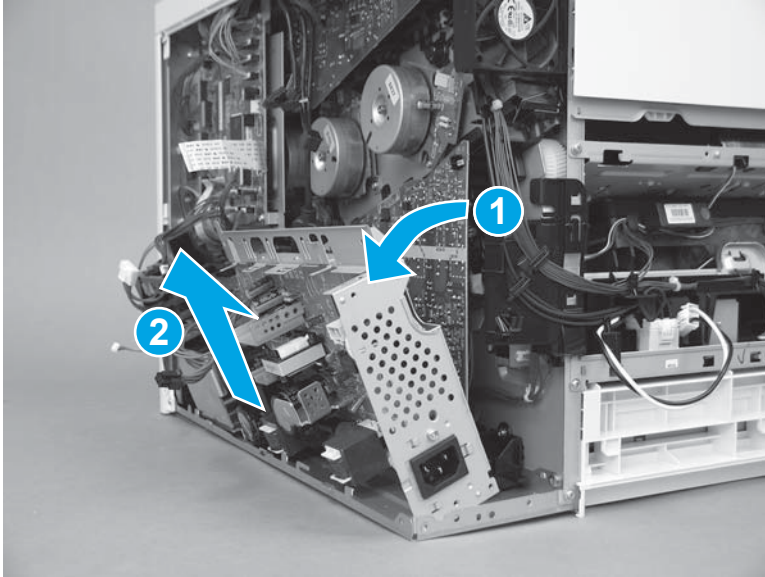

Step 25: Remove the power supply fan (FM1)

1. Remove one screw (callout 1).

Figure 1-4108 Remove one screw

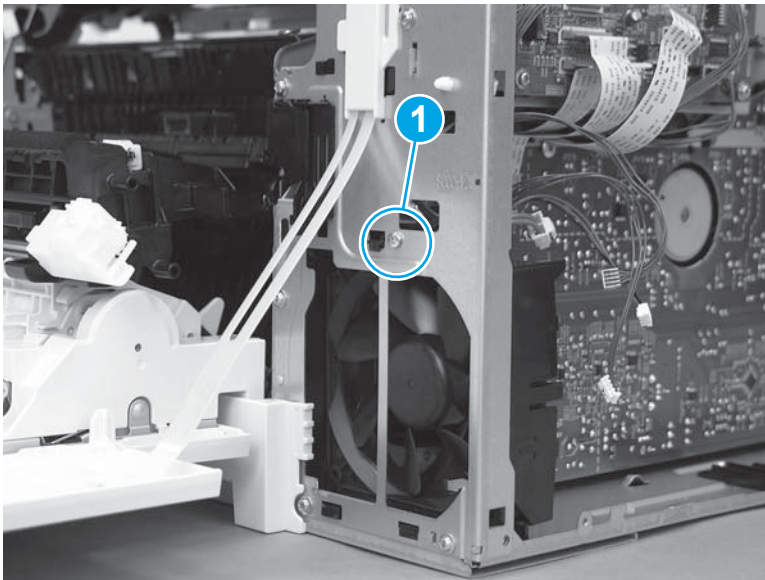

2. Release the wire harnesses from the retainer on the top of the fan bracket.

Figure 1-4109 Release the wire harnesses

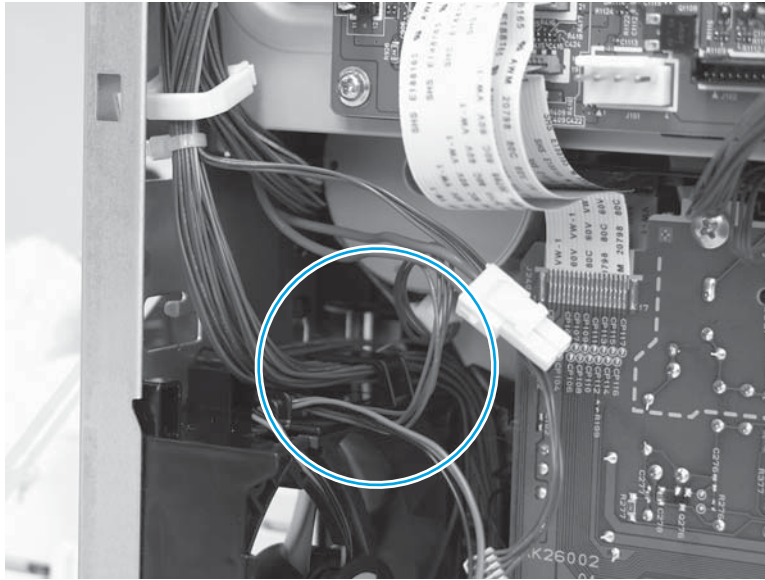

3. Lift the fan up (callout 1), and then slide it out of the printer (callout 2) to remove it.

Figure 1-4110 Remove the fan

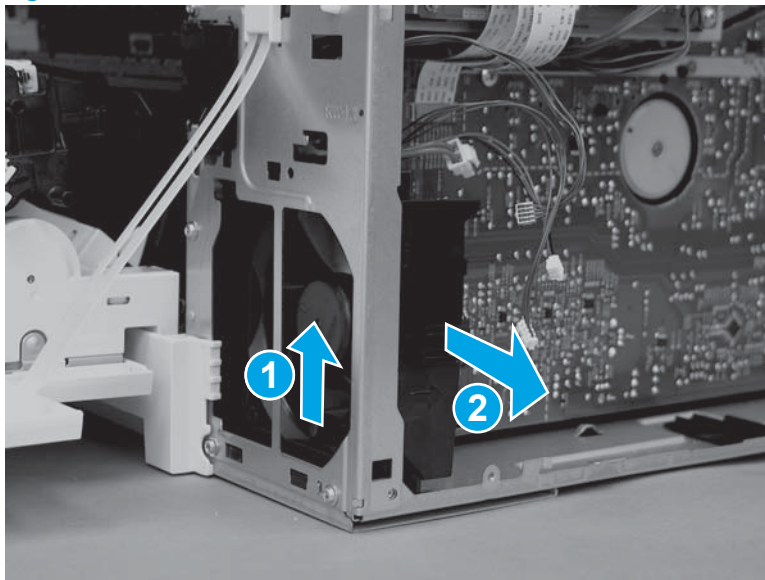

Step 26: Remove the high-voltage power supply D (HVPSD)

CAUTION:  ESD-sensitive part.

1. Disconnect one flat cable (callout 1) on the DC controller.

Figure 1-4111 Disconnect one flat cable

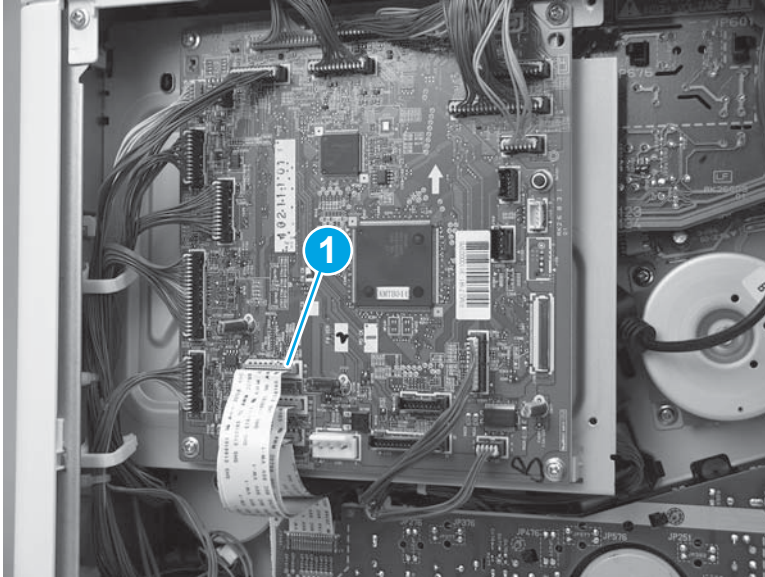

2. Remove two screws (callout 1), and then remove one self tapping screw (callout 2) on the HVPSD.

Figure 1-4112 Remove three screws

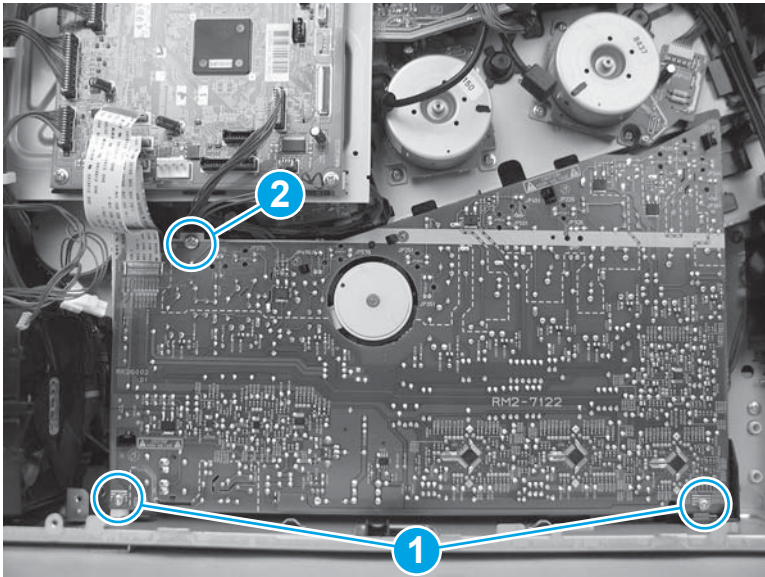

3. Release five tabs (callout 1), and then remove the HVPSD (callout 2).

Figure 1-4113 Remove the HVPSD

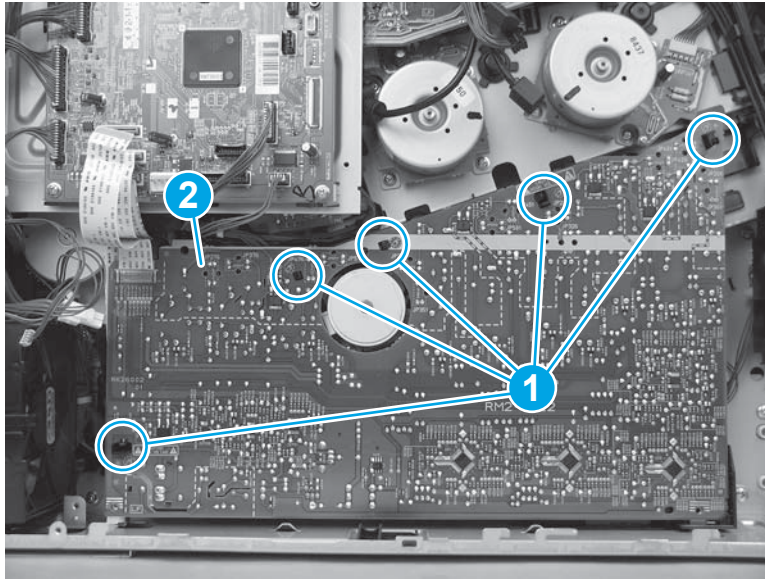

Step 27: Remove the lifter drive assembly

1. Disconnect two connectors (callout 1).

Figure 1-4114 Disconnect two connectors

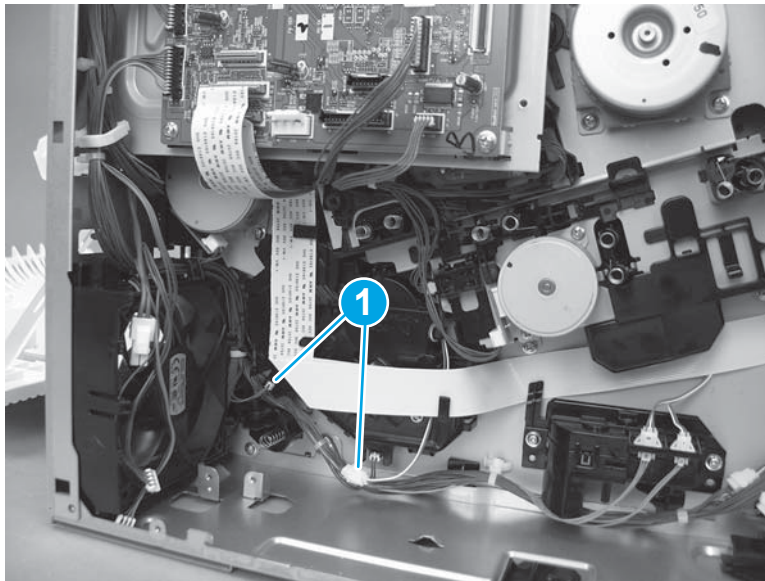

2. Disconnect two flat cables (callout 1), and then release them from the retainers (callout 2).

Figure 1-4115 Disconnect two flat cables

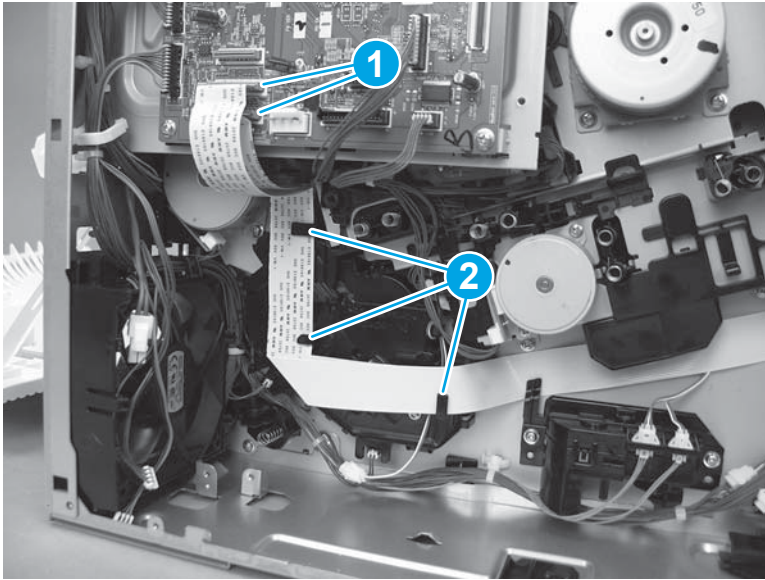

3. Remove two screws (callout 1), release one tab (callout 2), and then remove the lifter drive assembly (callout 3).

 **NOTE:** Release one wire harness from the retainer (callout 4) as the assembly is removed.

Figure 1-4116 Remove the assembly



Step 28: Remove the DC controller and sheet-metal bracket

 **CAUTION:**  ESD sensitive part.

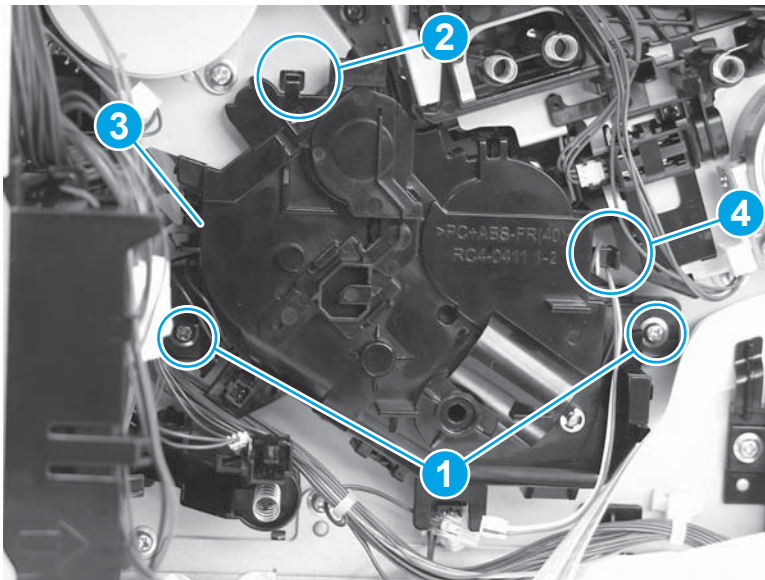
1. Disconnect all of the connectors, and then remove two screws (callout 1).

The following connectors are empty:

- J140, J141, and J143

Figure 1-4117 Remove two screws

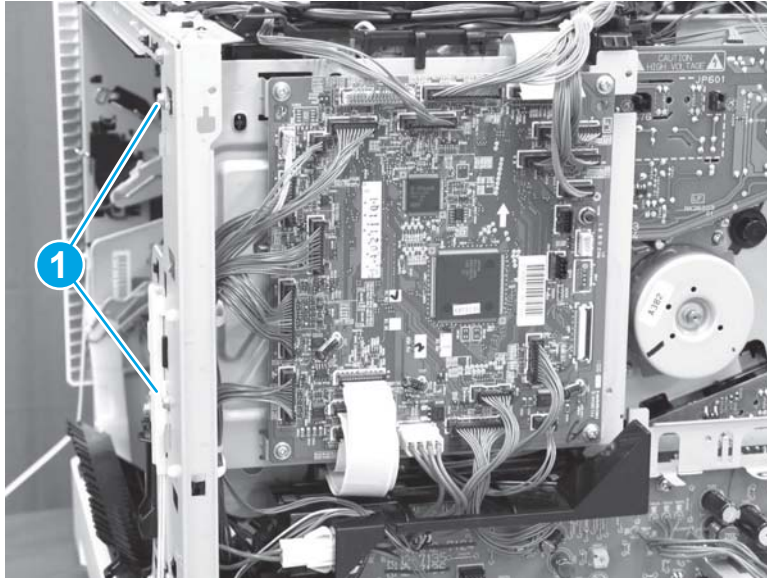

2. Lift up on the DC controller and sheet-metal plate to remove it.

Figure 1-4118 Remove the plate

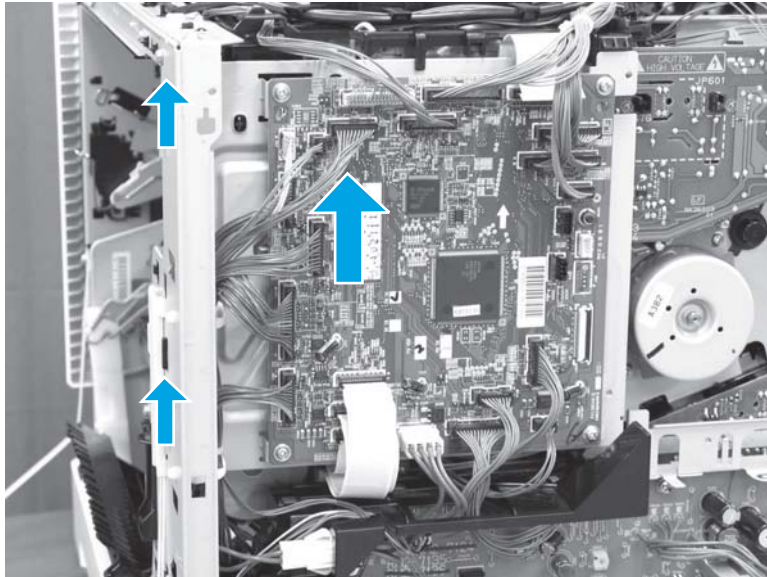

Step 29: Remove the pickup drive assembly and motor (M5)

1. Release one tab (callout 1), and then move the guide (callout 2) out of the way.

Figure 1-4119 Move the guide out of the way

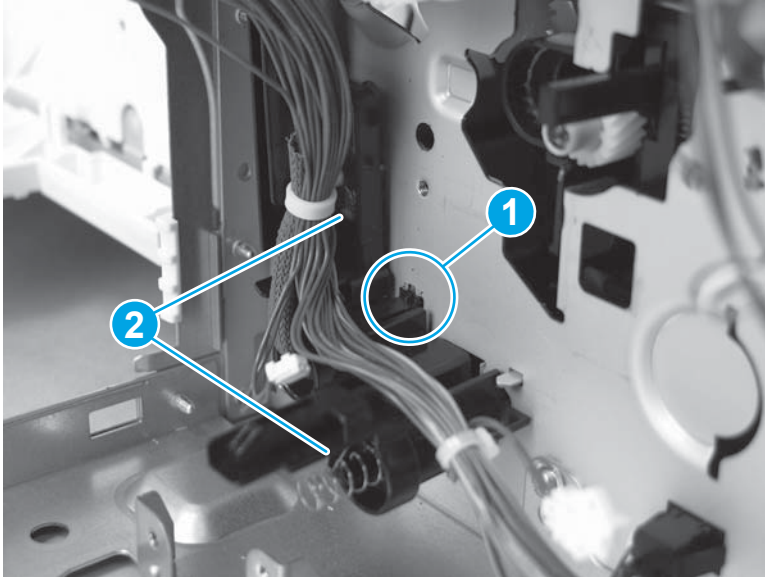

2. Remove three screws (callout 1).

Figure 1-4120 Remove three screws

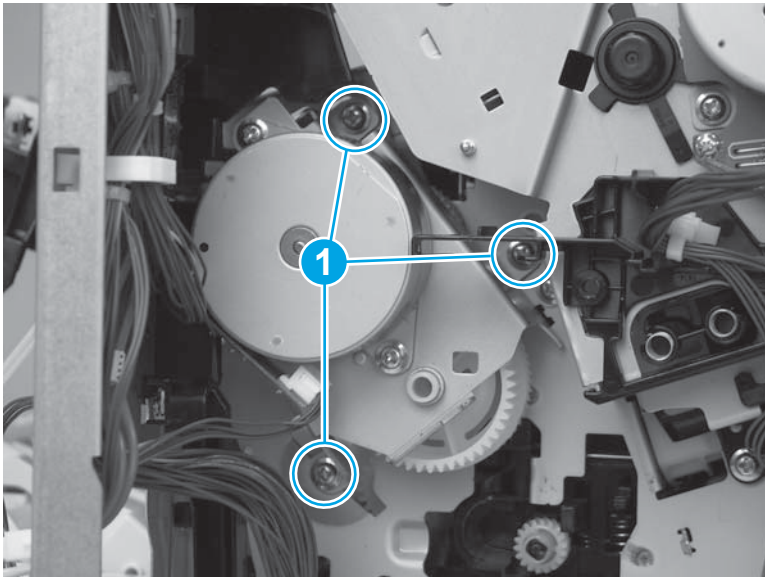

3. Remove the assembly.

CAUTION: One gear on the back side of the assembly is not captive. Handle the assembly carefully.

Figure 1-4121 Remove the assembly

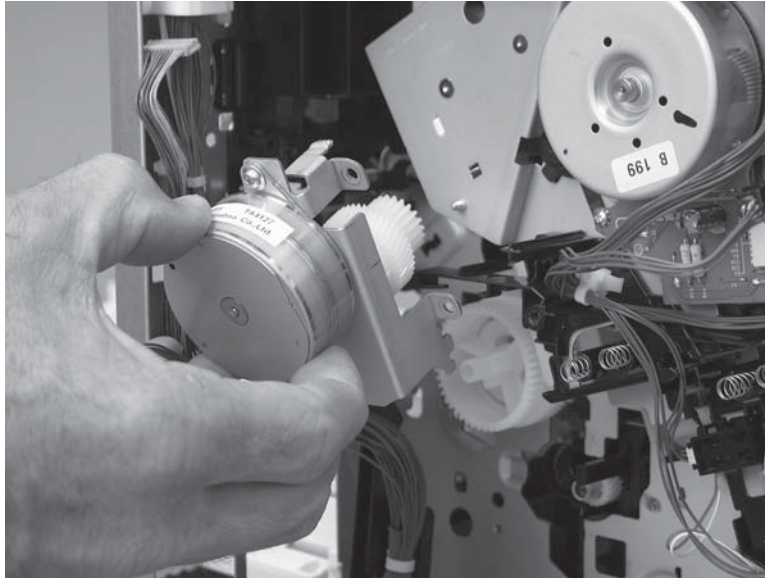

4. If the gear (callout 1) was not removed with the assembly in the previous step, remove it now.

Figure 1-4122 Remove the gear if installed

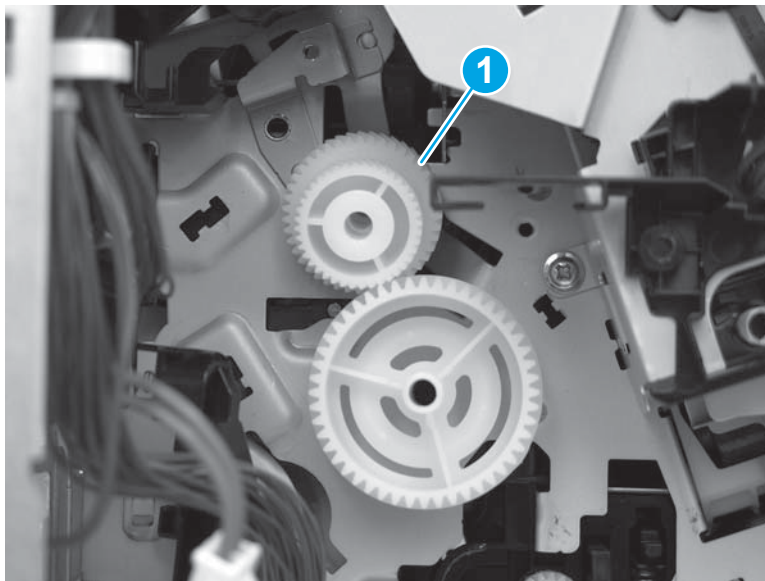

Step 30: Remove the registration assembly

1. At the right side of the printer, release one tab (callout 1).

Figure 1-4123 Release one tab

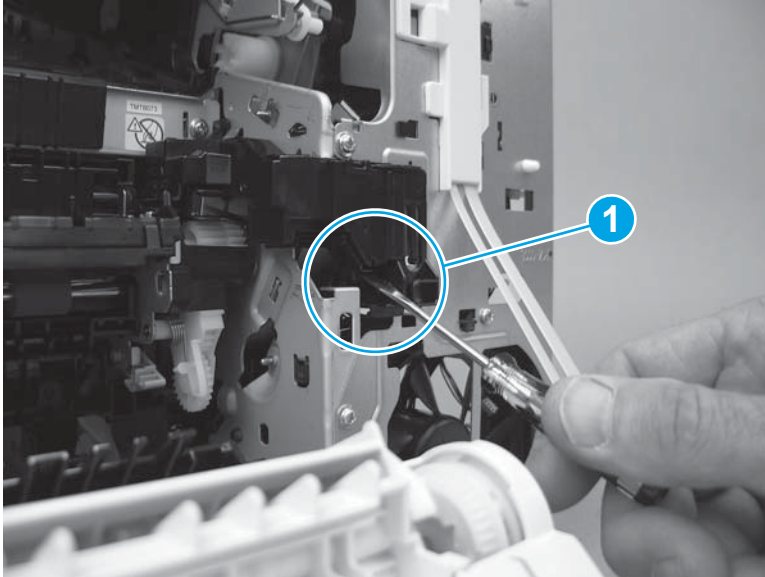

2. Remove the cover.

Figure 1-4124 Remove the cover

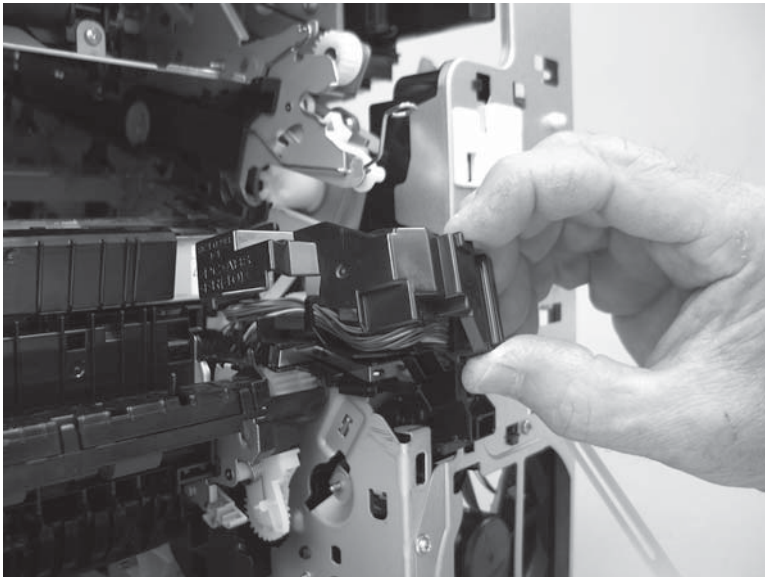

3. Release one tab (callout 1), and then push down on the guide (callout 2) to release it.

Figure 1-4125 Release the guide

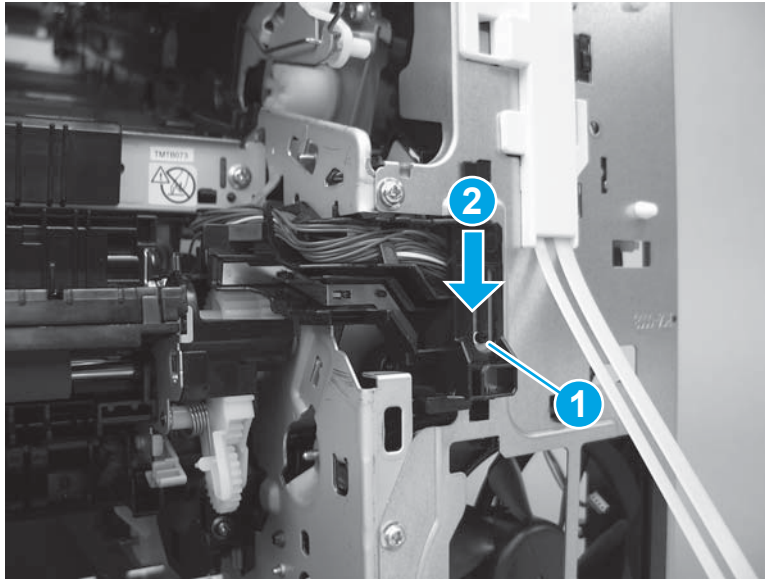

4. Move the guide out of the way.

Figure 1-4126 Move the guide out of the way

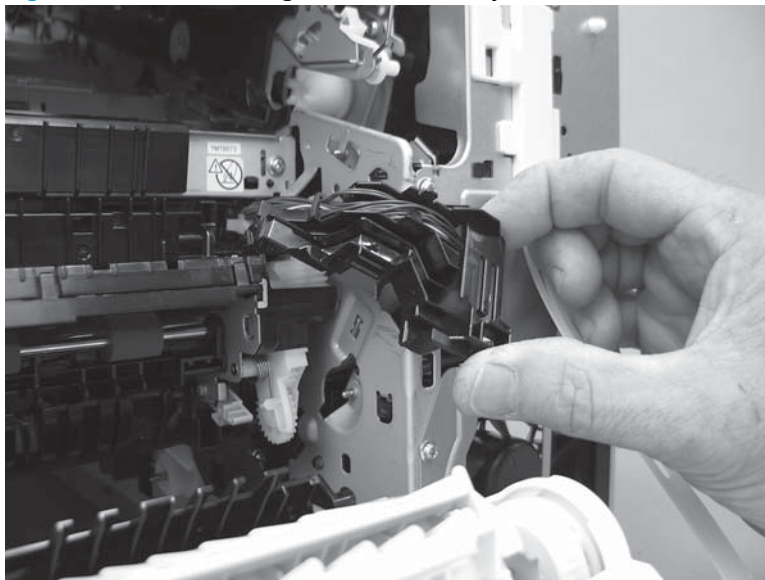

5. Remove three screws (callout 1).

Figure 1-4127 Remove three screws

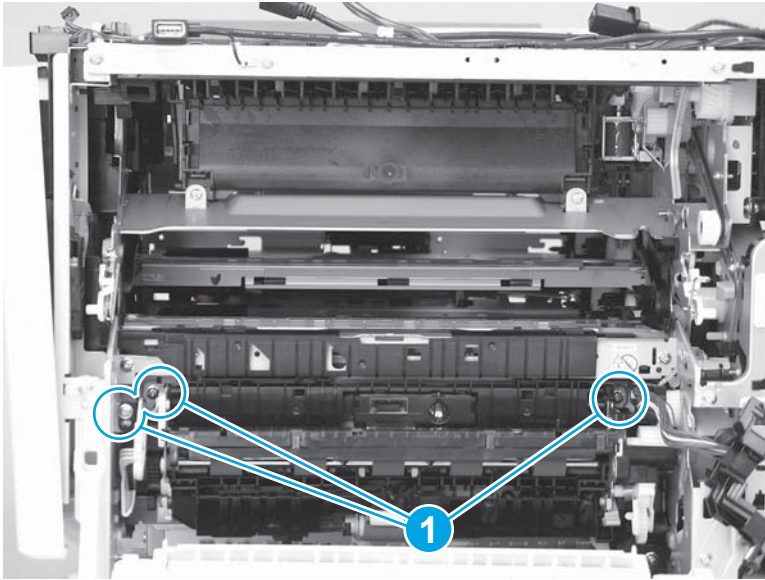

6. Before proceeding, locate the sheet metal portion (callout 1) of the assembly. When handling the assembly, use the sheet metal as handles.

Figure 1-4128 Locate the sheet metal portion of the assembly

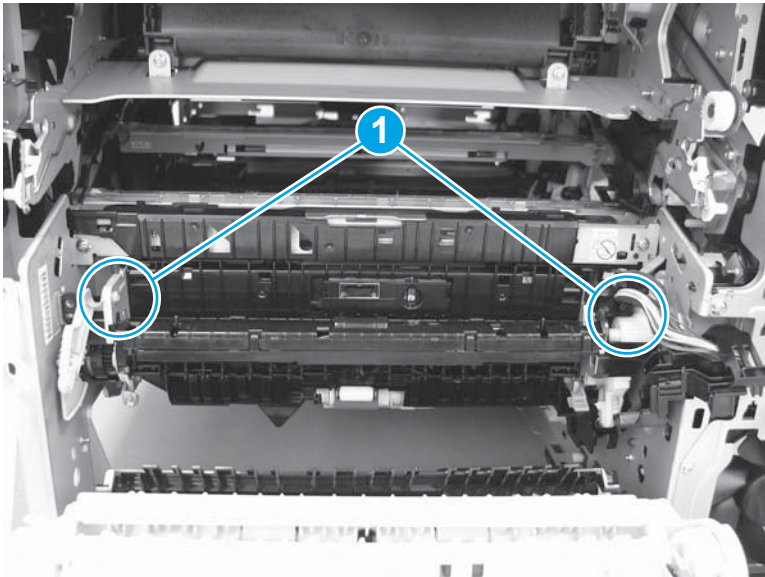

7. Before proceeding, take note of the sheet-metal tabs (callout 1) on the back of the assembly—the figure shows the assembly removed so the tabs can be viewed—that fasten it to the chassis.

Figure 1-4129 Take note of the sheet-metal tabs

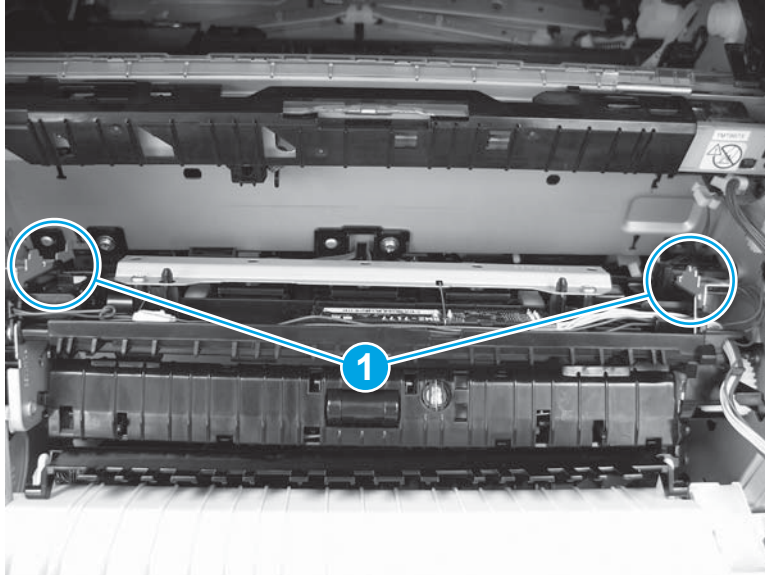

8. Grasp the sheet-metal handles (callout 1), and then rotate the top of the assembly away from the chassis (callout 2) to release the top tabs.

Figure 1-4130 Rotate the top of the assembly away from the chassis

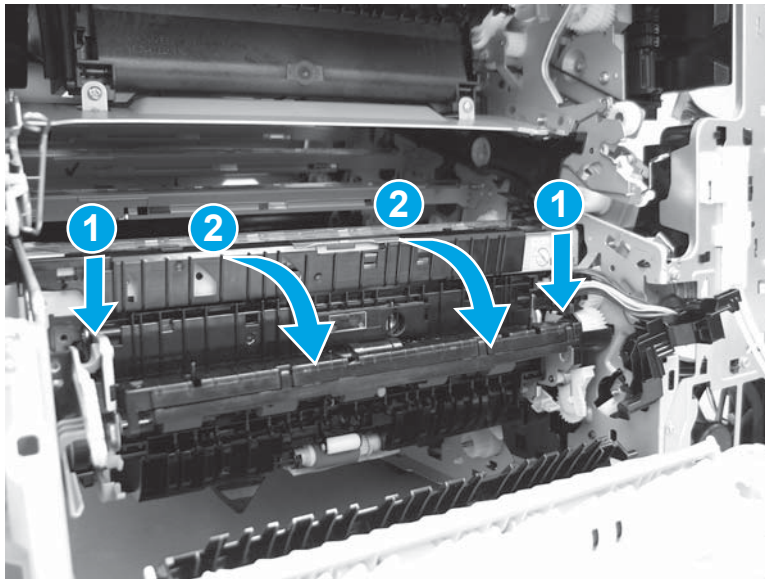

9. Pull up on the assembly to release the bottom tabs.

CAUTION: The assembly is still attached to the printer by a wire harness. Do not attempt to completely remove the assembly.

Figure 1-4131 Release the bottom tabs

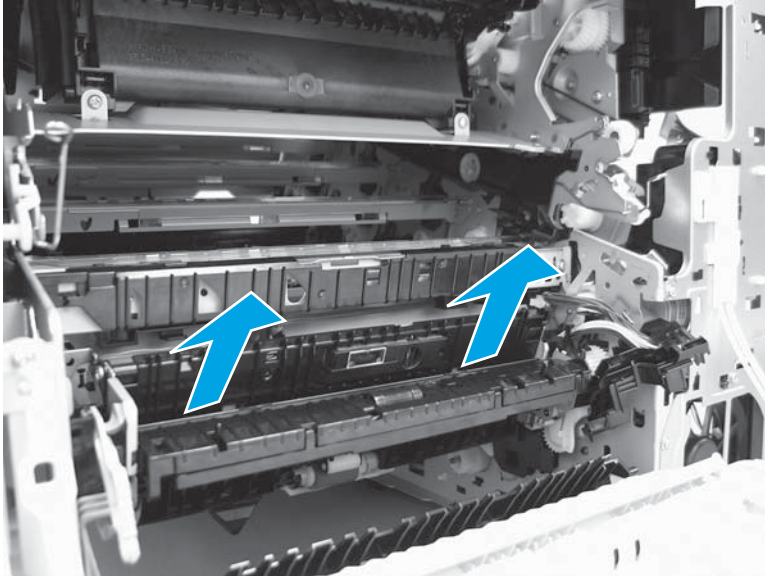

10. Turn the registration assembly over to access the back side, disconnect three connectors (callout 1), and then remove the assembly.

Figure 1-4132 Remove the assembly

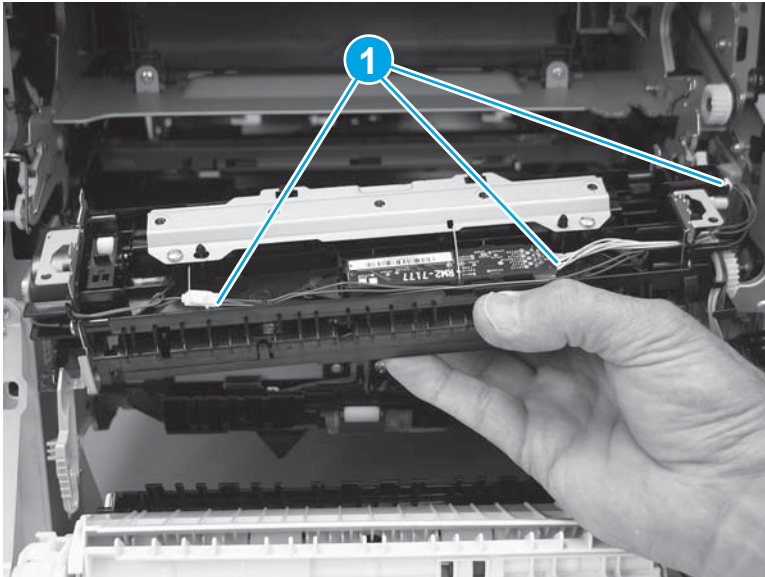

Step 31: Remove the paper pickup assembly

1. At the right side of the printer, remove four screws (callout 1).

Figure 1-4133 Remove three screws

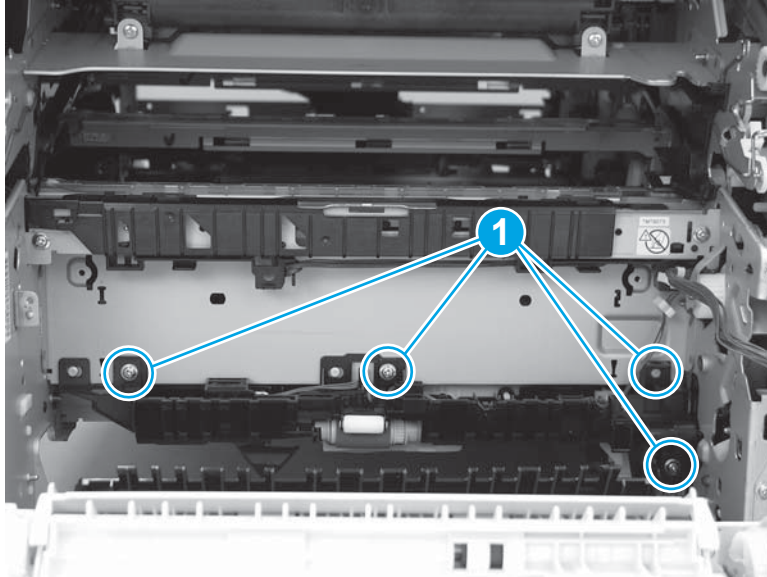

2. Slightly separate the left end of the assembly from the chassis to release it.

Figure 1-4134 Release the left end of the assembly

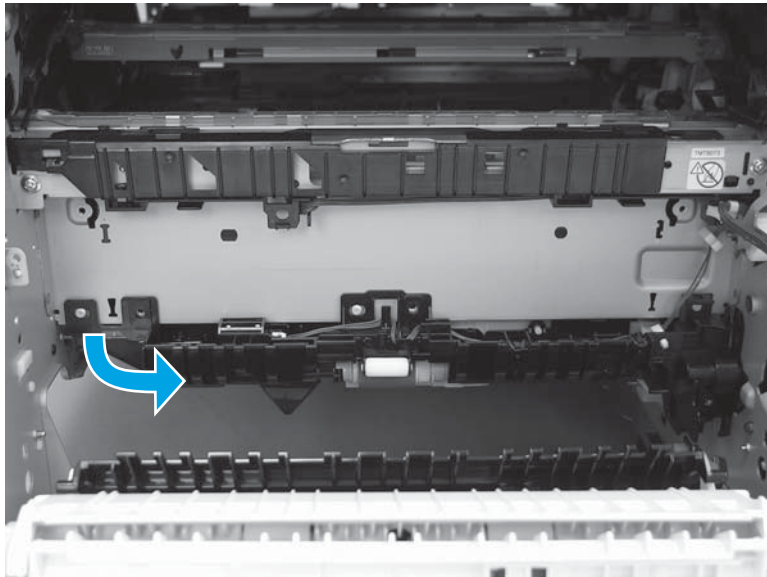

3. Slide the assembly to the left (callout 1), and then continue to rotate the left end of it out and away from the chassis (callout 2).

Figure 1-4135 Slide the assembly to the left

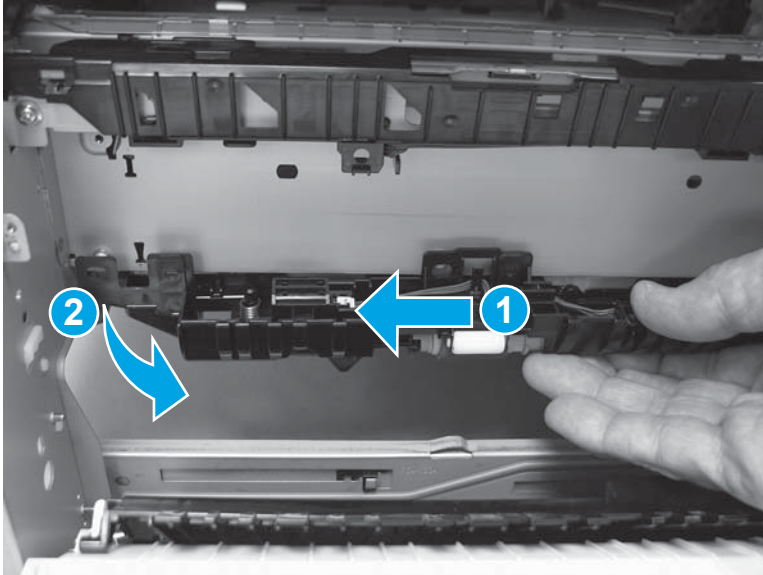

4. Remove the assembly.

CAUTION: The assembly is still attached to the printer by a wire harness. Do not attempt to completely remove the assembly.

Figure 1-4136 Remove the assembly

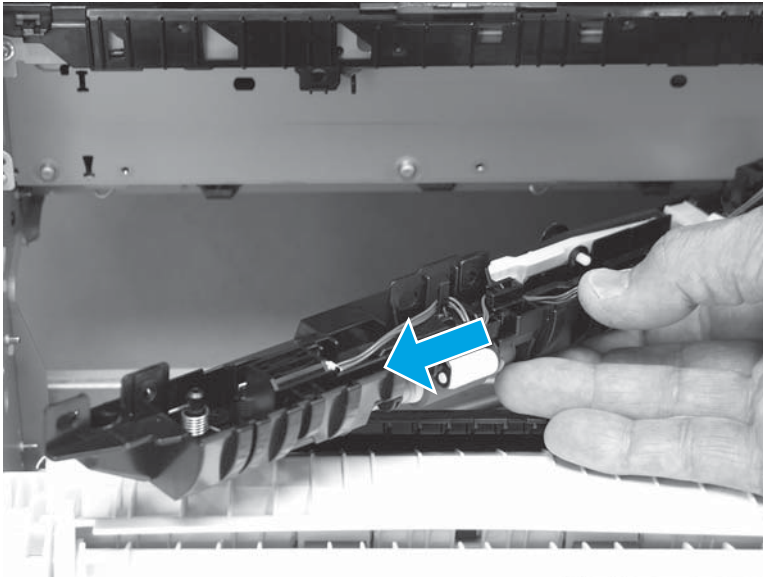

5. Turn the paper pickup assembly over to access the back side, release one connector (callout 1), release the wire harness from the guide (callout 2), and then release it from the retainer (callout 3).

Figure 1-4137 Disconnect one connector

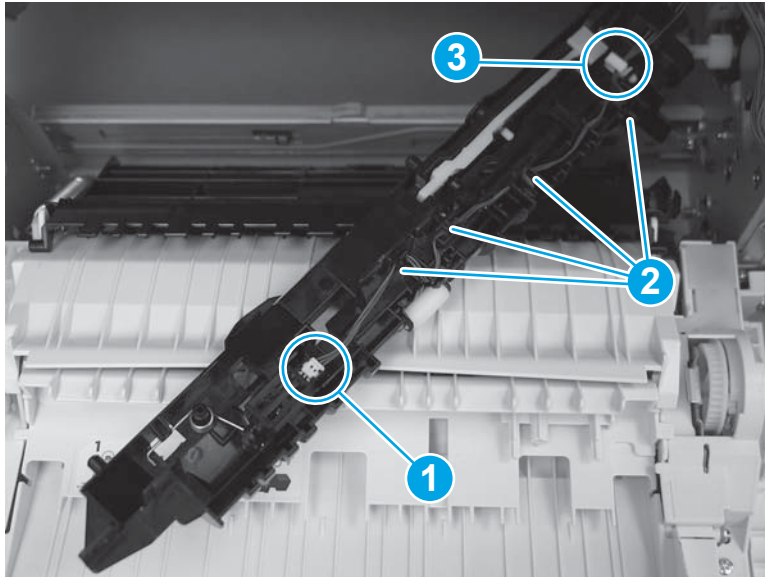

6. On the paper pickup assembly, slide the tray pickup roller assembly to the left to compress the spring loaded shaft (callout 1), and then rotate the right end of the roller assembly up and away from the pickup assembly (callout 2) to remove it.

Figure 1-4138 Remove the tray pickup roller assembly

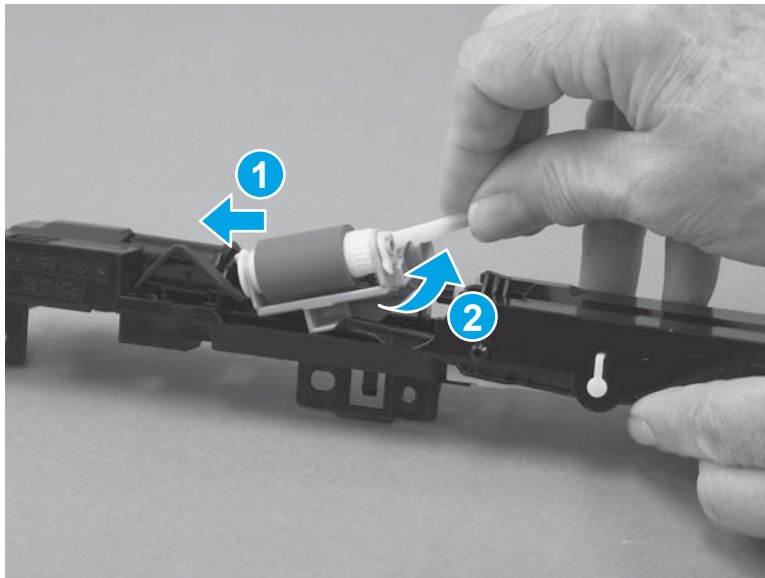

7. Locate the feed bushing (callout 1).

Figure 1-4139 Locate the feed bushing

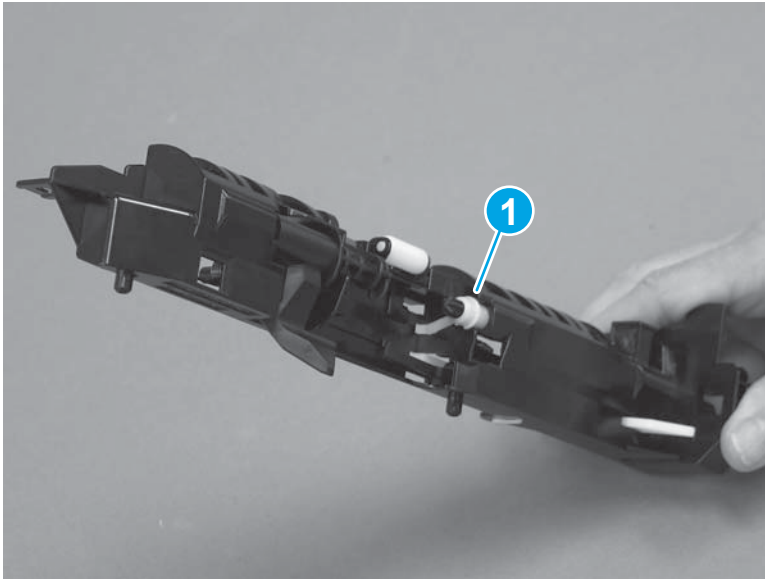

8. Use a small, flat-blade screwdriver to release one tab on the bushing (callout 1), and then rotate the bushing clockwise (callout 2).

Figure 1-4140 Release one tab and rotate the bushing

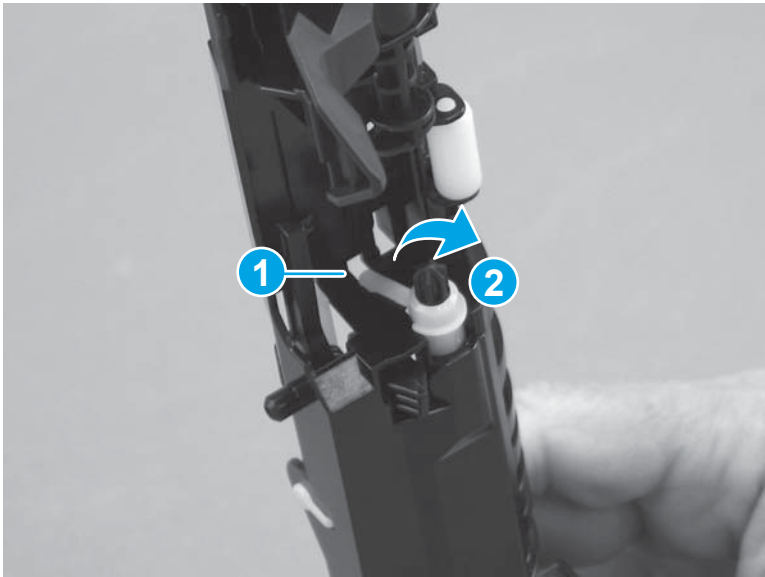

9. Lift the bushing (callout 1) off of the shaft.

Figure 1-4141 Remove the bushing

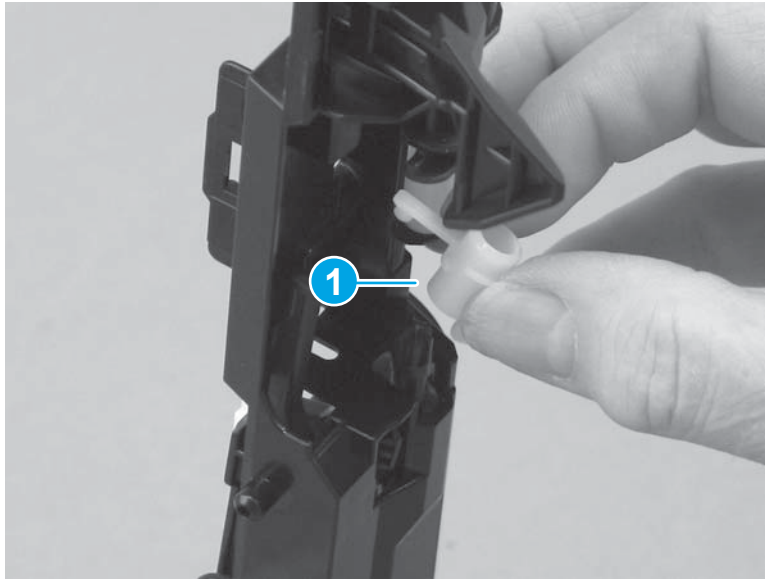

10. At the end of the paper pickup assembly, slide the shaft with the gear on the end (callout 1) slightly out of the assembly.



 **NOTE:** Try not to remove the grease from the gear when handling the shaft and gear.

Figure 1-4142 Slide the shaft out

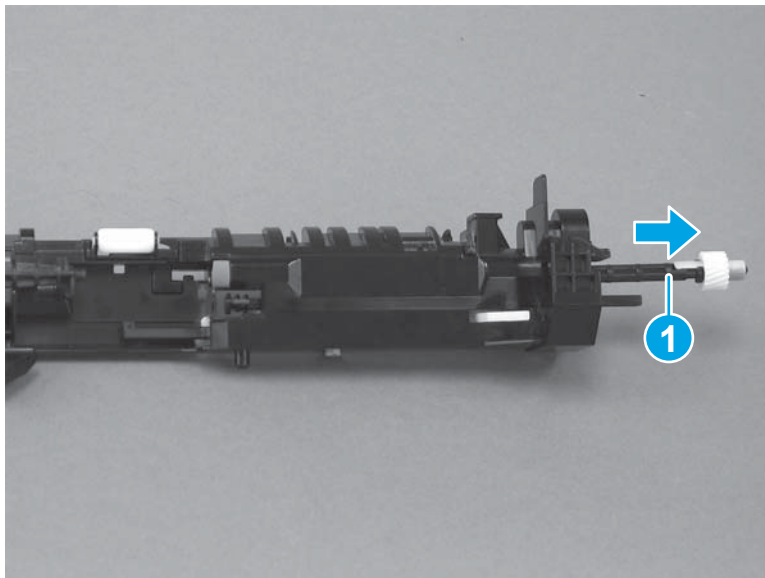

11. Release one tab (callout 1), and then slide the gear (callout 2) off of the shaft.

 **NOTE:** Try not to remove the grease from the gear when handling it.

 **TIP:** Set the gear aside for installation on the replacement paper pickup assembly.

Figure 1-4143 Remove the gear



Step 32: Unpack the replacement assembly

Unpack the replacement assembly from the packaging.

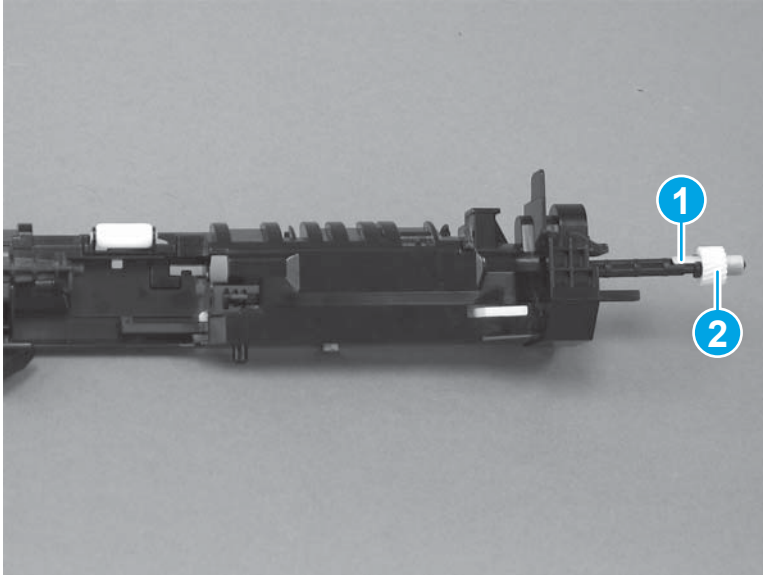
For complete information on HP's recycling programs, go to [Product return and recycling](#).

 **NOTE:** HP recommends responsible disposal of the defective assembly.

Figure 1-4144 Recycle and unpack



Step 33: Install the paper pickup assembly

1. On the replacement paper pickup assembly, slide the tray pickup roller assembly to the left to compress the spring loaded shaft (callout 1), and then rotate the right end of the roller assembly up and away from the pickup assembly (callout 2) to remove it.

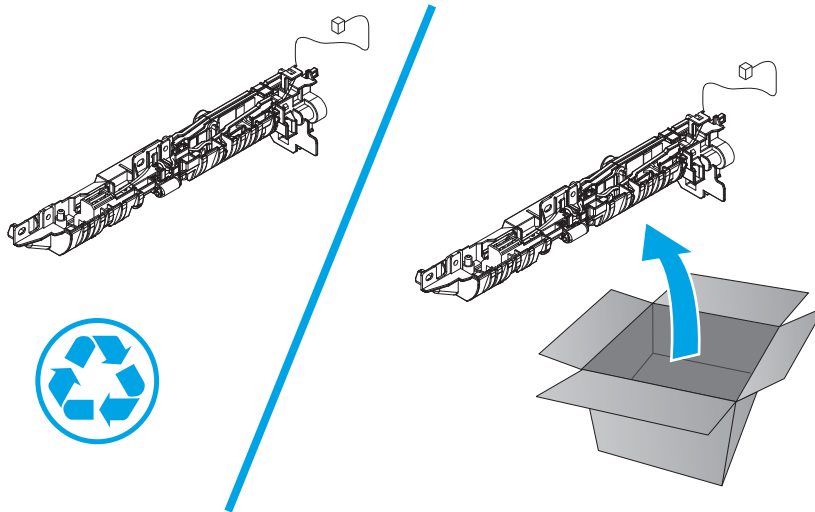
Figure 1-4145 Remove the tray pickup roller assembly

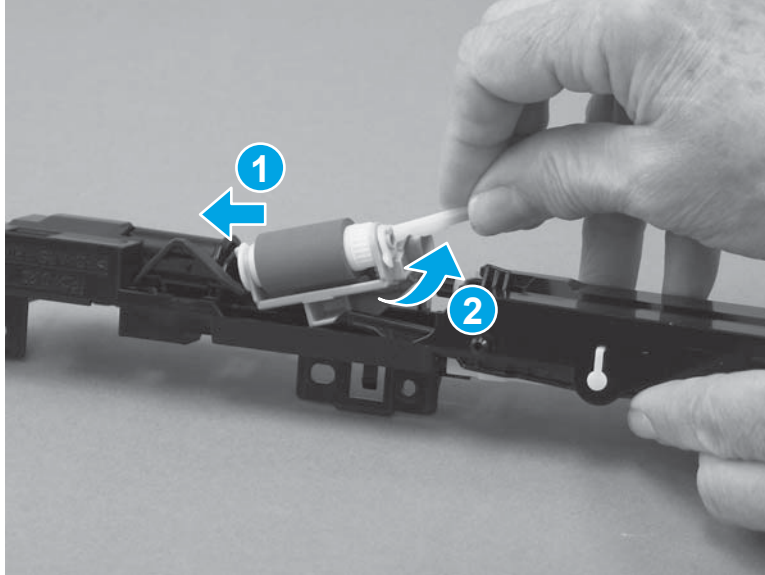

2. Locate the feed bushing (callout 1).

Figure 1-4146 Locate the feed bushing

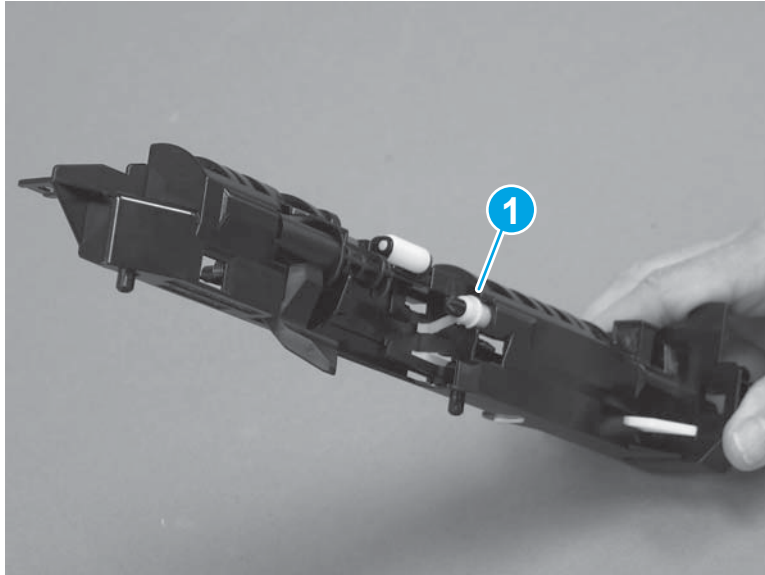

3. Use a small, flat-blade screwdriver to release one tab on the bushing (callout 1), and then rotate the bushing clockwise (callout 2).

Figure 1-4147 Release one tab and rotate the bushing

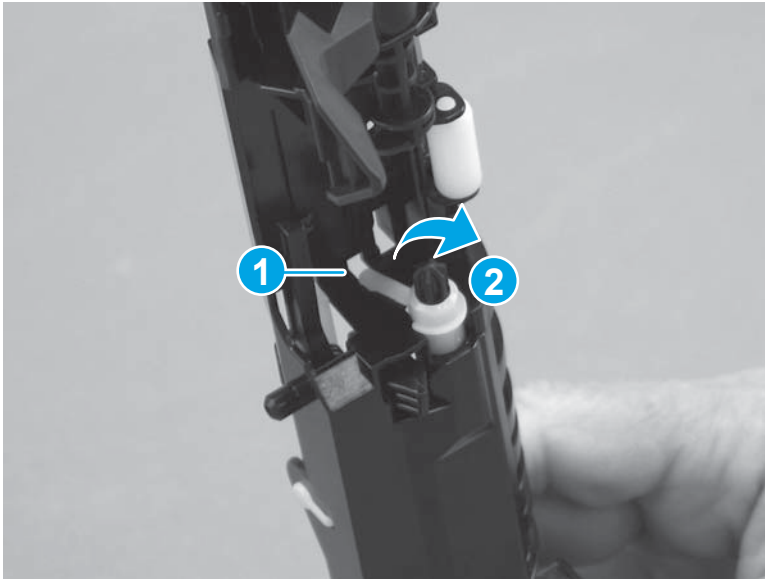

4. Lift the bushing (callout 1) off of the shaft.

Figure 1-4148 Remove the bushing

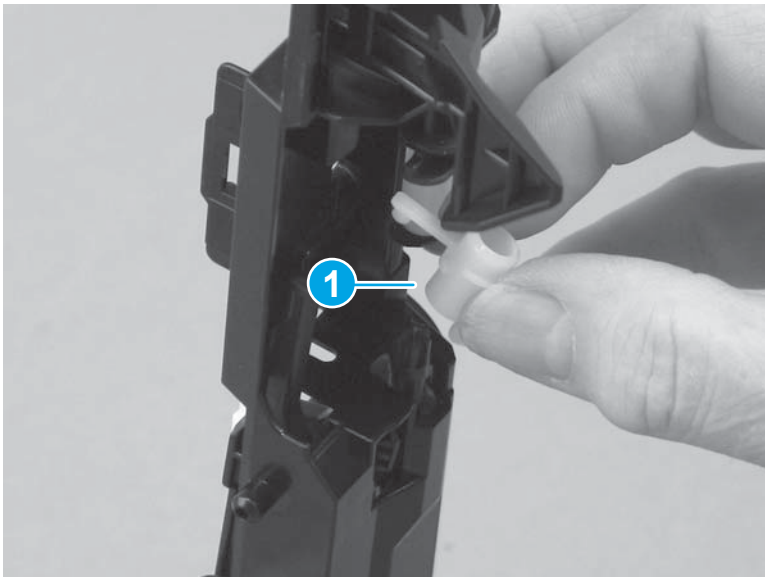

5. At the end of the paper pickup assembly, slide the shaft (callout 1) slightly out of the assembly.

Figure 1-4149 Slide the shaft out

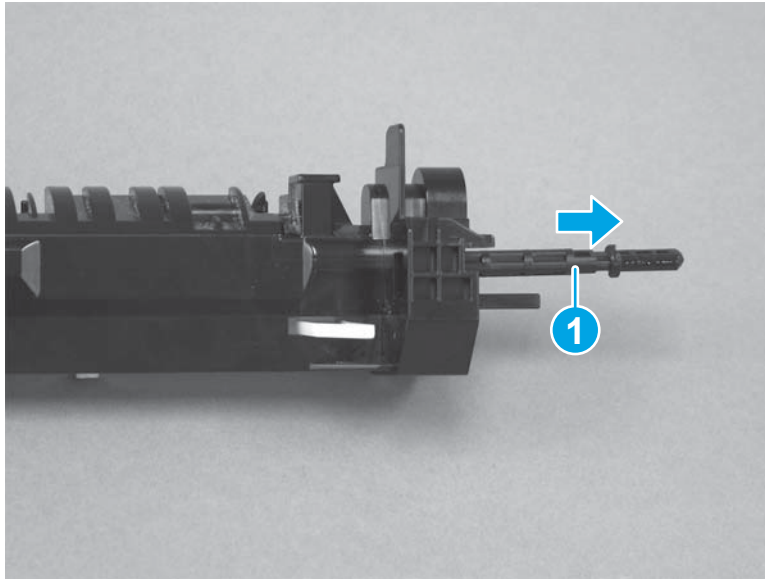

6. Position the gear (callout 1) removed from the discarded paper pickup assembly on the shaft (callout 2) of the replacement pickup assembly.

 **NOTE:** The hole in the center of the gear is keyed to match the end of the shaft.

 **NOTE:** Try not to remove the grease from the gear when handling it.

Figure 1-4150 Position the gear

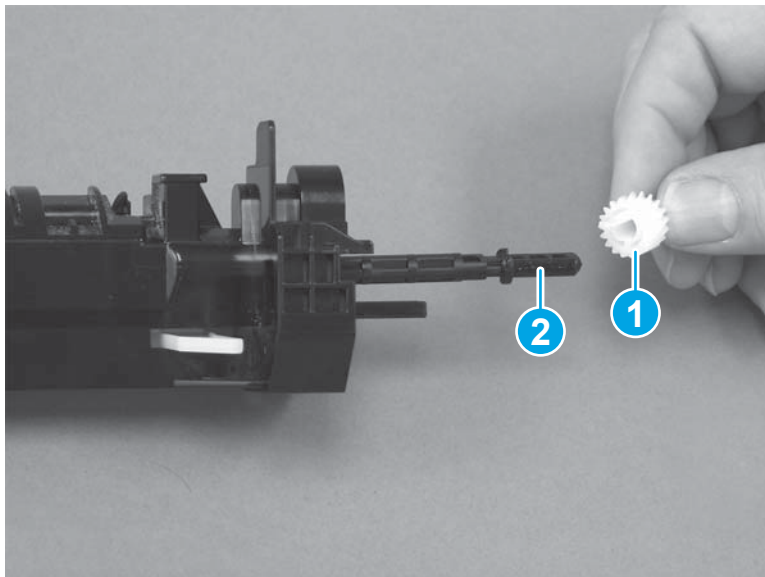

7. Slide the gear (callout 1) onto the shaft. Make sure that the tab (callout 2) snaps into place.

Figure 1-4151 Install the gear

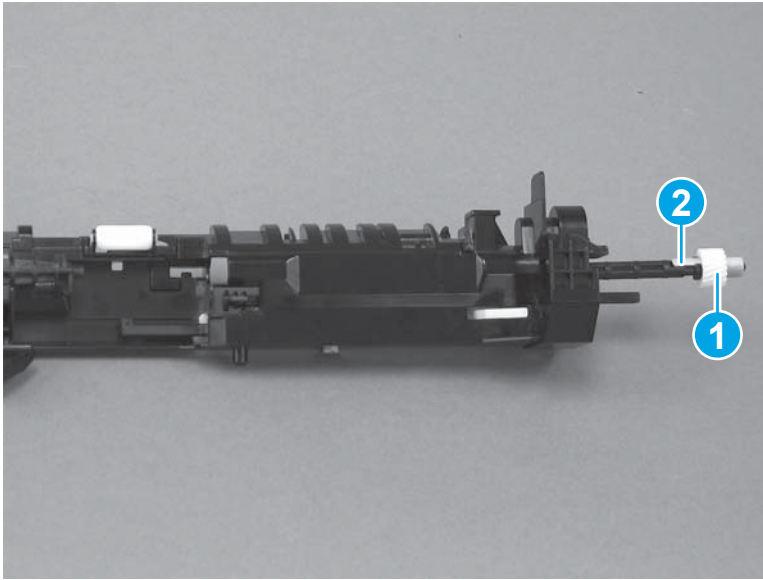

8. Slide the shaft into the paper pickup assembly.

Figure 1-4152 Install the shaft

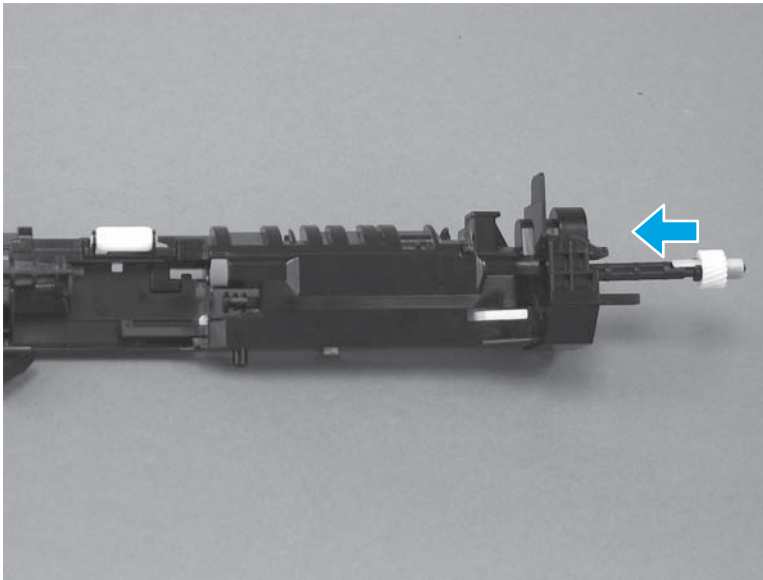

9. Make sure that the ridge on the shaft (callout 1) fits into the slot (callout 2) in the paper pickup assembly.

 **TIP:** Hold the shaft in place with one finger while installing the feed bushing in the next step.

Figure 1-4153 Check shaft alignment



10. Position the feed bushing (callout 1) over the end of the shaft (callout 2). Align the ridge (callout 3) on the bushing with the opening (callout 4) in the paper pickup assembly.

Figure 1-4154 Position the feed bushing

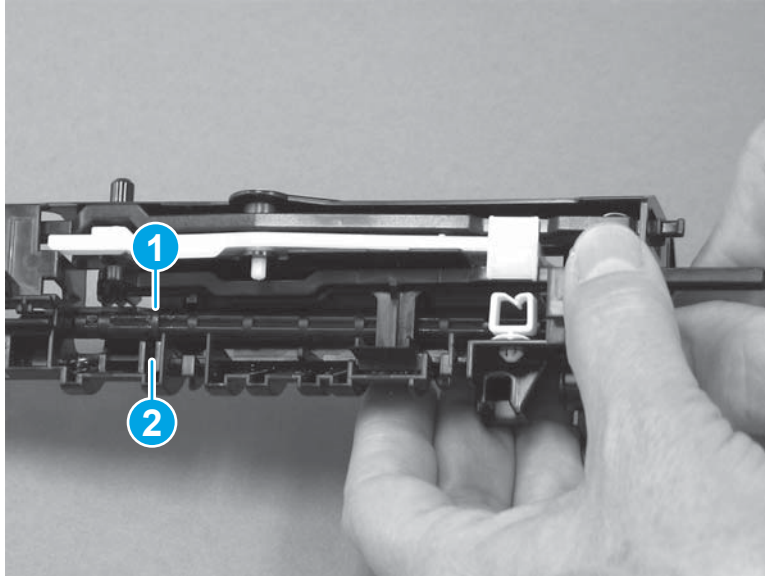
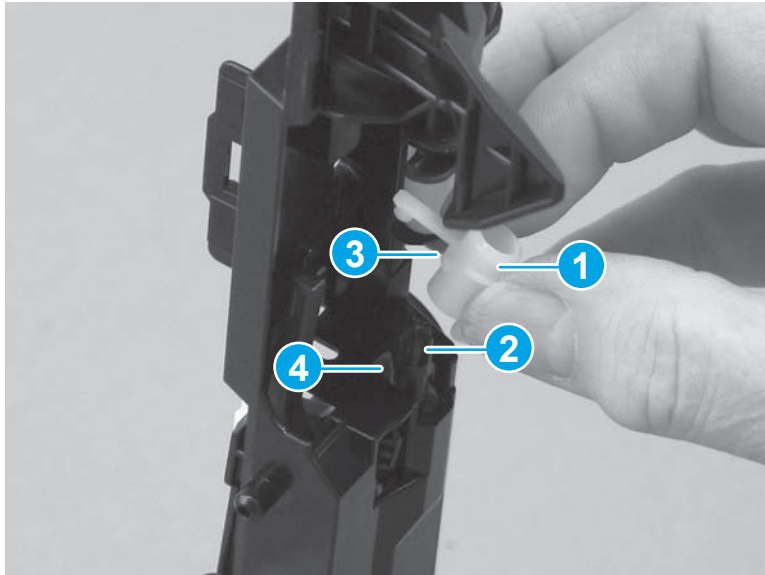

11. Press down on the bushing (callout 1) while rotating it counterclockwise (callout 2) until the tab (callout 3) fits into the slot (callout 4).

Figure 1-4155 Install the feed bushing

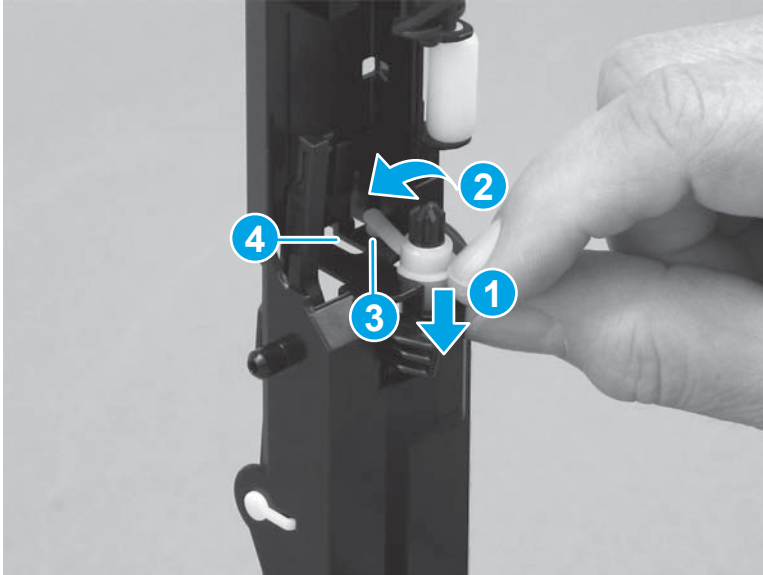

12. Before proceeding, check to make sure that the ridge on the shaft is still positioned in the slot in the pickup assembly (callout 1). If the shaft is not positioned correctly, remove the feed bushing and reinstall the shaft in the correct position.

Figure 1-4156 Check shaft alignment

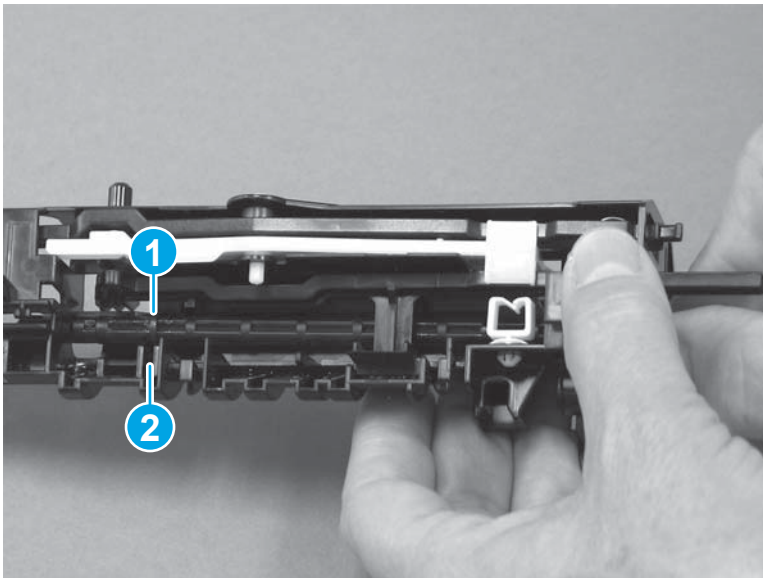

13. Position the roller assembly in the paper pickup assembly so that the hole (callout 1) in the roller assembly fits over the shaft (callout 2) on the pickup assembly and the tab (callout 3) on the roller assembly fits over the hook (callout 4) in the pickup assembly.

Figure 1-4157 Position the roller assembly

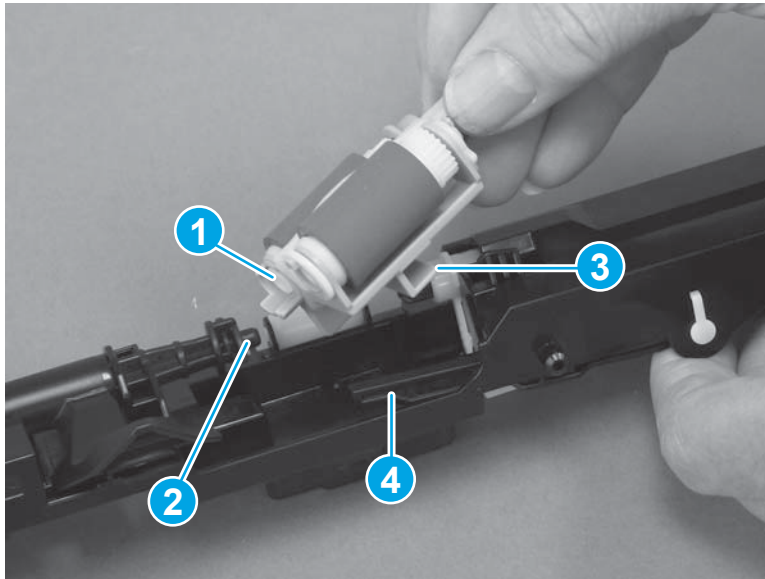

14. Slide the roller assembly to the left (callout 1) to compress the spring-loaded shaft. Rotate the roller assembly toward the pickup assembly (callout 2), making sure that the collar on the roller (callout 3) fits over the shaft on the pickup assembly (callout 4).

Figure 1-4158 Install the roller assembly

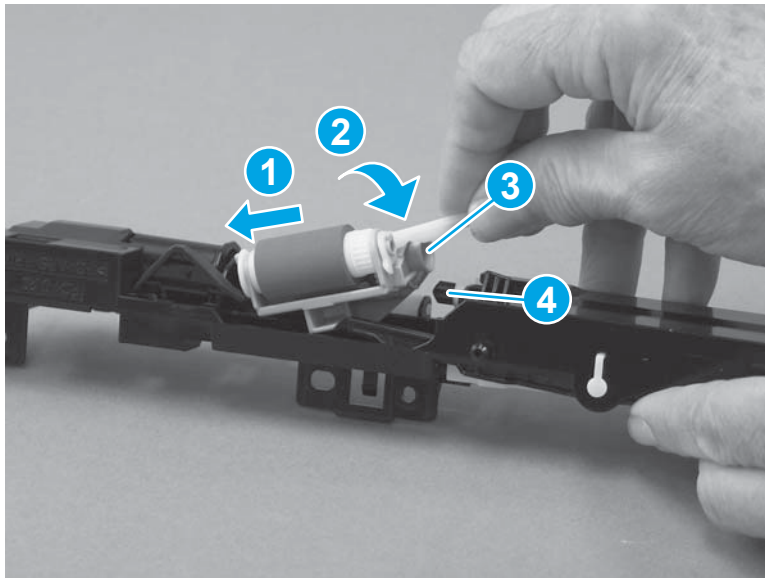

15. Carefully release the spring-loaded shaft with the roller assembly in place.

Figure 1-4159 Release the spring loaded shaft

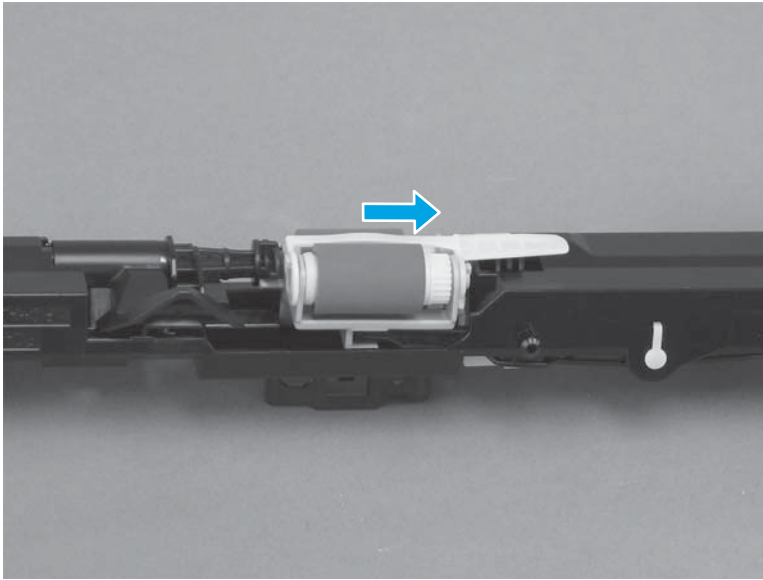

16. When the paper pickup assembly is installed, the right end must be correctly engaged with the drive gear (callout 1) or the assembly will not be able to be correctly installed.

Figure 1-4160 Remove three screws

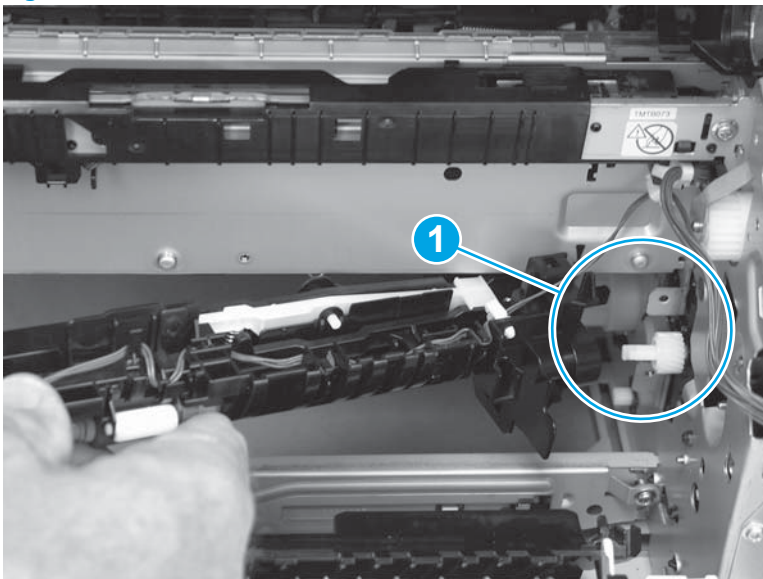

17. Turn the paper pickup assembly over to access the back side, connect one connector (callout 1), position the wire harness in the guide (callout 2), and then secure it in the retainer (callout 3).

Figure 1-4161 Connect one connector

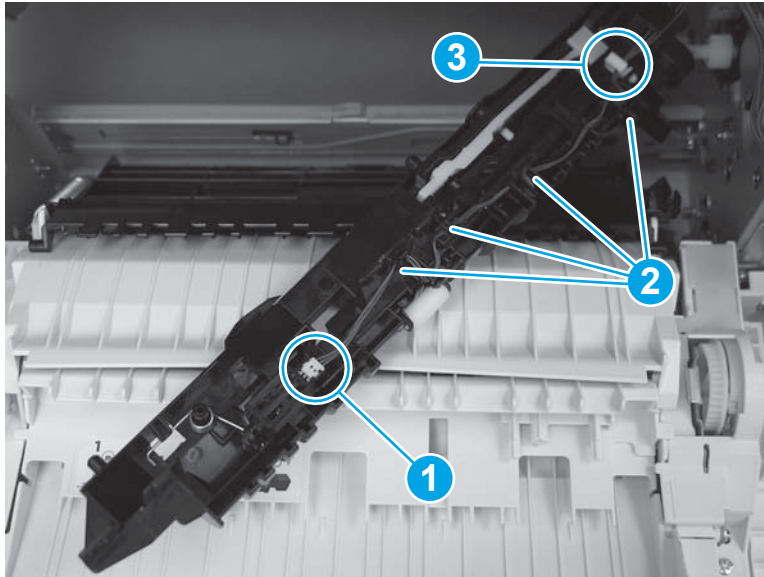

18. Position the right end of the assembly in the printer at a slight angle and engaged with the drive gear.

 **NOTE:** The right end of the assembly must be correctly engaged with the drive gear or the assembly will not be able to be correctly installed.

Figure 1-4162 Position the assembly in the product



19. Slide the assembly to the right (callout 1), and then to rotate the left end of it toward the chassis (callout 2).

Figure 1-4163 Slide the assembly to the right

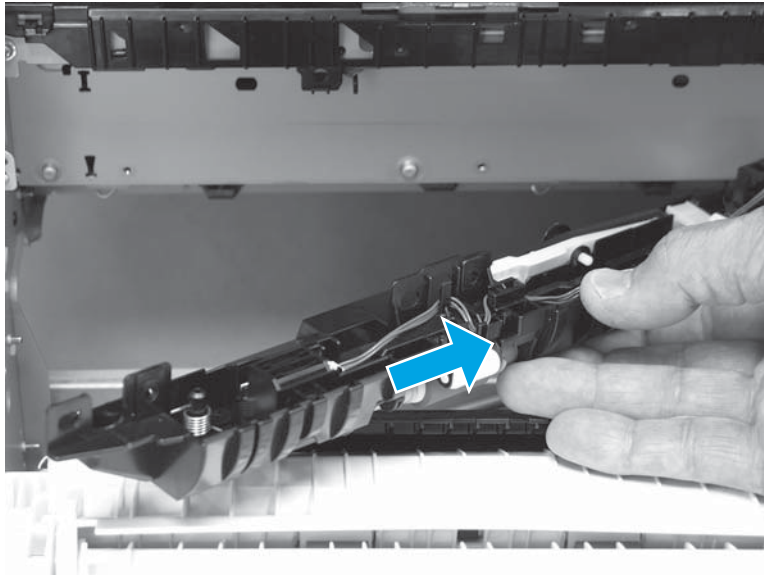
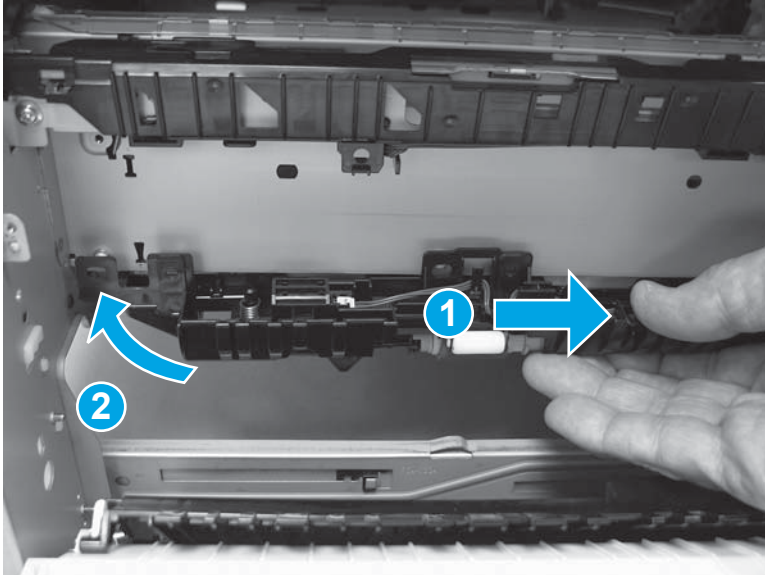

20. Continue to rotate the left end of the assembly toward the chassis to install it.

Figure 1-4164 Install the assembly

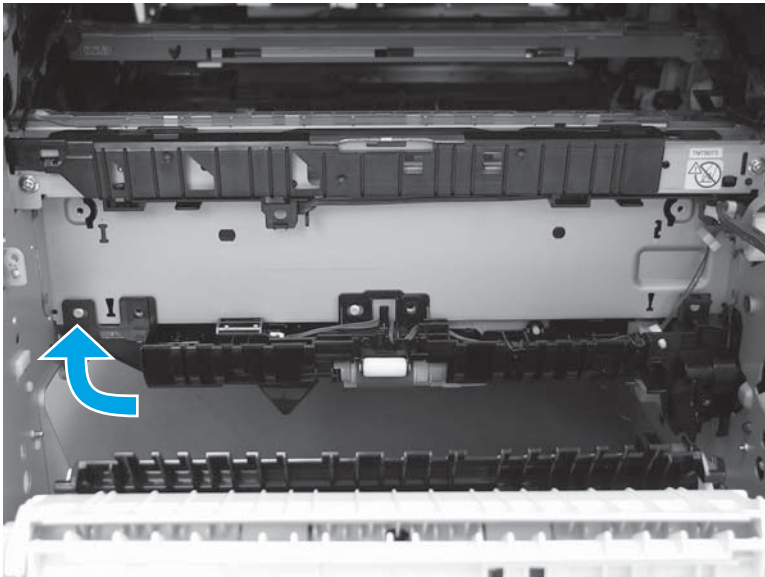

21. Install four screws (callout 1).

Figure 1-4165 Install three screws

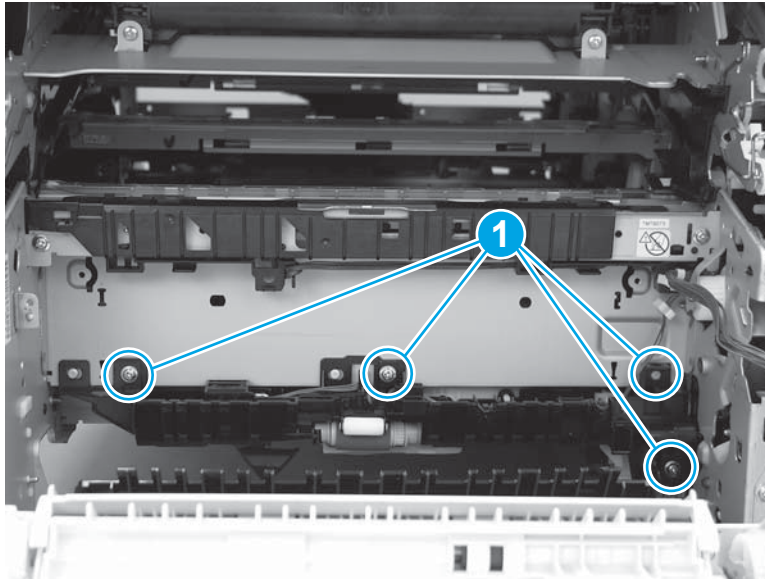

Step 34: Install the registration assembly

1. Turn the registration assembly over to access the back side, and then connect three connectors (callout 1).

Figure 1-4166 Connect three connectors

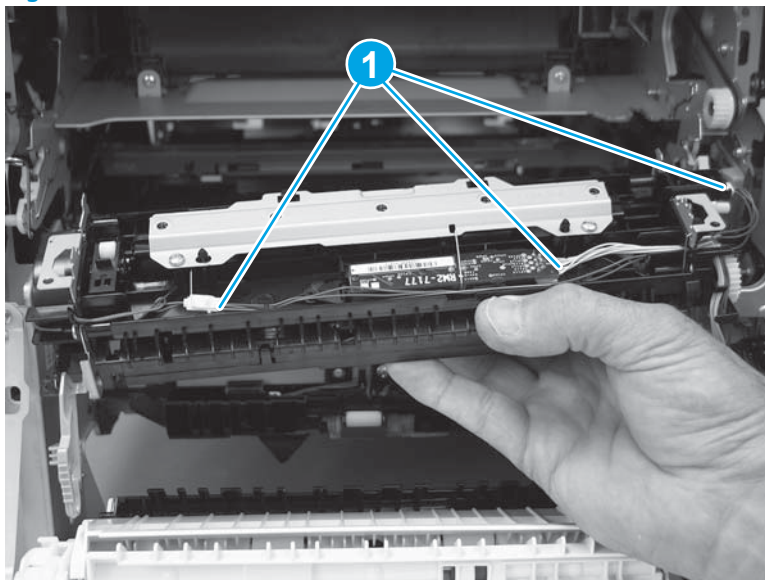

2. Align the tabs on the assembly with the slots in the chassis.

Figure 1-4167 Align the tabs on the assembly with the slots

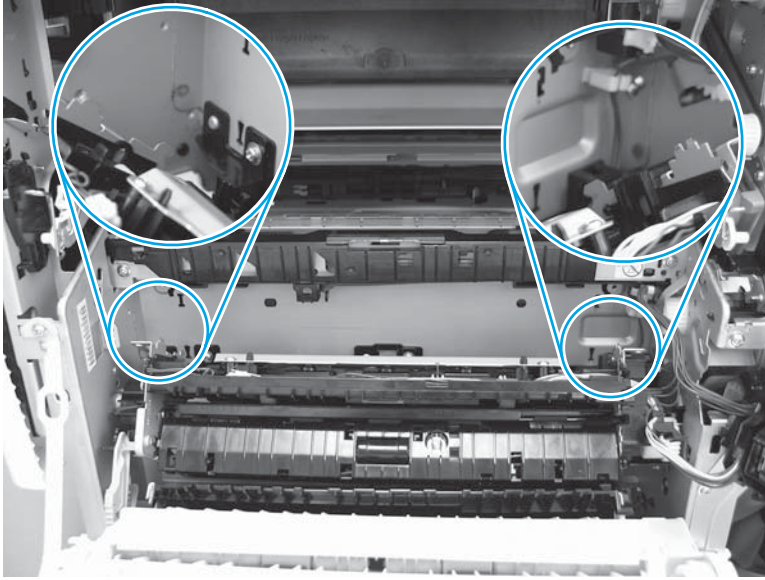

3. Position the bottom tabs in the appropriate slots, and then push down on the assembly to engage them.

Figure 1-4168 Install the bottom tabs

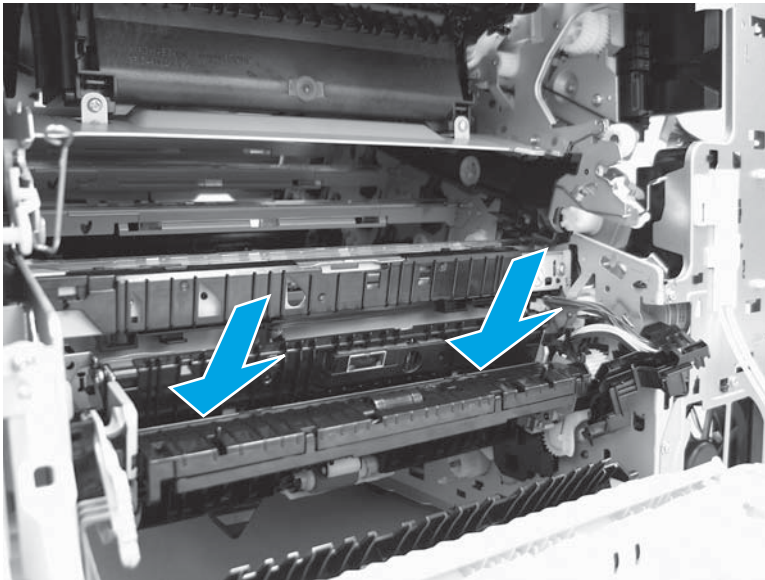

4. Grasp the sheet-metal handles (callout 1) to rotate the top of the assembly toward the chassis (callout 2) to install the top tabs.

Figure 1-4169 Install the top tabs

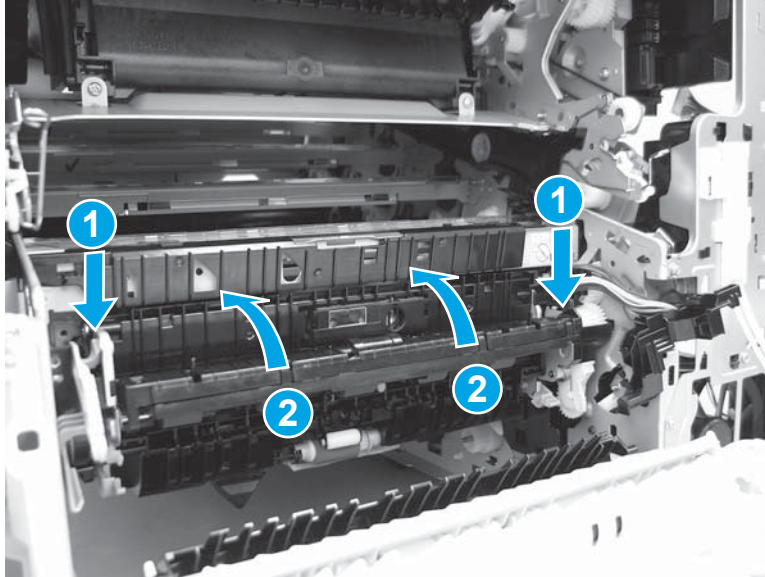

5. Install three screws (callout 1).

Figure 1-4170 Install three screws

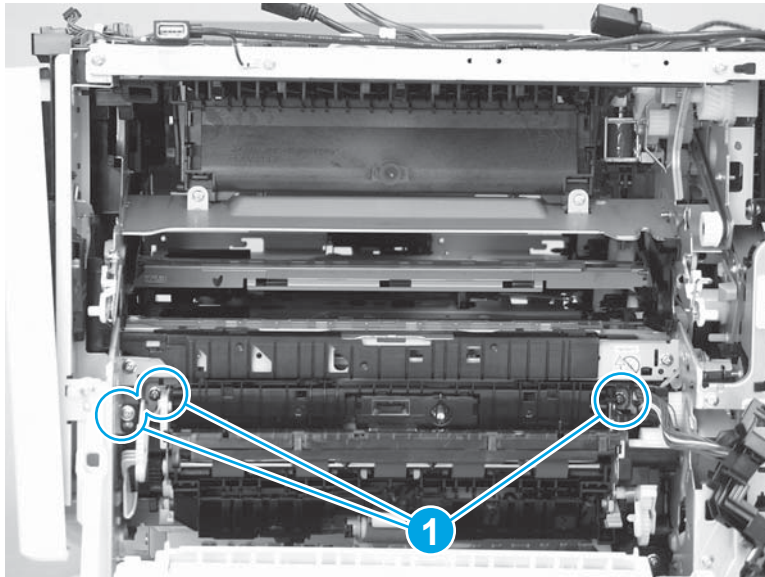

6. Position the guide on the chassis.

Figure 1-4171 Position the guide on the product

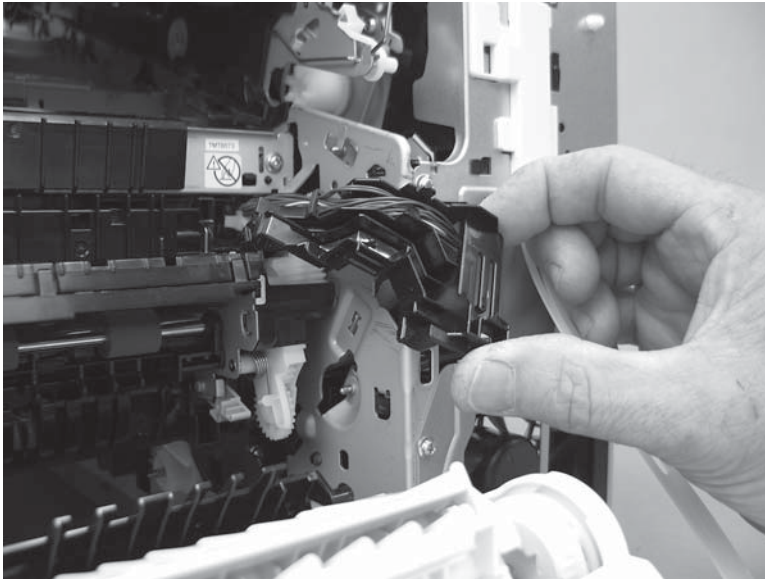

7. Slide the guide up to install it (callout 1), and then make sure that the tab (callout 2) snaps into place.

Figure 1-4172 Install the guide

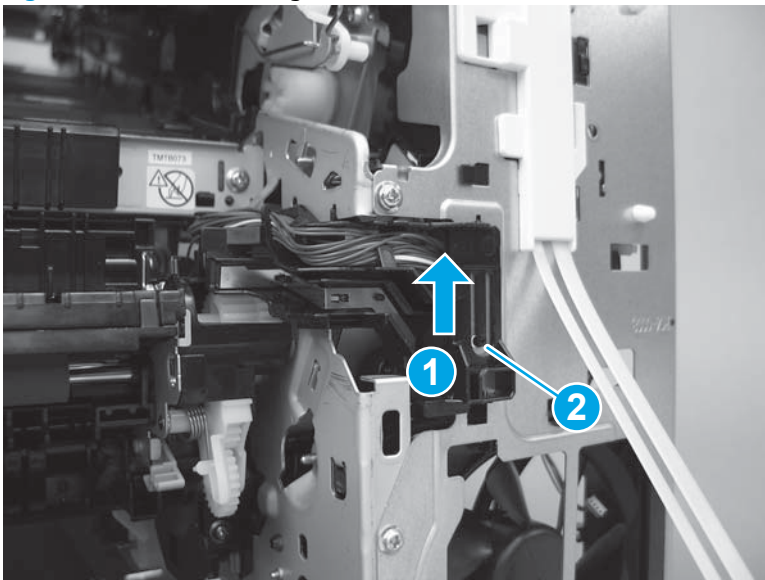

8. Position the cover on the printer.

Figure 1-4173 Position the cover on the product

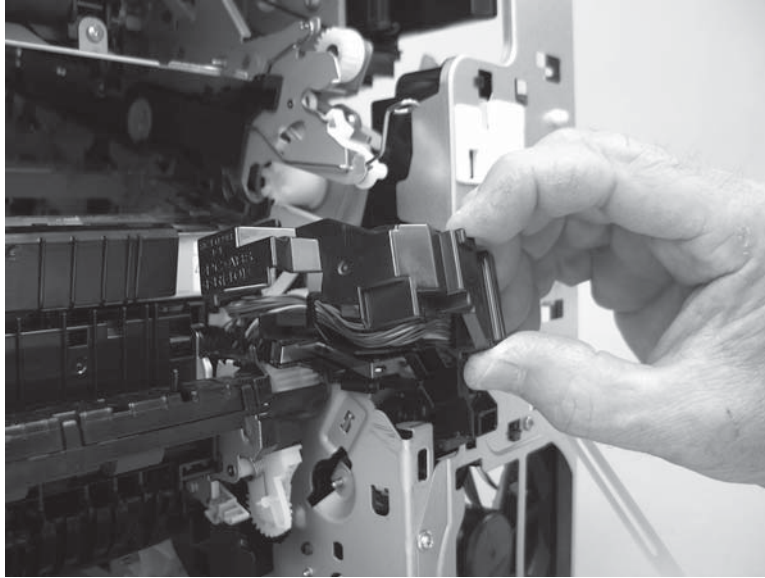

9. Install the cover, and then make sure that the tab (callout 1) snaps into place.

Figure 1-4174 Install the cover

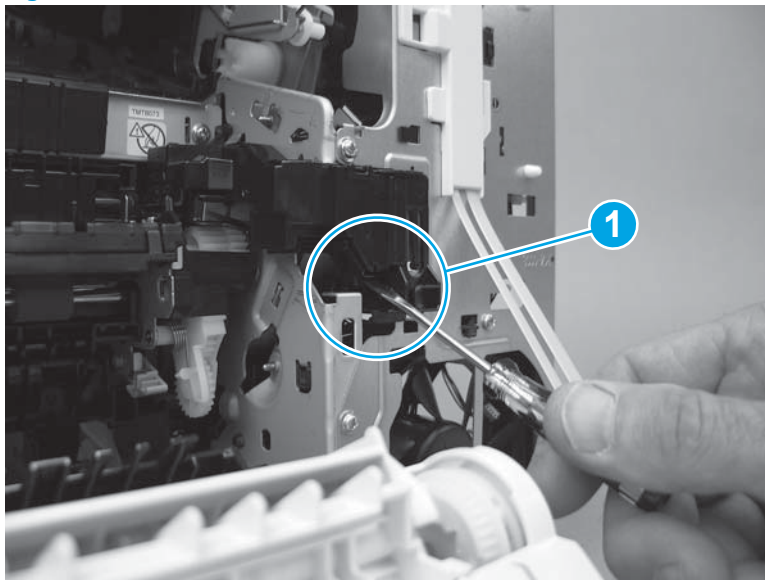

Step 35: Install the pickup drive assembly and motor (M5)

1. Before installing the assembly, check to see if a gap exists (callout 1) between the gears.

 **NOTE:** If no gap exists, go to step 3 in this section.

Figure 1-4175 Check the gears for a gap



2. Adjust the gears on the assembly to remove the gap (callout 1).

Figure 1-4176 Adjust the gears

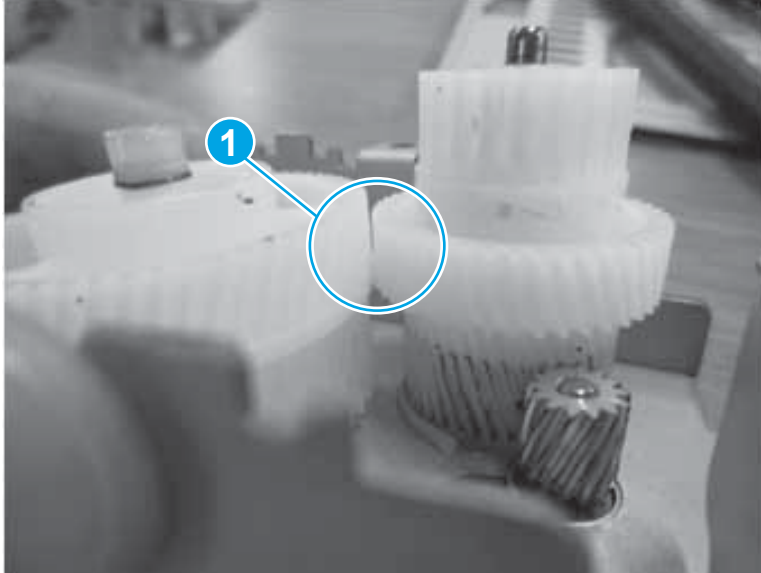
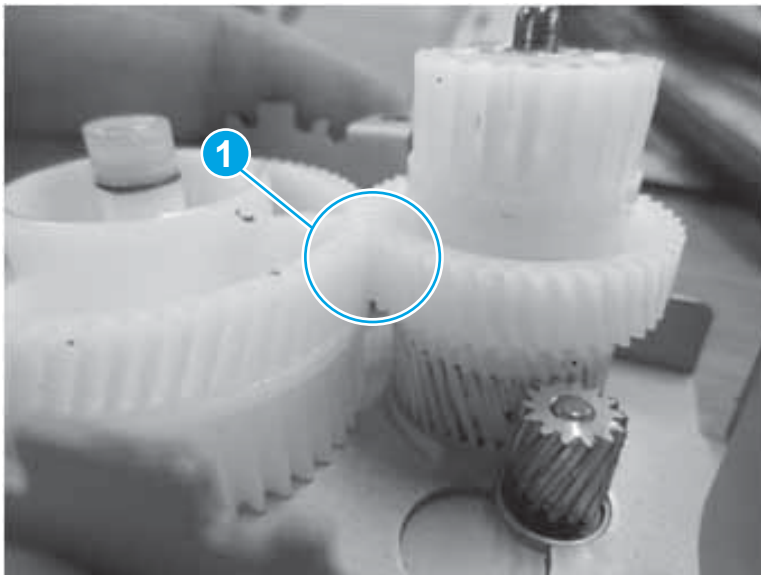

3. Align the tabs on the pickup drive assembly with the slots in the chassis, and then install the assembly on the printer.

 **IMPORTANT:** The figure below shows the large gear of the assembly already installed on the printer chassis. However it is easier to install the pickup drive assembly if the gear is installed on the assembly.

 **TIP:** With the right door open, look into the printer and verify that the mounting bracket for the assembly is correctly installed against the chassis.

Figure 1-4177 Install the assembly



4. Install three screws (callout 1).

Figure 1-4178 Install three screws

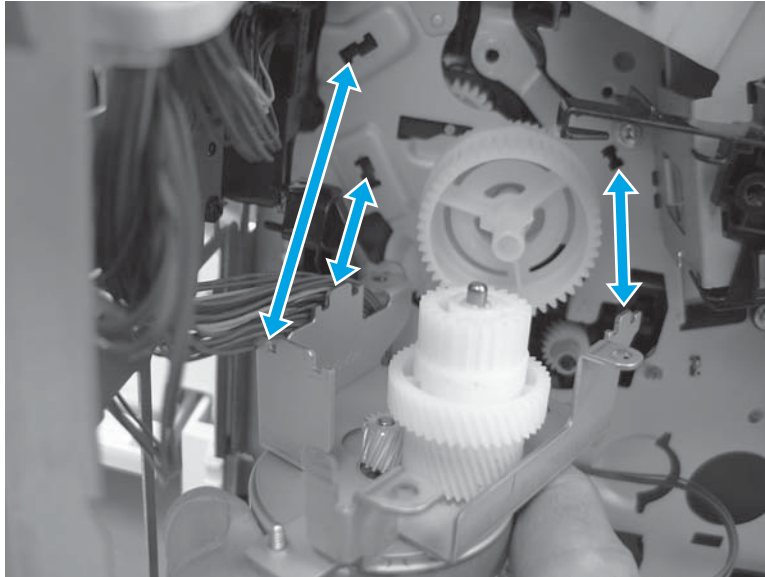
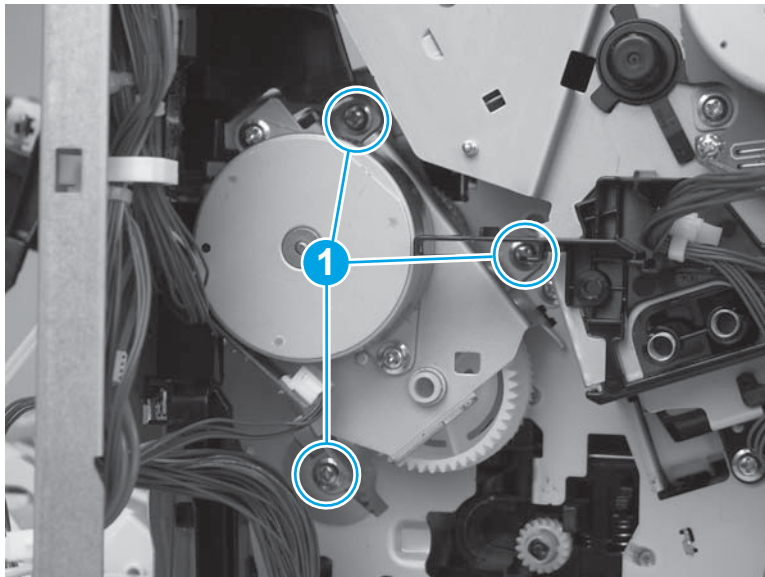

5. Install the guide (callout 1). Make sure that the tab (callout 2) snaps into place.

Figure 1-4179 Install the guide

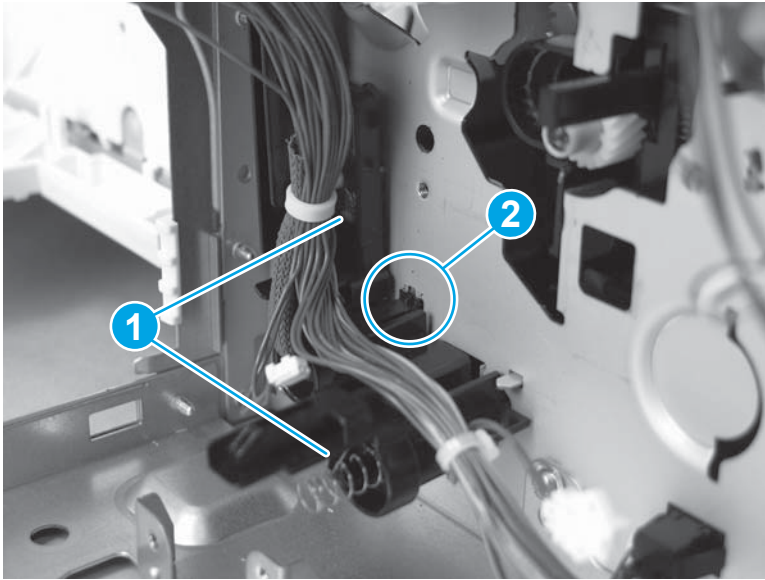

Step 36: Install the DC controller and sheet-metal bracket

 **CAUTION:**  ESD-sensitive part.

1. Position the DC controller and sheet-metal plate on the printer, and then push down to engage the plate with the chassis.

Figure 1-4180 Install the plate

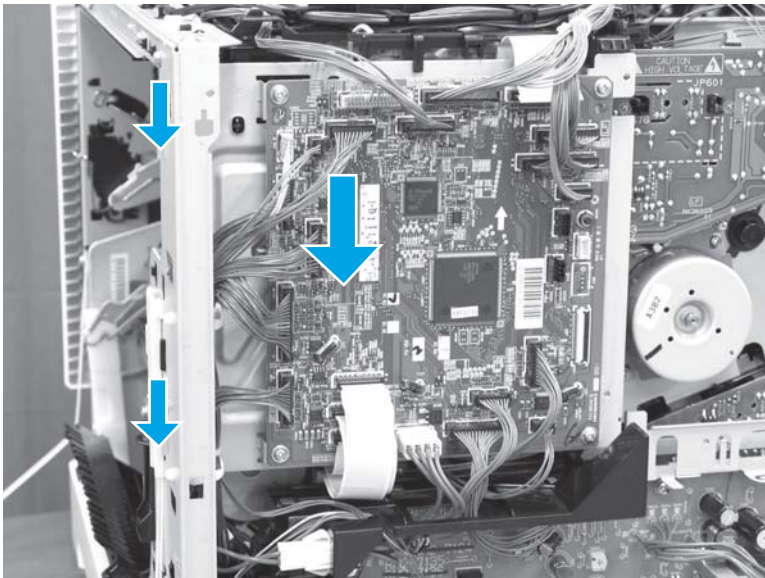

2. Install two screws (callout 1), and then connect all of the connectors.

The following connectors are empty:

- J140, J141, and J143

Figure 1-4181 Install two screws

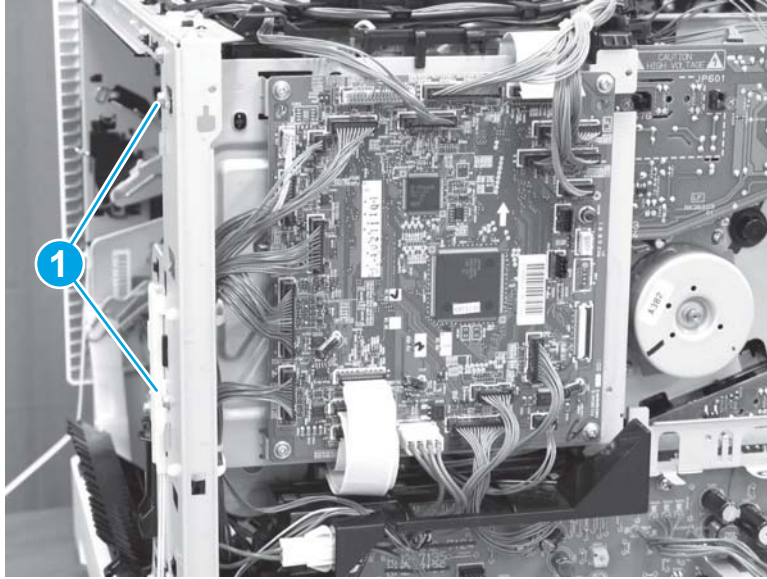

Step 37: Install the lifter drive assembly

1. Install one wire harness on the retainer (callout 1), position the lifter drive assembly in the printer (make sure that one tab (callout 2) snaps into place), and then install two screws (callout 3).

 **TIP:** It might be easier to install the assembly if the bottom of the assembly is installed first, and then the top of the assembly is rotated into place.

Figure 1-4182 Install the lifter drive



2. Connect two flat cables (callout 1), and then place them in the retainers (callout 2).

Figure 1-4183 Connect two flat cables

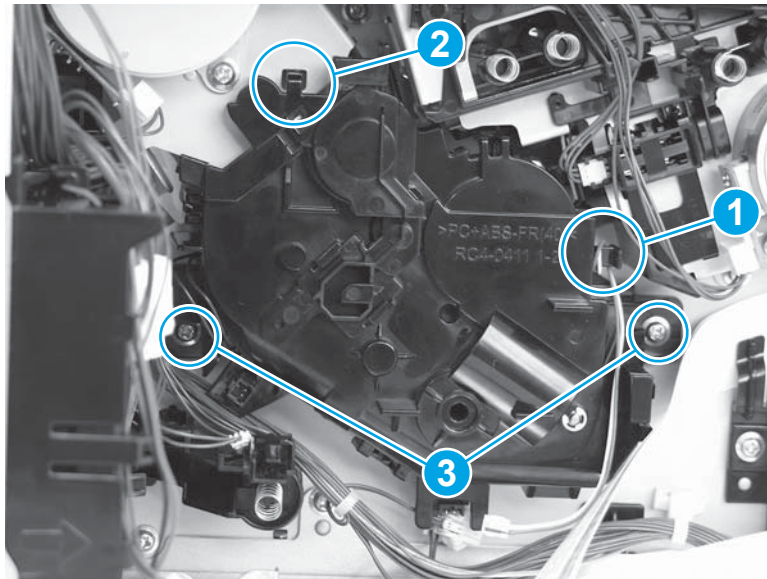
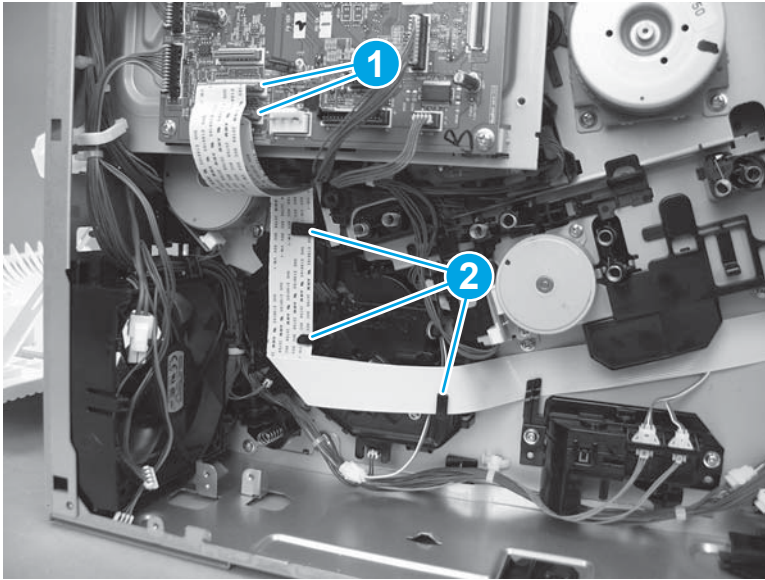

3. Connect two connectors (callout 1).

Figure 1-4184 Connect two connectors

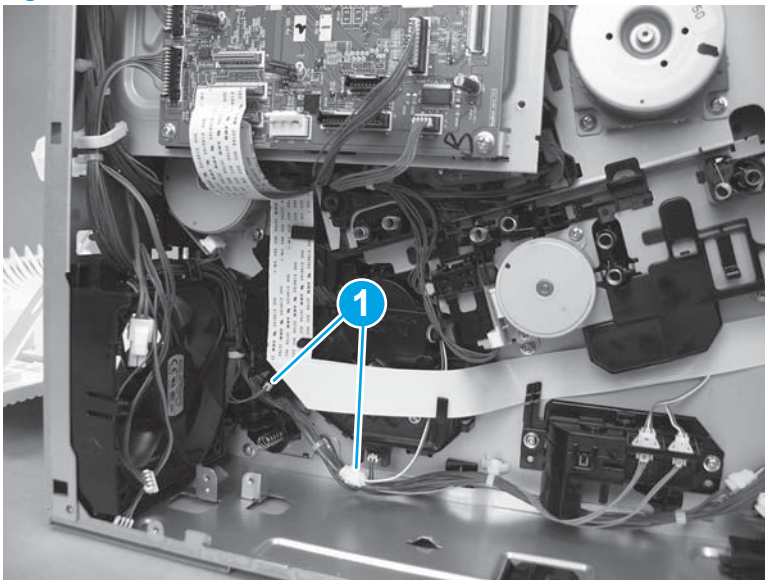

Step 38: Install the HVPSD

 **CAUTION:**  ESD-sensitive part.

1. Position the bottom right corner of the HVPSD (callout 1) behind the black tab, and then rotate it up and onto the printer (callout 2).

Figure 1-4185 Install the HVPSD

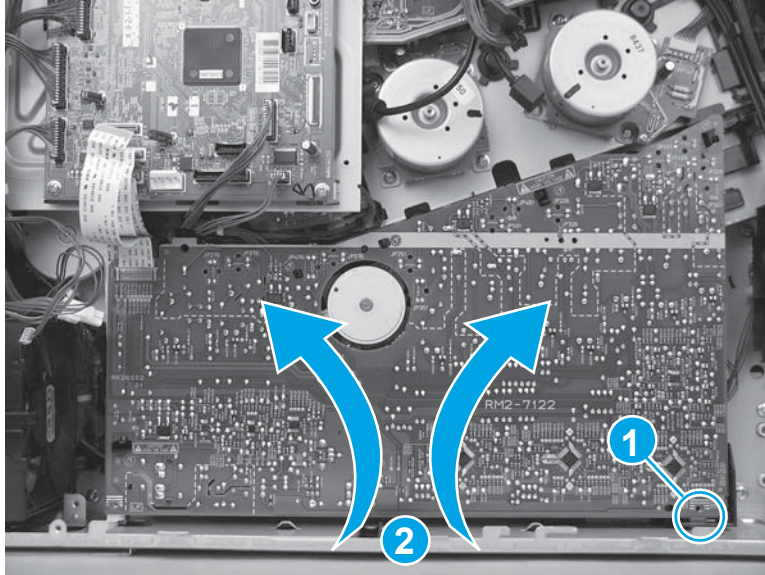

2. Press it onto five tabs (callout 2).

 **IMPORTANT:** Make sure that all five tabs snap into place.

Figure 1-4186 Press the tabs



3. Install two screws (callout 1), and then install one self tapping screw (callout 2) on the HVPSD.

Figure 1-4187 Install three screws

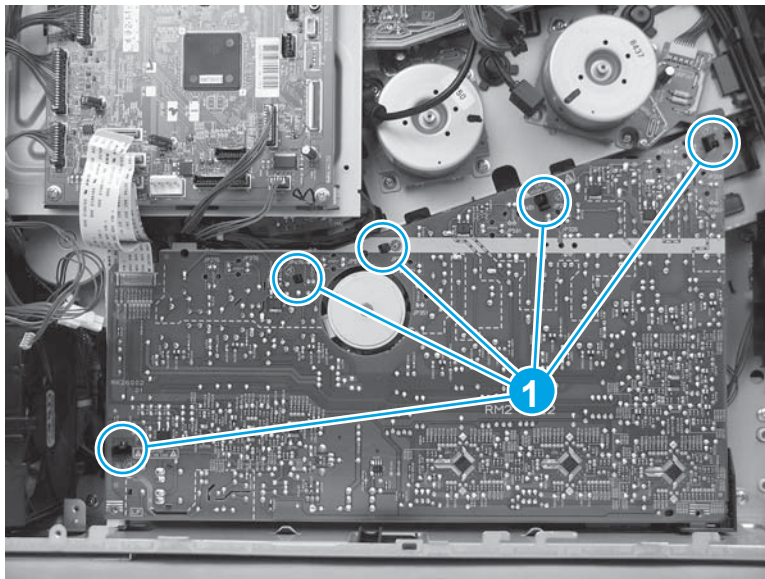
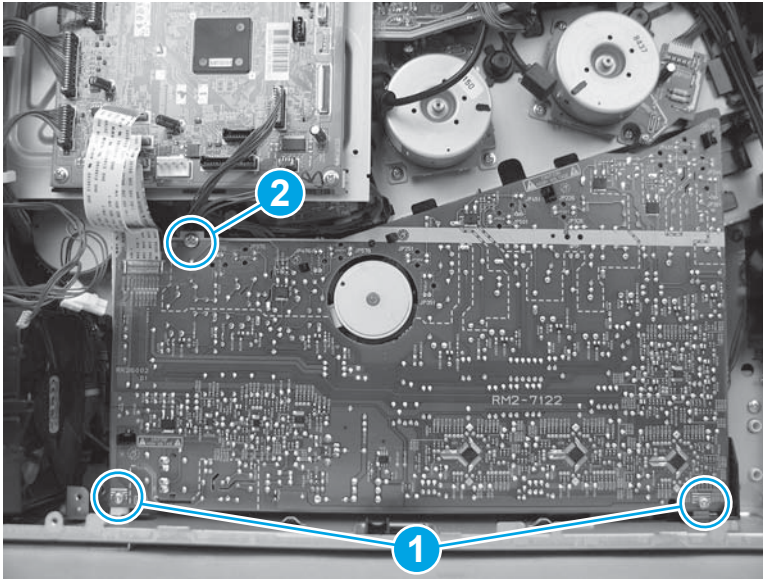

4. Connect one flat cable (callout 1) on the DC controller.

Figure 1-4188 Connect one flat cable

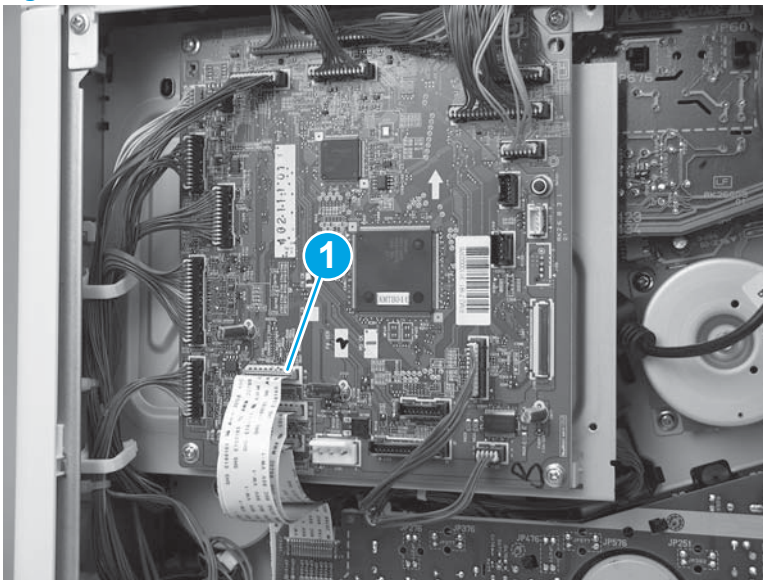

Step 39: Install the power-supply fan (FM1)

1. Slide the fan in (callout 1) and then down (callout 2) into the printer to install it.



NOTE: Make sure that the arrow (callout 3) embossed on the fan holder faces into the printer.

Figure 1-4189 Install the fan

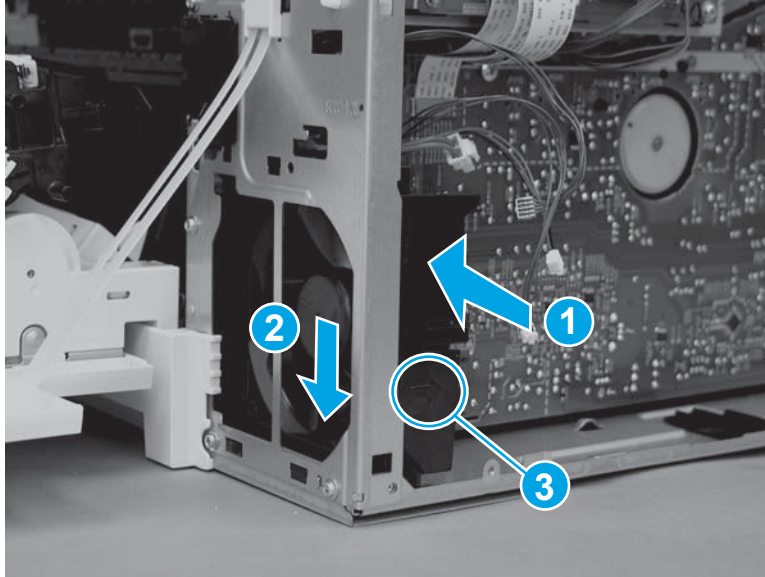

2. Place the wire harnesses in the retainer on the top of the fan bracket.

Figure 1-4190 Place the wire harnesses in the retainer

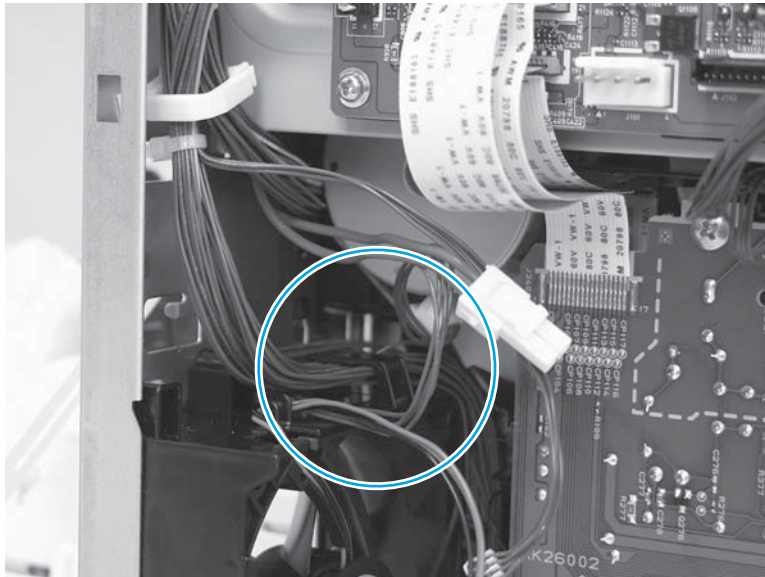

3. Install one screw (callout 1).

Figure 1-4191 Install one screw

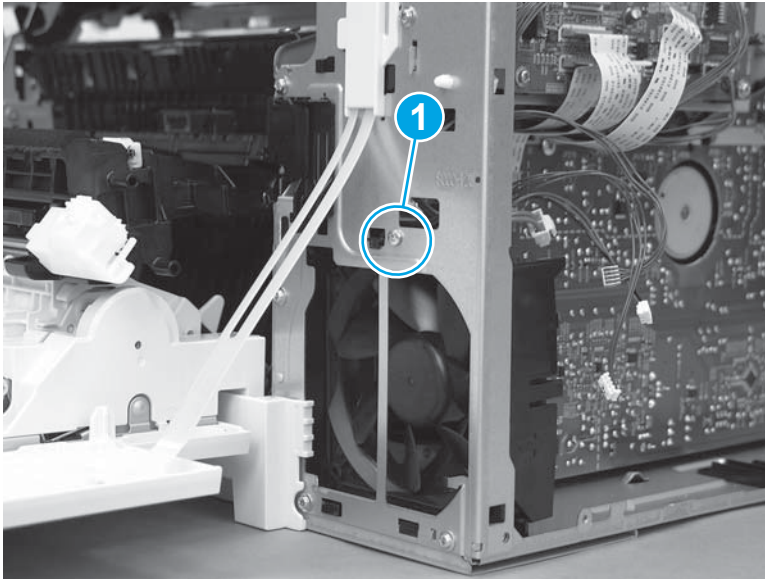

Step 40: Install the LVPS

 **CAUTION:**  ESD-sensitive part.

1. Position the bottom of the LVPS in the printer (callout 1) at a slight angle, and then rotate the top of it into the printer (callout 2) to install it.

Figure 1-4192 Install the LVPS

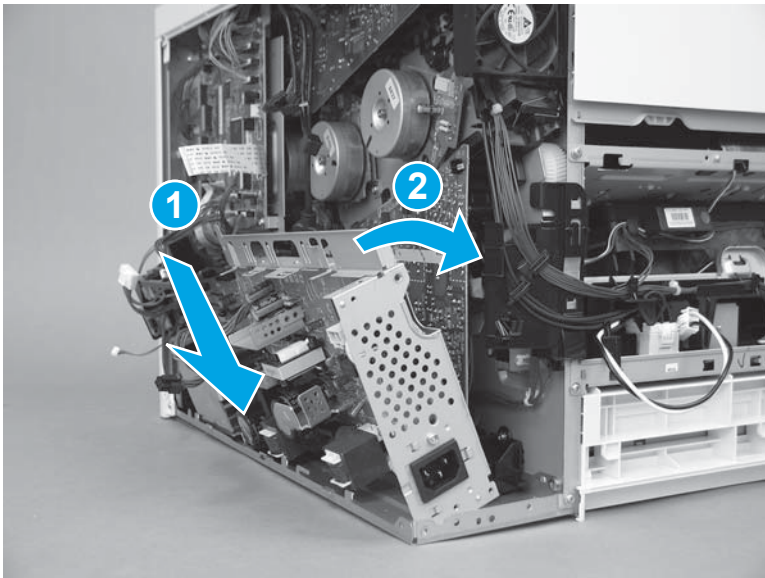

2. Install three screws (callout 1).

Figure 1-4193 Install three screws

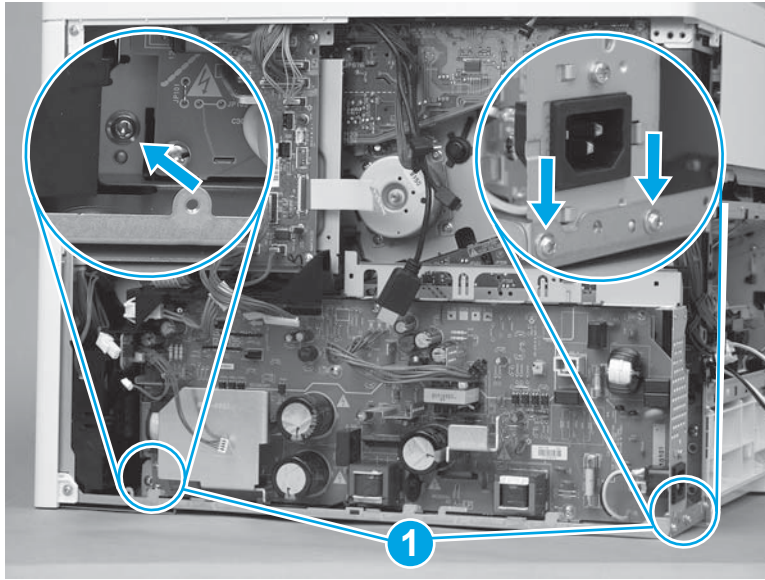

3. Pass the wire harnesses from the DC controller to the LVPS through the opening in the chassis (callout 1), and then install the wire harnesses in the retainer (callout 2).

Figure 1-4194 Pass the wire harnesses through the opening

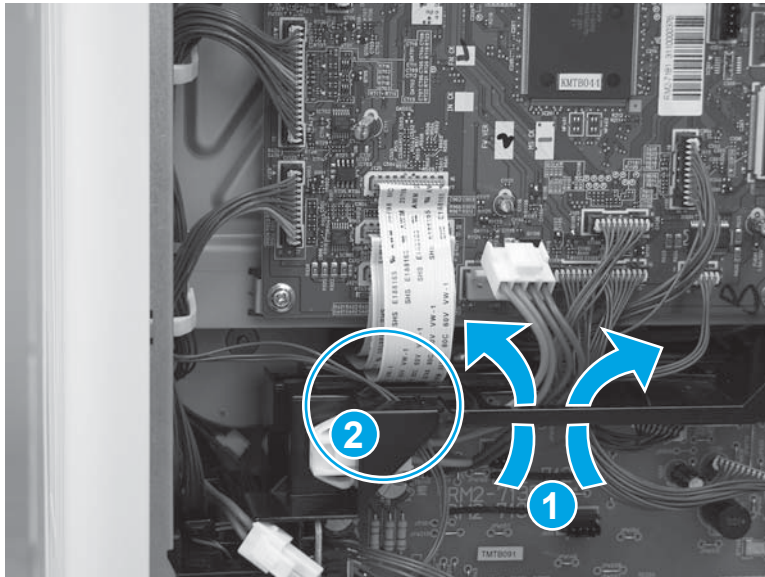

4. Connect three connectors on the DC controller (callout 1), and then connect four connectors (callout 2) on the LVPS.

Figure 1-4195 Connect seven connectors

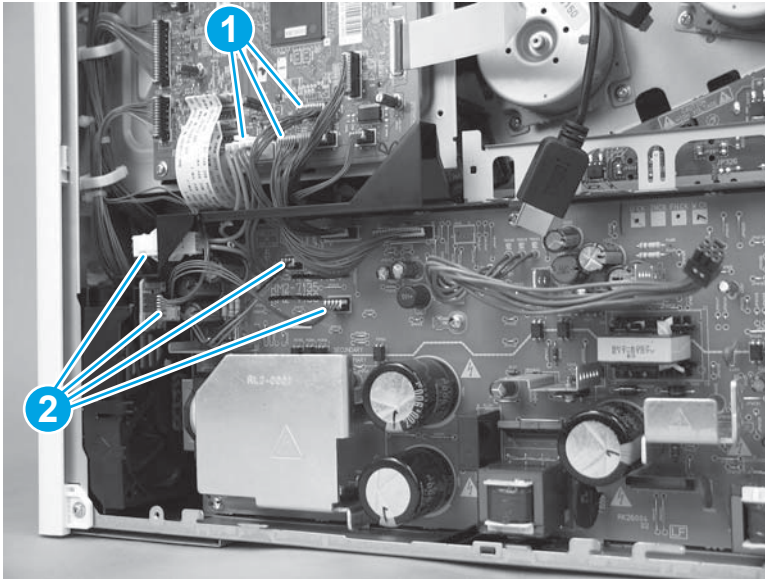

5. Pass the wire harness through the opening (callout 1) in the chassis, and then connect one wire harness (callout 2).

Figure 1-4196 Connect one wire harness

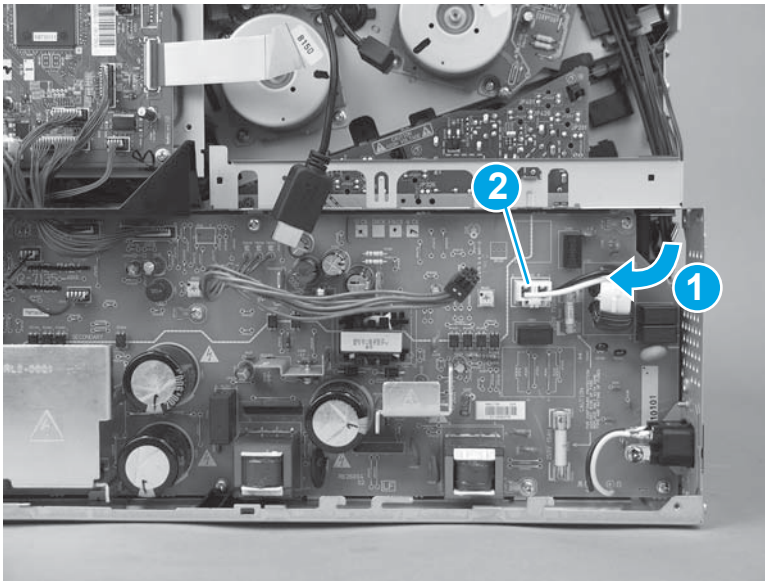

Step 41: Install the formatter case

1. Pass the wire harnesses through the opening in the formatter case.

Figure 1-4197 Pass the wire harnesses through the opening

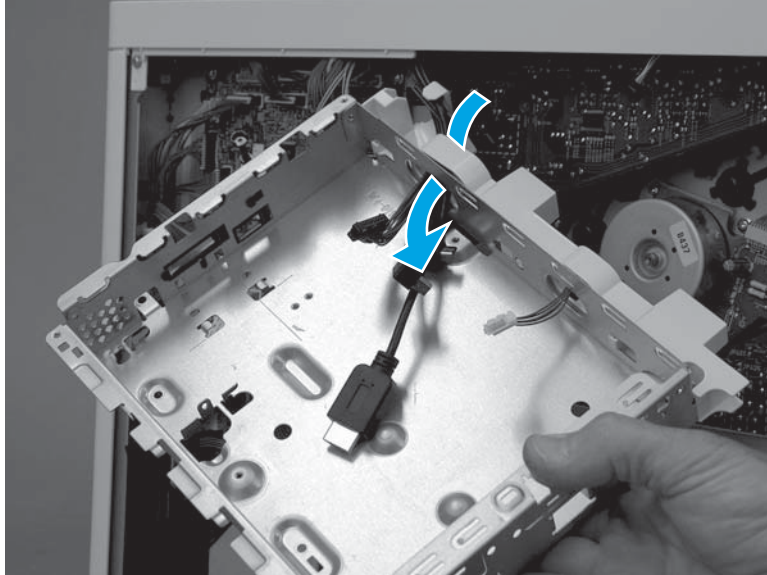

2. Position the top of the formatter case on the printer (callout 1), and then rotate the bottom of the case (callout 2) into the printer.

Figure 1-4198 Install the formatter case

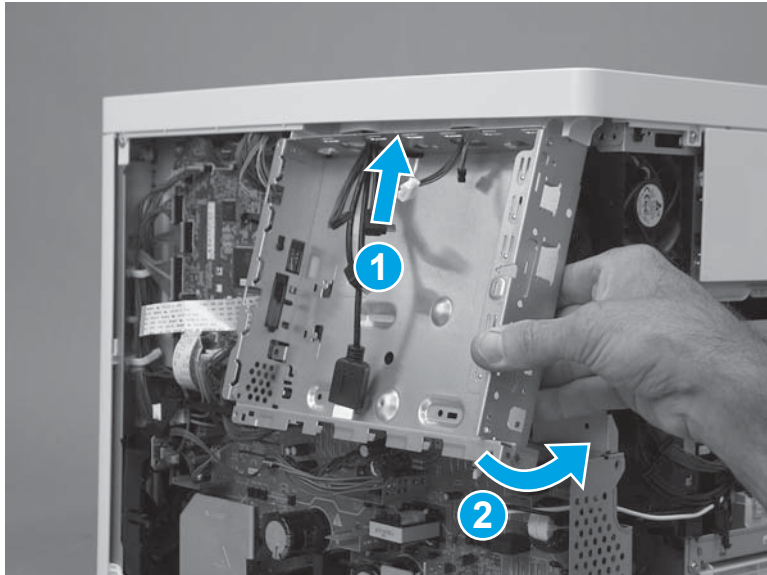

3. Install six screws (callout 1).

Figure 1-4199 Install six screws

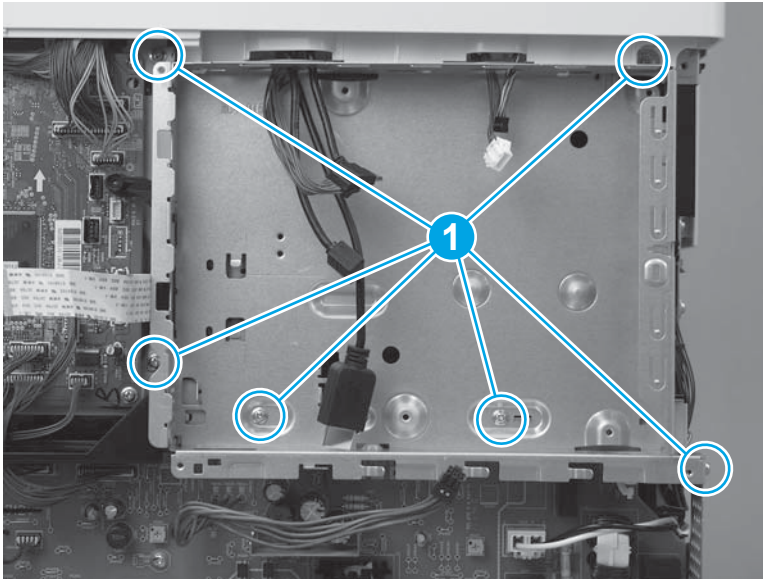

4. Pass two wire harnesses and one flat cable (callout 1) through the opening in the formatter case, and then install one wire harness in the retainer (callout 2).

 **IMPORTANT:** Make sure that the flat cable is securely fastened to the DC controller, and was not dislodged when the formatter case was removed.

Figure 1-4200 Install wire harnesses and flat cable



5. Position the LVPS cover on the printer, slide the cover to the left to install it, and then install two screws (callout 1).

Figure 1-4201 Install the LVPS cover

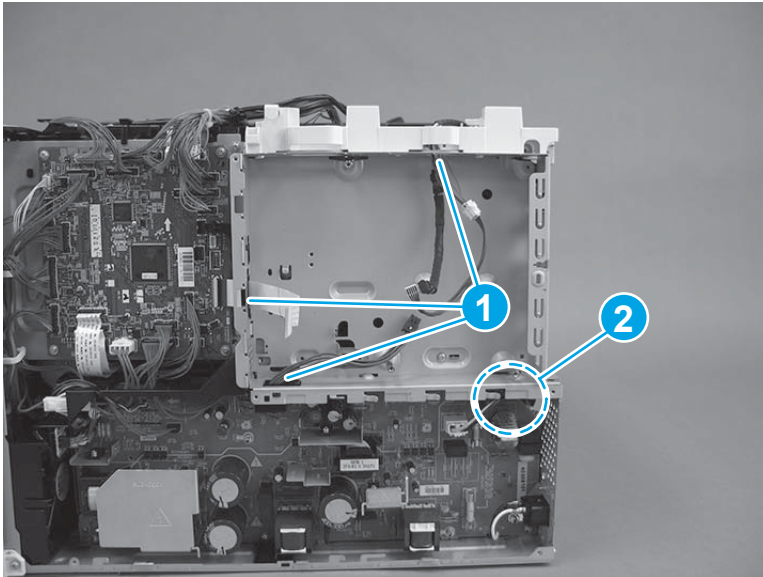
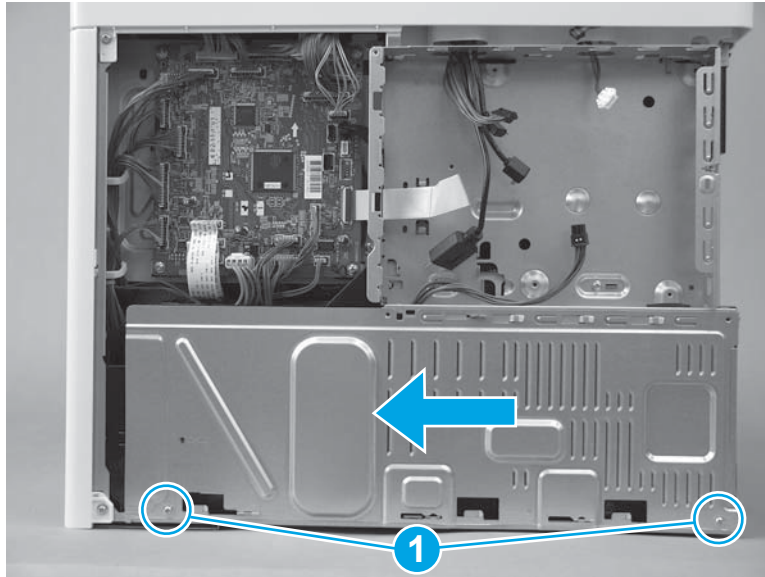

6. If no tape is affixed to the back of the flat cable, skip this step. If double-sided tape is affixed to the back of the flat cable, align the line (callout 1) on the cable with the edge (callout 2) of the opening in the sheet metal. Press to attach the flat cable to the formatter case.

Figure 1-4202 Attach the flat cable

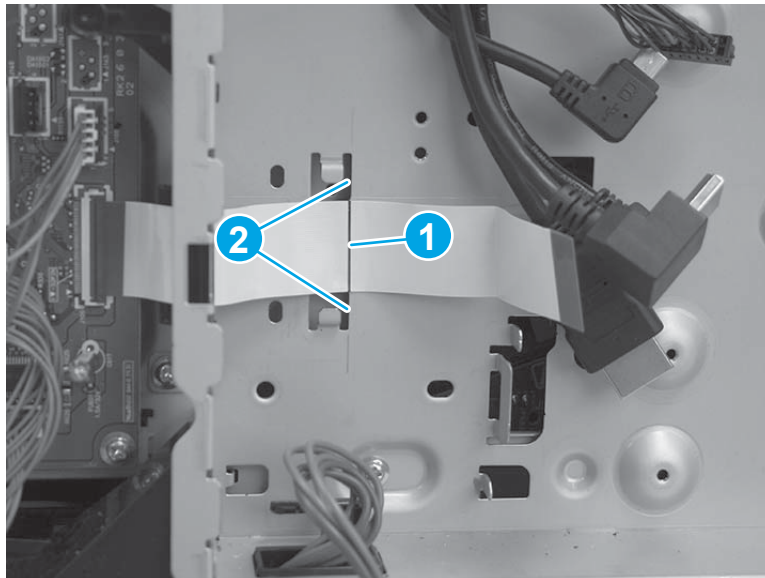

7. Position the bracket over the flat cable, and then slide the bracket to the left to install it. Make sure that the edges of the bracket fit under the sheet metal tabs (callout 1) on the formatter case and that the tabs (callout 2) snap into place.

Figure 1-4203 Position the bracket

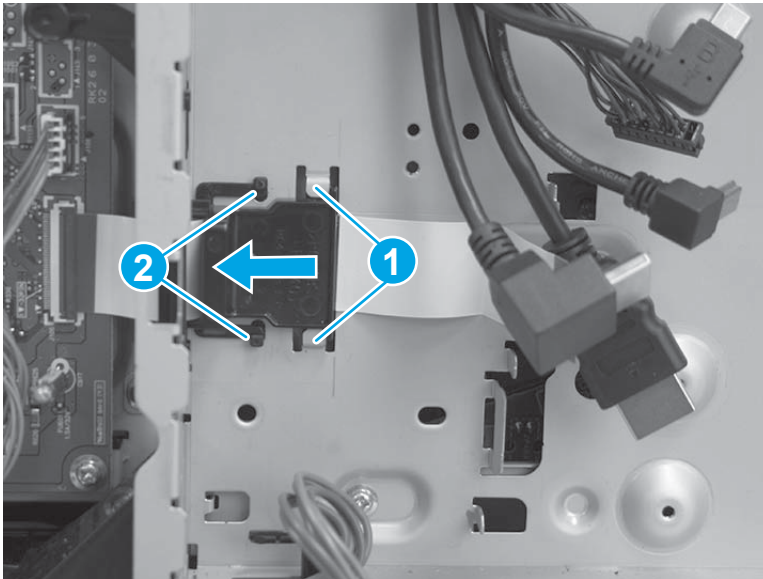

8. **M577 only:** Pass the wire harness (callout 1) through the openings in the formatter case (callout 2), and then connect one connector (callout 3).

Figure 1-4204 Connect one connector

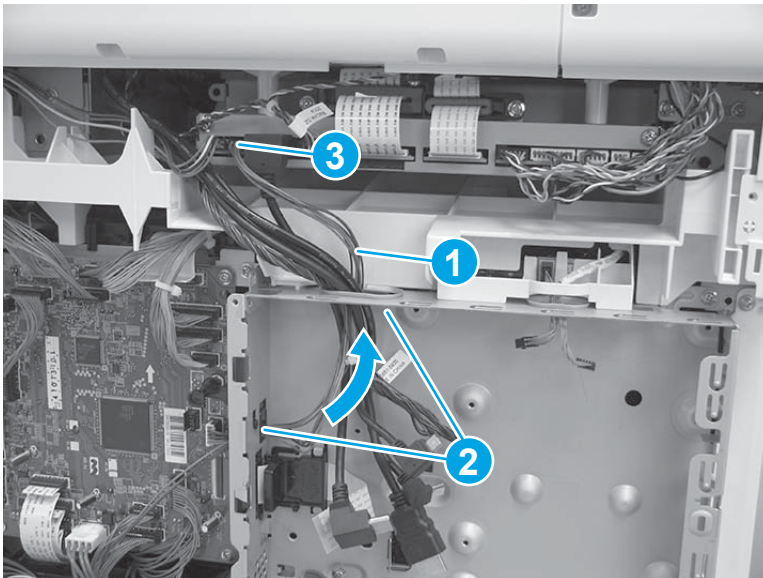

Step 42: Install the right rear cover

1. Position the cover on the printer.

Figure 1-4205 Install the cover

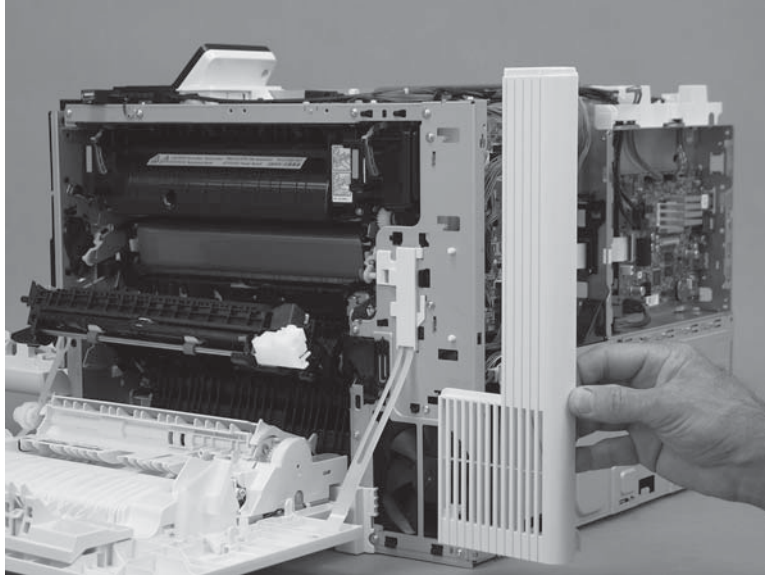

2. Slide the cover toward the right door (callout 1) to engage it with the printer, and then install one screw (callout 2).

Figure 1-4206 Install one screw

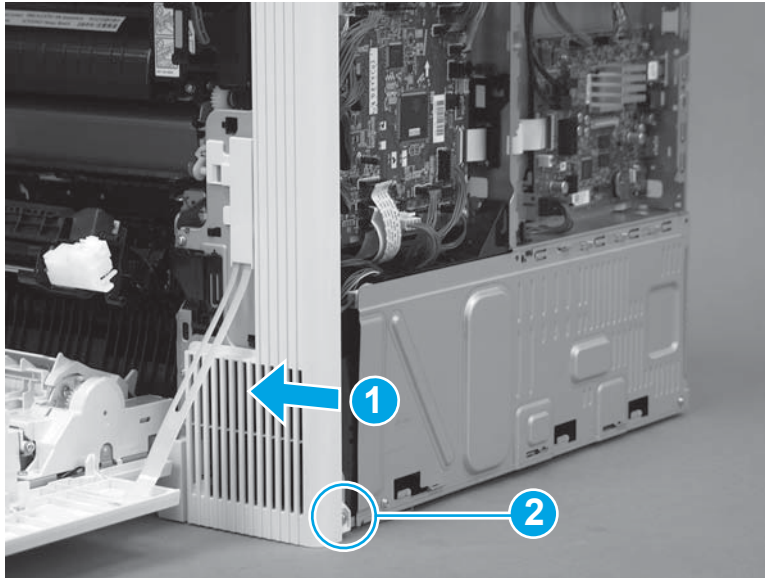

Step 43: Install the upper cover (M552 and M553)

 **NOTE:** This step is for the M552 and M553 models. For the M577 models, skip this step and go to [Step 44: Install the left cover on page 2341](#).

1. Position the cover on the printer.

 **NOTE:** For the M553x model, do not forget to pass the control-panel wire harness and USB cable through the opening in the cover.

Figure 1-4207 Install the cover



2. Push down on the rear corner of the cover to engage one tab (callout 1).

Figure 1-4208 Engage one tab

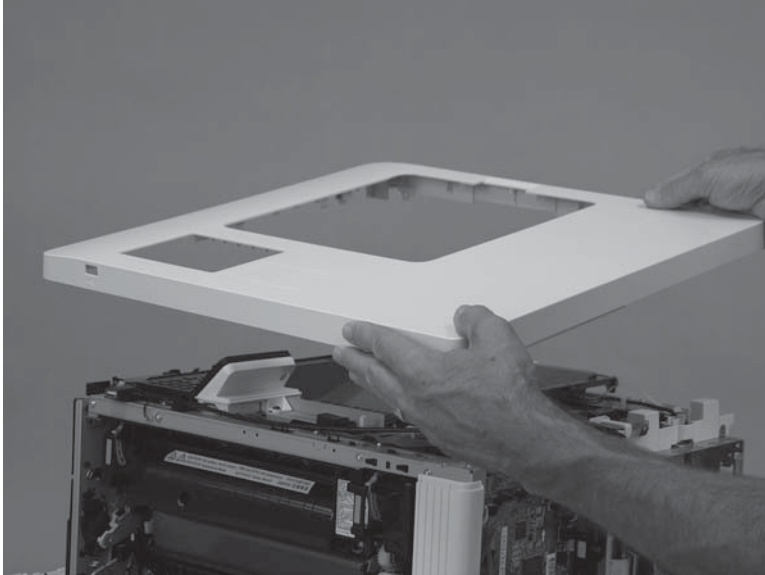
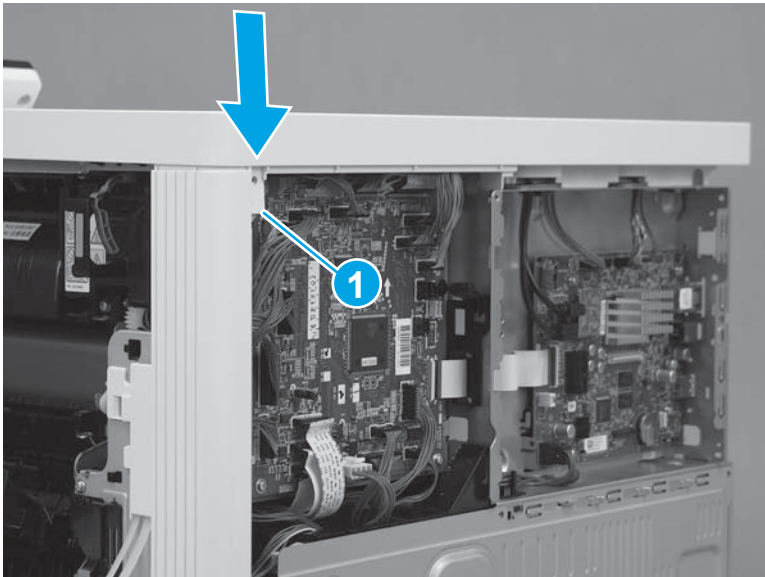

3. Push down on the front corner of the cover to engage one tab (callout 1), and then install one screw (callout 2).

 **NOTE:** This is a self-tapping plastic-thread screw. Make sure that this screw is used in this location when it is reinstalled.

Figure 1-4209 Engage one tab and install one screw



4. Install three screws (callout 1).

Figure 1-4210 Install three screws

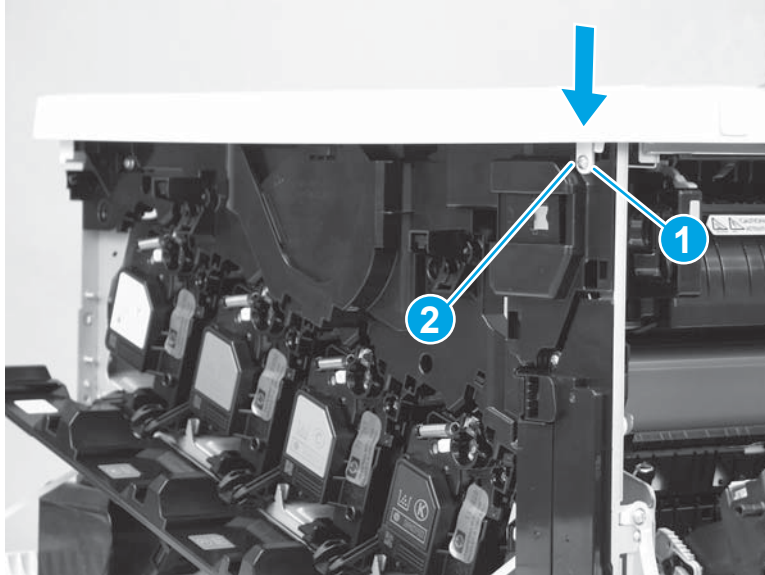
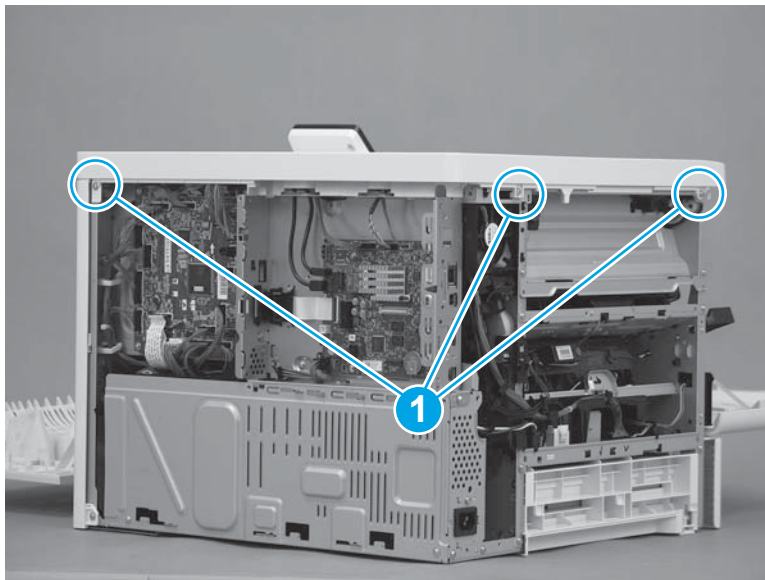

Step 44: Install the left cover

1. Position the cover on the printer.

 **NOTE:** Slightly offset the cover toward the rear of the printer.

Figure 1-4211 Install the cover

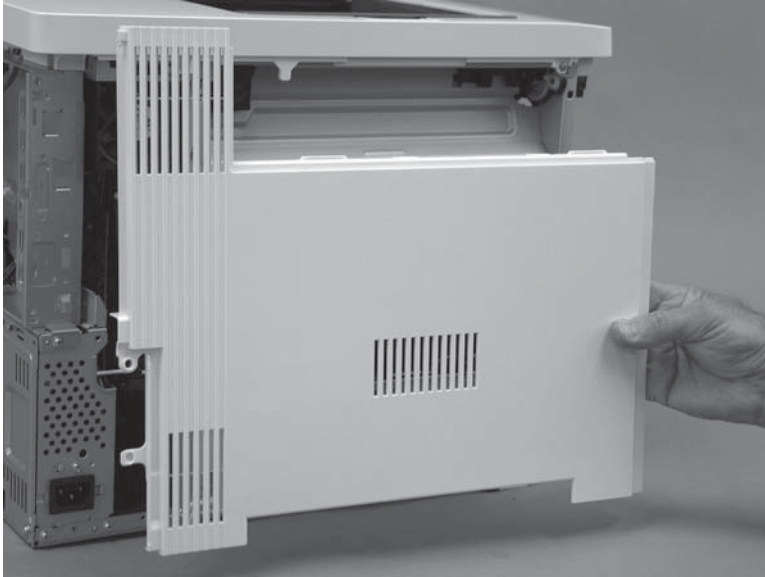

2. Slide the cover (callout 1) toward the front of the printer to engage it. Make sure that the tab (callout 2) snaps into place.

 **NOTE:** Locate the alignment pin (callout 3) on the cover from the front door side of the printer, and then make sure that it is fully engaged in the slot in the chassis.

 **TIP:** While sliding the cover into place, push in on the center of the cover (callout 1) to make sure that the hooks on the back of the cover engage with the slots in the chassis.

Figure 1-4212 Engage the cover



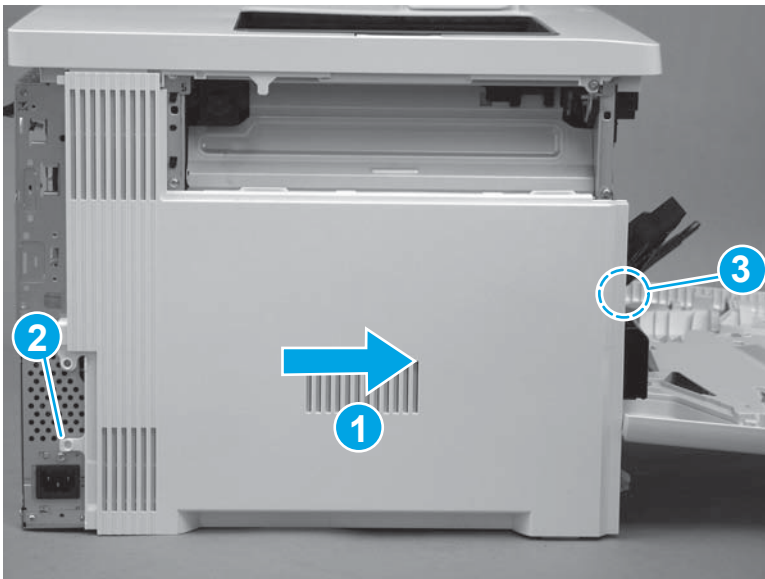

3. At the left side of the printer, install one screw (callout 1).

Figure 1-4213 Install one screw



Step 45: Install the right upper cover (M577)

 **NOTE:** This step is for the M577 models. For the M552 and M553 models, skip this step and go to [Step 52: Install the rear cover \(M552 and M553\) on page 2357.](#)

 **NOTE:** The figures below show the image scanner installed. The procedures for removing and installing the right upper cover are the same whether the image scanner is installed or removed."

1. **M577c/f/z only:** Install the cables (callout 1) through the slot (callout 2) in the printer.

Figure 1-4214 Install the cables

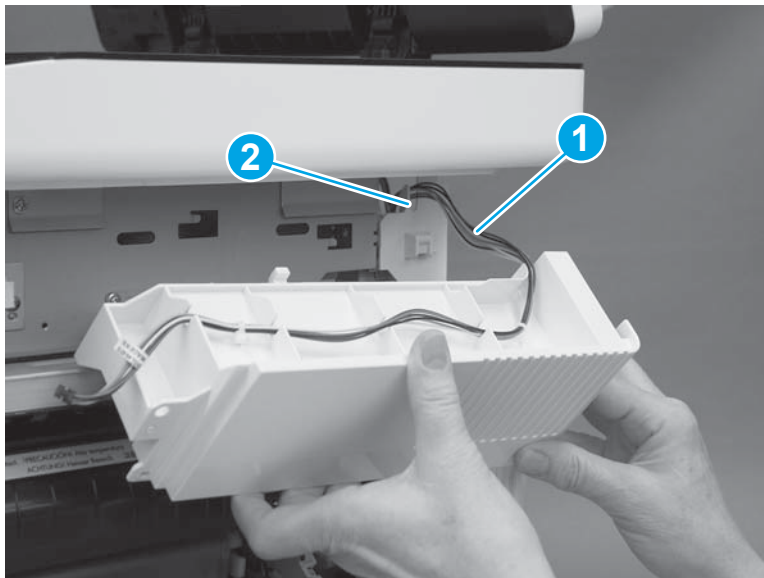

2. Position the hooks (callout 1) on the cover in the slots (callout 2) in the printer.

Figure 1-4215 Position the hooks

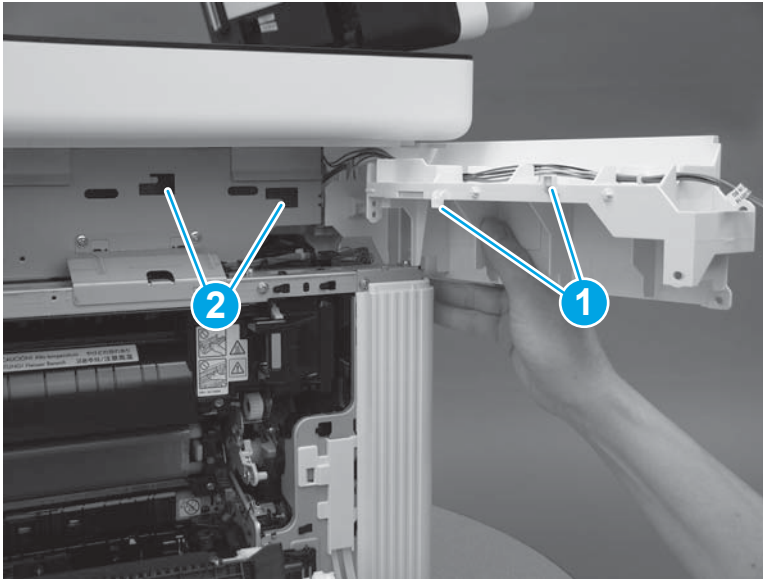

3. Slide the cover toward the front of the printer to install it.

Figure 1-4216 Install the cover

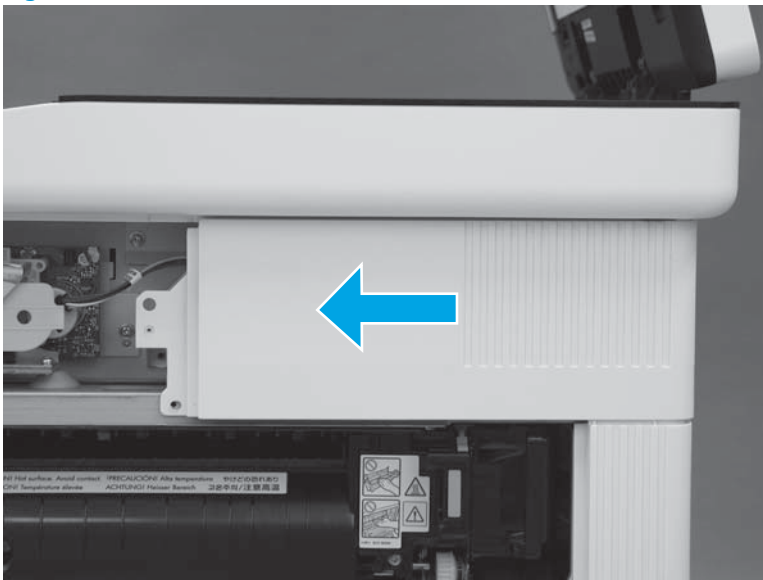

4. At the back of the printer, install one screw (callout 1).

M577c/f/z only: Connect one connector (callout 2), if the integrated scanner assembly is installed.

 **TIP:** This screw is smaller than the screws installed in the next step. Make sure that this screw is installed in the correct position.

Figure 1-4217 Install one screw and connector



5. At the right side of the printer, install two screws (callout 1).

M577c/f/z only: Connect one connector (callout 2), if the stapler is installed.

Figure 1-4218 Install one screw and connector

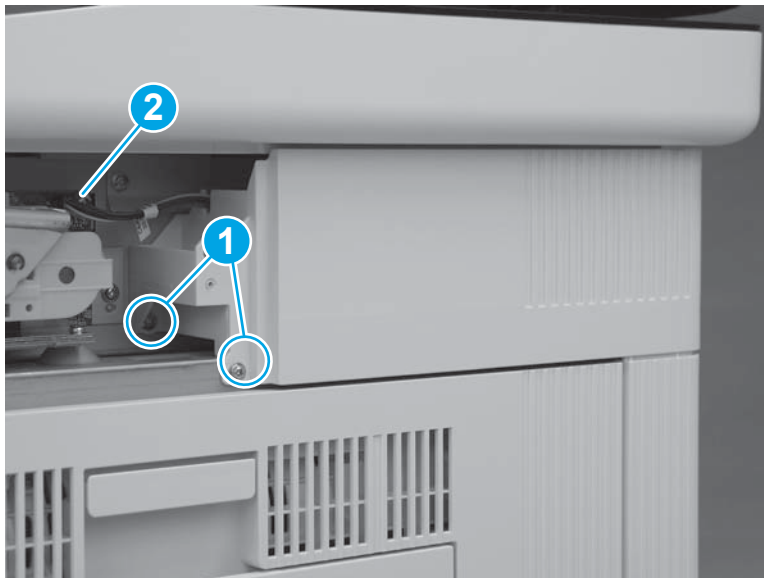

Step 46: Install the integrated scanner assembly (ISA) (M577)

 **NOTE:** This step is for the M577 models. For the M552 and M553 models, skip this step and go to [Step 52: Install the rear cover \(M552 and M553\) on page 2357.](#)



NOTE: The ISA includes the document feeder, image scanner, scanner control board (SCB), control panel, keyboard (M577c/z) and NFC PCA (M577z).

1. Before proceeding, locate the mounting pins (callout 1) on the bottom of the ISA and the slots (callout 2) on the printer base.

Figure 1-4219 Locate the ISA mounting pins and slots

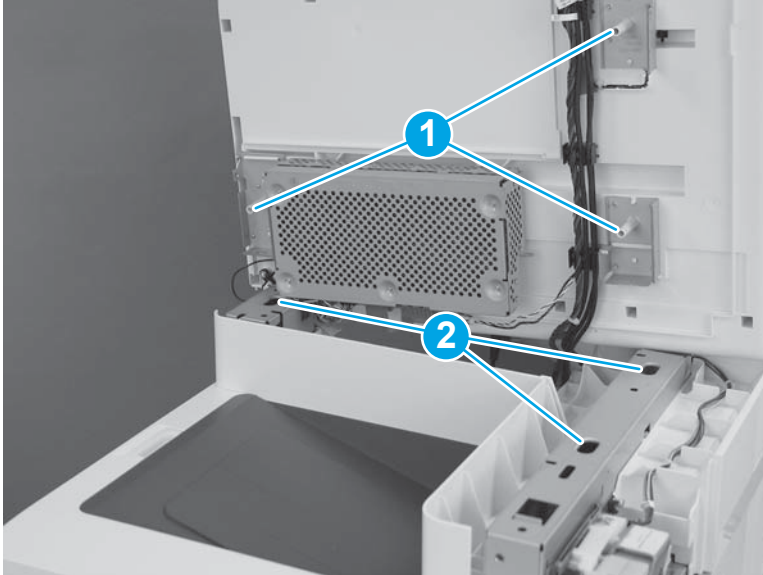

2. Position the ISA on the printer base with the pins in the slots.



NOTE: To locate the pins and slots, see [Figure 1-395 Locate the ISA mounting pins and slots on page 250](#).

When installing the ISA, carefully pass the cables through the opening in the top of the formatter case.

Figure 1-4220 Install the ISA



3. Slightly slide the ISA towards the front of the printer to engage it.

Figure 1-4221 Slide the ISA towards the front of the printer

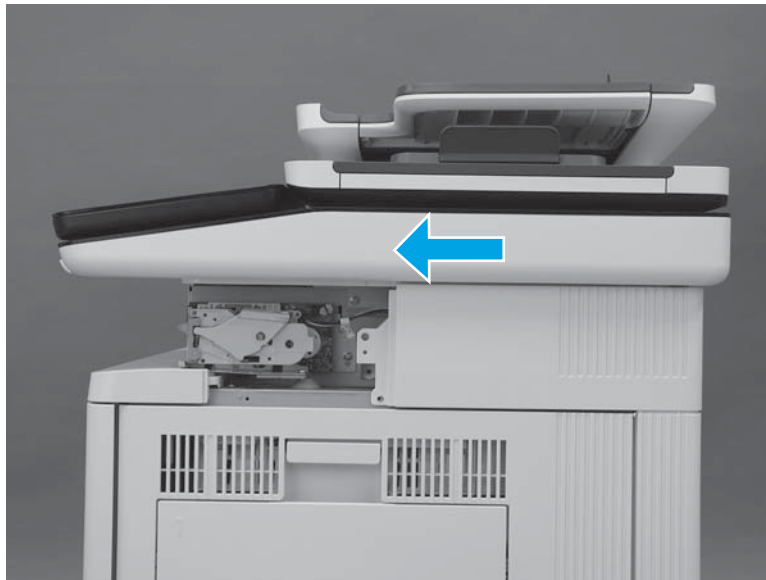

4. At the left side of the printer, install one screw (callout 1).

Figure 1-4222 Install one screw

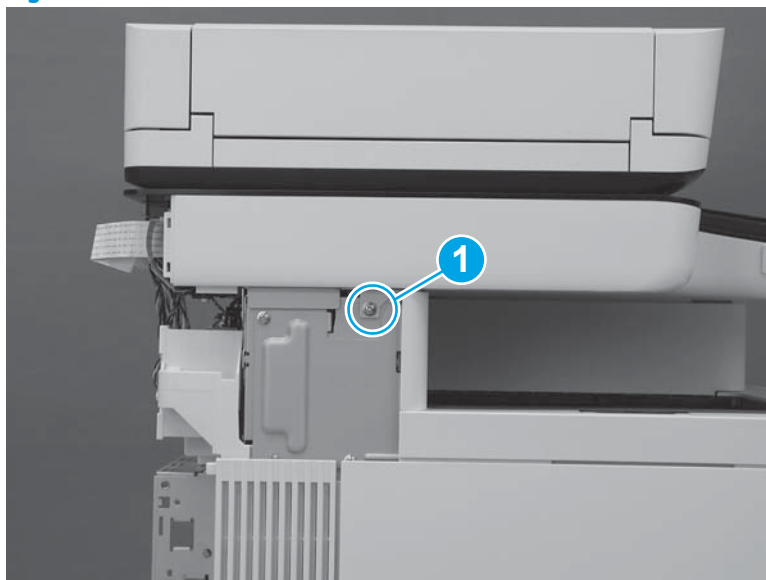

5. At the back of the printer, install two screws (callout 1).

Figure 1-4223 Install two screws

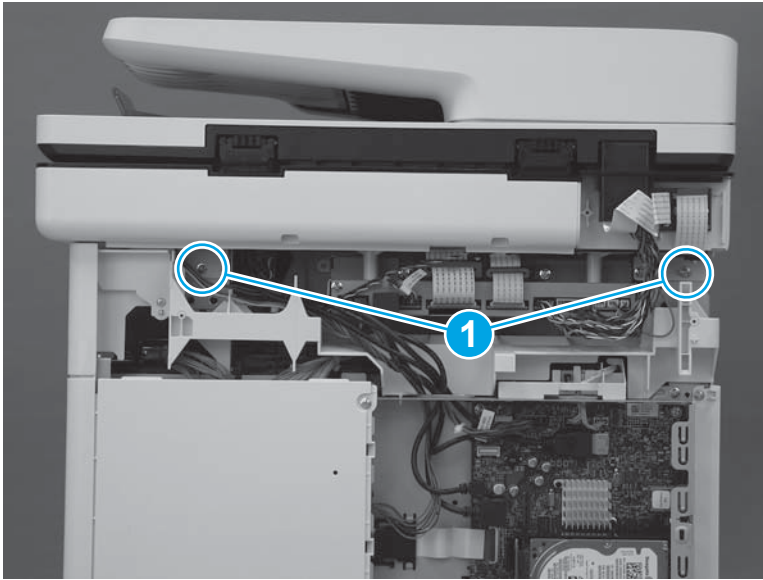

6. At the right side of the printer, install one screw (callout 1).

Figure 1-4224 Install one screw

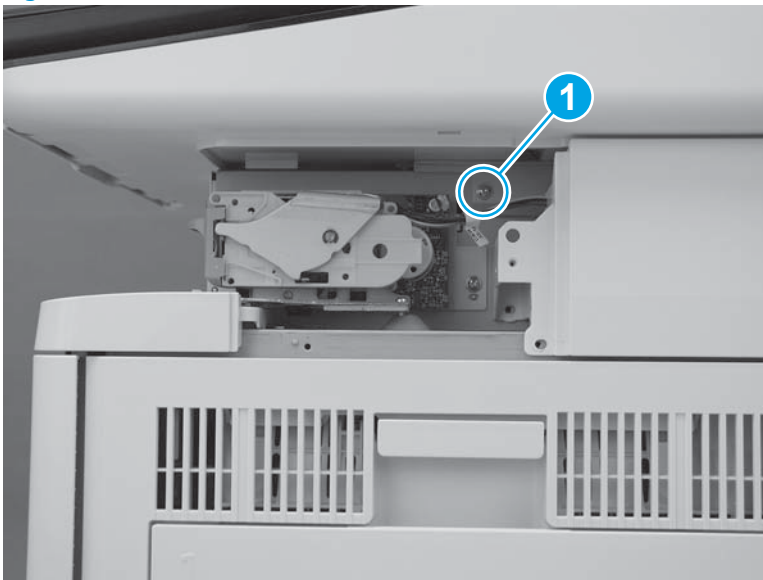

7. Connect two connectors on the scanner control board (callout 1).

M577c/f/z only: Connect one connector for the stapler on the scanner control board (callout 2).

Figure 1-4225 Connect connectors

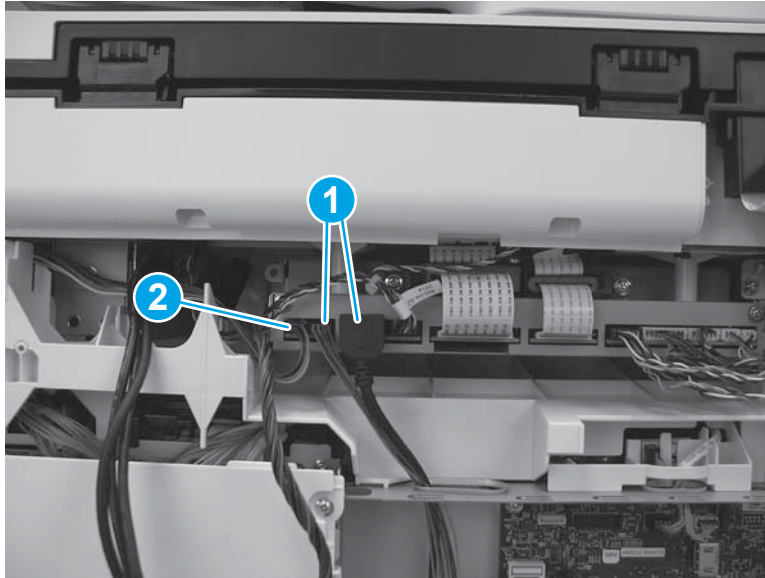

Step 47: Install the stapler cover assembly (M577c/f/z)

 **NOTE:** This step is for the M577c/f/z models only. For the M577dn model, skip this step and go to [Step 48: Install the right front upper cover \(M577dn\) on page 2350.](#)

For the M552 and M553 models, skip this step and go to [Step 52: Install the rear cover \(M552 and M553\) on page 2357.](#)

1. Install the tabs (callout 1) on the cover in the slots (callout 2) in the printer.

Figure 1-4226 Install two tabs



2. Press the cover toward the left side of the printer until it snaps into place.

Figure 1-4227 Install the cover assembly



3. Install one screw (callout 1).



 **IMPORTANT:** This is a self-tapping screw for plastic. Rotate it counterclockwise to align it with the existing thread pattern, and then carefully turn it clockwise to tighten. Do not overtighten. This will prevent stripping the threads inside the screw hole.

Figure 1-4228 Install one screw

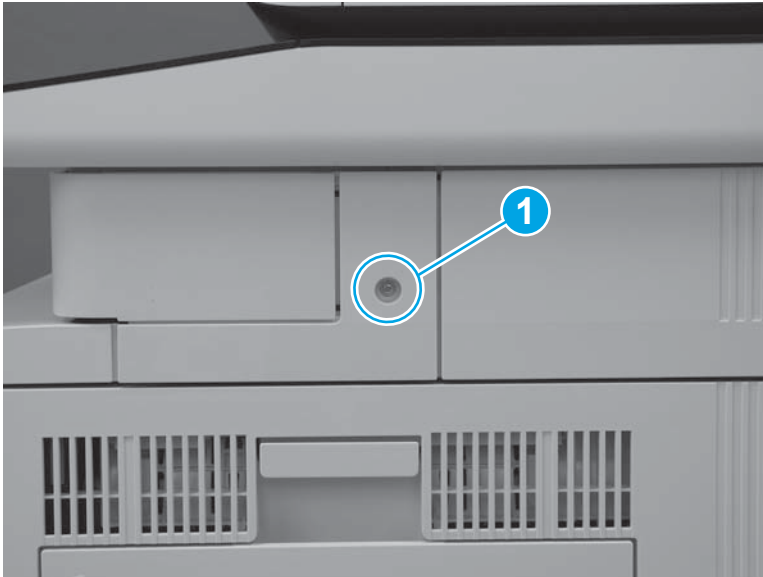

Step 48: Install the right front upper cover (M577dn)

 **NOTE:** This step is for the M577dn model only. For the M577c/f/z models, skip this step and go to [Step 49: Install the left upper cover \(M577\) on page 2352](#).

For the M552 and M553 models, skip this step and go to [Step 52: Install the rear cover \(M552 and M553\) on page 2357](#).

1. Slide the cover toward the left side of the printer to install it. Make sure that the slots (callout 1) in the cover fit over the tabs (callout 2) on the inside of the paper feeder cover.

Figure 1-4229 Install the cover

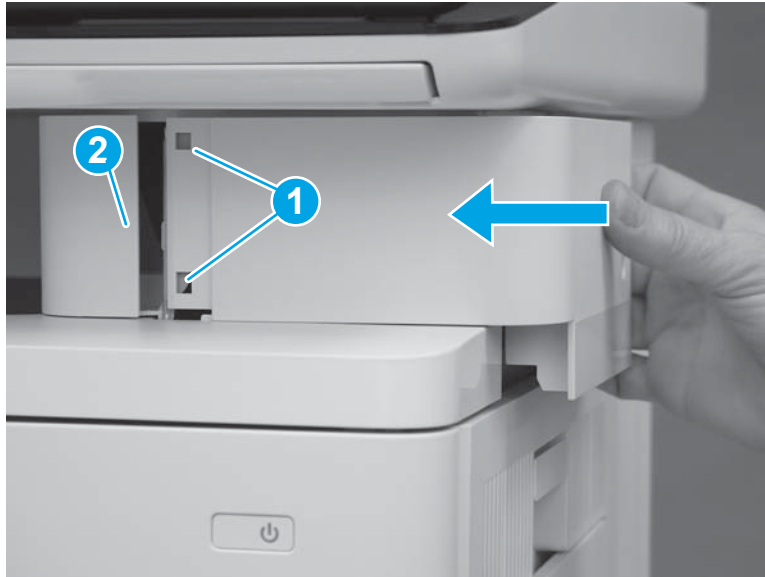

2. Press the right front upper cover (callout 1) and the paper feeder cover (callout 2) together until the tabs on the inside of the covers snap into place.

Figure 1-4230 Press the cover



3. Install one screw (callout 1).

Figure 1-4231 Install one screw

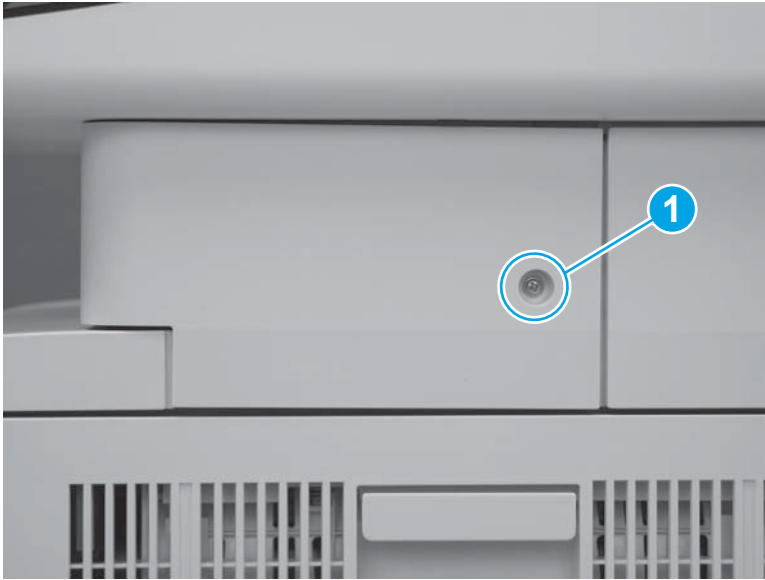

Step 49: Install the left upper cover (M577)



NOTE: This step is for the M577 models. For the M552 and M553 models, skip this step and go to [Step 52: Install the rear cover \(M552 and M553\) on page 2357](#).

1. Position the tab (callout 1) on the lower edge of the cover behind the left cover (callout 2).

Figure 1-4232 Position the tab

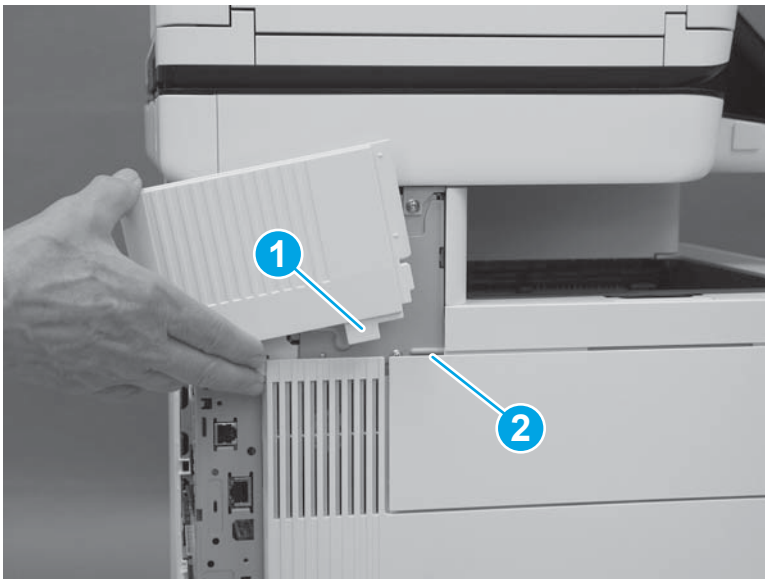

2. Slide the cover toward the front of the printer to install it. Make sure that the edge (callout 1) of the cover fits behind the edge (callout 2) of the top rear cover.

Figure 1-4233 Slide the cover

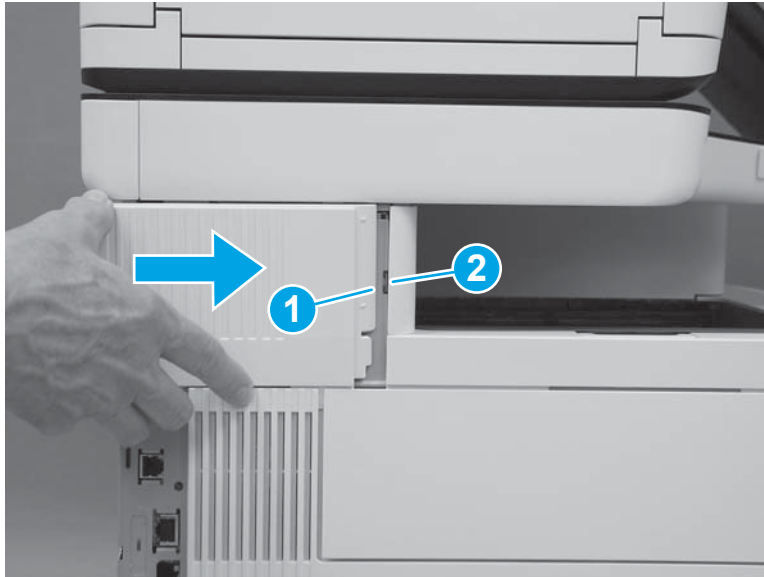

3. Make sure that the tab (callout 1) is fully installed.

Figure 1-4234 Check the tab

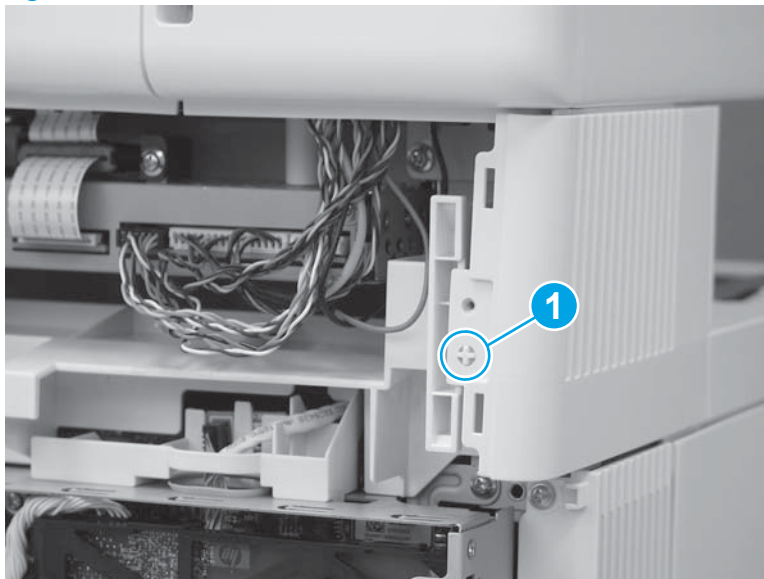

Step 50: Install the rear cover (M577)

 **NOTE:** This step is for the M577 models. For the M552 and M553 models, skip this step and go to [Step 52: Install the rear cover \(M552 and M553\) on page 2357](#).

1. Position the hooks (callout 1) on the cover in the slots (callout 2) in the printer.

Figure 1-4235 Position the hooks

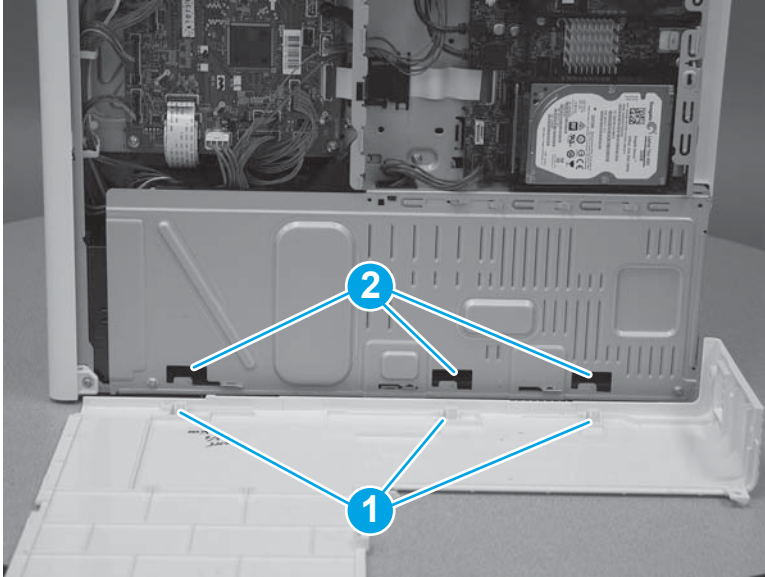

2. Position the back edge (callout 1) of the rear cover behind the edge (callout 2) of the right rear cover. Slide the cover to the left to install it.

Figure 1-4236 Install the cover

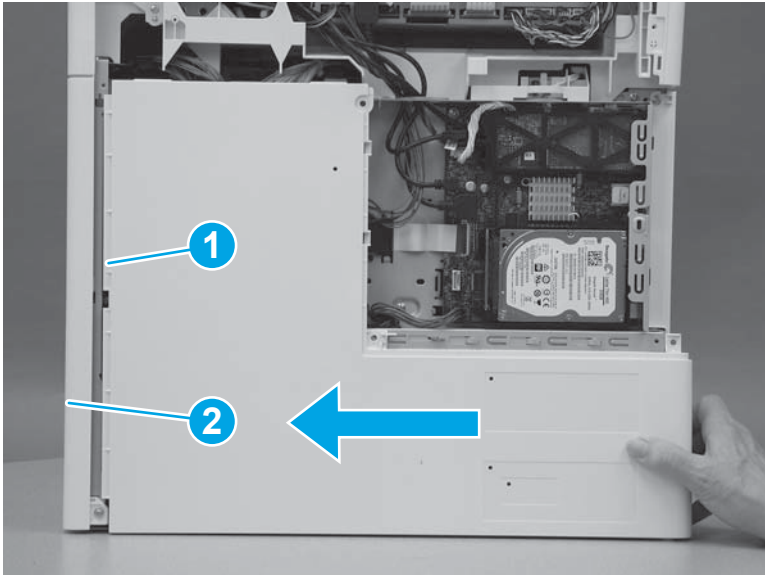

3. Install four screws (callout 1).

Figure 1-4237 Install four screws cover

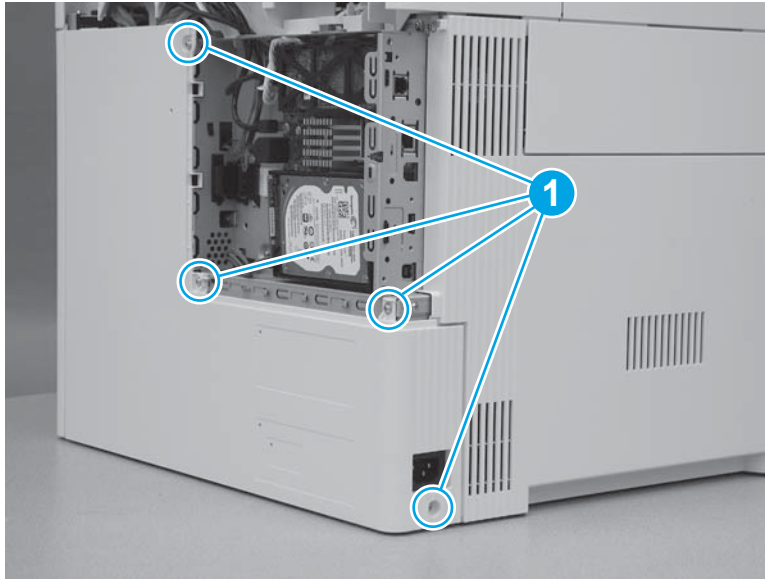

Step 51: Install the rear upper cover (M577)

 **NOTE:** This step is for the M577 models. For the M552 and M553 models, skip this step and go to [Step 52: Install the rear cover \(M552 and M553\) on page 2357](#).

1. Align the ridge (callout 1) on the lower edge of the rear upper cover in front of the tabs (callout 2) on the top edge of the rear cover.

Figure 1-4238 Align the cover

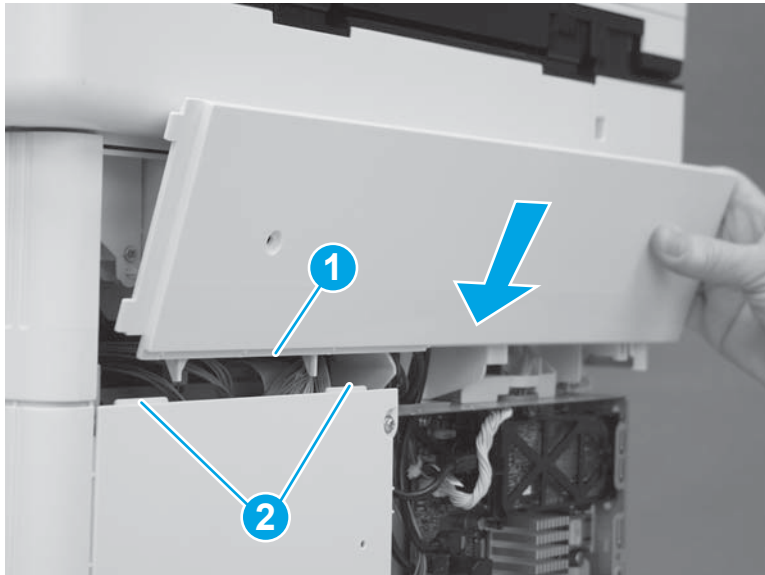

2. Rotate the top of the cover toward the printer.

Figure 1-4239 Rotate the top of the cover

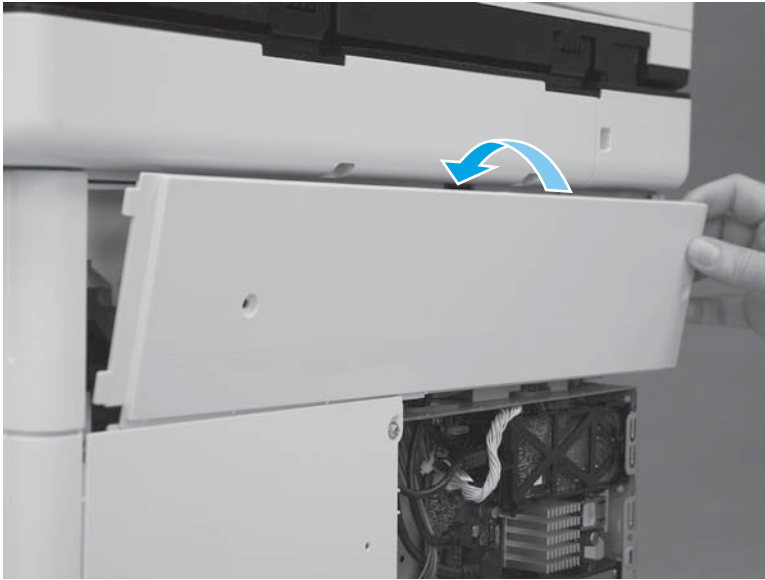

3. Slide the cover to the left (callout 1). Make sure that the tabs (callout 2) on the upper rear cover slide behind the edge (callout 3) of the right upper cover. Make sure that the cover is fully seated.

Figure 1-4240 Slide the cover

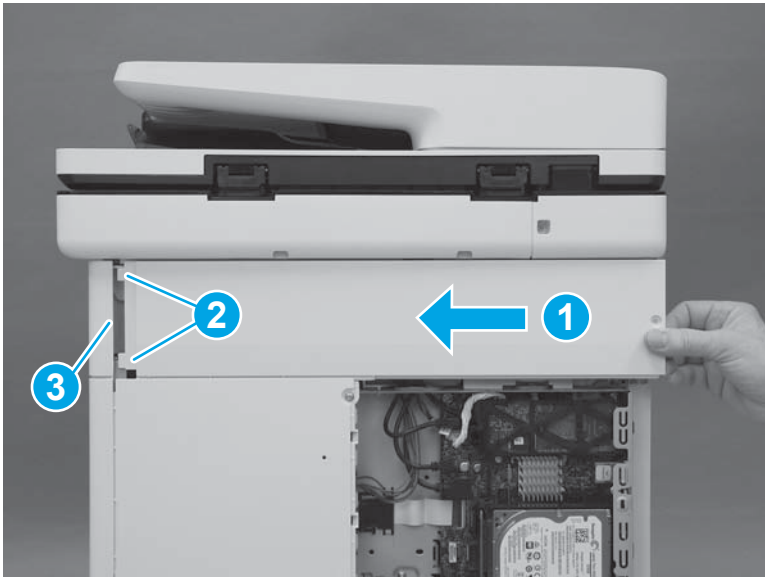

4. Install two screws (callout 1).

 **IMPORTANT:** These two screws are self-tapping screws for plastic. Rotate them counterclockwise to align them with the existing thread pattern, and then carefully turn them clockwise to tighten. Do not overtighten. This will prevent stripping the threads inside the screw holes.

Figure 1-4241 Install two screws



Step 52: Install the rear cover (M552 and M553)

 **NOTE:** This step is for the M552 and M553 models. For the M577 models, skip this step and go to [Step 53: Install the formatter \(M577\) on page 2358](#).

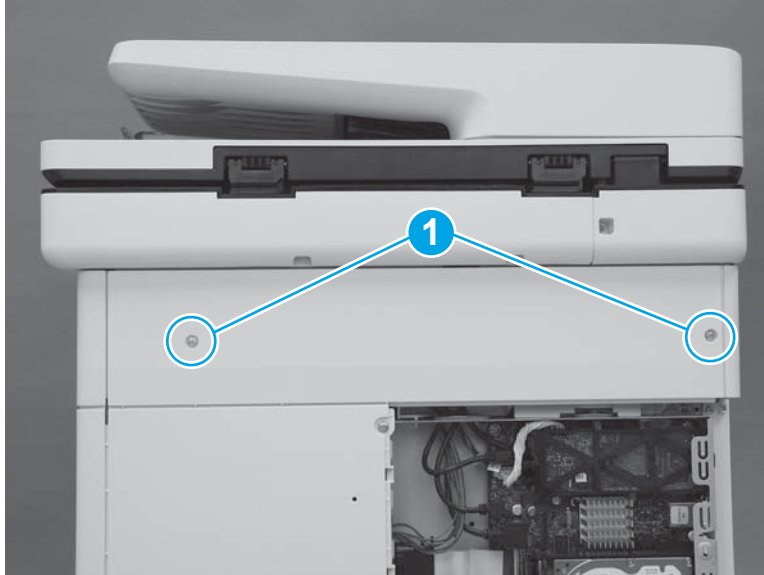
1. Position the top of the cover under the upper cover (callout 1), rotate the bottom of the cover onto the chassis (callout 2), and then slide the cover to the left (callout 3) to install it.

Figure 1-4242 Install the cover

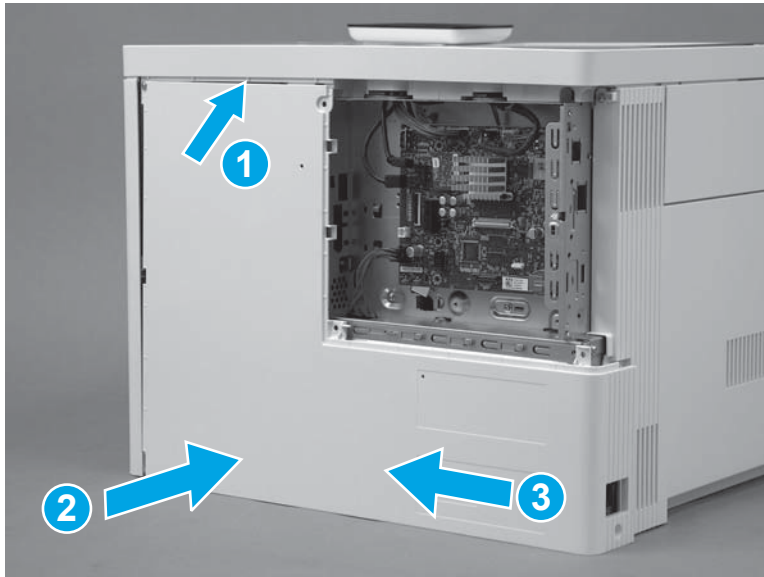

2. Install four screws (callout 1).

Figure 1-4243 Install four screws cover

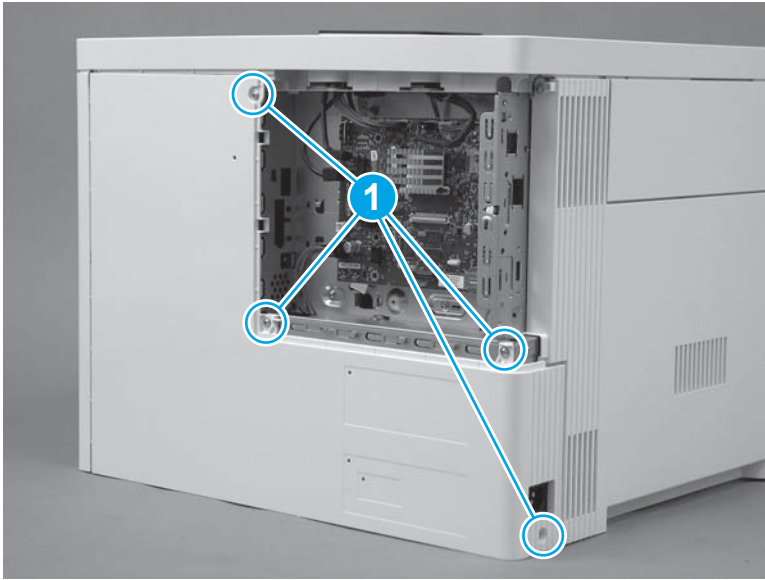

Step 53: Install the formatter (M577)



NOTE: This step is for the M577 models. For the M552 and M553 models, skip this step and to go [Step 56: Install the formatter \(M552 and M553\) on page 2363](#).



CAUTION:  ESD-sensitive part.

1. Position the formatter in the printer. Make sure that the network port (callout 1) fits through the opening (callout 2) in the formatter case.

Figure 1-4244 Install the formatter

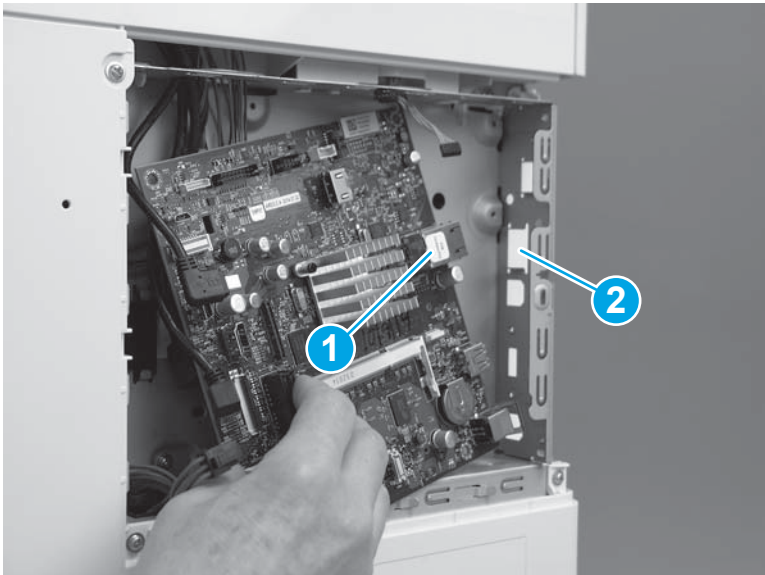

2. Install four screws (callout 1).

Figure 1-4245 Install four screws

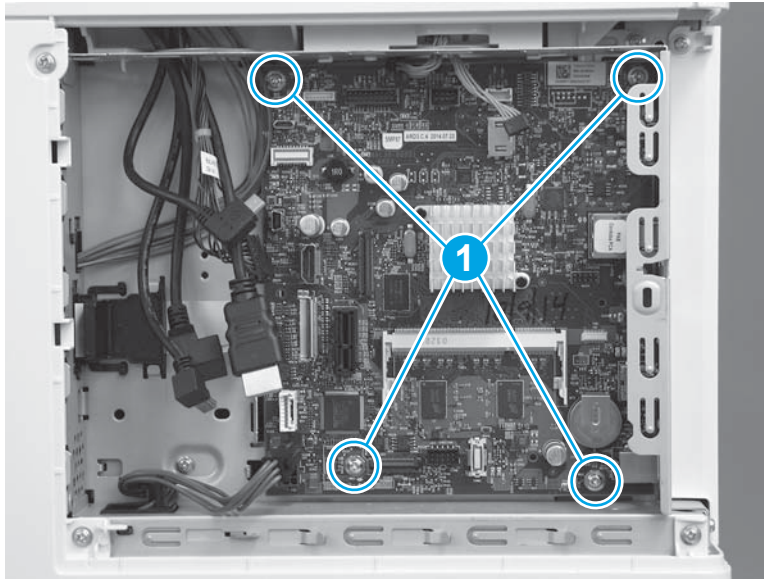

3. Connect all of the connectors on the formatter.

The following connectors are empty:

- All models: J1 (this connector is empty unless the optional DIMM is installed)
- All models: J3
- M577dn: J15 (this is the fax connector for the M577f/z/c models)
- All models: J21 (this connector is empty unless the optional internal USB ports component is installed)
- All models: J23
- All models: J24
- All models: J51
- All models: J57
- All models: J97
- All models: J98 (this connector is empty unless the optional trusted platform module (TPM) is installed)

 **IMPORTANT:** The flat-cable connector (callout 1) is a Zero Insertion Force (ZIF) connector that uses a hinged retainer to secure the flat cable. The hinged retainer must be opened to install the flat cable, and then closed after the cable is installed.

Figure 1-4246 Connect all connectors



Step 54: Install the fax PCA (M577c/f/z)

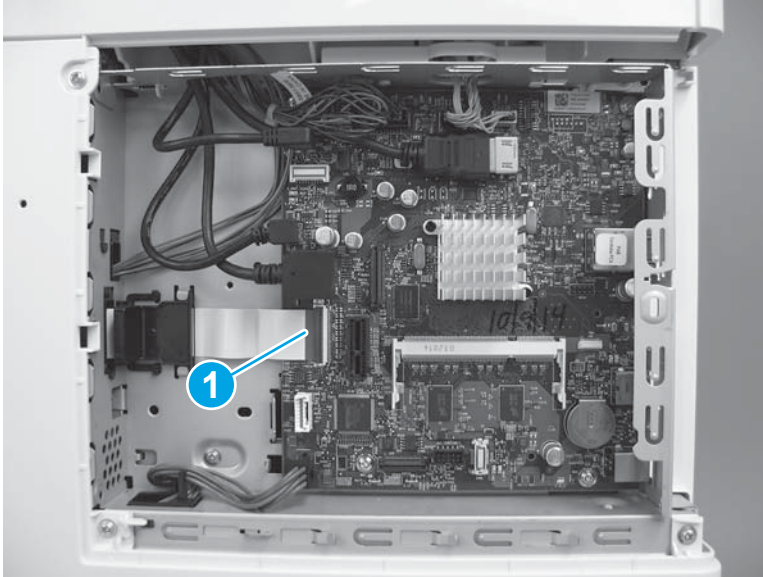

NOTE: This step is for the M577c/f/z models. For the M577n model, skip this step and go to [Step 55: Install the HDD \(M577\) on page 2361](#).

For the M552 and M553 models, skip this step and go to [Step 56: Install the formatter \(M552 and M553\) on page 2363](#).



CAUTION:  ESD-sensitive part.

1. Position the tab and telephone port (callout 1) on the fax PCA in the slots (callout 2) in the formatter case.

Figure 1-4247 Position the fax PCA

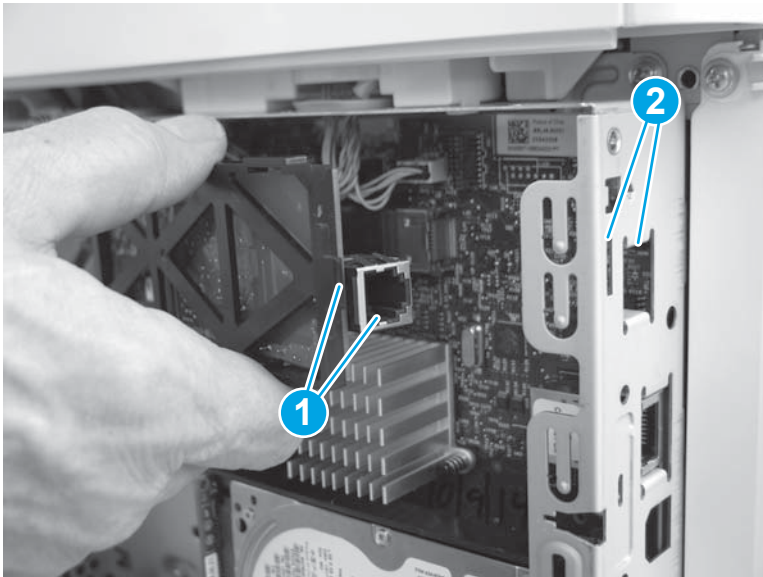

- Slide the fax PCA to the right (callout 1) until the tab and telephone port described in the previous step and seated in the formatter case. Position the retainer (callout 2) in the slot (callout 3) in the formatter. Rotate the end of the fax PCA toward the formatter (callout 4) until the retainer snaps into place.

Figure 1-4248 Install the fax PCA

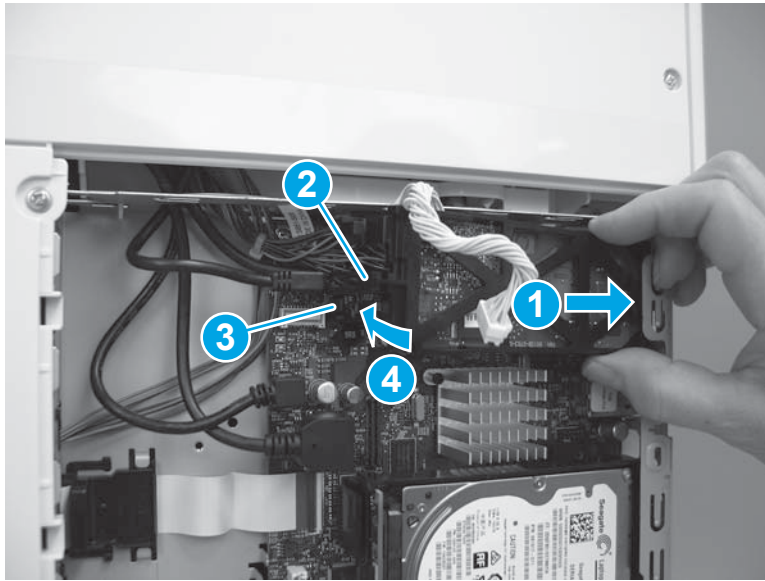

- Position the cable (callout 1) in the guide (callout 2), and then connect one connector (callout 3).

Figure 1-4249 Connect the connector

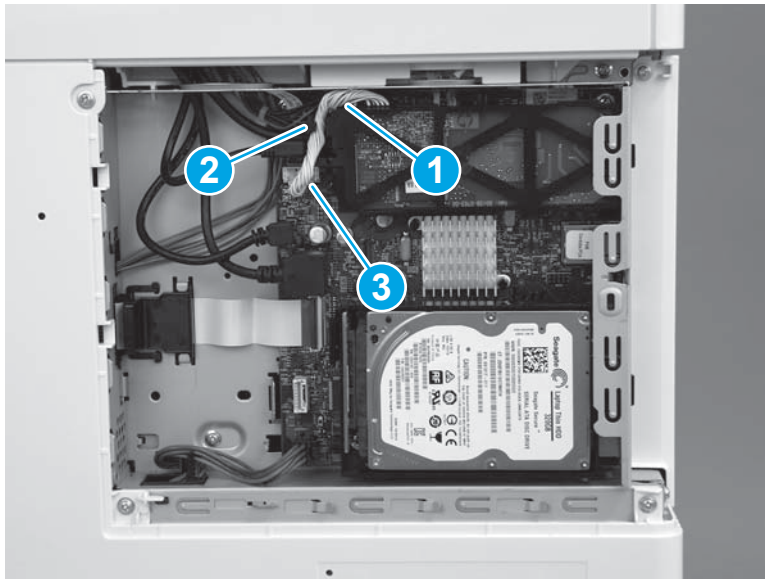

Step 55: Install the HDD (M577)

 **NOTE:** This step is for the M577 models. For the M552 and M553 models, skip this step and go to [Step 56: Install the formatter \(M552 and M553\) on page 2363](#).

 **CAUTION:**  ESD-sensitive part.

1. Align the end of the bracket (callout 1) with the slot in the chassis (callout 2), and then slide the HDD into the printer (callout 3) to engage the bracket with the chassis.

Figure 1-4250 Install the holder

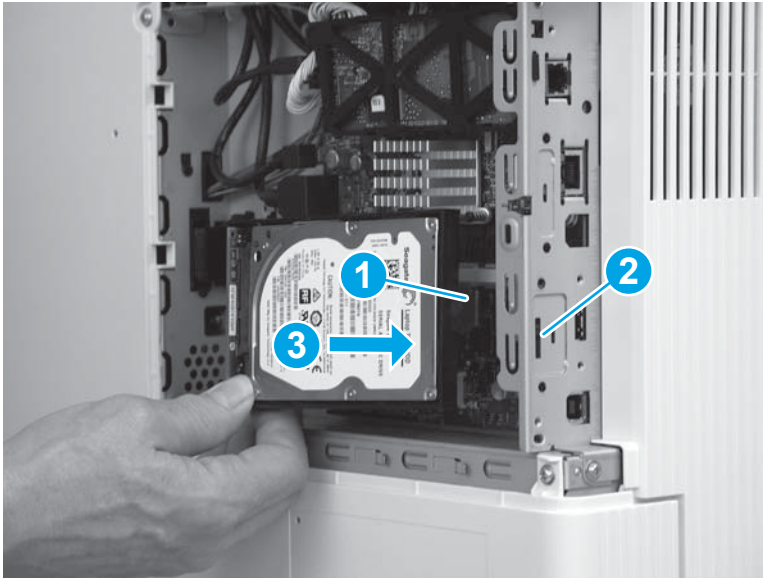

2. Hold the HDD connector latch (callout 1) in the released position, and then rotate the HDD down and into the connector on the formatter to install it.

 **NOTE:** Make sure that the tab (callout 2) snaps into place, and that the HDD is securely installed.

Figure 1-4251 Release the HDD

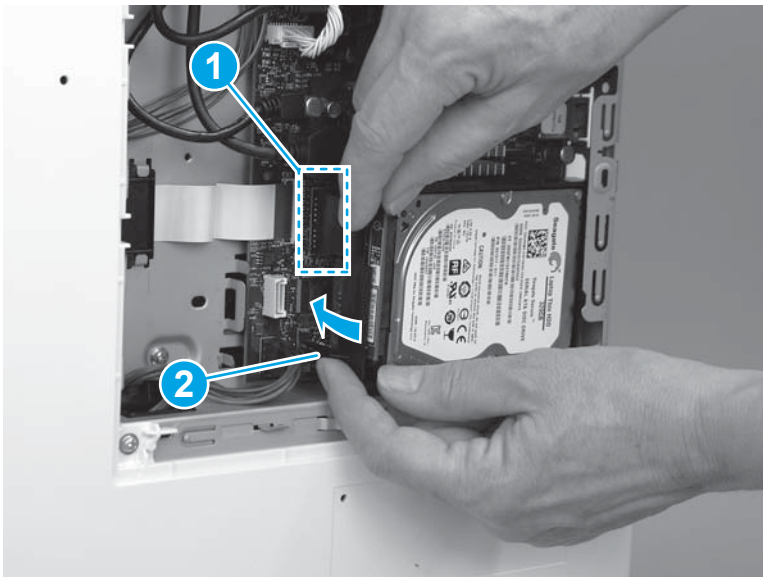

Step 56: Install the formatter (M552 and M553)

 **NOTE:** This step is for the M552 and M553 models. For the M577 models, skip this step and go to [Step 59: Install the formatter cover on page 2368](#).

If the optional hard-disk drive (HDD) was removed, do not forget to reinstall it after the formatter is reinstalled.

Engage the HDD holder with the chassis, rotate the HDD connector down and into the connector on the formatter. Make sure that the tabs snap into place.

 **CAUTION:**  ESD-sensitive part.

1. Position the formatter in the printer, and then install four screws (callout 1).

Figure 1-4252 Install the formatter

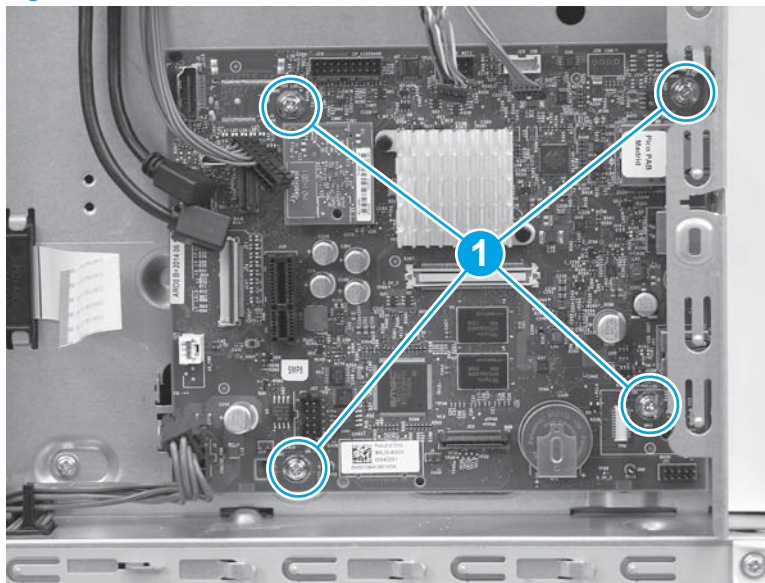

2. Connect all of the connectors on the formatter.

The following connectors are empty:

- All models: J1 (this connector is empty unless the optional DIMM is installed)
- M553n/dn and M552dn: J2 (callout 1; this is the touchscreen connector for the M553x model)
- All models: J9 (this connector is empty unless the optional internal USB ports component is installed)
- All models: J18 (this connector is empty unless the optional hard-disk-drive (HDD) is installed)
- All models: J23
- All models: J24
- M553n/dn and M552dn: J25 (this is the wireless connector for the M553x model)

- All models: J57
- All models: J98 (this connector is empty unless the optional trusted platform module (TPM) is installed)



 **IMPORTANT:** The flat-cable connector (callout 2) is a Zero Insertion Force (ZIF) connector that uses a hinged retainer to secure the flat cable. The hinged retainer must be opened to install the flat cable.

Figure 1-4253 Connect all connectors

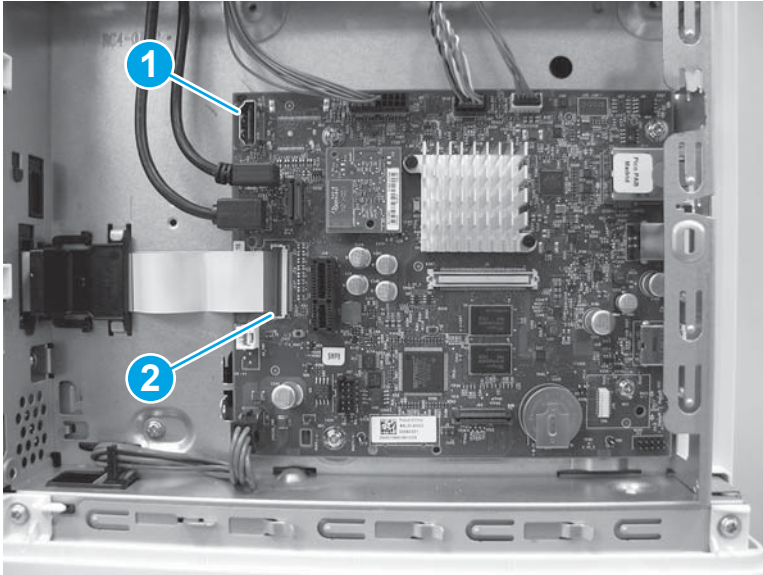

Step 57: Install the control-panel assembly (M553x only)

 **NOTE:** This step is for the M553x model. For the M553n/dn and M552dn models, skip this step and go to [Step 58: Install the USB cover \(M552 and M553\) on page 2367](#).

For the M577 models, skip this step and go to [Step 59: Install the formatter cover on page 2368](#).

1. Place the control panel on the printer as shown.

Figure 1-4254 Place the control panel on the product

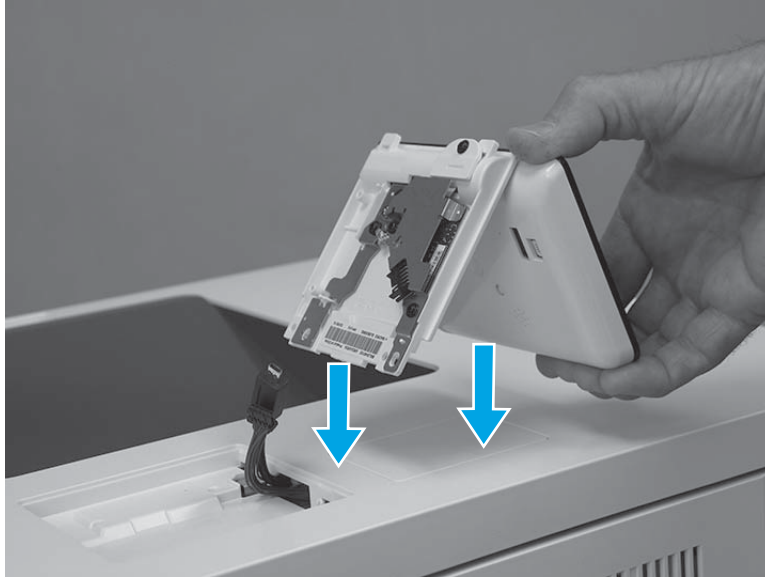

2. Connect one USB cable (callout 1), and one connector (callout 2).

 **IMPORTANT:** Take note of the location of the two mounting tabs (callout 3) on the control-panel assembly.

Figure 1-4255 Connect two connectors



3. Turn the control panel over, and then position the front edge tabs in the slots in the top cover.

Figure 1-4256 Turn the control panel over

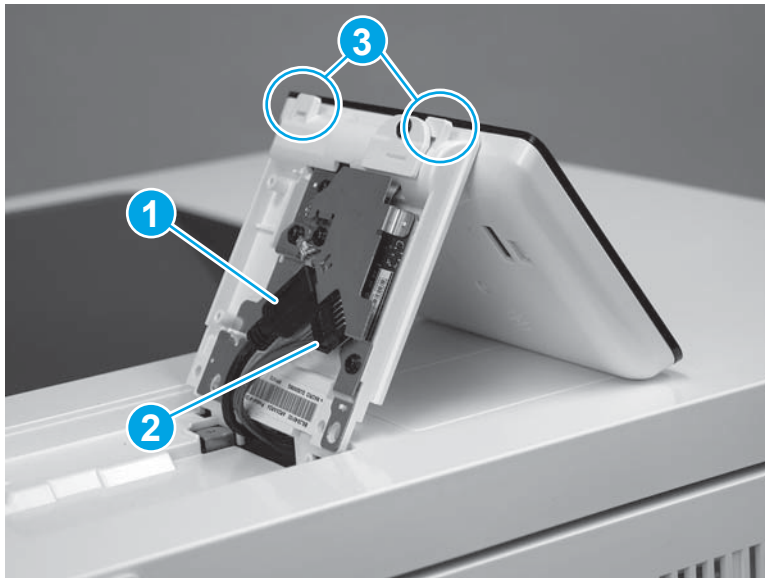
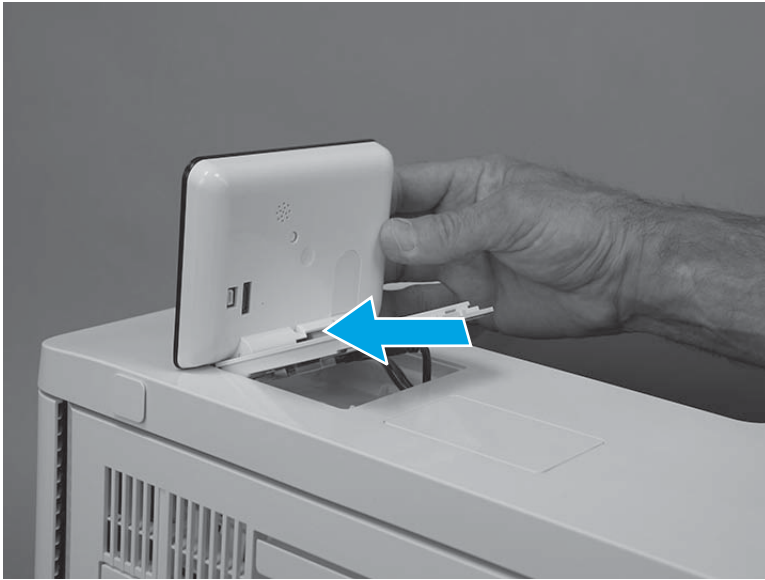

4. Rotate the control-panel base down onto the printer.

Figure 1-4257 Rotate the control-panel base down



5. Use a small Phillips screwdriver to install two screws (callout 1).

Figure 1-4258 Install two screws

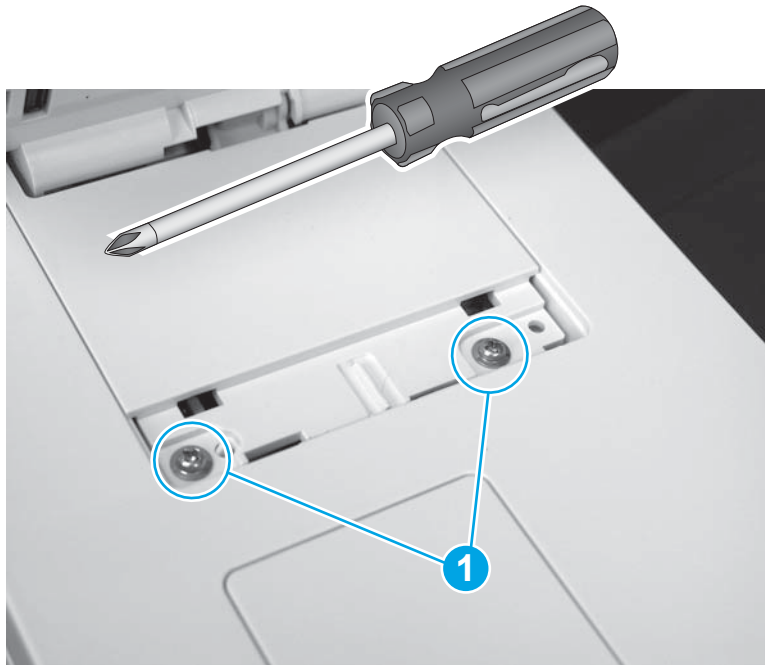

6. Position the screw cover mounting feet into the slots in the top cover (callout 1), and then rotate the cover down (callout 2) to install it.

 **NOTE:** Press down on the cover firmly to make sure that the tabs on the cover (callout 3) snap into place.

Figure 1-4259 Install the cover



Step 58: Install the USB cover (M552 and M553)

 **NOTE:** This step is for the M552 and M553 models. For the M577 models, skip this step and go to [Step 59: Install the formatter cover on page 2368](#).

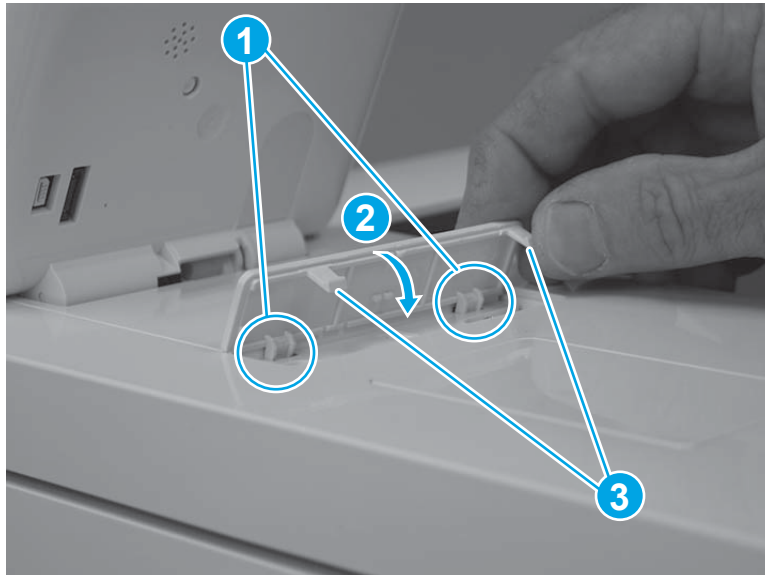
1. Push the cover into the USB port to install it.

Figure 1-4260 Install the cover



2. Make sure that the USB cover is fully seated after installing it.

Figure 1-4261 Check the installation



Step 59: Install the formatter cover

- ▲ Slide the cover onto the printer (callout 1) to install it.

 **NOTE:** Make sure that the tabs on the formatter cover align with the slots provided in the printer (callout 2). Tighten the two thumbscrews (callout 3).

 **TIP:** If needed, use the edge of a coin to turn the thumbscrews.

Figure 1-4262 Install the cover



Step 60: Install the TCU

1. Verify that the toner collection hatch cover is in the closed position on the TCU.

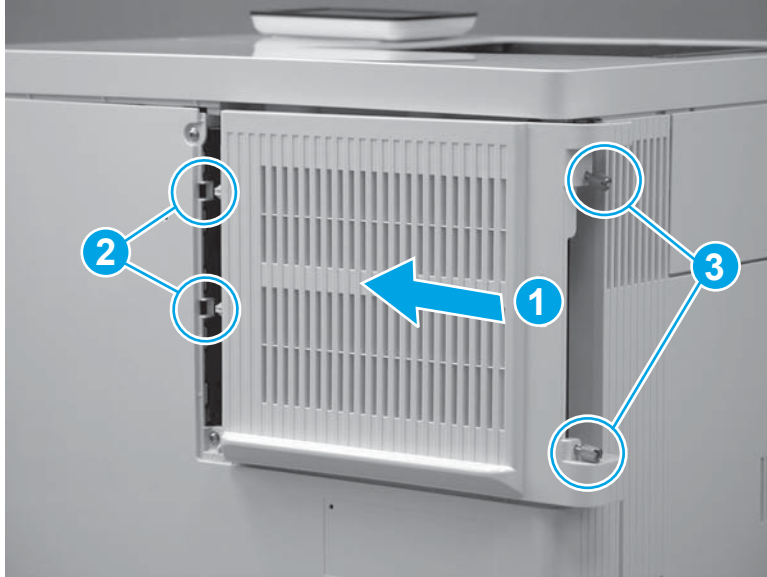
Figure 1-4263 Verify that the toner collection hatch cover is closed

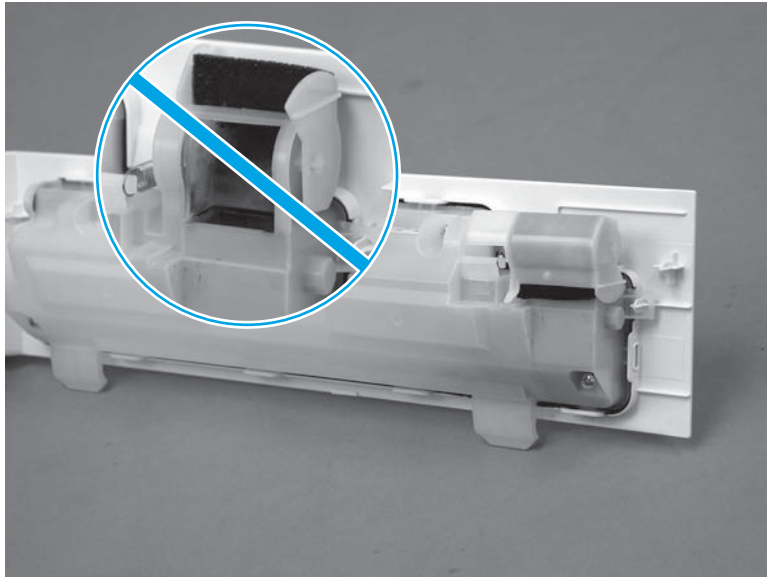

2. Position the TCU with the hinges in the slots provided in the printer (callout 1), and then rotate the TCU up and into the closed position.

 **NOTE:** The toner collection hatch cover automatically opens when the TCU is closed.

Figure 1-4264 Install the TCU



3. Close the front door.

Figure 1-4265 Close the front door

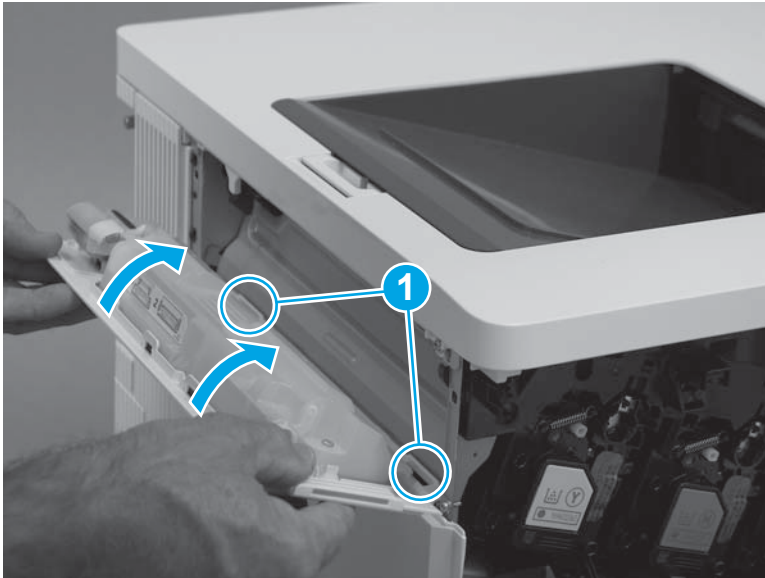

Step 61: Install the tray

1. With the front of the tray slightly lifted, align the sides of the tray with the rails in the printer, and then carefully slide the tray into the printer.

 **TIP:** As the tray slides into the printer, lower the front of it.

Figure 1-4266 Install the tray



2. Close the tray.

Figure 1-4267 Close the tray



Step 62: Install the ITB

CAUTION: Do not touch the grey-plastic belt. Skin oils and fingerprints on the belt can cause print-quality problems.

1. Handle the ITB by the edges. Do not touch the grey-plastic belt. Skin oils and fingerprints on the belt can cause print-quality problems.

Figure 1-4268 Handle the ITB by the edges

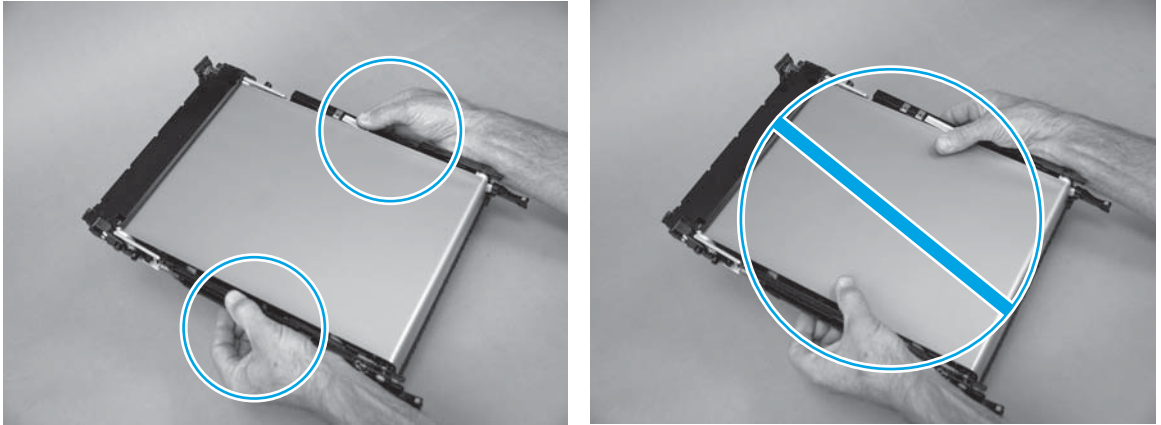

2. Align the ITB with the slots in the printer, and then carefully push it into the printer.

 **NOTE:** Be careful. Do not dislodge the ITB retainer springs from the holders on the chassis. The springs can interfere with installing the ITB.

Figure 1-4269 Align the ITB with the slots in the product

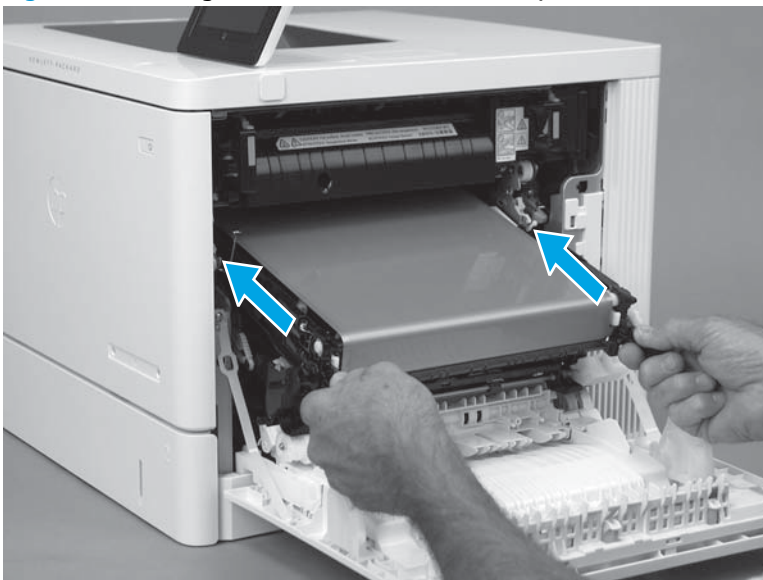

3. Continue to carefully push the ITB into the printer until it is fully installed.

Figure 1-4270 Install the ITB

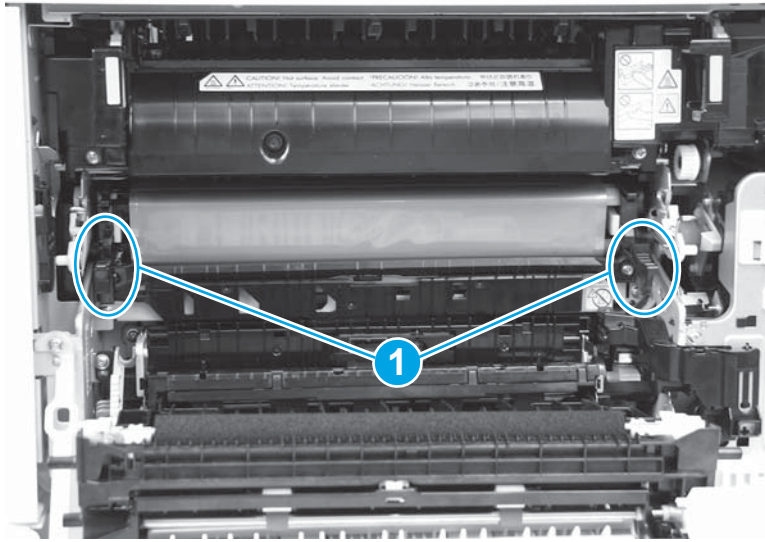

4. Remove the right-side ITB spring from the holder.

Figure 1-4271 Remove the spring from the holder

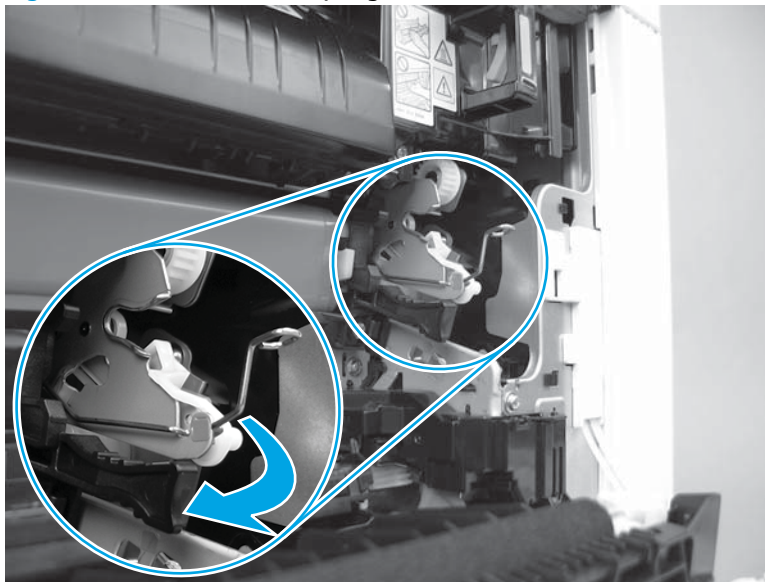

5. Fasten the right-side ITB spring (callout 1) under the tab (callout 2).

Figure 1-4272 Fasten the rear-side ITB spring

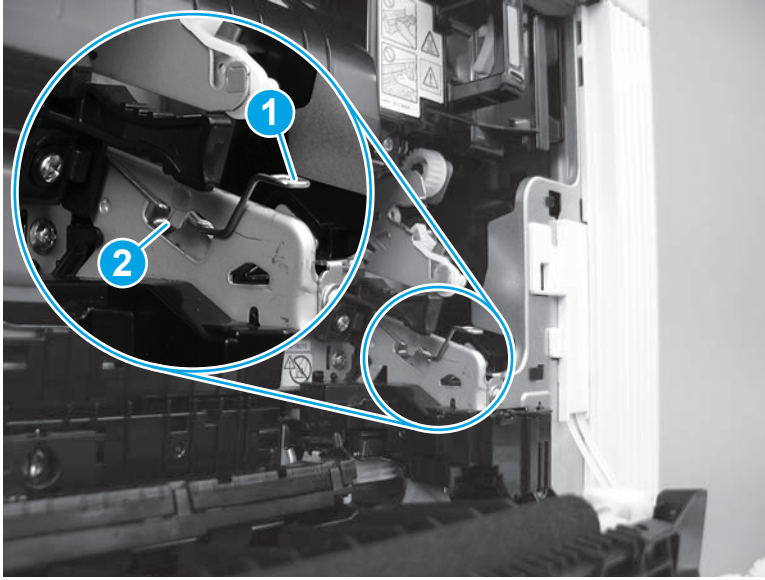

6. Remove the left-side ITB spring from the holder.

Figure 1-4273 Remove the spring from the holder

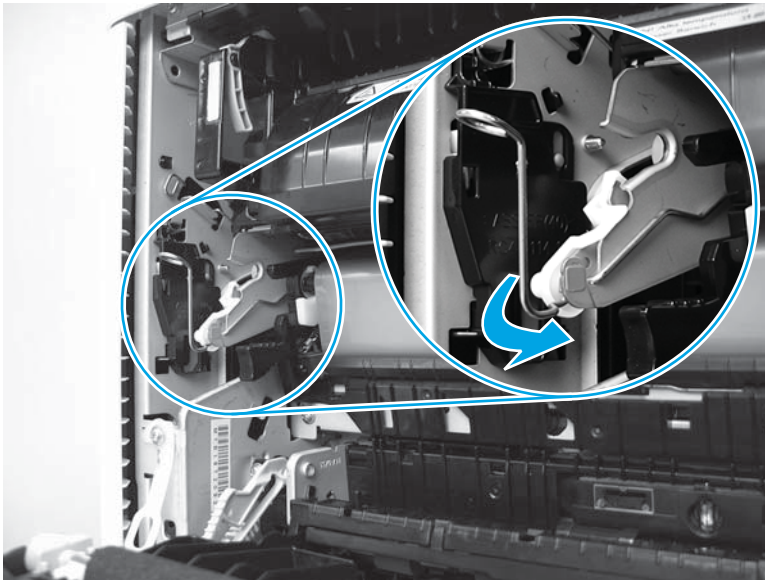

7. Fasten the left-side ITB spring (callout 1) under the tab (callout 2).

Figure 1-4274 Fasten the front-side ITB spring

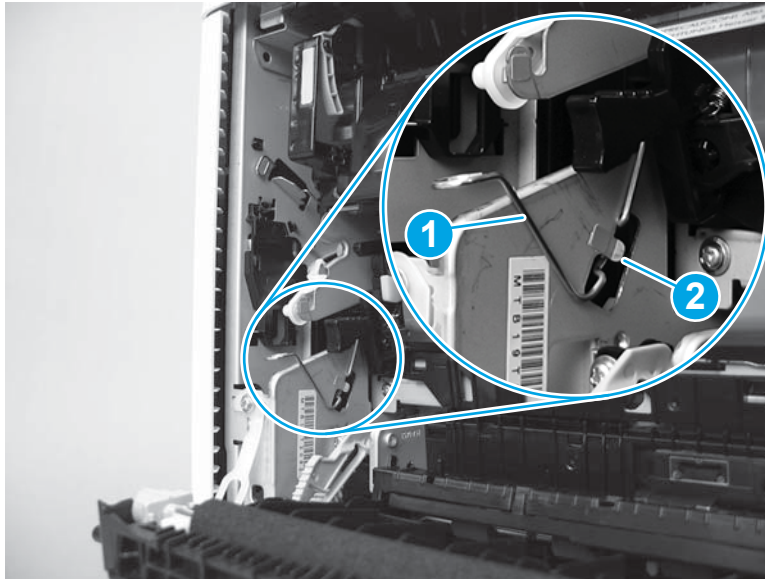

8. Push in the blue lever to engage the ITB drive coupling.

Figure 1-4275 Engage the ITB drive coupling

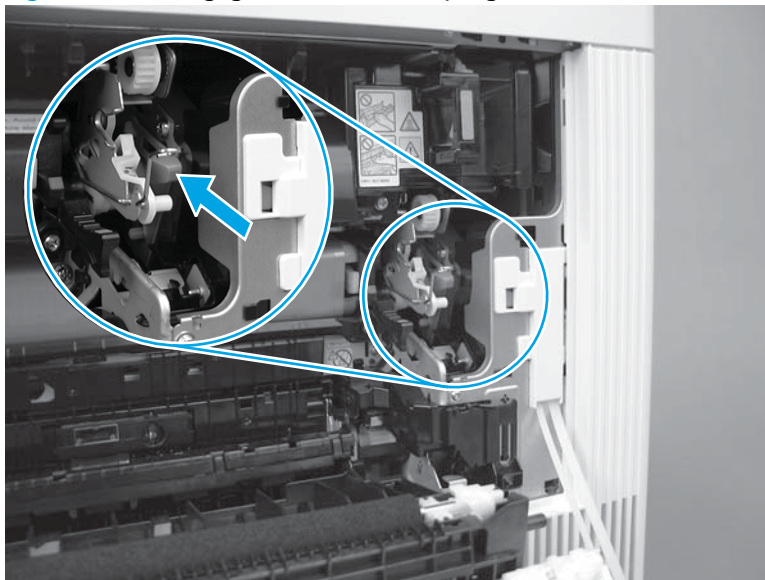

9. Close the right door.

 **TIP:** The right door should close easily if the ITB assembly is correctly installed.

Figure 1-4276 Close the right door



Step 63: Install the secondary transfer roller assembly

1. Move the registration sensor assembly (callout 1) out of the way, and then position the secondary transfer assembly right hinge (callout 2) into the hole provided in the printer.

Figure 1-4277 Install the right hinge

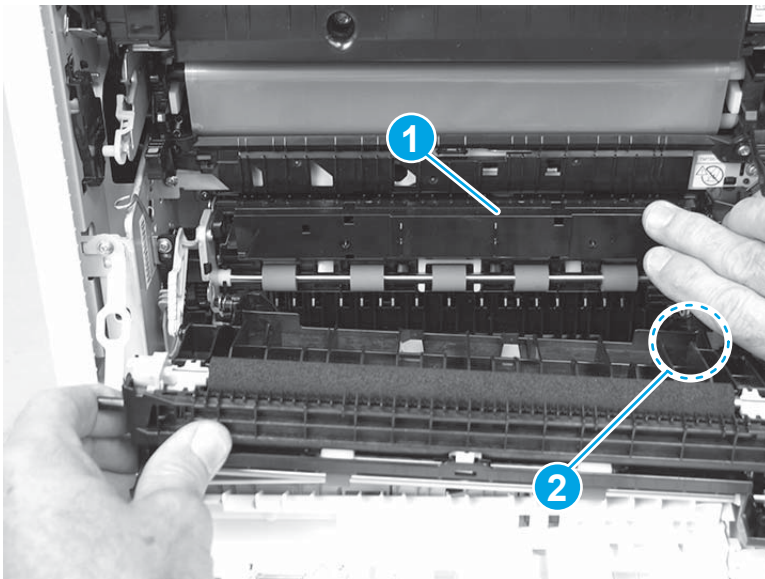

2. Position the assembly left-side hinge near the hole provided in the printer, and then slide the assembly toward the front of the printer to install the hinge in the hole.

Figure 1-4278 Install the left hinge

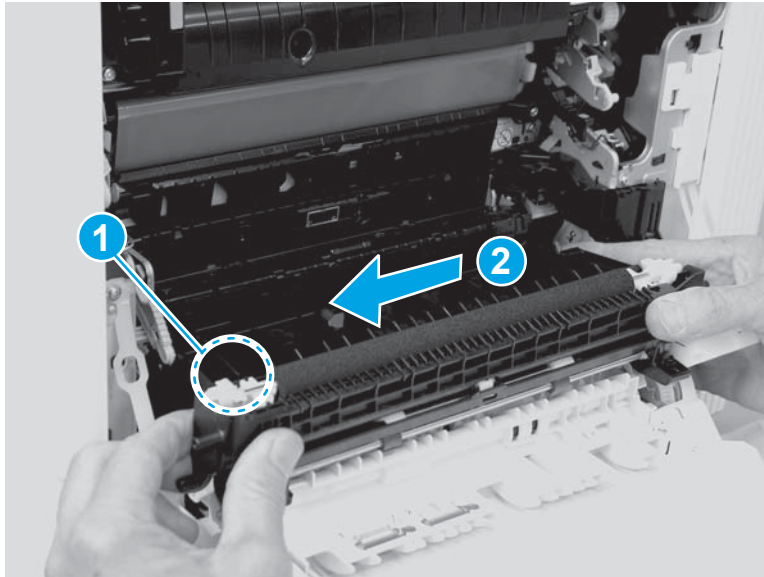

3. Carefully flex the blue arm, and then push it over the pin on the assembly to engage it.

 **NOTE:** Make sure that the pin is correctly installed in the slot on the blue arm.

Figure 1-4279 Engage the blue arm with the pin

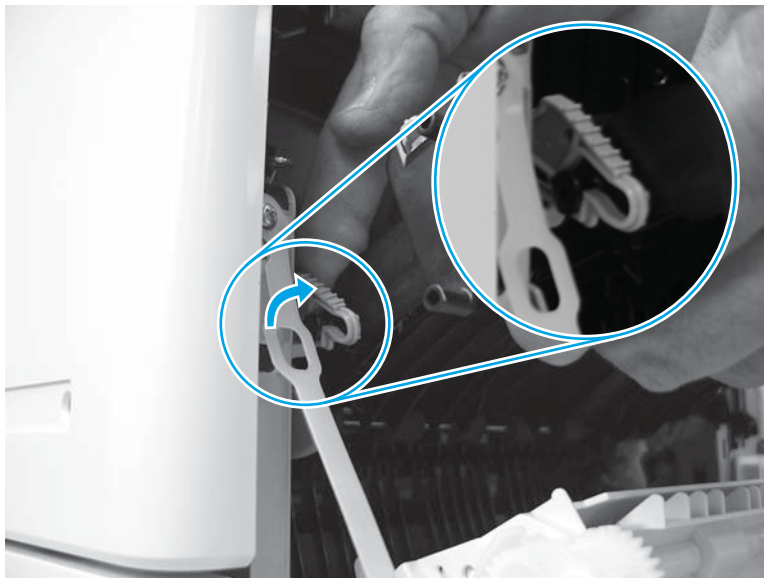

4. Close the right door.

 **TIP:** The right door should close easily if the secondary transfer assembly is correctly installed.

Figure 1-4280 Close the right door



Removal and replacement: Density-detect assembly

- [Introduction](#)
- [Step 1: Remove the secondary transfer roller assembly](#)
- [Step 2: Remove the ITB](#)
- [Step 3: Remove the tray](#)
- [Step 4: Remove the toner collection unit \(TCU\)](#)
- [Step 5: Remove the formatter cover](#)
- [Step 6: Remove the USB cover \(M552 and M553\)](#)
- [Step 7: Remove the control panel \(M553x only\)](#)
- [Step 8: Remove the formatter \(M552 and M553\)](#)
- [Step 9: Remove the hard-disk drive \(HDD\) \(M577\)](#)
- [Step 10: Remove the fax PCA \(M577c/f/z\)](#)
- [Step 11: Remove the formatter \(M577\)](#)
- [Step 12: Remove the rear cover \(M552 and M553\)](#)
- [Step 13: Remove the rear upper cover \(M577\)](#)
- [Step 14: Remove the rear cover \(M577\)](#)
- [Step 15: Remove the left upper cover \(M577\)](#)
- [Step 16: Remove the right front upper cover \(M577dn\)](#)
- [Step 17: Remove the stapler cover assembly \(M577c/f/z\)](#)
- [Step 18: Remove the integrated scanner assembly \(ISA\) \(M577\)](#)
- [Step 19: Remove the right upper cover \(M577dn\)](#)
- [Step 20: Remove the left cover](#)
- [Step 21: Remove the upper cover \(M552 and M553\)](#)
- [Step 22: Remove the right rear cover](#)
- [Step 23: Remove the formatter case](#)
- [Step 24: Remove the low-voltage power supply \(LVPS\)](#)
- [Step 25: Remove the power supply fan \(FM1\)](#)
- [Step 26: Remove the high-voltage power supply D \(HVPSD\)](#)
- [Step 27: Remove the lifter drive assembly](#)
- [Step 28: Remove the DC controller and sheet-metal bracket](#)
- [Step 29: Remove the pickup drive assembly and motor \(M5\)](#)

- [Step 30: Remove the registration assembly](#)
- [Step 31: Remove the density-detect assembly](#)
- [Step 32: Unpack the replacement assembly](#)
- [Step 33: Install the density-detect assembly](#)
- [Step 34: Install the registration assembly](#)
- [Step 35: Install the pickup drive assembly and motor \(M5\)](#)
- [Step 36: Install the DC controller and sheet-metal bracket](#)
- [Step 37: Install the lifter drive assembly](#)
- [Step 38: Install the HVPSD](#)
- [Step 39: Install the power-supply fan \(FM1\)](#)
- [Step 40: Install the LVPS](#)
- [Step 41: Install the formatter case](#)
- [Step 42: Install the right rear cover](#)
- [Step 43: Install the upper cover \(M552 and M553\)](#)
- [Step 44: Install the left cover](#)
- [Step 45: Install the right upper cover \(M577\)](#)
- [Step 46: Install the integrated scanner assembly \(ISA\) \(M577\)](#)
- [Step 47: Install the stapler cover assembly \(M577c/f/z\)](#)
- [Step 48: Install the right front upper cover \(M577dn\)](#)
- [Step 49: Install the left upper cover \(M577\)](#)
- [Step 50: Install the rear cover \(M577\)](#)
- [Step 51: Install the rear upper cover \(M577\)](#)
- [Step 52: Install the rear cover \(M552 and M553\)](#)
- [Step 53: Install the formatter \(M577\)](#)
- [Step 54: Install the fax PCA \(M577c/f/z\)](#)
- [Step 55: Install the HDD \(M577\)](#)
- [Step 56: Install the formatter \(M552 and M553\)](#)
- [Step 57: Install the control-panel assembly \(M553x only\)](#)
- [Step 58: Install the USB cover \(M552 and M553\)](#)
- [Step 59: Install the formatter cover](#)
- [Step 60: Install the TCU](#)

- [Step 61: Install the tray](#)
- [Step 62: Install the ITB](#)
- [Step 63: Install the secondary transfer roller assembly](#)

Introduction

This document provides the procedures to remove and replace the registration density-detect assembly.

Before performing service

 **TIP:** Some figures might show assemblies removed or installed that have not yet been removed or installed at that specific step. However, the procedures are correct for this printer and the target assembly. Always thoroughly read the instructions that accompany each figure.

Turn the printer power off

- Disconnect the power cable.

 **WARNING!** To avoid damage to the printer, turn the printer off, wait 30 seconds, and then remove the power cord before attempting to service the printer.

Use the table below to identify the correct part number for your printer, and then go to <http://h20141.www2.hp.com/hpparts> to order the part.

Density-detect assembly part number	
RM2-7160-000CN	Density-detect assembly

Required tools

- #2 Phillips screwdriver with a magnetic tip

After performing service

Make sure that all of the connectors on the LVPS are fully seated.

Make sure that all of the connectors on the HVPSD are fully seated.

Make sure that all of the connectors on the DC controller are fully seated.

Make sure that the TCU is fully closed after replacing it.

Make sure that all of the connectors on the formatter are fully seated.

Make sure that the formatter cover is fully seated, and that the thumbscrews are finger tight after replacing it.

Use the [Device Maintenance](#) menu to perform a [Full Calibration](#). For more information, see the printer troubleshooting manual.

Turn the printer power on

- Connect the power cable.
- Use the power switch to turn the power on.

Post service test

Use the [Troubleshooting](#) menu to perform a [Color Band Test](#). For more information, see the printer troubleshooting manual.

Print a configuration page to make sure that the printer is functioning correctly.

Step 1: Remove the secondary transfer roller assembly

1. Open the right door.

Figure 1-4281 Open the right door



2. Release the blue arm, and then let the secondary transfer assembly rotate down to the half-way open position.

 **NOTE:** The assembly should stop at the halfway down point—the pin will stop at the notch in the slot in the blue arm.

Figure 1-4282 Release the secondary transfer roller assembly



3. Carefully flex the top portion of the blue arm—as shown in the figure—to start to disengage it from the pin.

Figure 1-4283 Carefully flex the top portion of the blue arm

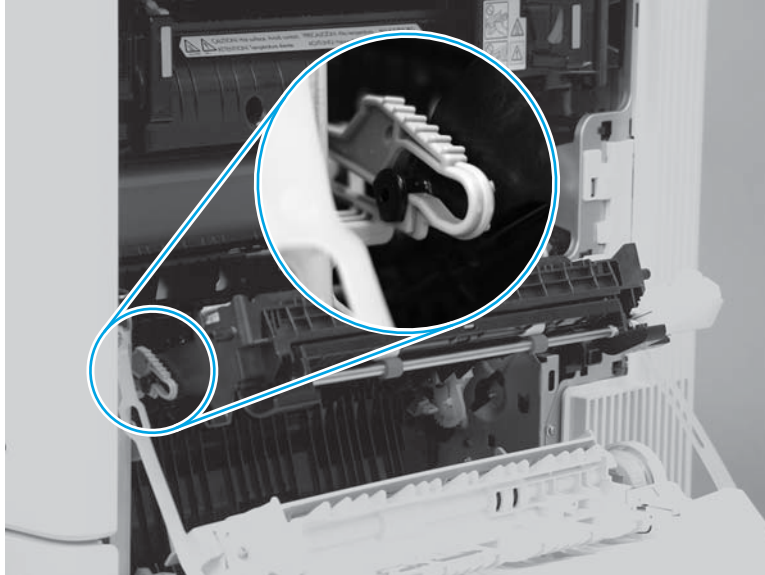

4. Continue to flex the blue arm until it disengages from the pin.

Figure 1-4284 Disengage the blue arm and pin



5. Slide the assembly toward the front of the printer to release it (callout 1), and then rotate it down and away from the printer to remove it (callout 2).



 **Reinstallation tip:** Before removing the assembly, take note of where the assembly hinge pins fit into the holes provided in the printer.

Figure 1-4285 Remove the secondary transfer roller assembly

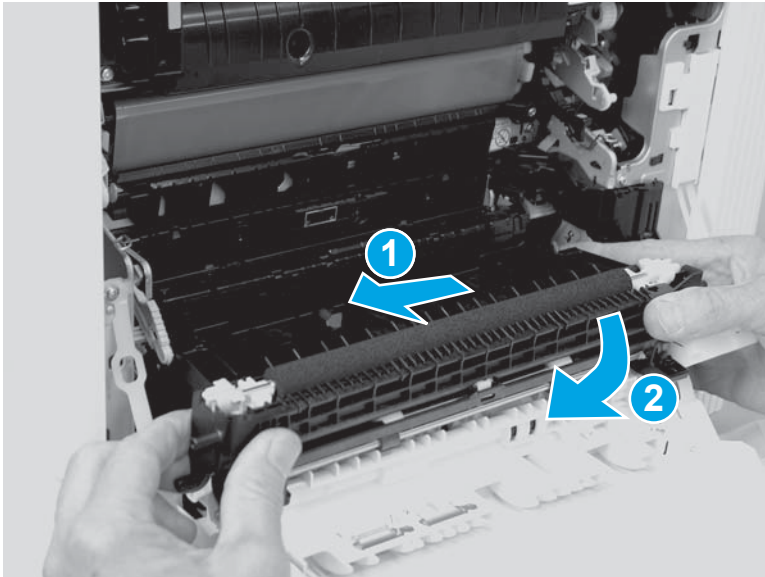

Step 2: Remove the ITB

 **CAUTION:** Do not touch the grey-plastic belt. Skin oils and fingerprints on the belt can cause print-quality problems.

1. Open the right door.

Figure 1-4286 Open the right door



2. Pull the blue lever to release the ITB drive coupling.

Figure 1-4287 Release the ITB drive coupling

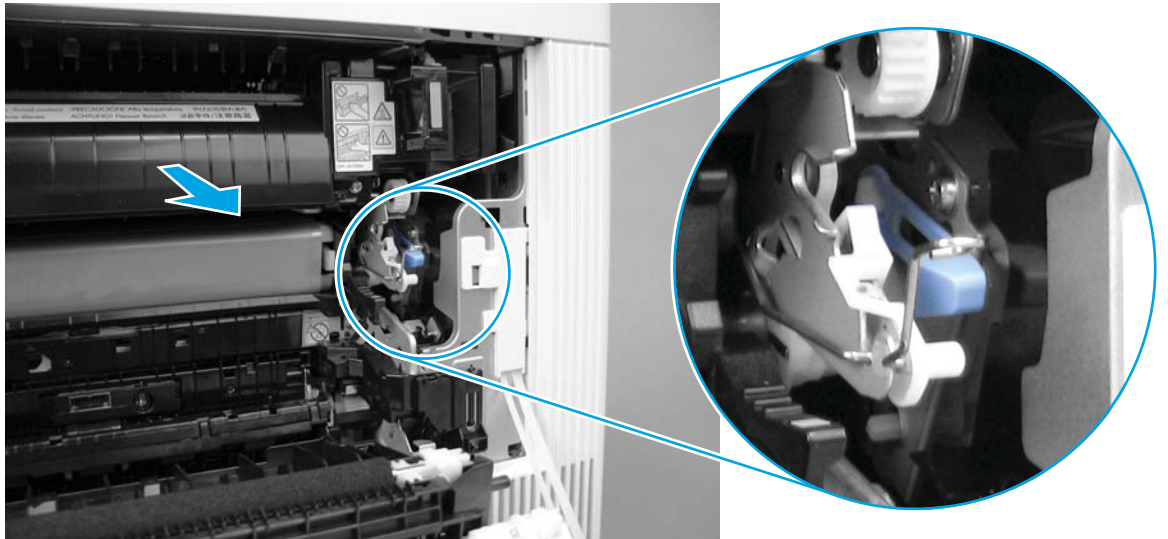

3. Push in on the blue arm to release the secondary transfer roller assembly, and then completely lower the assembly.

 **NOTE:** Press the blue arm on the secondary transfer roller assembly a second time to release the roller assembly when it stops at the halfway open position.

Figure 1-4288 Lower the secondary transfer roller assembly



4. Release the left-side ITB spring (callout 1) from the tab (callout 2).

Figure 1-4289 Release the front-side ITB spring

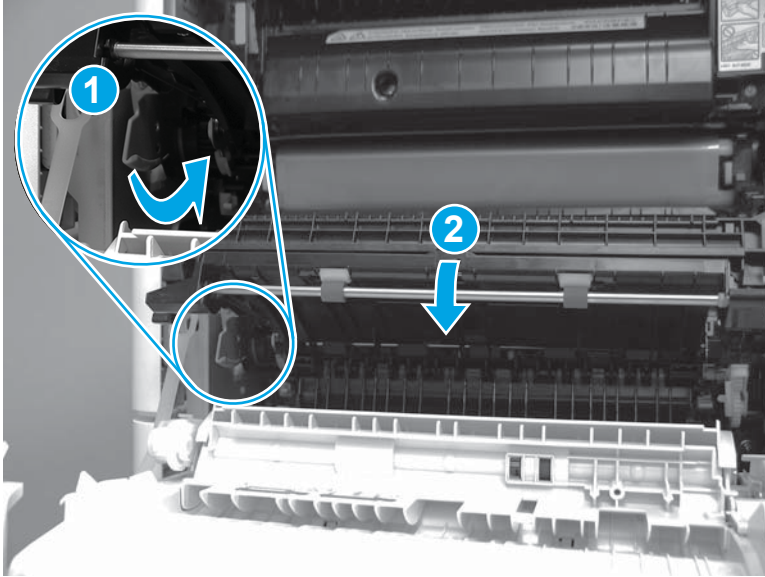
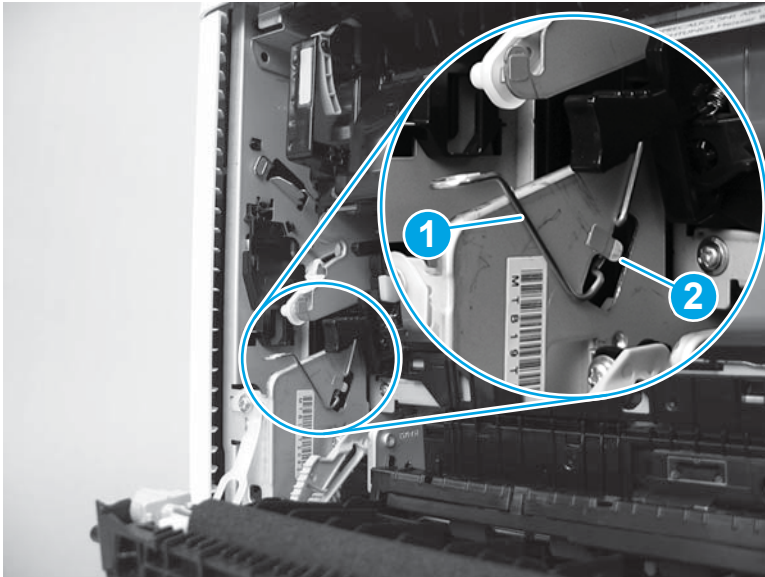

5. Place the left-side ITB spring on the holder to keep it out of the way.

 **TIP:** The holder is colored blue to help locate it.

Figure 1-4290 Place the spring on the holder

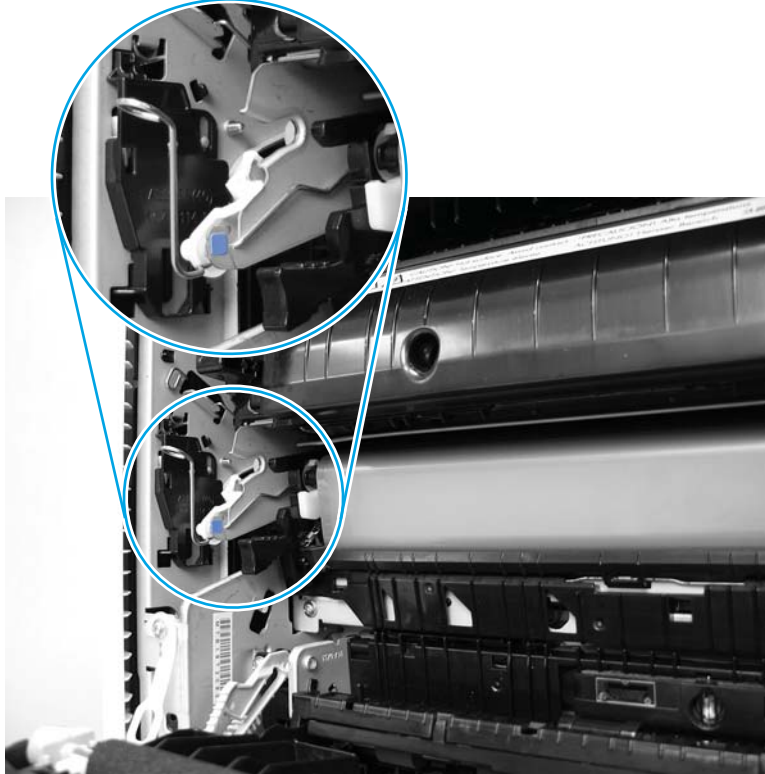

6. Release the right-side ITB spring (callout 1) from the tab (callout 2).

Figure 1-4291 Release the rear-side ITB spring

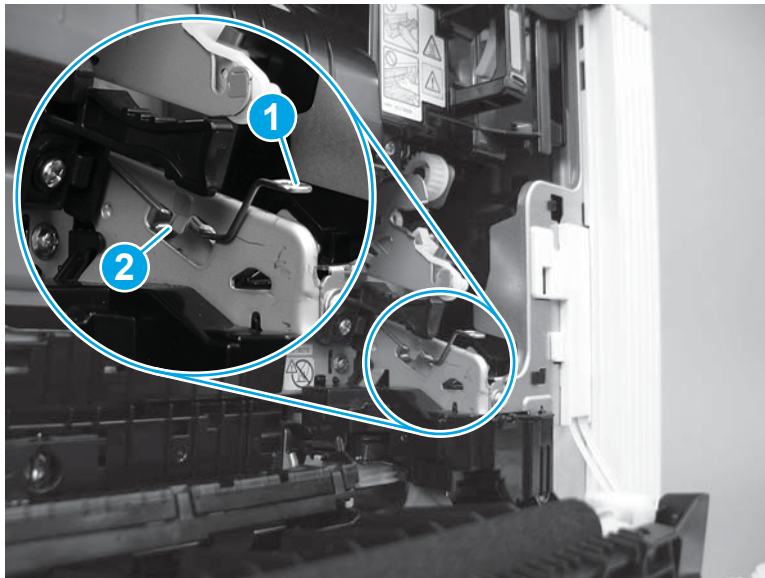

7. Place the right-side ITB spring on the holder to keep it out of the way.

 **TIP:** The holder is colored blue to help locate it.

Figure 1-4292 Place the spring on the holder

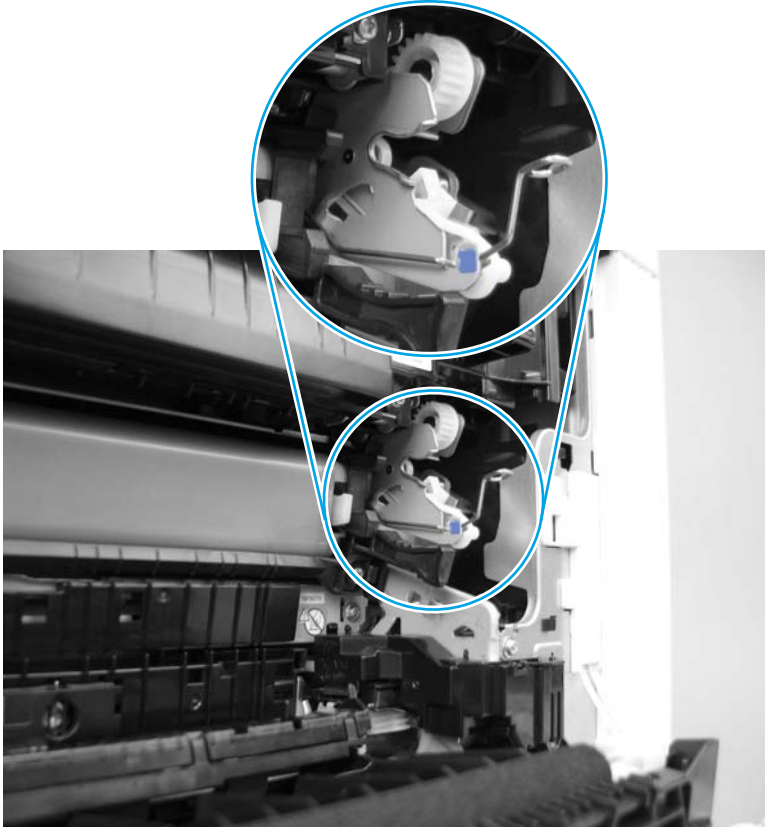

8. Grasp the two blue handles on the ITB.

⚠ CAUTION: If the ITB is removed to access other assemblies in the printer, use care. The ITB is a sensitive assembly. Be careful when handling the ITB so that it is not damaged. Always place the ITB in a safe and protected location.

Figure 1-4293 Grasp the ITB handles

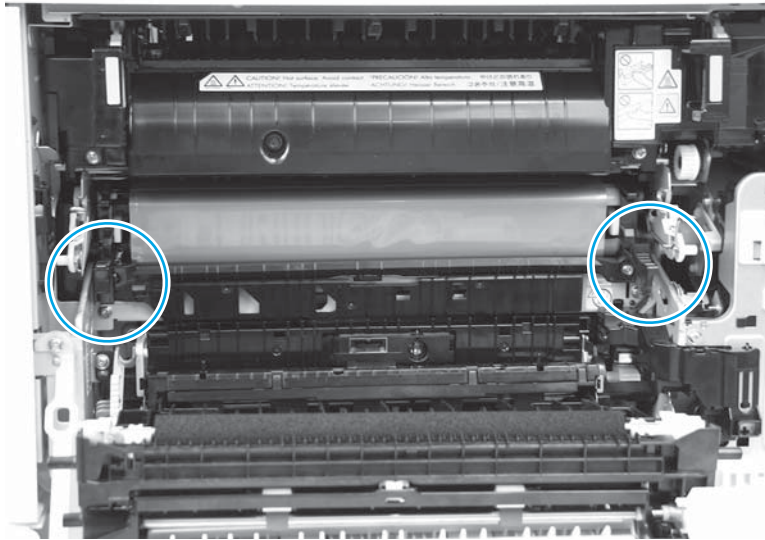

9. Pull the ITB out of the printer to remove it.

⚠ CAUTION: Do not touch the grey-plastic belt. Skin oils and fingerprints on the belt can cause print-quality problems.

Figure 1-4294 Remove the ITB



Step 3: Remove the tray

1. Pull the tray out until it stops.

Figure 1-4295 Pull the tray out



2. Lift the front of the tray, and then pull it out of the printer to remove it.

Figure 1-4296 Remove the tray

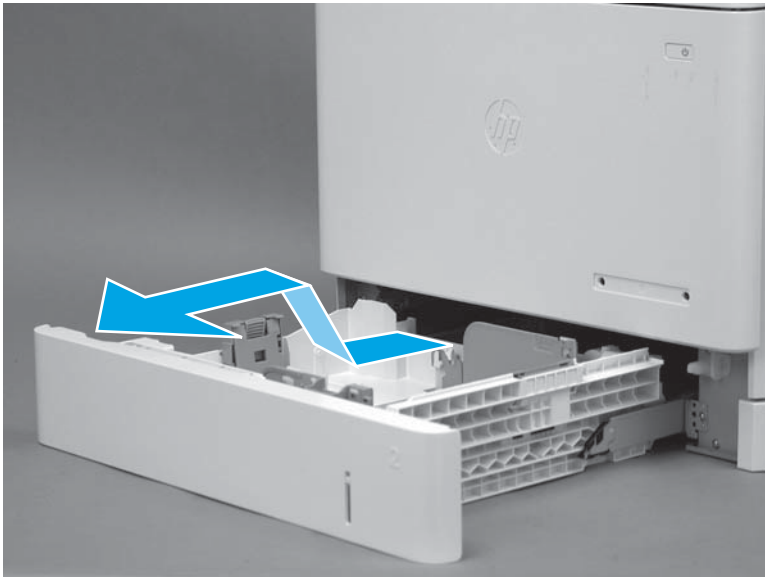

Step 4: Remove the toner collection unit (TCU)

1. Open the front door.

Figure 1-4297 Open the front door



2. Open the TCU.

 **NOTE:** The toner collection hatch cover automatically closes when the TCU is opened.

Figure 1-4298 Open the TCU



3. Pull the TCU away from the printer at an angle to remove it.

⚠ CAUTION: Do not open the toner collection hatch cover when handling the TCU. If toner gets on clothing, wipe it off by using a dry cloth and wash the clothes in cold water. Hot water sets toner into fabric.

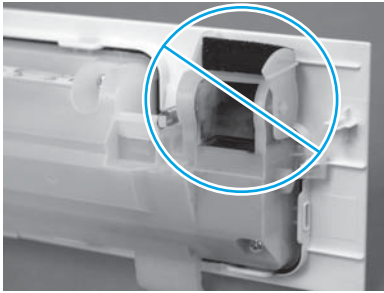
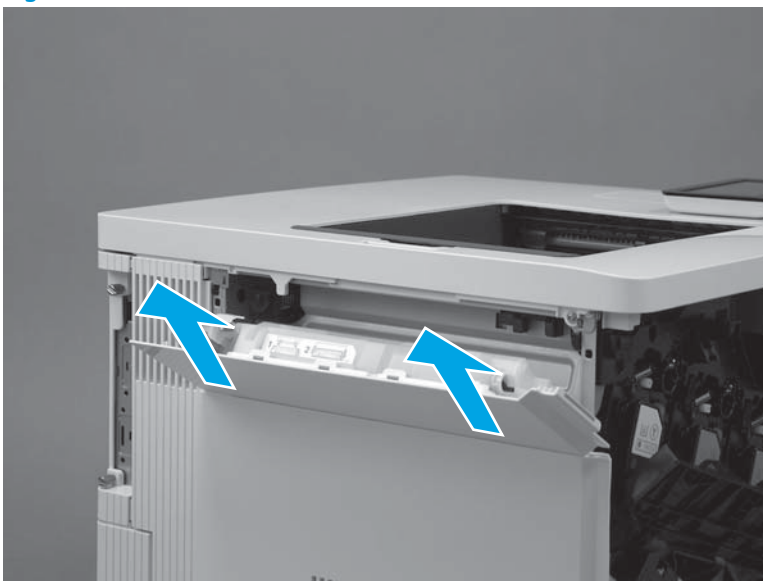

Figure 1-4299 Remove the TCU



Step 5: Remove the formatter cover

1. Locate the formatter cover.

Figure 1-4300 Locate the formatter cover

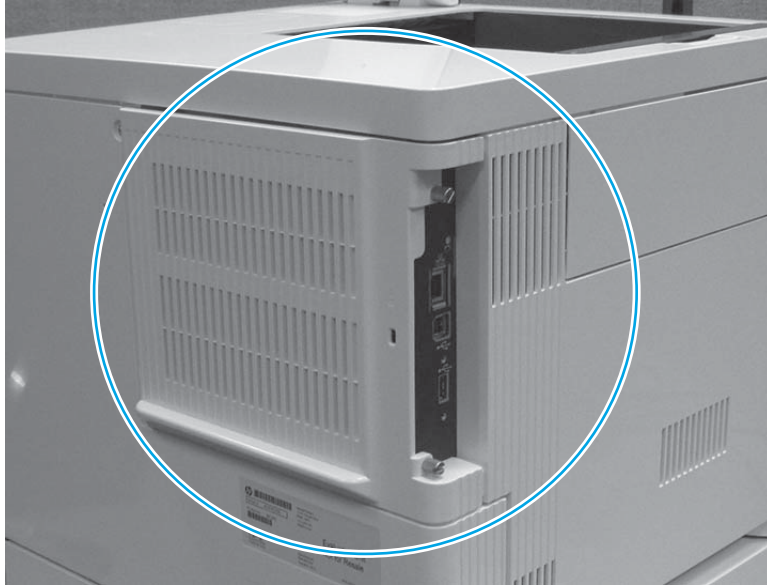

2. Loosen the two thumbscrews (callout 1). Grasp the two thumbscrews, and then slide the cover away from the printer (callout 2) to remove it.



 **TIP:** If needed, use the edge of a coin to turn the thumbscrews.

Figure 1-4301 Loosen the thumbscrews

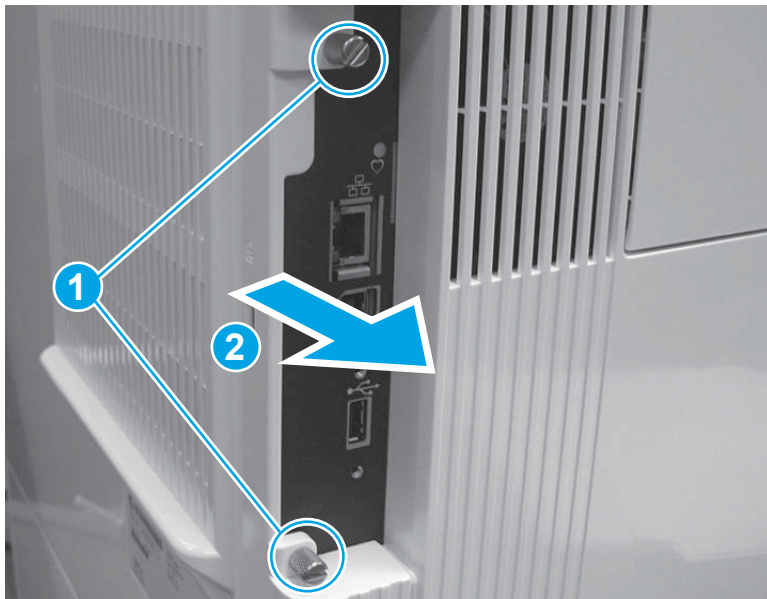

Step 6: Remove the USB cover (M552 and M553)

 **NOTE:** This step is for the M552 and M553 models. For the M577 models, skip this step and go to [Step 9: Remove the hard-disk drive \(HDD\) \(M577\) on page 2399](#).

1. Locate the USB cover.

Figure 1-4302 Locate the USB cover



2. Pull the cover off of the printer to remove it.

Figure 1-4303 Remove the cover



Step 7: Remove the control panel (M553x only)

 **NOTE:** For the M553n/dn and M552dn models, skip this step and go to [Step 8: Remove the formatter \(M552 and M553\) on page 2398](#).

For the M577 models, skip this step and go to [Step 9: Remove the hard-disk drive \(HDD\) \(M577\) on page 2399](#).

1. Tilt the control panel up.

Figure 1-4304 Tilt the control panel up



2. Use a small flat-blade screwdriver to release the control-panel screws cover tabs.

Figure 1-4305 Release the control-panel screws cover tabs



3. Rotate the cover up to remove it.

Figure 1-4306 Remove the cover



4. Use a small Phillips screwdriver to remove two screws (callout 1).

 **IMPORTANT:** Store the screws in a secure place where they cannot fall down into the printer.

Figure 1-4307 Remove two screws

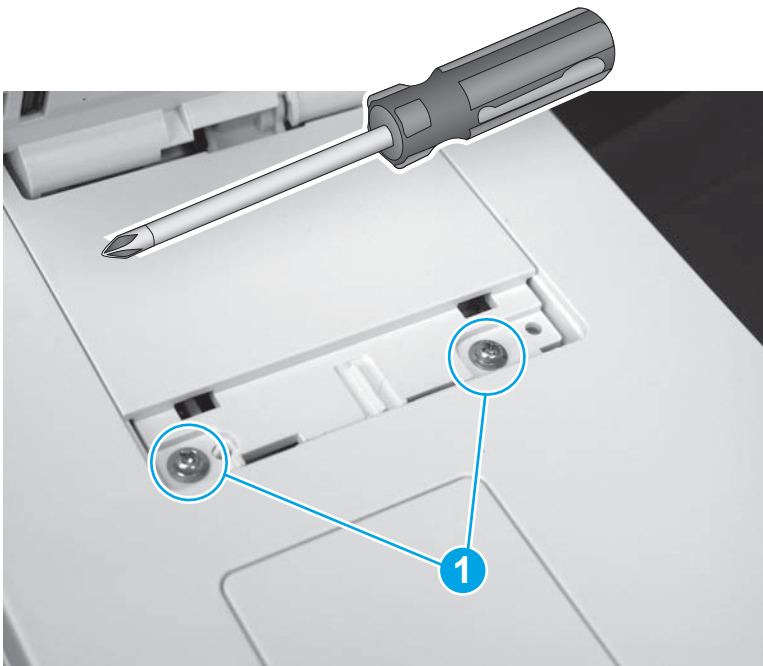

5. Rotate the control-panel base toward the front of the printer.

Figure 1-4308 Rotate the control-panel base up



6. Slightly slide the control-panel base toward the rear of the printer (callout 1) to release it, and then turn the control panel over (callout 2) to access the bottom side.

⚠ CAUTION: The control panel is still attached to the printer. Do not attempt to completely remove the control panel.

Figure 1-4309 Turn the control panel over

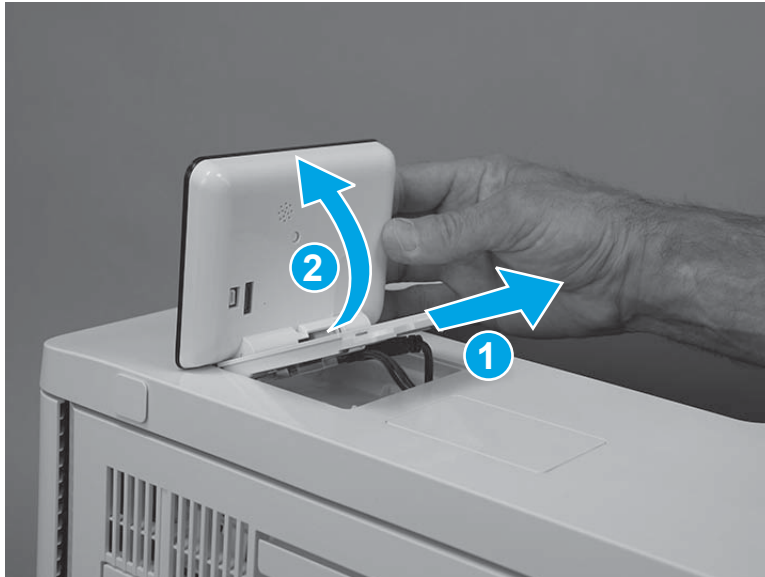

7. Disconnect one USB cable (callout 1), one connector (callout 2), and then remove the control panel.

Figure 1-4310 Disconnect two connectors

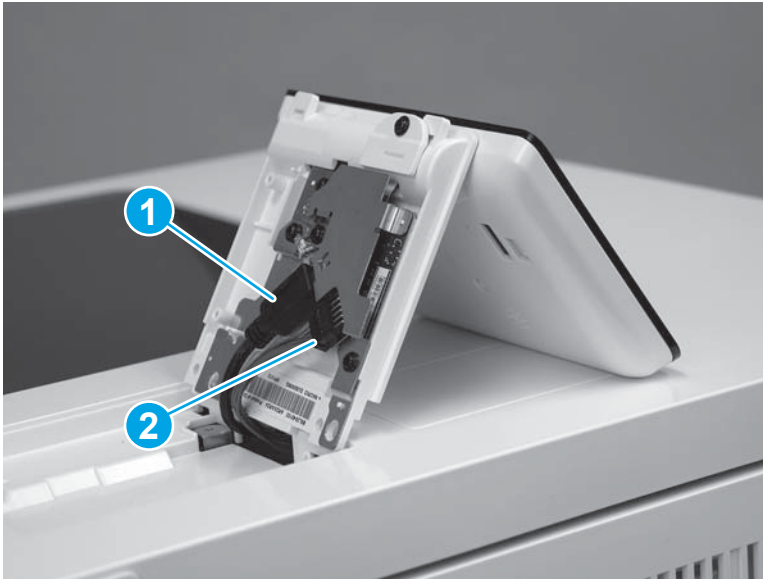

Step 8: Remove the formatter (M552 and M553)



NOTE: This step is for the M552 and M553 models. For the M577 models, skip this step and go to [Step 9: Remove the hard-disk drive \(HDD\) \(M577\) on page 2399](#).

If the optional hard-disk drive (HDD) is installed, it must be removed to gain access to the formatter mounting screws.

Release two tabs along the left edge of the HDD, rotate the left edge away from the product, and then slide the HDD to the left to remove it.



CAUTION:  ESD-sensitive part.

1. Disconnect all of the connectors on the formatter.

The following connectors are empty:

- All models: J1 (this connector is empty unless the optional DIMM is installed)
- M553n/dn and M552dn: J2 (callout 1; this is the touchscreen connector for the M553x model)
- All models: J9 (this connector is empty unless the optional internal USB ports component is installed)
- All models: J18 (this connector is empty unless the optional hard-disk-drive (HDD) is installed)
- All models: J23
- All models: J24
- M553n/dn and M552dn: J25 (this is the wireless connector for the M553x model)

- All models: J57
- All models: J98 (this connector is empty unless the optional trusted platform module (TPM) is installed)

 **IMPORTANT:** The flat-cable connector (callout 2) is a Zero Insertion Force (ZIF) connector that uses a hinged retainer to secure the flat cable. The hinged retainer must be opened to release the flat cable.

Figure 1-4311 Disconnect all connectors



2. Remove four screws (callout 1), and then remove the formatter.

Figure 1-4312 Remove the formatter

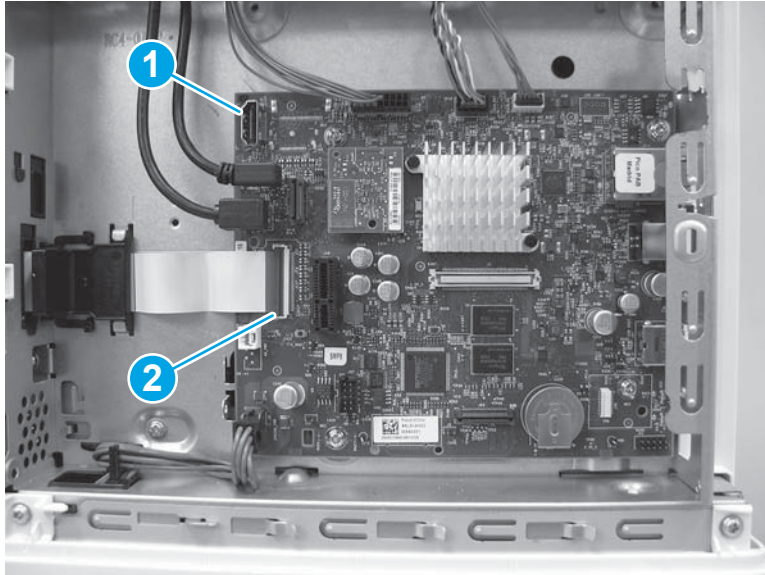
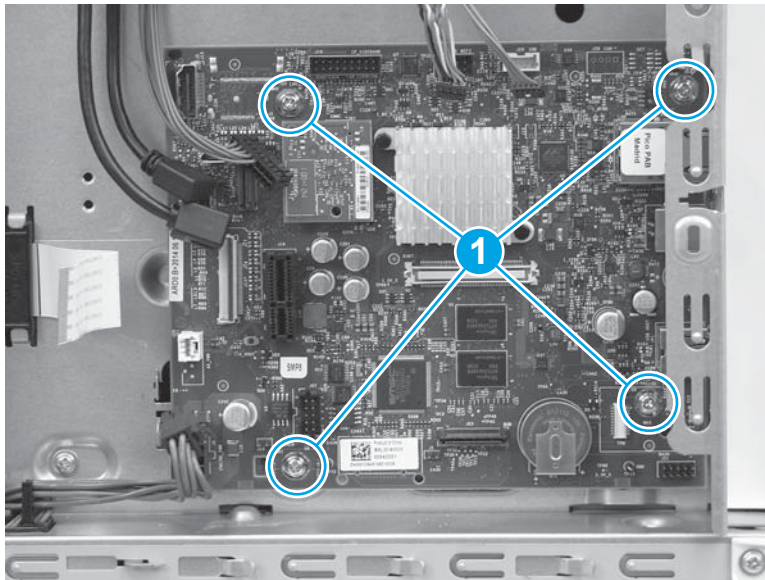

Step 9: Remove the hard-disk drive (HDD) (M577)

 **NOTE:** This step is for the M577 models. For the M552 and M553 models, skip this step and go to [Step 12: Remove the rear cover \(M552 and M553\) on page 2404](#).

 **CAUTION:**  ESD-sensitive part.

1. Release two tabs (callout 1). Hold the tabs in the released position, and then rotate the hard disk drive (HDD) up (callout 2) to release the connector from the formatter.

Figure 1-4313 Release the HDD

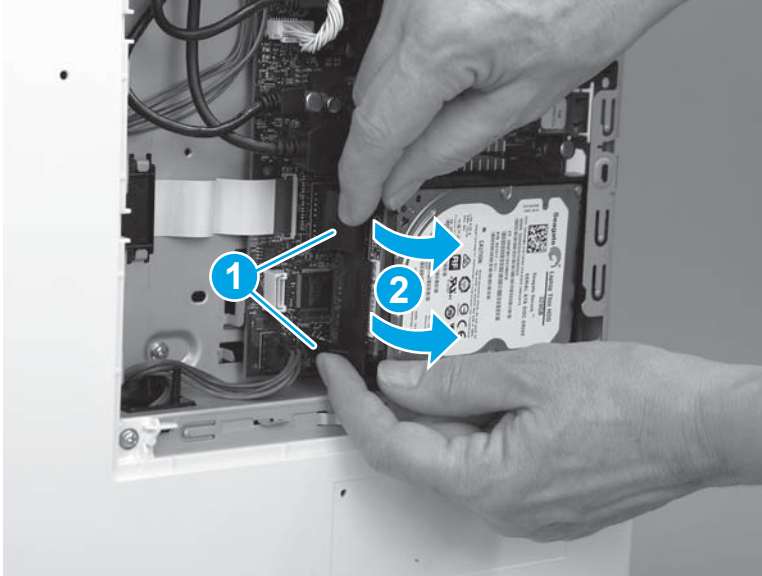

2. Slide the HDD away from the printer to remove it.

Figure 1-4314 Remove the HDD

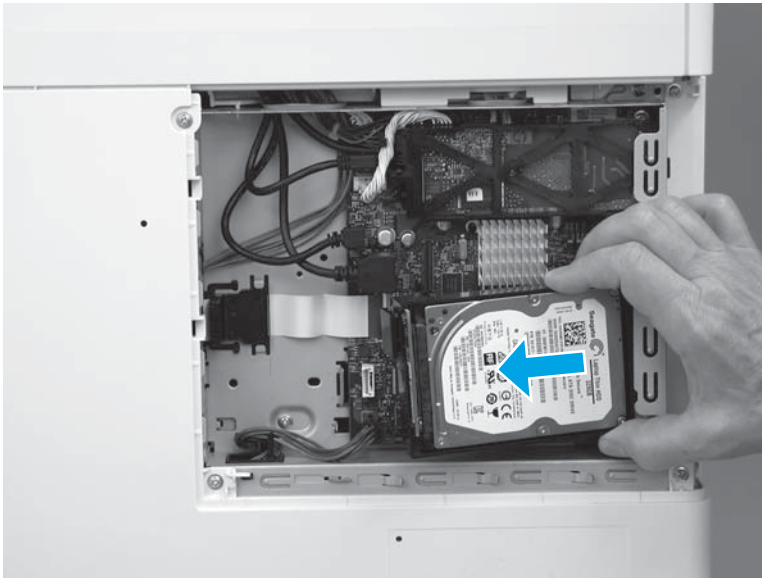

Step 10: Remove the fax PCA (M577c/f/z)

 **NOTE:** This step is for the M577c/f/z models. For the M577n model, skip this step and go to [Step 11: Remove the formatter \(M577\) on page 2402.](#)

For the M552 and M553 models, skip this step and go to [Step 12: Remove the rear cover \(M552 and M553\) on page 2404.](#)

 **CAUTION:**  ESD-sensitive part.

1. Locate the fax PCA component on the formatter.

Figure 1-4315 Locate the fax PCA

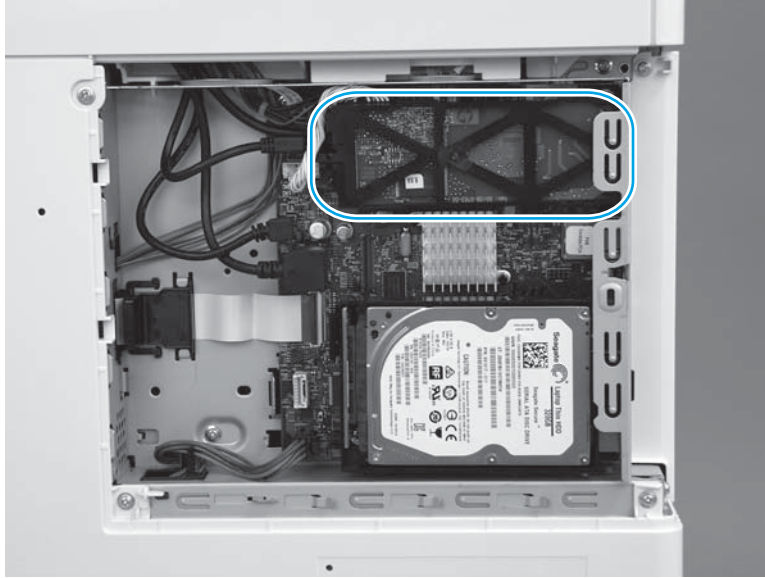

2. Release the connector latch (callout 1), and then pull the connector away from the formatter (callout 2) to disconnect it.

Figure 1-4316 Disconnect one connector

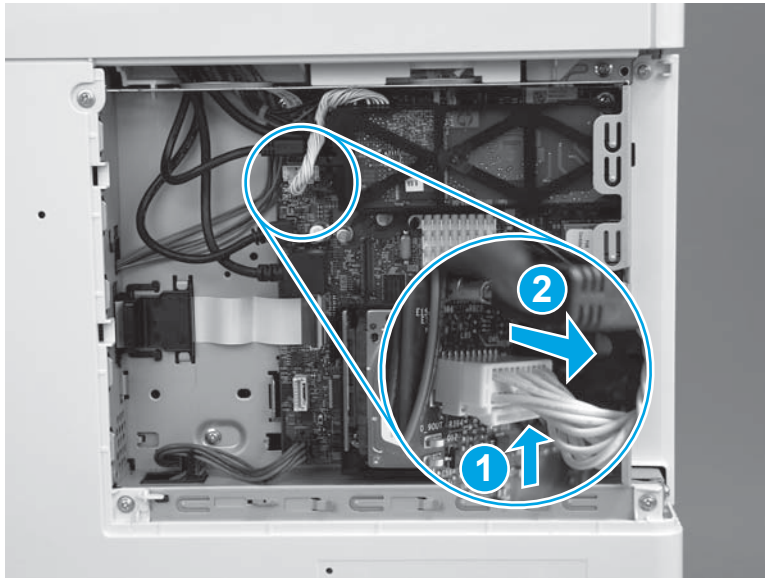

3. Release one retainer (callout 1) by pressing the bracket arms together.

Figure 1-4317 Release one latch

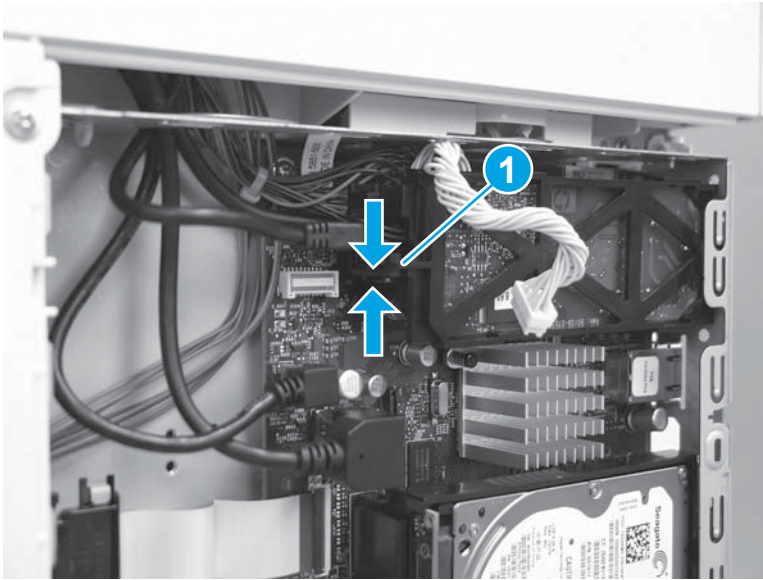

4. Rotate the end of the fax PCA (callout 1) away from the formatter, and then slide the PCA left (callout 2) to remove it.

Figure 1-4318 Remove the fax PCA

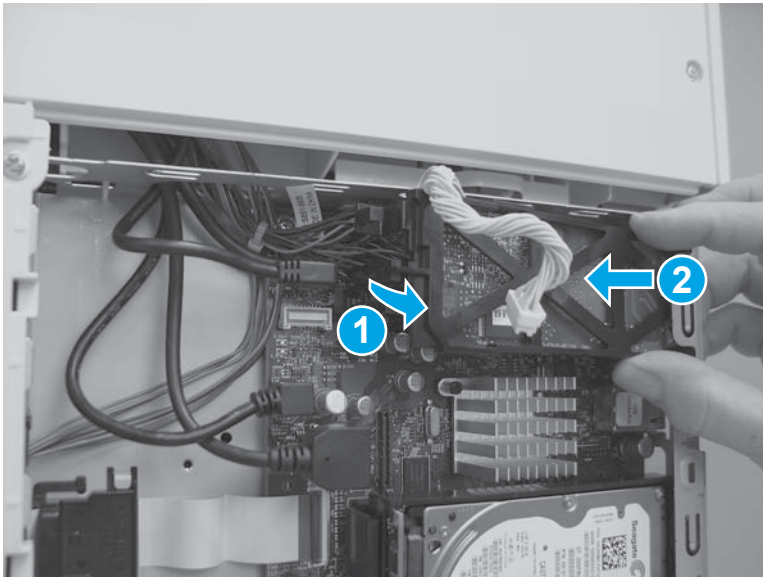

Step 11: Remove the formatter (M577)



NOTE: This step is for the M577 models. For the M552 and M553 models, skip this step and go to [Step 12: Remove the rear cover \(M552 and M553\) on page 2404.](#)



CAUTION:  ESD-sensitive part.

1. Disconnect all of the connectors on the formatter.

The following connectors are empty:

- All models: J1 (this connector is empty unless the optional DIMM is installed)
- All models: J3
- M577dn: J15 (this is the fax connector for the M577f/z/c models)
- All models: J21 (this connector is empty unless the optional internal USB ports component is installed)
- All models: J23
- All models: J24
- All models: J51
- All models: J57
- All models: J97
- All models: J98 (this connector is empty unless the optional trusted platform module (TPM) is installed)

 **IMPORTANT:** The flat-cable connector (callout 1) is a Zero Insertion Force (ZIF) connector that uses a hinged retainer to secure the flat cable. The hinged retainer must be opened to release the flat cable.

Figure 1-4319 Disconnect all connectors



2. Remove four screws (callout 1).

Figure 1-4320 Remove four screws

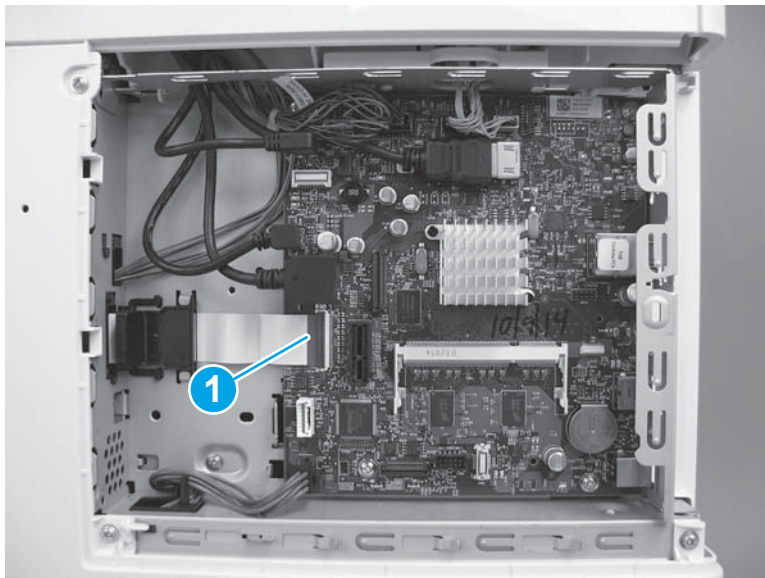
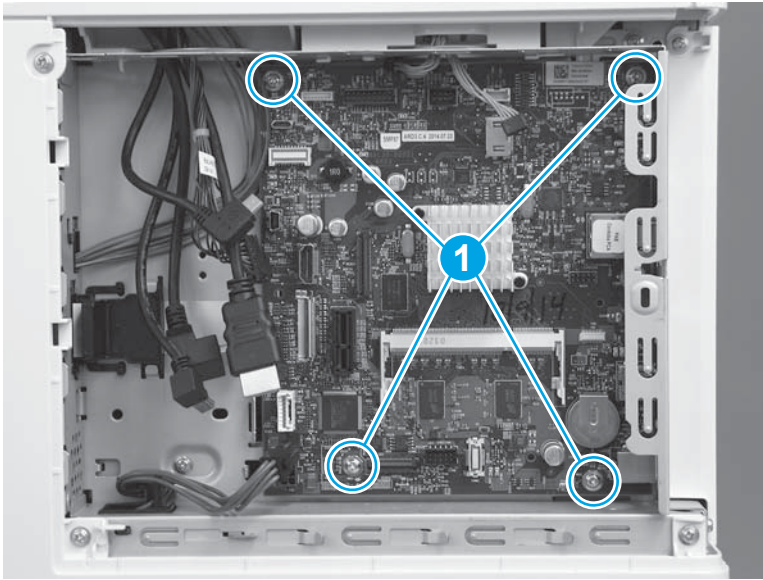

3. Remove the formatter.

Figure 1-4321 Remove the formatter

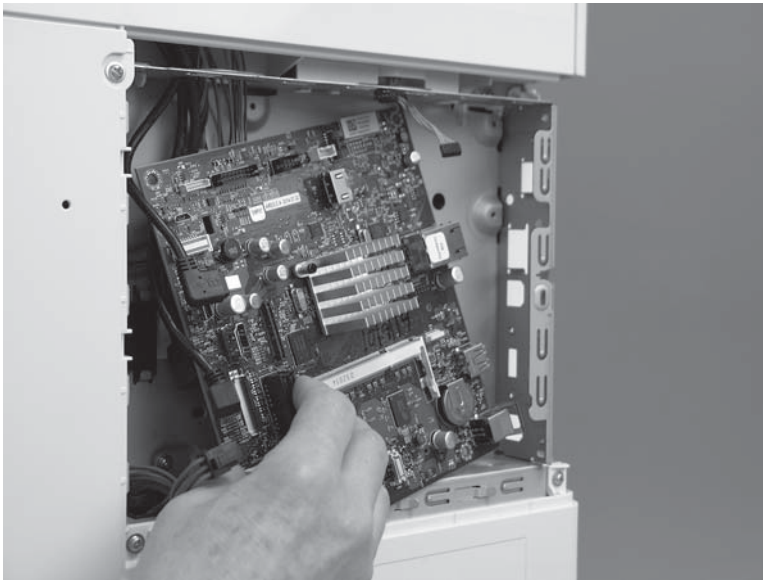

Step 12: Remove the rear cover (M552 and M553)



NOTE: This step is for the M552 and M553 models. For the M577 models, skip this step and go to [Step 13: Remove the rear upper cover \(M577\) on page 2405.](#)

1. Remove four screws (callout 1).

Figure 1-4322 Remove four screws

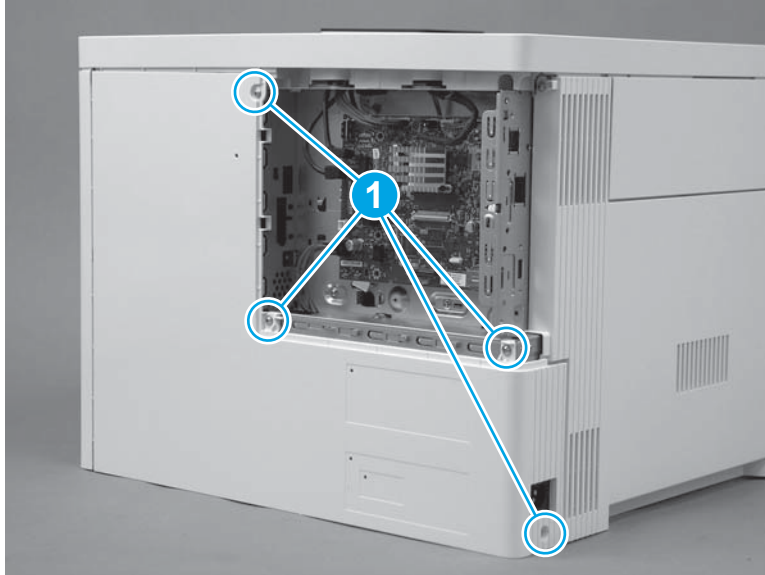

2. Slightly slide the cover to the right (callout 1), rotate the bottom of the cover away from the printer (callout 2), and then pull the top of the cover away from the printer (callout 3) to remove the cover.

Figure 1-4323 Remove the cover

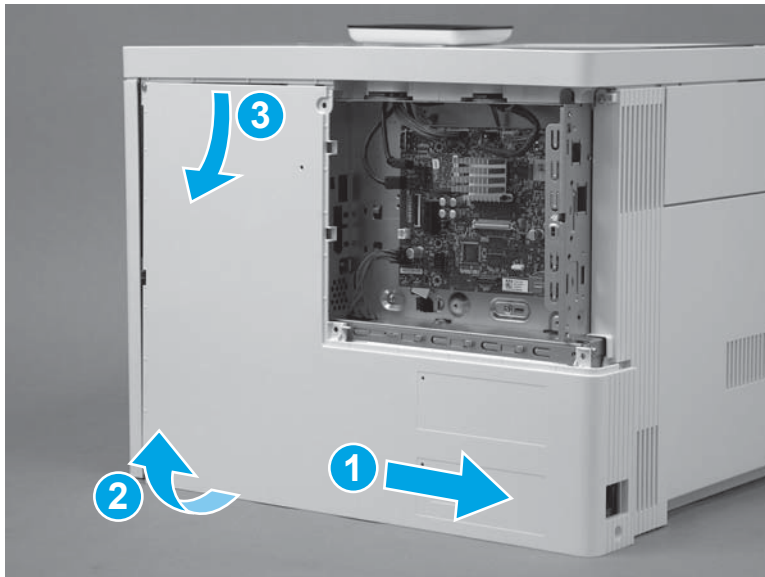

Step 13: Remove the rear upper cover (M577)

 **NOTE:** This step is for the M577 models. For the M552 and M553 models, skip this step and go to [Step 20: Remove the left cover on page 2418](#).

1. Remove two screws (callout 1).

 **Reinstallation tip:** These two screws are self-tapping screws for plastic. When reinstalling them, rotate the screws counterclockwise to align them with the existing thread pattern, and then carefully turn them clockwise to tighten. Do not overtighten. This will prevent stripping the threads inside the screw holes.

Figure 1-4324 Remove two screws



2. Use a small, flat blade screwdriver to release the right edge of the cover.

Figure 1-4325 Release the right edge

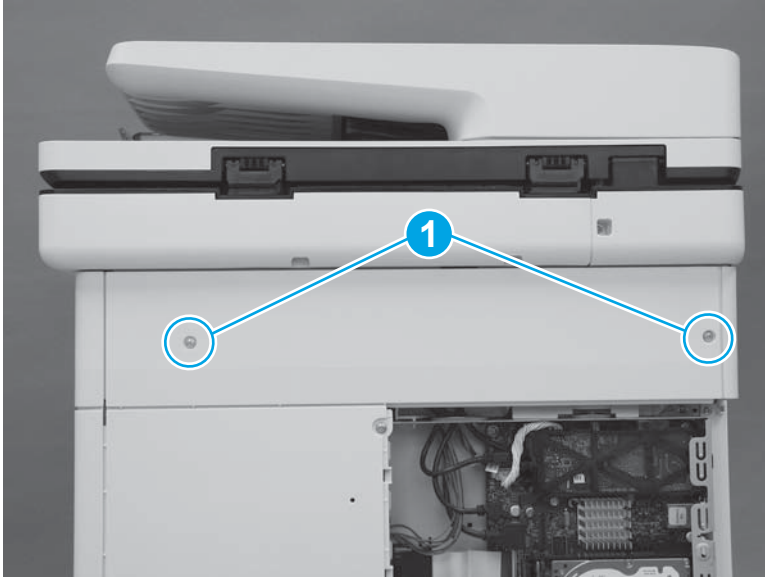
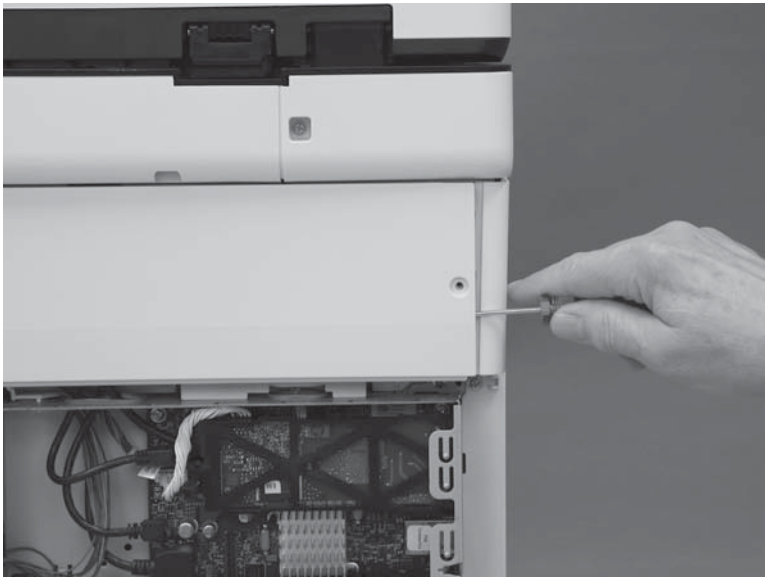

3. Pull the right edge of the cover (callout 1) away from the printer, and then slide the cover to the right (callout 2).

Figure 1-4326 Slide the cover right

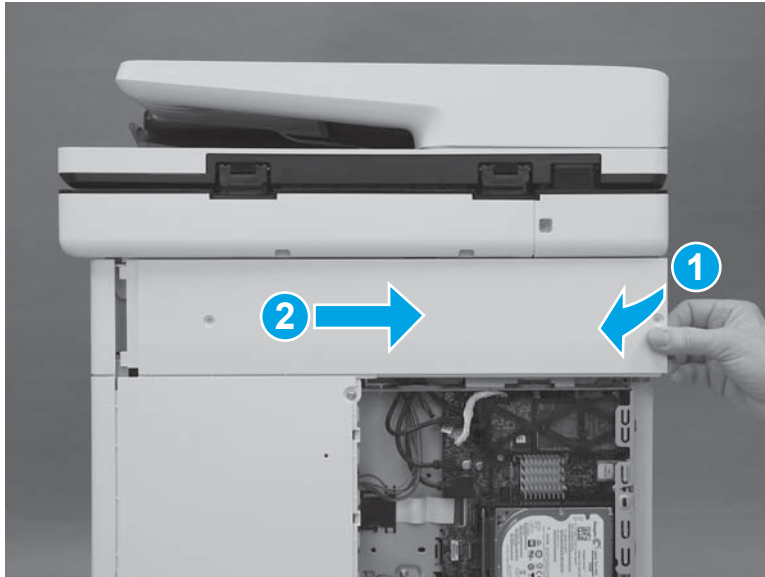

4. Remove the cover.

Figure 1-4327 Remove the cover

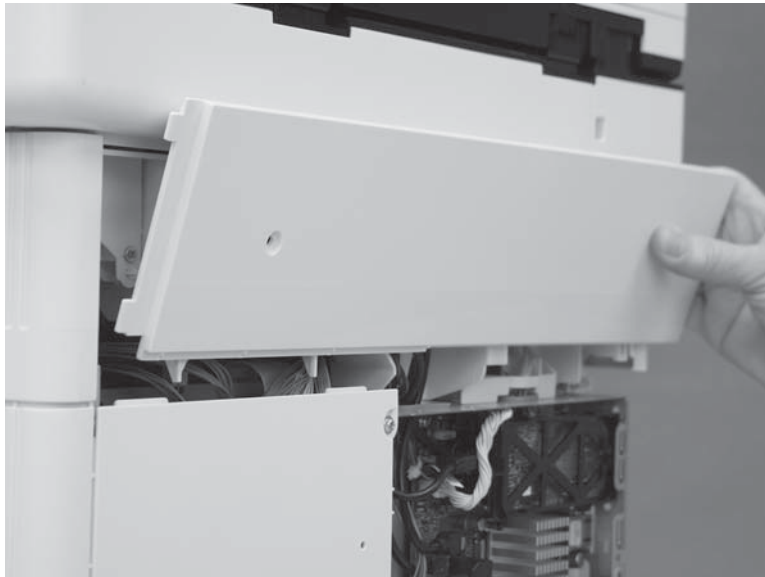

Step 14: Remove the rear cover (M577)

 **NOTE:** This step is for the M577 models. For the M552 and M553 models, skip this step and go to [Step 20: Remove the left cover on page 2418.](#)

1. Remove four screws (callout 1).

Figure 1-4328 Remove four screws

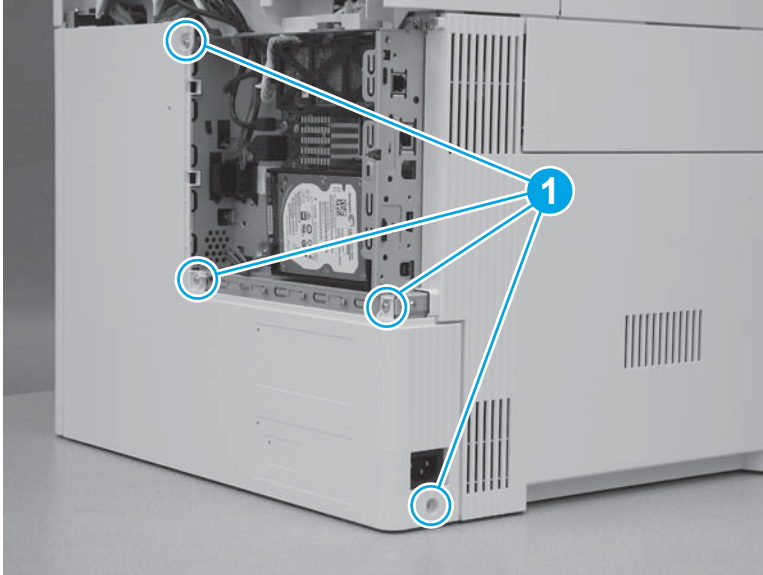

2. Slide the cover to the right to remove it.

Figure 1-4329 Remove the cover

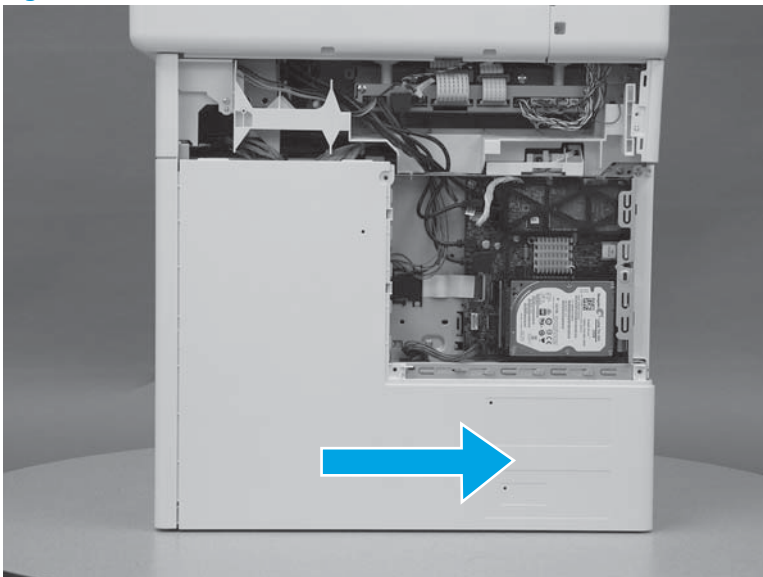

Step 15: Remove the left upper cover (M577)



NOTE: This step is for the M577 models. For the M552 and M553 models, skip this step and go to [Step 20: Remove the left cover on page 2418](#).

1. At the left side of the printer, release one tab (callout 1).

Figure 1-4330 Release one tab

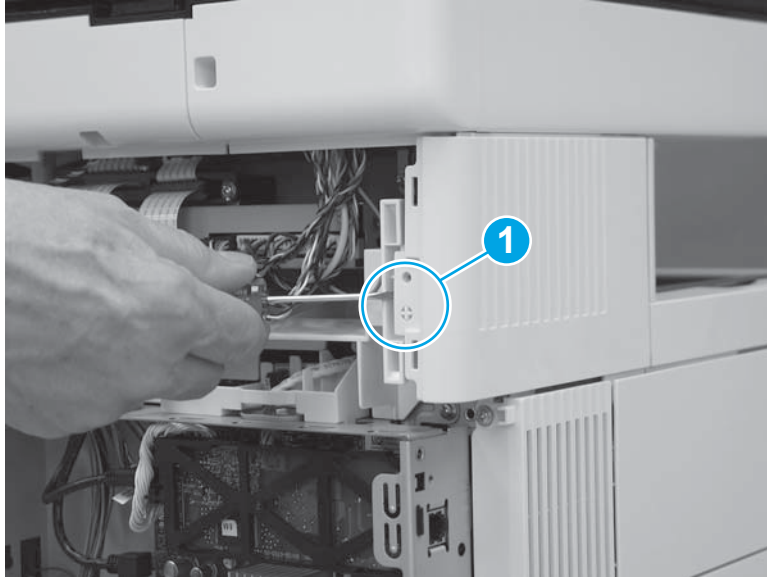

2. Slide the left upper cover toward the back of the printer.

Figure 1-4331 Slide the cover back

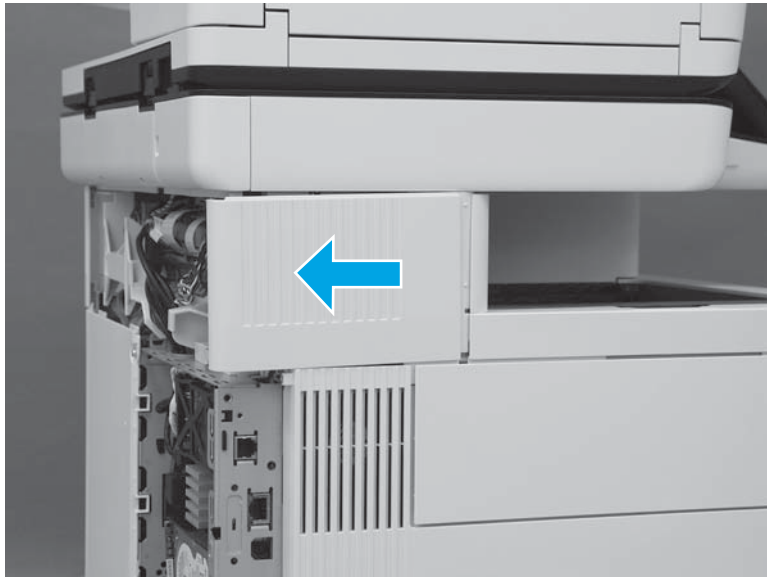

3. Rotate the cover up to remove it.

Figure 1-4332 Remove the left upper cover



Step 16: Remove the right front upper cover (M577dn)



NOTE: This step is for the M577dn model. For the M577c/f/z models, skip this step and go to [Step 17: Remove the stapler cover assembly \(M577c/f/z\) on page 2411](#).

For the M552 and M553 models, skip this step and go to [Step 20: Remove the left cover on page 2418](#).

1. Slide the cover toward the left side of the printer to install it. Make sure that the slots (callout 1) in the cover fit over the tabs (callout 2) on the inside of the paper feeder cover.

Figure 1-4333 Install the cover



2. Press the right front upper cover (callout 1) and the paper feeder cover (callout 2) together until the tabs on the inside of the covers snap into place.

Figure 1-4334 Press the cover



3. Install one screw (callout 1).

Figure 1-4335 Install one screw

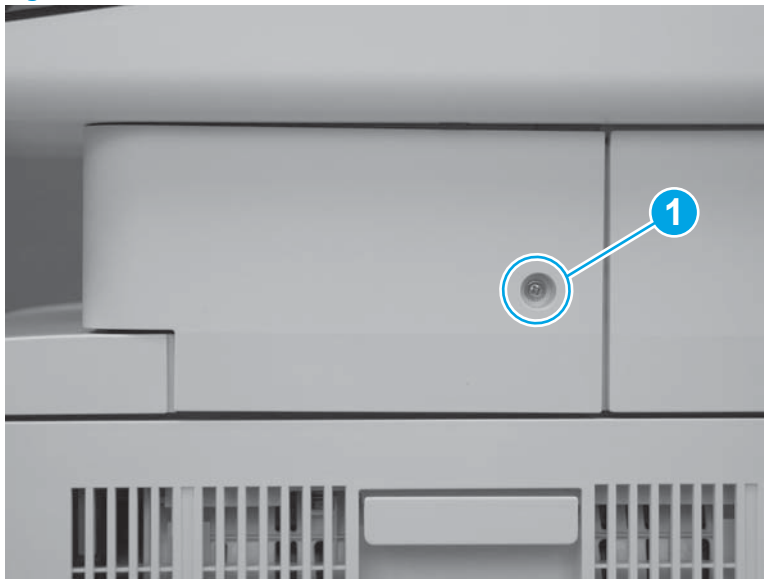

Step 17: Remove the stapler cover assembly (M577c/f/z)

 **NOTE:** This step is for the M577c/f/z models. For the M577dn model, skip this step and go to [Step 19: Remove the right upper cover \(M577dn\) on page 2416](#).

For the M552 and M553 models, skip this step and go to [Step 20: Remove the left cover on page 2418](#).

1. Remove one screw (callout 1).

 **Reinstallation tip:** This is a self-tapping screw for plastic. When reinstalling, rotate the screw counterclockwise to align it with the existing thread pattern, and then carefully turn it clockwise to tighten. Do not overtighten. This will prevent stripping the threads inside the screw hole.

Figure 1-4336 Remove one screw



2. Release two tabs at the front edge of the cover (callout 1).

Figure 1-4337 Release two tabs

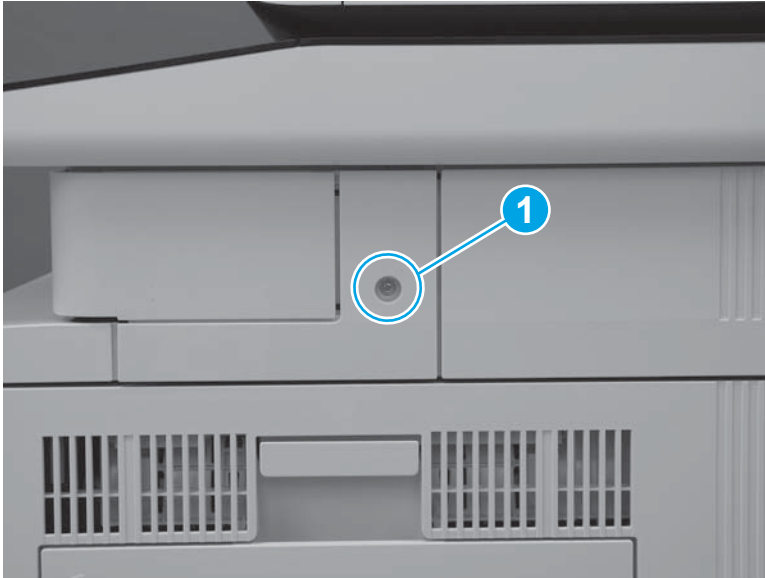

3. Release the back edge of the cover.

Figure 1-4338 Release the back edge of the cover

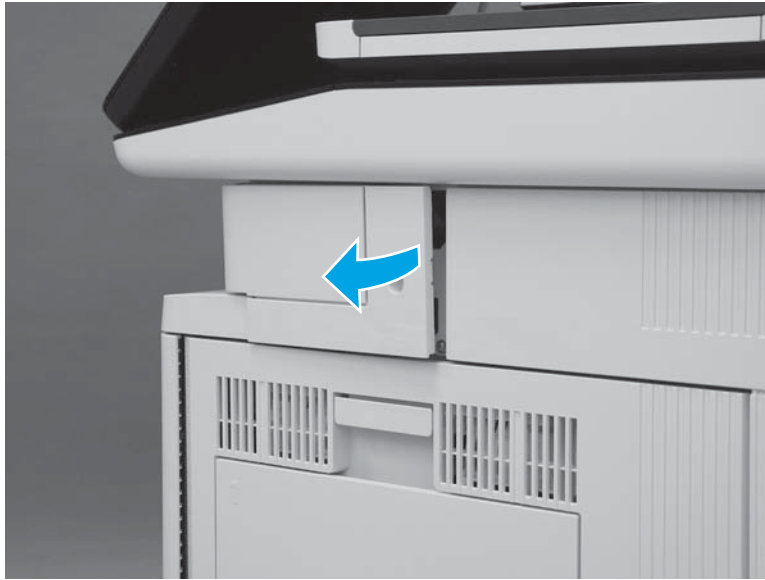



4. Rotate the cover away from the printer to remove it.

Figure 1-4339 Remove the cover



Step 18: Remove the integrated scanner assembly (ISA) (M577)

 **NOTE:** This step is for the M577 models. For the M552 and M553 models, skip this step and go to [Step 20: Remove the left cover on page 2418](#).

 **NOTE:** The ISA includes the document feeder, image scanner, scanner control board (SCB), control panel, keyboard (M577c/z) and NFC PCA (M577z).

1. At the left side of the printer, remove one screw (callout 1).

Figure 1-4340 Remove one screw

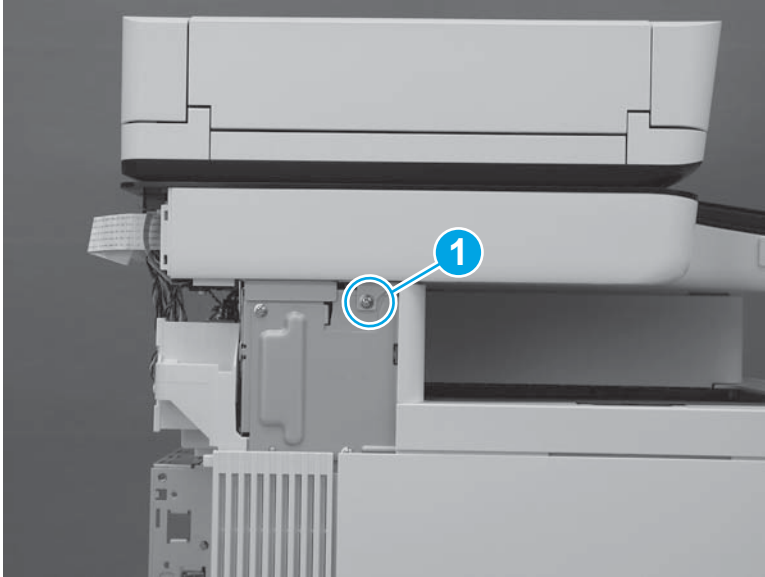

2. At the back side of the printer, remove two screws (callout 1).

Figure 1-4341 Remove two screws

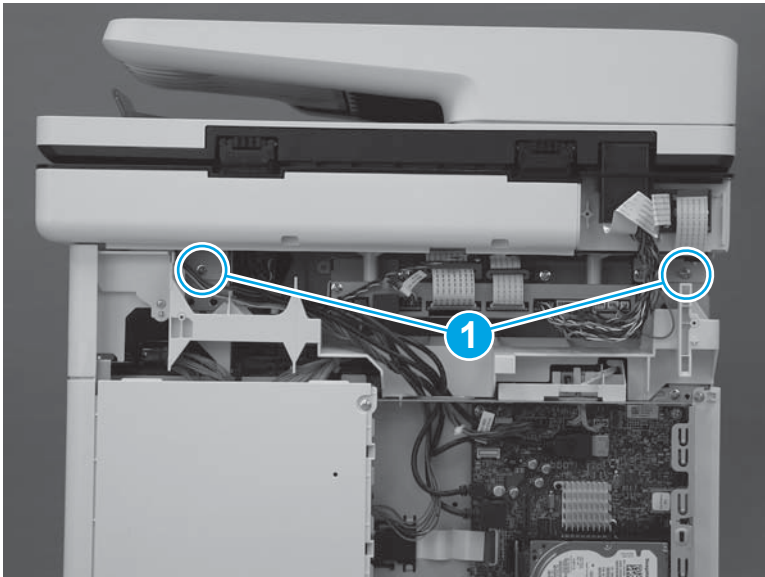

3. At the right side of the printer, remove one screw (callout 1).

Figure 1-4342 Remove one screw

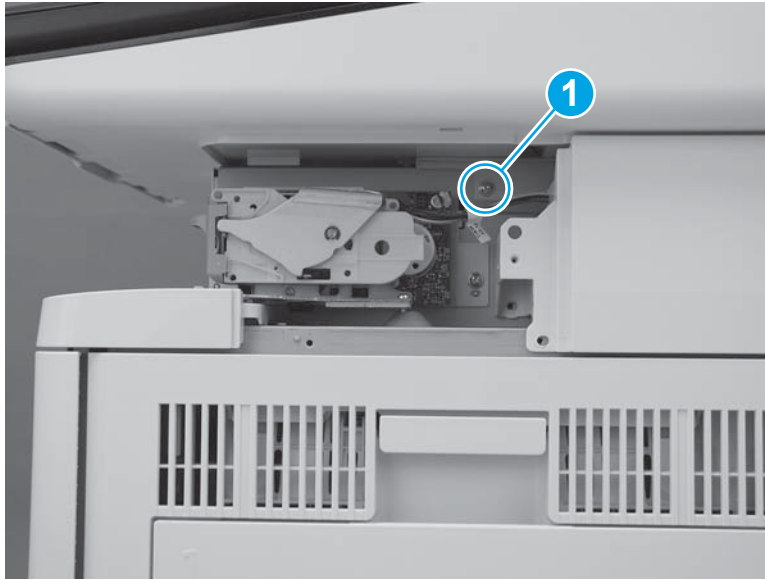

4. Disconnect two connectors on the scanner control board (callout 1).

M577c/f/z only: Disconnect one connector for the stapler on the scanner control board (callout 2).

Figure 1-4343 Disconnect connectors

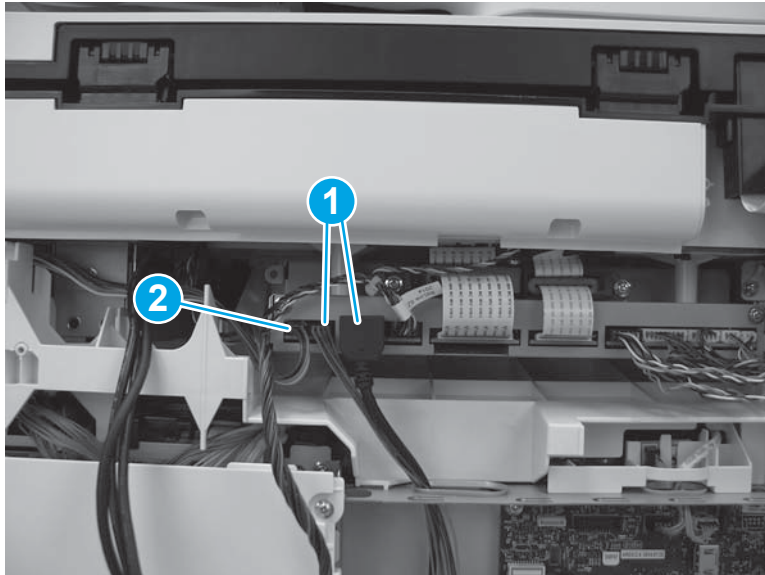

5. Slightly slide the ISA towards the back of the printer to release it.

Figure 1-4344 Slide the ISA towards the back of the printer

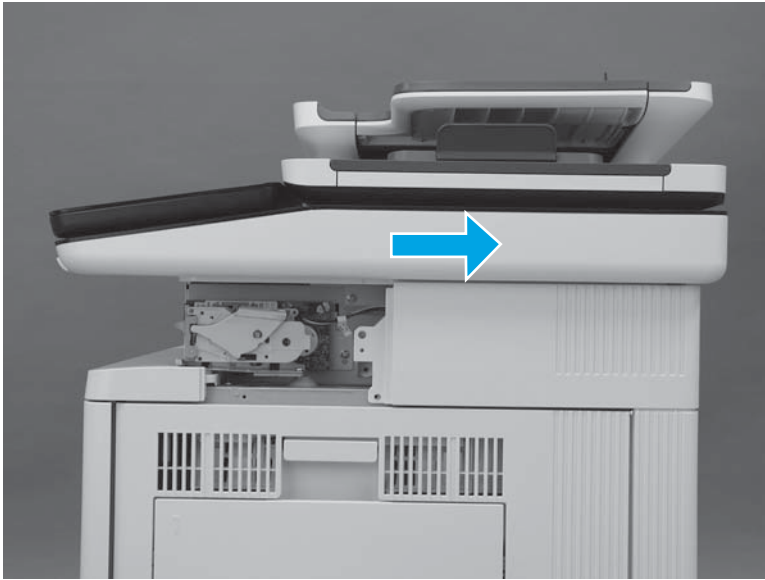

6. Lift the ISA up to remove it.



 **NOTE:** When lifting the ISA, carefully pass the cables through the opening in the top of the formatter case.

Figure 1-4345 Remove the ISA



Step 19: Remove the right upper cover (M577dn)

 **NOTE:** This step is for the M577 models. For the M552 and M553 models, skip this step and go to [Step 20: Remove the left cover on page 2418](#).

 **NOTE:** The figures below show the image scanner installed. The procedures for removing and installing the right upper cover are the same whether the image scanner is installed or removed."

1. At the right side of the printer, remove two screws (callout 1).

M577c/f/z only: Disconnect one connector (callout 2), if it was not already disconnected in a previous step.

Figure 1-4346 Remove two screws and one connector

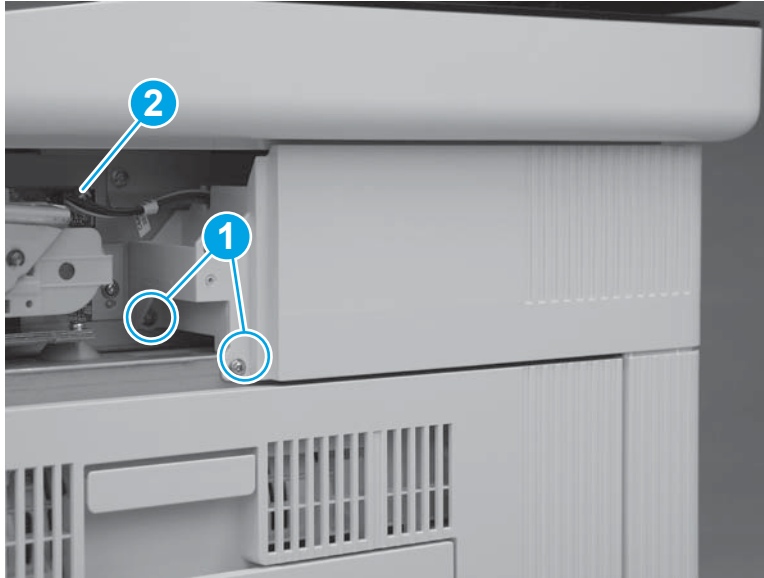

2. At the back of the printer, remove one screw (callout 1).

M577c/f/z only: Disconnect one connector (callout 2), if it was not already disconnected in a previous step.

 **Reinstallation tip:** This screw is smaller than the screws removed in the previous step. When reinstalling the right upper cover, make sure that this screw is installed in the correct position.

Figure 1-4347 Remove one screw and connector



3. Slide the cover toward the back of the printer.

Figure 1-4348 Slide the cover

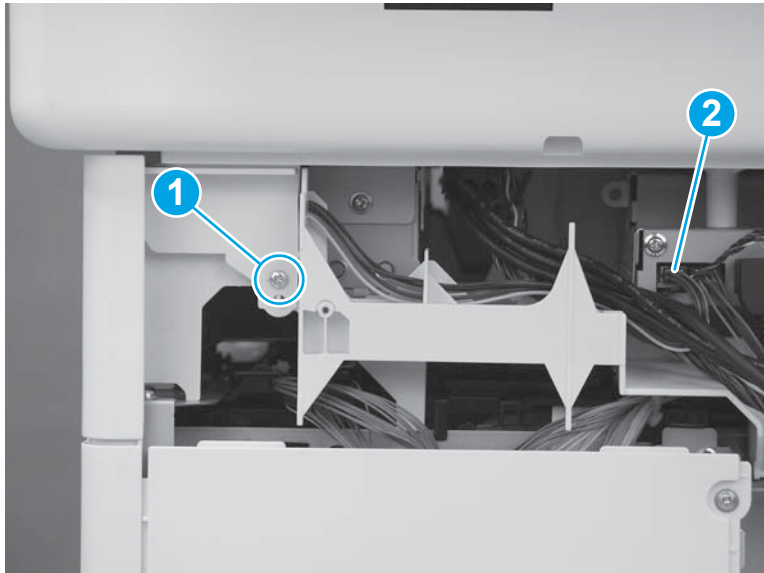
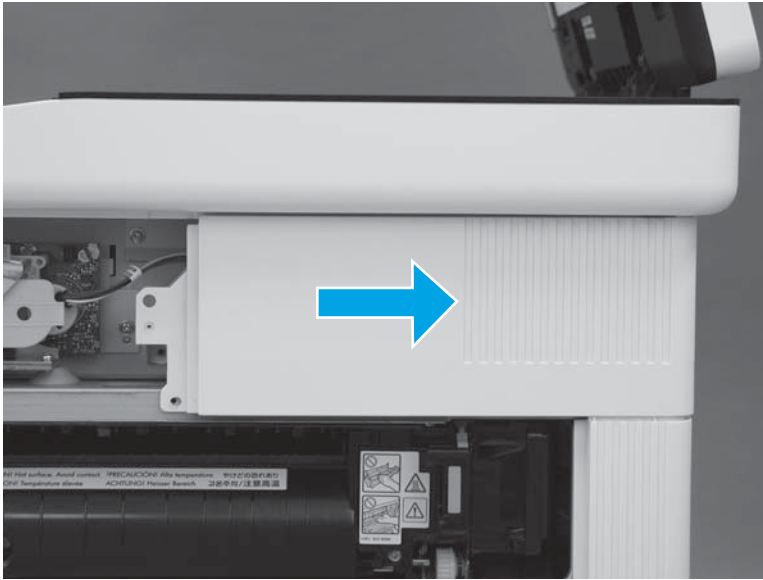

4. Lift the cover away from the printer to remove it.

M577c/f/z only: Release the cables (callout 1) through the slot (callout 2) in the printer.

Figure 1-4349 Remove the cover

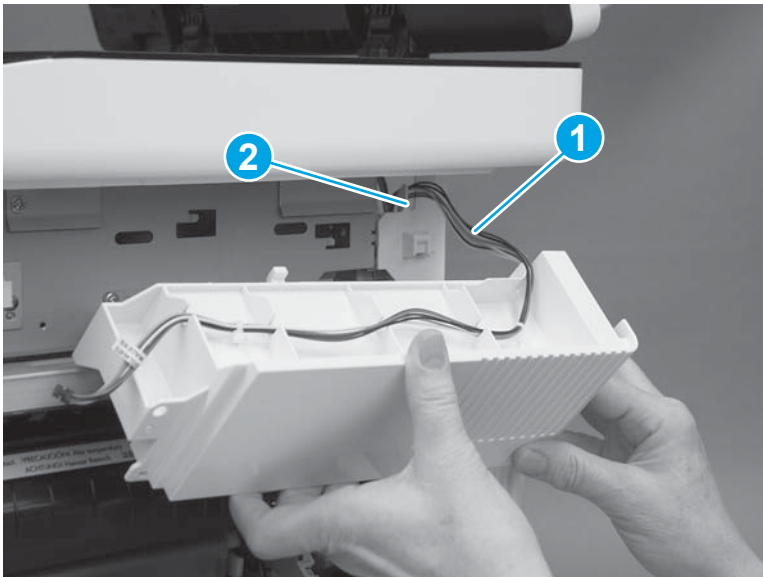

Step 20: Remove the left cover

1. At the left side of the printer, remove one screw (callout 1).

Figure 1-4350 Remove one screw



2. Release one tab (callout 1), rotate the front edge of the cover away from the printer (callout 2), and then slide the cover (callout 3) toward the rear of the printer to release it.

Figure 1-4351 Release the cover

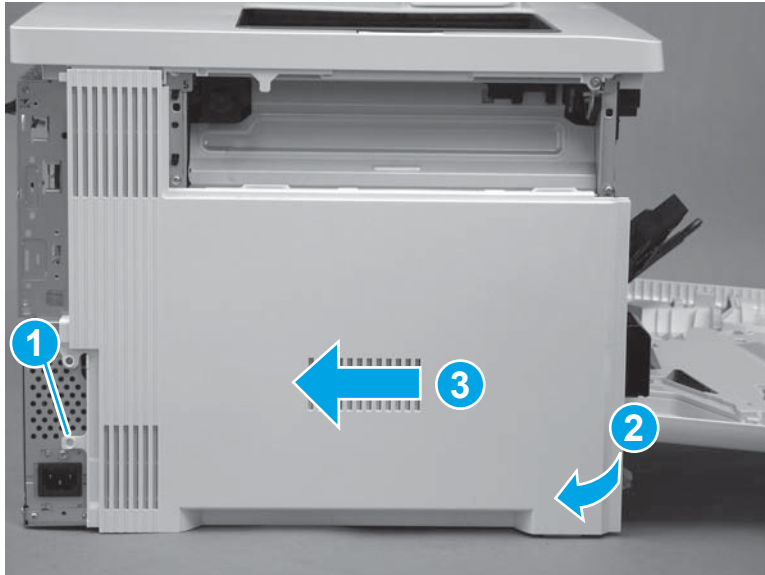

3. Remove the cover.

Figure 1-4352 Remove the cover

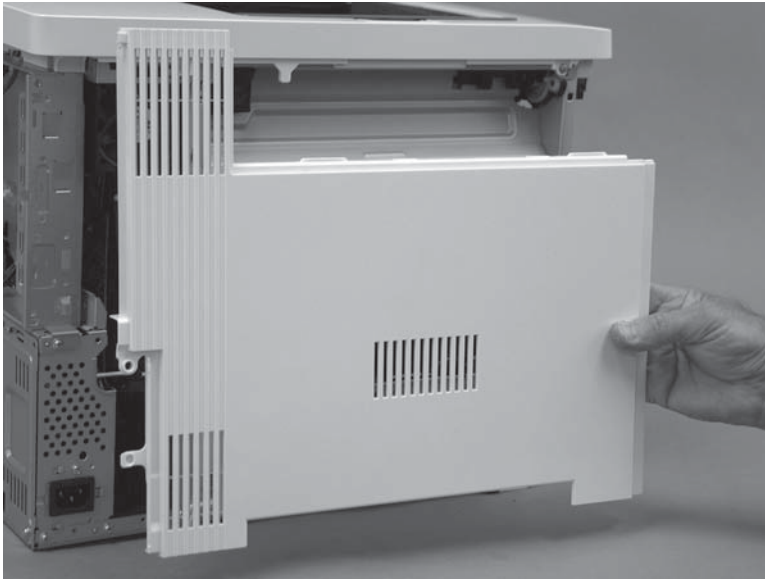

Step 21: Remove the upper cover (M552 and M553)



NOTE: This step is for the M552 and M553 models. For the M577 models, skip this step and go to [Step 22: Remove the right rear cover on page 2422](#).

1. Remove three screws (callout 1).

Figure 1-4353 Remove three screws

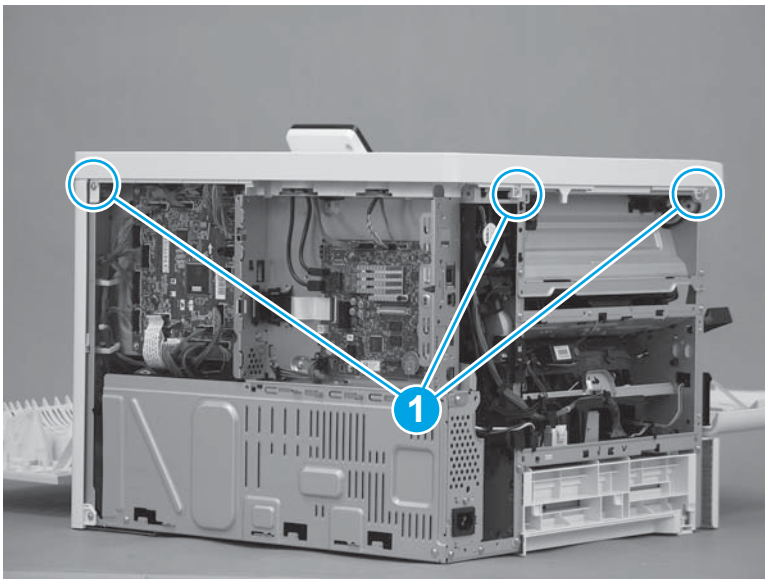

2. Remove one screw (callout 1), release one tab (callout 2), and then slightly separate the corner of the cover from the chassis.

 **NOTE:** This is a self-tapping plastic-thread screw. Make sure that this screw is used in this location when it is reinstalled.

Figure 1-4354 Remove one screw and release one tab



3. Release one tab (callout 1), and then lift up on the cover to release it.

 **NOTE:** If the cover does not release, check for addition tabs by locating the triangles embossed in the cover at tab locations.

Figure 1-4355 Release the cover



4. Remove the cover.

Figure 1-4356 Remove the cover

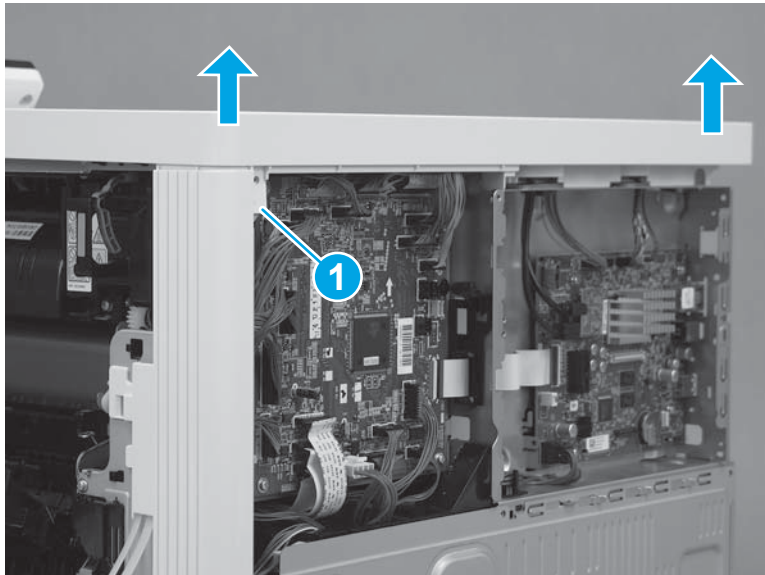
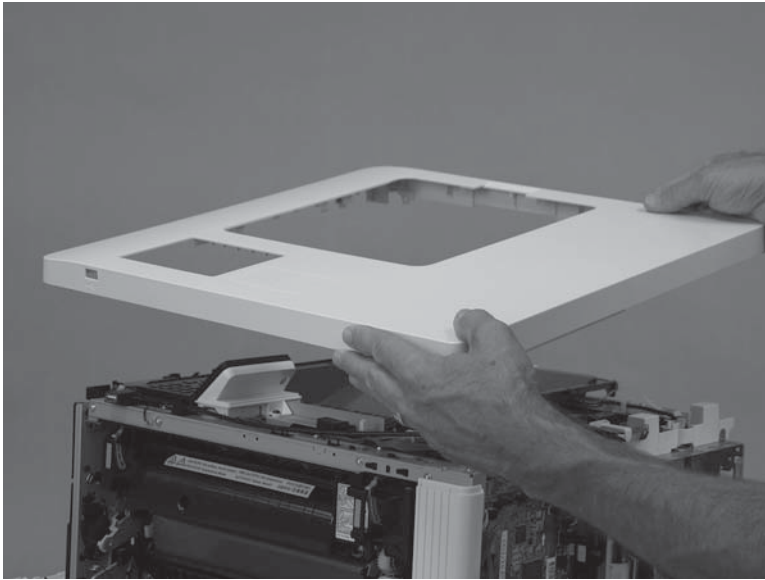

Step 22: Remove the right rear cover

1. Remove one screw (callout 1), and then slide the cover toward the rear of the printer (callout 2) to release it.

 **TIP:** If the right door is closed, open it now.

Figure 1-4357 Release the cover

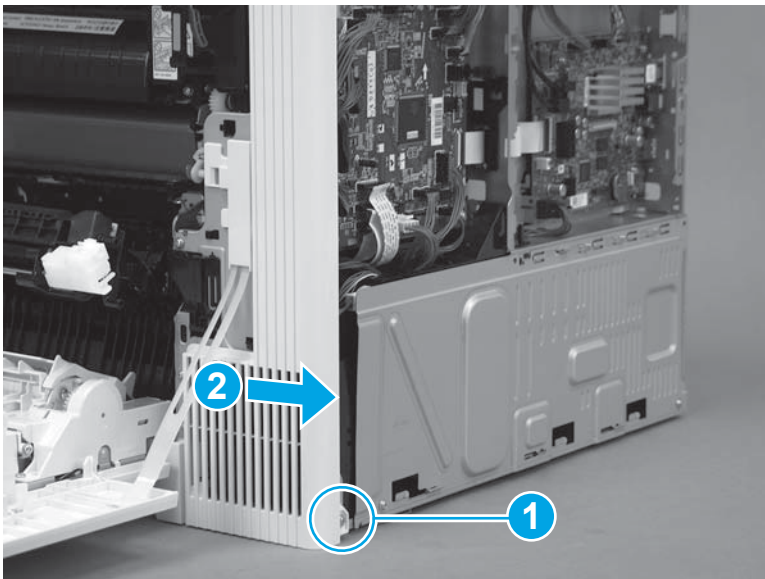

2. Remove the cover.

Figure 1-4358 Remove the cover

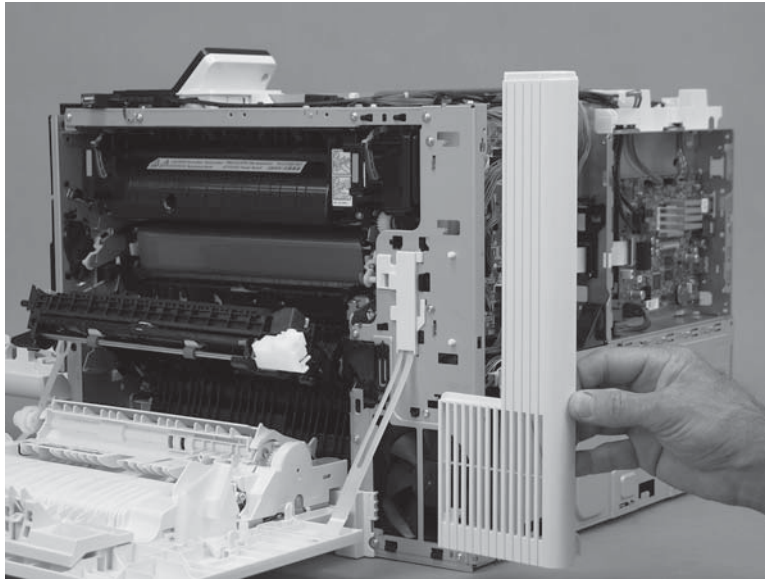

Step 23: Remove the formatter case

1. **M577 only:** Disconnect one connector (callout 1), and then pass the wire harness (callout 2) through two openings in the formatter case (callout 3).

Figure 1-4359 Disconnect one connector

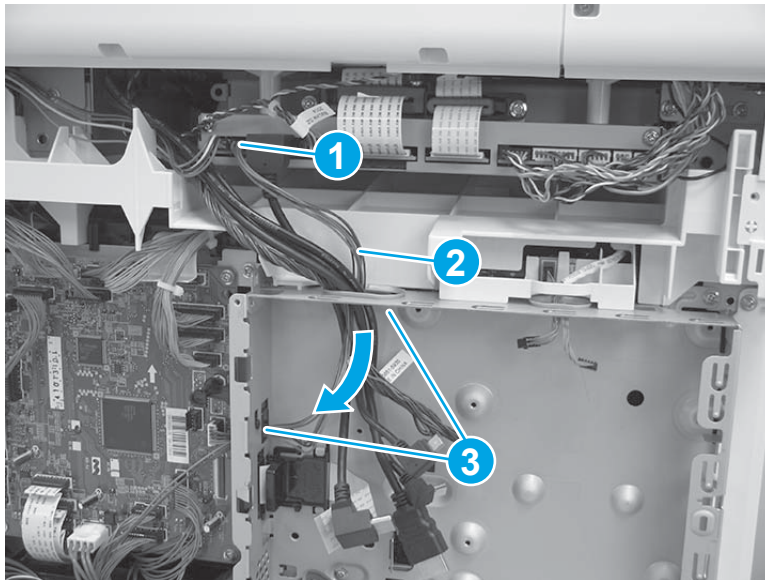

2. Release two tabs (callout 1) on the black plastic bracket. Hold the tabs in the released position, and then slide the bracket (callout 2) to the right to remove it from the formatter case.

Figure 1-4360 Remove the bracket

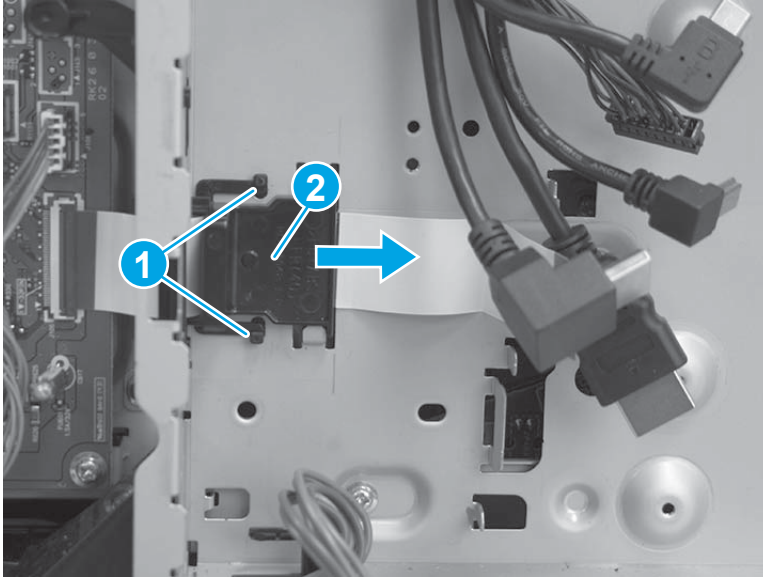

3. Remove two screws (callout 1), and then slide the low-voltage power supply (LVPS) cover to the right to remove it.

Figure 1-4361 Remove the LVPS cover

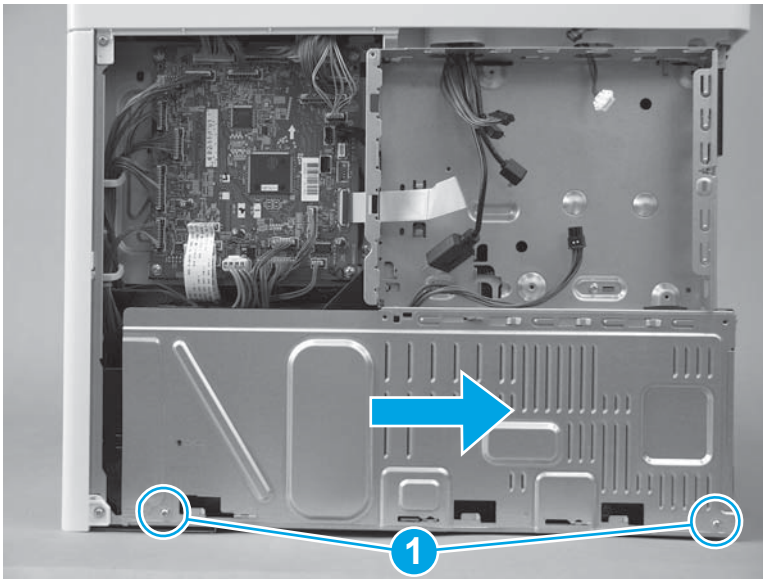

4. Pass two wire harnesses and one flat cable (callout 1) through the opening in the formatter case, and then release one wire harness from the retainer (callout 2).

CAUTION: The flat cable might be attached to the formatter case with double-sided tape. Make sure that this tape is released, so that the flat cable is not damaged when the formatter case is removed.

Figure 1-4362 Release wire harnesses and flat cable

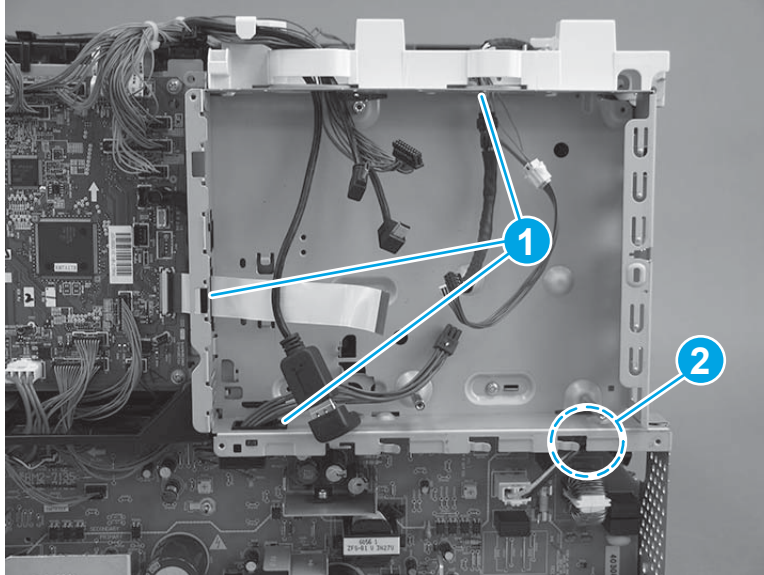

5. Remove six screws (callout 1).

Figure 1-4363 Remove six screws

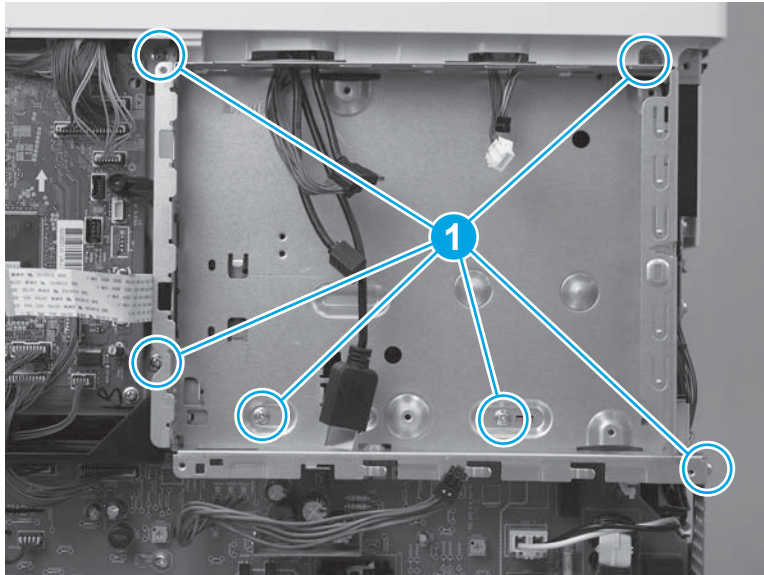

6. Rotate the bottom of the formatter case away from the printer (callout 1), and then pull it down (callout 2) to release it.

Figure 1-4364 Release the formatter case

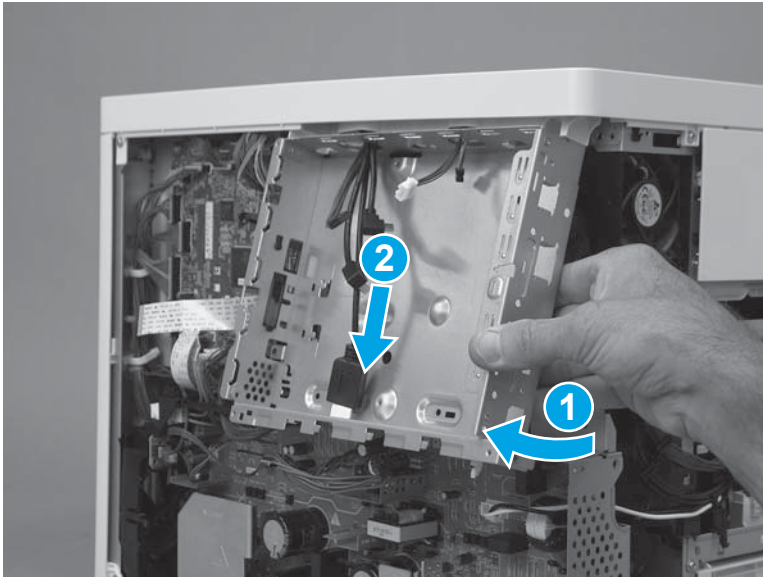

7. Pass the wire harnesses through the opening in the formatter case to remove it.

IMPORTANT: If the formatter case is removed so that it can be replaced, make sure to transfer the memory PCA (island of data) and plastic bracket (callout 1) to the replacement case.

Figure 1-4365 Remove the formatter case

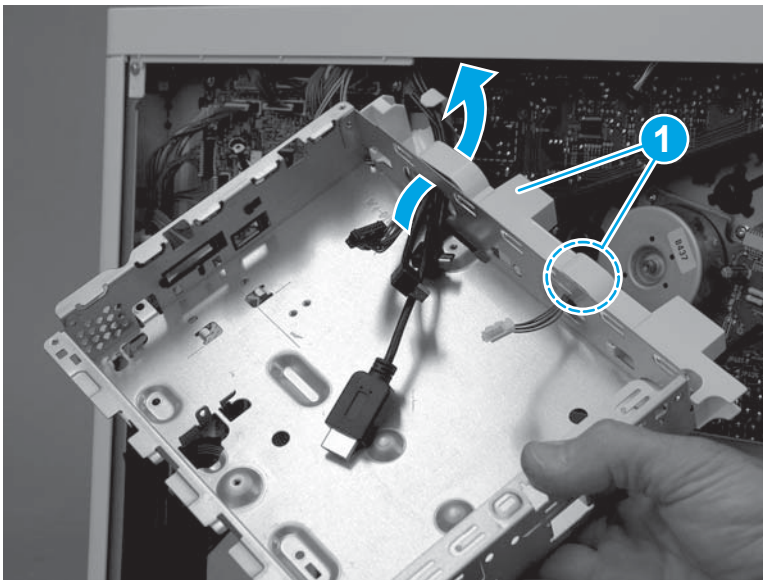

Step 24: Remove the low-voltage power supply (LVPS)

CAUTION:  ESD-sensitive part.

1. Disconnect one wire harness (callout 1), and then pass the wire harness through the opening (callout 2) in the chassis.

Figure 1-4366 Disconnect one wire harness

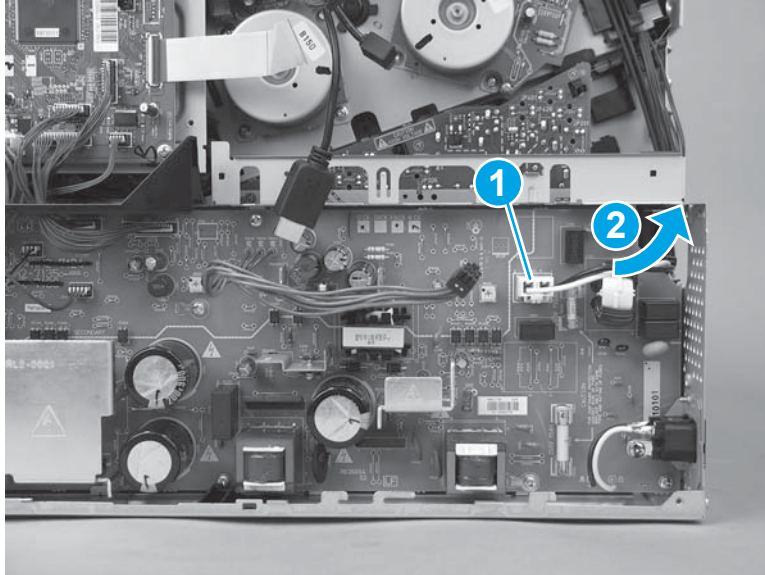

2. Disconnect three connectors on the DC controller (callout 1), and then disconnect four connectors (callout 2) on the LVPS.

Figure 1-4367 Disconnect seven connectors

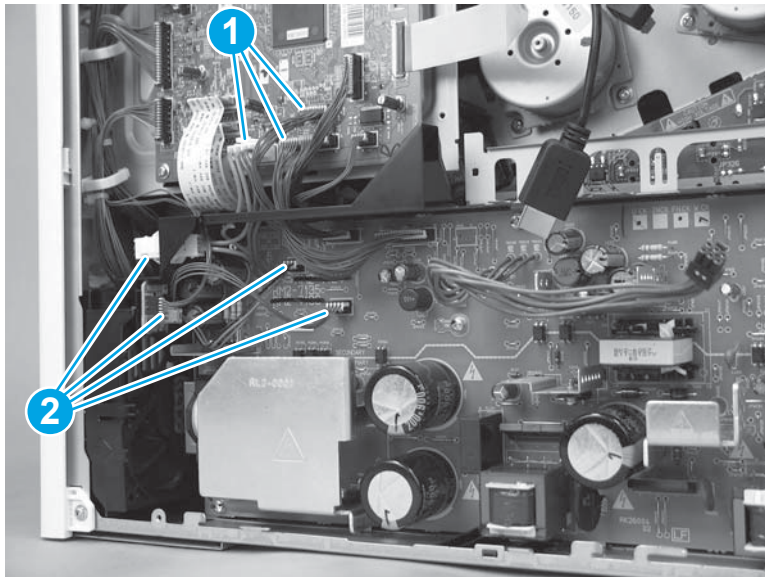

3. Pass the wire harnesses from the DC controller to the LVPS through the opening in the chassis (callout 1), and then release the wire harnesses from the retainer (callout 2).

Figure 1-4368 Pass the wire harnesses through the opening

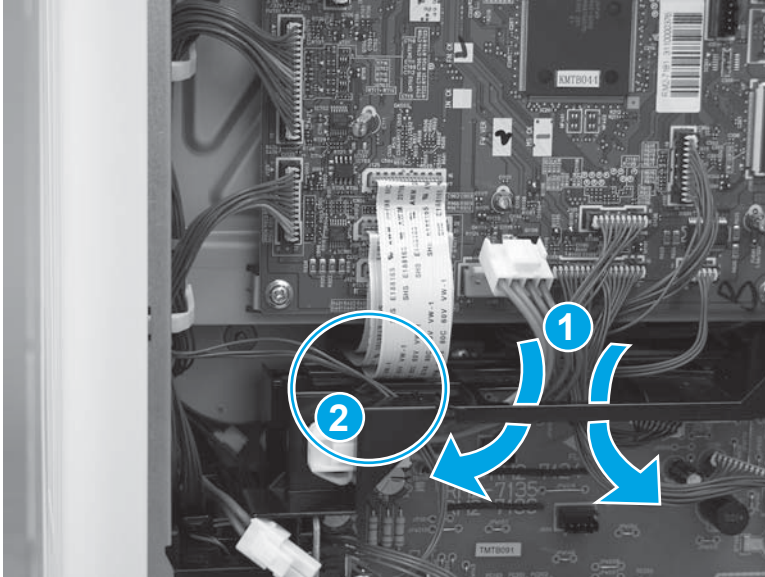

4. Remove three screws (callout 1).

Figure 1-4369 Remove three screws

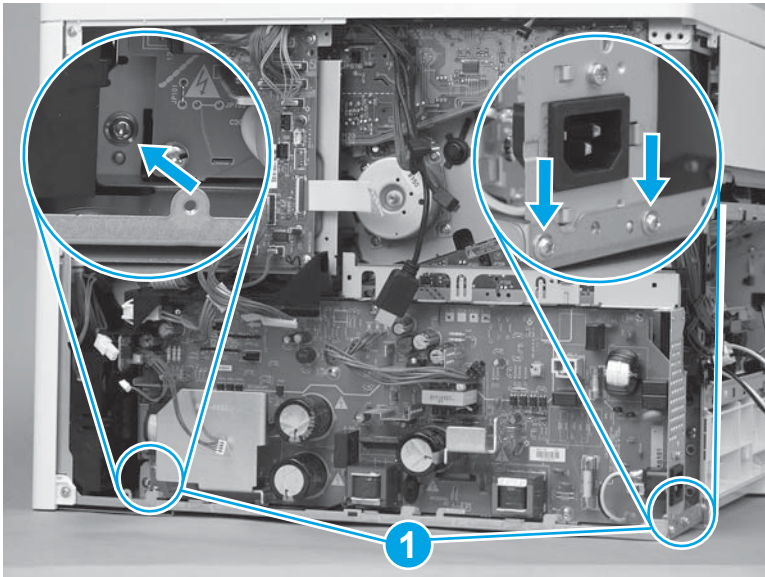

5. Rotate the top of the LVPS away from the printer (callout 1), and then slide it up and out (callout 2) of the printer to remove it.

Figure 1-4370 Remove the LVPS

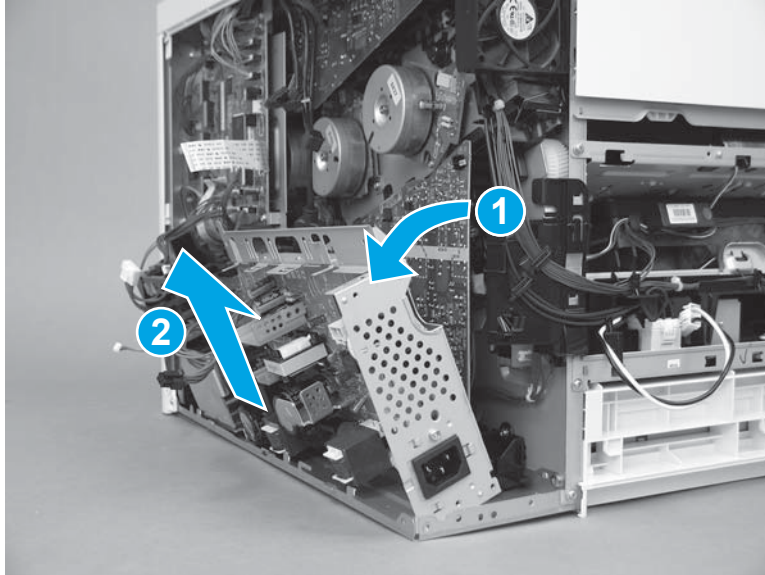

Step 25: Remove the power supply fan (FM1)

1. Remove one screw (callout 1).

Figure 1-4371 Remove one screw

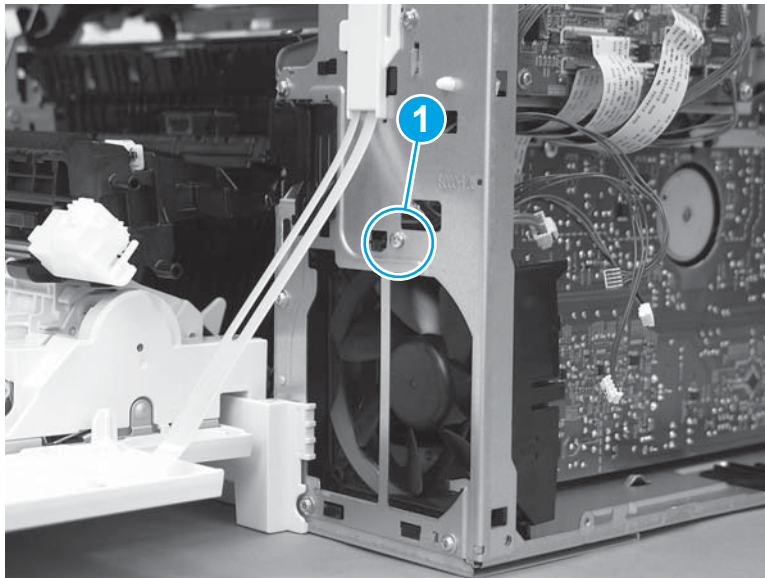

2. Release the wire harnesses from the retainer on the top of the fan bracket.

Figure 1-4372 Release the wire harnesses

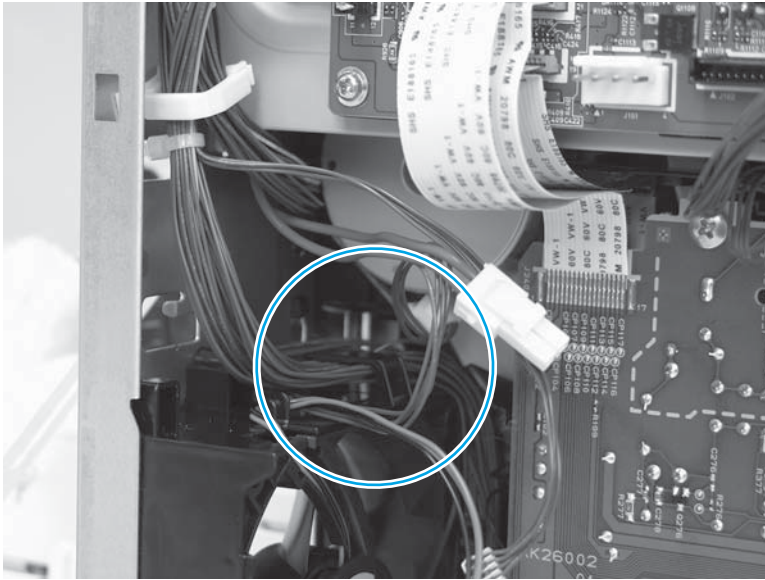

3. Lift the fan up (callout 1), and then slide it out of the printer (callout 2) to remove it.

Figure 1-4373 Remove the fan

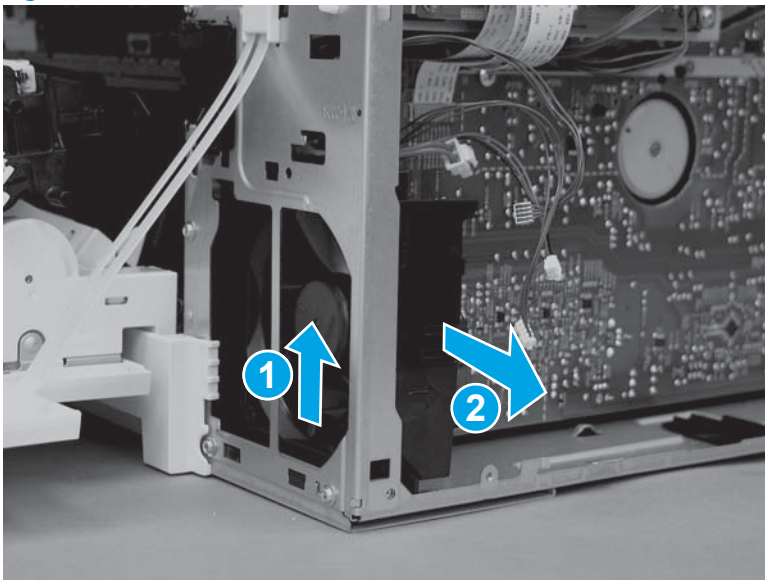

Step 26: Remove the high-voltage power supply D (HVPSD)

 **CAUTION:**  ESD-sensitive part.

1. Disconnect one flat cable (callout 1) on the DC controller.

Figure 1-4374 Disconnect one flat cable

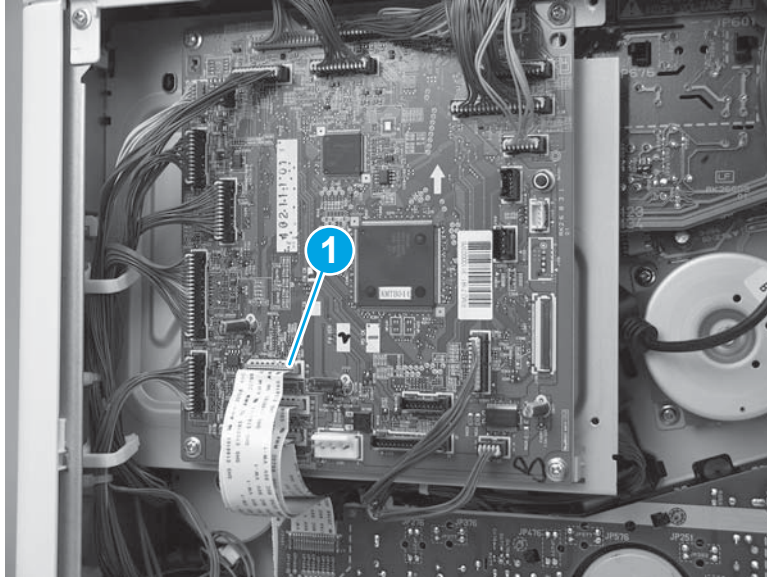

2. Remove two screws (callout 1), and then remove one self tapping screw (callout 2) on the HVPSD.

Figure 1-4375 Remove three screws

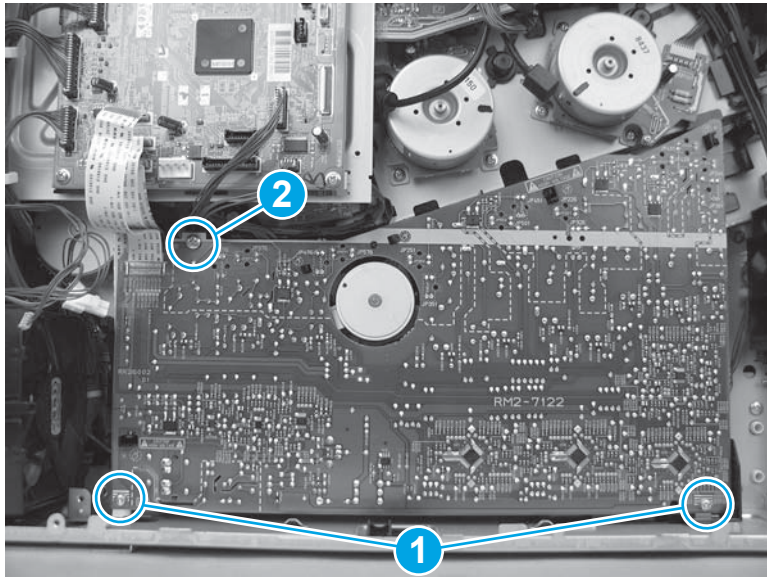

3. Release five tabs (callout 1), and then remove the HVPSD (callout 2).

Figure 1-4376 Remove the HVPSD

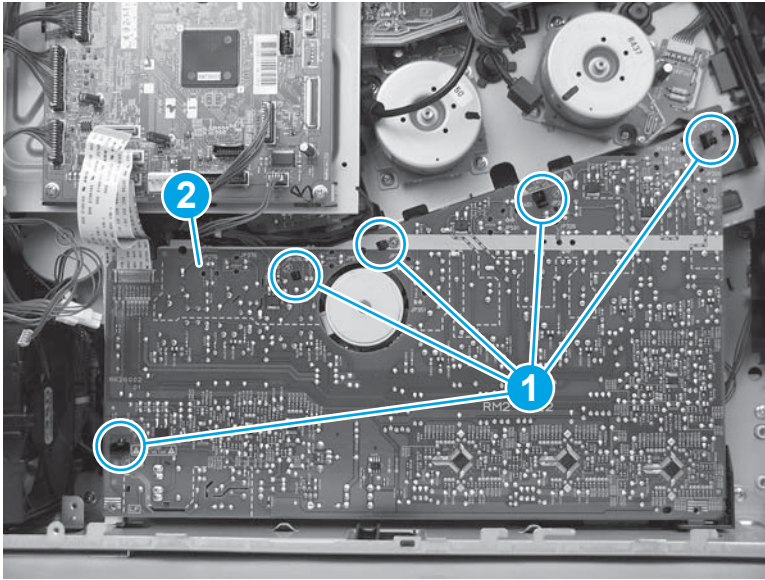

Step 27: Remove the lifter drive assembly

1. Disconnect two connectors (callout 1).

Figure 1-4377 Disconnect two connectors

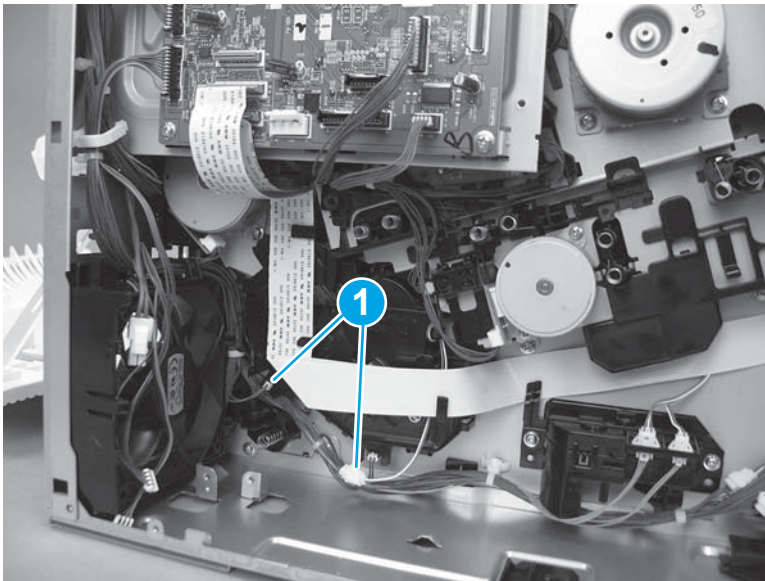

2. Disconnect two flat cables (callout 1), and then release them from the retainers (callout 2).

Figure 1-4378 Disconnect two flat cables

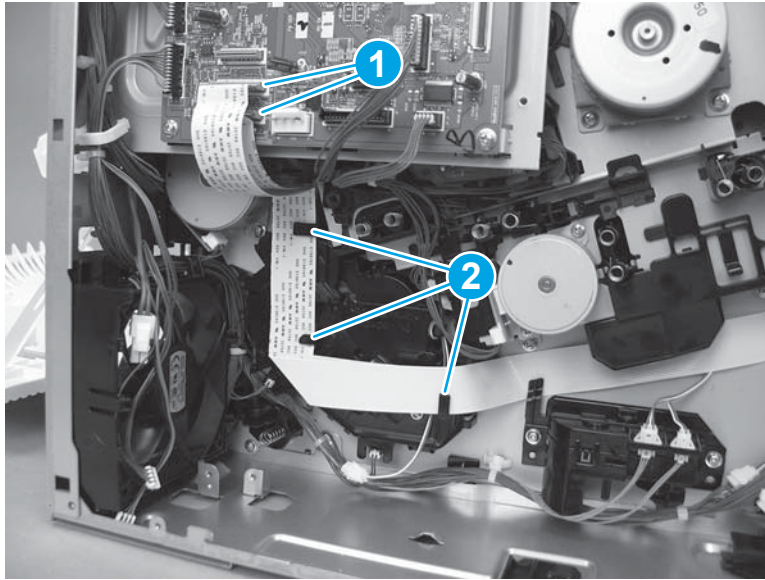

3. Remove two screws (callout 1), release one tab (callout 2), and then remove the lifter drive assembly (callout 3).

 **NOTE:** Release one wire harness from the retainer (callout 4) as the assembly is removed.

Figure 1-4379 Remove the assembly



Step 28: Remove the DC controller and sheet-metal bracket

 **CAUTION:**  ESD sensitive part.

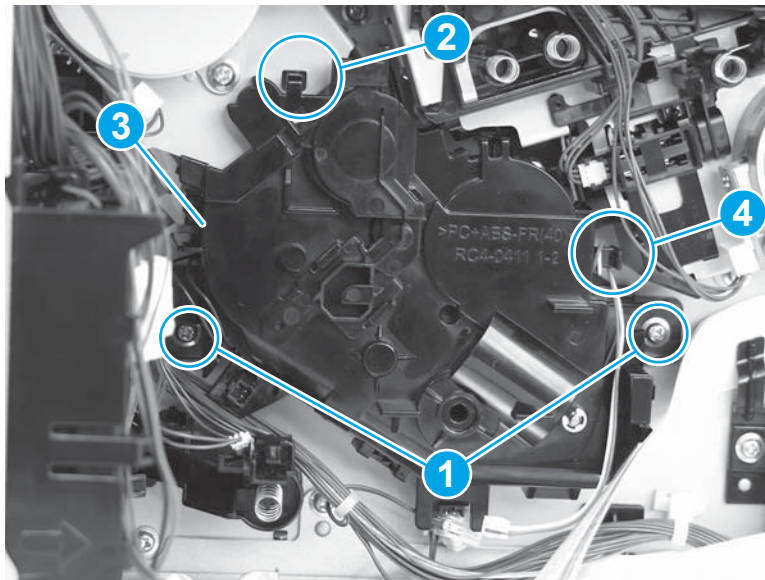
1. Disconnect all of the connectors, and then remove two screws (callout 1).

The following connectors are empty:

- J140, J141, and J143

Figure 1-4380 Remove two screws

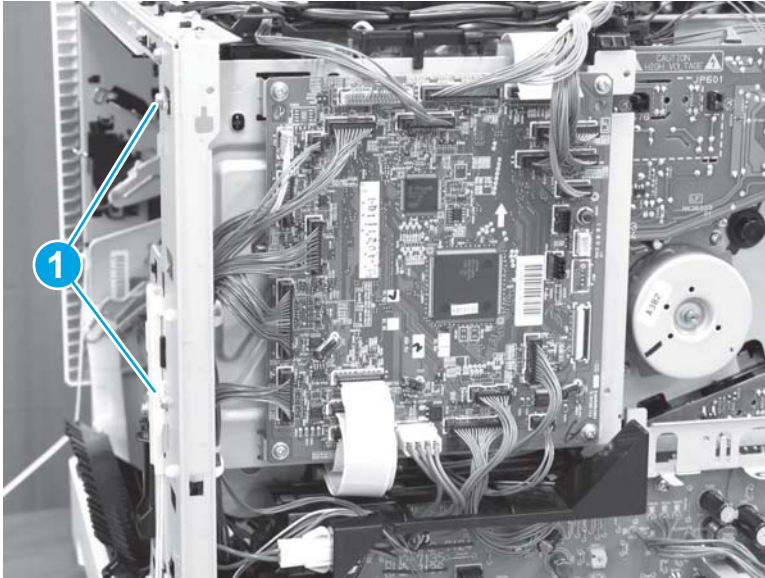

2. Lift up on the DC controller and sheet-metal plate to remove it.

Figure 1-4381 Remove the plate

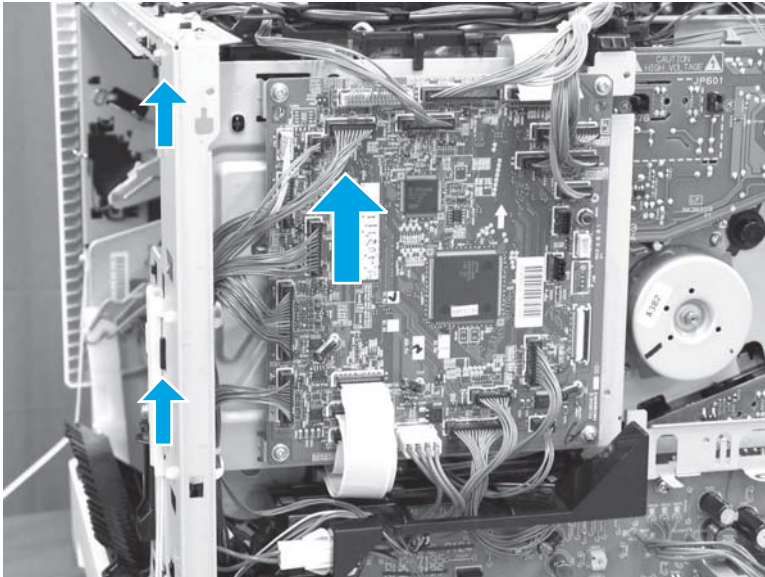

Step 29: Remove the pickup drive assembly and motor (M5)

1. Release one tab (callout 1), and then move the guide (callout 2) out of the way.

Figure 1-4382 Move the guide out of the way

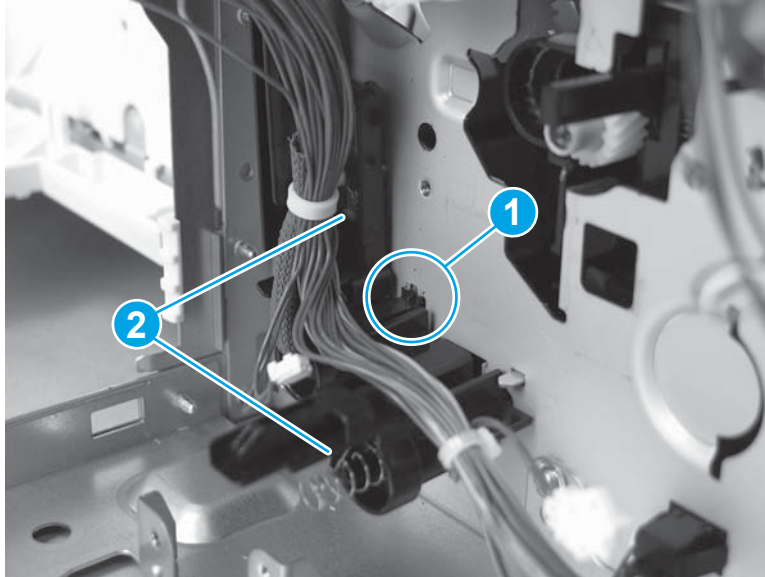

2. Remove three screws (callout 1).

Figure 1-4383 Remove three screws

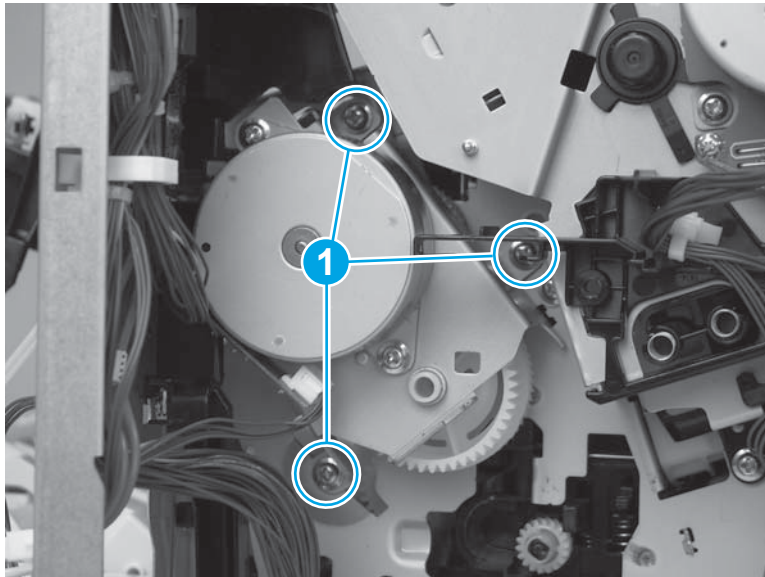

3. Remove the assembly.

⚠ CAUTION: One gear on the back side of the assembly is not captive. Handle the assembly carefully.

Figure 1-4384 Remove the assembly

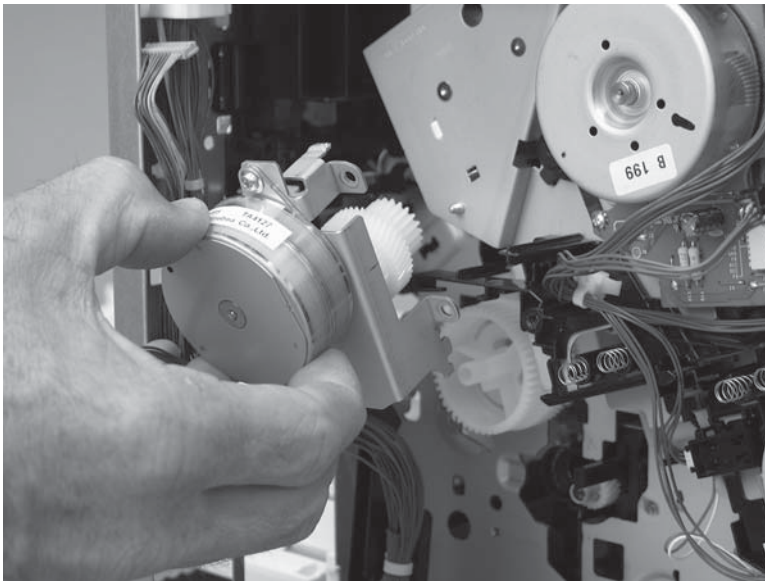

4. If the gear (callout 1) was not removed with the assembly in the previous step, remove it now.

Figure 1-4385 Remove the gear if installed

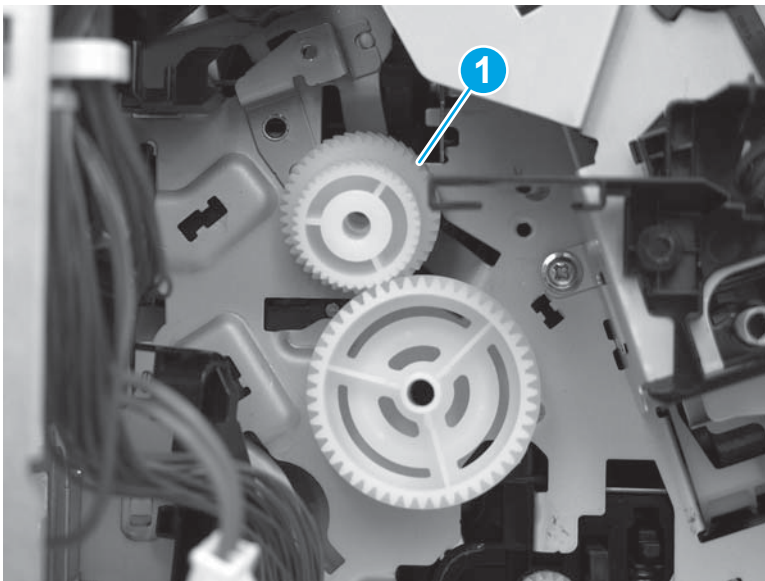

Step 30: Remove the registration assembly

1. At the right side of the printer, release one tab (callout 1).

Figure 1-4386 Release one tab

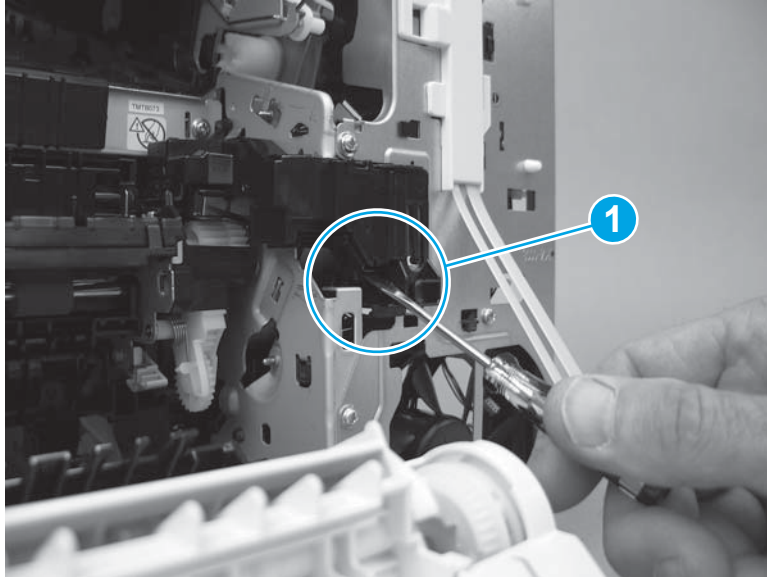

2. Remove the cover.

Figure 1-4387 Remove the cover

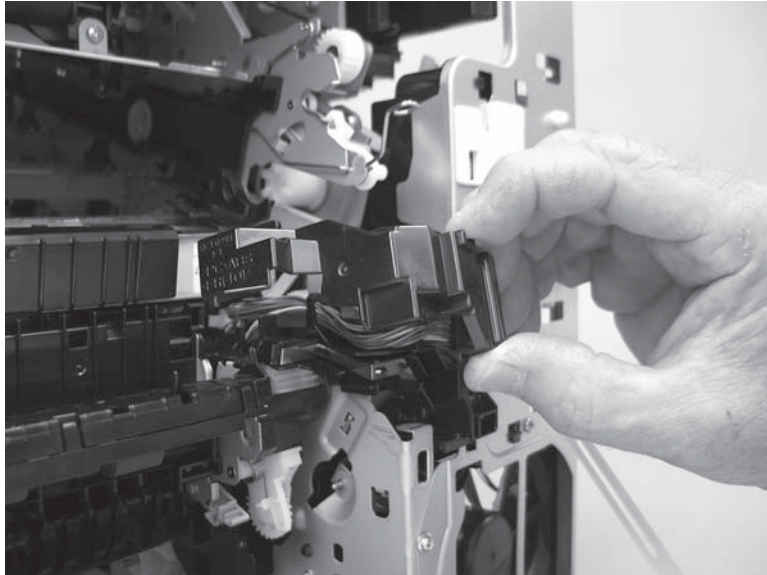

3. Release one tab (callout 1), and then push down on the guide (callout 2) to release it.

Figure 1-4388 Release the guide

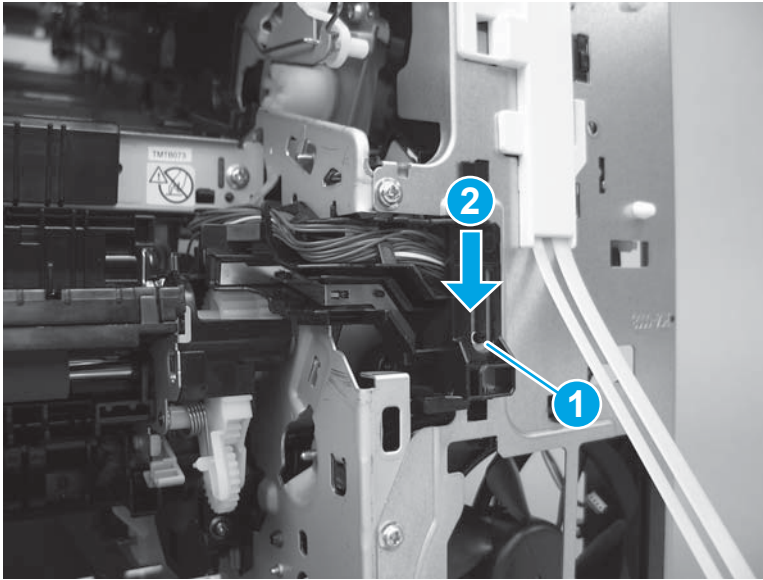

4. Move the guide out of the way.

Figure 1-4389 Move the guide out of the way

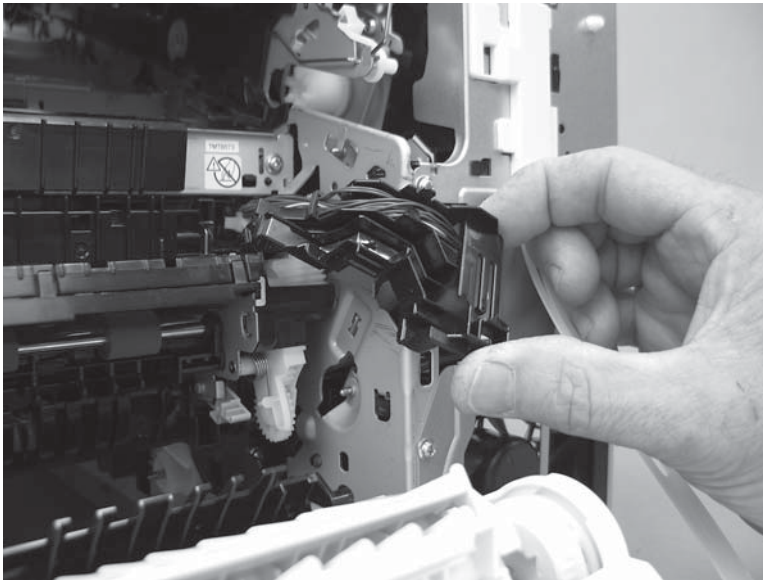

5. Remove three screws (callout 1).

Figure 1-4390 Remove three screws

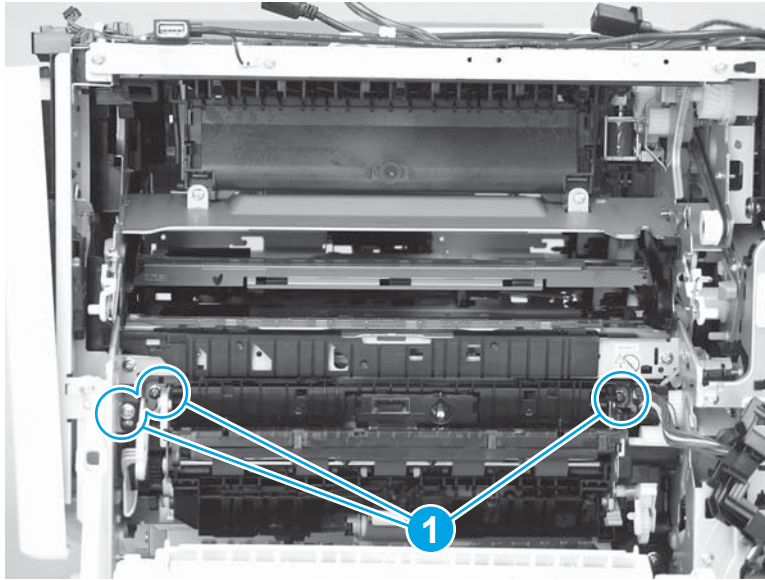

6. Before proceeding, locate the sheet metal portion (callout 1) of the assembly. When handling the assembly, use the sheet metal as handles.

Figure 1-4391 Locate the sheet metal portion of the assembly

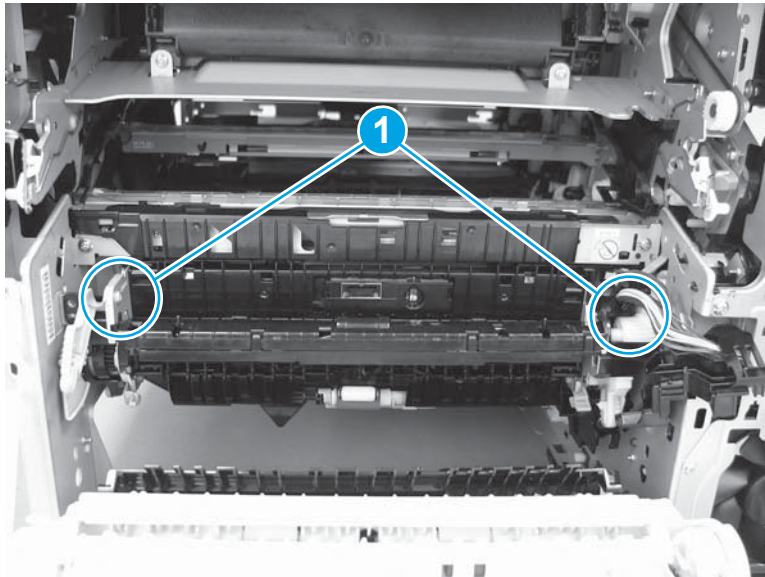

7. Before proceeding, take note of the sheet-metal tabs (callout 1) on the back of the assembly—the figure shows the assembly removed so the tabs can be viewed—that fasten it to the chassis.

Figure 1-4392 Take note of the sheet-metal tabs

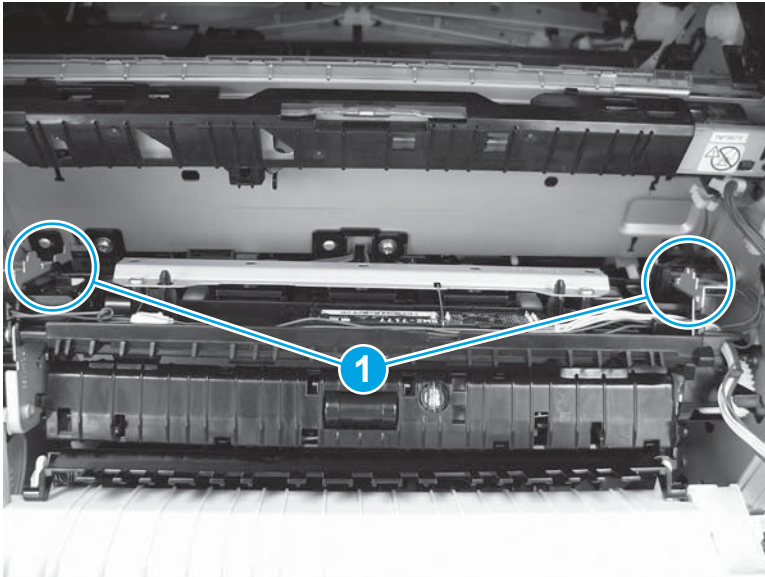

8. Grasp the sheet-metal handles (callout 1), and then rotate the top of the assembly away from the chassis (callout 2) to release the top tabs.

Figure 1-4393 Rotate the top of the assembly away from the chassis

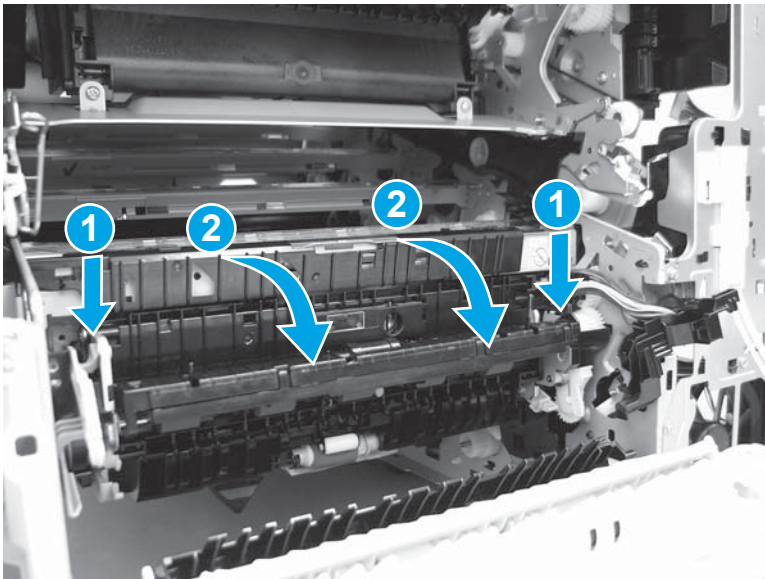

9. Pull up on the assembly to release the bottom tabs.

CAUTION: The assembly is still attached to the printer by a wire harness. Do not attempt to completely remove the assembly.

Figure 1-4394 Release the bottom tabs

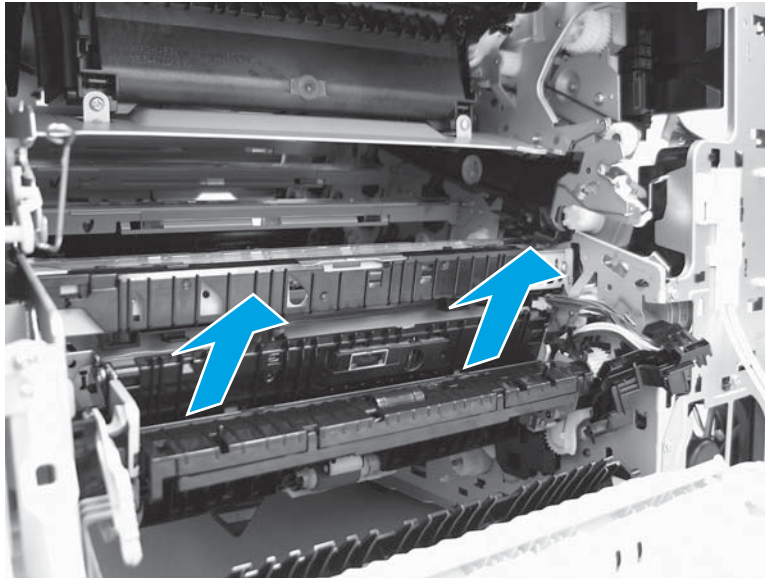

10. Turn the registration assembly over to access the back side, disconnect three connectors (callout 1), and then remove the assembly.

Figure 1-4395 Remove the assembly

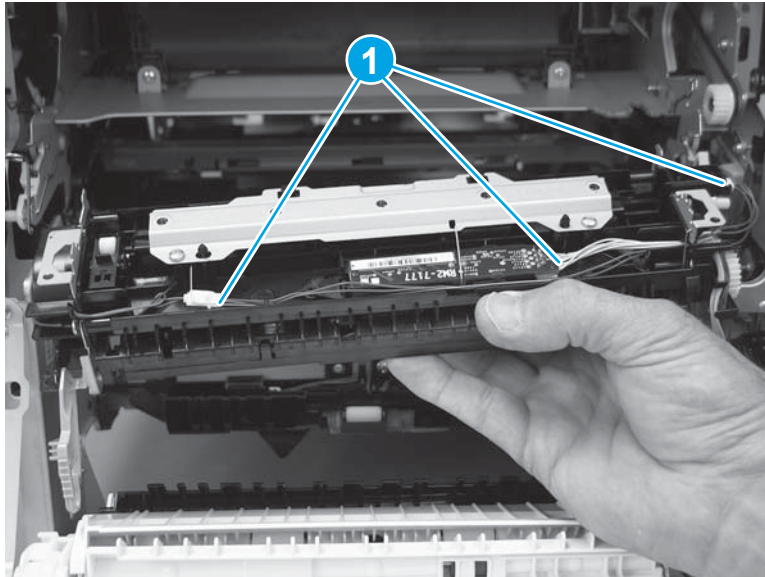

Step 31: Remove the density-detect assembly

1. Remove one screw (callout 1).

Figure 1-4396 Remove one screw

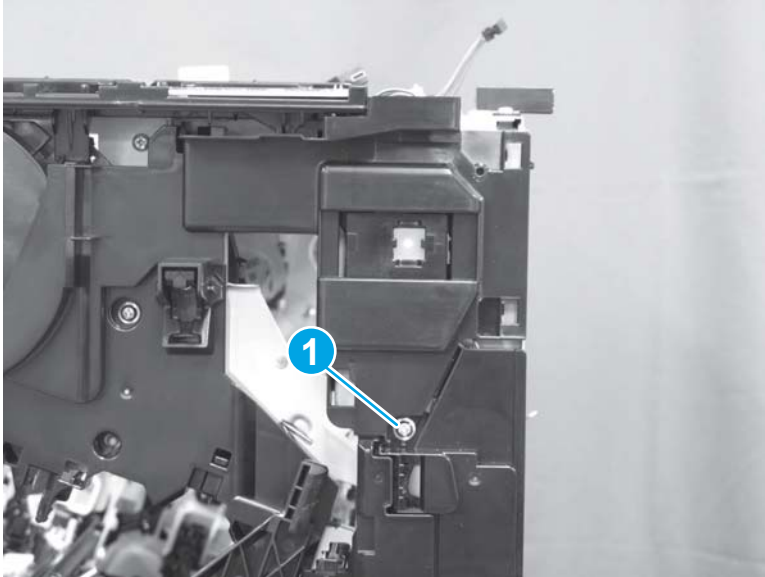

2. Release two tabs (callout 1), and then remove the cover (callout 2).

Figure 1-4397 Remove the cover

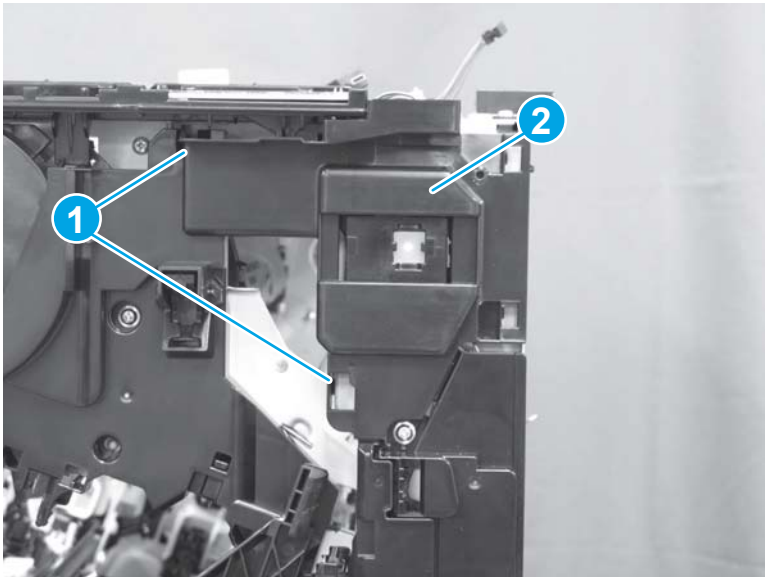

3. Remove one screw (callout 1), and then remove the cover (callout 2).

Figure 1-4398 Remove the cover

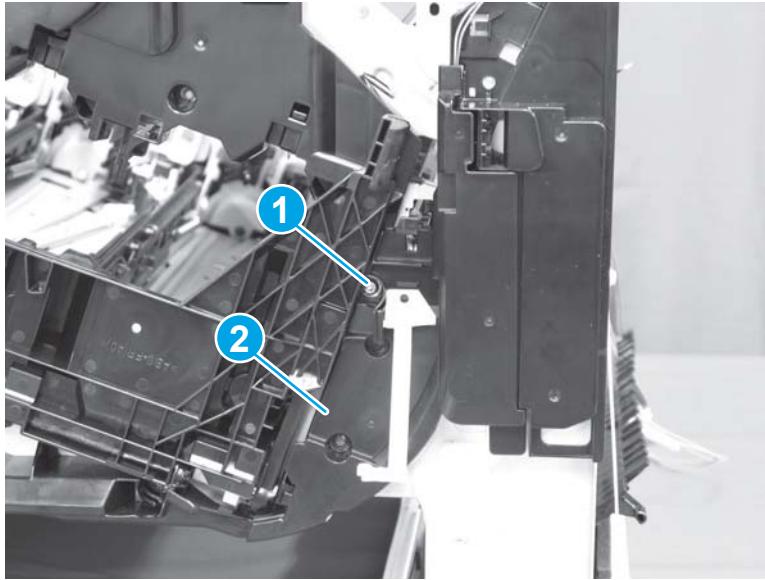

4. Remove two screws (callout 1), and then remove the density-detect assembly (callout 2).

Figure 1-4399 Remove the assembly

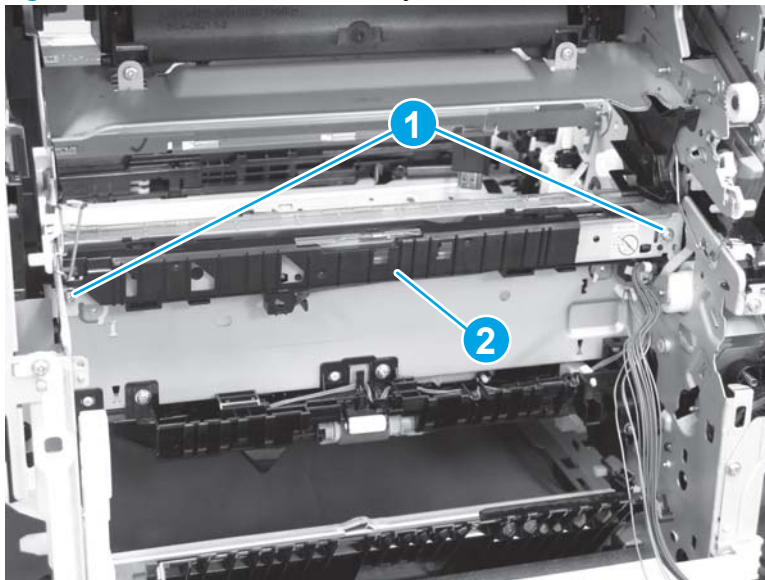

Step 32: Unpack the replacement assembly

Unpack the replacement assembly from the packaging.

For complete information on HP's recycling programs, go to [Product return and recycling](#).

CAUTION: When handling the assembly, take care not to wipe any of the grease off of the gears on the back side of the assembly.

NOTE: HP recommends responsible disposal of the defective assembly.

Figure 1-4400 Recycle and unpack

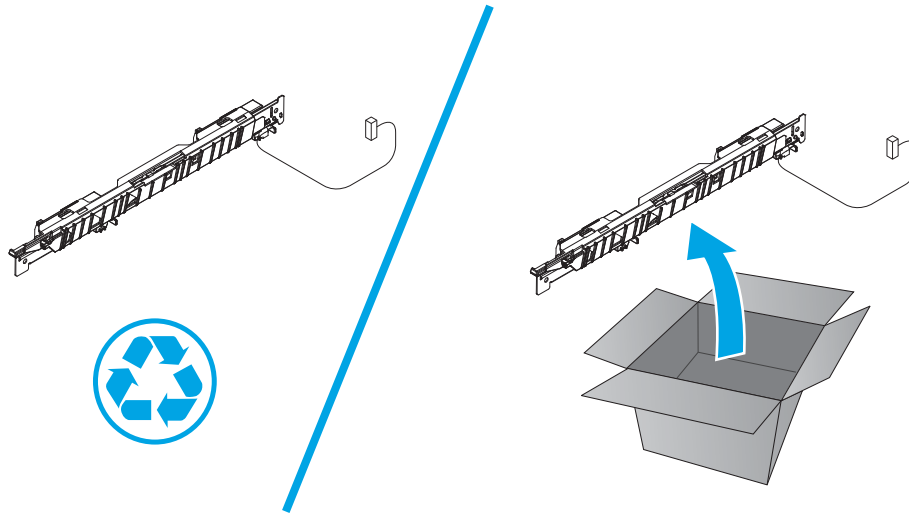

Step 33: Install the density-detect assembly

1. Position the density-detect assembly on the printer (callout 1), and then install two screws (callout 2).

Figure 1-4401 Install the assembly

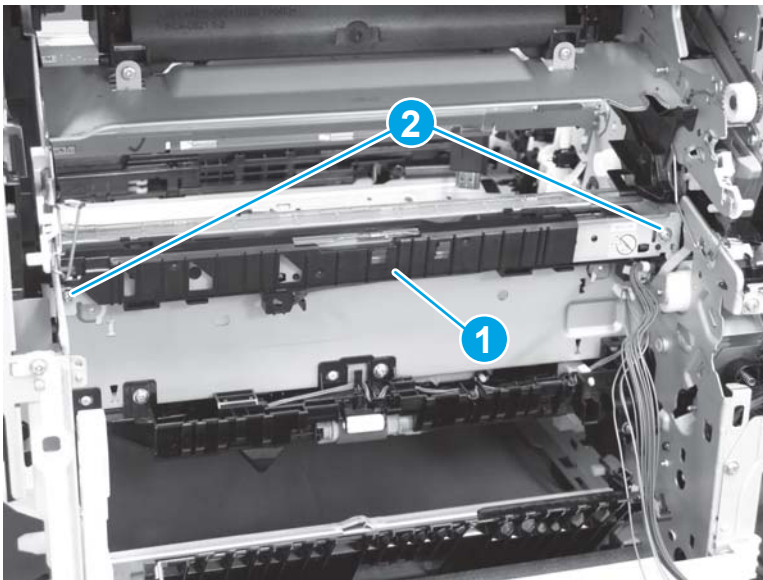

2. Install the cover (callout 1) on the printer, and then install one screw (callout 2).

Figure 1-4402 Install the cover

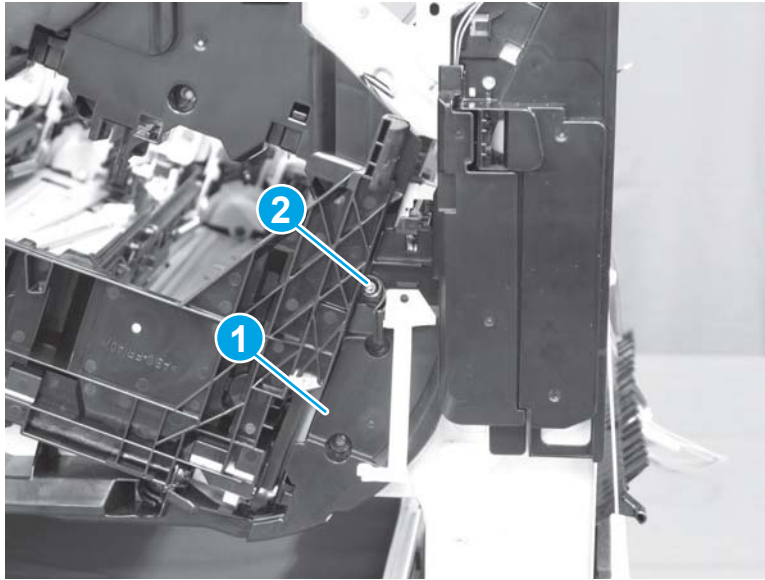

3. Install the cover (callout 1), and then make sure that two tabs (callout 2) snap into place.

Figure 1-4403 Install the cover

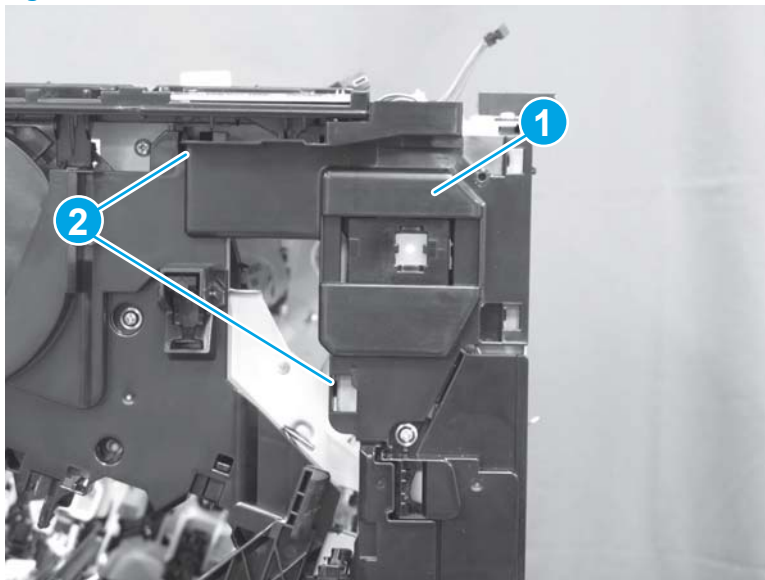

4. Install one screw (callout 1).

Figure 1-4404 Install one screw

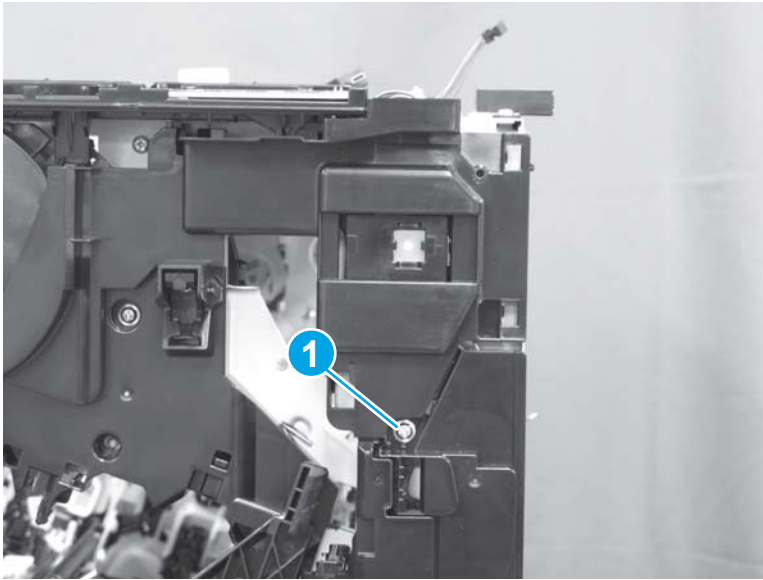

Step 34: Install the registration assembly

1. Turn the registration assembly over to access the back side, and then connect three connectors (callout 1).

Figure 1-4405 Connect three connectors

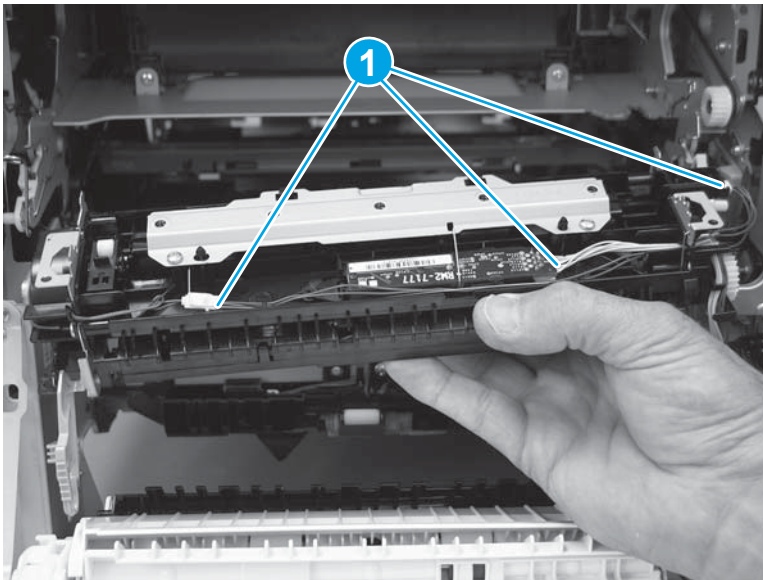

2. Align the tabs on the assembly with the slots in the chassis.

Figure 1-4406 Align the tabs on the assembly with the slots

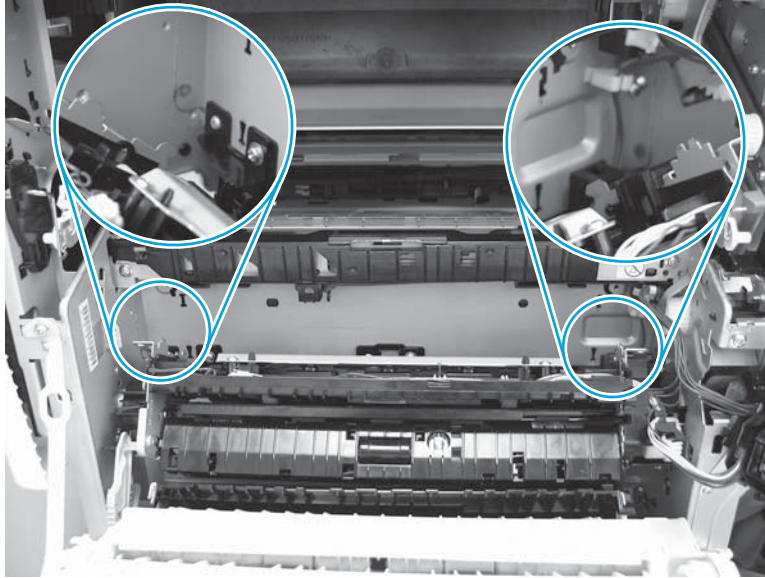

3. Position the bottom tabs in the appropriate slots, and then push down on the assembly to engage them.

Figure 1-4407 Install the bottom tabs

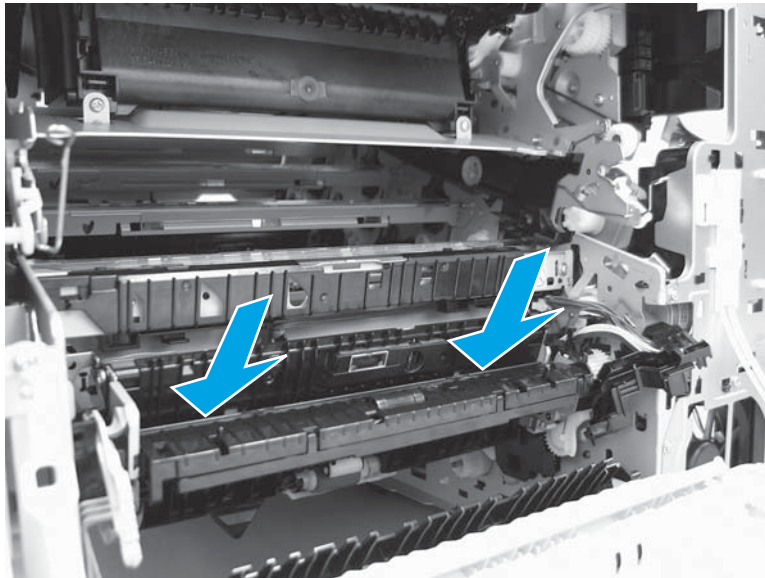

4. Grasp the sheet-metal handles (callout 1) to rotate the top of the assembly toward the chassis (callout 2) to install the top tabs.

Figure 1-4408 Install the top tabs

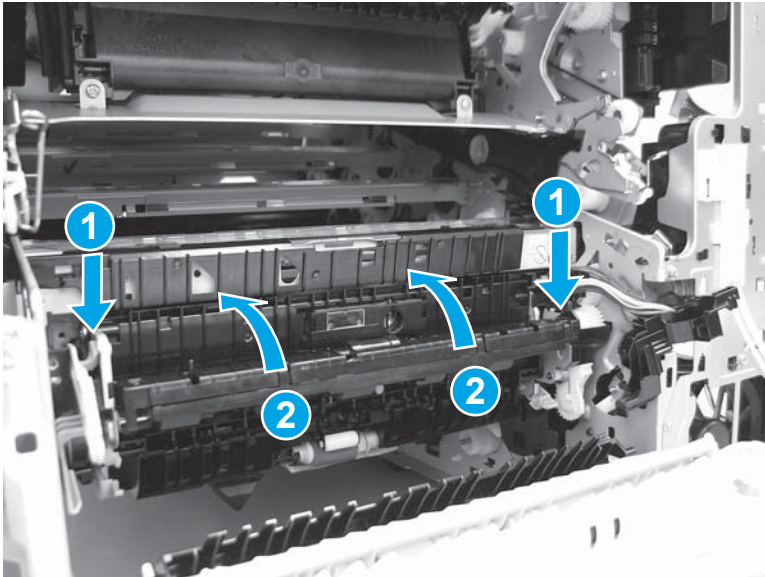

5. Install three screws (callout 1).

Figure 1-4409 Install three screws

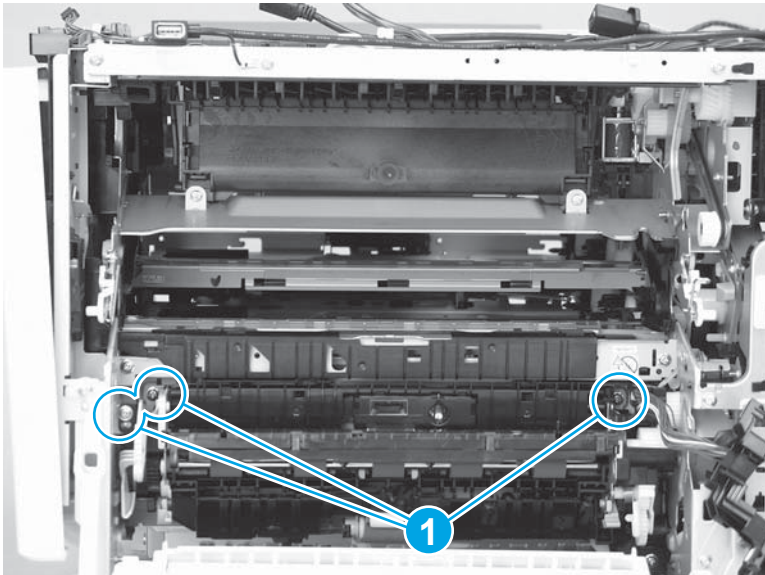

6. Position the guide on the chassis.

Figure 1-4410 Position the guide on the product

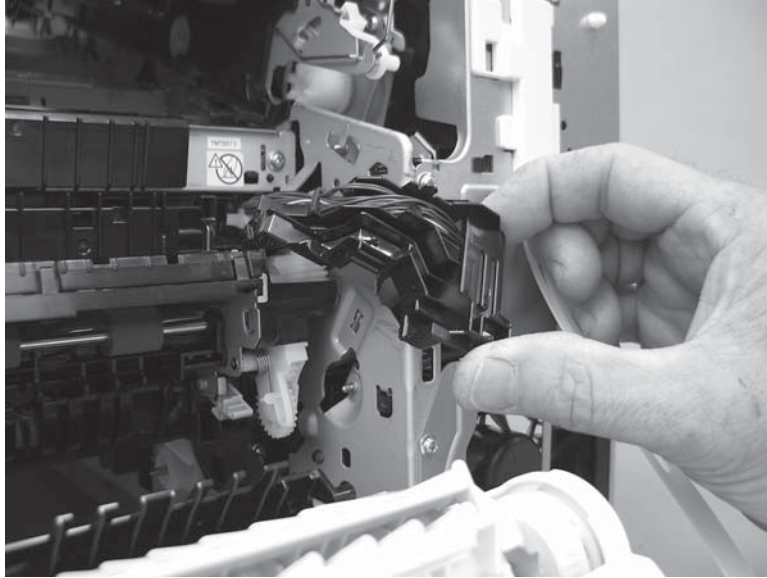

7. Slide the guide up to install it (callout 1), and then make sure that the tab (callout 2) snaps into place.

Figure 1-4411 Install the guide

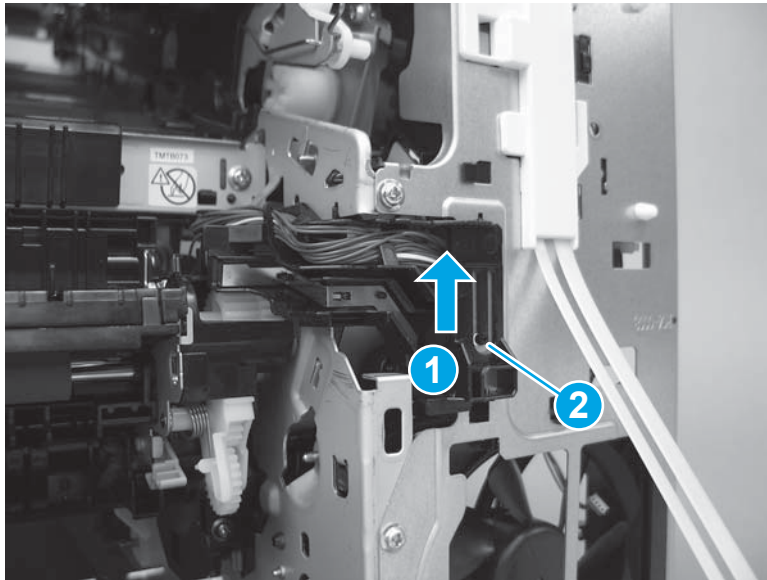

8. Position the cover on the printer.

Figure 1-4412 Position the cover on the product

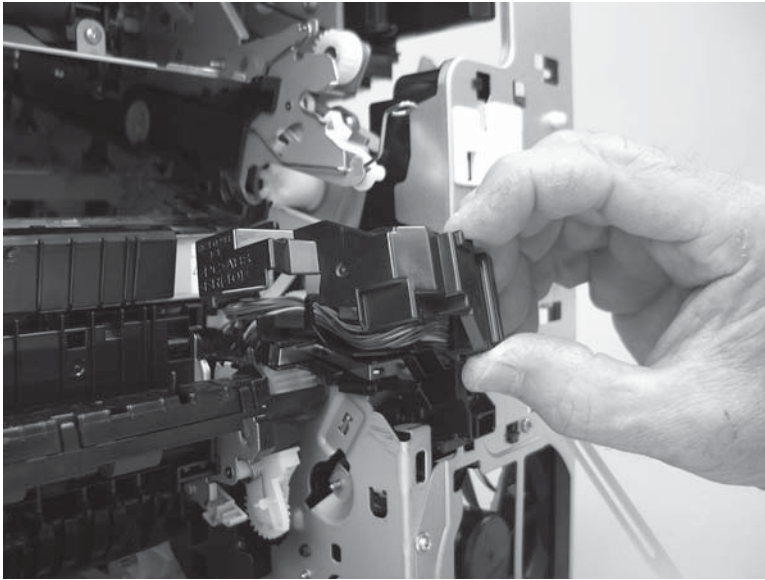

9. Install the cover, and then make sure that the tab (callout 1) snaps into place.

Figure 1-4413 Install the cover

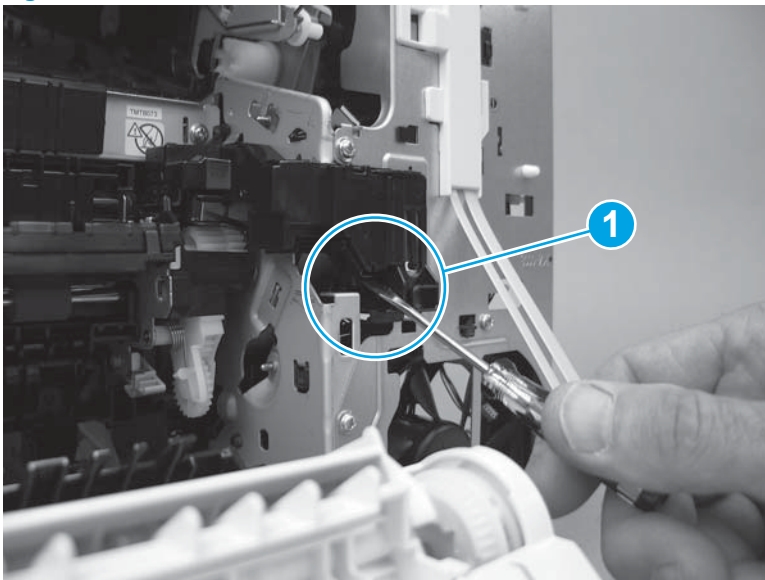

Step 35: Install the pickup drive assembly and motor (M5)

1. Before installing the assembly, check to see if a gap exists (callout 1) between the gears.

 **NOTE:** If no gap exists, go to step [3](#) in this section.

Figure 1-4414 Check the gears for a gap

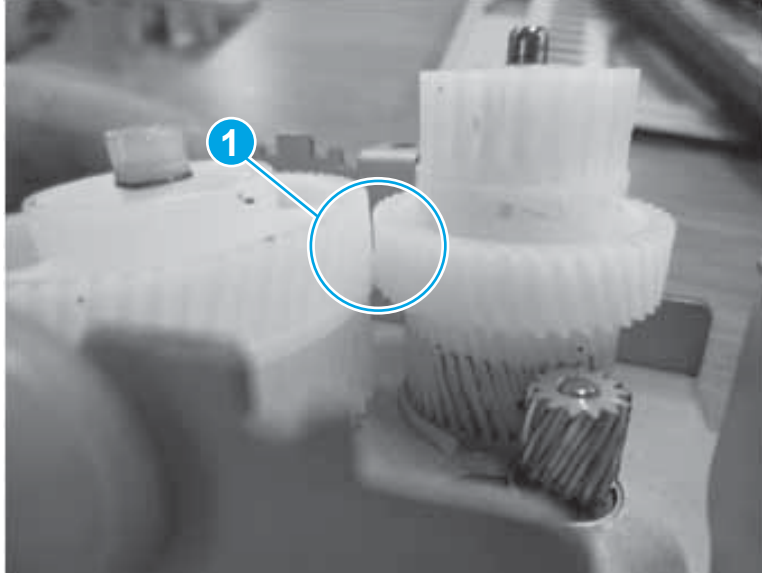

2. Adjust the gears on the assembly to remove the gap (callout 1).

Figure 1-4415 Adjust the gears

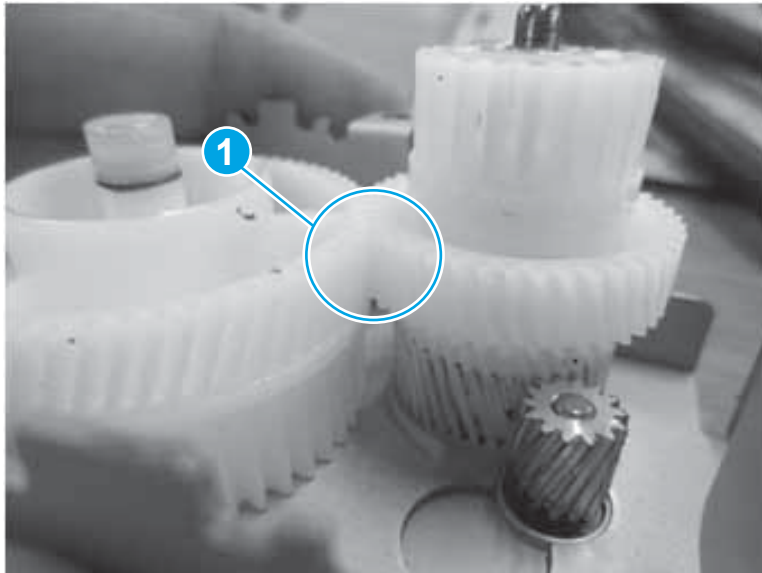

3. Align the tabs on the pickup drive assembly with the slots in the chassis, and then install the assembly on the printer.

 **IMPORTANT:** The figure below shows the large gear of the assembly already installed on the printer chassis. However it is easier to install the pickup drive assembly if the gear is installed on the assembly.

 **TIP:** With the right door open, look into the printer and verify that the mounting bracket for the assembly is correctly installed against the chassis.

Figure 1-4416 Install the assembly



4. Install three screws (callout 1).

Figure 1-4417 Install three screws

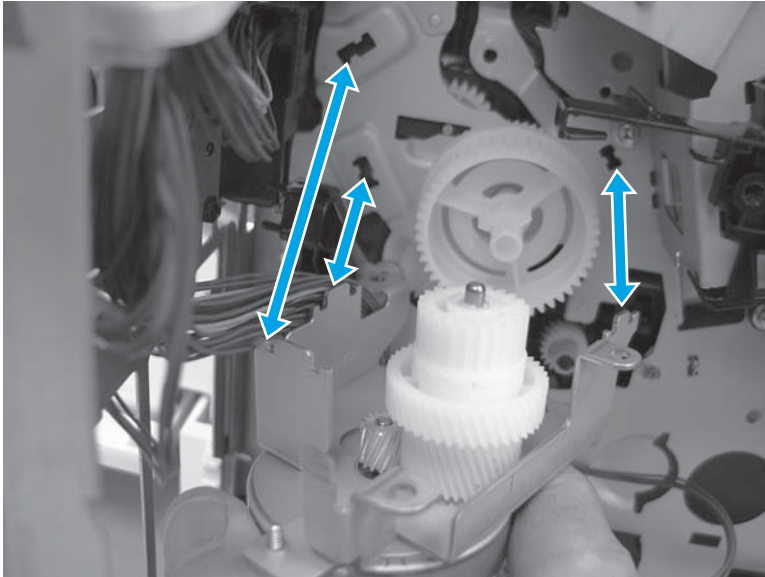
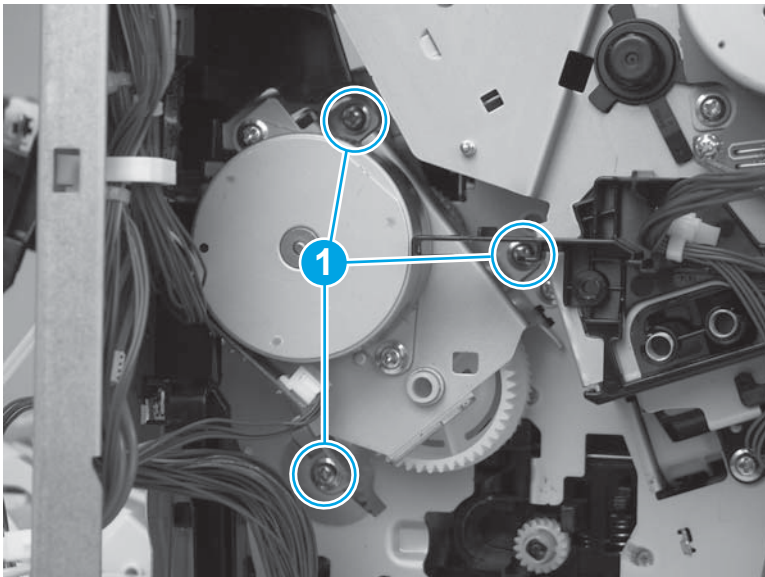

5. Install the guide (callout 1). Make sure that the tab (callout 2) snaps into place.

Figure 1-4418 Install the guide

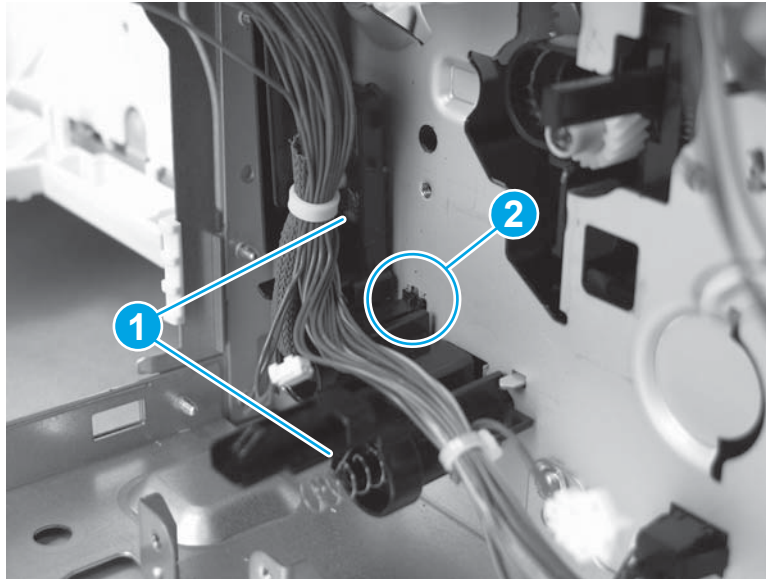

Step 36: Install the DC controller and sheet-metal bracket

CAUTION:  ESD-sensitive part.

1. Position the DC controller and sheet-metal plate on the printer, and then push down to engage the plate with the chassis.

Figure 1-4419 Install the plate

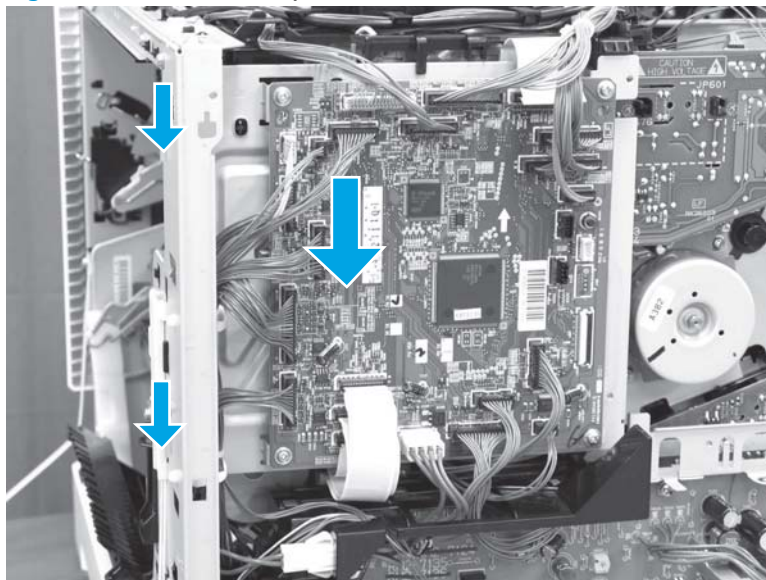

2. Install two screws (callout 1), and then connect all of the connectors.

The following connectors are empty:

- J140, J141, and J143

Figure 1-4420 Install two screws

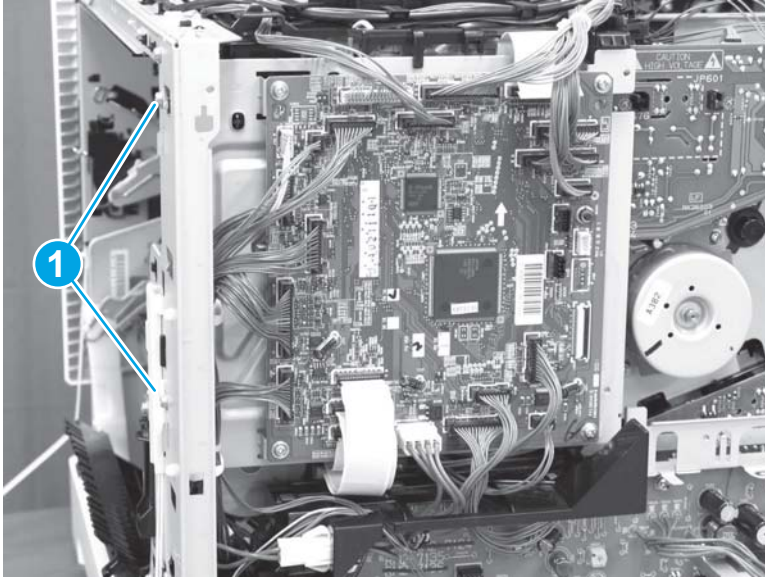

Step 37: Install the lifter drive assembly

1. Install one wire harness on the retainer (callout 1), position the lifter drive assembly in the printer (make sure that one tab (callout 2) snaps into place), and then install two screws (callout 3).

 **TIP:** It might be easier to install the assembly if the bottom of the assembly is installed first, and then the top of the assembly is rotated into place.

Figure 1-4421 Install the lifter drive



2. Connect two flat cables (callout 1), and then place them in the retainers (callout 2).

Figure 1-4422 Connect two flat cables

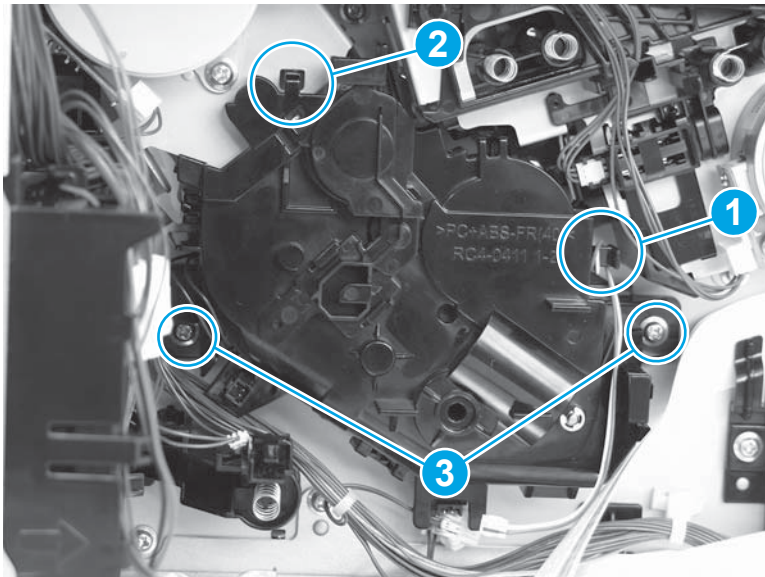
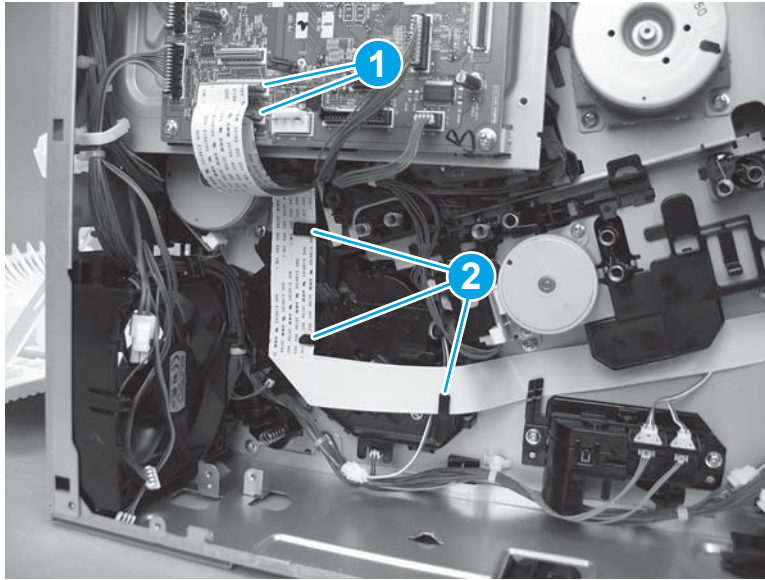

3. Connect two connectors (callout 1).

Figure 1-4423 Connect two connectors

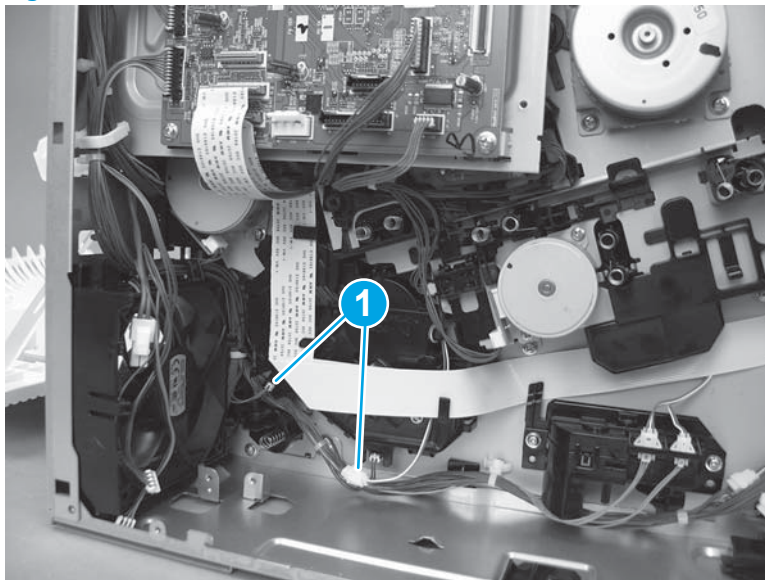

Step 38: Install the HVPSD

 **CAUTION:**  ESD-sensitive part.

1. Position the bottom right corner of the HVPSD (callout 1) behind the black tab, and then rotate it up and onto the printer (callout 2).

Figure 1-4424 Install the HVPSD

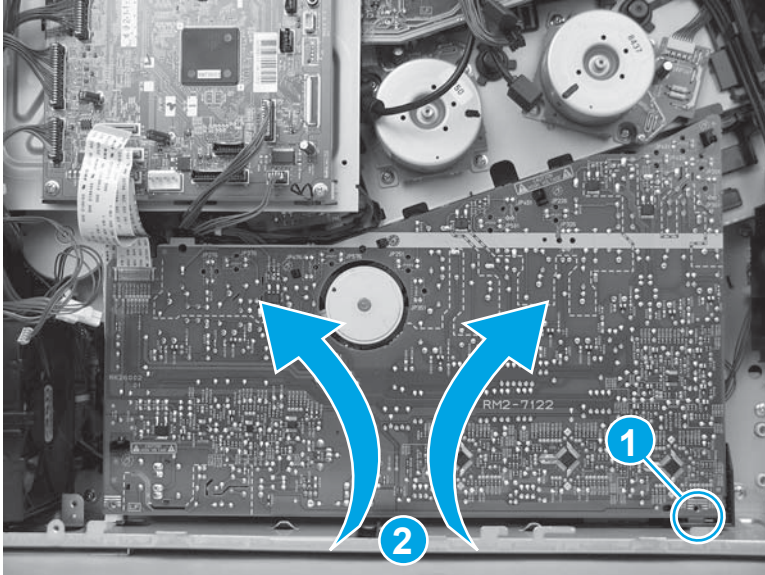

2. Press it onto five tabs (callout 2).

 **IMPORTANT:** Make sure that all five tabs snap into place.

Figure 1-4425 Press the tabs



3. Install two screws (callout 1), and then install one self tapping screw (callout 2) on the HVPSD.

Figure 1-4426 Install three screws

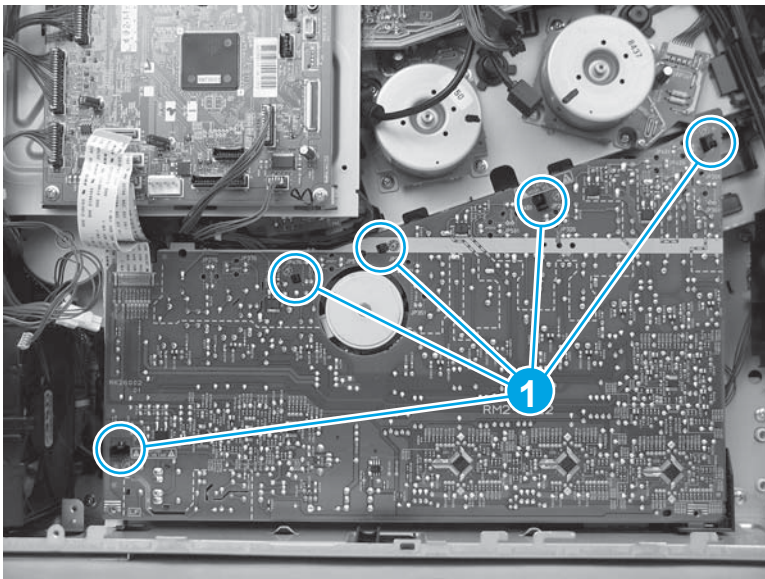
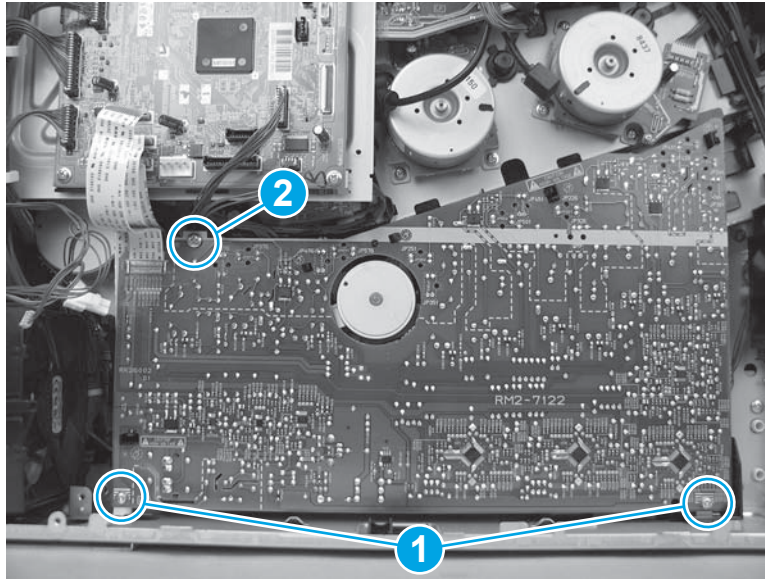

4. Connect one flat cable (callout 1) on the DC controller.

Figure 1-4427 Connect one flat cable

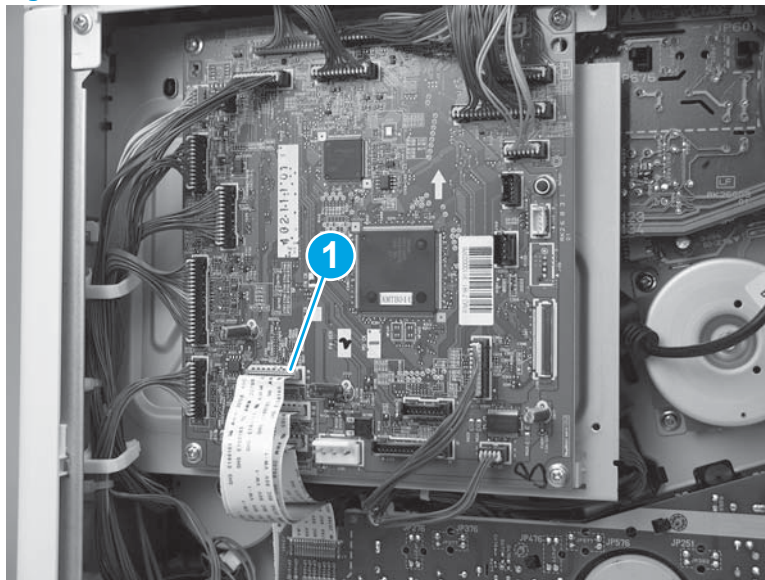

Step 39: Install the power-supply fan (FM1)

1. Slide the fan in (callout 1) and then down (callout 2) into the printer to install it.

 **NOTE:** Make sure that the arrow (callout 3) embossed on the fan holder faces into the printer.

Figure 1-4428 Install the fan



2. Place the wire harnesses in the retainer on the top of the fan bracket.

Figure 1-4429 Place the wire harnesses in the retainer

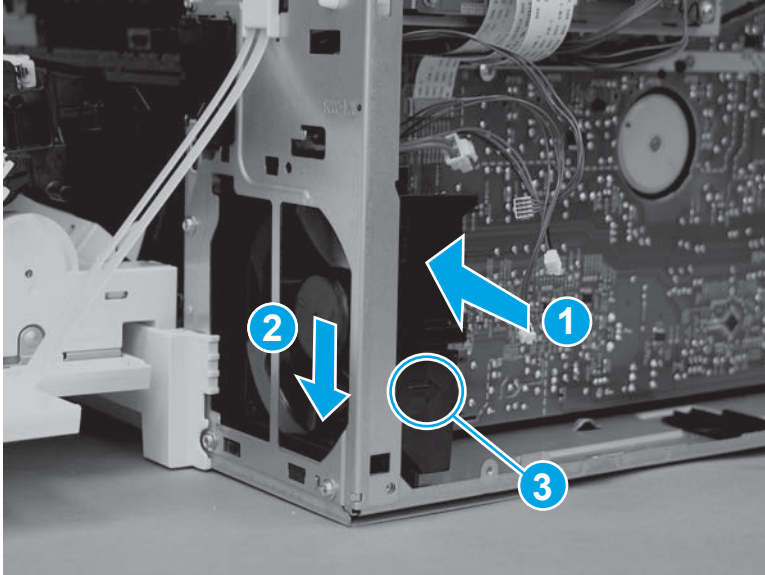
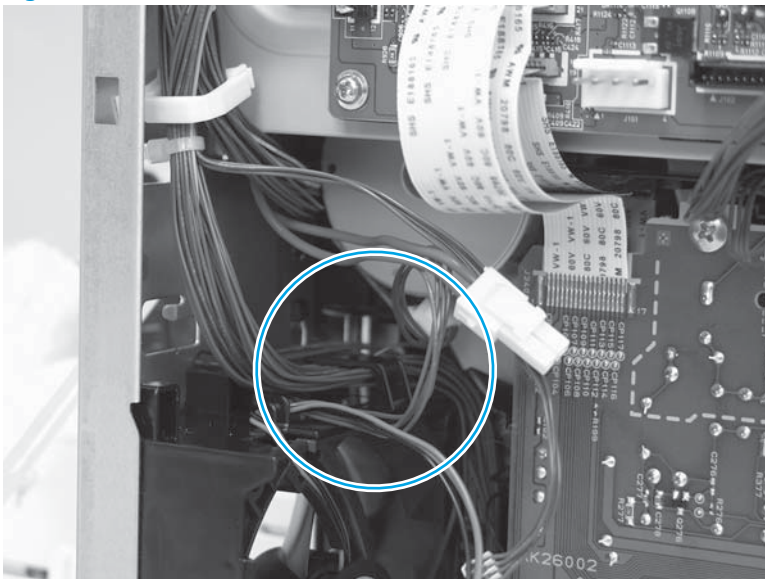

3. Install one screw (callout 1).

Figure 1-4430 Install one screw

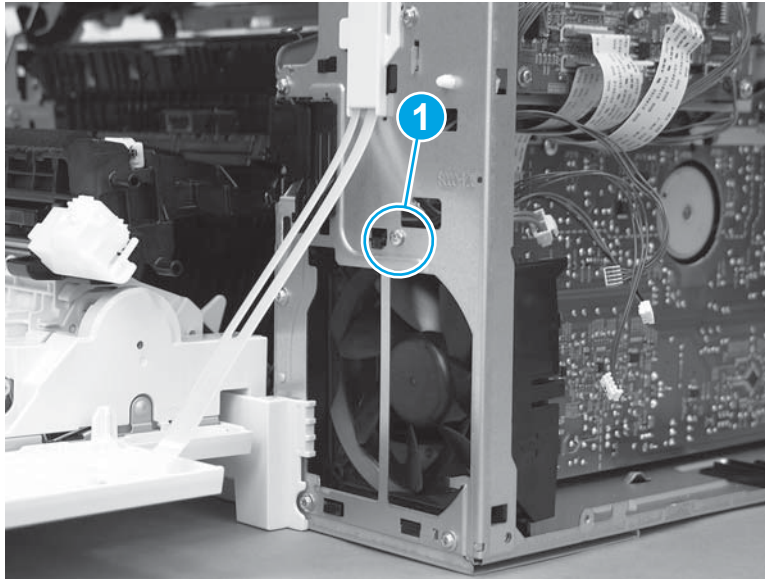

Step 40: Install the LVPS

CAUTION:  ESD-sensitive part.

1. Position the bottom of the LVPS in the printer (callout 1) at a slight angle, and then rotate the top of it into the printer (callout 2) to install it.

Figure 1-4431 Install the LVPS

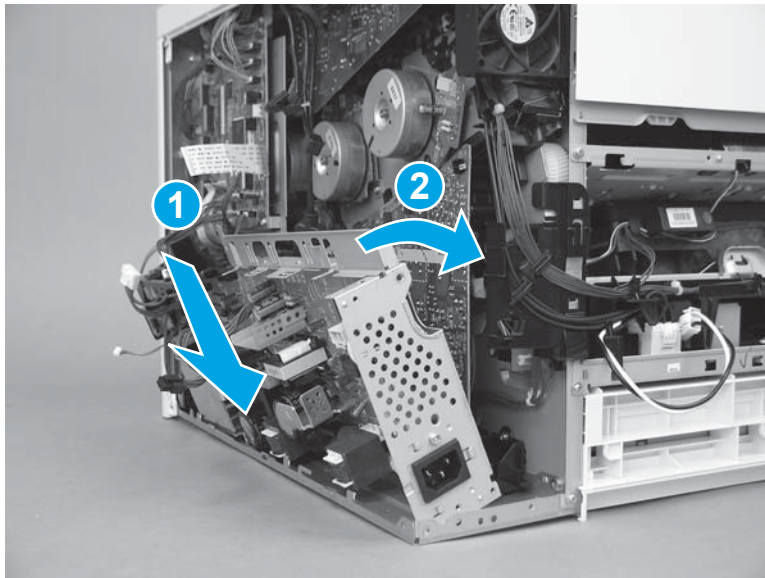

2. Install three screws (callout 1).

Figure 1-4432 Install three screws

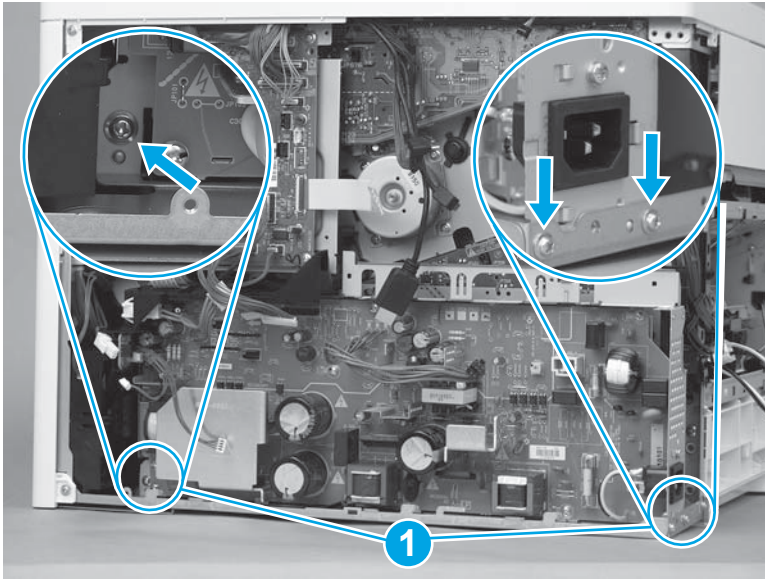

3. Pass the wire harnesses from the DC controller to the LVPS through the opening in the chassis (callout 1), and then install the wire harnesses in the retainer (callout 2).

Figure 1-4433 Pass the wire harnesses through the opening

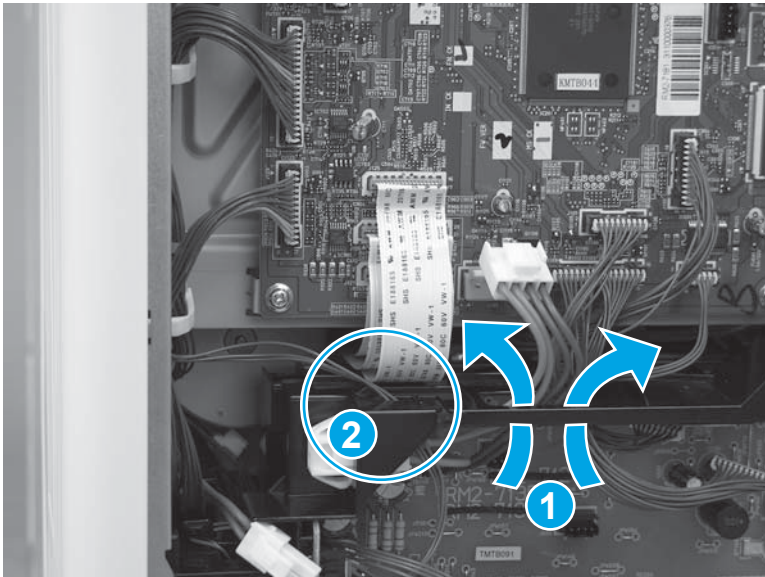

4. Connect three connectors on the DC controller (callout 1), and then connect four connectors (callout 2) on the LVPS.

Figure 1-4434 Connect seven connectors

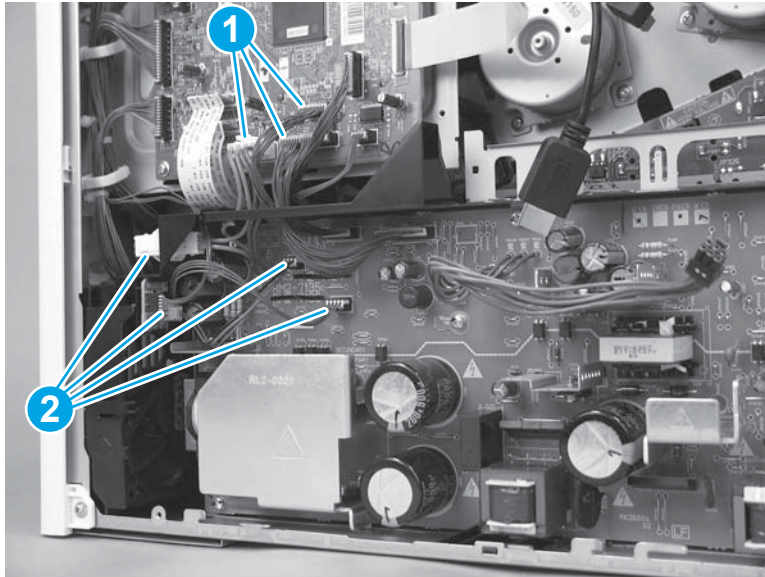

5. Pass the wire harness through the opening (callout 1) in the chassis, and then connect one wire harness (callout 2).

Figure 1-4435 Connect one wire harness

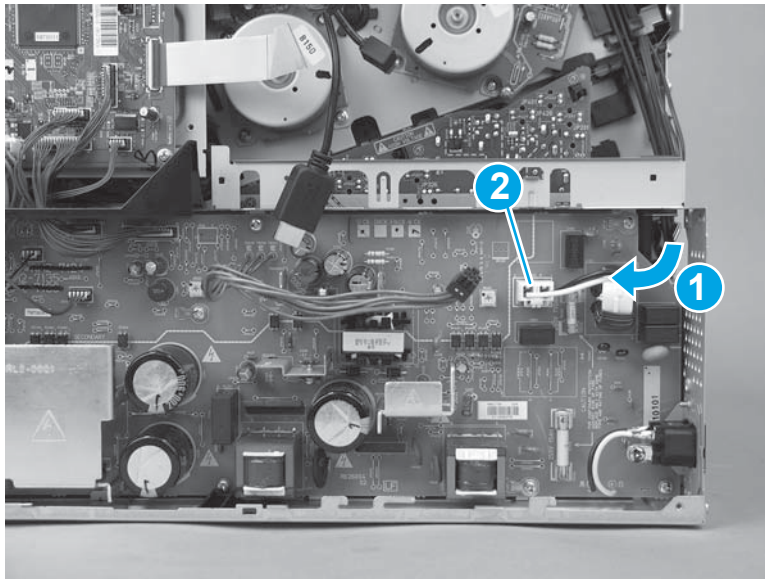

Step 41: Install the formatter case

1. Pass the wire harnesses through the opening in the formatter case.

Figure 1-4436 Pass the wire harnesses through the opening

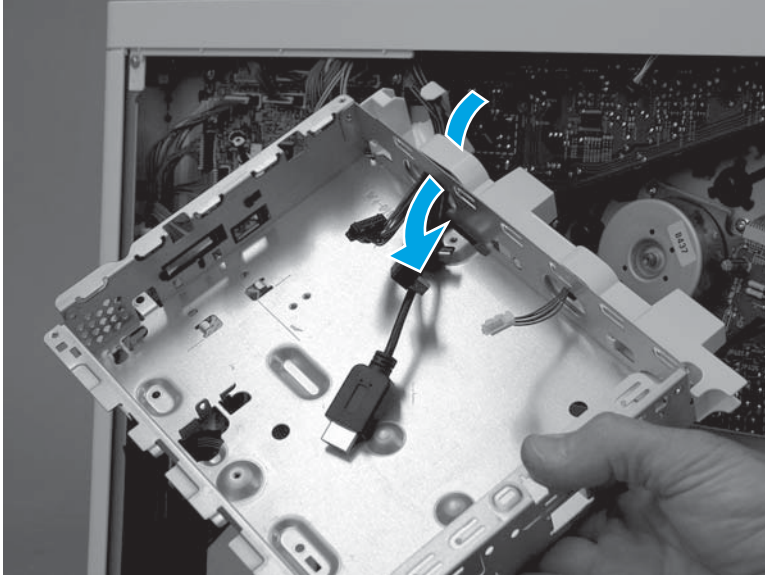

2. Position the top of the formatter case on the printer (callout 1), and then rotate the bottom of the case (callout 2) into the printer.

Figure 1-4437 Install the formatter case

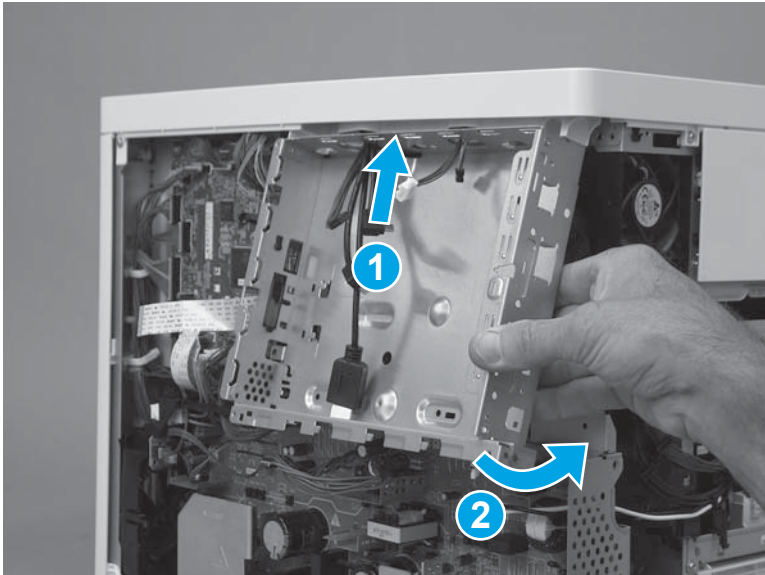

3. Install six screws (callout 1).

Figure 1-4438 Install six screws

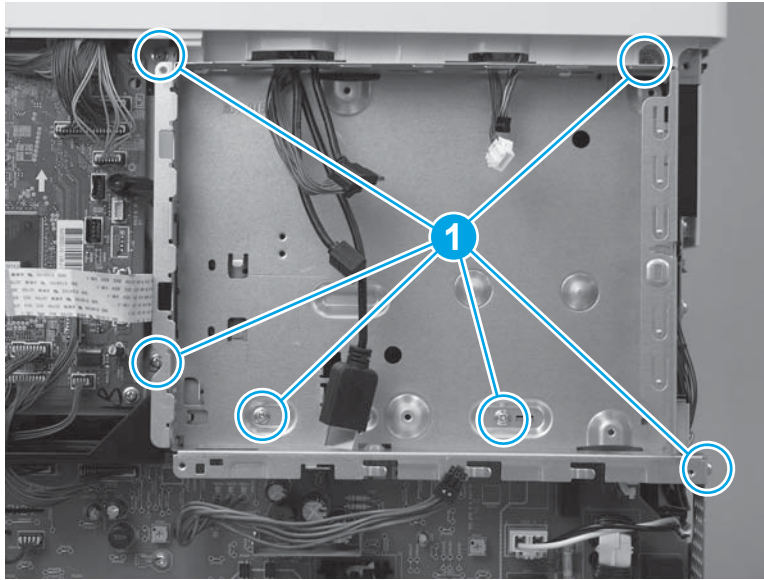

4. Pass two wire harnesses and one flat cable (callout 1) through the opening in the formatter case, and then install one wire harness in the retainer (callout 2).

 **IMPORTANT:** Make sure that the flat cable is securely fastened to the DC controller, and was not dislodged when the formatter case was removed.

Figure 1-4439 Install wire harnesses and flat cable



5. Position the LVPS cover on the printer, slide the cover to the left to install it, and then install two screws (callout 1).

Figure 1-4440 Install the LVPS cover

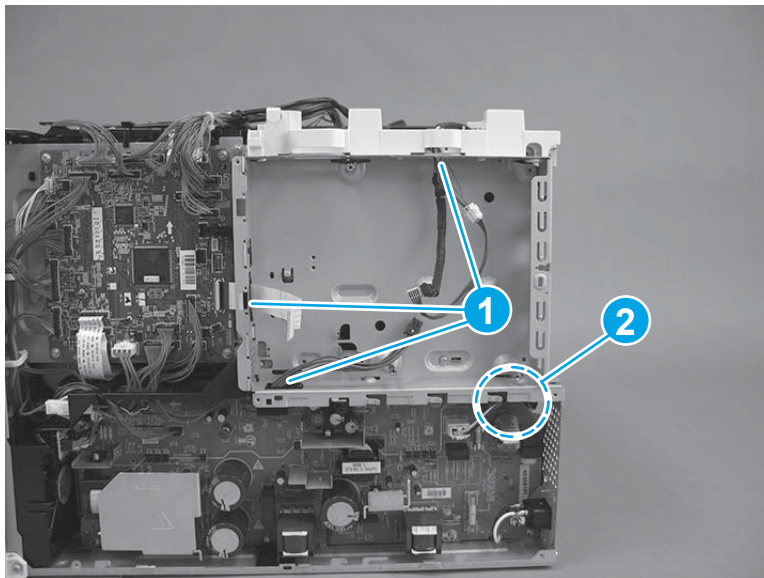
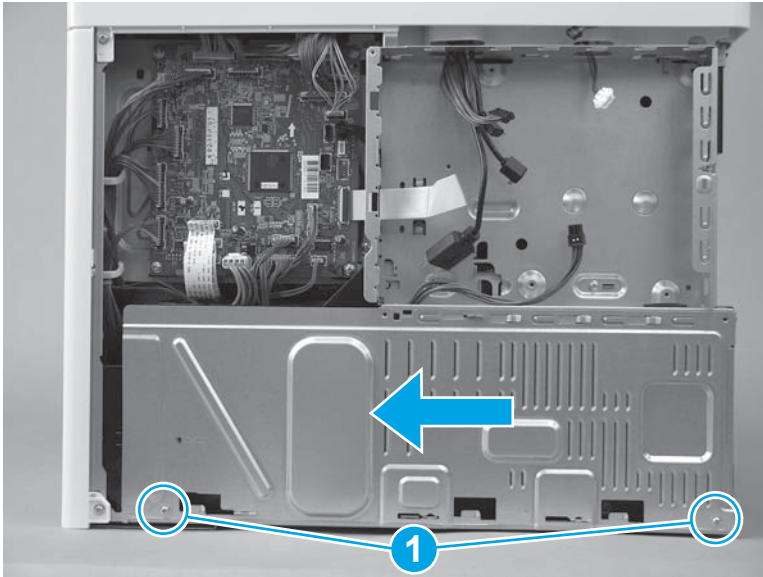

6. If no tape is affixed to the back of the flat cable, skip this step. If double-sided tape is affixed to the back of the flat cable, align the line (callout 1) on the cable with the edge (callout 2) of the opening in the sheet metal. Press to attach the flat cable to the formatter case.

Figure 1-4441 Attach the flat cable

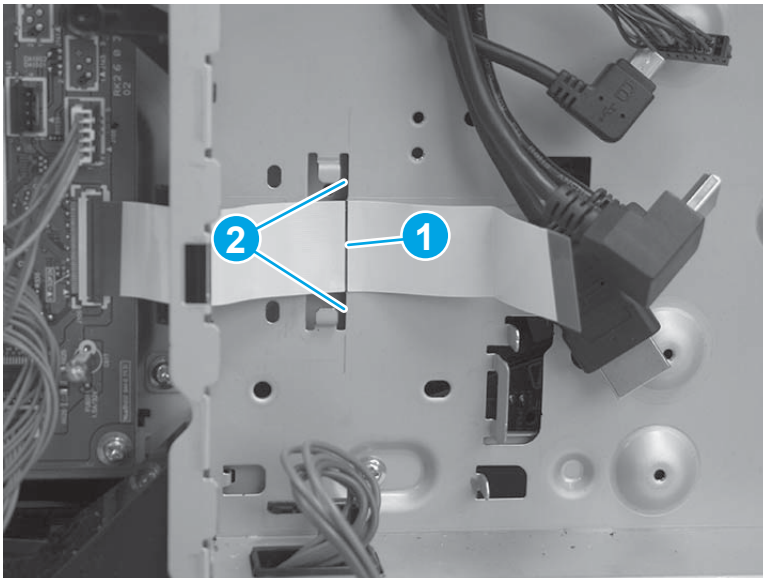

7. Position the bracket over the flat cable, and then slide the bracket to the left to install it. Make sure that the edges of the bracket fit under the sheet metal tabs (callout 1) on the formatter case and that the tabs (callout 2) snap into place.

Figure 1-4442 Position the bracket

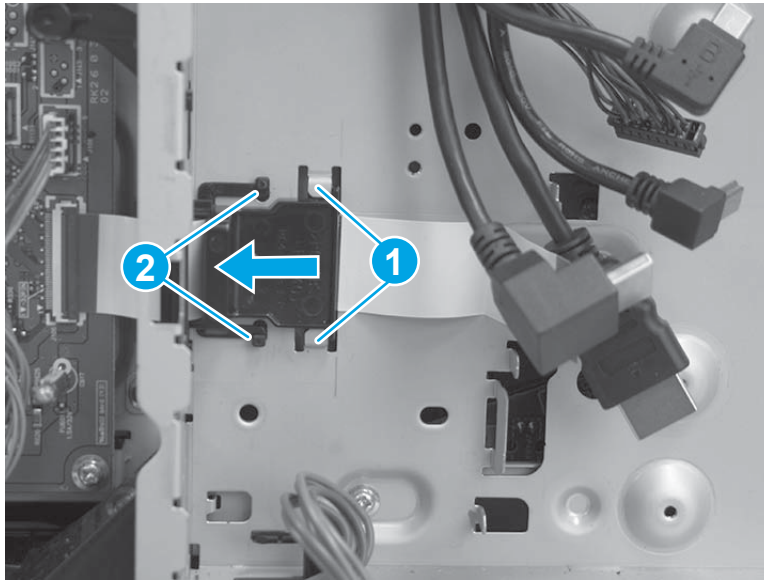

8. **M577 only:** Pass the wire harness (callout 1) through the openings in the formatter case (callout 2), and then connect one connector (callout 3).

Figure 1-4443 Connect one connector

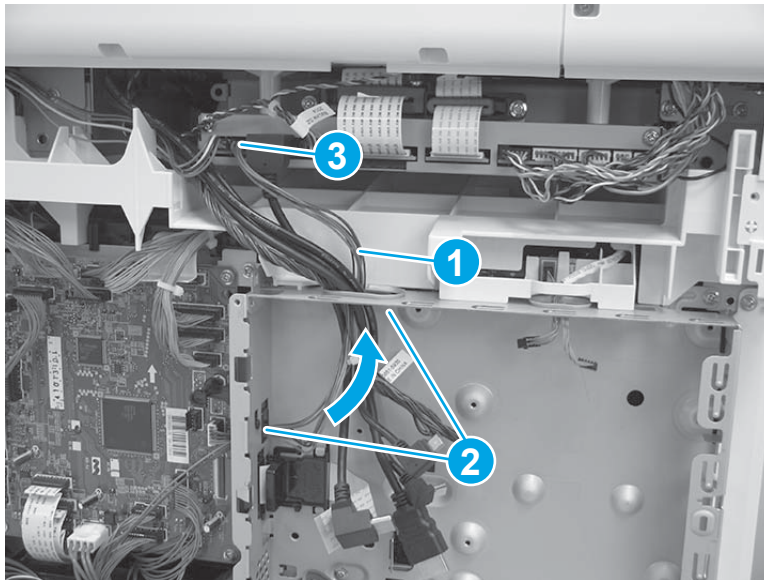

Step 42: Install the right rear cover

1. Position the cover on the printer.

Figure 1-4444 Install the cover

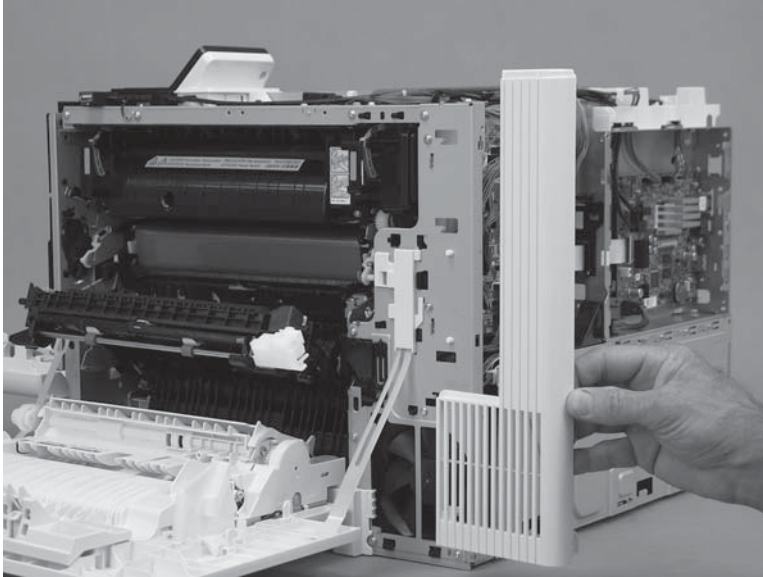

2. Slide the cover toward the right door (callout 1) to engage it with the printer, and then install one screw (callout 2).

Figure 1-4445 Install one screw

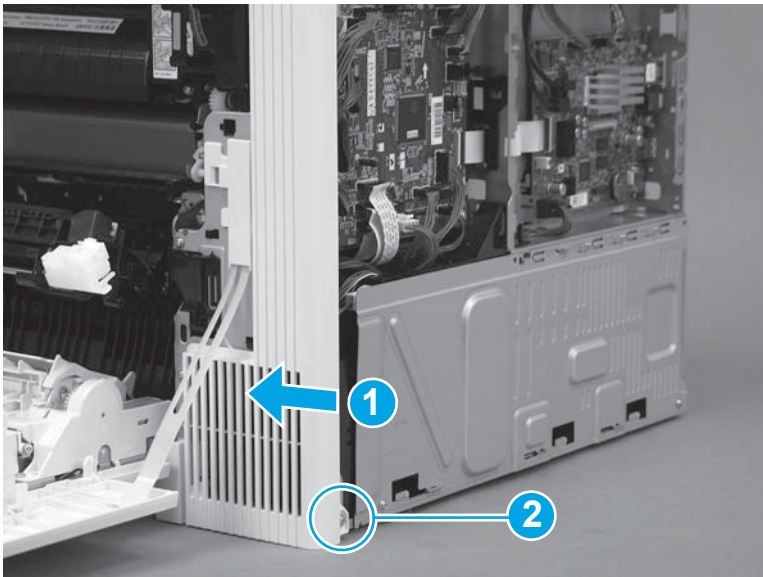

Step 43: Install the upper cover (M552 and M553)

 **NOTE:** This step is for the M552 and M553 models. For the M577 models, skip this step and go to [Step 44: Install the left cover on page 2468](#).

1. Position the cover on the printer.

 **NOTE:** For the M553x model, do not forget to pass the control-panel wire harness and USB cable through the opening in the cover.

Figure 1-4446 Install the cover



2. Push down on the rear corner of the cover to engage one tab (callout 1).

Figure 1-4447 Engage one tab

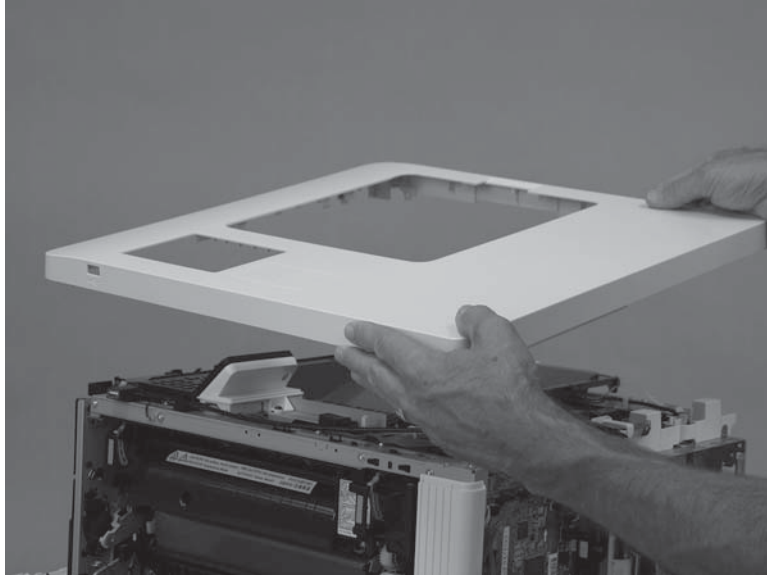
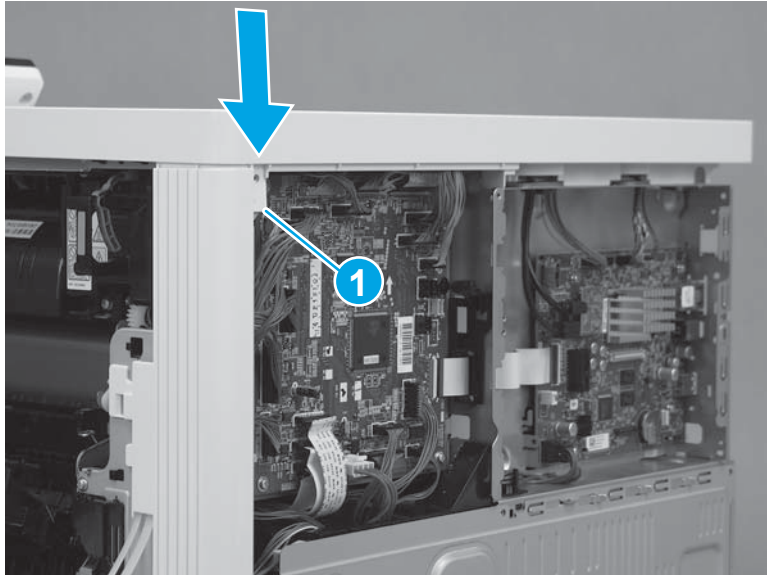

3. Push down on the front corner of the cover to engage one tab (callout 1), and then install one screw (callout 2).

 **NOTE:** This is a self-tapping plastic-thread screw. Make sure that this screw is used in this location when it is reinstalled.

Figure 1-4448 Engage one tab and install one screw



4. Install three screws (callout 1).

Figure 1-4449 Install three screws

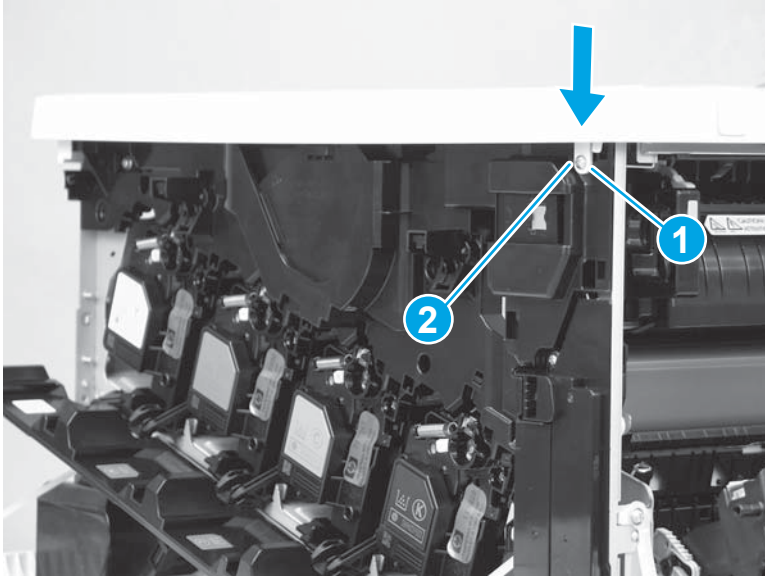
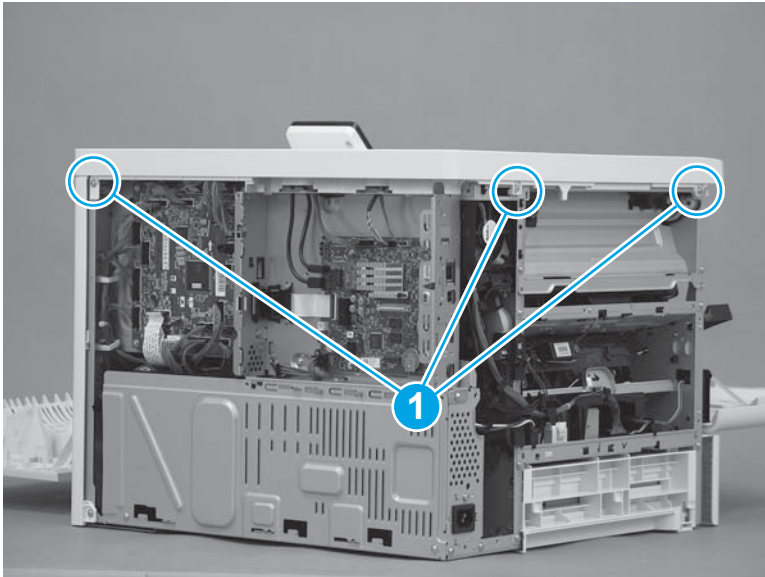

Step 44: Install the left cover

1. Position the cover on the printer.

 **NOTE:** Slightly offset the cover toward the rear of the printer.

Figure 1-4450 Install the cover

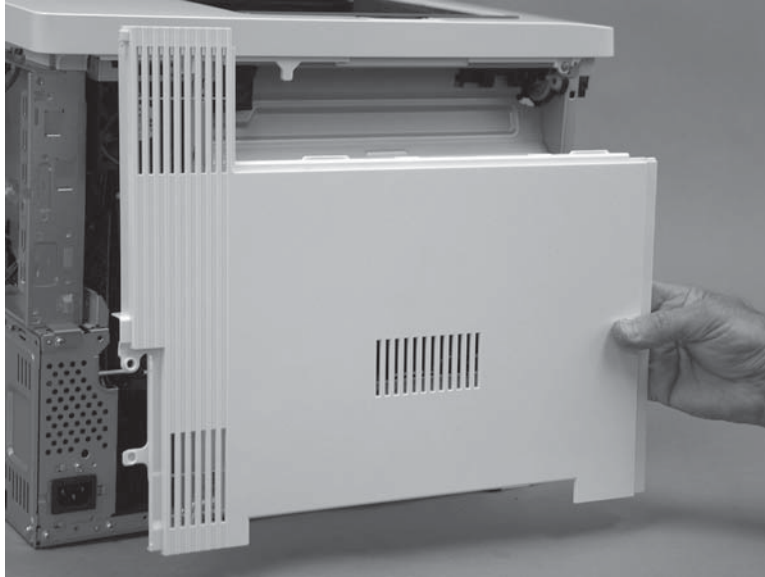

2. Slide the cover (callout 1) toward the front of the printer to engage it. Make sure that the tab (callout 2) snaps into place.

 **NOTE:** Locate the alignment pin (callout 3) on the cover from the front door side of the printer, and then make sure that it is fully engaged in the slot in the chassis.

 **TIP:** While sliding the cover into place, push in on the center of the cover (callout 1) to make sure that the hooks on the back of the cover engage with the slots in the chassis.

Figure 1-4451 Engage the cover



3. At the left side of the printer, install one screw (callout 1).

Figure 1-4452 Install one screw

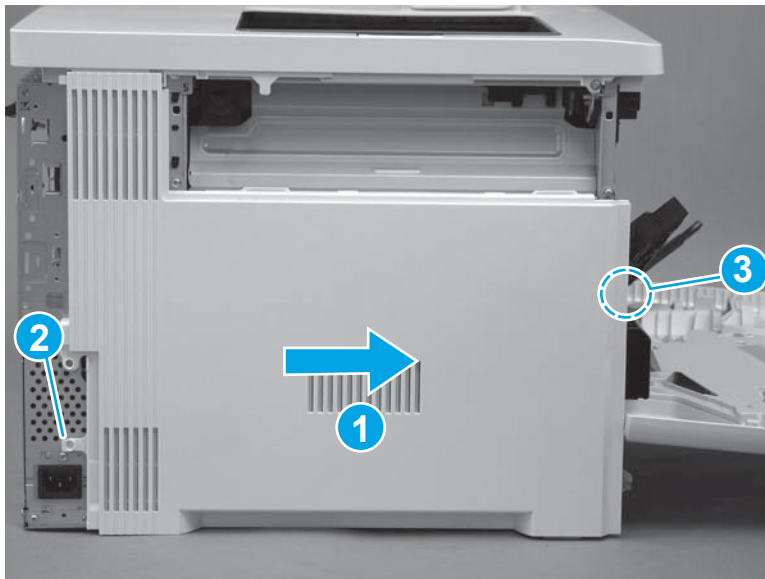

Step 45: Install the right upper cover (M577)



NOTE: This step is for the M577 models. For the M552 and M553 models, skip this step and go to [Step 52: Install the rear cover \(M552 and M553\) on page 2484](#).



NOTE: The figures below show the image scanner installed. The procedures for removing and installing the right upper cover are the same whether the image scanner is installed or removed."

1. **M577c/f/z only:** Install the cables (callout 1) through the slot (callout 2) in the printer.

Figure 1-4453 Install the cables

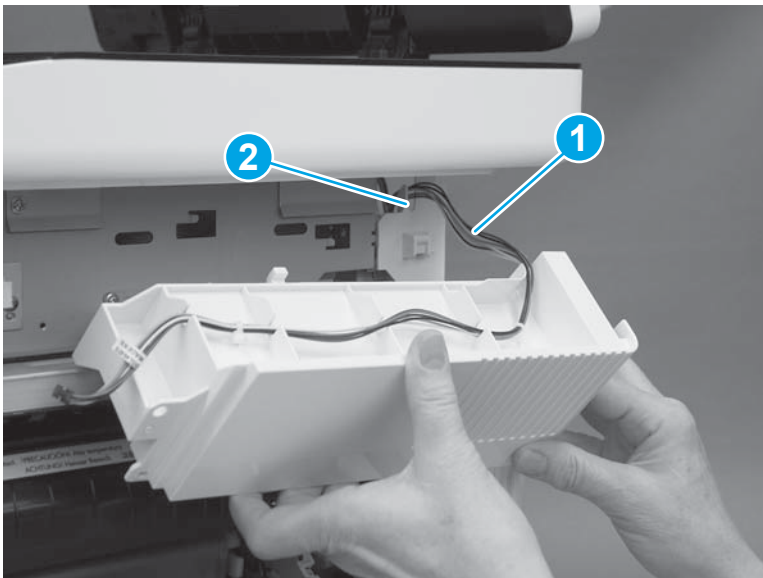

2. Position the hooks (callout 1) on the cover in the slots (callout 2) in the printer.

Figure 1-4454 Position the hooks

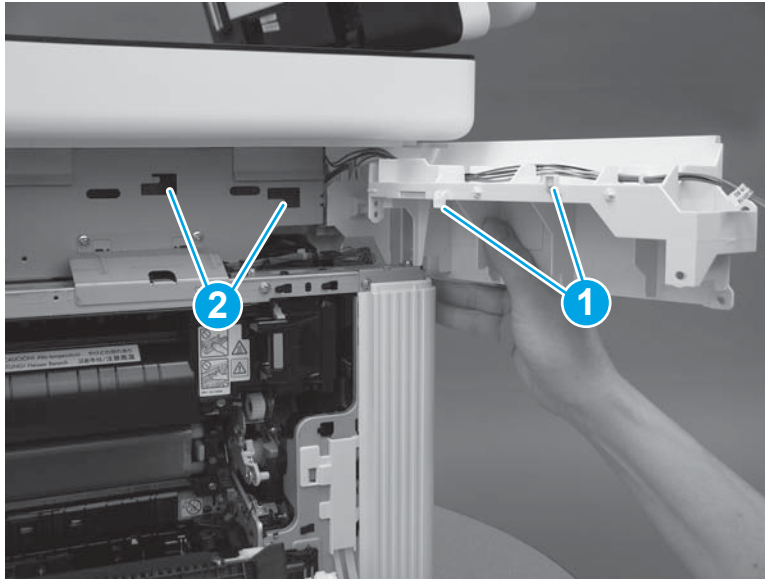

3. Slide the cover toward the front of the printer to install it.

Figure 1-4455 Install the cover

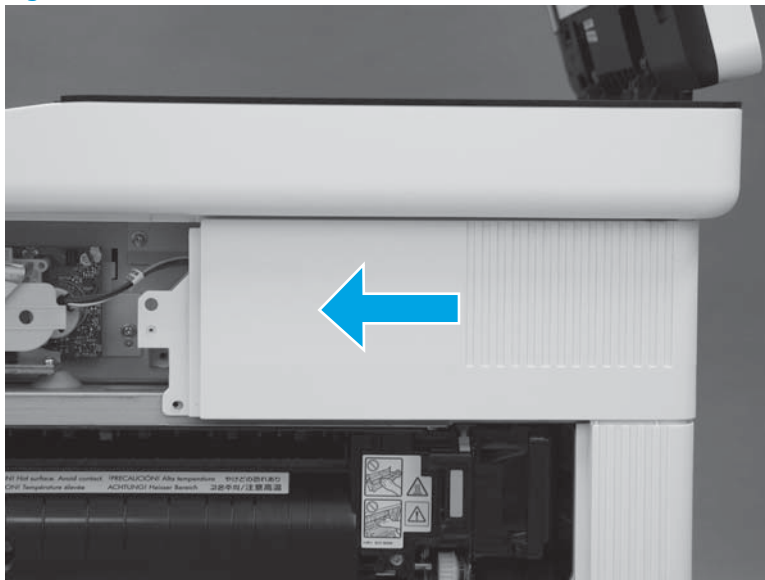

4. At the back of the printer, install one screw (callout 1).

M577c/f/z only: Connect one connector (callout 2), if the integrated scanner assembly is installed.

TIP: This screw is smaller than the screws installed in the next step. Make sure that this screw is installed in the correct position.

Figure 1-4456 Install one screw and connector



5. At the right side of the printer, install two screws (callout 1).

M577c/f/z only: Connect one connector (callout 2), if the stapler is installed.

Figure 1-4457 Install one screw and connector

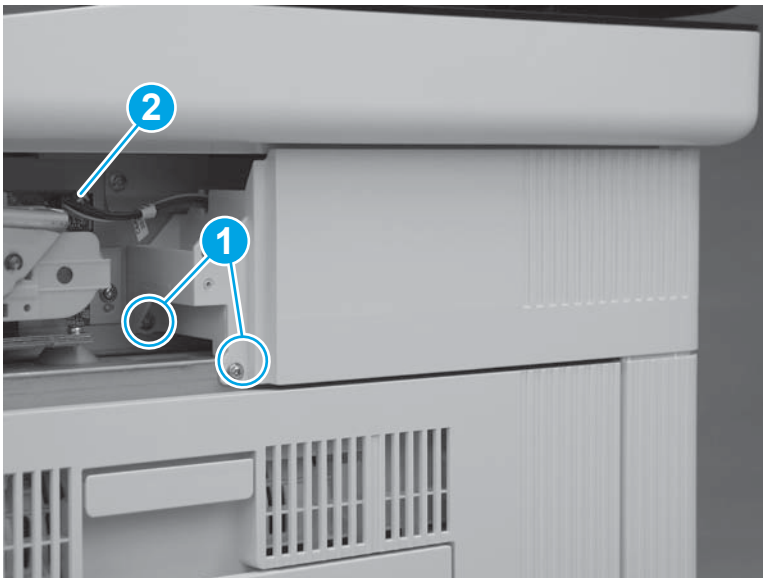

Step 46: Install the integrated scanner assembly (ISA) (M577)

NOTE: This step is for the M577 models. For the M552 and M553 models, skip this step and go to [Step 52: Install the rear cover \(M552 and M553\) on page 2484](#).

 **NOTE:** The ISA includes the document feeder, image scanner, scanner control board (SCB), control panel, keyboard (M577c/z) and NFC PCA (M577z).

1. Before proceeding, locate the mounting pins (callout 1) on the bottom of the ISA and the slots (callout 2) on the printer base.

Figure 1-4458 Locate the ISA mounting pins and slots

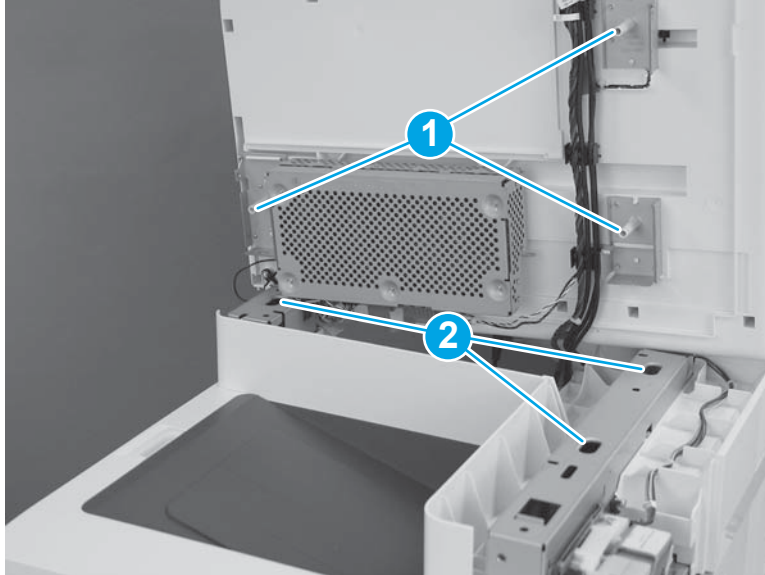

2. Position the ISA on the printer base with the pins in the slots.

 **NOTE:** To locate the pins and slots, see [Figure 1-395 Locate the ISA mounting pins and slots on page 250](#).

When installing the ISA, carefully pass the cables through the opening in the top of the formatter case.

Figure 1-4459 Install the ISA

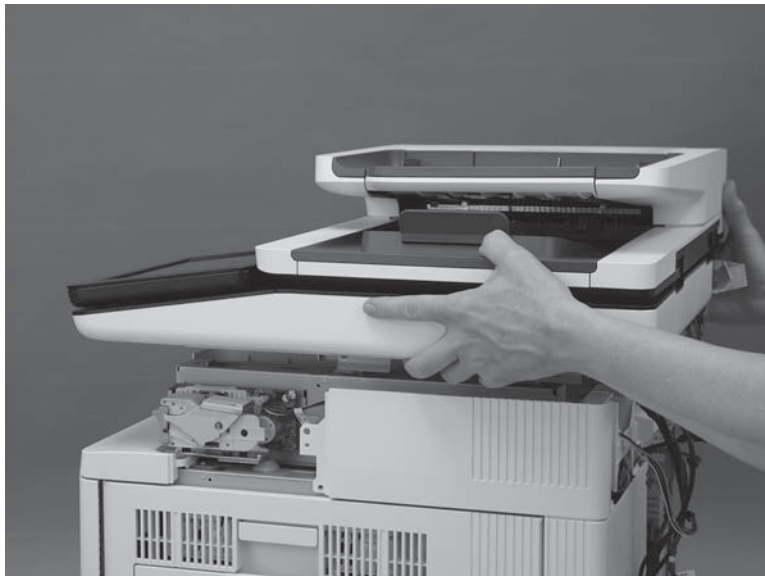

3. Slightly slide the ISA towards the front of the printer to engage it.

Figure 1-4460 Slide the ISA towards the front of the printer

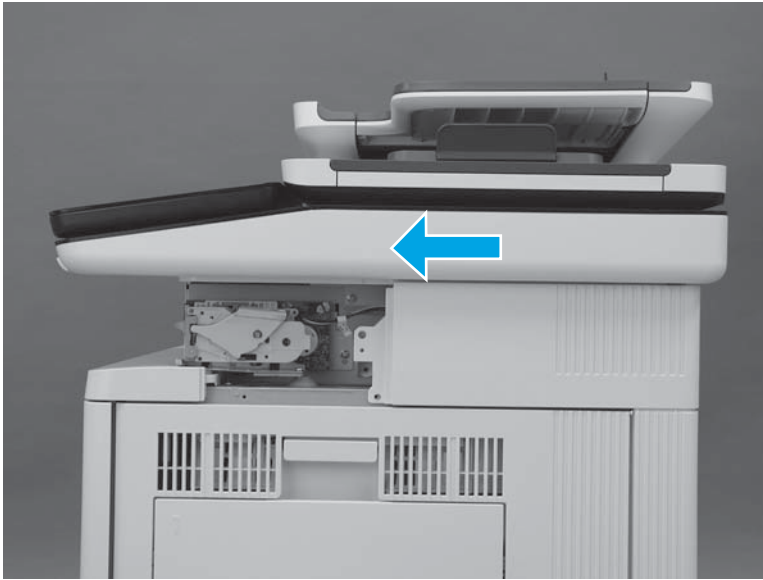

4. At the left side of the printer, install one screw (callout 1).

Figure 1-4461 Install one screw

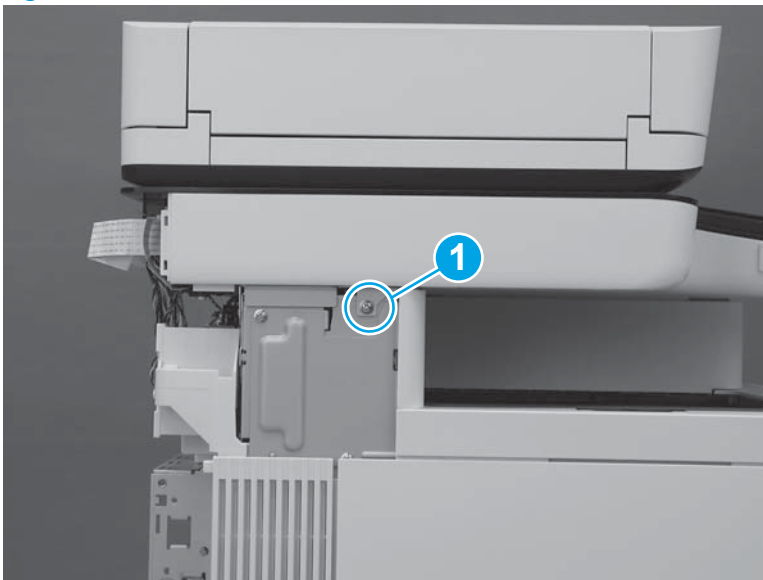

5. At the back of the printer, install two screws (callout 1).

Figure 1-4462 Install two screws

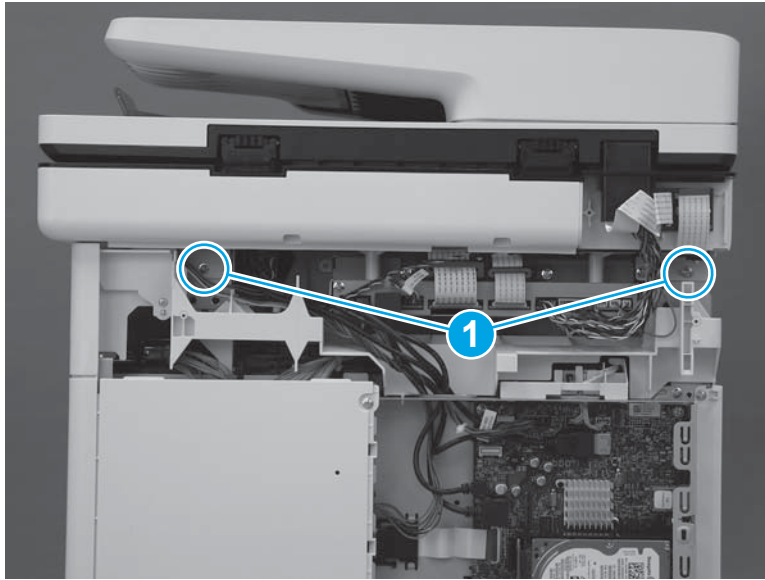

6. At the right side of the printer, install one screw (callout 1).

Figure 1-4463 Install one screw

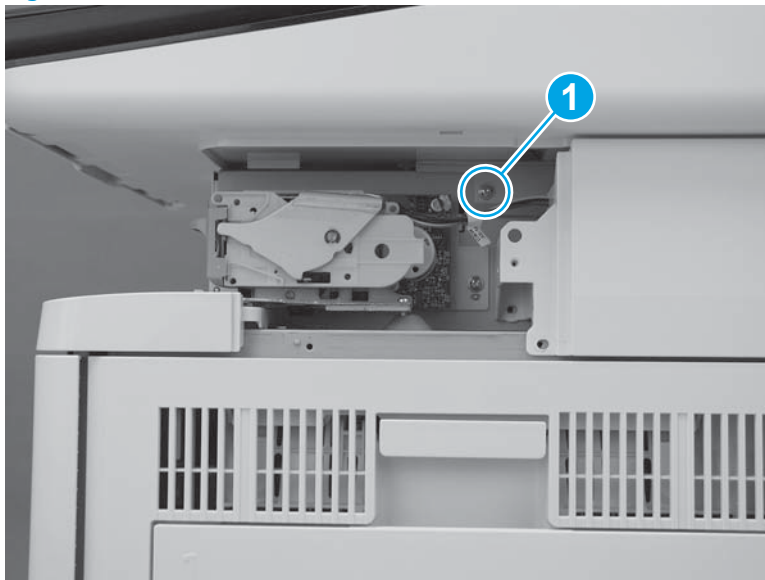

7. Connect two connectors on the scanner control board (callout 1).

M577c/f/z only: Connect one connector for the stapler on the scanner control board (callout 2).

Figure 1-4464 Connect connectors

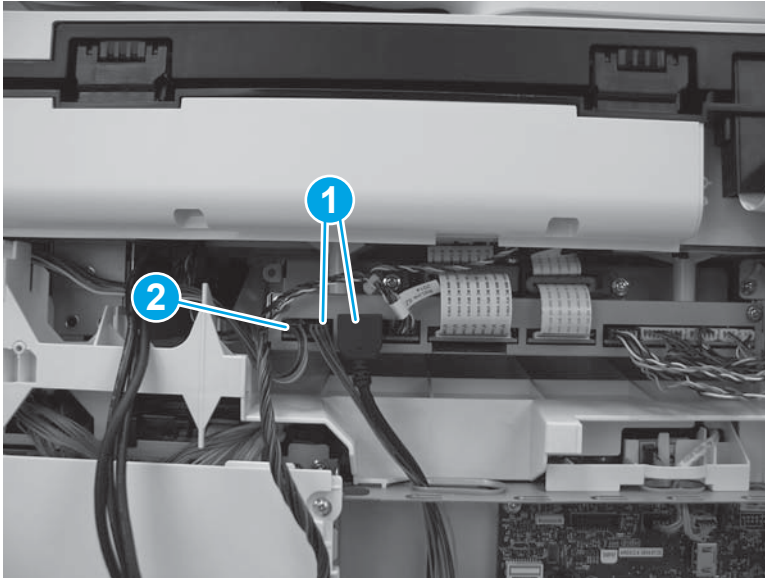

Step 47: Install the stapler cover assembly (M577c/f/z)

 **NOTE:** This step is for the M577c/f/z models only. For the M577dn model, skip this step and go to [Step 48: Install the right front upper cover \(M577dn\) on page 2477](#).

For the M552 and M553 models, skip this step and go to [Step 52: Install the rear cover \(M552 and M553\) on page 2484](#).

1. Install the tabs (callout 1) on the cover in the slots (callout 2) in the printer.

Figure 1-4465 Install two tabs



2. Press the cover toward the left side of the printer until it snaps into place.

Figure 1-4466 Install the cover assembly



3. Install one screw (callout 1).



 **IMPORTANT:** This is a self-tapping screw for plastic. Rotate it counterclockwise to align it with the existing thread pattern, and then carefully turn it clockwise to tighten. Do not overtighten. This will prevent stripping the threads inside the screw hole.

Figure 1-4467 Install one screw

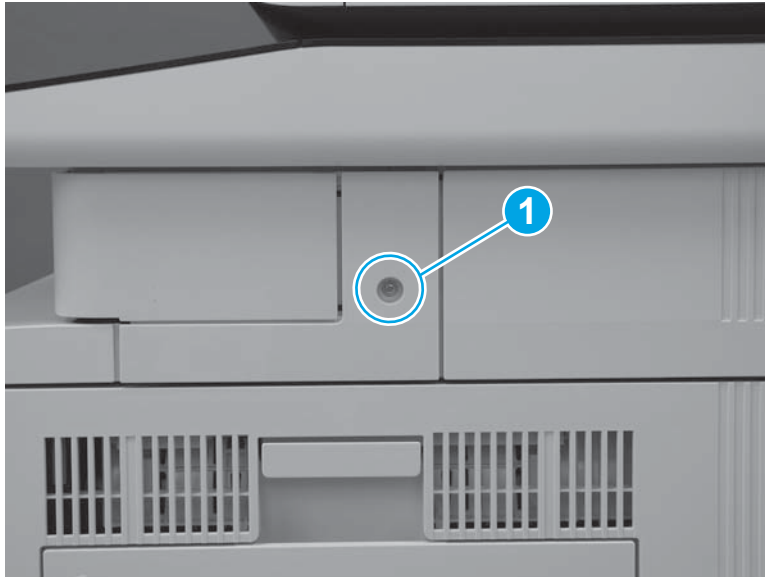

Step 48: Install the right front upper cover (M577dn)

 **NOTE:** This step is for the M577dn model only. For the M577c/f/z models, skip this step and go to [Step 49: Install the left upper cover \(M577\) on page 2479](#).

For the M552 and M553 models, skip this step and go to [Step 52: Install the rear cover \(M552 and M553\) on page 2484](#).

1. Slide the cover toward the left side of the printer to install it. Make sure that the slots (callout 1) in the cover fit over the tabs (callout 2) on the inside of the paper feeder cover.

Figure 1-4468 Install the cover

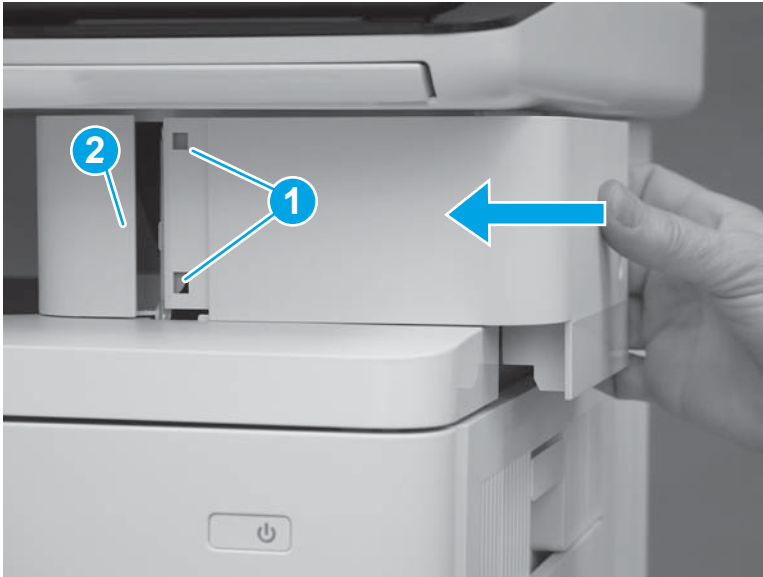

2. Press the right front upper cover (callout 1) and the paper feeder cover (callout 2) together until the tabs on the inside of the covers snap into place.

Figure 1-4469 Press the cover



3. Install one screw (callout 1).

Figure 1-4470 Install one screw

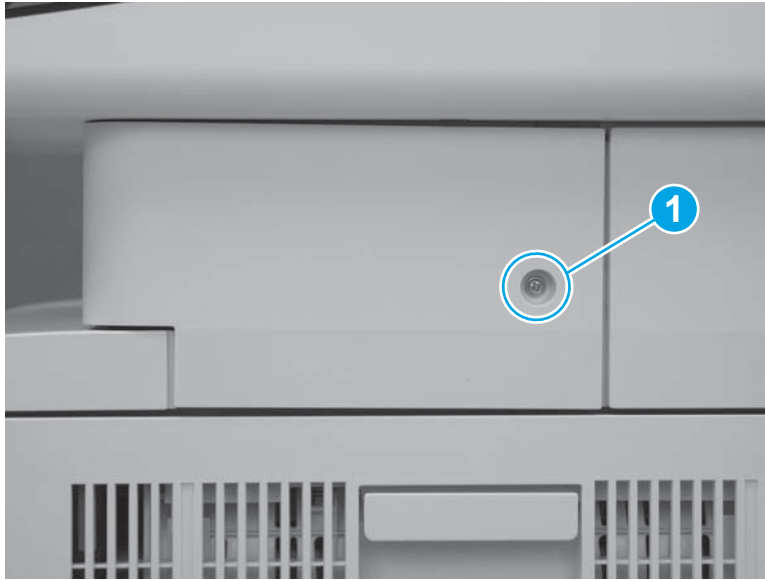

Step 49: Install the left upper cover (M577)

 **NOTE:** This step is for the M577 models. For the M552 and M553 models, skip this step and go to [Step 52: Install the rear cover \(M552 and M553\) on page 2484](#).

1. Position the tab (callout 1) on the lower edge of the cover behind the left cover (callout 2).

Figure 1-4471 Position the tab

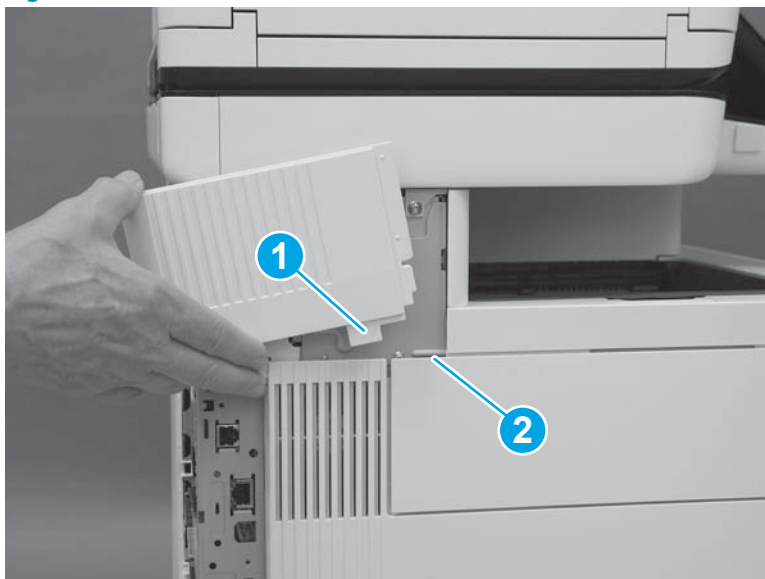

2. Slide the cover toward the front of the printer to install it. Make sure that the edge (callout 1) of the cover fits behind the edge (callout 2) of the top rear cover.

Figure 1-4472 Slide the cover

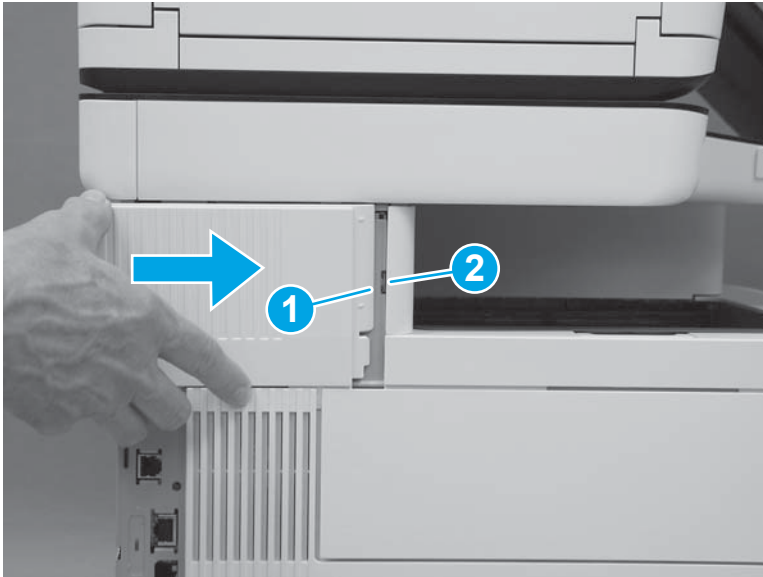

3. Make sure that the tab (callout 1) is fully installed.

Figure 1-4473 Check the tab

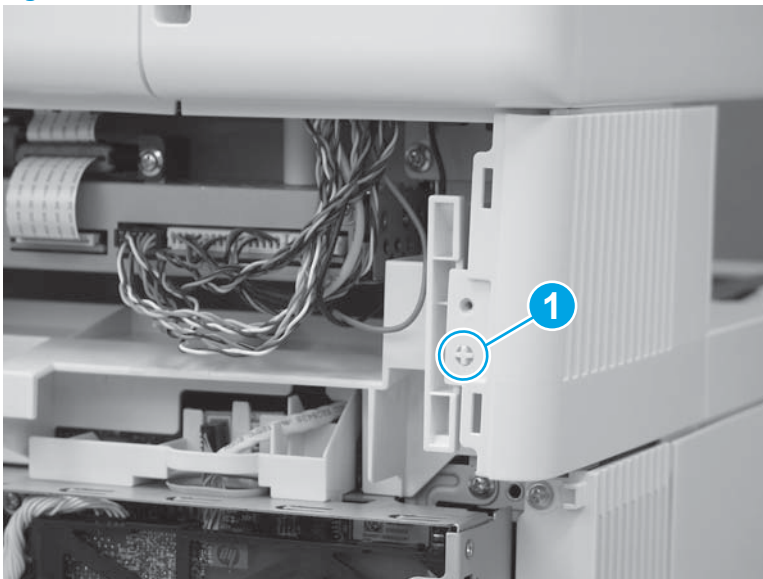

Step 50: Install the rear cover (M577)



NOTE: This step is for the M577 models. For the M552 and M553 models, skip this step and go to [Step 52: Install the rear cover \(M552 and M553\) on page 2484](#).

1. Position the hooks (callout 1) on the cover in the slots (callout 2) in the printer.

Figure 1-4474 Position the hooks

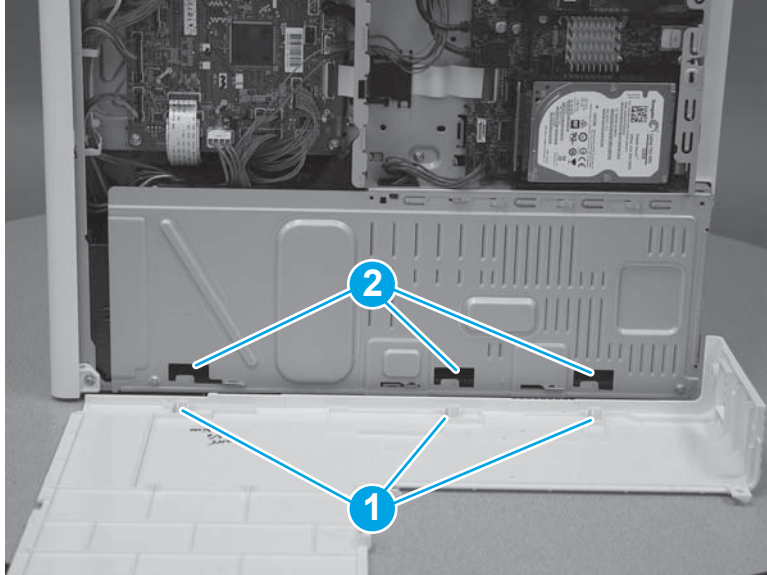

2. Position the back edge (callout 1) of the rear cover behind the edge (callout 2) of the right rear cover. Slide the cover to the left to install it.

Figure 1-4475 Install the cover

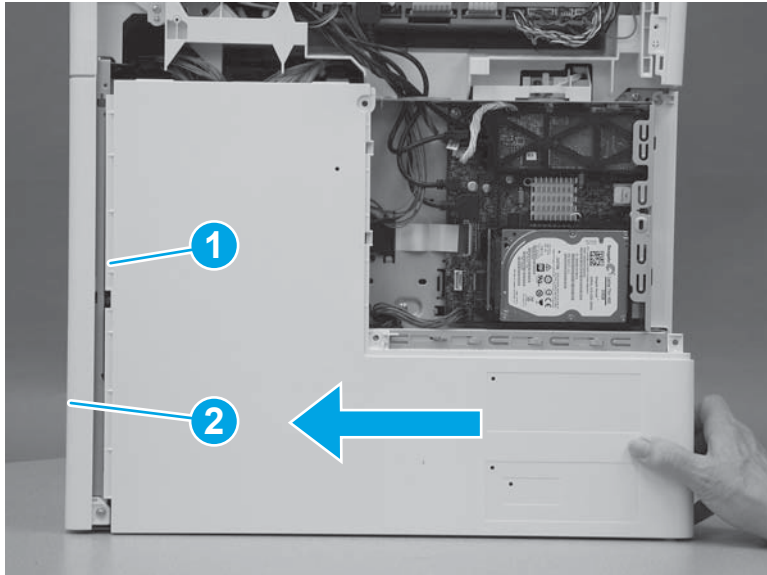

3. Install four screws (callout 1).

Figure 1-4476 Install four screws cover

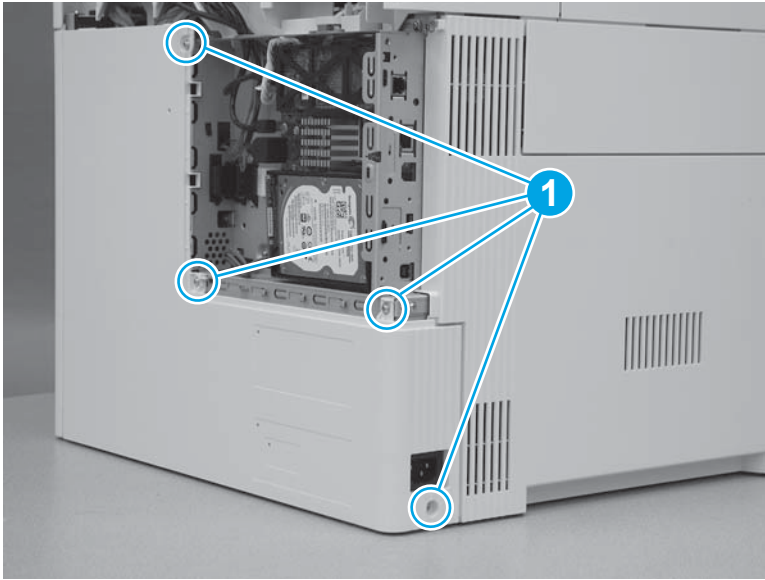

Step 51: Install the rear upper cover (M577)



NOTE: This step is for the M577 models. For the M552 and M553 models, skip this step and go to [Step 52: Install the rear cover \(M552 and M553\) on page 2484](#).

1. Align the ridge (callout 1) on the lower edge of the rear upper cover in front of the tabs (callout 2) on the top edge of the rear cover.

Figure 1-4477 Align the cover

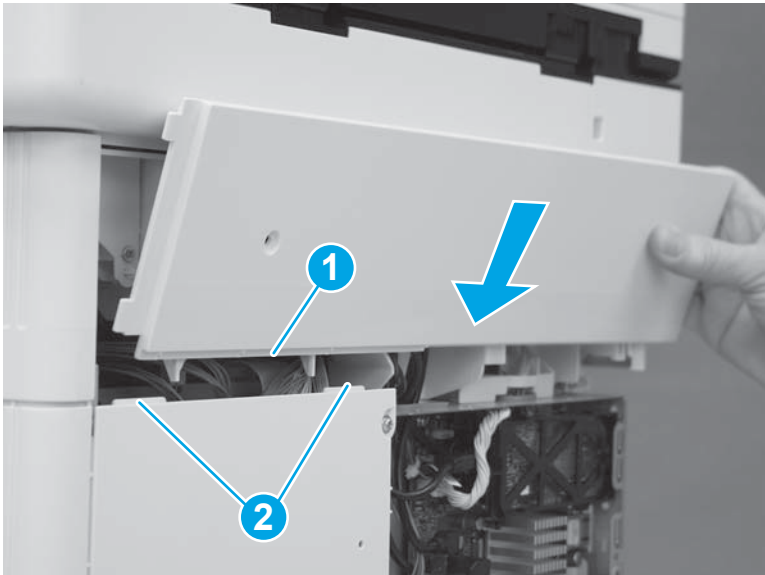

2. Rotate the top of the cover toward the printer.

Figure 1-4478 Rotate the top of the cover

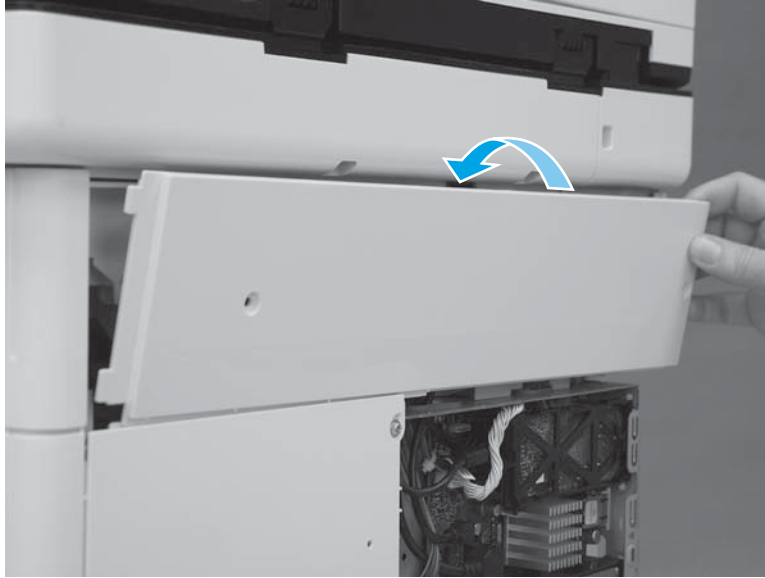

3. Slide the cover to the left (callout 1). Make sure that the tabs (callout 2) on the upper rear cover slide behind the edge (callout 3) of the right upper cover. Make sure that the cover is fully seated.

Figure 1-4479 Slide the cover

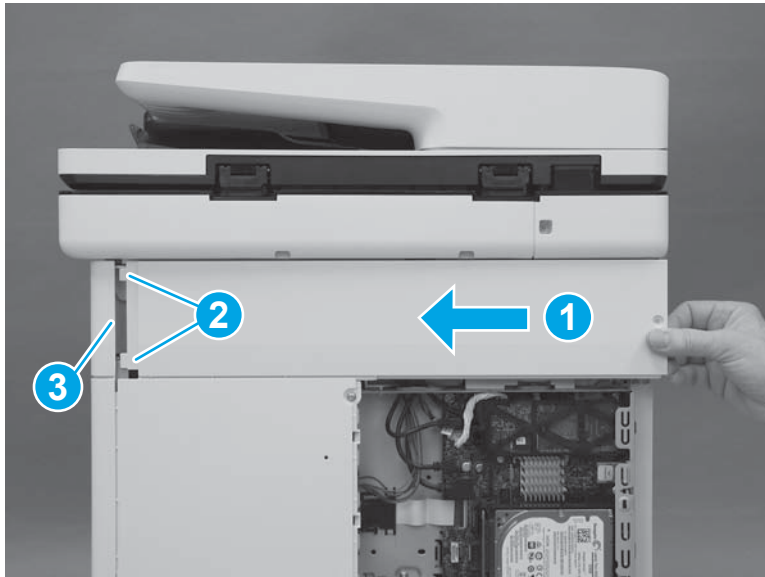

4. Install two screws (callout 1).



 **IMPORTANT:** These two screws are self-tapping screws for plastic. Rotate them counterclockwise to align them with the existing thread pattern, and then carefully turn them clockwise to tighten. Do not overtighten. This will prevent stripping the threads inside the screw holes.

Figure 1-4480 Install two screws

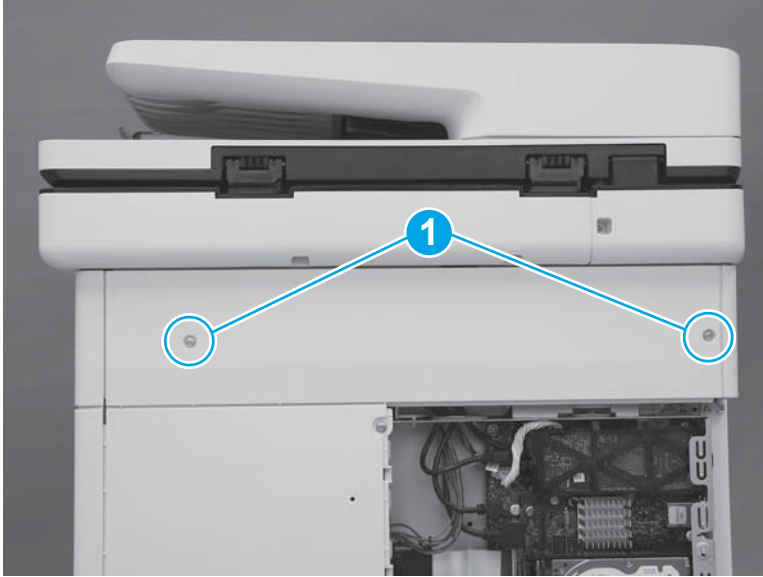

Step 52: Install the rear cover (M552 and M553)

 **NOTE:** This step is for the M552 and M553 models. For the M577 models, skip this step and go to [Step 53: Install the formatter \(M577\) on page 2485](#).

1. Position the top of the cover under the upper cover (callout 1), rotate the bottom of the cover onto the chassis (callout 2), and then slide the cover to the left (callout 3) to install it.

Figure 1-4481 Install the cover

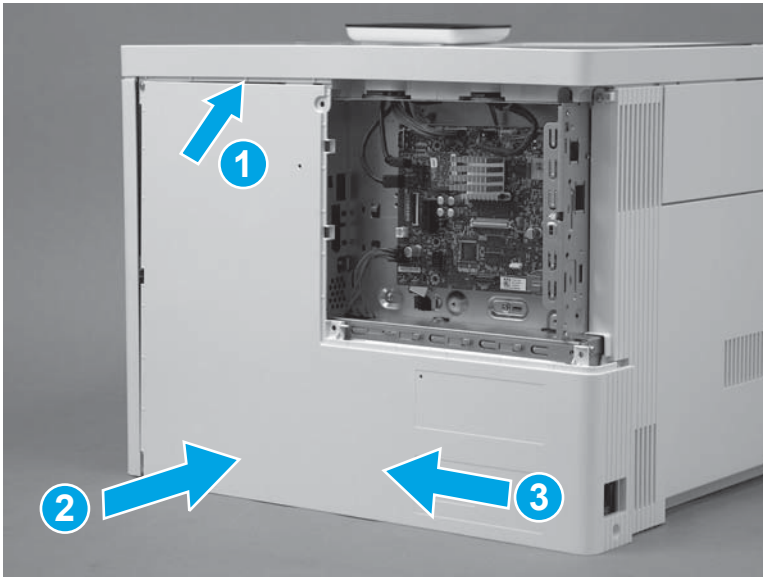

2. Install four screws (callout 1).

Figure 1-4482 Install four screws cover

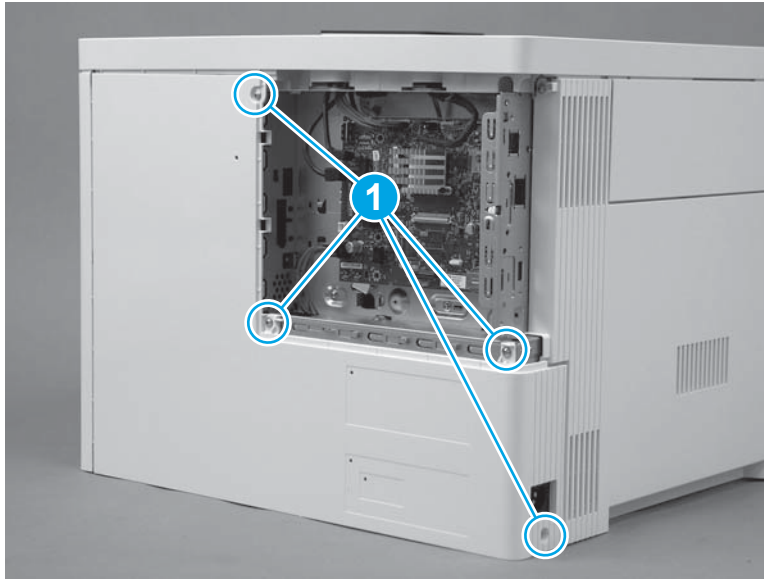

Step 53: Install the formatter (M577)

 **NOTE:** This step is for the M577 models. For the M552 and M553 models, skip this step and to go [Step 56: Install the formatter \(M552 and M553\)](#) on page 2490.

 **CAUTION:**  ESD-sensitive part.

1. Position the formatter in the printer. Make sure that the network port (callout 1) fits through the opening (callout 2) in the formatter case.

Figure 1-4483 Install the formatter

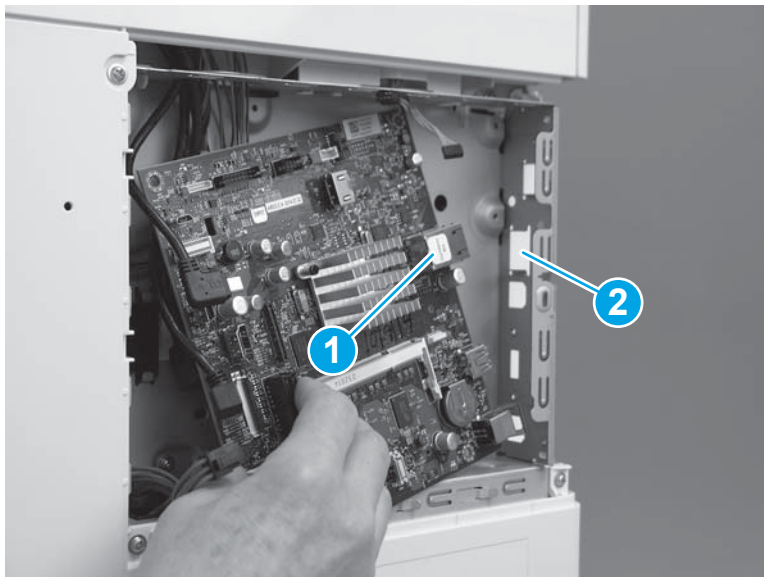

2. Install four screws (callout 1).

Figure 1-4484 Install four screws

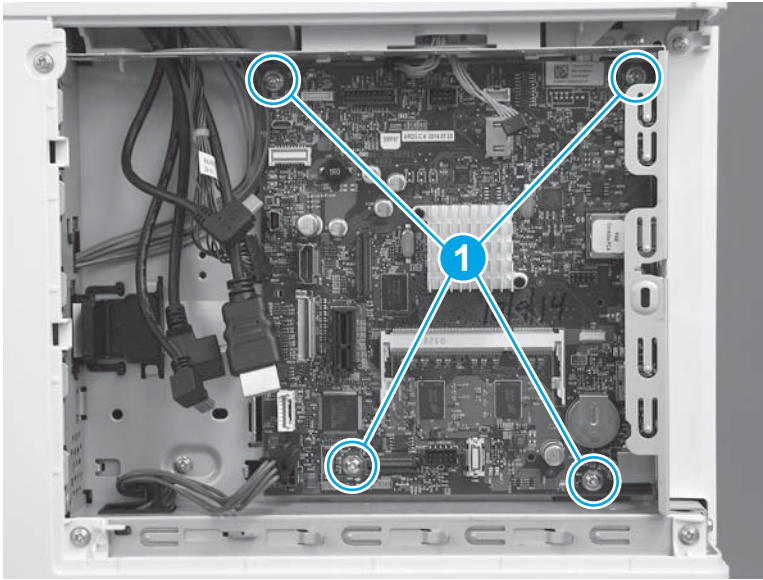

3. Connect all of the connectors on the formatter.

The following connectors are empty:

- All models: J1 (this connector is empty unless the optional DIMM is installed)
- All models: J3
- M577dn: J15 (this is the fax connector for the M577f/z/c models)
- All models: J21 (this connector is empty unless the optional internal USB ports component is installed)
- All models: J23
- All models: J24
- All models: J51
- All models: J57
- All models: J97
- All models: J98 (this connector is empty unless the optional trusted platform module (TPM) is installed)

 **IMPORTANT:** The flat-cable connector (callout 1) is a Zero Insertion Force (ZIF) connector that uses a hinged retainer to secure the flat cable. The hinged retainer must be opened to install the flat cable, and then closed after the cable is installed.

Figure 1-4485 Connect all connectors



Step 54: Install the fax PCA (M577c/f/z)

 **NOTE:** This step is for the M577c/f/z models. For the M577n model, skip this step and go to [Step 55: Install the HDD \(M577\) on page 2488](#).

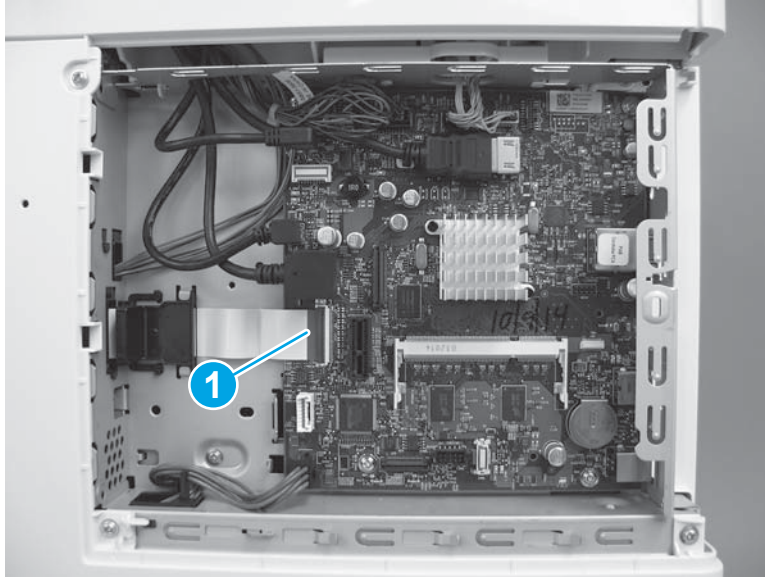
For the M552 and M553 models, skip this step and go to [Step 56: Install the formatter \(M552 and M553\) on page 2490](#).

 **CAUTION:**  ESD-sensitive part.

1. Position the tab and telephone port (callout 1) on the fax PCA in the slots (callout 2) in the formatter case.

Figure 1-4486 Position the fax PCA

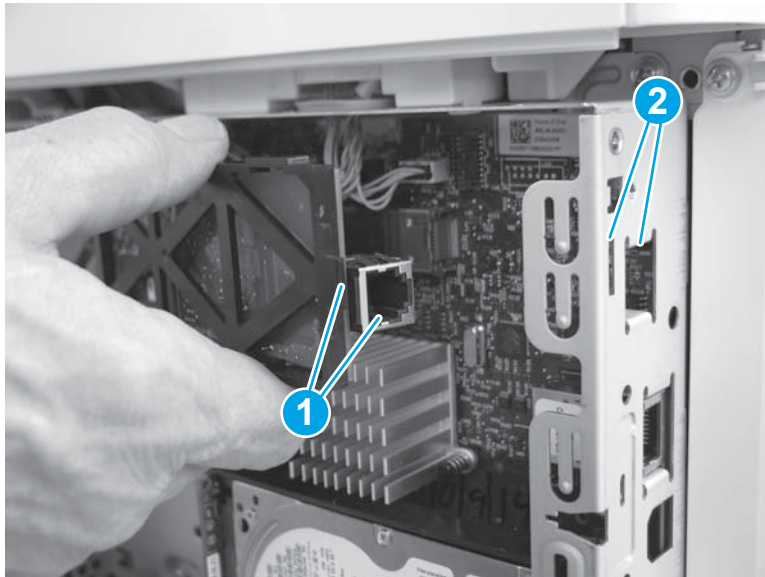

2. Slide the fax PCA to the right (callout 1) until the tab and telephone port described in the previous step and seated in the formatter case. Position the retainer (callout 2) in the slot (callout 3) in the formatter. Rotate the end of the fax PCA toward the formatter (callout 4) until the retainer snaps into place.

Figure 1-4487 Install the fax PCA

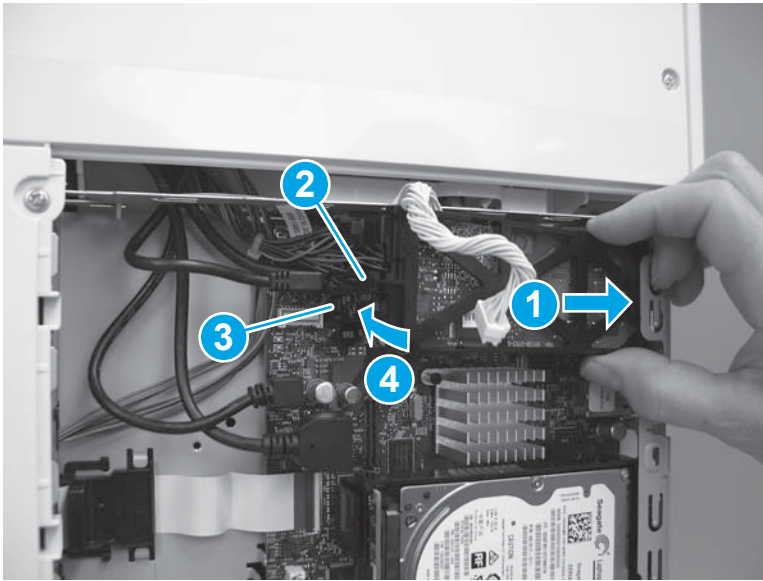

3. Position the cable (callout 1) in the guide (callout 2), and then connect one connector (callout 3).

Figure 1-4488 Connect the connector

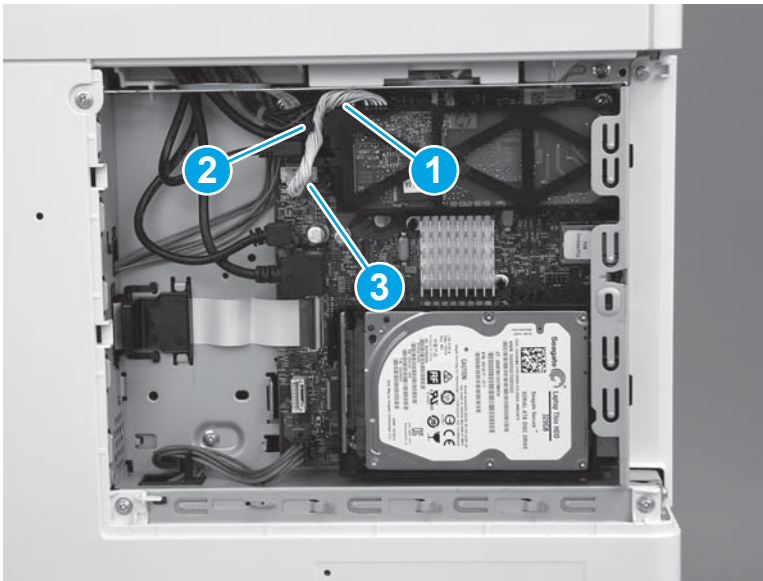

Step 55: Install the HDD (M577)



NOTE: This step is for the M577 models. For the M552 and M553 models, skip this step and go to [Step 56: Install the formatter \(M552 and M553\) on page 2490.](#)

 **CAUTION:**  ESD-sensitive part.

1. Align the end of the bracket (callout 1) with the slot in the chassis (callout 2), and then slide the HDD into the printer (callout 3) to engage the bracket with the chassis.

Figure 1-4489 Install the holder

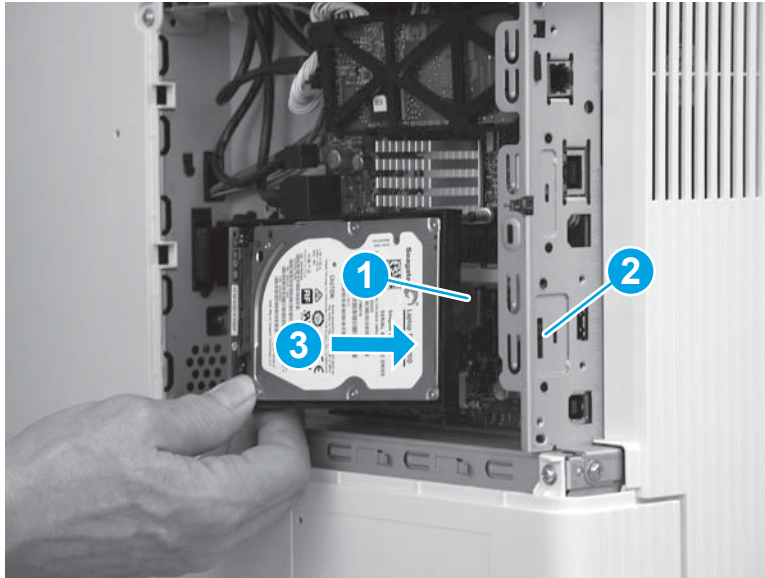

2. Hold the HDD connector latch (callout 1) in the released position, and then rotate the HDD down and into the connector on the formatter to install it.

 **NOTE:** Make sure that the tab (callout 2) snaps into place, and that the HDD is securely installed.

Figure 1-4490 Release the HDD

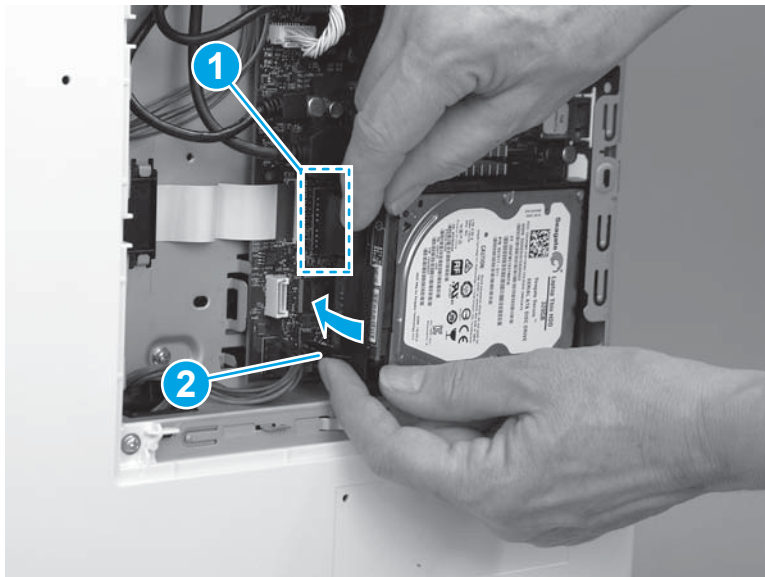

Step 56: Install the formatter (M552 and M553)

 **NOTE:** This step is for the M552 and M553 models. For the M577 models, skip this step and go to [Step 59: Install the formatter cover on page 2495](#).

If the optional hard-disk drive (HDD) was removed, do not forget to reinstall it after the formatter is reinstalled.

Engage the HDD holder with the chassis, rotate the HDD connector down and into the connector on the formatter. Make sure that the tabs snap into place.

 **CAUTION:**  ESD-sensitive part.

1. Position the formatter in the printer, and then install four screws (callout 1).

Figure 1-4491 Install the formatter

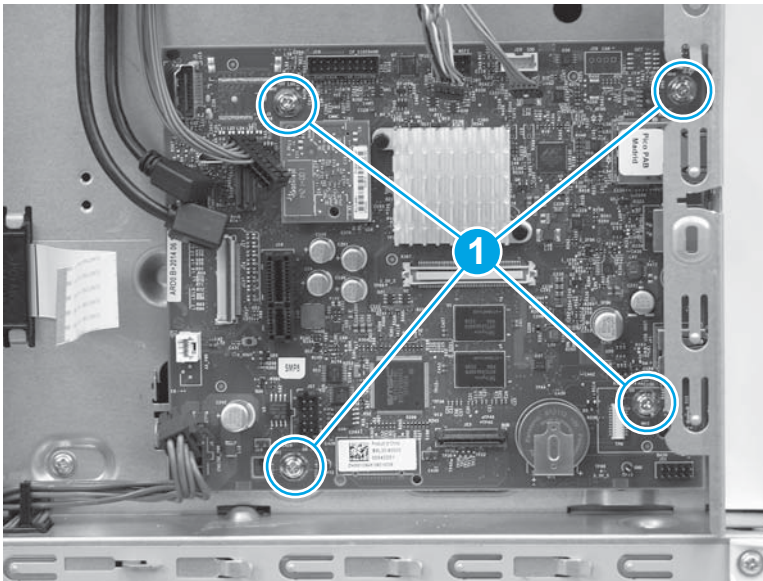

2. Connect all of the connectors on the formatter.

The following connectors are empty:

- All models: J1 (this connector is empty unless the optional DIMM is installed)
- M553n/dn and M552dn: J2 (callout 1; this is the touchscreen connector for the M553x model)
- All models: J9 (this connector is empty unless the optional internal USB ports component is installed)
- All models: J18 (this connector is empty unless the optional hard-disk-drive (HDD) is installed)
- All models: J23
- All models: J24
- M553n/dn and M552dn: J25 (this is the wireless connector for the M553x model)

- All models: J57
- All models: J98 (this connector is empty unless the optional trusted platform module (TPM) is installed)



 **IMPORTANT:** The flat-cable connector (callout 2) is a Zero Insertion Force (ZIF) connector that uses a hinged retainer to secure the flat cable. The hinged retainer must be opened to install the flat cable.

Figure 1-4492 Connect all connectors

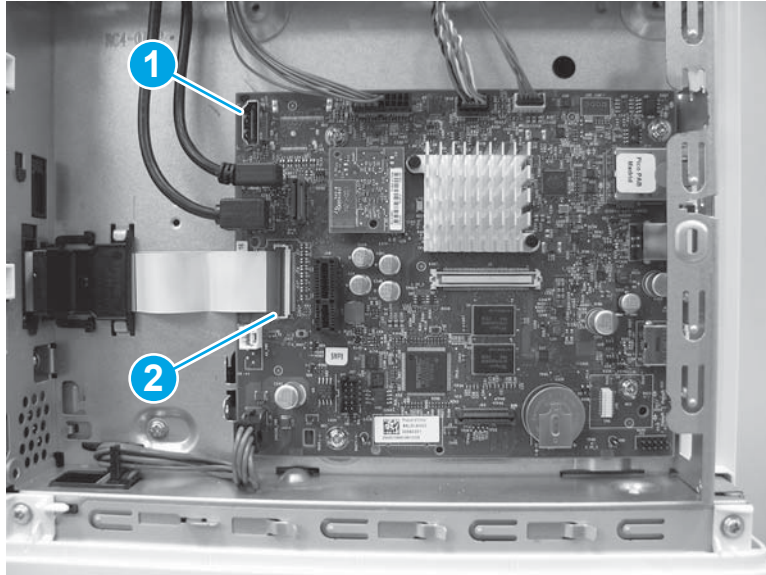

Step 57: Install the control-panel assembly (M553x only)

 **NOTE:** This step is for the M553x model. For the M553n/dn and M552dn models, skip this step and go to [Step 58: Install the USB cover \(M552 and M553\) on page 2494](#).

For the M577 models, skip this step and go to [Step 59: Install the formatter cover on page 2495](#).

1. Place the control panel on the printer as shown.

Figure 1-4493 Place the control panel on the product

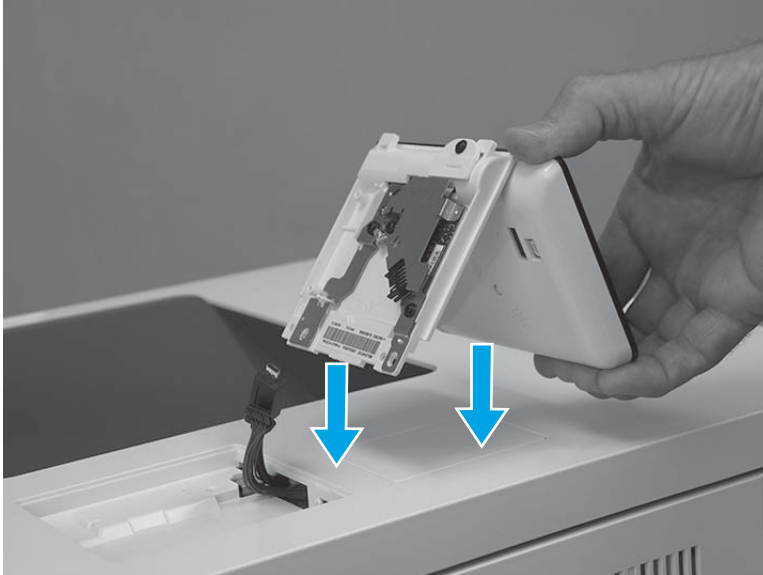

2. Connect one USB cable (callout 1), and one connector (callout 2).

 **IMPORTANT:** Take note of the location of the two mounting tabs (callout 3) on the control-panel assembly.

Figure 1-4494 Connect two connectors



3. Turn the control panel over, and then position the front edge tabs in the slots in the top cover.

Figure 1-4495 Turn the control panel over

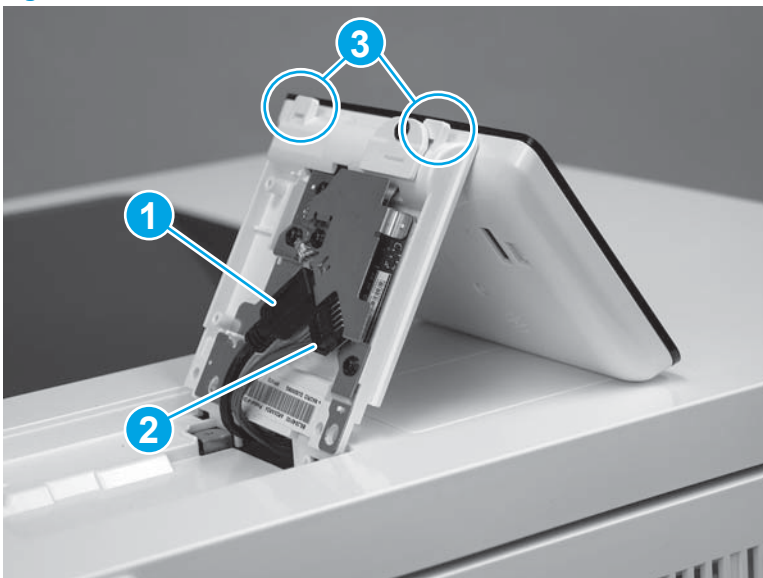
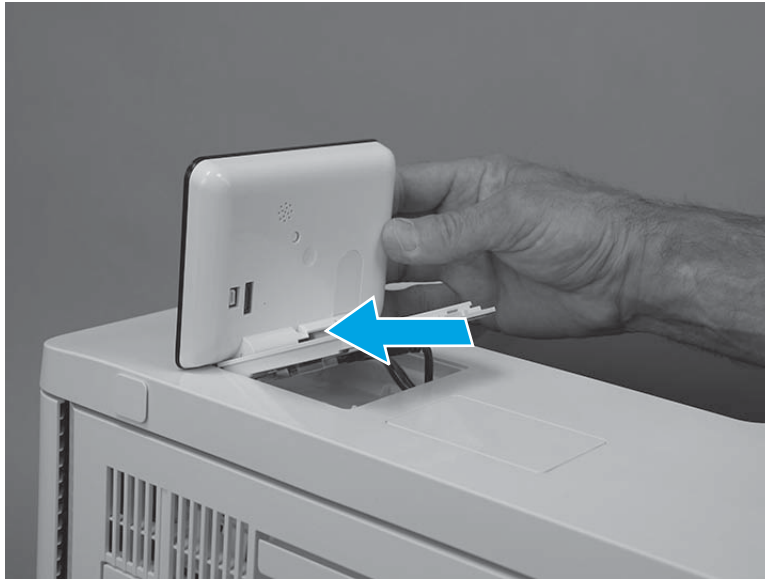

4. Rotate the control-panel base down onto the printer.

Figure 1-4496 Rotate the control-panel base down



5. Use a small Phillips screwdriver to install two screws (callout 1).

Figure 1-4497 Install two screws

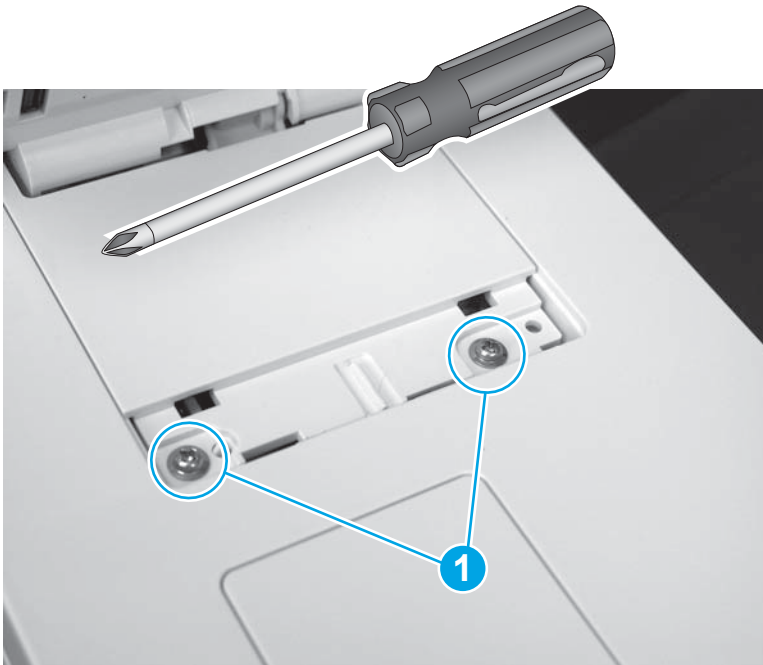

6. Position the screw cover mounting feet into the slots in the top cover (callout 1), and then rotate the cover down (callout 2) to install it.



 **NOTE:** Press down on the cover firmly to make sure that the tabs on the cover (callout 3) snap into place.

Figure 1-4498 Install the cover

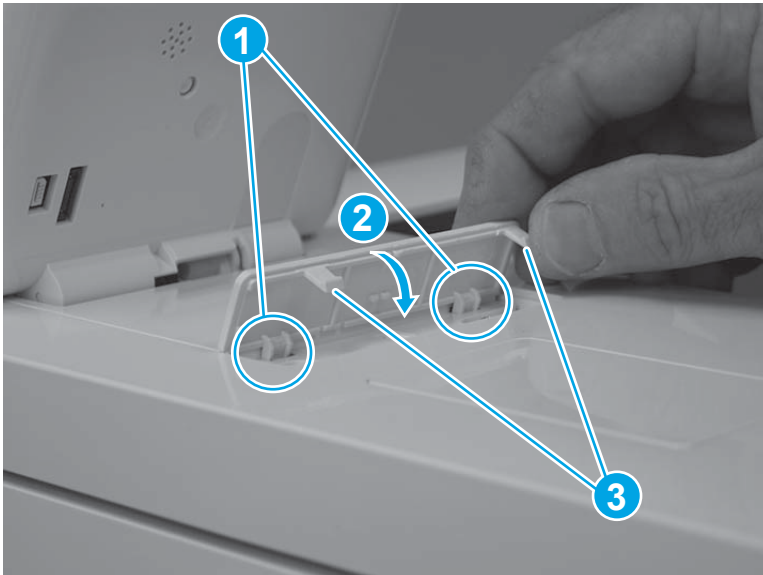

Step 58: Install the USB cover (M552 and M553)

 **NOTE:** This step is for the M552 and M553 models. For the M577 models, skip this step and go to [Step 59: Install the formatter cover on page 2495](#).

1. Push the cover into the USB port to install it.

Figure 1-4499 Install the cover



2. Make sure that the USB cover is fully seated after installing it.

Figure 1-4500 Check the installation

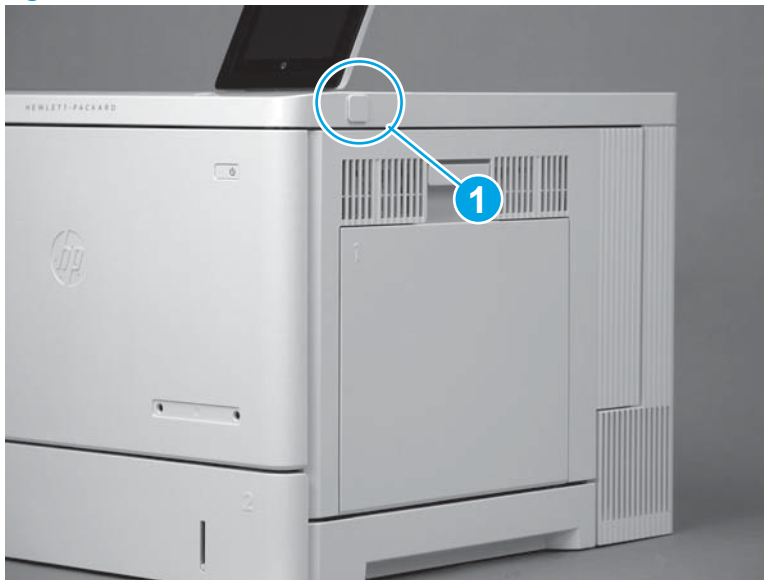

Step 59: Install the formatter cover

- ▲ Slide the cover onto the printer (callout 1) to install it.

 **NOTE:** Make sure that the tabs on the formatter cover align with the slots provided in the printer (callout 2). Tighten the two thumbscrews (callout 3).

 **TIP:** If needed, use the edge of a coin to turn the thumbscrews.

Figure 1-4501 Install the cover



Step 60: Install the TCU

1. Verify that the toner collection hatch cover is in the closed position on the TCU.

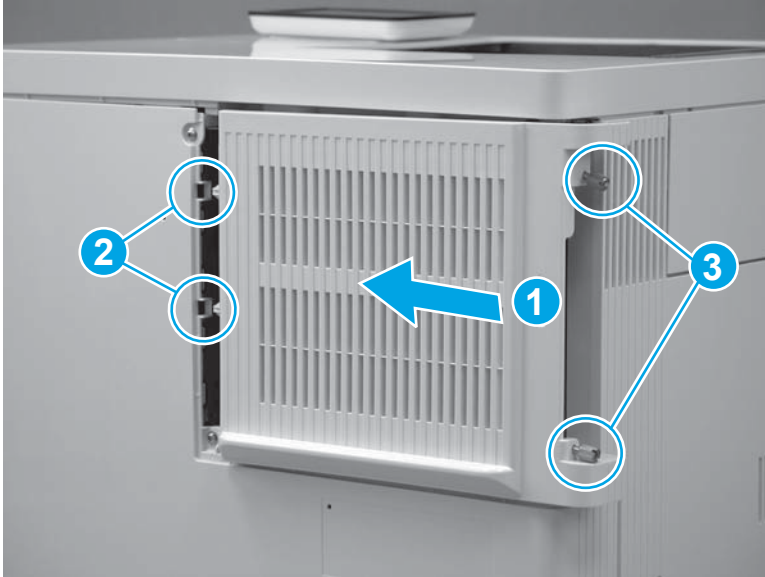
Figure 1-4502 Verify that the toner collection hatch cover is closed

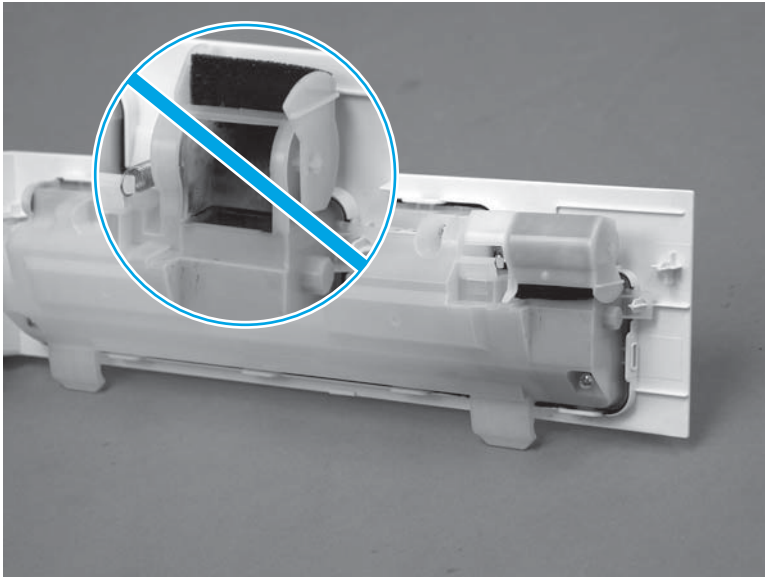

2. Position the TCU with the hinges in the slots provided in the printer (callout 1), and then rotate the TCU up and into the closed position.

 **NOTE:** The toner collection hatch cover automatically opens when the TCU is closed.

Figure 1-4503 Install the TCU



3. Close the front door.

Figure 1-4504 Close the front door

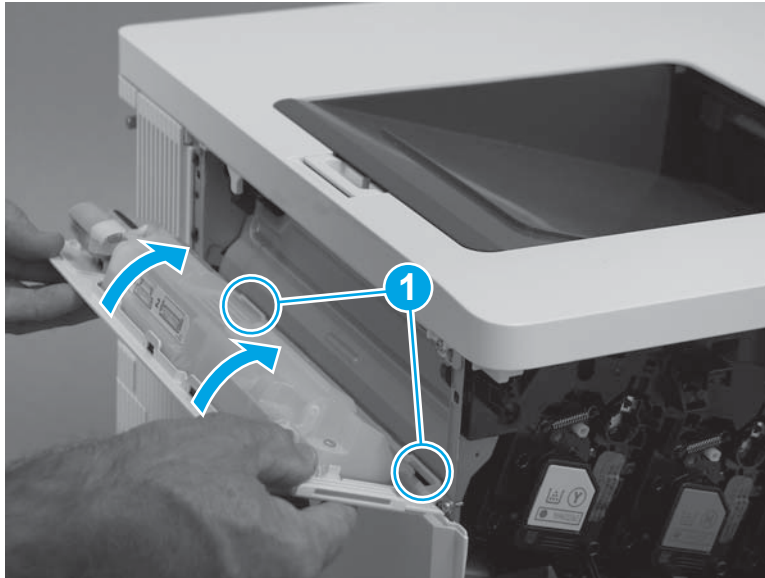

Step 61: Install the tray

1. With the front of the tray slightly lifted, align the sides of the tray with the rails in the printer, and then carefully slide the tray into the printer.

 **TIP:** As the tray slides into the printer, lower the front of it.

Figure 1-4505 Install the tray



2. Close the tray.

Figure 1-4506 Close the tray



Step 62: Install the ITB

CAUTION: Do not touch the grey-plastic belt. Skin oils and fingerprints on the belt can cause print-quality problems.

1. Handle the ITB by the edges. Do not touch the grey-plastic belt. Skin oils and fingerprints on the belt can cause print-quality problems.

Figure 1-4507 Handle the ITB by the edges

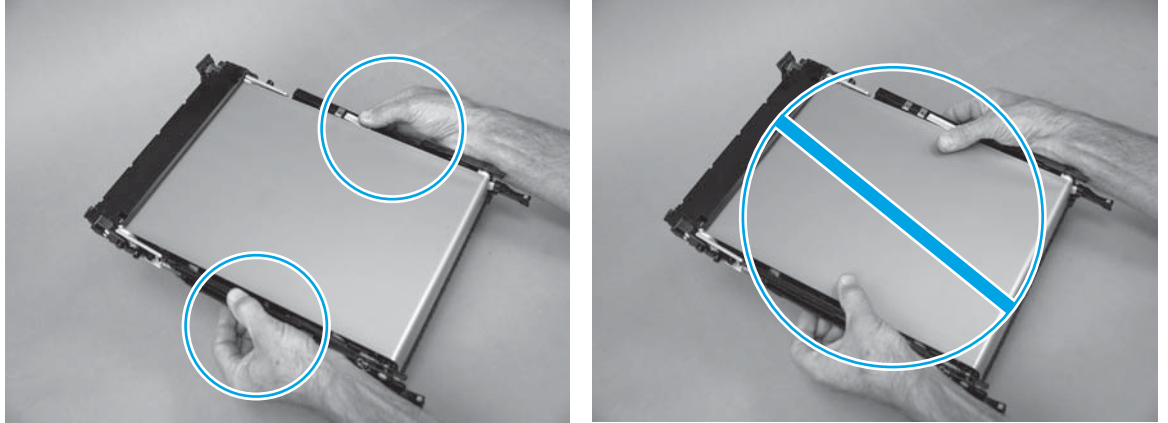

2. Align the ITB with the slots in the printer, and then carefully push it into the printer.

 **NOTE:** Be careful. Do not dislodge the ITB retainer springs from the holders on the chassis. The springs can interfere with installing the ITB.

Figure 1-4508 Align the ITB with the slots in the product



3. Continue to carefully push the ITB into the printer until it is fully installed.

Figure 1-4509 Install the ITB

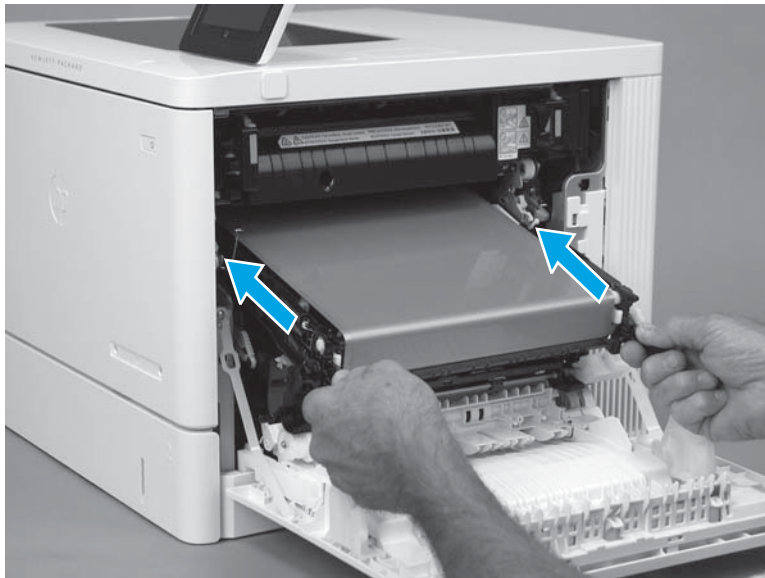
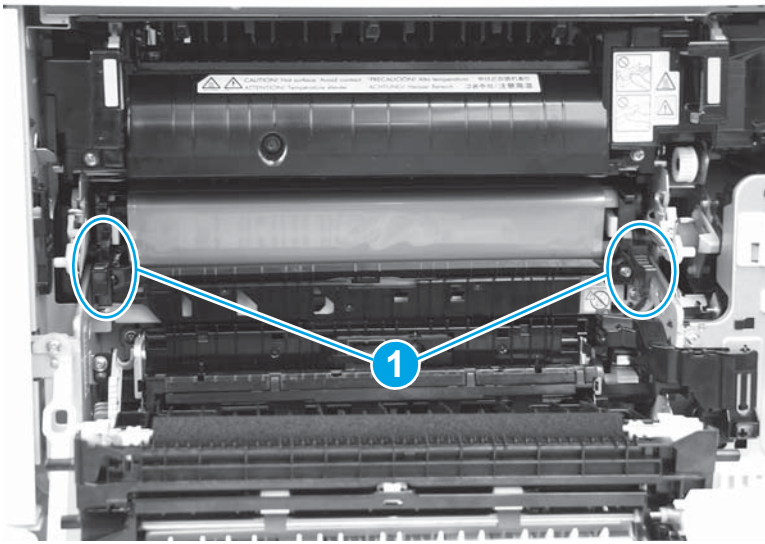

4. Remove the right-side ITB spring from the holder.

Figure 1-4510 Remove the spring from the holder



5. Fasten the right-side ITB spring (callout 1) under the tab (callout 2).

Figure 1-4511 Fasten the rear-side ITB spring

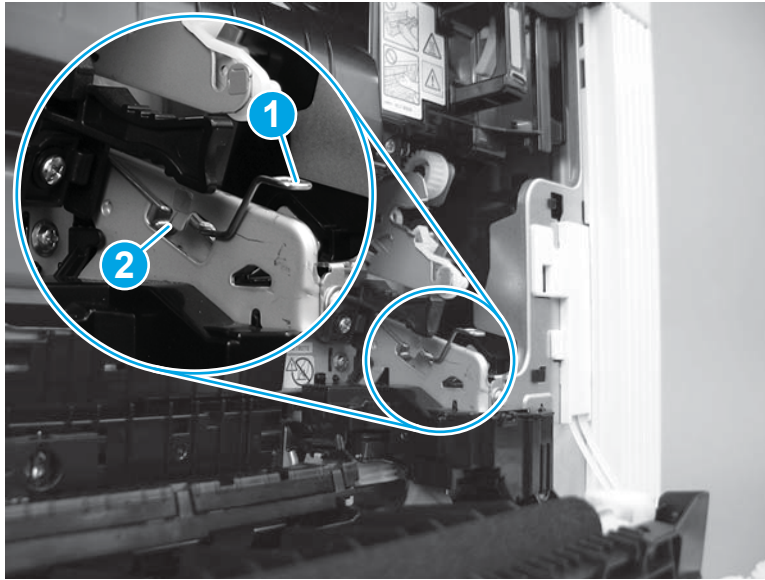

6. Remove the left-side ITB spring from the holder.

Figure 1-4512 Remove the spring from the holder

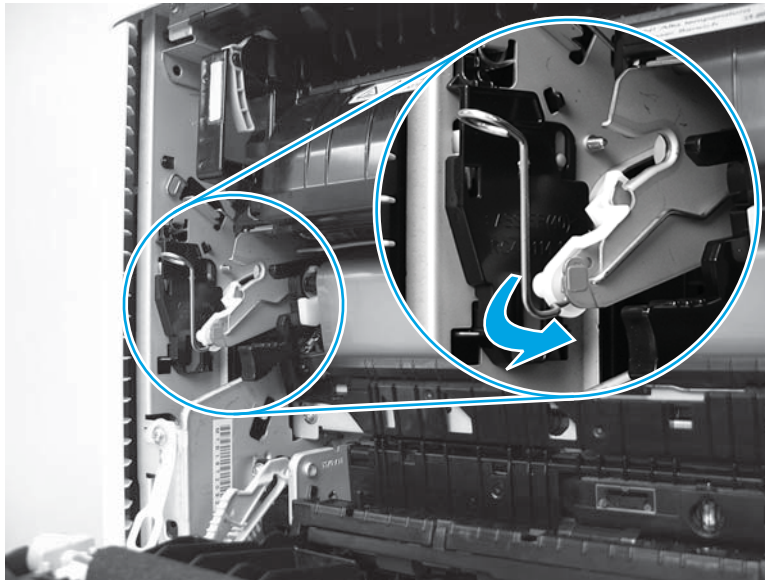

7. Fasten the left-side ITB spring (callout 1) under the tab (callout 2).

Figure 1-4513 Fasten the front-side ITB spring

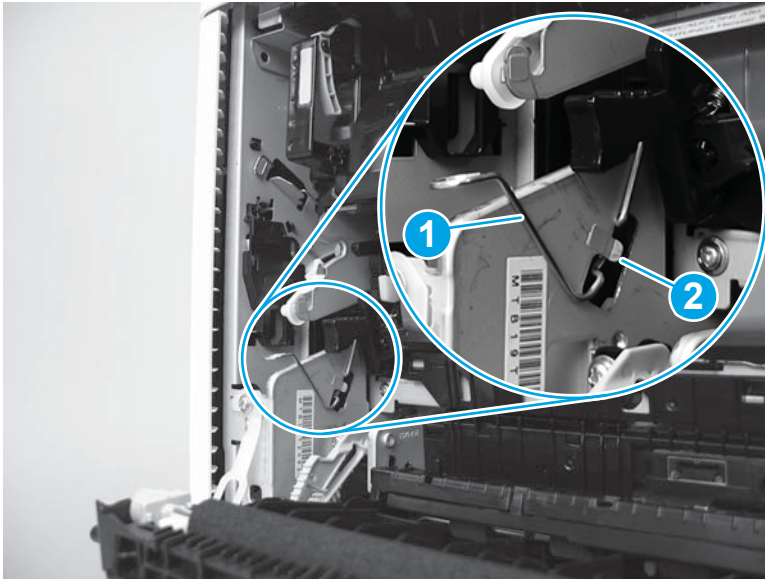

8. Push in the blue lever to engage the ITB drive coupling.

Figure 1-4514 Engage the ITB drive coupling

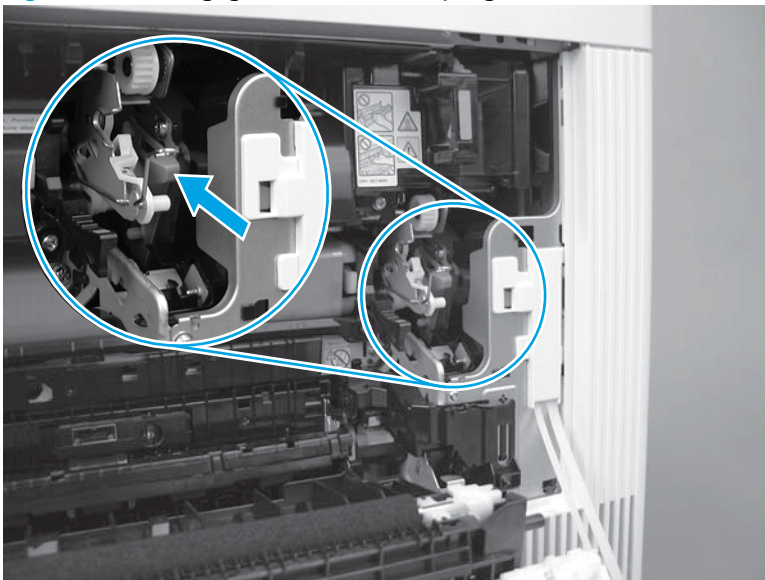

9. Close the right door.

 **TIP:** The right door should close easily if the ITB assembly is correctly installed.

Figure 1-4515 Close the right door



Step 63: Install the secondary transfer roller assembly

1. Move the registration sensor assembly (callout 1) out of the way, and then position the secondary transfer assembly right hinge (callout 2) into the hole provided in the printer.

Figure 1-4516 Install the right hinge

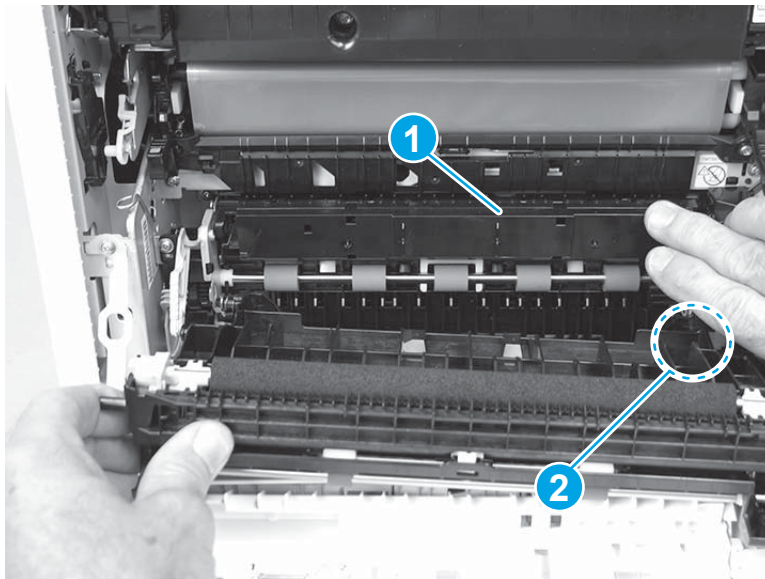

2. Position the assembly left-side hinge near the hole provided in the printer, and then slide the assembly toward the front of the printer to install the hinge in the hole.

Figure 1-4517 Install the left hinge

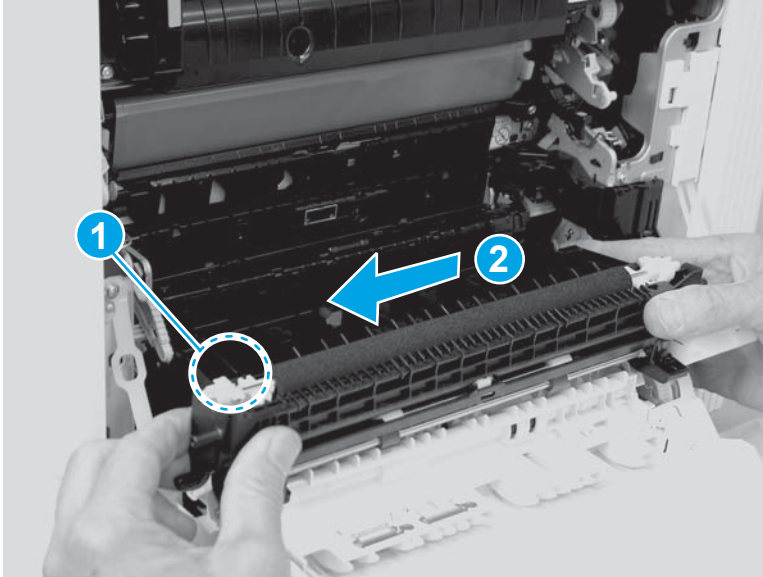

3. Carefully flex the blue arm, and then push it over the pin on the assembly to engage it.

 **NOTE:** Make sure that the pin is correctly installed in the slot on the blue arm.

Figure 1-4518 Engage the blue arm with the pin



4. Close the right door.

 **TIP:** The right door should close easily if the secondary transfer assembly is correctly installed.

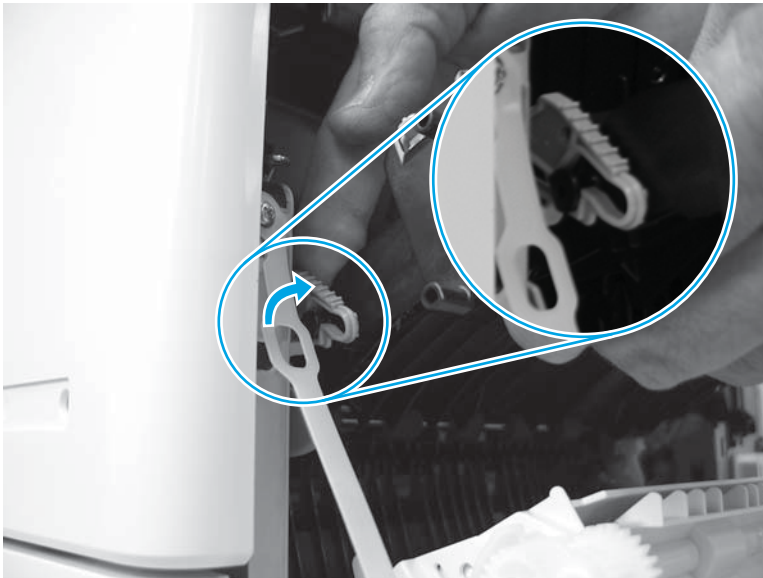
Figure 1-4519 Close the right door



Removal and replacement: Main drive assembly

- [Introduction](#)
- [Step 1: Remove the USB cover \(M552 and M553\)](#)
- [Step 2: Remove the fuser](#)
- [Step 3: Remove the ITB](#)
- [Step 4: Remove the control panel \(M553x only\)](#)
- [Step 5: Remove the tray](#)
- [Step 6: Remove the toner collection unit \(TCU\)](#)
- [Step 7: Remove the formatter cover](#)
- [Step 8: Remove the formatter \(M552 and M553\)](#)
- [Step 9: Remove the hard-disk drive \(HDD\) \(M577\)](#)
- [Step 10: Remove the fax PCA \(M577c/f/z\)](#)
- [Step 11: Remove the formatter \(M577\)](#)
- [Step 12: Remove the rear cover \(M552 and M553\)](#)
- [Step 13: Remove the rear upper cover \(M577\)](#)
- [Step 14: Remove the rear cover \(M577\)](#)
- [Step 15: Remove the left upper cover \(M577\)](#)
- [Step 16: Remove the right front upper cover \(M577dn\)](#)
- [Step 17: Remove the stapler cover assembly \(M577c/f/z\)](#)
- [Step 18: Remove the integrated scanner assembly \(ISA\) \(M577\)](#)
- [Step 19: Remove the stapler unit \(M577c/f/z\)](#)
- [Step 20: Remove the right upper cover \(M577\)](#)
- [Step 21: Remove the top rear cover \(M577\)](#)
- [Step 22: Remove the paper feed cover \(M577\)](#)
- [Step 23: Remove the top cover \(M577\)](#)
- [Step 24: Remove the top bracket \(M577\)](#)
- [Step 25: Remove the left cover](#)
- [Step 26: Remove the upper cover \(M552 and M553\)](#)
- [Step 27: Remove the formatter case](#)
- [Step 28: Remove the right rear cover](#)
- [Step 29: Remove the low-voltage power supply \(LVPS\)](#)



- [Step 30: Remove the power supply fan \(FM1\)](#)
- [Step 31: Remove the high-voltage power supply D \(HVPSD\)](#)
- [Step 32: Remove the lifter drive assembly](#)
- [Step 33: Remove the DC controller and sheet-metal bracket](#)
- [Step 34: Remove the high-voltage power supply T \(HVPST\)](#)
- [Step 35: Remove the fuser drive assembly](#)
- [Step 36: Remove the main-drive assembly](#)
- [Step 37: Unpack the replacement assembly](#)
- [Step 38: Install the main-drive assembly](#)
- [Step 39: Install the fuser drive assembly](#)
- [Step 40: Install the HVPST](#)
- [Step 41: Install the DC controller and sheet-metal bracket](#)
- [Step 42: Install the lifter drive assembly](#)
- [Step 43: Install the HVPSD](#)
- [Step 44: Install the power-supply fan \(FM1\)](#)
- [Step 45: Install the LVPS](#)
- [Step 46: Install the right rear cover](#)
- [Step 47: Install the formatter case](#)
- [Step 48: Install the upper cover \(M552 and M553\)](#)
- [Step 49: Install the left cover](#)
- [Step 50: Install the top bracket \(M577\)](#)
- [Step 51: Install the top cover \(M577\)](#)
- [Step 52: Install the paper feed cover \(M577\)](#)
- [Step 53: Install the top rear cover \(M577\)](#)
- [Step 54: Install the right upper cover \(M577\)](#)
- [Step 55: Install the stapler unit \(M577c/f/z\)](#)
- [Step 56: Install the integrated scanner assembly \(ISA\) \(M577\)](#)
- [Step 57: Install the stapler cover assembly \(M577c/f/z\)](#)
- [Step 58: Install the right front upper cover \(M577dn\)](#)
- [Step 59: Install the left upper cover \(M577\)](#)
- [Step 60: Install the rear cover \(M577\)](#)

- [Step 61: Install the rear upper cover \(M577\)](#)
- [Step 62: Install the rear cover \(M552 and M553\)](#)
- [Step 63: Install the formatter \(M577\)](#)
- [Step 64: Install the fax PCA \(M577c/f/z\)](#)
- [Step 65: Install the HDD \(M577\)](#)
- [Step 66: Install the formatter \(M552 and M553\)](#)
- [Step 67: Install the formatter cover](#)
- [Step 68: Install the TCU](#)
- [Step 69: Install the tray](#)
- [Step 70: Install the control-panel assembly \(M553x only\)](#)
- [Step 71: Install the ITB](#)
- [Step 72: Install the fuser](#)
- [Step 73: Install the USB cover \(M552 and M553\)](#)
- [Step 74: Calibrate the printer](#)
- [Step 75: Perform a color band test](#)

Introduction

This document provides the procedures to remove and replace the main-drive assembly.

Before performing service

 **CAUTION:**  This part contains components that are electrostatic discharge (ESD) sensitive. To reduce the possibility of ESD damage, always touch the sheet-metal chassis to ground yourself before touching an ESD sensitive part.

 **IMPORTANT:** Some figures might show assemblies removed or installed that have not yet been removed or installed at that specific step. However, the procedures are correct for this printer and the target assembly. Always thoroughly read the instructions that accompany each figure.

 **NOTE:** HP does not recommend that this procedure be performed at the customer's location. This procedure can take two hours to complete.

Turn the printer power off

- Disconnect the power cable.

 **WARNING!** To avoid damage to the printer, turn the printer off, wait 30 seconds, and then remove the power cord before attempting to service the printer.

 **IMPORTANT:** If the toner cartridges have not already been removed prior to servicing the printer, remove them now.

The toner cartridges are sensitive to strong light. Set them aside and cover them with paper to protect them.

Use the table below to identify the correct part number for your printer, and then go to <http://h20141.www2.hp.com/hpparts> to order the part.

Main-drive assembly part number	
B5L25-67902	Main-drive assembly with instruction guide

Required tools

- #2 Phillips screwdriver with a magnetic tip

After performing service

Make sure that all of the connectors on the HVPST are fully seated.

Make sure that all of the connectors on the HVPSD are fully seated.

Make sure that all of the connectors on the LVPS are fully seated.

Make sure that all of the connectors on the DC controller are fully seated.

Make sure that the TCU is fully closed after replacing it.

Make sure that all of the connectors on the formatter are fully seated.

Make sure that the formatter cover is fully seated, and that the thumbscrews are finger tight after replacing it. For more information, see the printer troubleshooting manual.

Reinstall the toner cartridges.

Use the [Device Maintenance](#) menu to perform a [Full Calibration](#). For more information, see the printer troubleshooting manual.

Use the [Troubleshooting](#) menu to perform a [Color Band Test](#). For more information, see the printer troubleshooting manual.

Turn the printer power on

- Connect the power cable.
- Use the power switch to turn the power on.

Post service test

Use the [Troubleshooting](#) menu to perform a [Color Band Test](#). For more information, see the printer troubleshooting manual.

Print a configuration page to make sure that the printer is functioning correctly.

Step 1: Remove the USB cover (M552 and M553)



NOTE: This step is for the M552 and M553 models. For the M577 models, skip this step and go to [Step 5: Remove the tray on page 2520](#).

1. Locate the USB cover.

Figure 1-4520 Locate the USB cover



2. Pull the cover off of the printer to remove it.

Figure 1-4521 Remove the cover



Step 2: Remove the fuser

1. Open the right door.

CAUTION: The fuser is very hot. After turning the printer power off, allow the fuser to cool for at least 30 minutes before removing it.

Figure 1-4522 Open the right door



2. Grasp the two fuser handles, and then squeeze the two blue triggers on the handles to release the fuser.

Figure 1-4523 Release the fuser

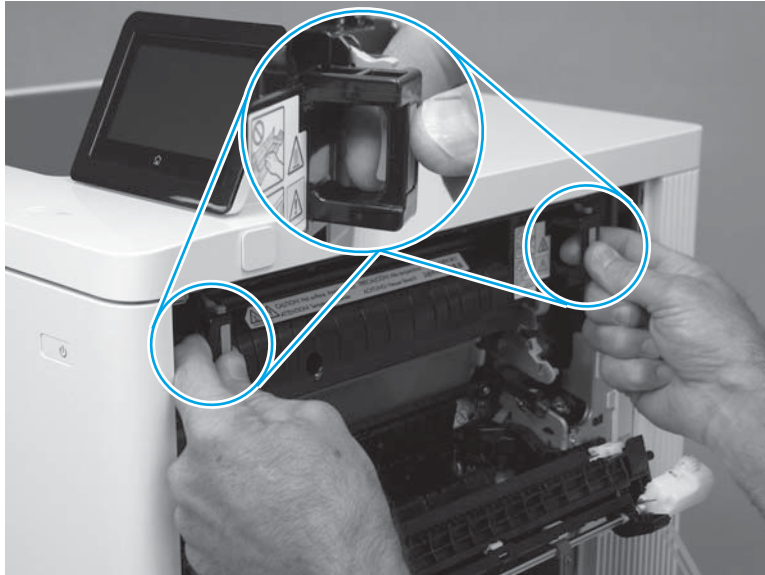

3. Slide the fuser straight out of the printer to remove it.

Figure 1-4524 Remove the fuser



Step 3: Remove the ITB

CAUTION: Do not touch the grey-plastic belt. Skin oils and fingerprints on the belt can cause print-quality problems.

1. Pull the blue lever to release the ITB drive coupling.

Figure 1-4525 Release the ITB drive coupling

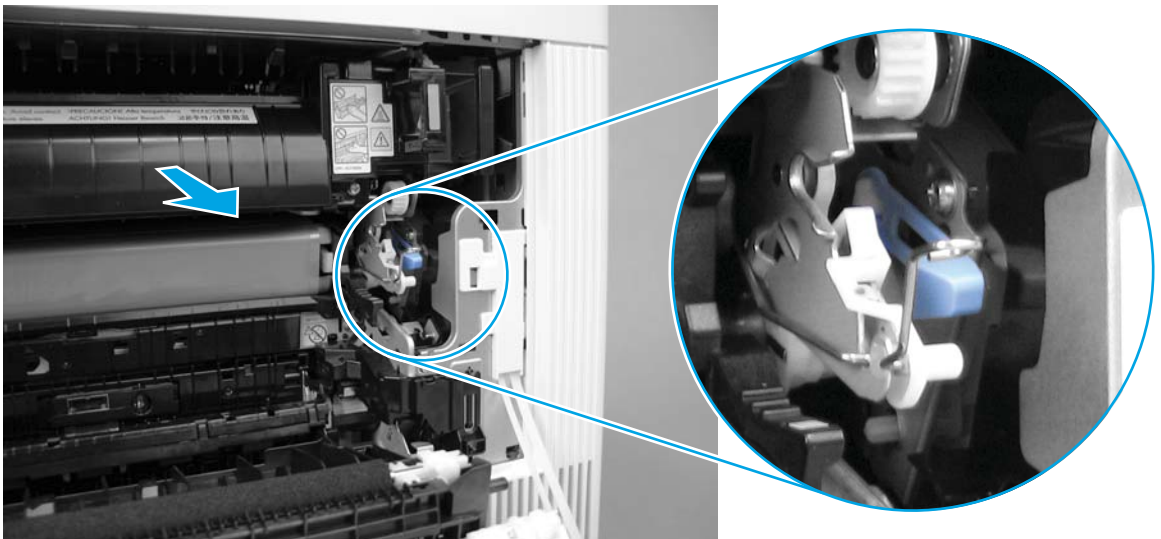

2. Push in on the blue arm to release the secondary transfer roller assembly, and then completely lower the assembly.

 **NOTE:** Press the blue arm on the secondary transfer roller assembly a second time to release the roller assembly when it stops at the halfway open position.

Figure 1-4526 Lower the secondary transfer roller assembly



3. Release the left-side ITB spring (callout 1) from the tab (callout 2).

Figure 1-4527 Release the front-side ITB spring

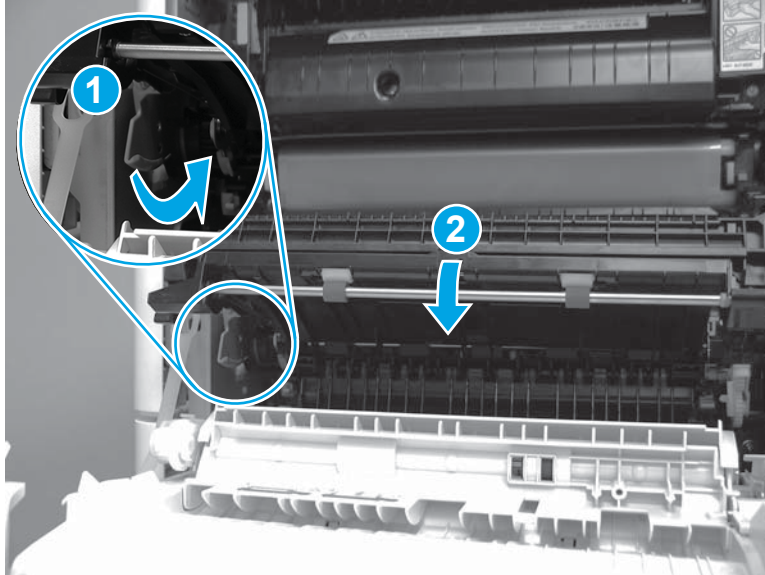
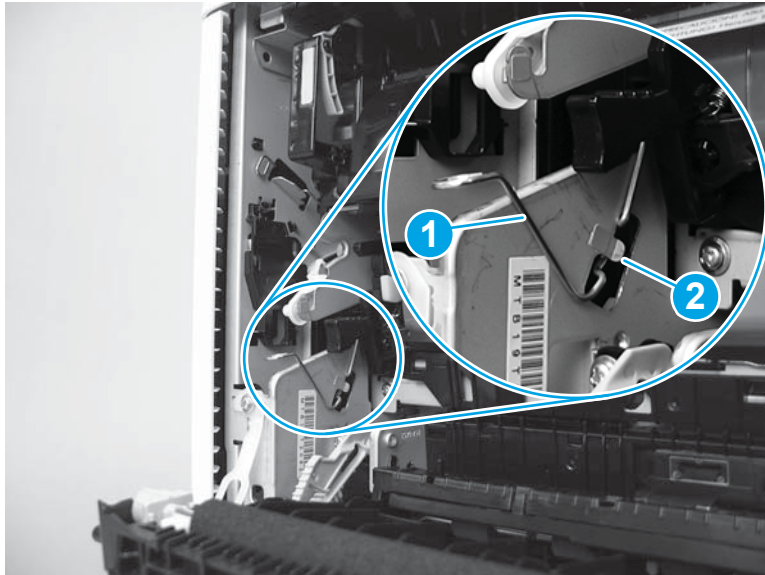

4. Place the left-side ITB spring on the holder to keep it out of the way.

 **TIP:** The holder is colored blue to help locate it.

Figure 1-4528 Place the spring on the holder

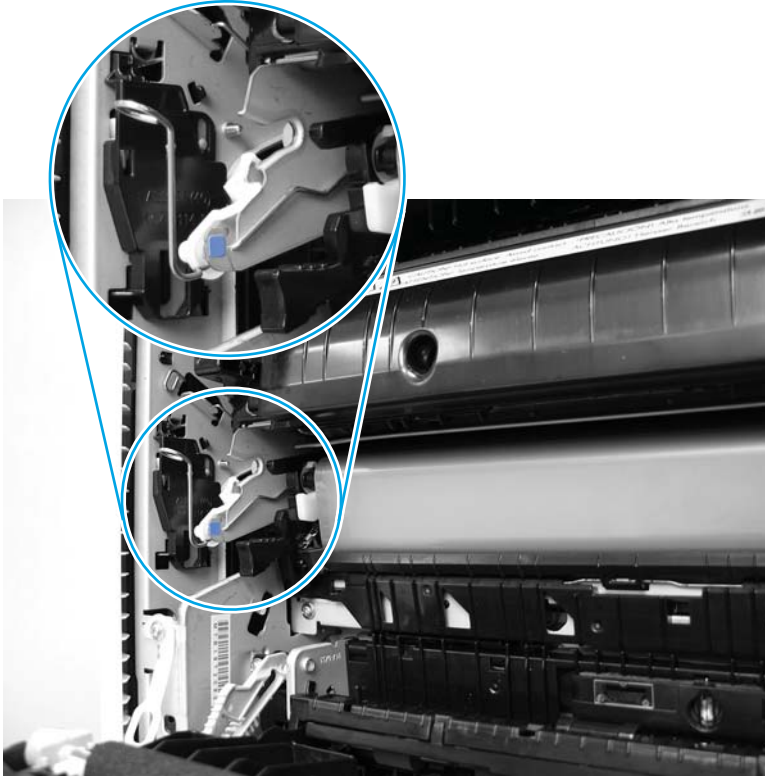

5. Release the right-side ITB spring (callout 1) from the tab (callout 2).

Figure 1-4529 Release the rear-side ITB spring

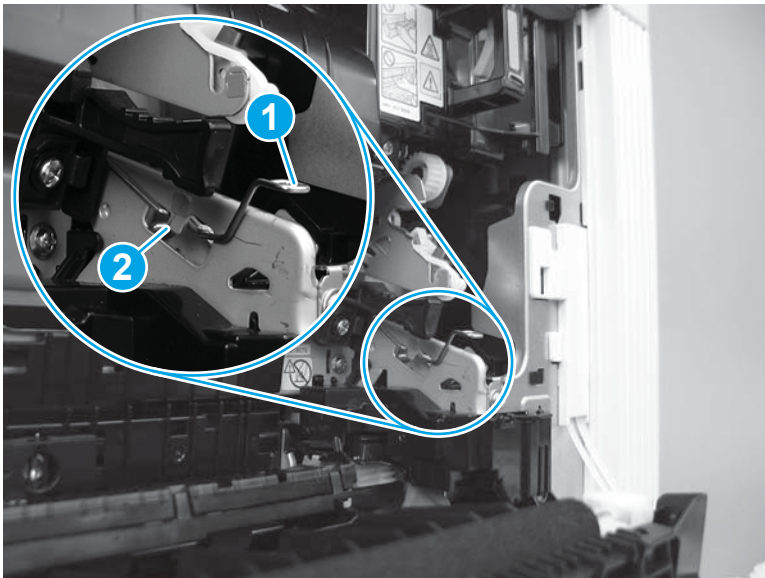

6. Place the right-side ITB spring on the holder to keep it out of the way.

 **TIP:** The holder is colored blue to help locate it.

Figure 1-4530 Place the spring on the holder

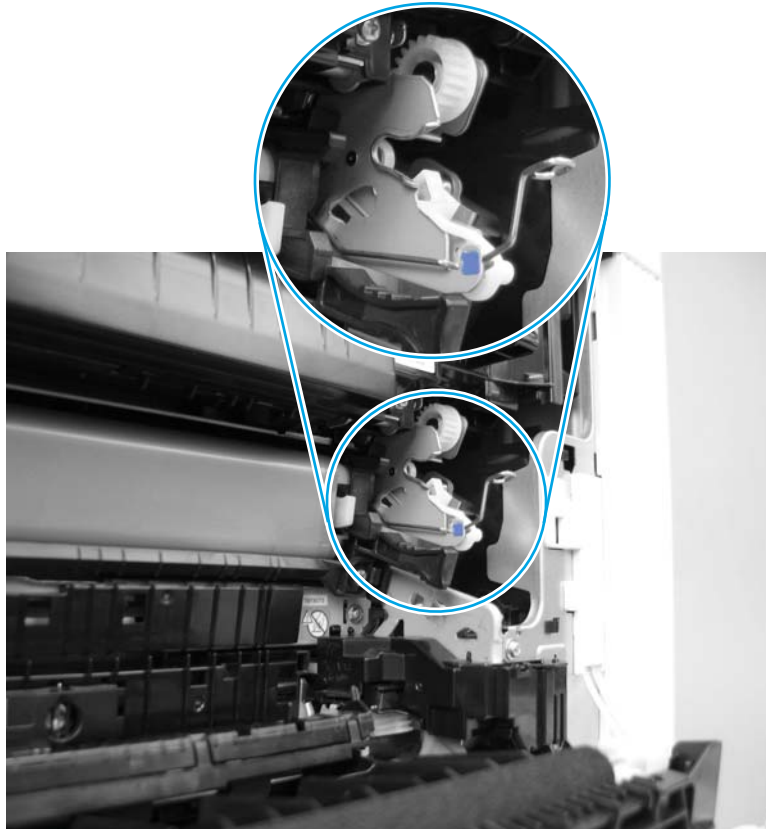

7. Grasp the two blue handles on the ITB.

⚠ CAUTION: If the ITB is removed to access other assemblies in the printer, use care. The ITB is a sensitive assembly. Be careful when handling the ITB so that it is not damaged. Always place the ITB in a safe and protected location.

Figure 1-4531 Grasp the ITB handles

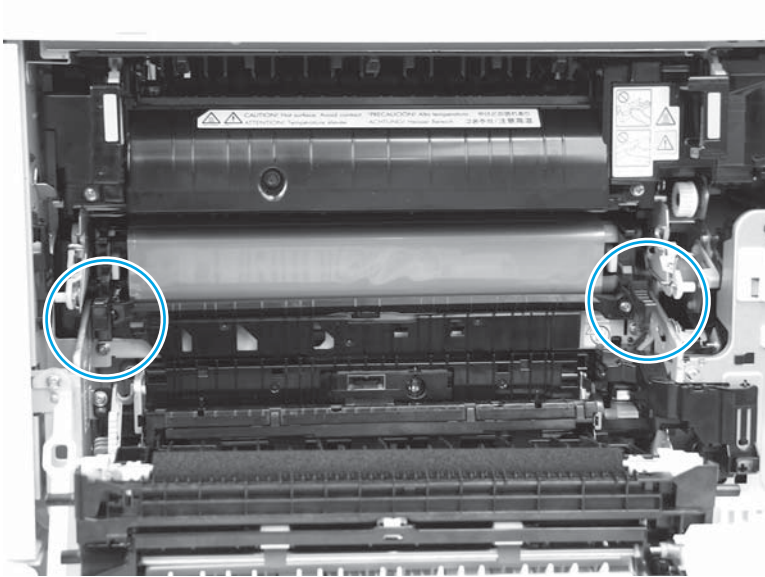

8. Pull the ITB out of the printer to remove it.

⚠ CAUTION: Do not touch the grey-plastic belt. Skin oils and fingerprints on the belt can cause print-quality problems.

Figure 1-4532 Remove the ITB

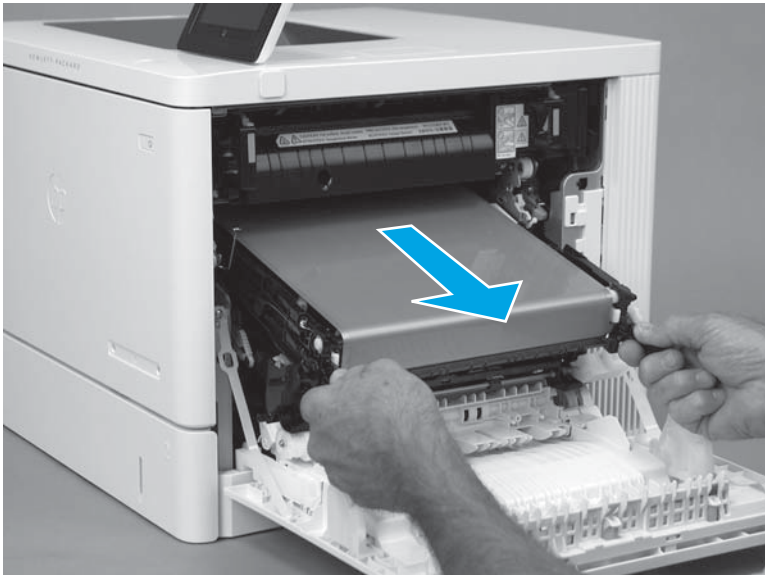

Step 4: Remove the control panel (M553x only)

 **NOTE:** This step is for the M553x model. For the M553n/dn, M552dn, and M577 models, skip this step and go to [Step 5: Remove the tray on page 2520](#).

1. Tilt the control panel up.

Figure 1-4533 Tilt the control panel up



2. Use a small flat-blade screwdriver to release the control-panel screws cover tabs.

Figure 1-4534 Release the control-panel screws cover tabs



3. Rotate the cover up to remove it.

Figure 1-4535 Remove the cover

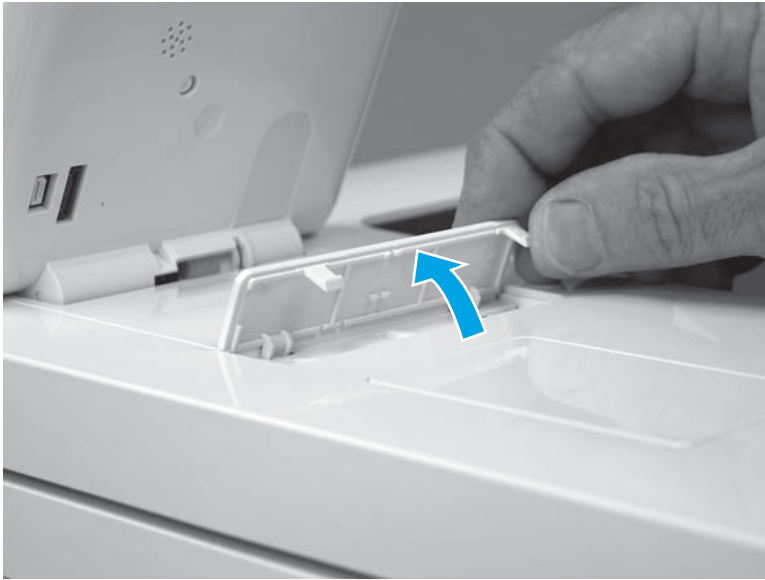

4. Use a small Phillips screwdriver to remove two screws (callout 1).

 **IMPORTANT:** Store the screws in a secure place where they cannot fall down into the printer.

Figure 1-4536 Remove two screws

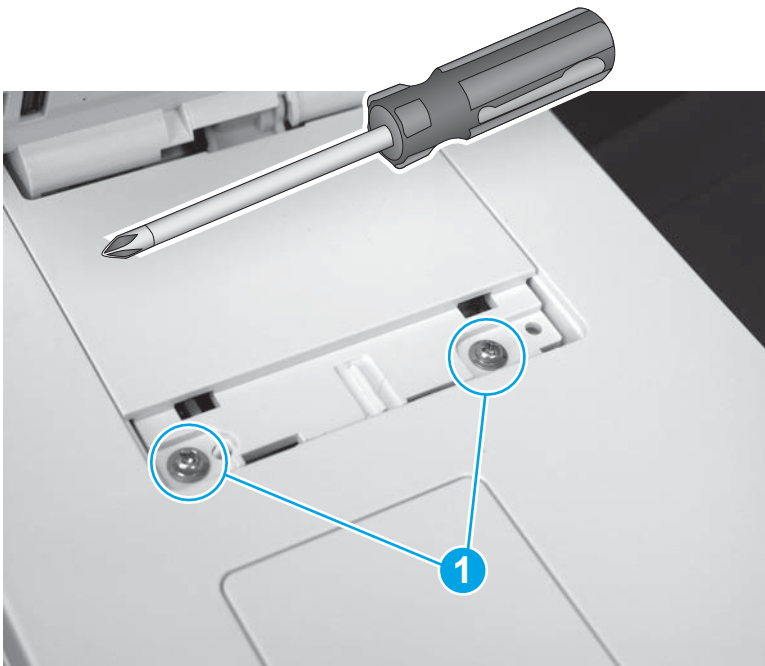

5. Rotate the control-panel base toward the front of the printer.

Figure 1-4537 Rotate the control-panel base up



6. Slightly slide the control-panel base toward the rear of the printer (callout 1) to release it, and then turn the control panel over (callout 2) to access the bottom side.

⚠ CAUTION: The control panel is still attached to the printer. Do not attempt to completely remove the control panel.

Figure 1-4538 Turn the control panel over

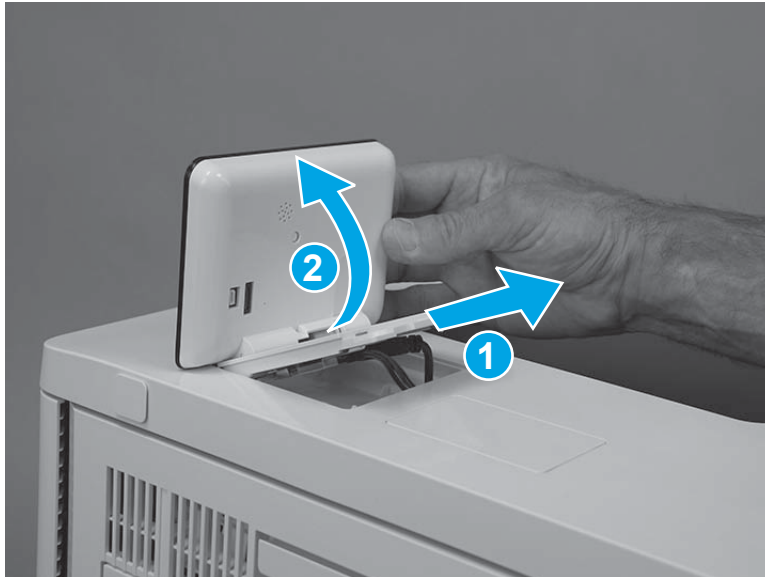

7. Disconnect one USB cable (callout 1), one connector (callout 2), and then remove the control panel.

Figure 1-4539 Disconnect two connectors

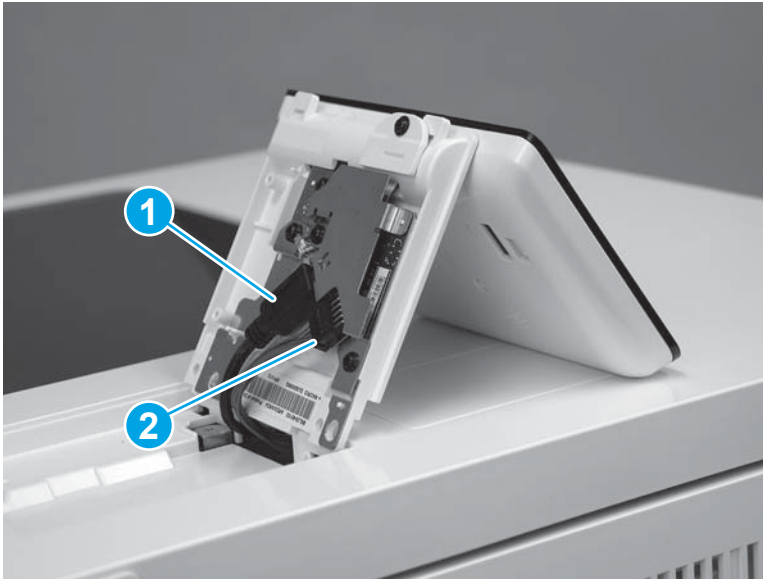

Step 5: Remove the tray

1. Pull the tray out until it stops.

Figure 1-4540 Pull the tray out



2. Lift the front of the tray, and then pull it out of the printer to remove it.

Figure 1-4541 Remove the tray

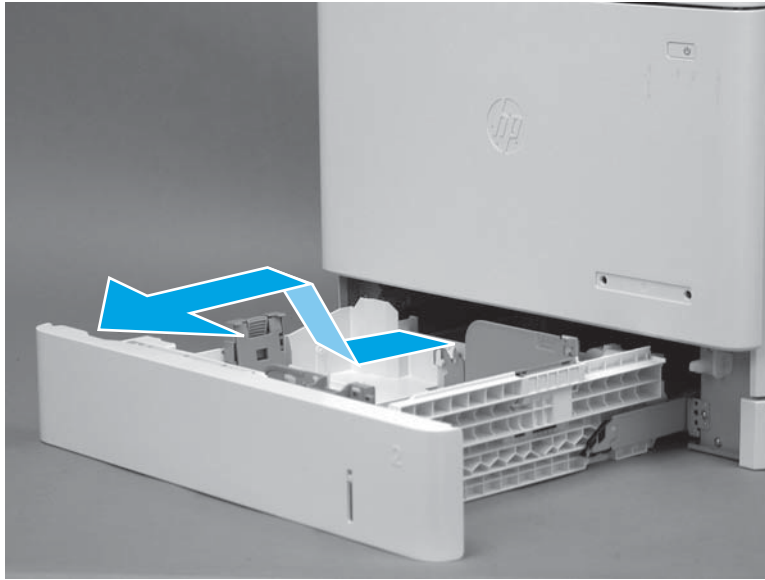

Step 6: Remove the toner collection unit (TCU)

1. Open the front door.

Figure 1-4542 Open the front door



2. Open the TCU.

 **NOTE:** The toner collection hatch cover automatically closes when the TCU is opened.

Figure 1-4543 Open the TCU



3. Pull the TCU away from the printer at an angle to remove it.

⚠ CAUTION: Do not open the toner collection hatch cover when handling the TCU. If toner gets on clothing, wipe it off by using a dry cloth and wash the clothes in cold water. Hot water sets toner into fabric.

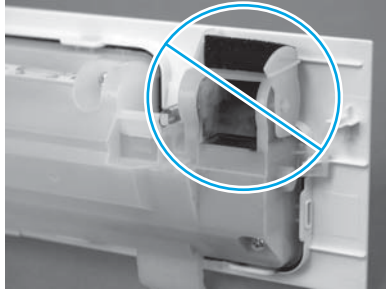
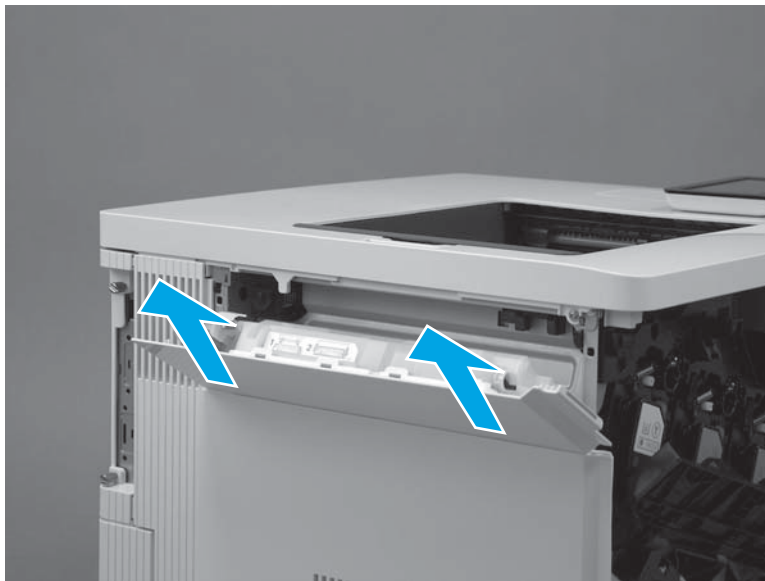

Figure 1-4544 Remove the TCU



Step 7: Remove the formatter cover

1. Locate the formatter cover.

Figure 1-4545 Locate the formatter cover

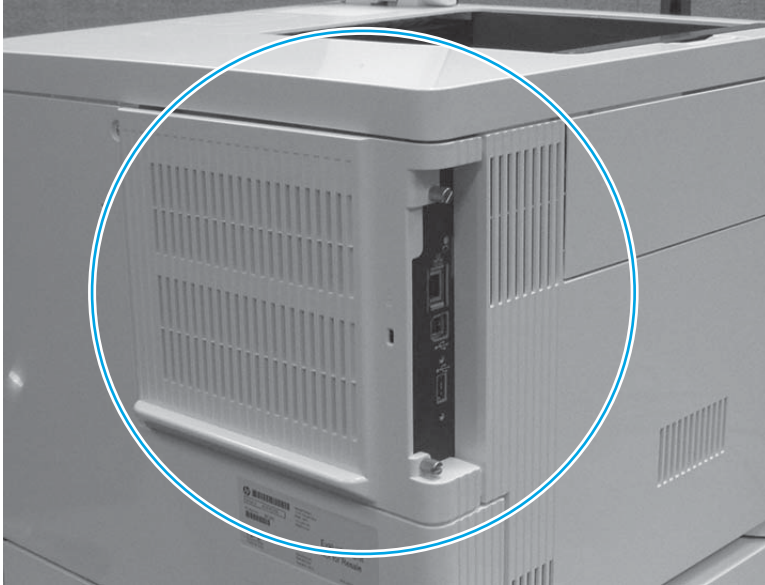

2. Loosen the two thumbscrews (callout 1). Grasp the two thumbscrews, and then slide the cover away from the printer (callout 2) to remove it.

 **TIP:** If needed, use the edge of a coin to turn the thumbscrews.

Figure 1-4546 Loosen the thumbscrews



Step 8: Remove the formatter (M552 and M553)

 **NOTE:** This step is for the M552 and M553 models. For the M577 models, skip this step and go to [Step 9: Remove the hard-disk drive \(HDD\) \(M577\) on page 2526](#).

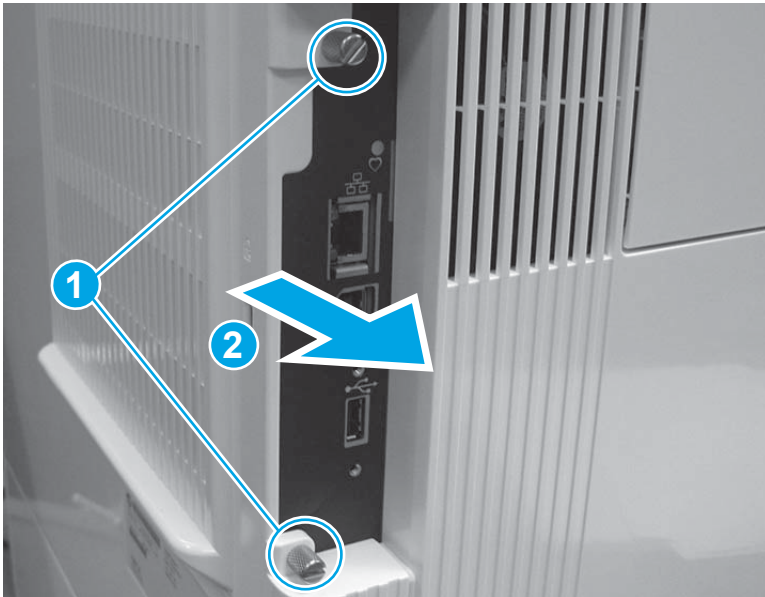
If the optional hard-disk drive (HDD) is installed, it must be removed to gain access to the formatter mounting screws.

Release two tabs along the left edge of the HDD, rotate the left edge away from the product, and then slide the HDD to the left to remove it.

 **CAUTION:**  ESD-sensitive part.

1. Disconnect all of the connectors on the formatter.

The following connectors are empty:

- All models: J1 (this connector is empty unless the optional DIMM is installed)
- M553n/dn and M552dn: J2 (callout 1; this is the touchscreen connector for the M553x model)
- All models: J9 (this connector is empty unless the optional internal USB ports component is installed)
- All models: J18 (this connector is empty unless the optional hard-disk-drive (HDD) is installed)
- All models: J23
- All models: J24
- M553n/dn and M552dn: J25 (this is the wireless connector for the M553x model)
- All models: J57
- All models: J98 (this connector is empty unless the optional trusted platform module (TPM) is installed)

 **IMPORTANT:** The flat-cable connector (callout 2) is a Zero Insertion Force (ZIF) connector that uses a hinged retainer to secure the flat cable. The hinged retainer must be opened to release the flat cable.

Figure 1-4547 Disconnect all connectors



2. Remove four screws (callout 1), and then remove the formatter.

Figure 1-4548 Remove the formatter

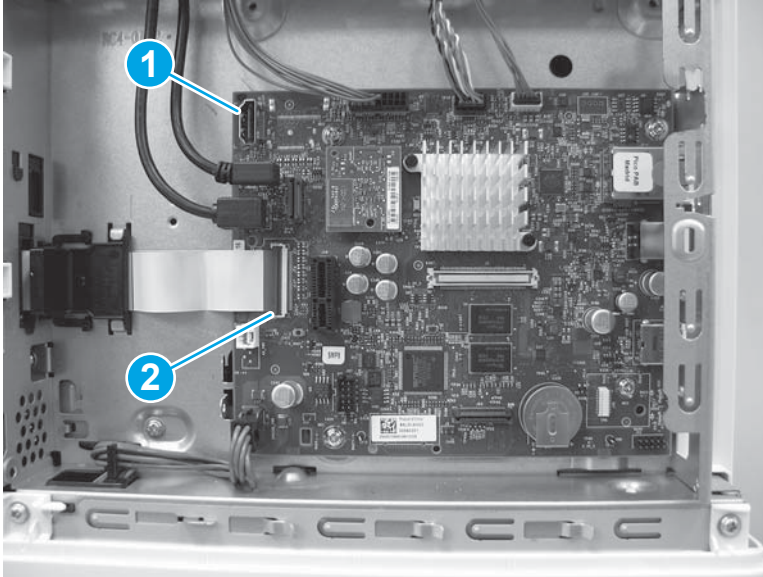
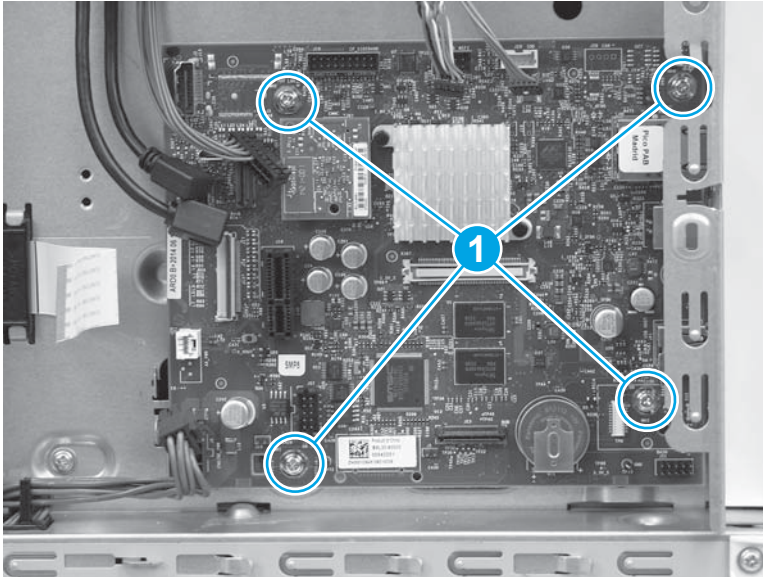

Step 9: Remove the hard-disk drive (HDD) (M577)



NOTE: This step is for the M577 models. For the M552 and M553 models, skip this step and go to [Step 12: Remove the rear cover \(M552 and M553\) on page 2531](#).



CAUTION:  ESD-sensitive part.

1. Release two tabs (callout 1). Hold the tabs in the released position, and then rotate the hard disk drive (HDD) up (callout 2) to release the connector from the formatter.

Figure 1-4549 Release the HDD

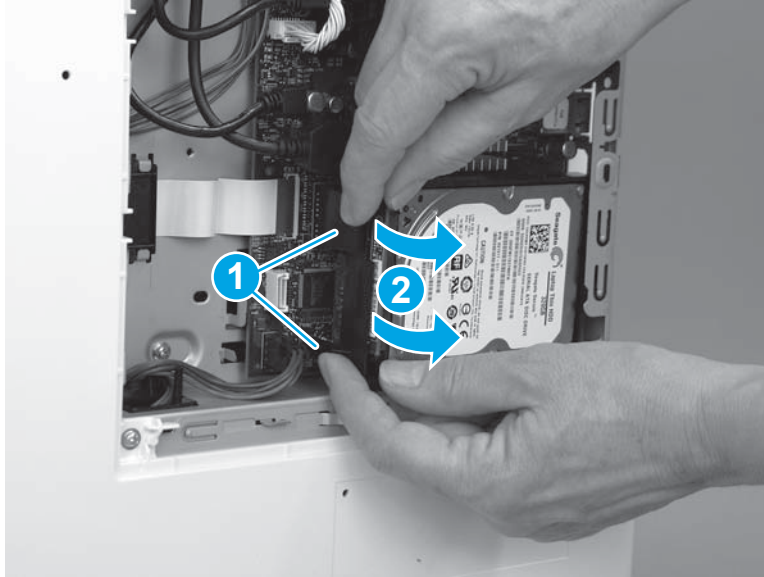

2. Slide the HDD away from the printer to remove it.

Figure 1-4550 Remove the HDD

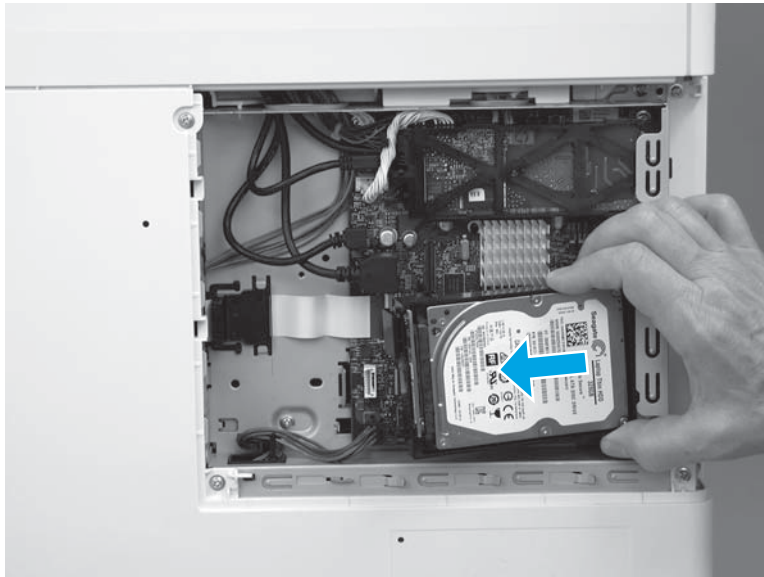

Step 10: Remove the fax PCA (M577c/f/z)

 **NOTE:** This step is for the M577c/f/z models. For the M577dn model, skip this step and go to [Step 11: Remove the formatter \(M577\) on page 2529.](#)

For the M552 and M553 models, skip this step and go to [Step 12: Remove the rear cover \(M552 and M553\) on page 2531.](#)

 **CAUTION:**  ESD-sensitive part.

1. Locate the fax PCA component on the formatter.

Figure 1-4551 Locate the fax PCA

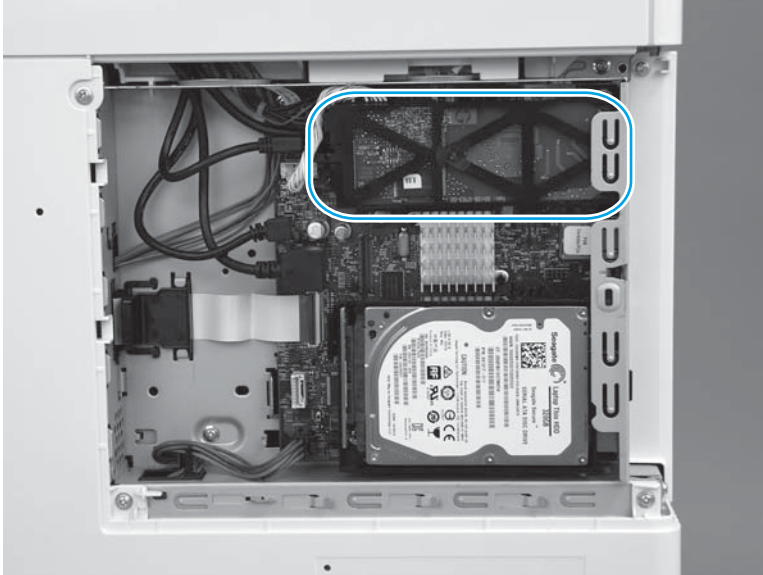

2. Release the connector latch (callout 1), and then pull the connector away from the formatter (callout 2) to disconnect it.

Figure 1-4552 Disconnect one connector

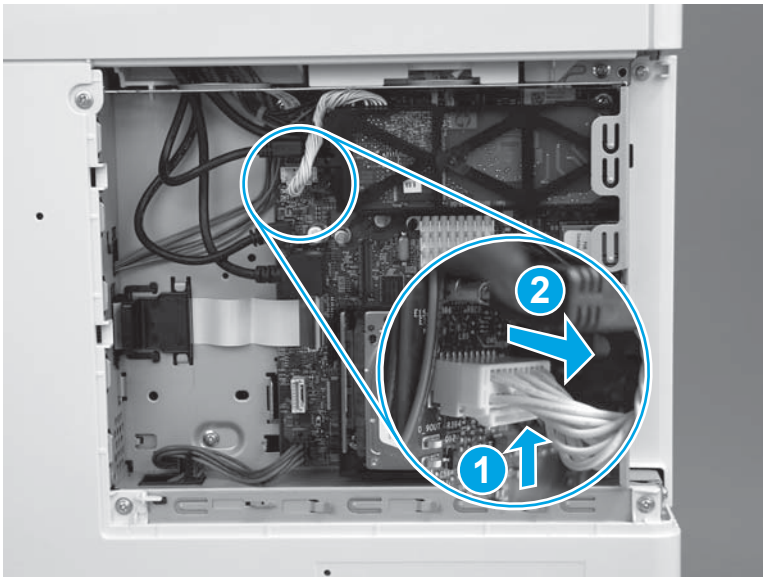

3. Release one retainer (callout 1) by pressing the bracket arms together.

Figure 1-4553 Release one latch

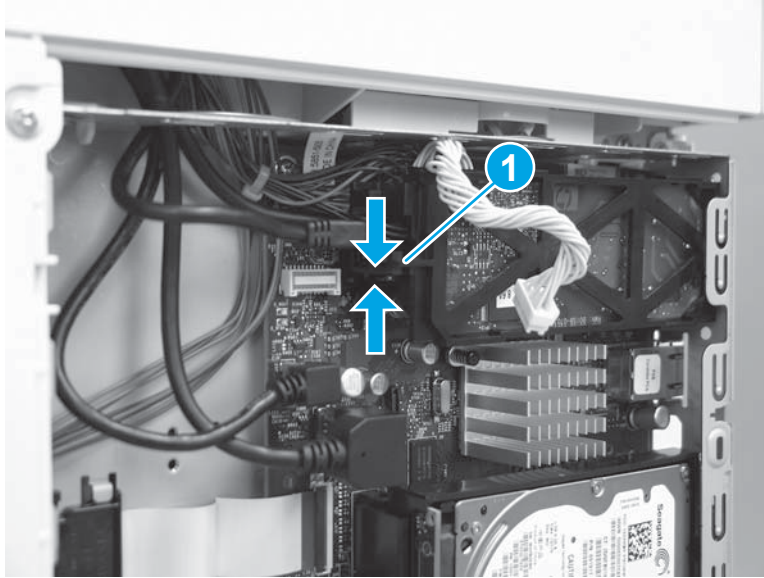

4. Rotate the end of the fax PCA (callout 1) away from the formatter, and then slide the PCA left (callout 2) to remove it.

Figure 1-4554 Remove the fax PCA

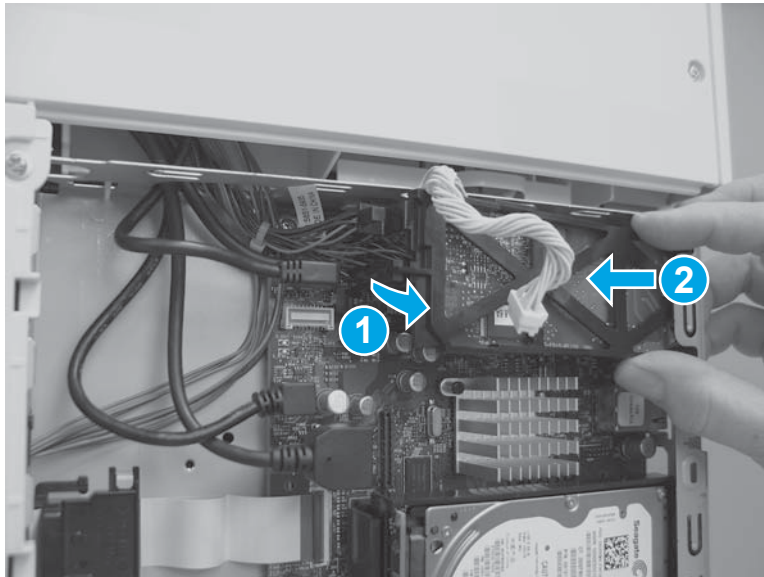

Step 11: Remove the formatter (M577)

 **NOTE:** This step is for the M577 models. For the M552 and M553 models, skip this step and go to [Step 12: Remove the rear cover \(M552 and M553\) on page 2531](#).

 **CAUTION:**  ESD-sensitive part.

1. Disconnect all of the connectors on the formatter.

The following connectors are empty:

- All models: J1 (this connector is empty unless the optional DIMM is installed)
- All models: J3
- M577dn: J15 (this is the fax connector for the M577f/z/c models)
- All models: J21 (this connector is empty unless the optional internal USB ports component is installed)
- All models: J23
- All models: J24
- All models: J51
- All models: J57
- All models: J97
- All models: J98 (this connector is empty unless the optional trusted platform module (TPM) is installed)

 **IMPORTANT:** The flat-cable connector (callout 1) is a Zero Insertion Force (ZIF) connector that uses a hinged retainer to secure the flat cable. The hinged retainer must be opened to release the flat cable.

Figure 1-4555 Disconnect all connectors



2. Remove four screws (callout 1).

Figure 1-4556 Remove four screws

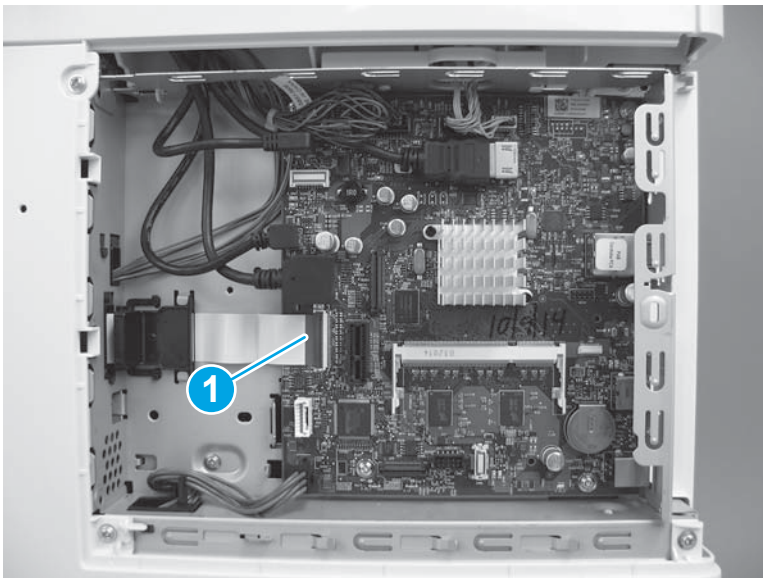
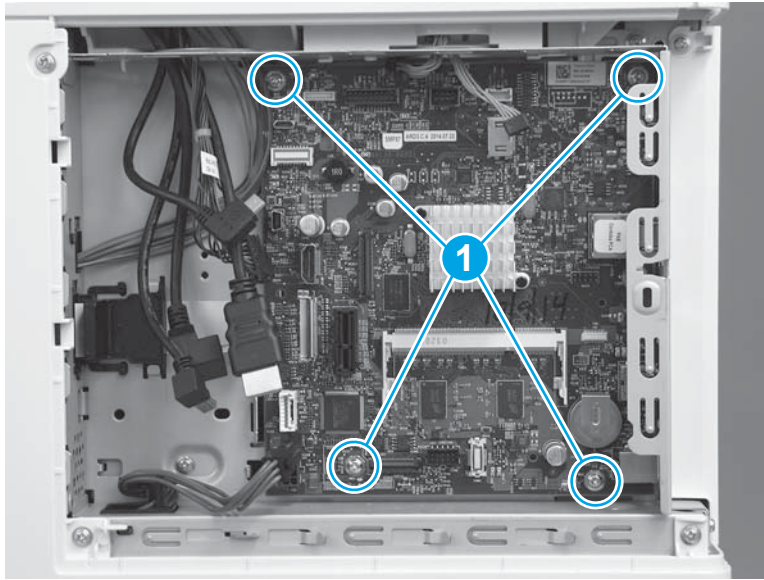

3. Remove the formatter.

Figure 1-4557 Remove the formatter

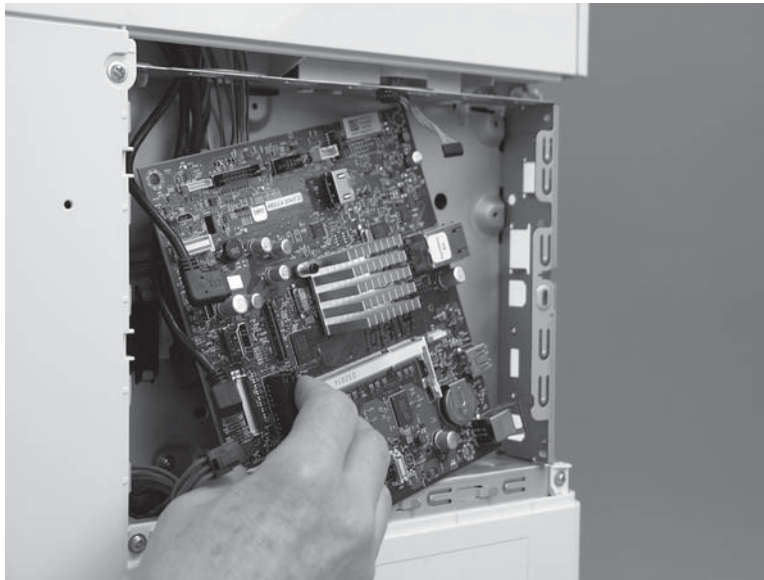

Step 12: Remove the rear cover (M552 and M553)

 **NOTE:** This step is for the M552 and M553 models. For the M577 models, skip this step and go to [Step 13: Remove the rear upper cover \(M577\) on page 2532.](#)

1. Remove four screws (callout 1).

Figure 1-4558 Remove four screws

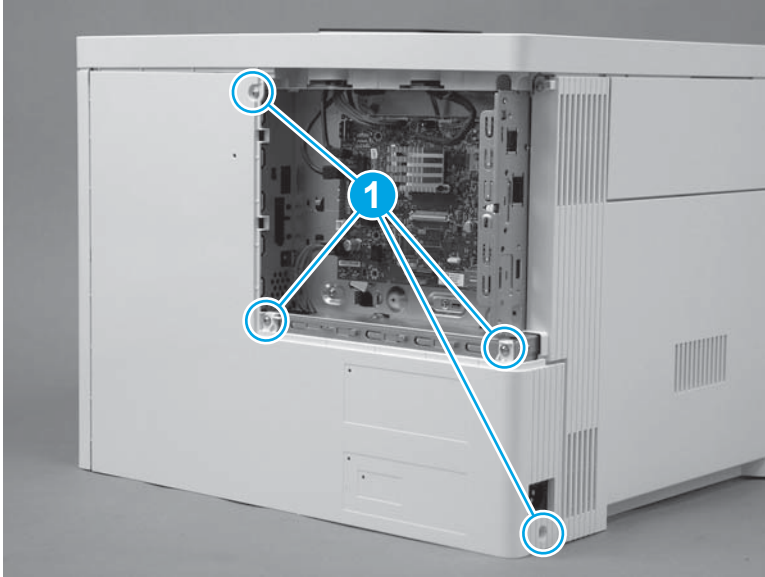

2. Slightly slide the cover to the right (callout 1), rotate the bottom of the cover away from the printer (callout 2), and then pull the top of the cover away from the printer (callout 3) to remove the cover.

Figure 1-4559 Remove the cover

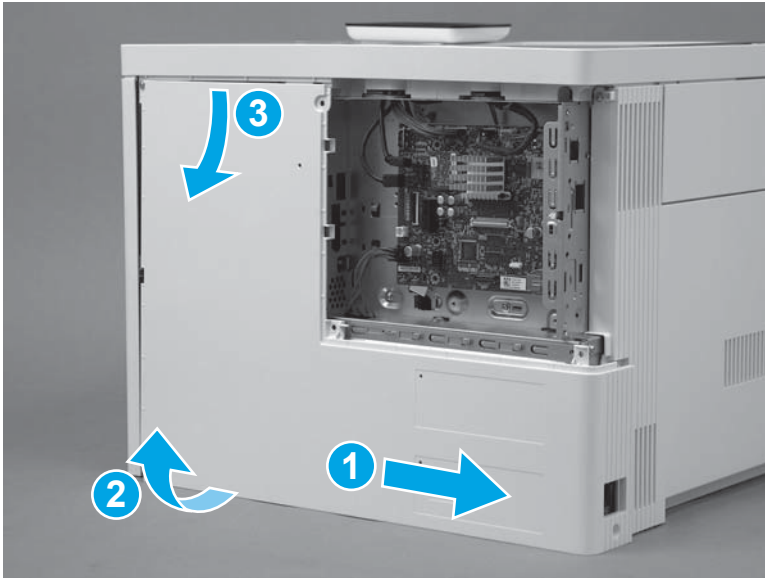

Step 13: Remove the rear upper cover (M577)



NOTE: This step is for the M577 models. For the M552 and M553 models, skip this step and go to [Step 25: Remove the left cover on page 2552](#).

1. Remove two screws (callout 1).



Reinstallation tip: These two screws are self-tapping screws for plastic. When reinstalling them, rotate the screws counterclockwise to align them with the existing thread pattern, and then carefully turn them clockwise to tighten. Do not overtighten. This will prevent stripping the threads inside the screw holes.

Figure 1-4560 Remove two screws

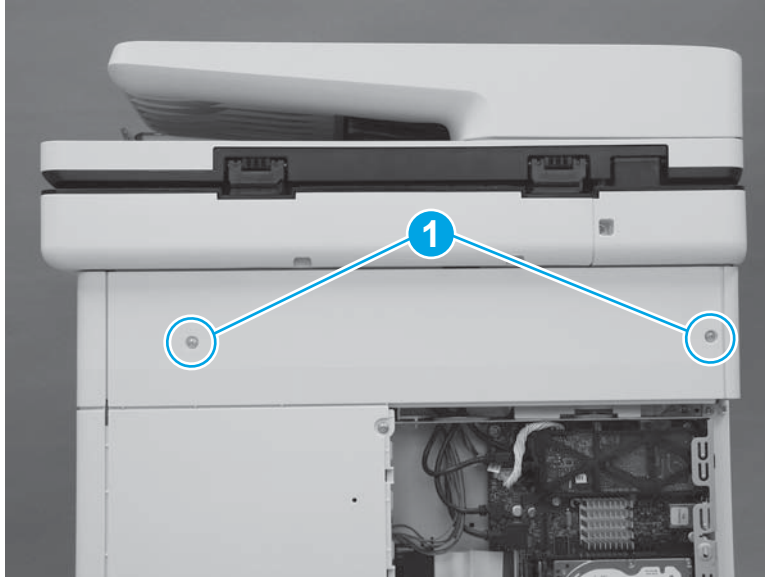

2. Use a small, flat blade screwdriver to release the right edge of the cover.

Figure 1-4561 Release the right edge

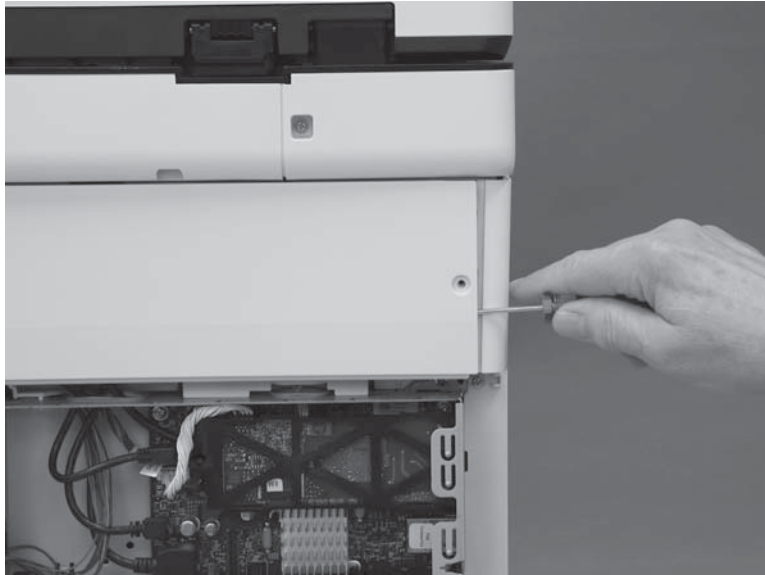

3. Pull the right edge of the cover (callout 1) away from the printer, and then slide the cover to the right (callout 2).

Figure 1-4562 Slide the cover right

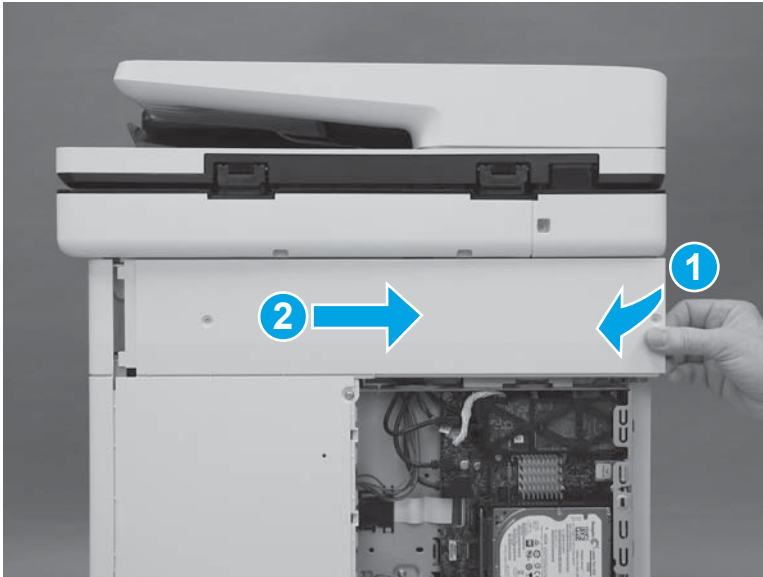

4. Remove the cover.

Figure 1-4563 Remove the cover

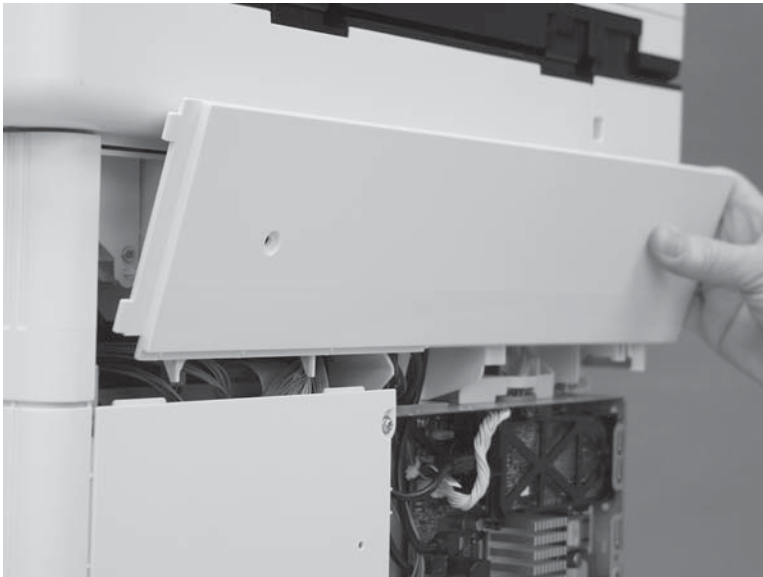

Step 14: Remove the rear cover (M577)



NOTE: This step is for the M577 models. For the M552 and M553 models, skip this step and go to [Step 25: Remove the left cover on page 2552](#).

1. Remove four screws (callout 1).

Figure 1-4564 Remove four screws

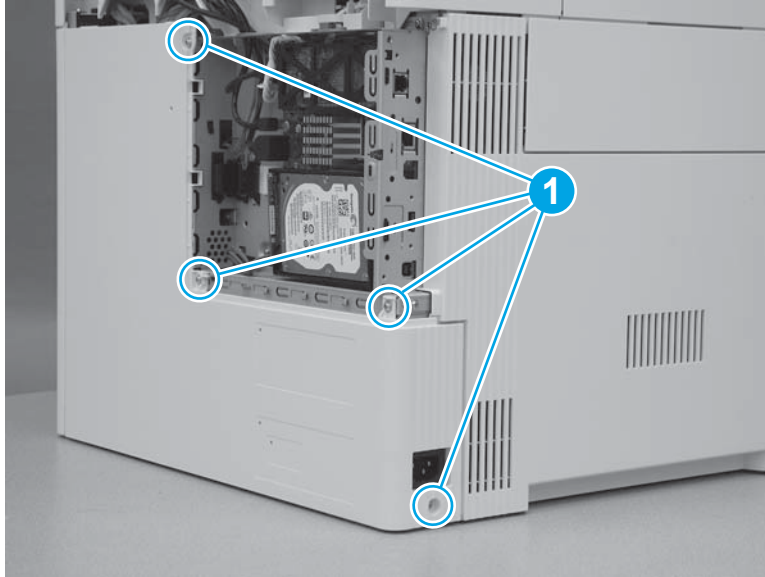

2. Slide the cover to the right to remove it.

Figure 1-4565 Remove the cover

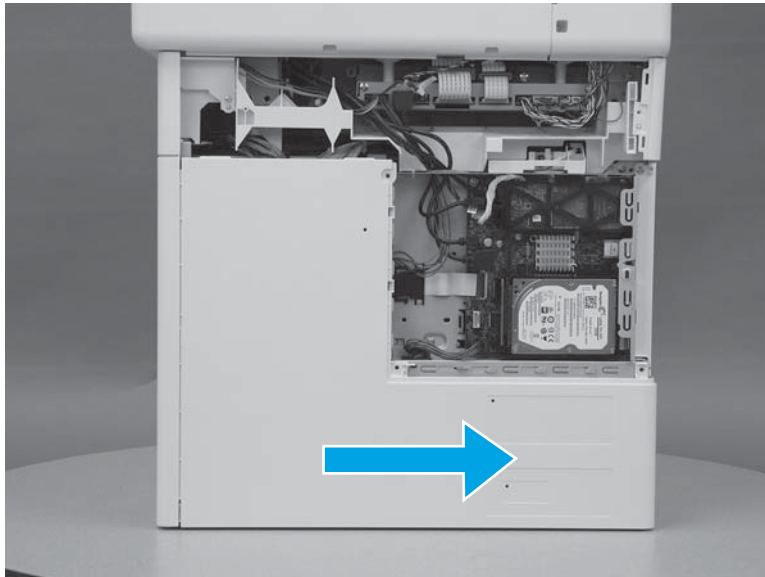

Step 15: Remove the left upper cover (M577)



NOTE: This step is for the M577 models. For the M552 and M553 models, skip this step and go to [Step 25: Remove the left cover on page 2552](#).

1. At the left side of the printer, release one tab (callout 1).

Figure 1-4566 Release one tab

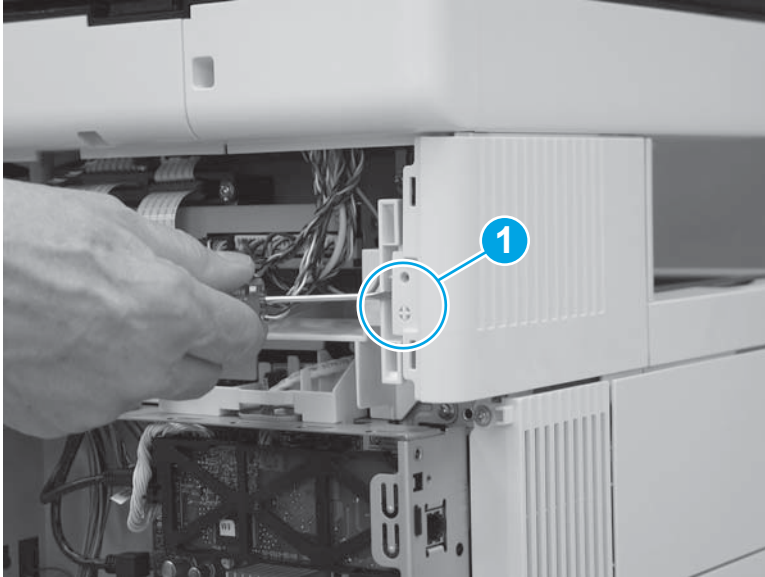

2. Slide the left upper cover toward the back of the printer.

Figure 1-4567 Slide the cover back

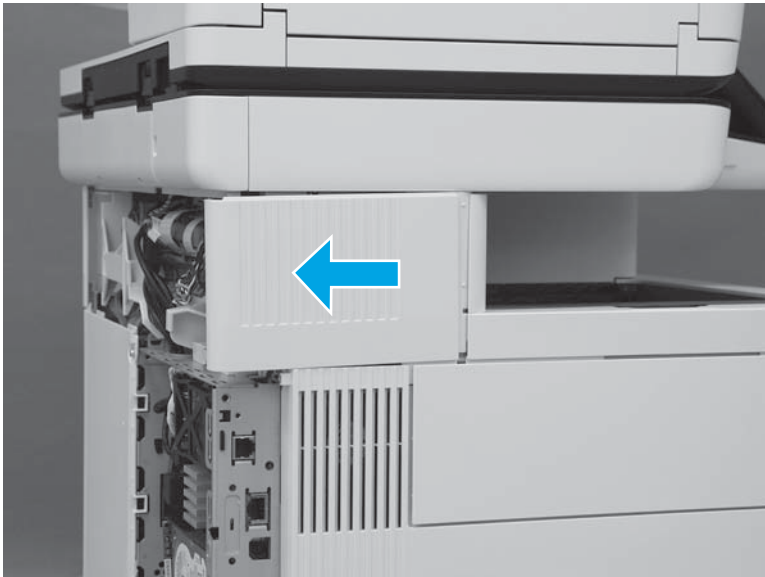

3. Rotate the cover up to remove it.

Figure 1-4568 Remove the left upper cover



Step 16: Remove the right front upper cover (M577dn)

 **NOTE:** This step is for the M577dn model. For the M577c/f/z models, skip this step and go to [Step 17: Remove the stapler cover assembly \(M577c/f/z\) on page 2538](#).

For the M552 and M553 models, skip this step and go to [Step 25: Remove the left cover on page 2552](#).

1. Remove one screw (callout 1).

Figure 1-4569 Remove one screw

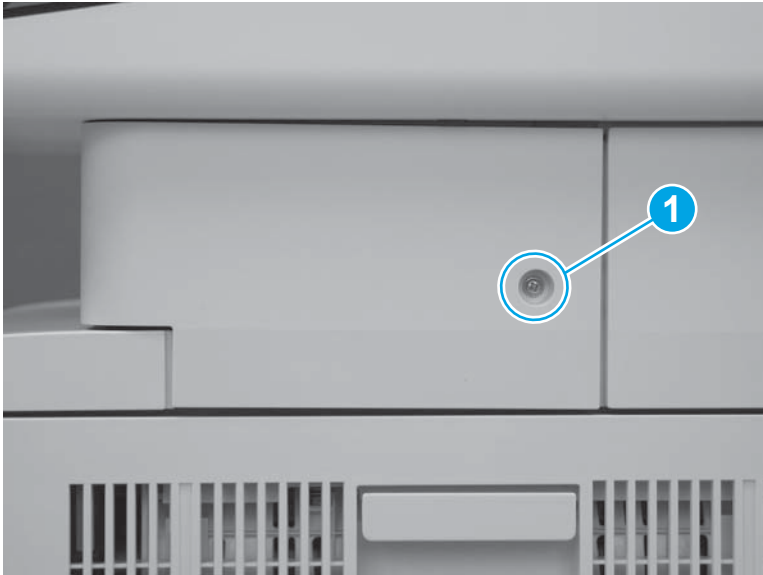

2. Release two tabs at the front edge of the cover (callout 1).

Figure 1-4570 Release two tabs



3. Rotate the front of the cover to the right to remove it.

Figure 1-4571 Rotate the cover



Step 17: Remove the stapler cover assembly (M577c/f/z)



NOTE: This step is for the M577c/f/z models. For the M577dn model, skip this step and go to [Step 20: Remove the right upper cover \(M577\) on page 2544](#).

For the M552 and M553 models, skip this step and go to [Step 25: Remove the left cover on page 2552](#).

1. Remove one screw (callout 1).

 **Reinstallation tip:** This is a self-tapping screw for plastic. When reinstalling, rotate the screw counterclockwise to align it with the existing thread pattern, and then carefully turn it clockwise to tighten. Do not overtighten. This will prevent stripping the threads inside the screw hole.

Figure 1-4572 Remove one screw



2. Release two tabs at the front edge of the cover (callout 1).

Figure 1-4573 Release two tabs

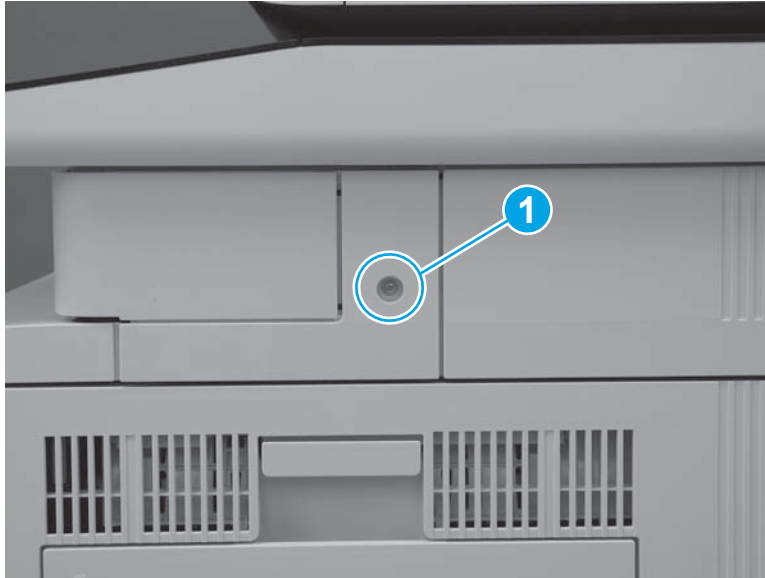

3. Release the back edge of the cover.

Figure 1-4574 Release the back edge of the cover

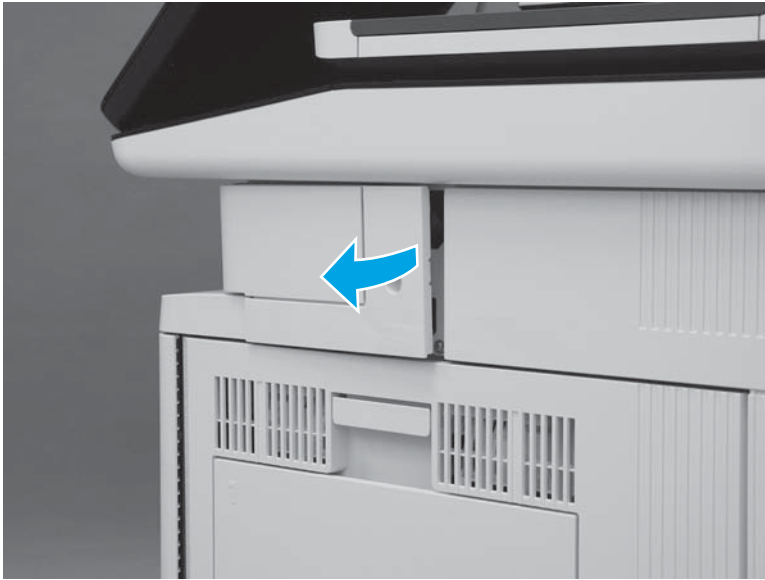



4. Rotate the cover away from the printer to remove it.

Figure 1-4575 Remove the cover



Step 18: Remove the integrated scanner assembly (ISA) (M577)

 **NOTE:** This step is for the M577 models. For the M552 and M553 models, skip this step and go to [Step 25: Remove the left cover on page 2552](#).

 **NOTE:** The ISA includes the document feeder, image scanner, scanner control board (SCB), control panel, keyboard (M577c/z) and NFC PCA (M577z).

1. At the left side of the printer, remove one screw (callout 1).

Figure 1-4576 Remove one screw

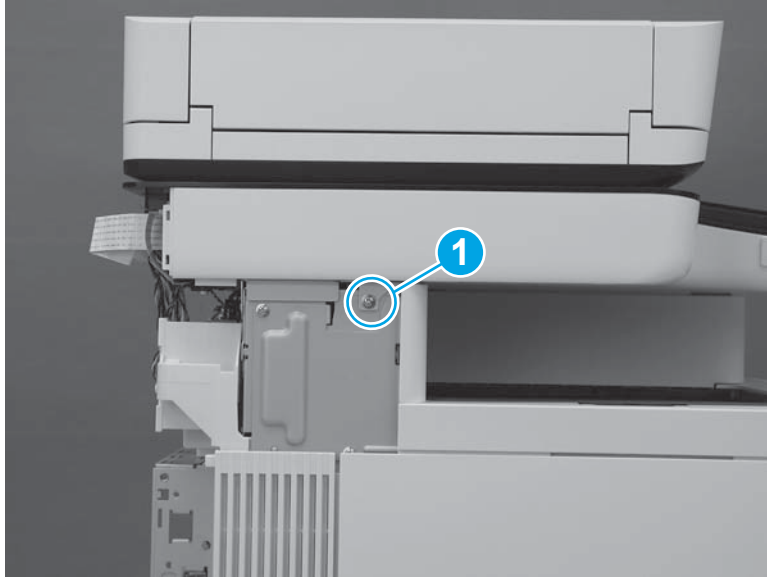

2. At the back side of the printer, remove two screws (callout 1).

Figure 1-4577 Remove two screws

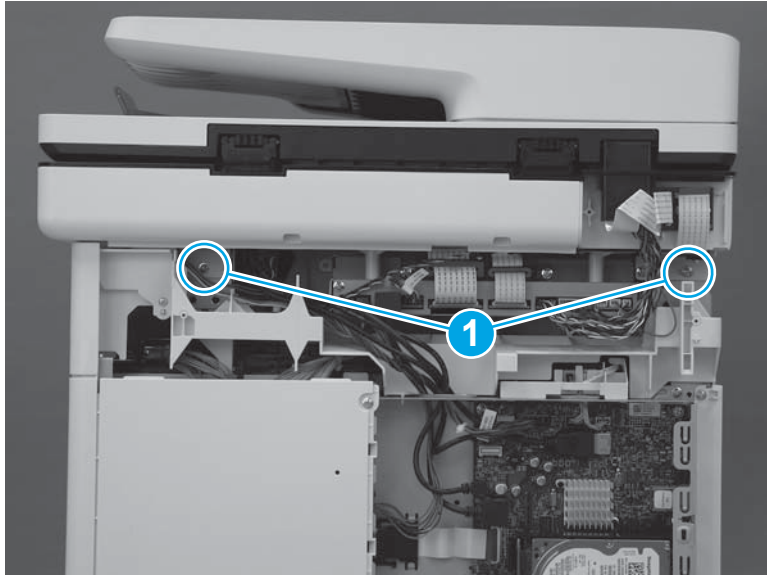

3. At the right side of the printer, remove one screw (callout 1).

Figure 1-4578 Remove one screw

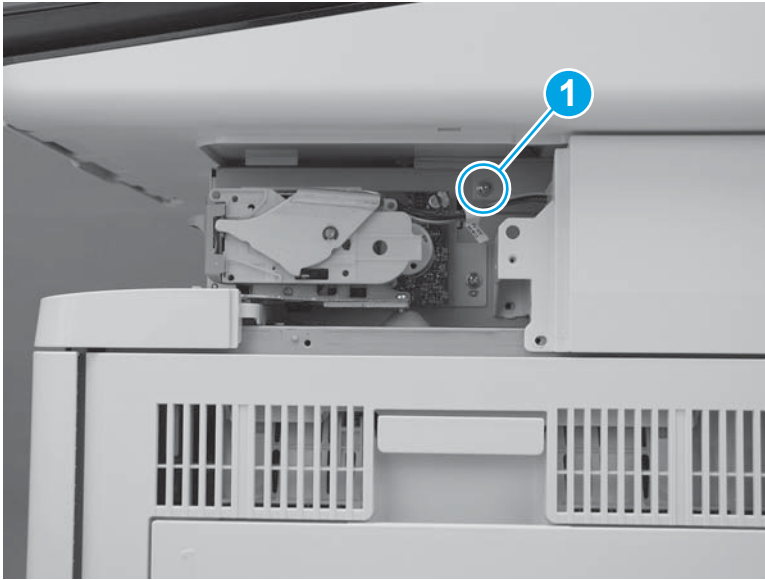

4. Disconnect two connectors on the scanner control board (callout 1).

M577c/f/z only: Disconnect one connector for the stapler on the scanner control board (callout 2).

Figure 1-4579 Disconnect connectors

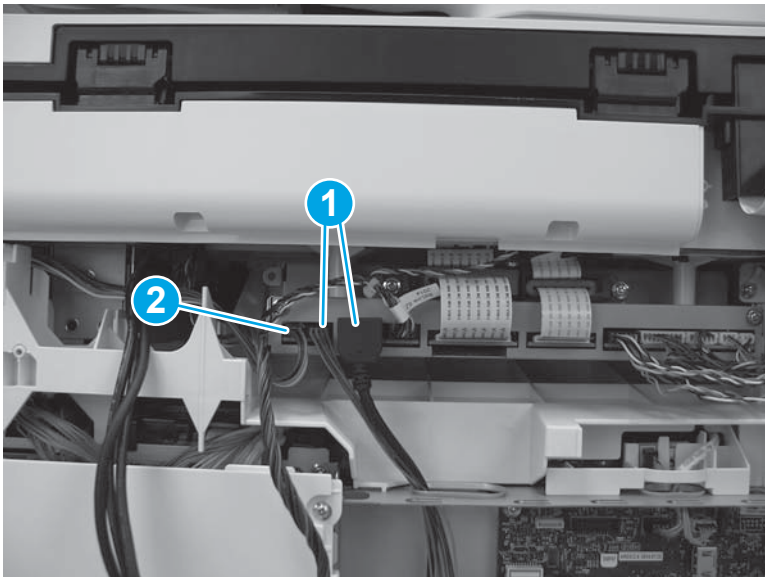

5. Slightly slide the ISA towards the back of the printer to release it.

Figure 1-4580 Slide the ISA towards the back of the printer

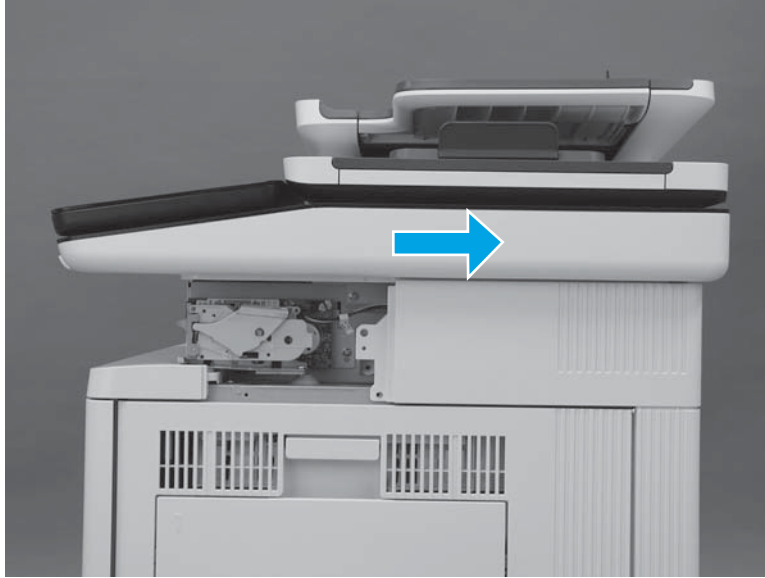

6. Lift the ISA up to remove it.



NOTE: When lifting the ISA, carefully pass the cables through the opening in the top of the formatter case.

Figure 1-4581 Remove the ISA

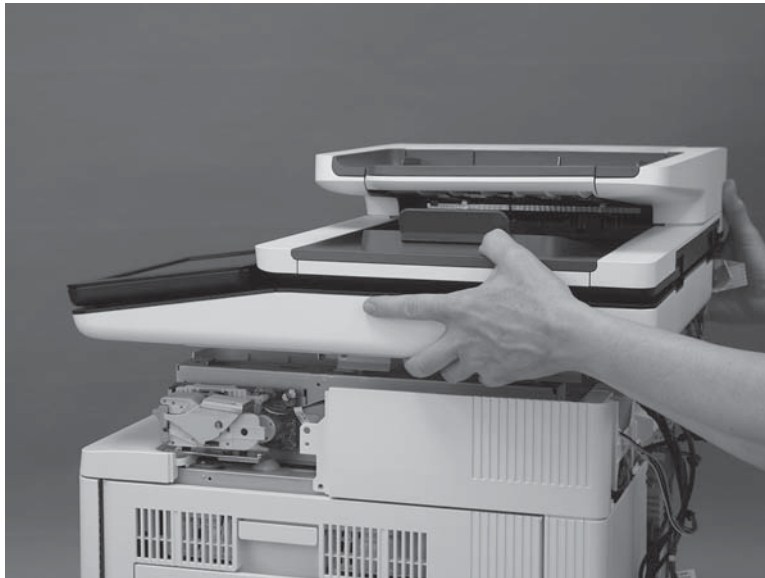

Step 19: Remove the stapler unit (M577c/f/z)



NOTE: This step is for the M577c/f/z models. For the M577dn model, skip this step and to go [Step 21: Remove the top rear cover \(M577\) on page 2546](#).

For the M552 and M553 models, skip this step and go to [Step 25: Remove the left cover on page 2552](#).

1. Disconnect one connector (callout 1), and then remove two screws (callout 2).

Figure 1-4582 Disconnect connector and remove screws

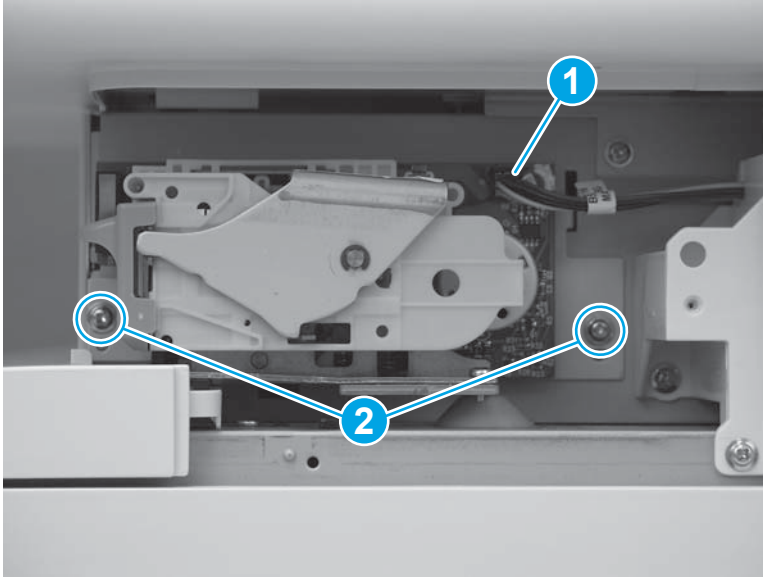

2. Slide the stapler unit up (callout 1), and then pull it away from the printer (callout 2) to remove it.

Figure 1-4583 Remove the stapler unit

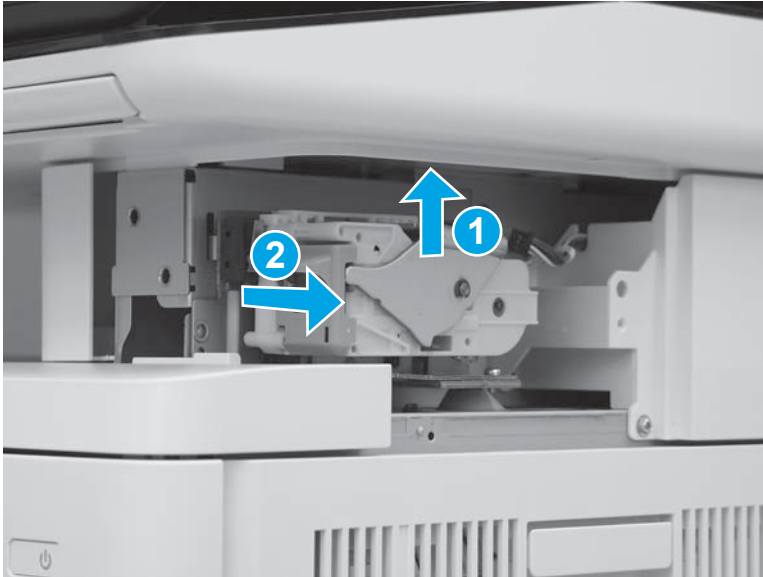

Step 20: Remove the right upper cover (M577)



NOTE: This step is for the M577 models. For the M552 and M553 models, skip this step and go to [Step 25: Remove the left cover on page 2552](#).



NOTE: The figures below show the image scanner installed. The procedures for removing and installing the right upper cover are the same whether the image scanner is installed or removed."

1. At the right side of the printer, remove two screws (callout 1).

M577c/f/z only: Disconnect one connector (callout 2), if it was not already disconnected in a previous step.

Figure 1-4584 Remove two screws and one connector

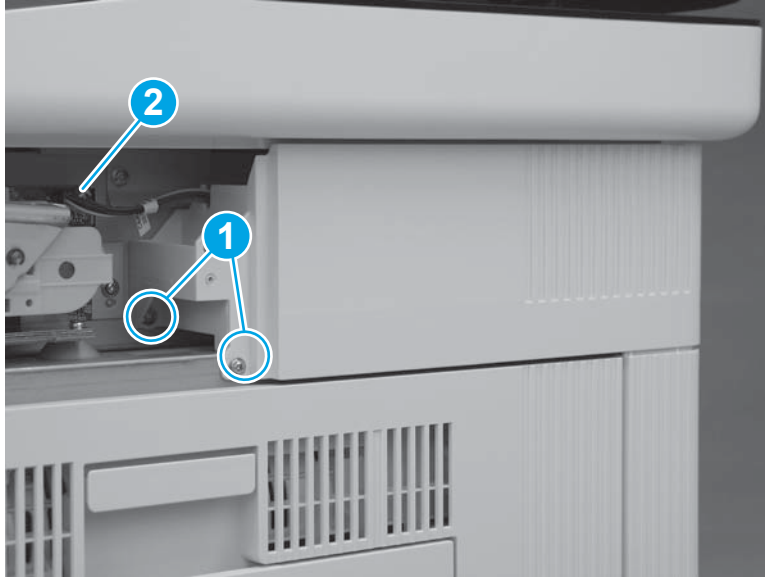

2. At the back of the printer, remove one screw (callout 1).

M577c/f/z only: Disconnect one connector (callout 2), if it was not already disconnected in a previous step.

 **Reinstallation tip:** This screw is smaller than the screws removed in the previous step. When reinstalling the right upper cover, make sure that this screw is installed in the correct position.

Figure 1-4585 Remove one screw and connector



3. Slide the cover toward the back of the printer.

Figure 1-4586 Slide the cover

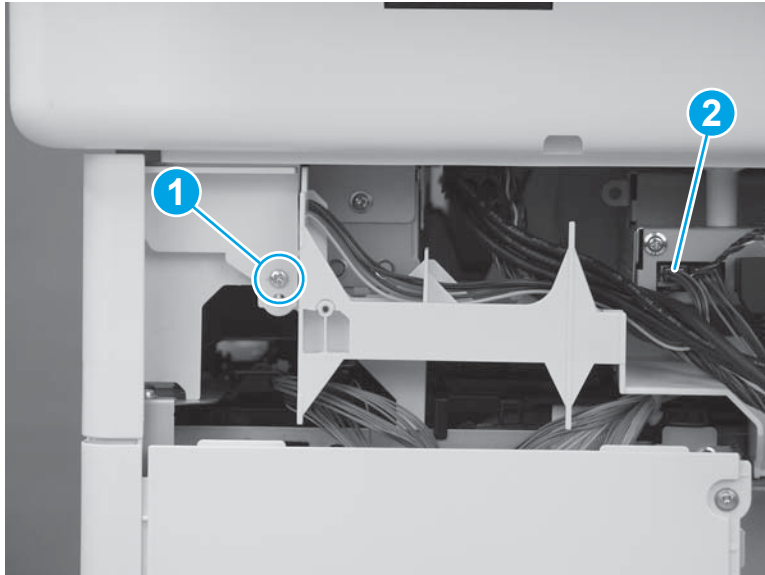
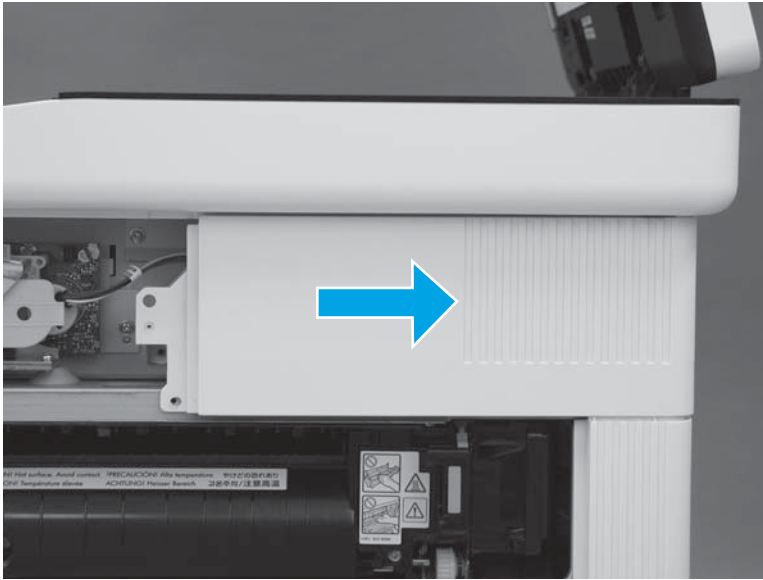

4. Lift the cover away from the printer to remove it.

M577c/f/z only: Release the cables (callout 1) through the slot (callout 2) in the printer.

Figure 1-4587 Remove the cover

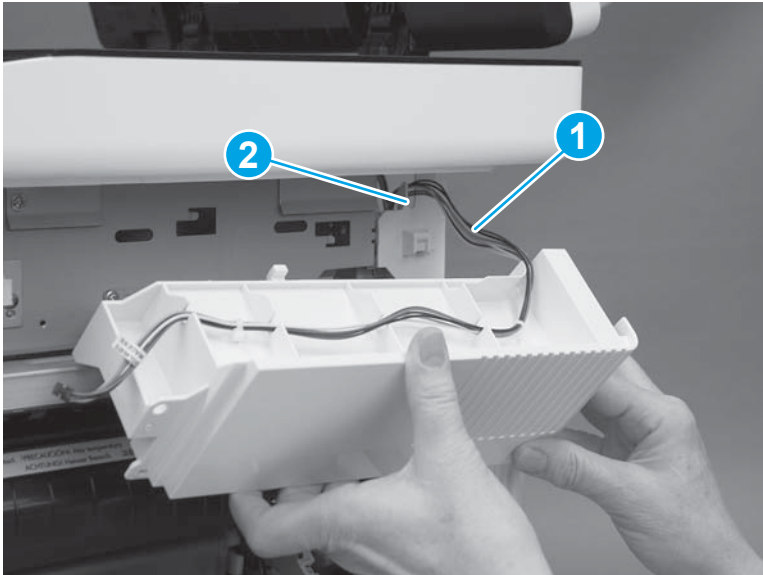

Step 21: Remove the top rear cover (M577)



NOTE: This step is for the M577 models. For the M552 and M553 models, skip this step and go to [Step 25: Remove the left cover on page 2552](#).

1. At the top of the printer, remove five screws (callout 1).

Figure 1-4588 Remove five screws

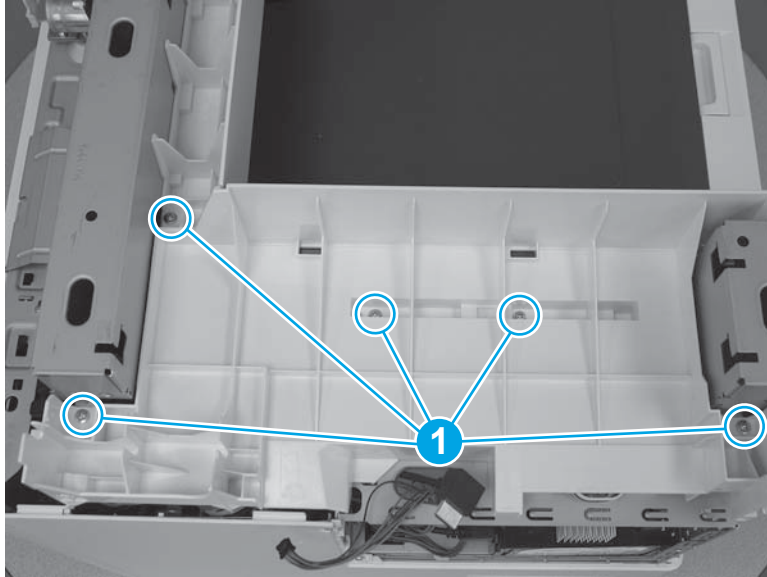

2. Release two tabs (callout 1) on the front edge of the cover.

Figure 1-4589 Release two tabs

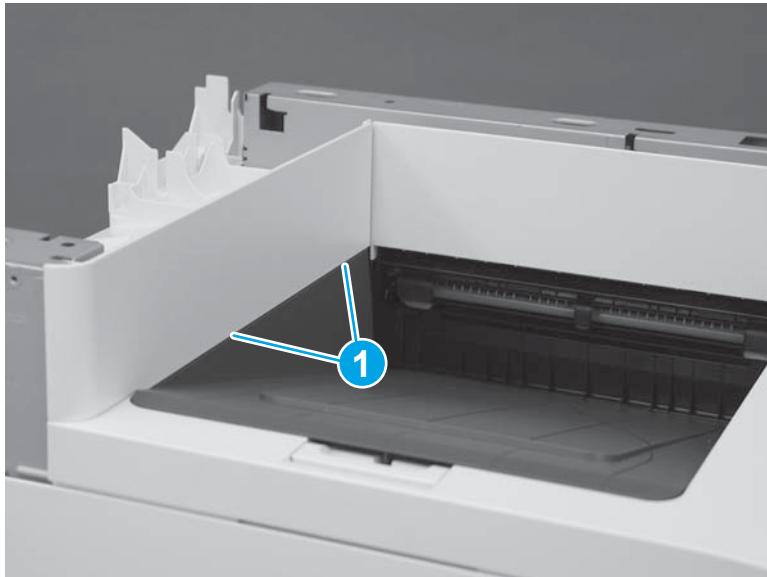

3. Remove the top rear cover.

Figure 1-4590 Remove the top rear cover

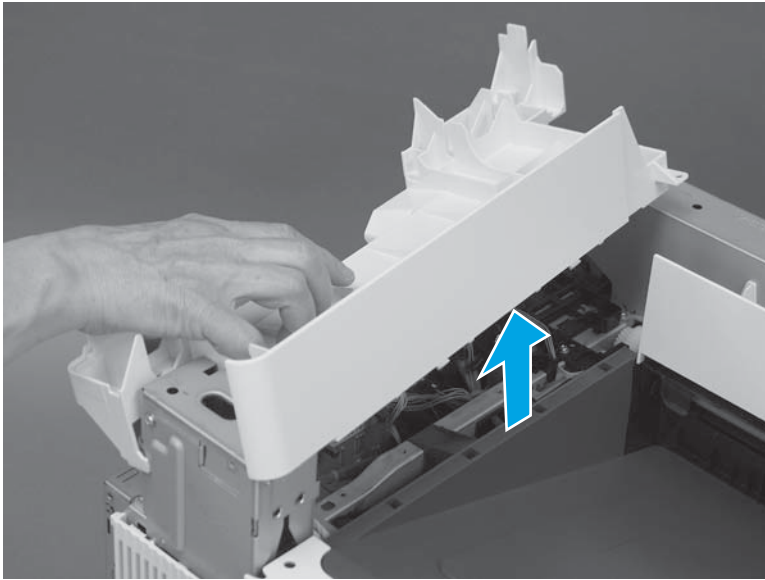

Step 22: Remove the paper feed cover (M577)



NOTE: This step is for the M577 models. For the M552 and M553 models, skip this step and go to [Step 25: Remove the left cover on page 2552](#).

1. Remove one screw (callout 1).

Figure 1-4591 Remove one screw

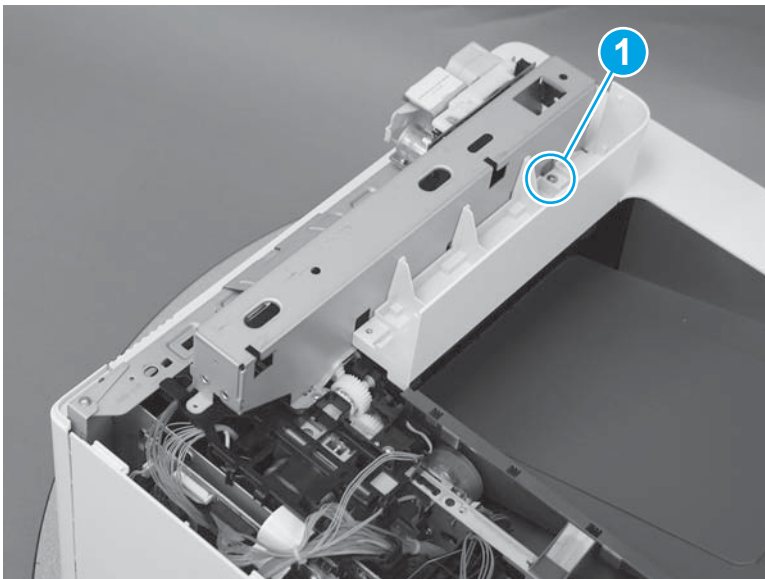

2. Lift the cover up to remove it.

Figure 1-4592 Remove the cover

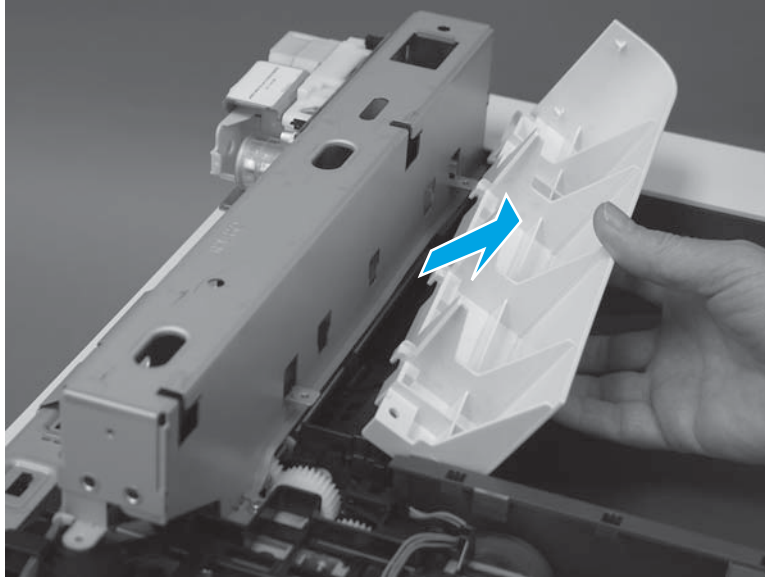

Step 23: Remove the top cover (M577)

 **NOTE:** This step is for the M577 models. For the M552 and M553 models, skip this step and go to [Step 25: Remove the left cover on page 2552](#).

1. At the front of the printer, remove one screw (callout 1).

 **Reinstallation tip:** This screw is longer and a different type of screw than the screw removed in the next step. When reinstalling the top cover, make sure that this screw is installed in the correct position.

Figure 1-4593 Remove one screw



2. At the left side of the printer, remove one screw (callout 1).

Figure 1-4594 Remove one screw

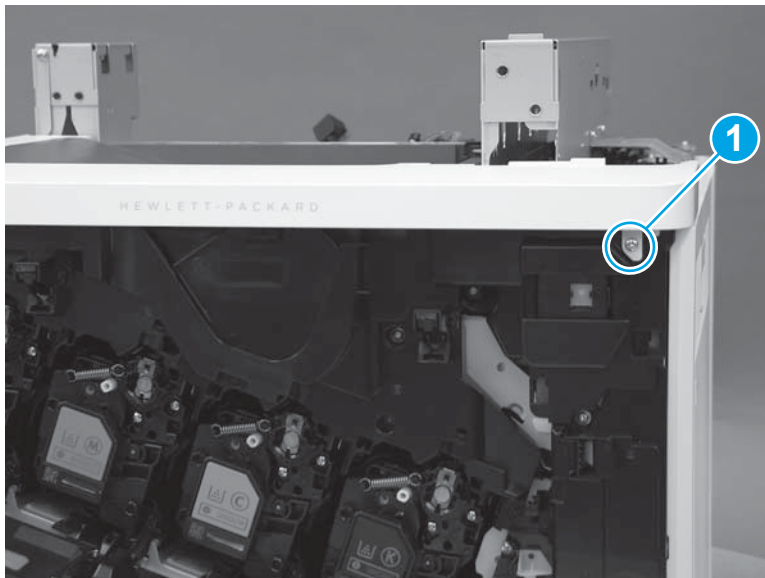
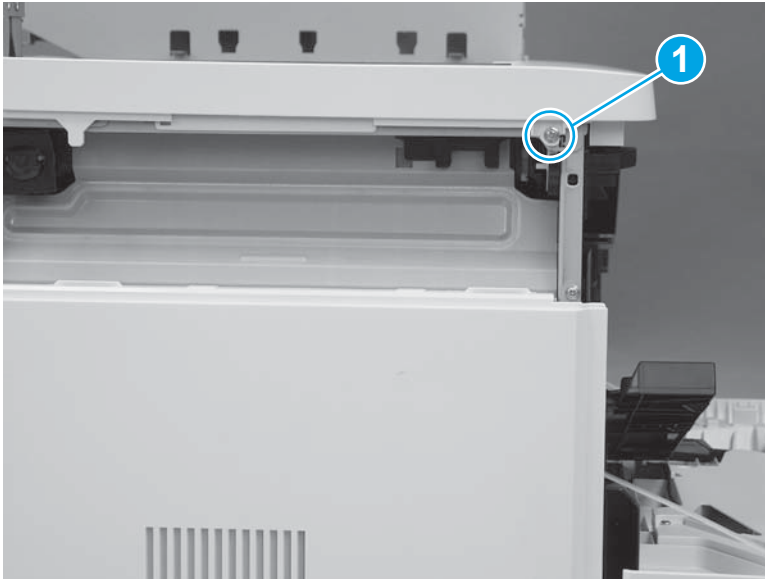

3. At the front of the printer, release one tab (callout 1).

Figure 1-4595 Release one tab

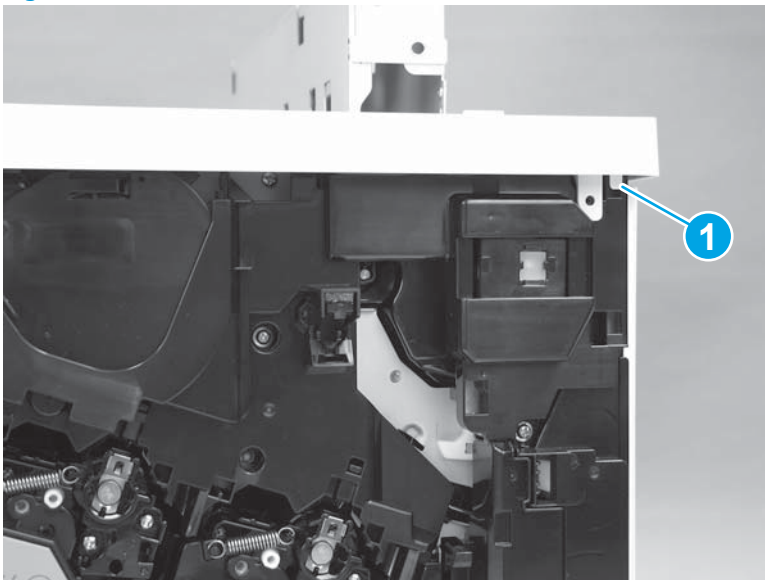

4. At the top of the printer, release two tabs (callout 1) next to the output bin, and then remove the top cover.

Figure 1-4596 Release two tabs

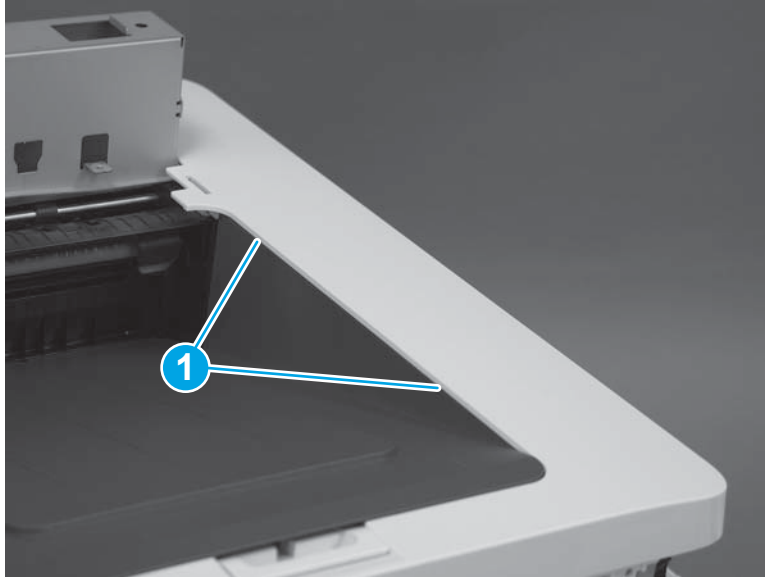

Step 24: Remove the top bracket (M577)

 **NOTE:** This step is for the M577 models. For the M552 and M553 models, skip this step and go to [Step 25: Remove the left cover on page 2552](#).

1. At the top of the printer, remove three screws (callout 1).

Figure 1-4597 Remove three screws

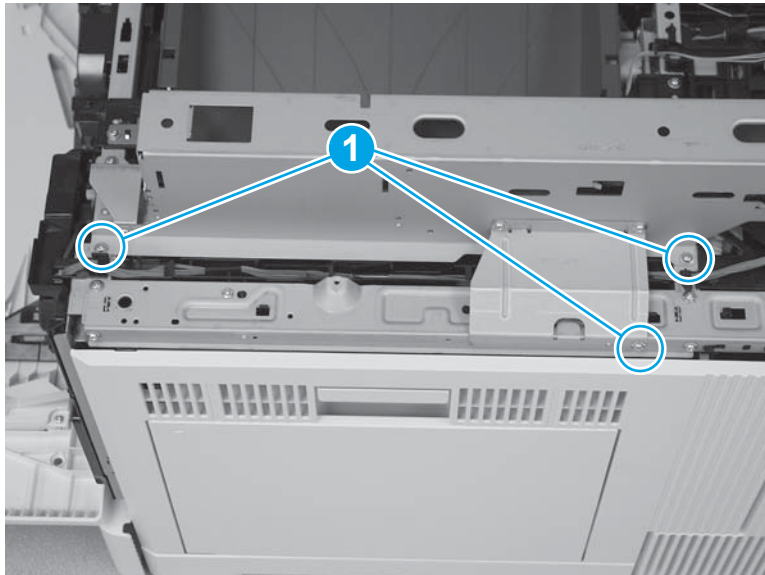

2. At the top of the printer, remove two screws (callout 1).

Figure 1-4598 Remove two screws

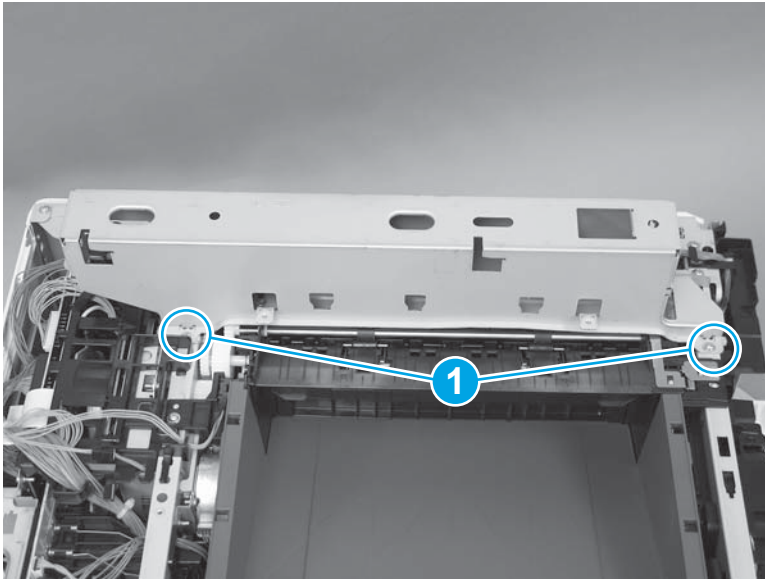

3. Lift the top bracket up to remove it.

Figure 1-4599 Remove the bracket

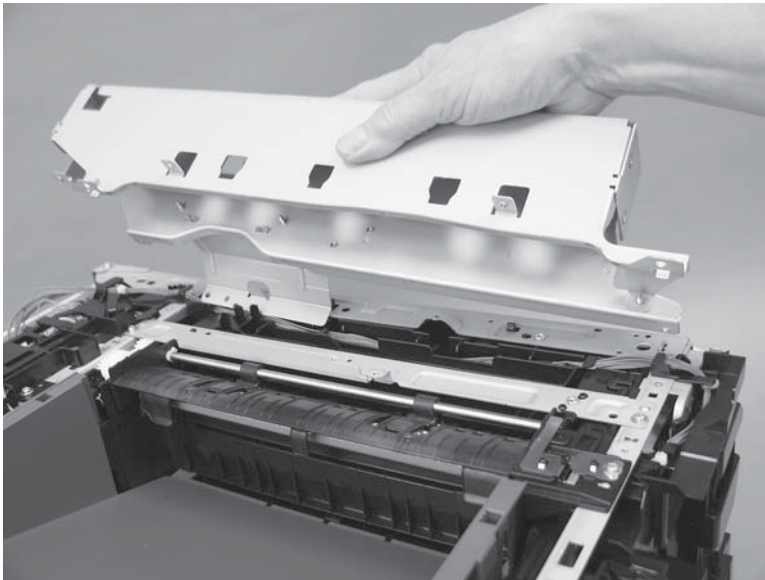

Step 25: Remove the left cover

1. At the left side of the printer, remove one screw (callout 1).

Figure 1-4600 Remove one screw



2. Release one tab (callout 1), rotate the front edge of the cover away from the printer (callout 2), and then slide the cover (callout 3) toward the rear of the printer to release it.

Figure 1-4601 Release the cover

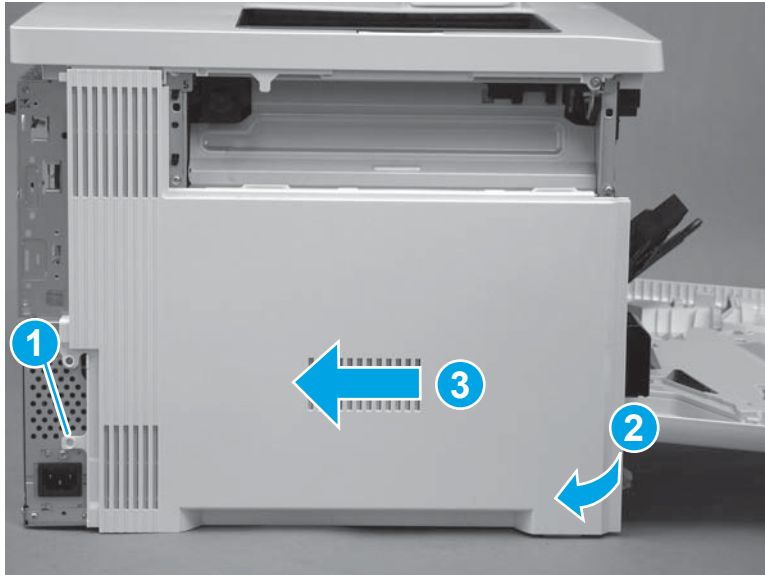

3. Remove the cover.

Figure 1-4602 Remove the cover

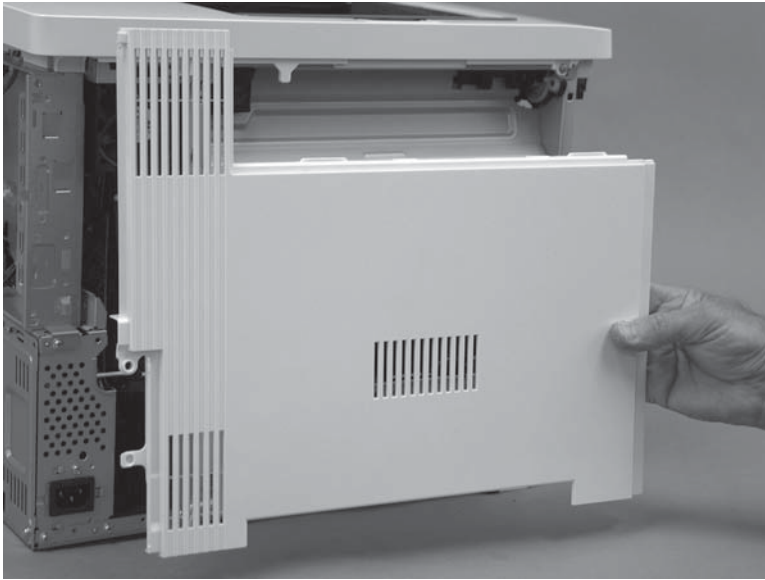

Step 26: Remove the upper cover (M552 and M553)



NOTE: This step is for the M552 and M553 models. For the M577 models, skip this step and go to [Step 27: Remove the formatter case on page 2556](#).

1. Remove three screws (callout 1).

Figure 1-4603 Remove three screws

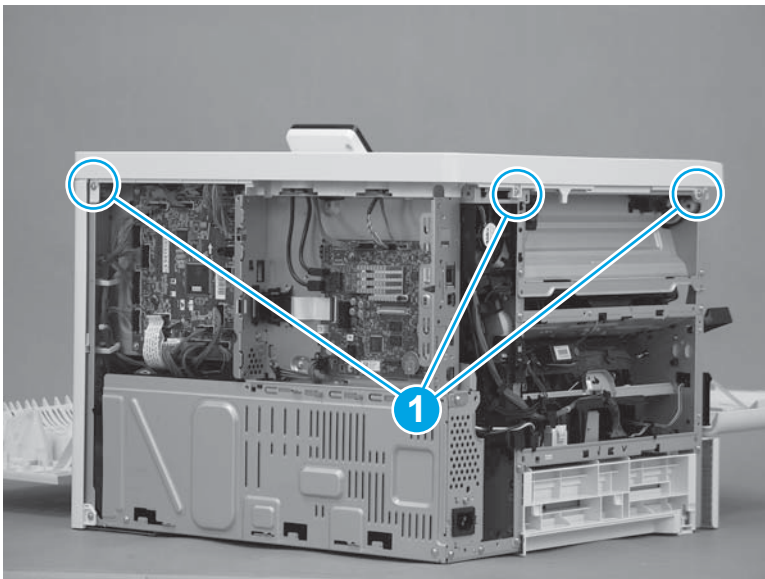

2. Remove one screw (callout 1), release one tab (callout 2), and then slightly separate the corner of the cover from the chassis.

 **NOTE:** This is a self-tapping plastic-thread screw. Make sure that this screw is used in this location when it is reinstalled.

Figure 1-4604 Remove one screw and release one tab



3. Release one tab (callout 1), and then lift up on the cover to release it.

 **NOTE:** If the cover does not release, check for additional tabs by locating the triangles embossed in the cover at tab locations.

Figure 1-4605 Release the cover



4. Remove the cover.

Figure 1-4606 Remove the cover

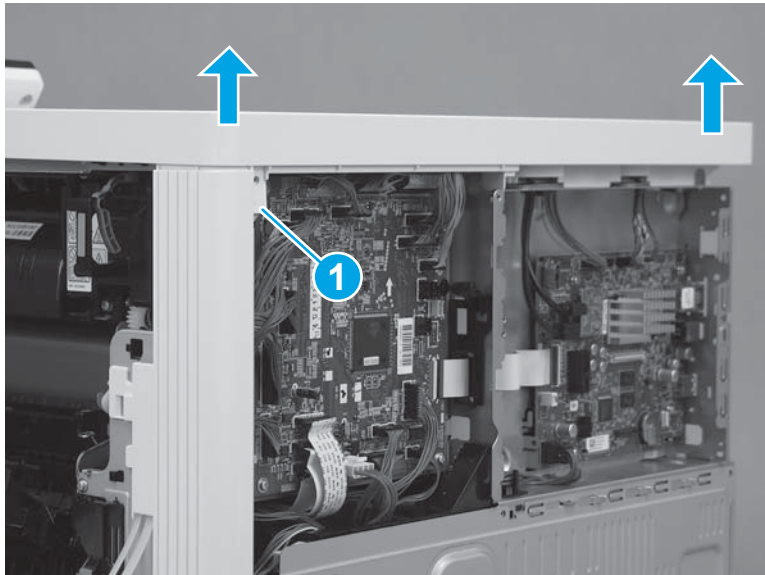
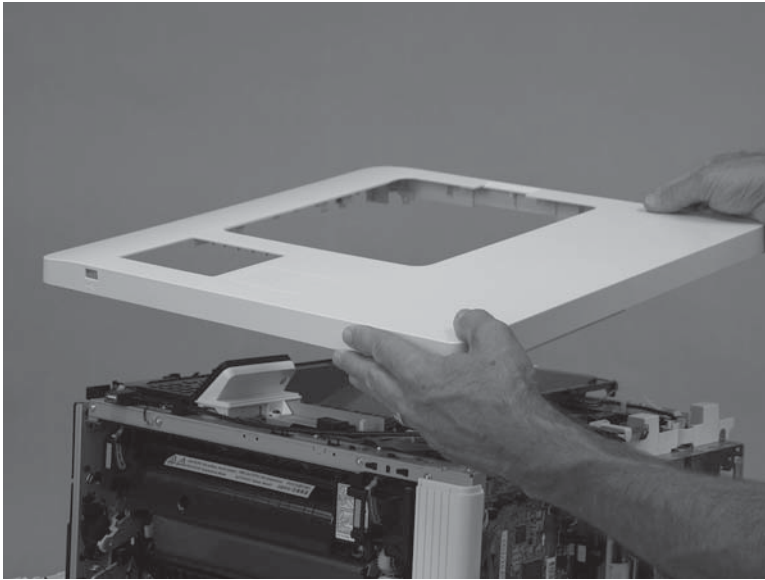

Step 27: Remove the formatter case

1. **M577 only:** Disconnect one connector (callout 1), and then pass the wire harness (callout 2) through two openings in the formatter case (callout 3).

Figure 1-4607 Disconnect one connector

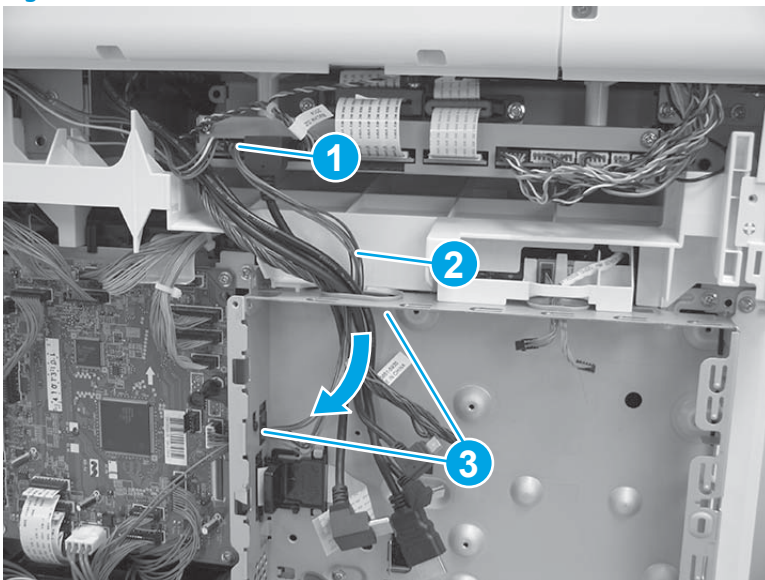

2. Release two tabs (callout 1) on the black plastic bracket. Hold the tabs in the released position, and then slide the bracket (callout 2) to the right to remove it from the formatter case.

Figure 1-4608 Remove the bracket

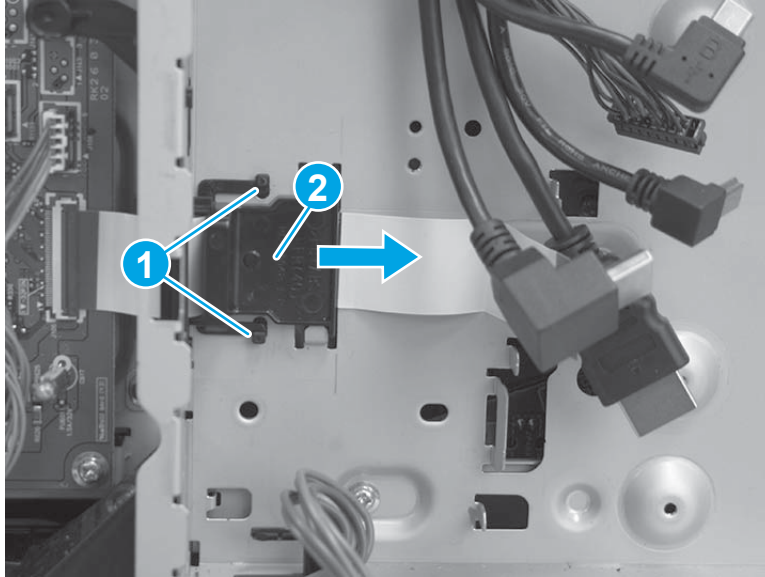

3. Remove two screws (callout 1), and then slide the low-voltage power supply (LVPS) cover to the right to remove it.

Figure 1-4609 Remove the LVPS cover

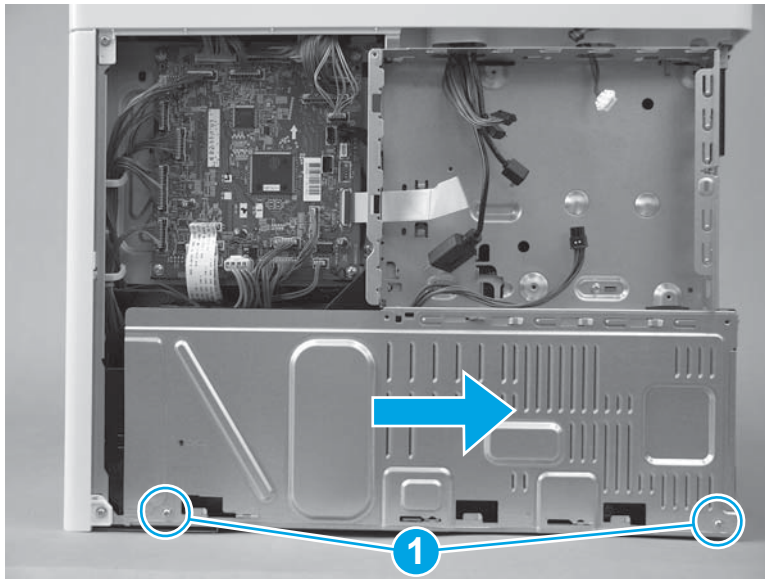

4. Pass two wire harnesses and one flat cable (callout 1) through the opening in the formatter case, and then release one wire harness from the retainer (callout 2).

⚠ CAUTION: The flat cable might be attached to the formatter case with double-sided tape. Make sure that this tape is released, so that the flat cable is not damaged when the formatter case is removed.

Figure 1-4610 Release wire harnesses and flat cable

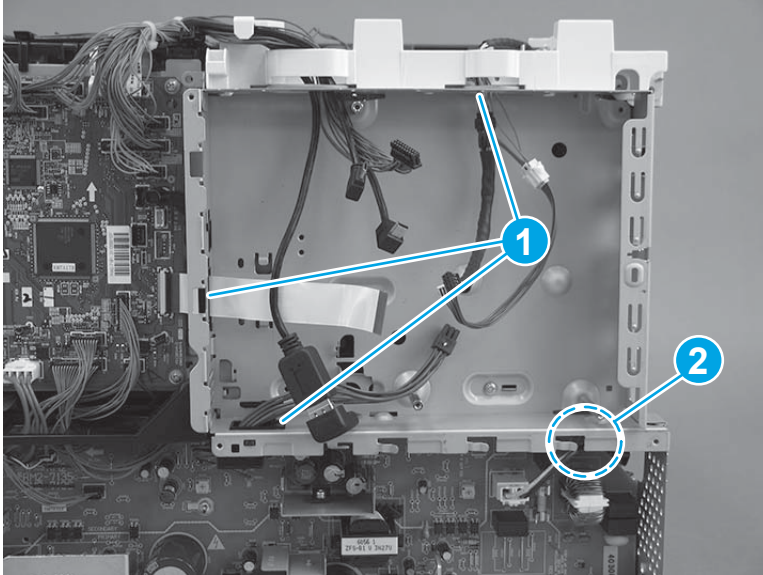

5. Remove six screws (callout 1).

Figure 1-4611 Remove six screws

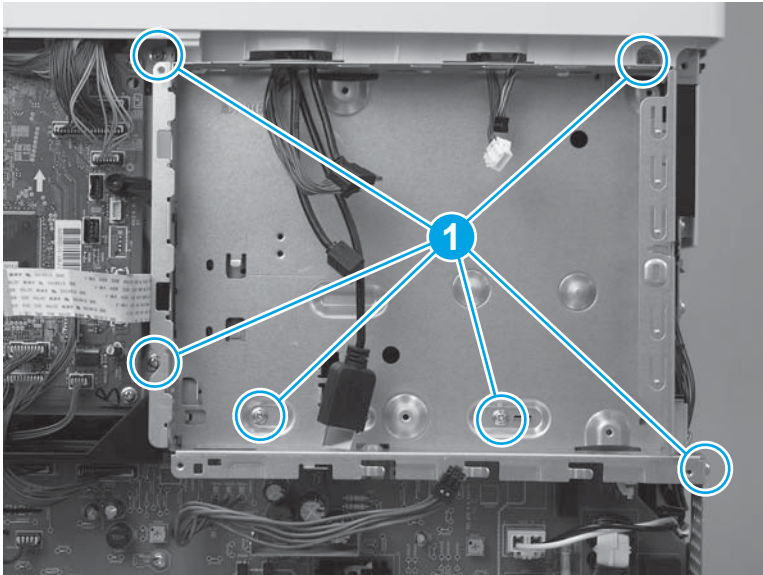

6. Rotate the bottom of the formatter case away from the printer (callout 1), and then pull it down (callout 2) to release it.

Figure 1-4612 Release the formatter case

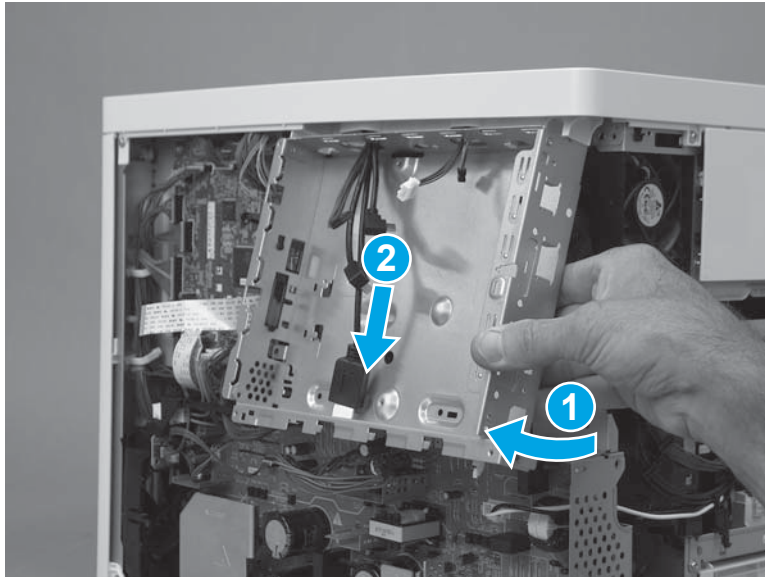

7. Pass the wire harnesses through the opening in the formatter case to remove it.

 **IMPORTANT:** If the formatter case is removed so that it can be replaced, make sure to transfer the memory PCA (island of data) and plastic bracket (callout 1) to the replacement case.

Figure 1-4613 Remove the formatter case



Step 28: Remove the right rear cover

1. Remove one screw (callout 1), and then slide the cover toward the rear of the printer (callout 2) to release it.

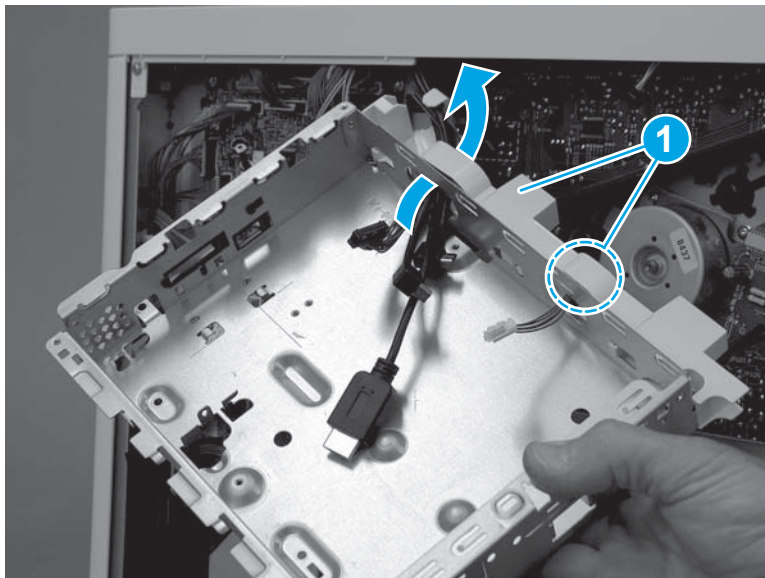
 **TIP:** If the right door is closed, open it now.

Figure 1-4614 Release the cover

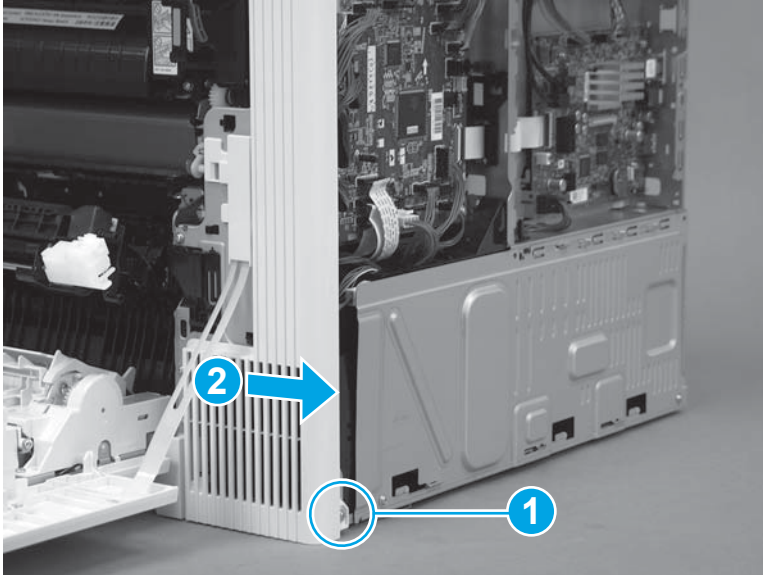

2. Remove the cover.

Figure 1-4615 Remove the cover

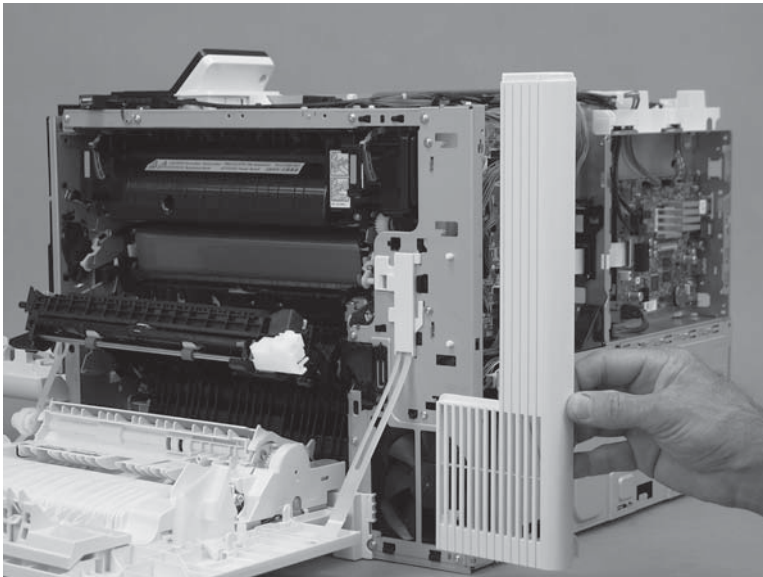

Step 29: Remove the low-voltage power supply (LVPS)

 **IMPORTANT:** Some figures might show assemblies removed or installed that have not yet been removed or installed at that specific step. However, the procedures are correct for this printer and the target assembly. Always thoroughly read the instructions that accompany each figure.

 **CAUTION:**  ESD-sensitive part.

1. Disconnect one wire harness (callout 1), and then pass the wire harness through the opening (callout 2) in the chassis.

Figure 1-4616 Disconnect one wire harness

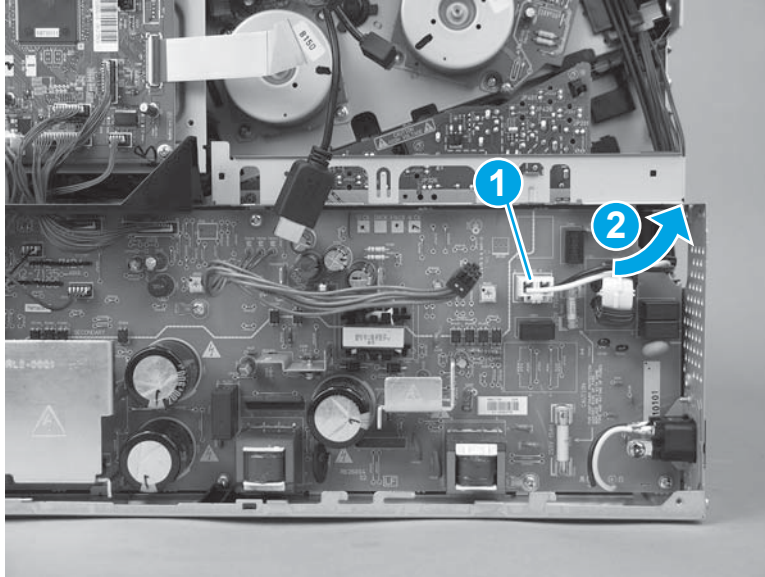

2. Disconnect three connectors on the DC controller (callout 1), and then disconnect four connectors (callout 2) on the LVPS.

Figure 1-4617 Disconnect seven connectors

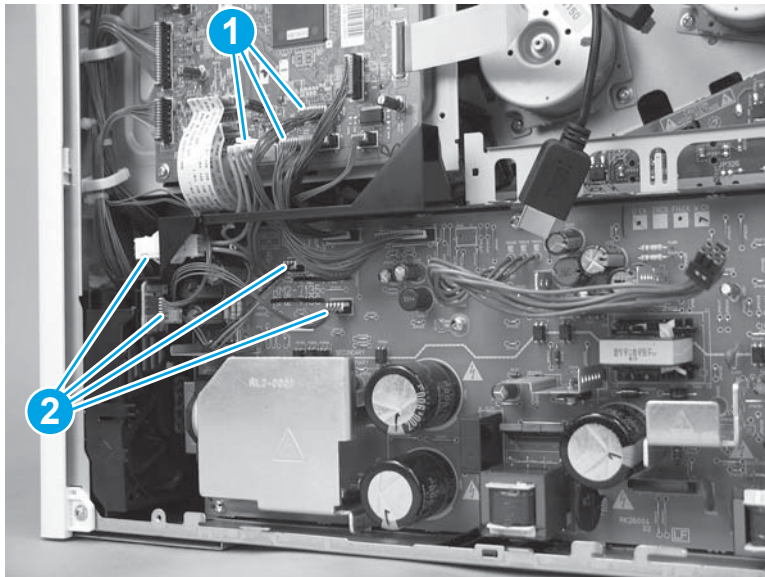

3. Pass the wire harnesses from the DC controller to the LVPS through the opening in the chassis (callout 1), and then release the wire harnesses from the retainer (callout 2).

Figure 1-4618 Pass the wire harnesses through the opening

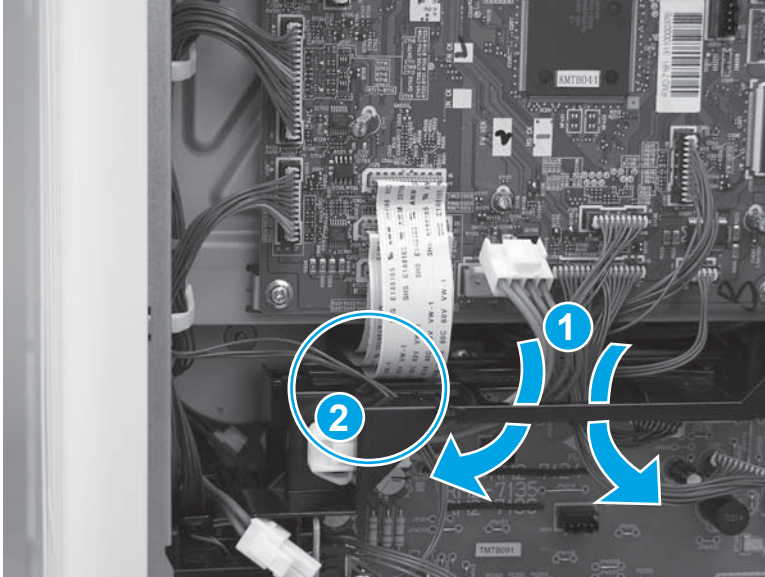

4. Remove three screws (callout 1).

Figure 1-4619 Remove three screws

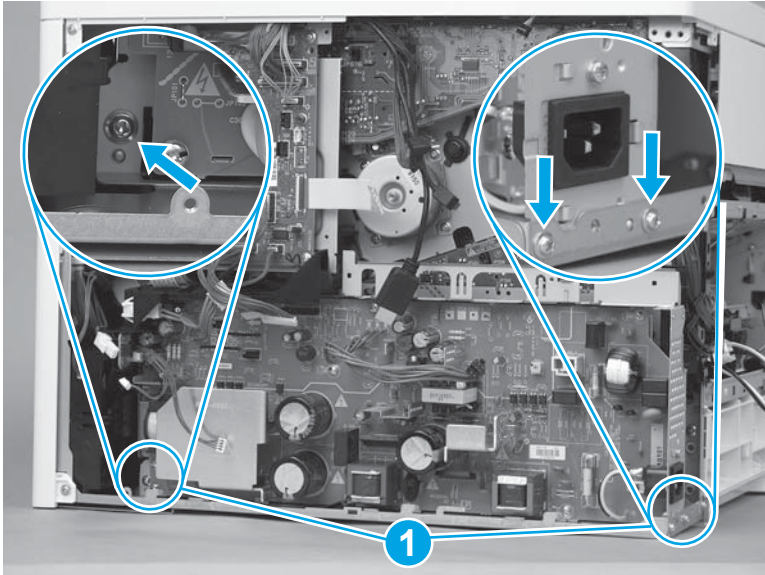

5. Rotate the top of the LVPS away from the printer (callout 1), and then slide it up and out (callout 2) of the printer to remove it.

Figure 1-4620 Remove the LVPS

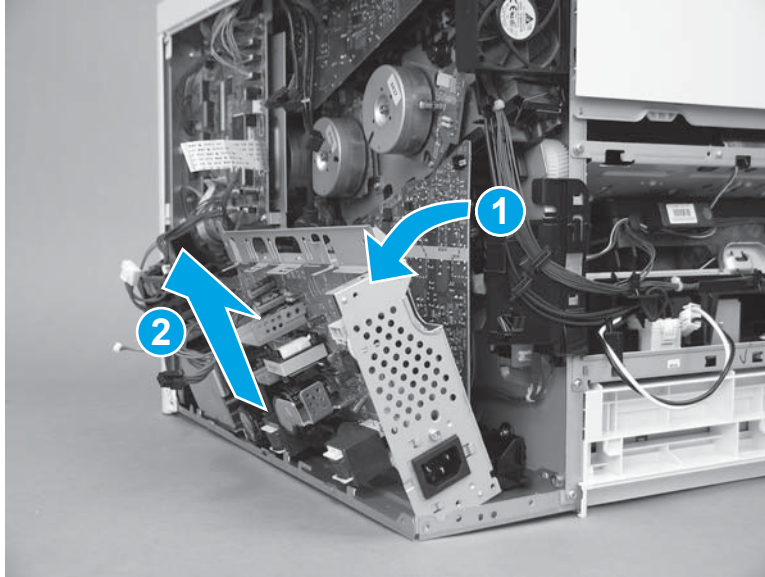

Step 30: Remove the power supply fan (FM1)

 **IMPORTANT:** Some figures might show assemblies removed or installed that have not yet been removed or installed at that specific step. However, the procedures are correct for this printer and the target assembly. Always thoroughly read the instructions that accompany each figure.

1. Remove one screw (callout 1).

Figure 1-4621 Remove one screw

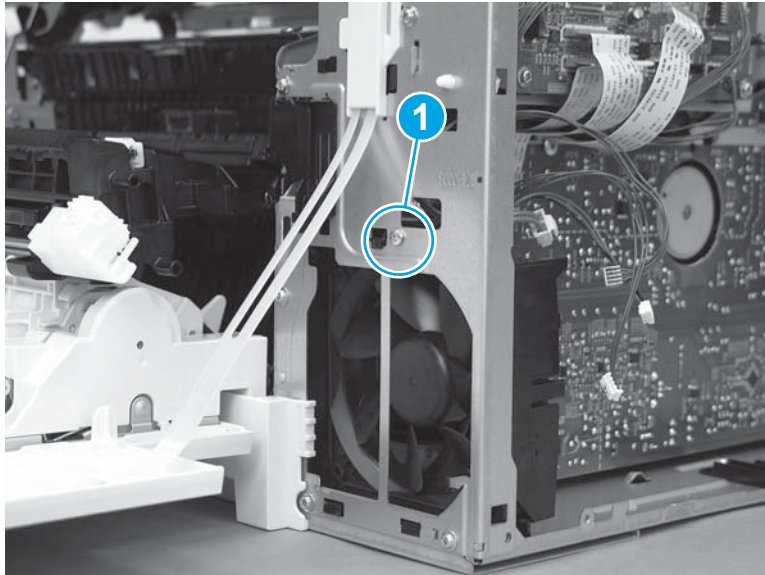

2. Release the wire harnesses from the retainer on the top of the fan bracket.

Figure 1-4622 Release the wire harnesses

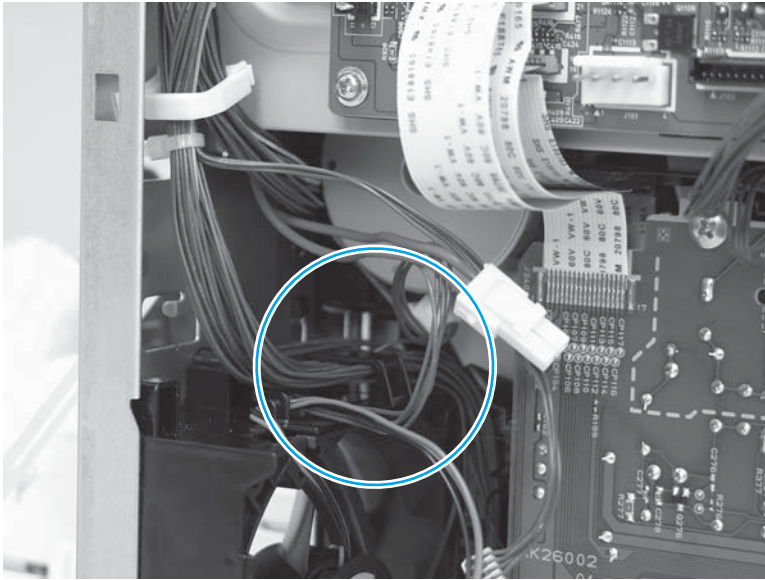

3. Lift the fan up (callout 1), and then slide it out of the printer (callout 2) to remove it.

Figure 1-4623 Remove the fan

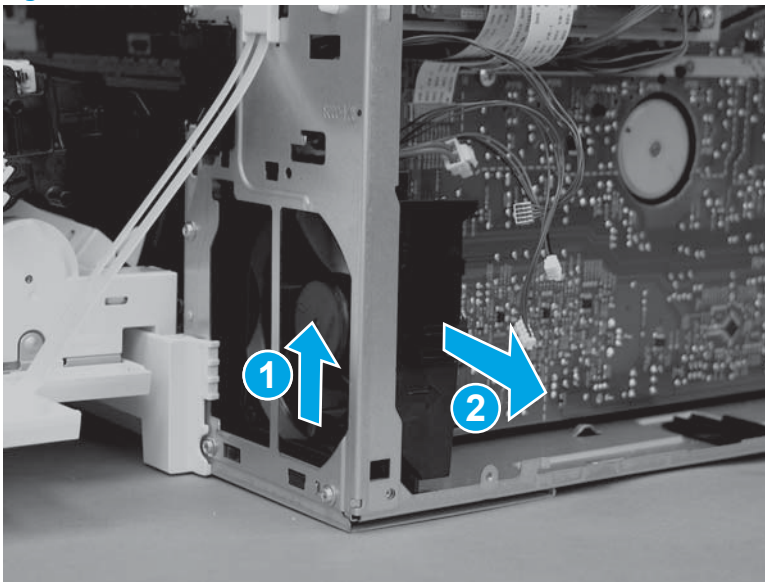

Step 31: Remove the high-voltage power supply D (HVPSD)

 **IMPORTANT:** Some figures might show assemblies removed or installed that have not yet been removed or installed at that specific step. However, the procedures are correct for this printer and the target assembly. Always thoroughly read the instructions that accompany each figure.

 **CAUTION:**  ESD-sensitive part.

1. Disconnect one flat cable (callout 1) on the DC controller.

Figure 1-4624 Disconnect one flat cable

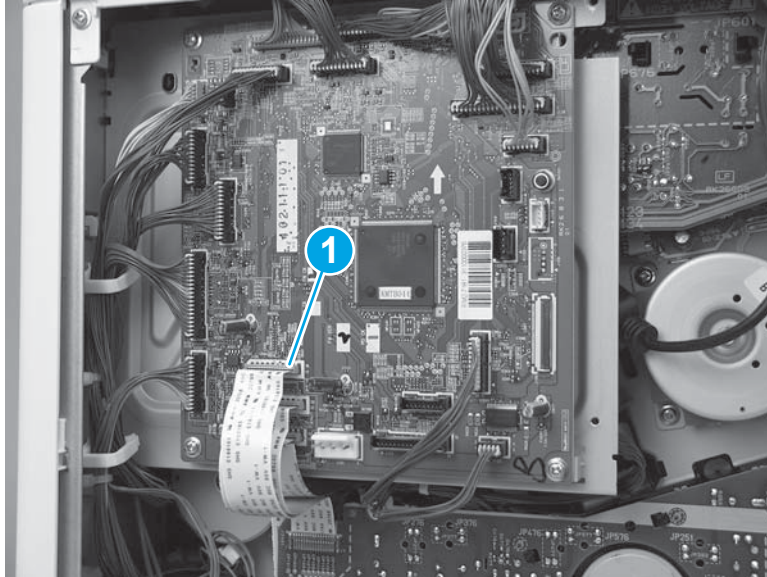

2. Remove two screws (callout 1), and then remove one self tapping screw (callout 2) on the HVPSD.

Figure 1-4625 Remove three screws

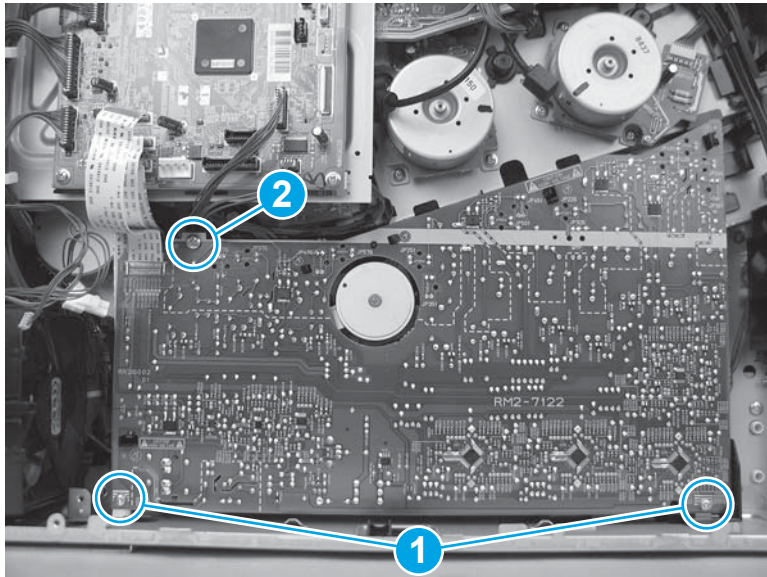

3. Release five tabs (callout 1), and then remove the HVPSD (callout 2).

Figure 1-4626 Remove the HVPSD

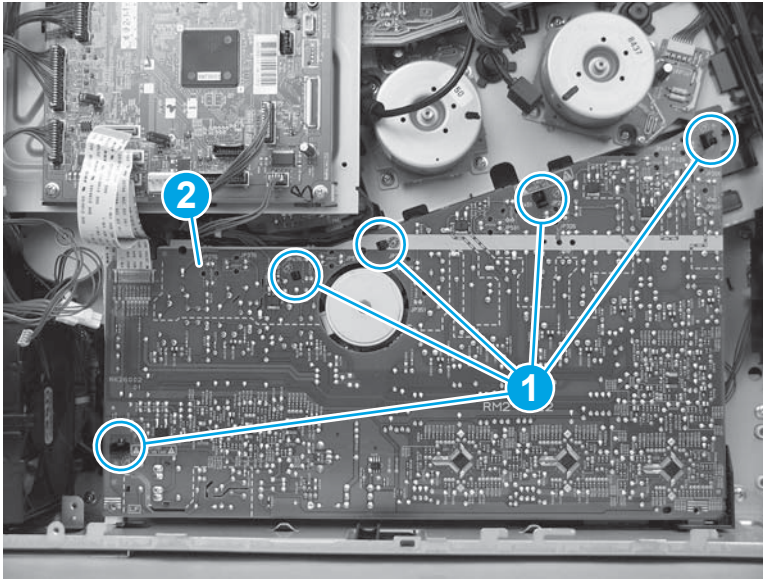

Step 32: Remove the lifter drive assembly

 **IMPORTANT:** Some figures might show assemblies removed or installed that have not yet been removed or installed at that specific step. However, the procedures are correct for this printer and the target assembly. Always thoroughly read the instructions that accompany each figure.

1. Disconnect two connectors (callout 1).

Figure 1-4627 Disconnect two connectors

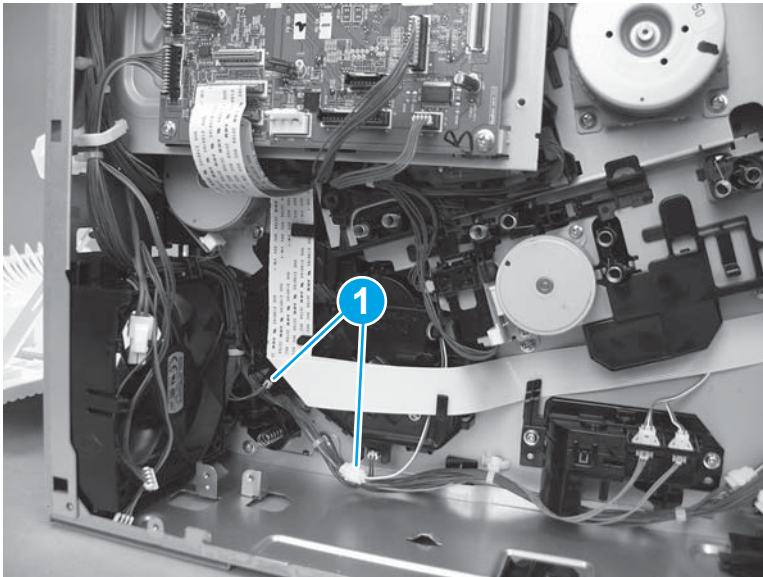

2. Disconnect two flat cables (callout 1), and then release them from the retainers (callout 2).

Figure 1-4628 Disconnect two flat cables

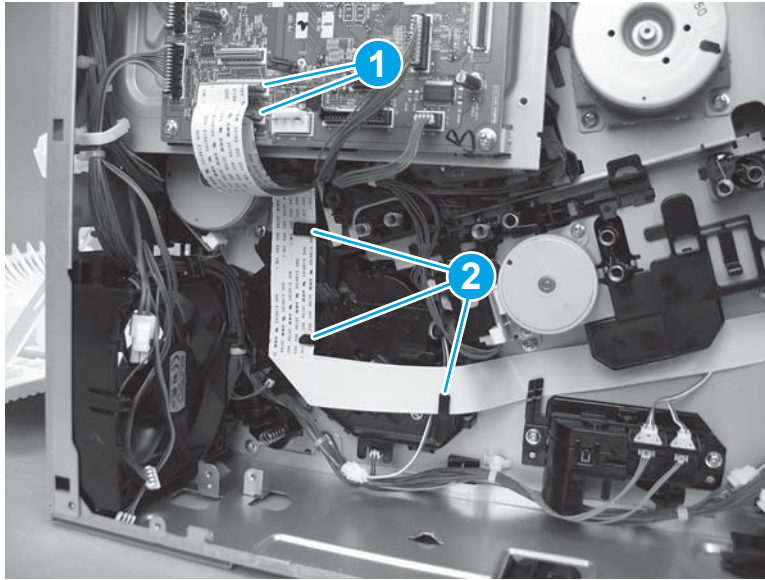

3. Remove two screws (callout 1), release one tab (callout 2), and then remove the lifter drive assembly (callout 3).

 **NOTE:** Release one wire harness from the retainer (callout 4) as the assembly is removed.

Figure 1-4629 Remove the assembly



Step 33: Remove the DC controller and sheet-metal bracket

 **CAUTION:**  ESD sensitive part.

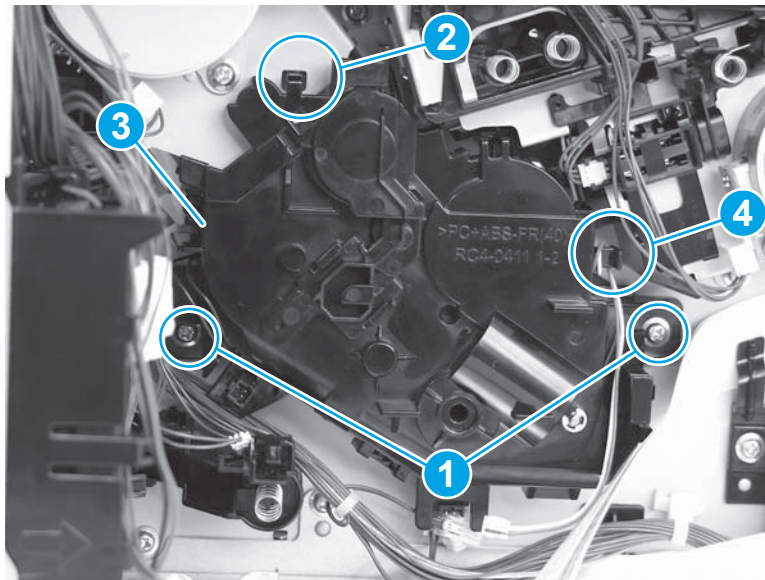
1. Disconnect all of the connectors, and then remove two screws (callout 1).

The following connectors are empty:

- J140, J141, and J143

Figure 1-4630 Remove two screws

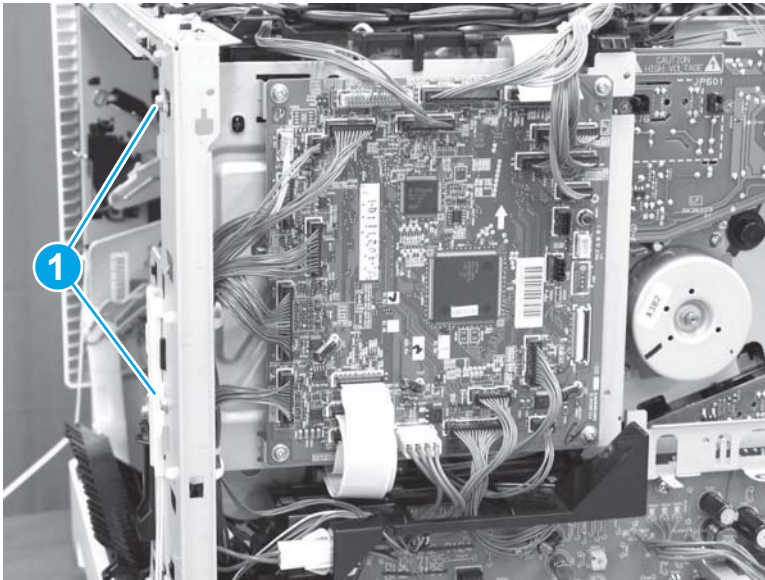

2. Lift up on the DC controller and sheet-metal plate to remove it.

Figure 1-4631 Remove the plate

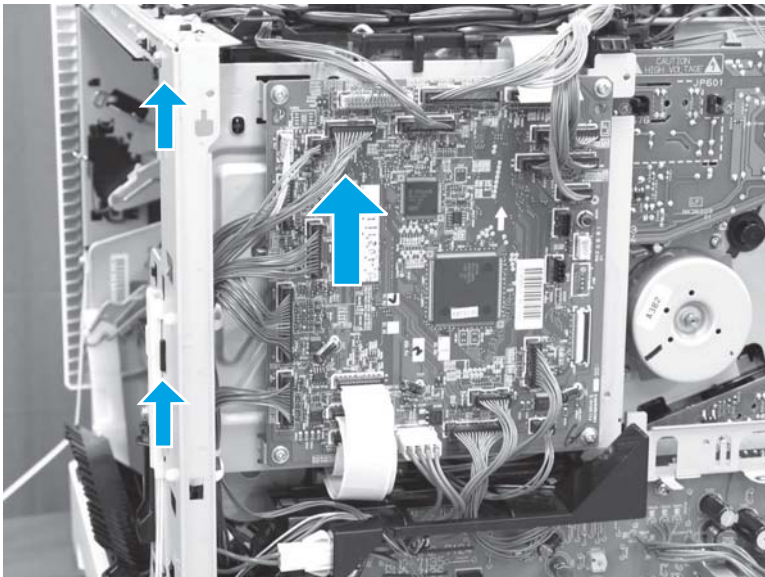

Step 34: Remove the high-voltage power supply T (HVPST)

 **CAUTION:**  ESD-sensitive part.

1. Disconnect five connectors (callout 1), and then disconnect one flat cable (callout 2).

Figure 1-4632 Disconnect five connectors and one flat cable

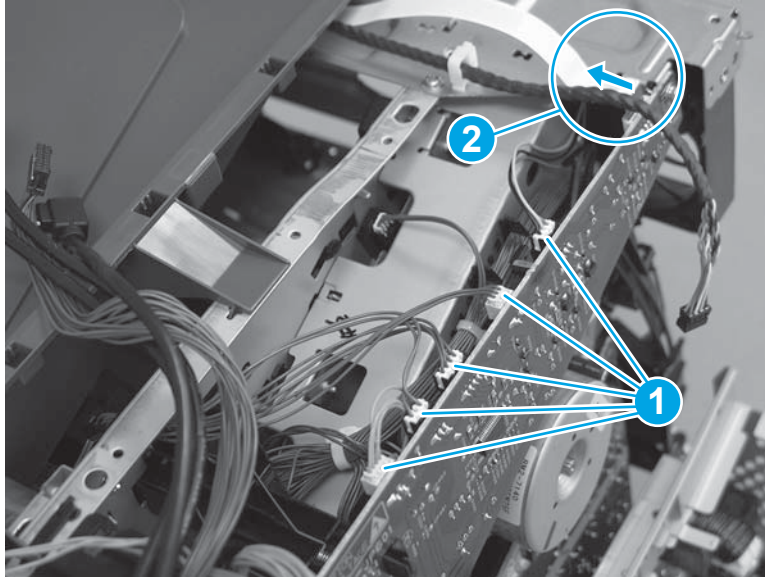

2. Remove one screw (callout 1).

Figure 1-4633 Remove one screw

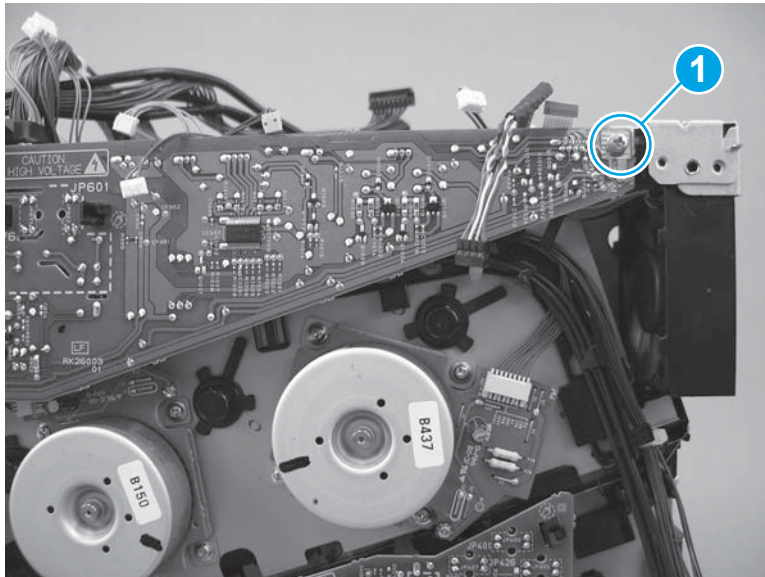

3. Release two tabs (callout 1), and then separate the HVPST from the printer.

CAUTION: Do not attempt to completely remove the HVPST. It is still connected to the printer by ground wire harness.

Figure 1-4634 Release the HVPST

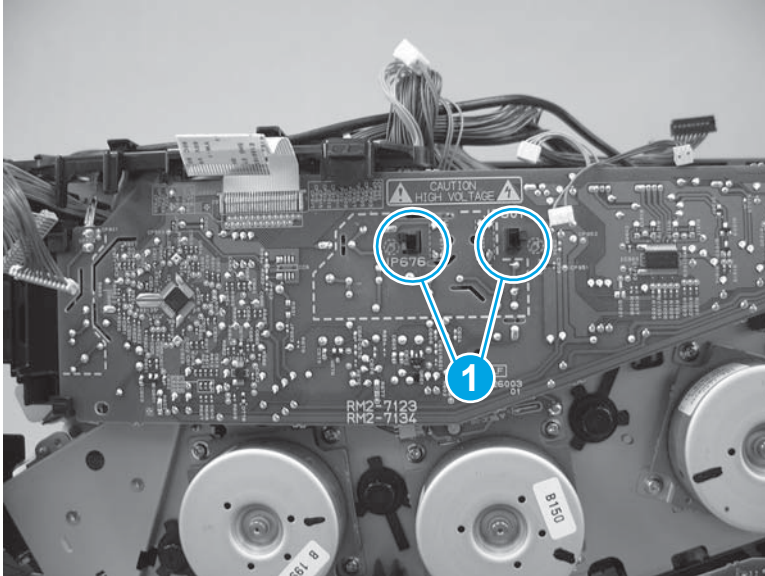

4. Release one ground wire connector (callout 1), and then remove the HVPST.

Figure 1-4635 Remove the HVPST

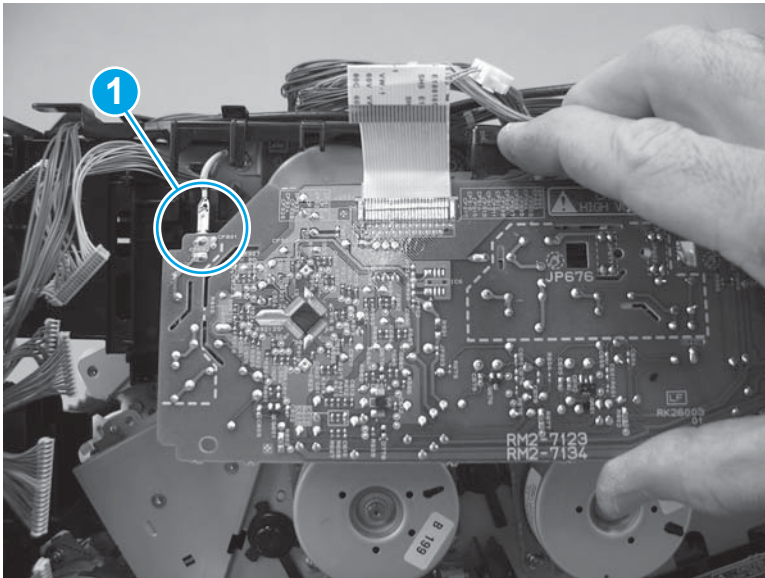

Step 35: Remove the fuser drive assembly

1. Release one tab (callout 1), slide the guide to release it (callout 2), and then rotate the guide up and away from the chassis to move it out of the way (callout 3).

CAUTION: One wire harnesses in the guide is still attached to the fuser motor. Do not attempt to completely remove the guide.

Figure 1-4636 Move the guide out of the way

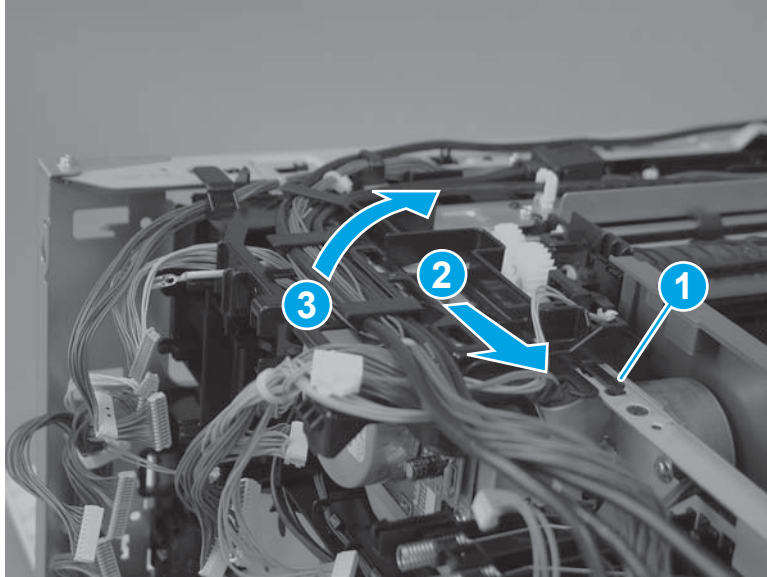

2. Disconnect one connector (callout 1).

Figure 1-4637 Disconnect one connector

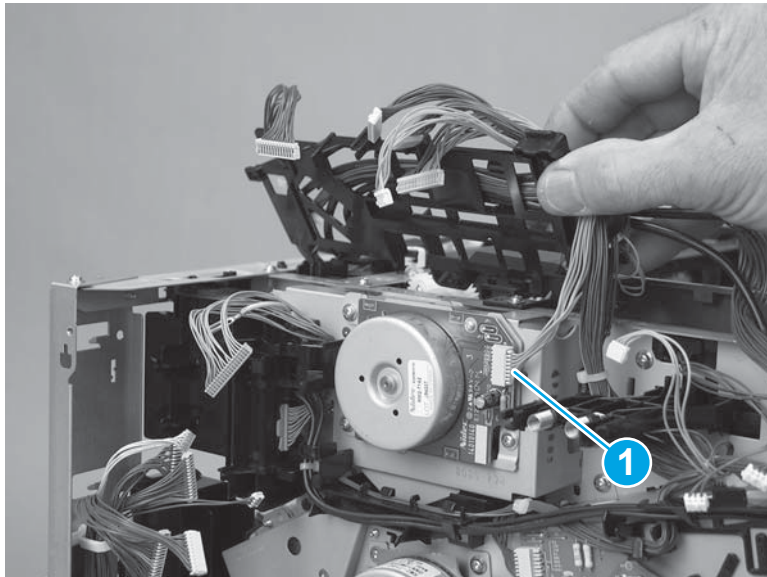

3. Remove one screw (callout 1).

Figure 1-4638 Remove one screw

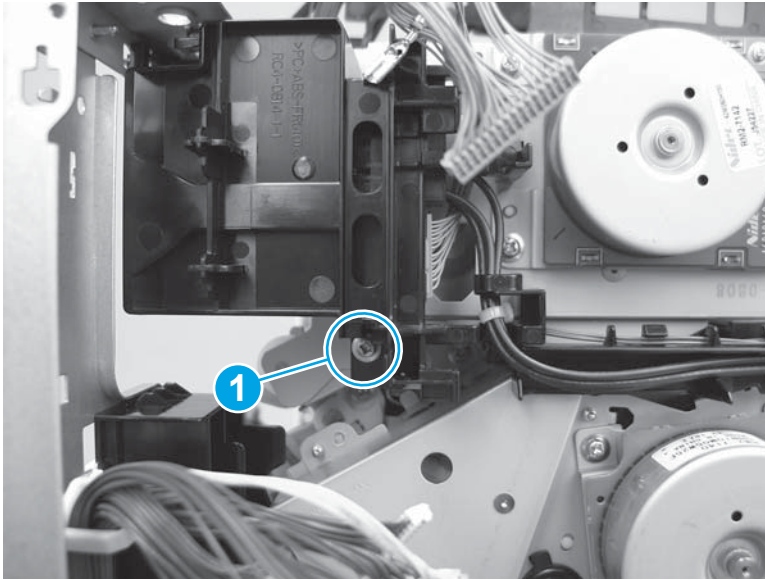

4. Release one tab (callout 1), slide the guide down to release it (callout 2), and then rotate the guide away from the chassis to remove it (callout 3).

Figure 1-4639 Remove the guide

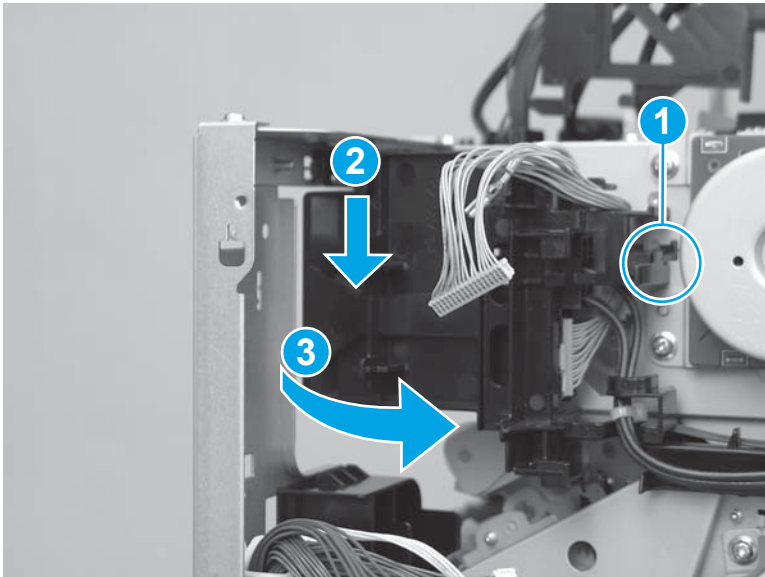

5. Remove three screws (callout 1).

Figure 1-4640 Remove three screws

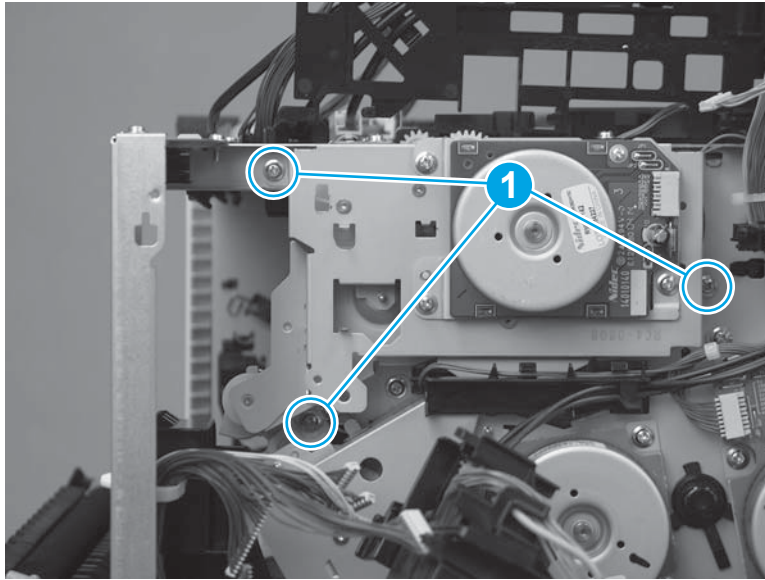

6. Remove the assembly.

CAUTION: Two gears on the back side of the assembly are not captive. Handle the assembly carefully.

Figure 1-4641 Remove the assembly

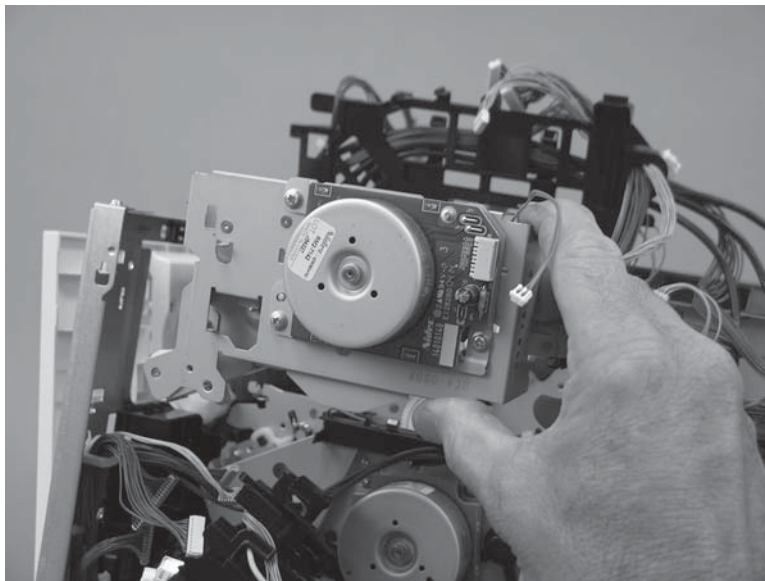

Step 36: Remove the main-drive assembly

IMPORTANT: If the toner cartridges have not already been removed prior to servicing the product, remove them now.

The toner cartridges are sensitive to strong light. Set them aside and cover them with paper to protect them.

1. At the rear side of the printer, remove one screw (callout 1).

Figure 1-4642 Remove one screw

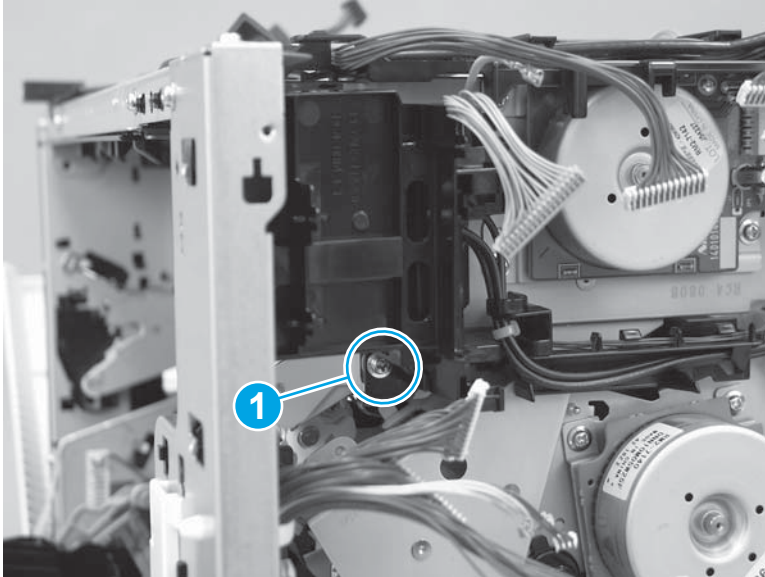

2. Release one tab (callout 1), push down on the cover (callout 2), and then rotate the cover away (callout 3) from the printer to remove it.

Figure 1-4643 Remove the cover

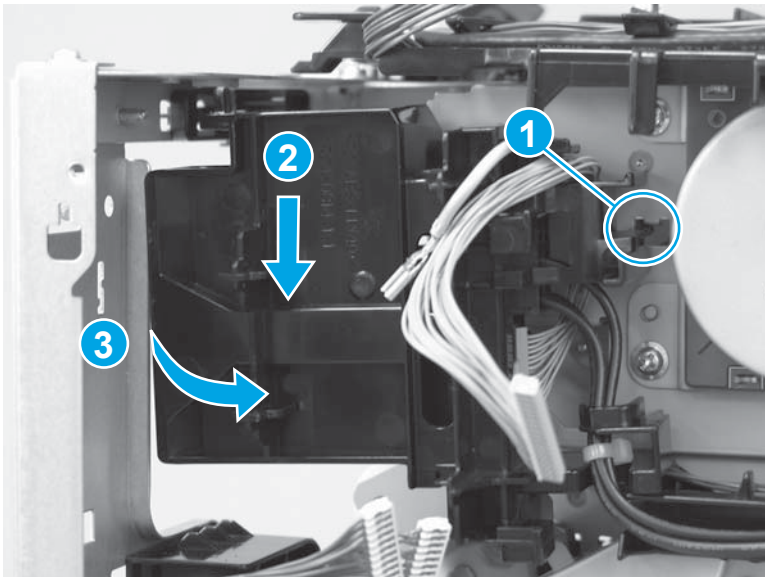

3. Release the wire harnesses from the guides (callout 1).

Figure 1-4644 Release the wire harnesses

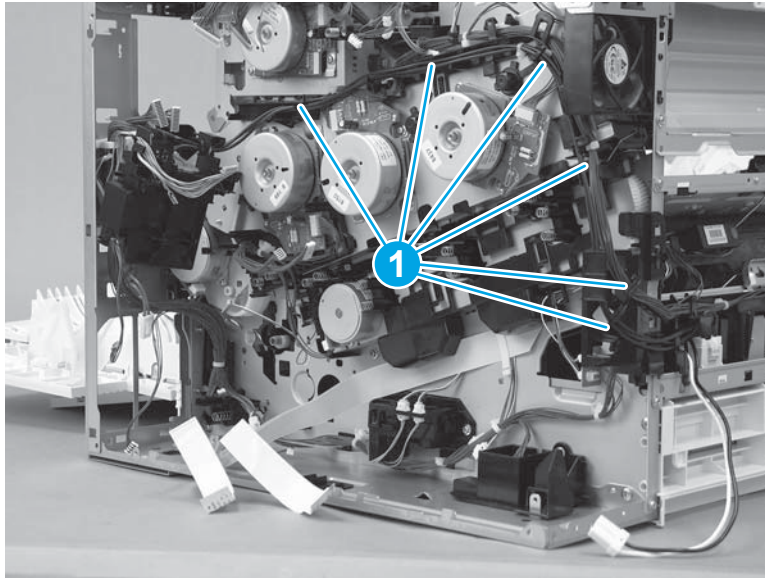

4. At the top of the printer, disconnect two connectors (callout 1).

Figure 1-4645 Disconnect two connectors

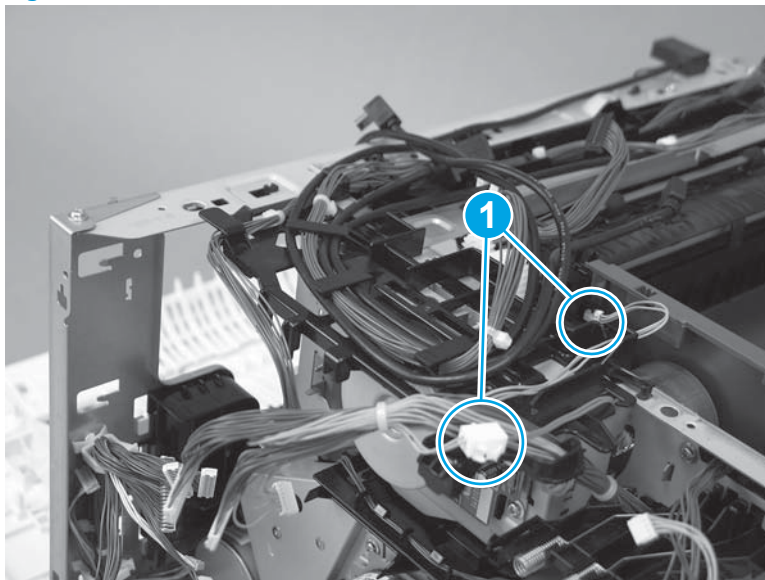

5. Release the wire harnesses (callout 1) from the retainers (callout 2).

Figure 1-4646 Release the wire harnesses

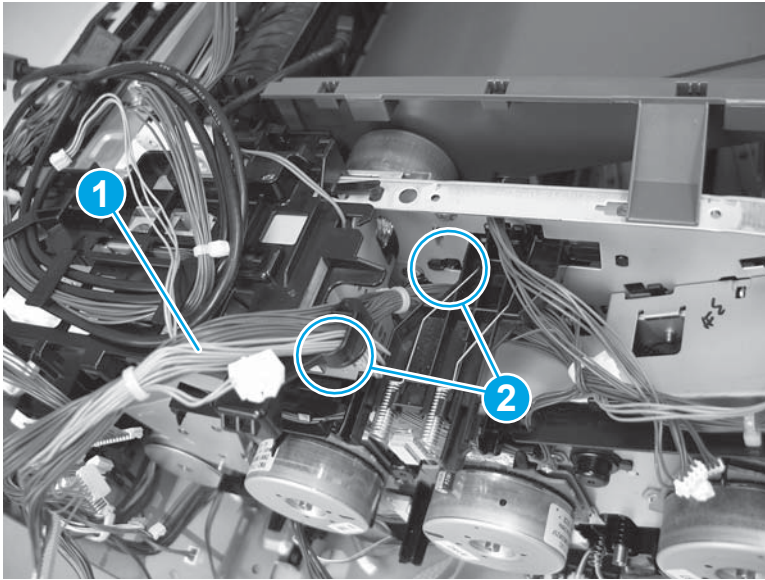

6. At the left side of the printer, disconnect one connector (callout 1), and then release the wire harnesses from the retainers (callout 2).

Figure 1-4647 Disconnect one connector

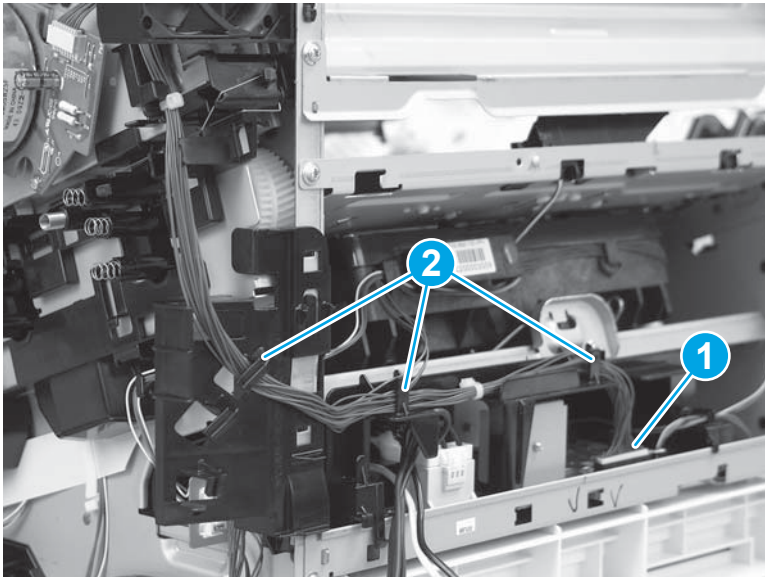

7. Release one tab (callout 1), and then push up on the guide (callout 2) to release it.

Figure 1-4648 Release the guide

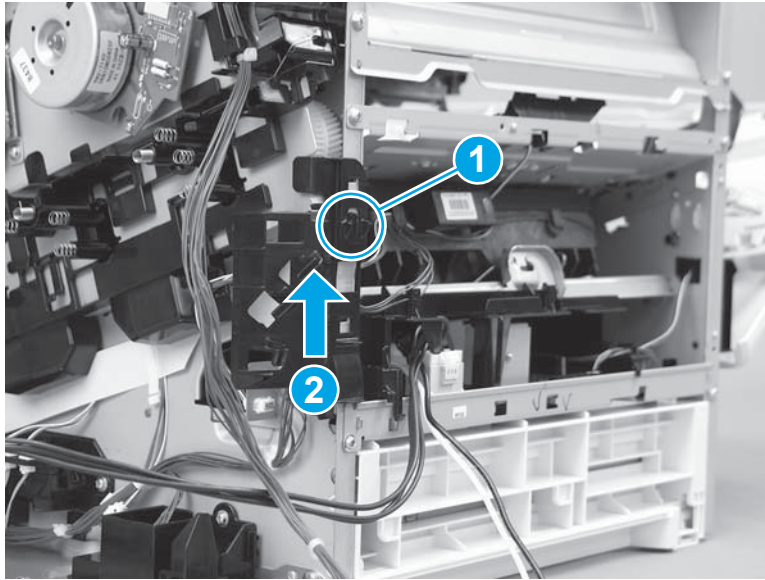

8. Remove the guide.

Figure 1-4649 Remove the guide

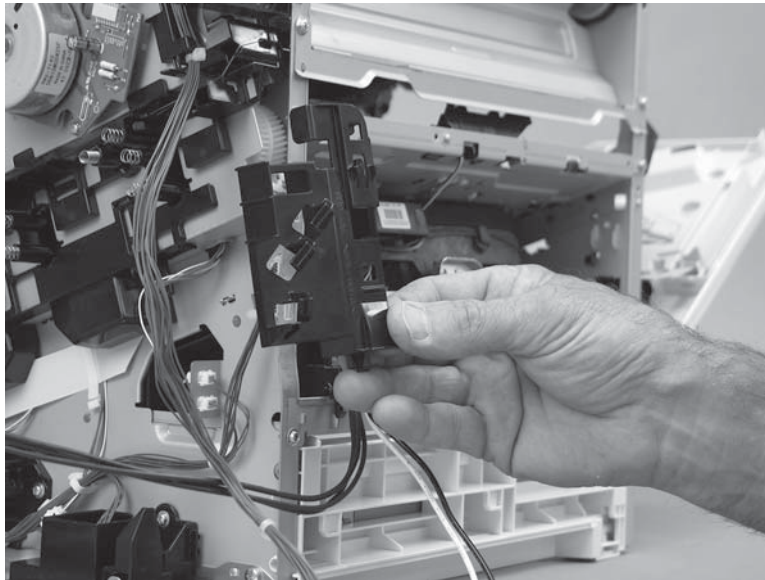

9. Release one wire harness (callout 1) from the retainer.

Figure 1-4650 Release one wire harness

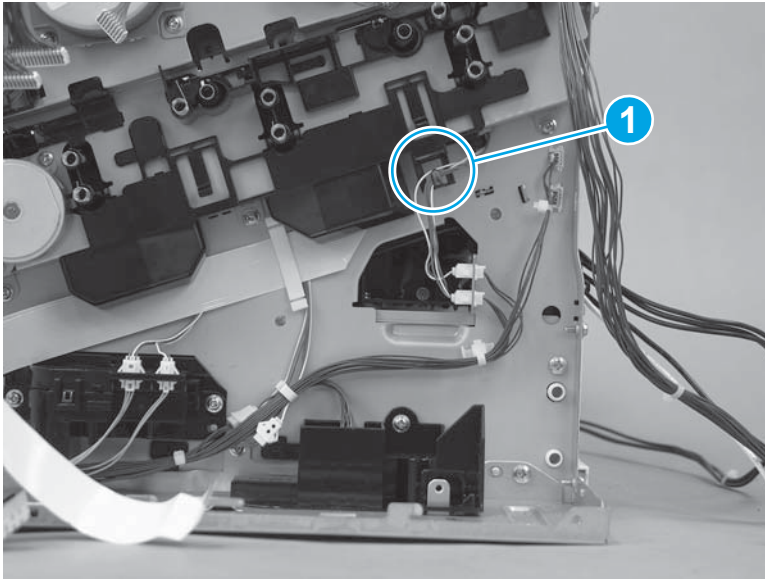

10. Release two tabs (callout 1), and then pull down on the guide (callout 2) to release it.

Figure 1-4651 Release the guide

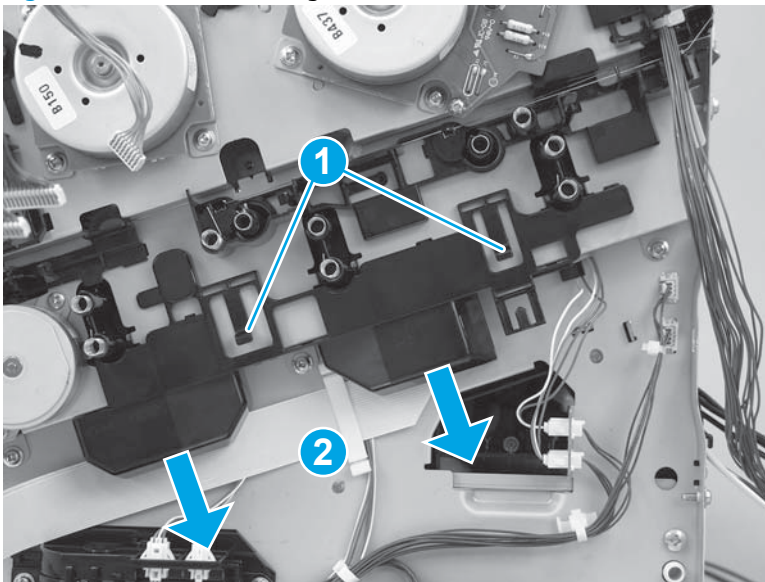

11. Remove the guide.

Figure 1-4652 Remove the guide

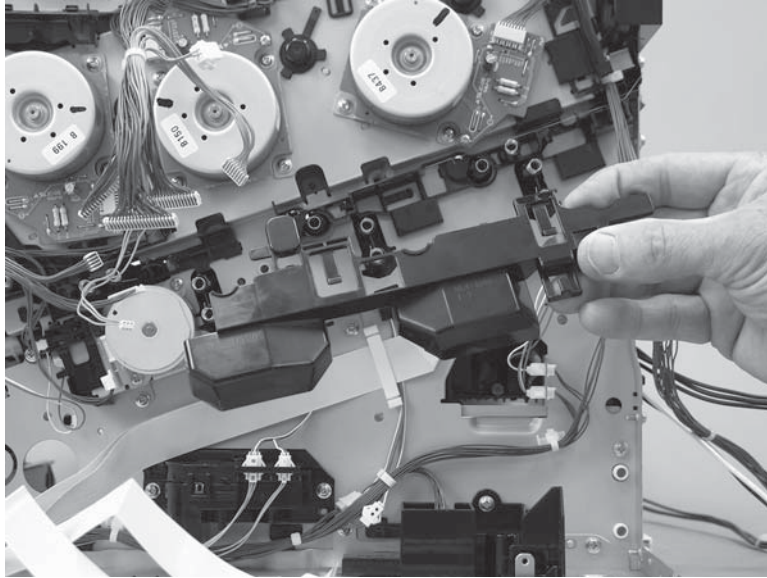

12. Remove seven screws (callout 1).

Figure 1-4653 Remove seven screws

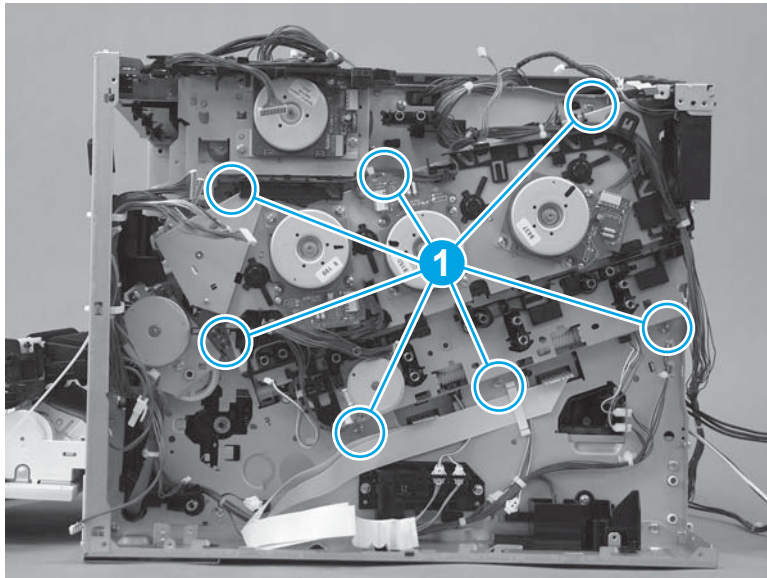

13. Carefully remove the main-drive assembly.

Figure 1-4654 Remove the main-drive assembly

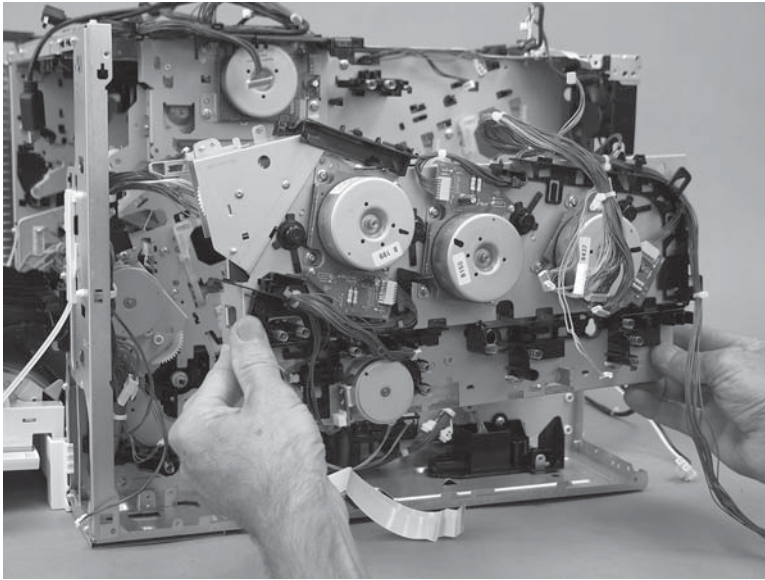

Step 37: Unpack the replacement assembly

Unpack the replacement assembly from the packaging.

For complete information on HP's recycling programs, go to [Product return and recycling](#).

CAUTION: When handling the assembly, take care not to wipe any of the grease off of the gears on the back side of the assembly.

NOTE: HP recommends responsible disposal of the defective assembly.

Figure 1-4655 Recycle and unpack

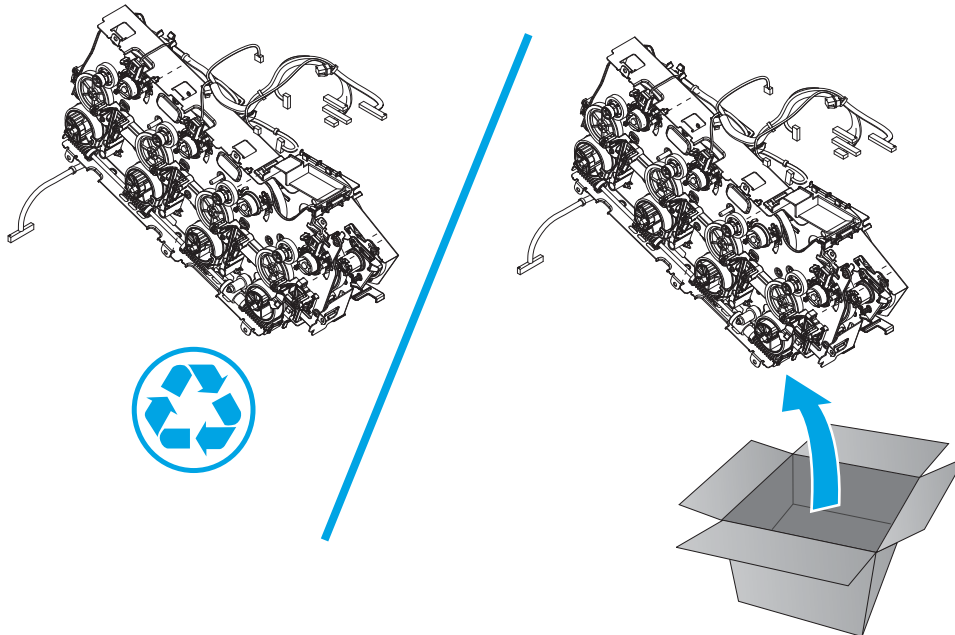

Check the main drive cam alignment

The cams on the back side of the assembly must be correctly aligned before the replacement assembly is installed.

1. Locate the 4 gears and cams (callouts 1-4) on the back side of the assembly.

Figure 1-4656 Main drive gear and cam locations

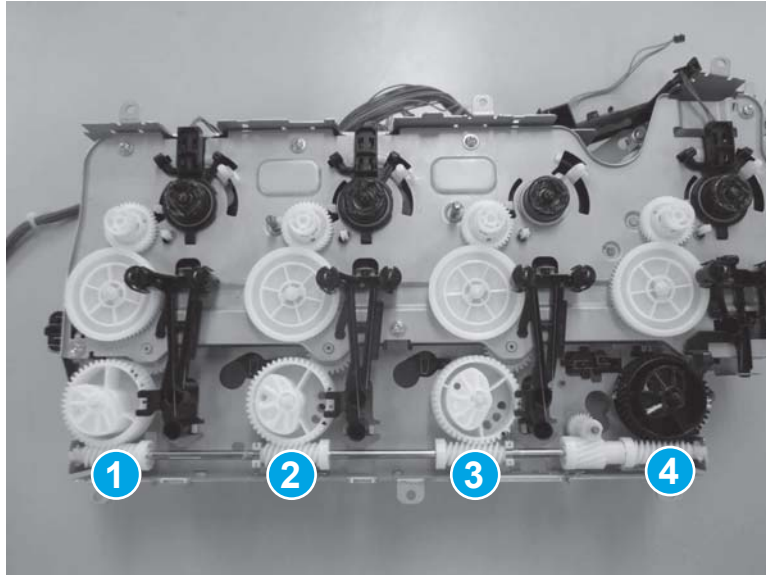

2. Verify the alignment of the holes in the 4 gears with the holes in the assembly chassis as shown.

 **TIP:** Rotate the shaft under the gears to change the alignment if necessary.

Figure 1-4657 Main drive gear and cam alignment

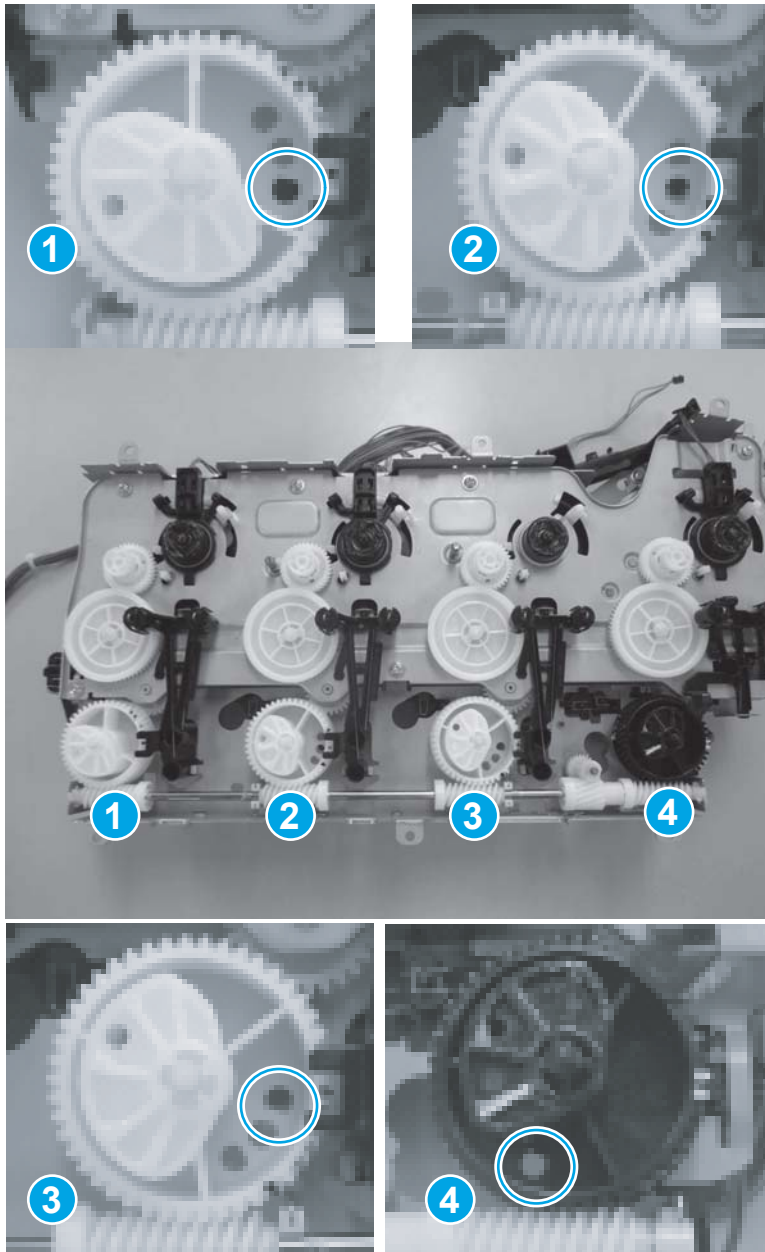

Step 38: Install the main-drive assembly

 **CAUTION:** When handling the assembly, take care not to wipe any of the grease off of the gears on the back side of the assembly.

1. Before proceeding, make sure that the blue ITB drive handle is in the locked (callout 1; pushed in) position on the replacement main-drive assembly.



 **NOTE:** If the drive handle is in the unlocked (callout 2; pulled out) position it will be difficult to install assembly.

Figure 1-4658 Check the blue ITB drive handle

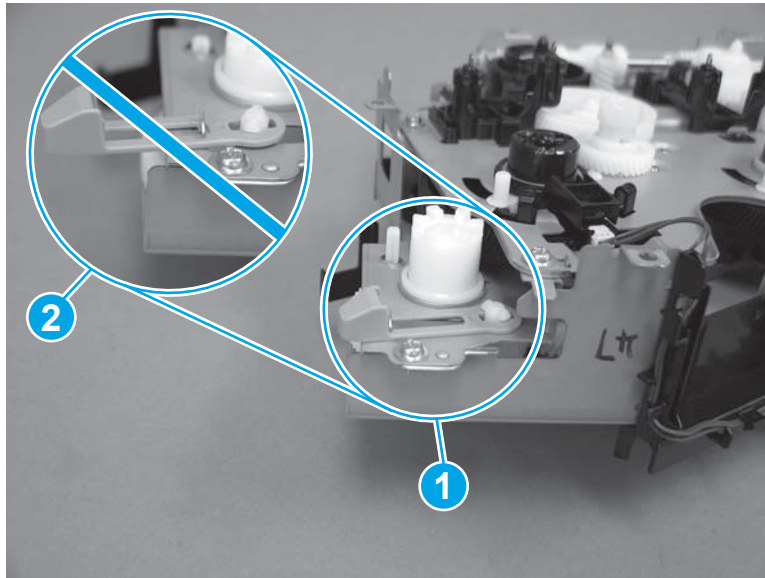

2. With the front door in the closed position, carefully position the replacement main-drive assembly on the printer.

 **CAUTION:** When handling the assembly, take care not to wipe any of the grease off of the gears on the back side of the assembly.

 **TIP:** Place the bottom of the assembly on the printer first, and then rotate the top of the assembly onto the printer.

Make sure that the entire assembly fits flush up against the chassis.

Figure 1-4659 Install the main-drive assembly

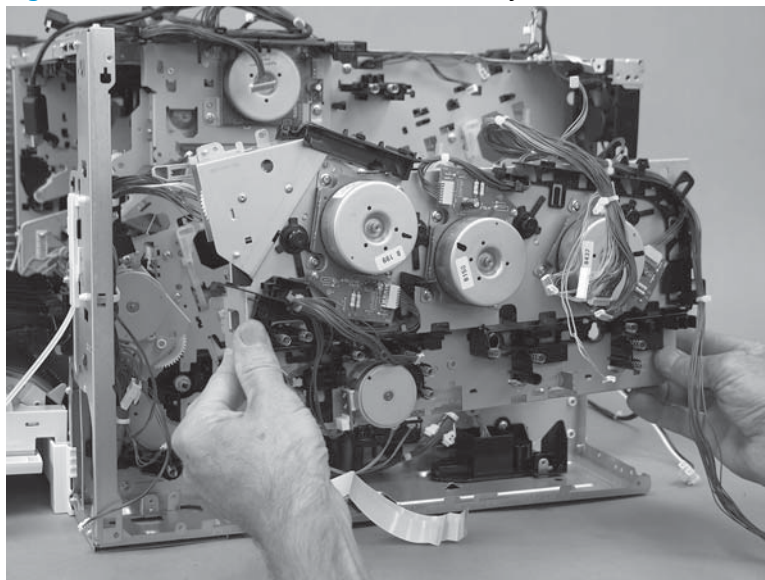

3. Install seven screws (callout 1).

Figure 1-4660 Install seven screws

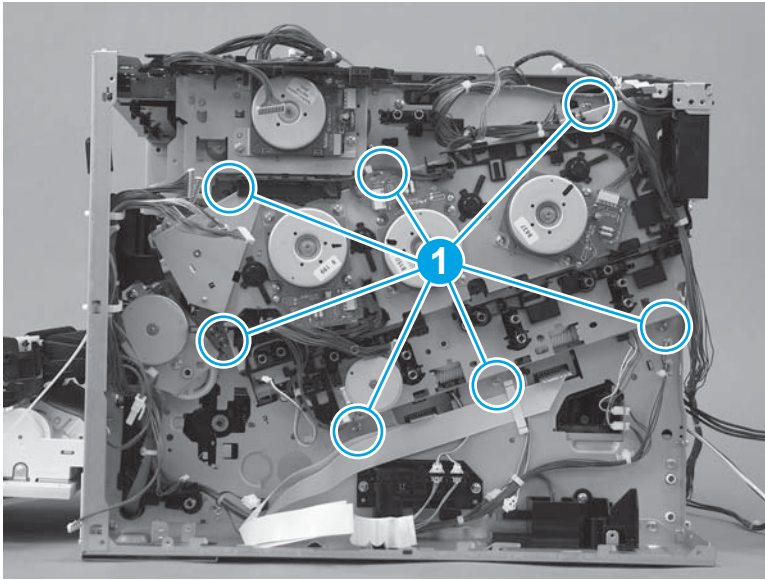

4. To verify that the assembly is correctly fastened to the chassis, open and close the front door while observing the cartridge drive gears (callout 1). The gears must freely move in and out when the door is opened and closed.

 **NOTE:** If the gears do not move freely, remove the assembly, reposition it on the chassis, and then verify that the gears move freely.

Figure 1-4661 Verify that the assembly is correctly fastened



5. Position the guide on the assembly, push up to install it, and then make sure that the two tabs (callout 1) snap into place.

Figure 1-4662 Install the guide

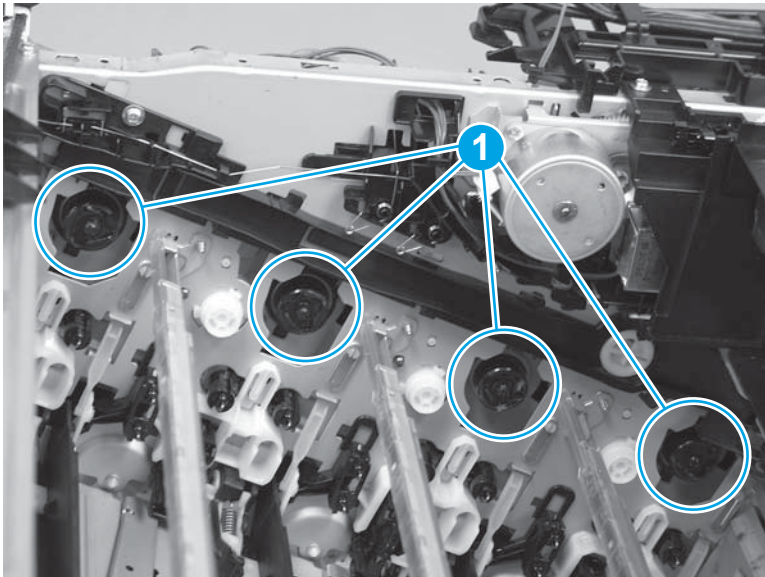
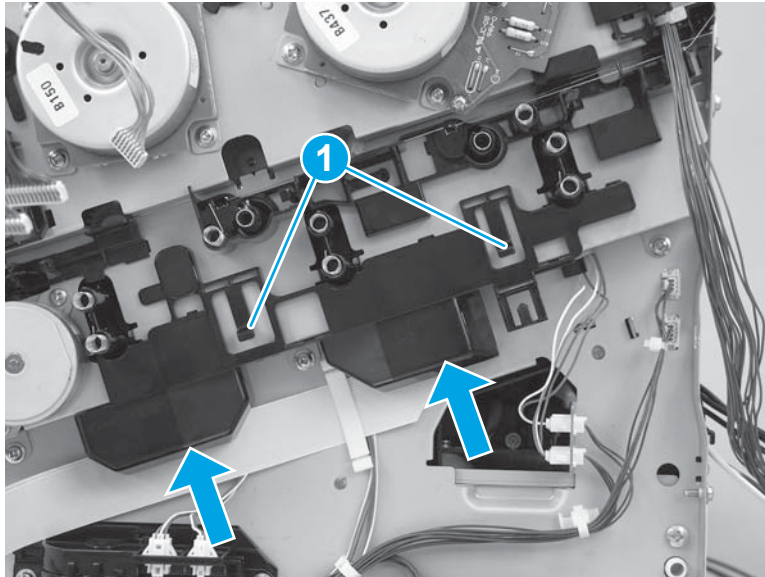

6. Install one wire harness (callout 1) on the retainer.

Figure 1-4663 Install one wire harness

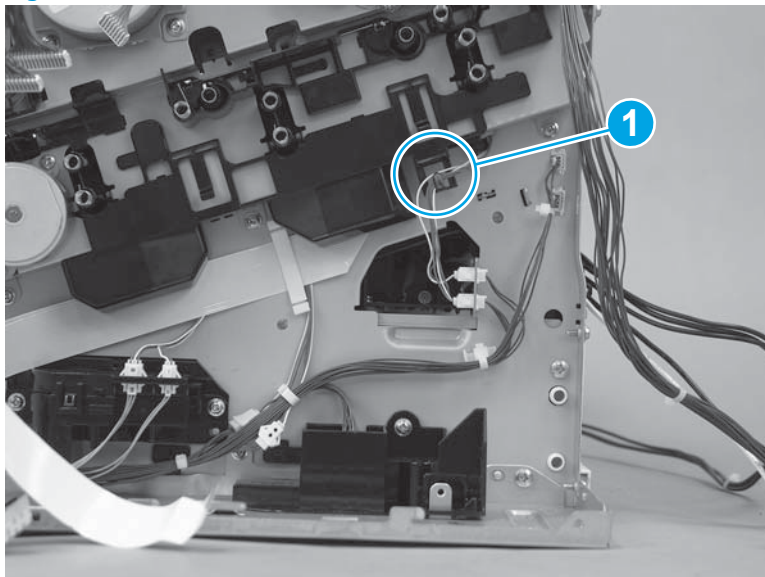

7. Position the guide on the assembly, push up to install it, and then make sure that the two tabs (callout 1) snap into place.

Figure 1-4664 Install the guide

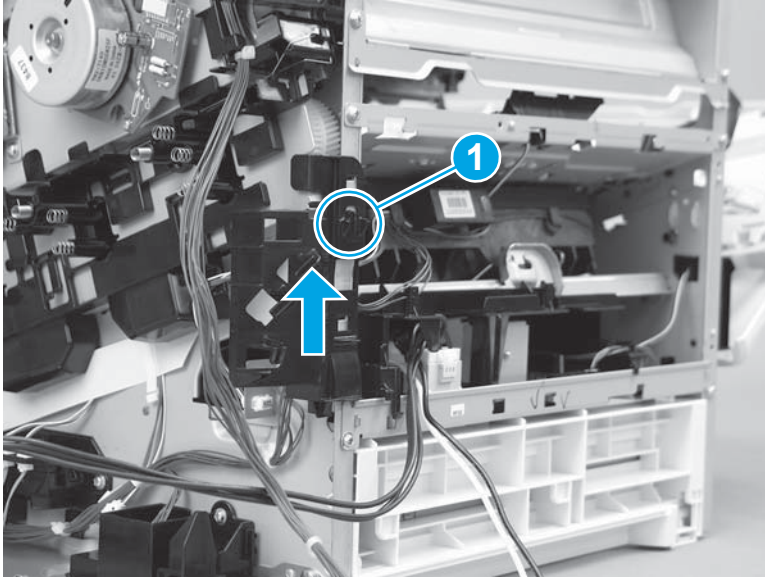

8. At the left side of the printer, connect one connector (callout 1), and then install the wire harnesses in the retainers (callout 2).

Figure 1-4665 Connect one connector

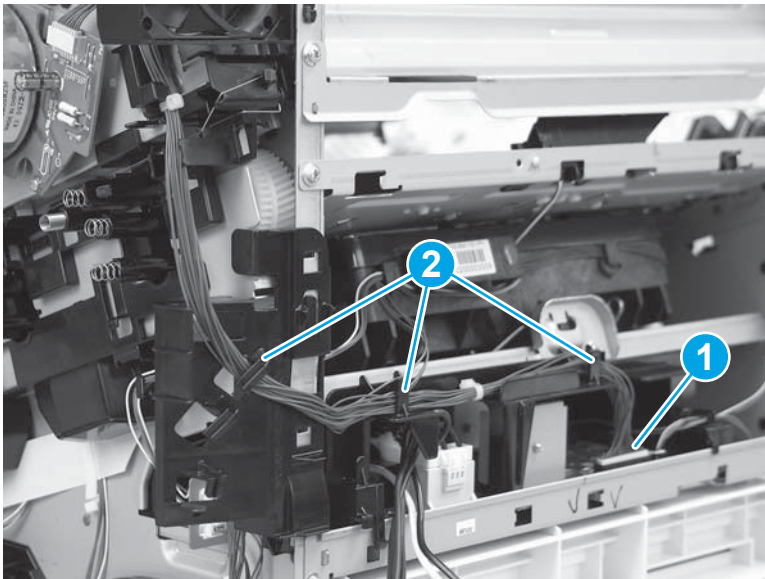

9. At the top of the printer, install the wire harnesses (callout 1) in the retainers (callout 2).

Figure 1-4666 Install the wire harnesses

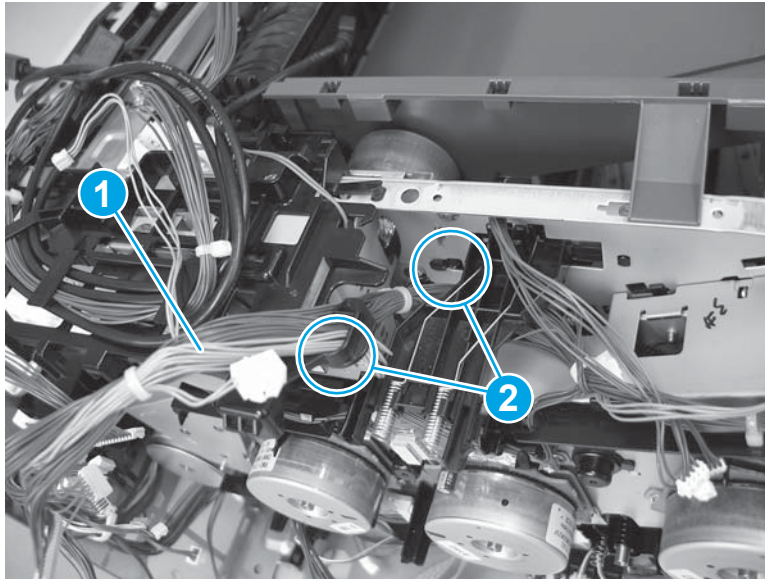

10. Connect two connectors (callout 1).

Figure 1-4667 Connect two connectors

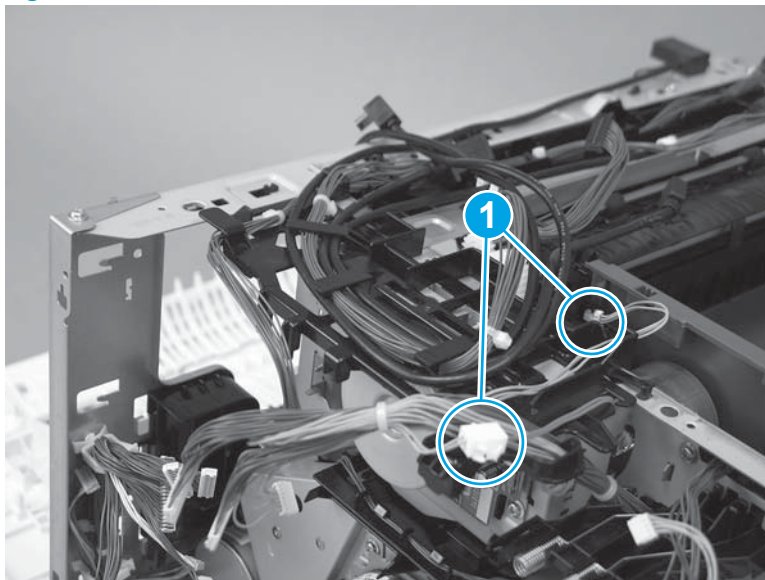

11. Install the wire harnesses in the guides (callout 1).

Figure 1-4668 Install the wire harnesses

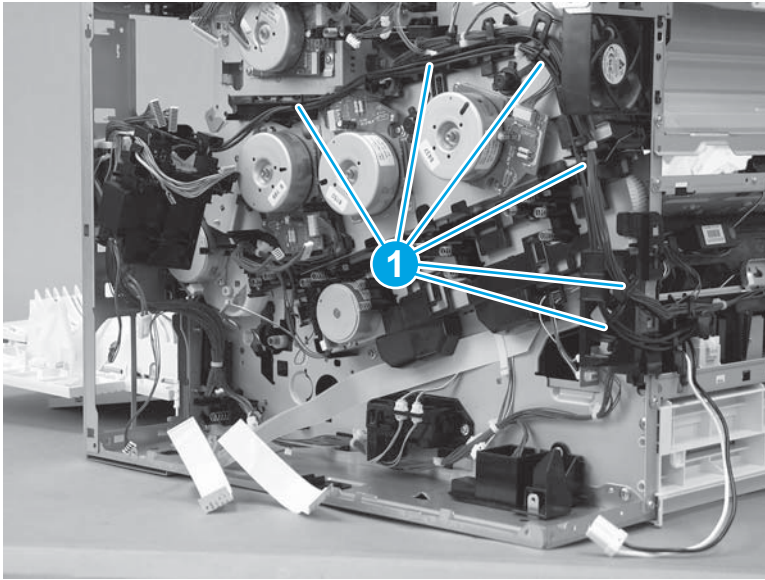

12. At the rear side of the printer do the following:
 - a. Position the right edge of the cover on the printer.
 - b. Rotate the left edge of the cover toward (callout 1) the printer to install it.
 - c. Push up on the cover (callout 2) to engage it.
 - d. Make sure that one tab (callout 3) snaps into place

Figure 1-4669 Install the cover

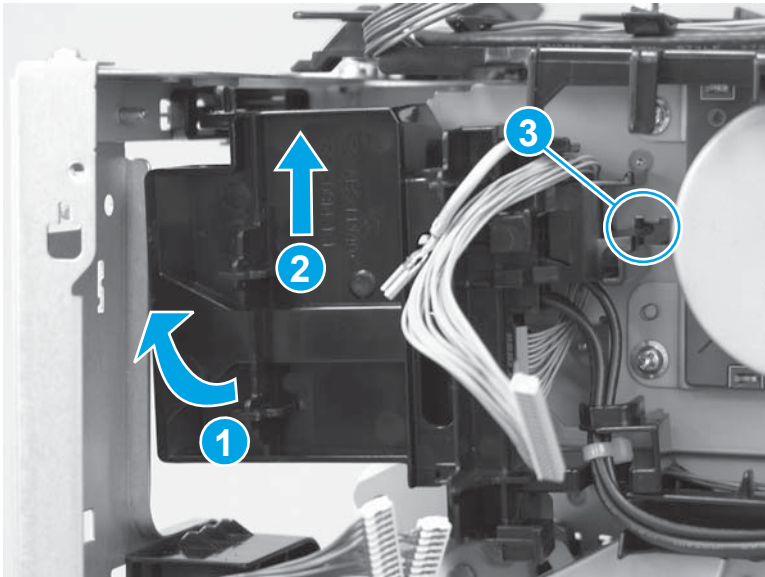

13. Install one screw (callout 1).

Figure 1-4670 Install one screw

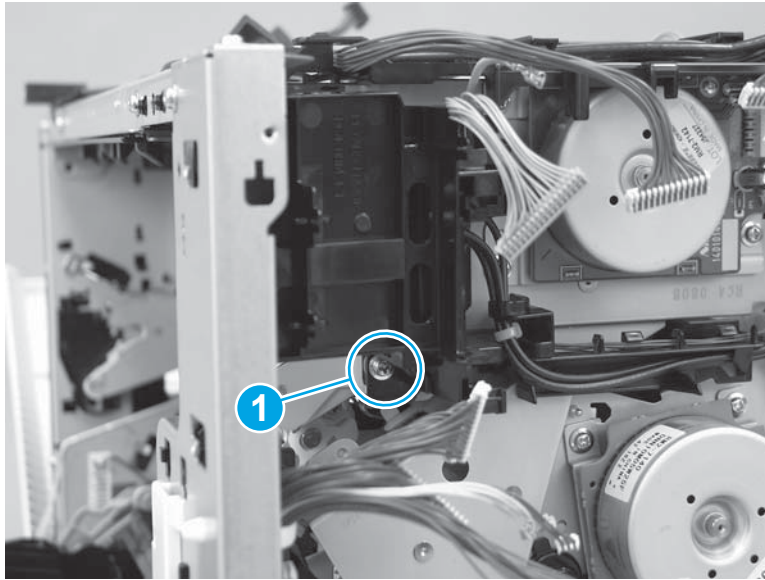

Step 39: Install the fuser drive assembly

1. Two gears (callout 1) on the back side of the assembly are not captive. If the gears are dislodged, install them as shown.

CAUTION: Handle the assembly carefully.

Figure 1-4671 Check the gears on the assembly

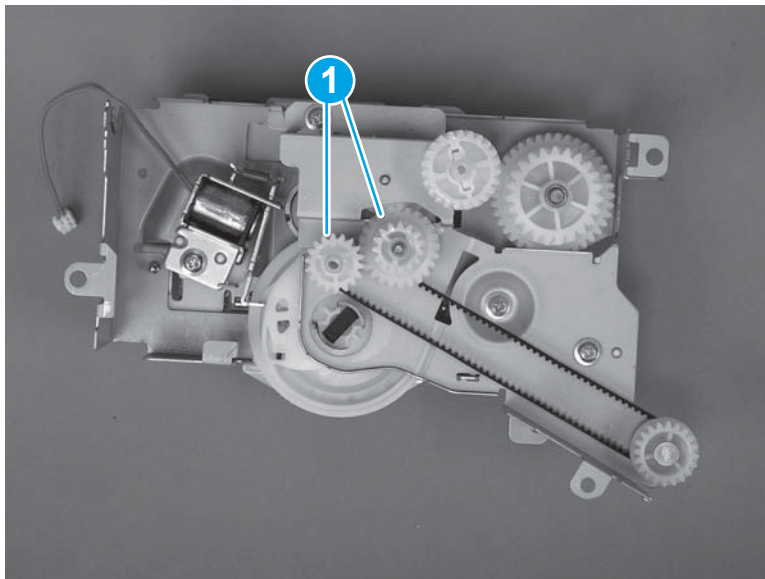

2. Position the assembly on the chassis, and then install three screws (callout 1).

Figure 1-4672 Install three screws

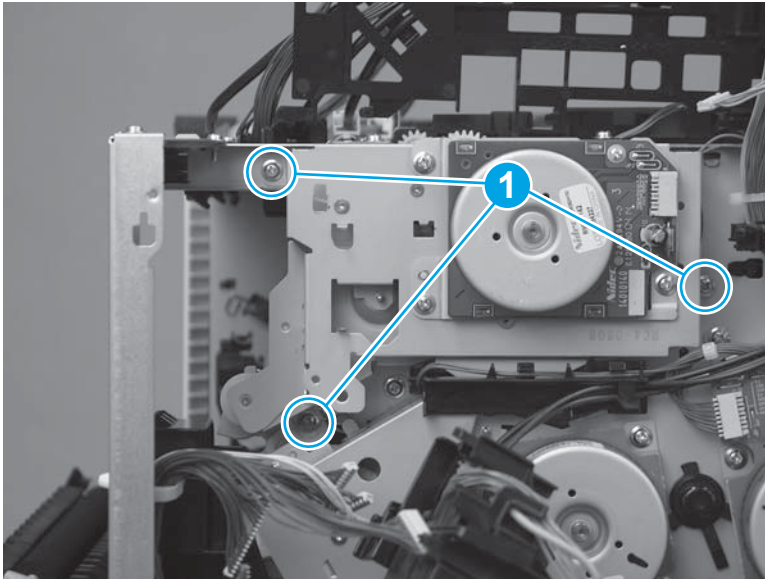

3. Position the guide on the chassis (callout 1), slide the guide up to engage it (callout 2), and then verify that the tab (callout 1) snaps into place.

Figure 1-4673 Install the guide

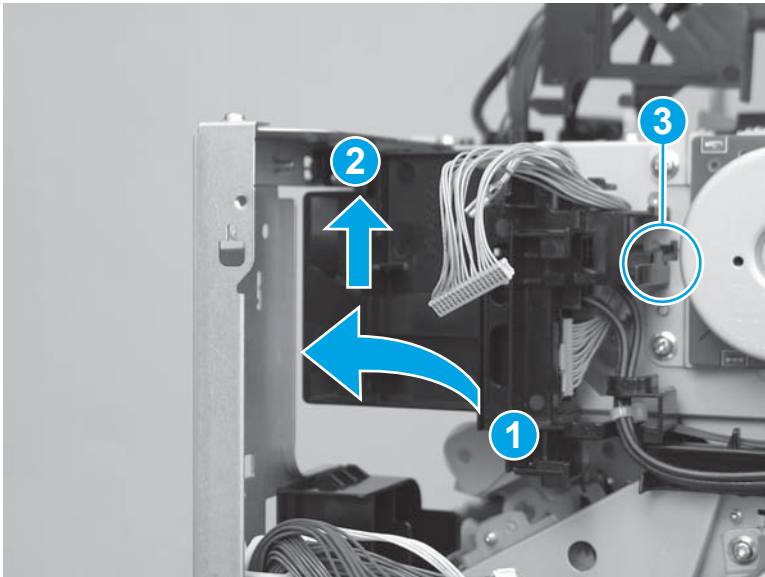

4. Install one screw (callout 1).

Figure 1-4674 Install one screw

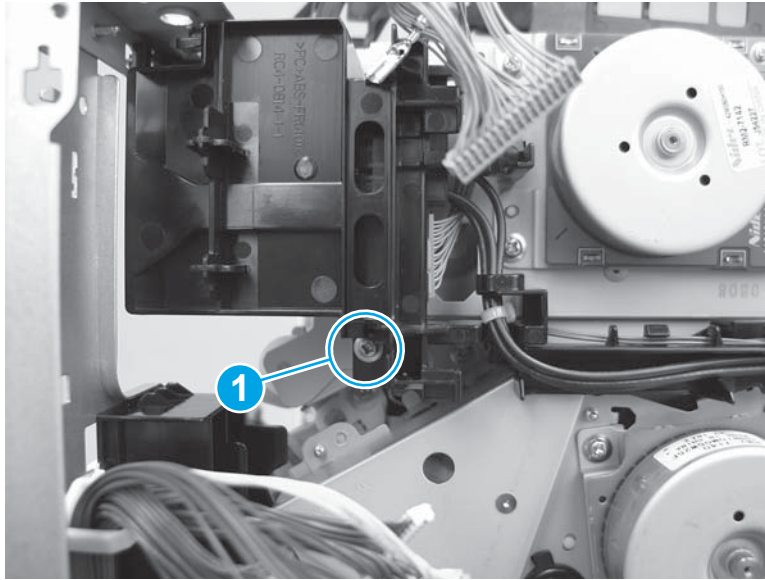

5. Connect one connector (callout 1).

Figure 1-4675 Connect one connector

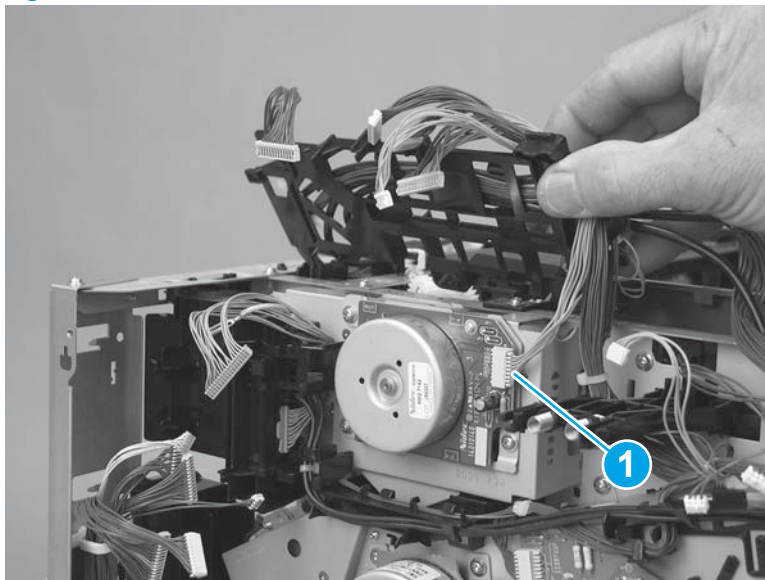

6. Rotate the guide down and onto the chassis (callout 1), slide the guide to engage it (callout 2), and then make sure that the tab (callout 3) snaps into place.

CAUTION: Do not dislodge the fuser motor connector when installing the guide.

Figure 1-4676 Install the guide

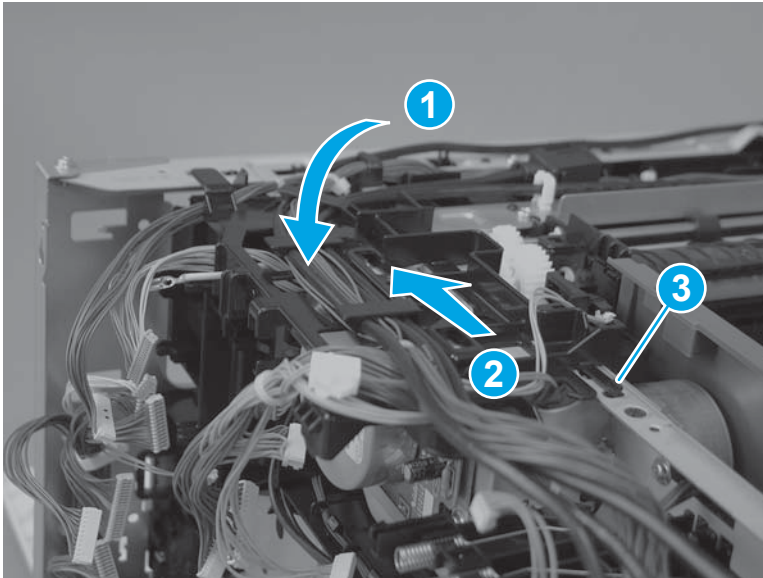

Step 40: Install the HVPST

CAUTION:  ESD-sensitive part.

1. Connect one ground wire connector (callout 1).

Figure 1-4677 Connect one ground wire

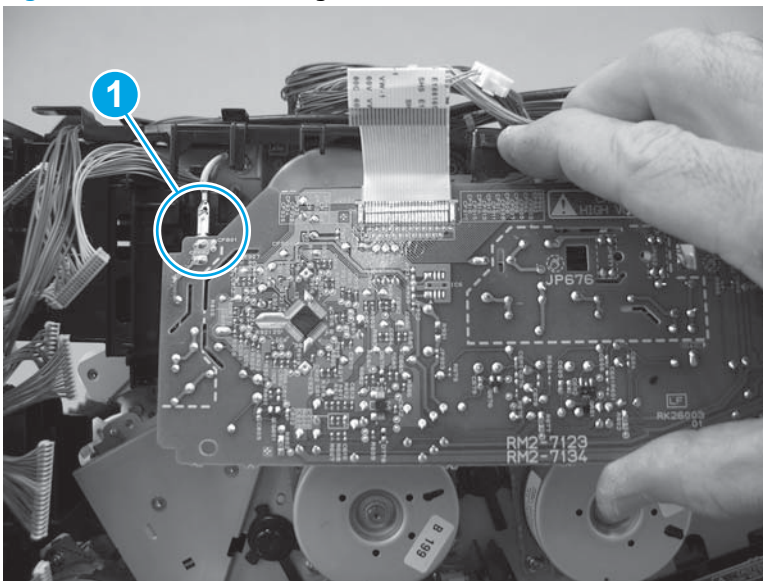

2. Position the HVPST on the printer, and then push in to engage two tabs (callout 1).

 **NOTE:** Make sure that the tabs snap into place.

Figure 1-4678 Install the HVPST

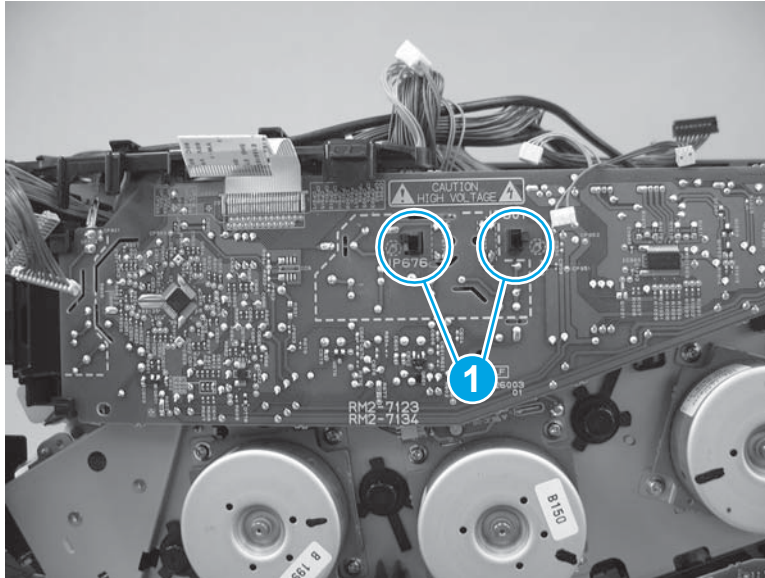

3. Install one screw (callout 1).

Figure 1-4679 Install one screw

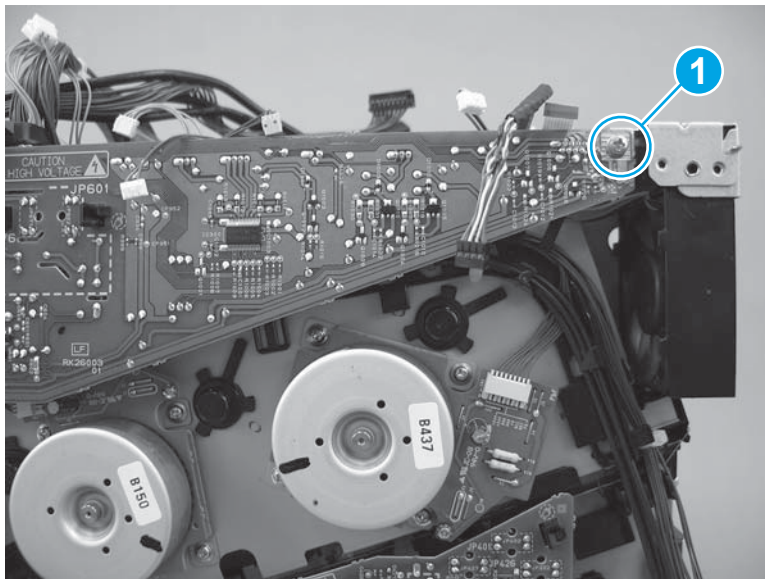

4. Connect five connectors (callout 1), and then connect one flat cable (callout 2).

Figure 1-4680 Connect five connectors and one flat cable

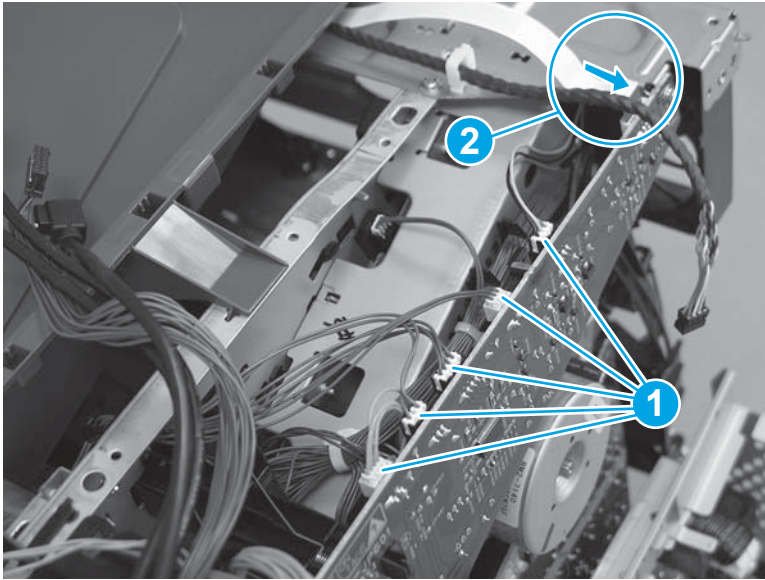

Step 41: Install the DC controller and sheet-metal bracket

 **CAUTION:**  ESD-sensitive part.

1. Position the DC controller and sheet-metal plate on the printer, and then push down to engage the plate with the chassis.

Figure 1-4681 Install the plate

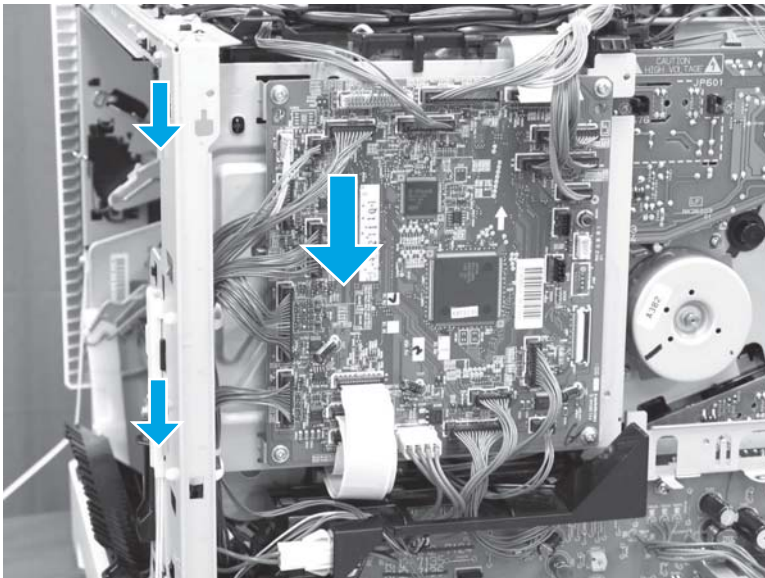

2. Install two screws (callout 1), and then connect all of the connectors.

The following connectors are empty:

- J140, J141, and J143

Figure 1-4682 Install two screws

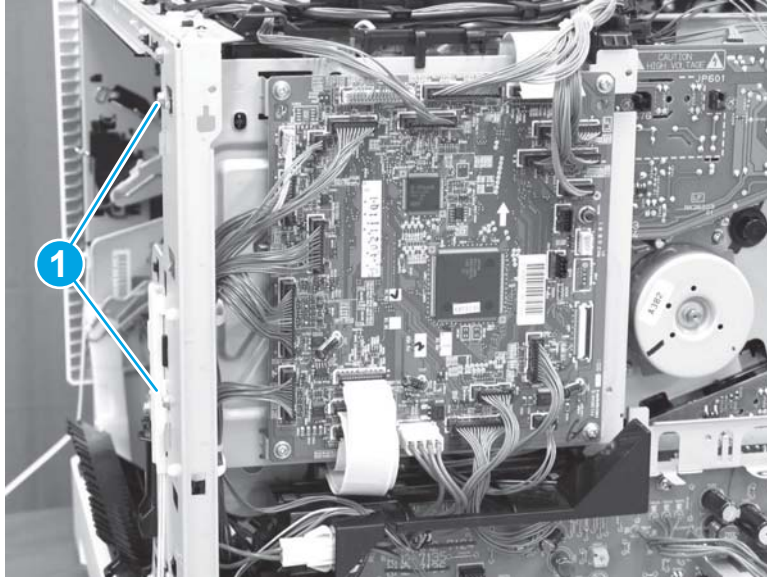

Step 42: Install the lifter drive assembly

1. Install one wire harness on the retainer (callout 1), position the lifter drive assembly in the printer (make sure that one tab (callout 2) snaps into place), and then install two screws (callout 3).

 **TIP:** It might be easier to install the assembly if the bottom of the assembly is installed first, and then the top of the assembly is rotated into place.

Figure 1-4683 Install the lifter drive



2. Connect two flat cables (callout 1), and then place them in the retainers (callout 2).

Figure 1-4684 Connect two flat cables

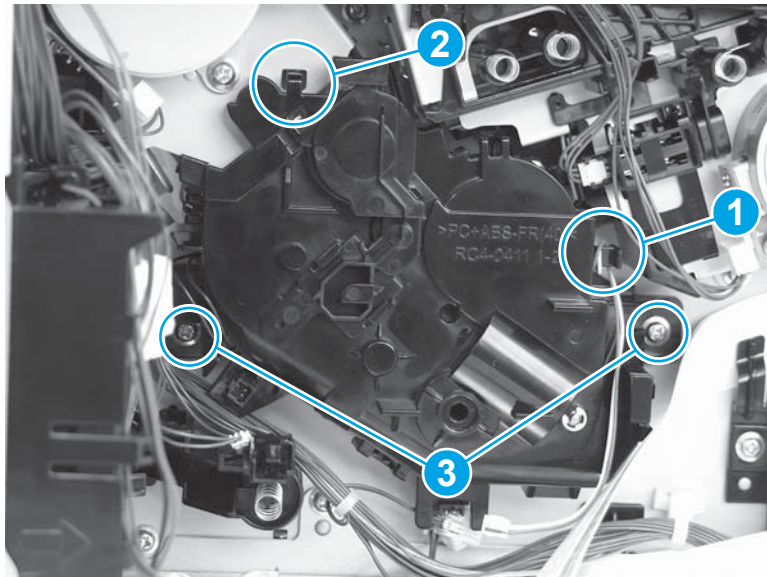
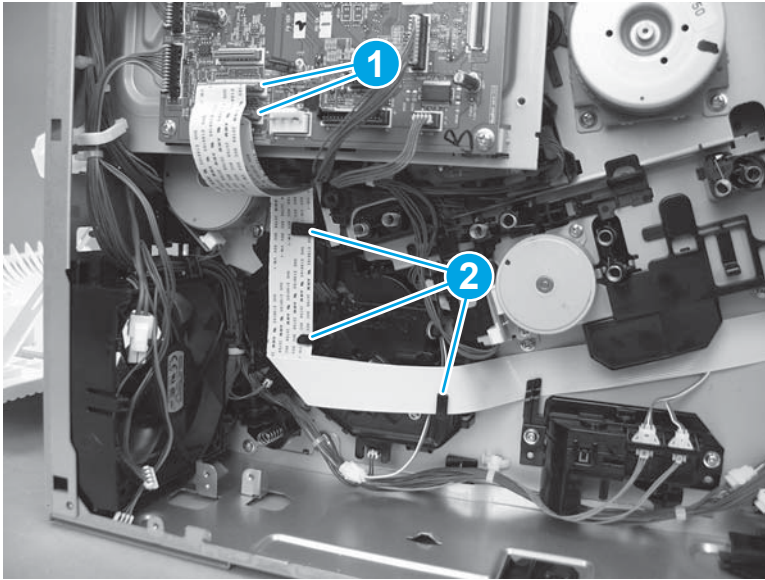

3. Connect two connectors (callout 1).

Figure 1-4685 Connect two connectors

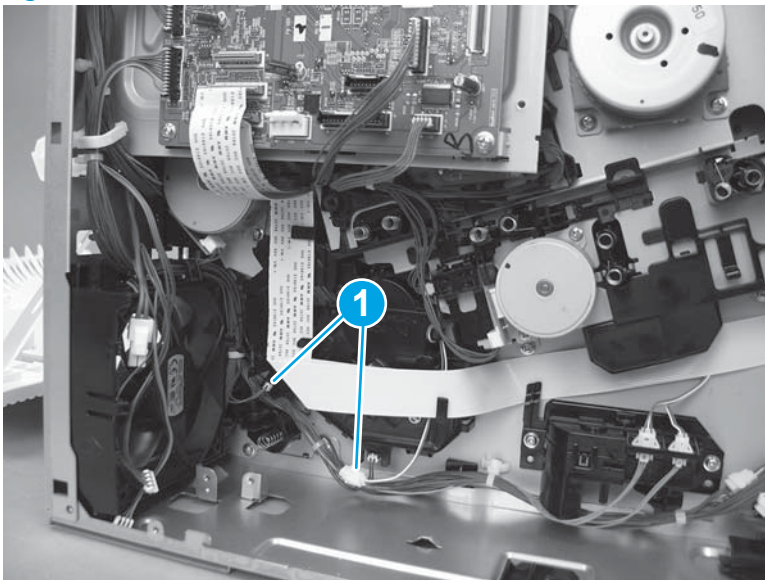

Step 43: Install the HVPSD

 **CAUTION:**  ESD-sensitive part.

1. Position the bottom right corner of the HVPSD (callout 1) behind the black tab, and then rotate it up and onto the printer (callout 2).

Figure 1-4686 Install the HVPSD

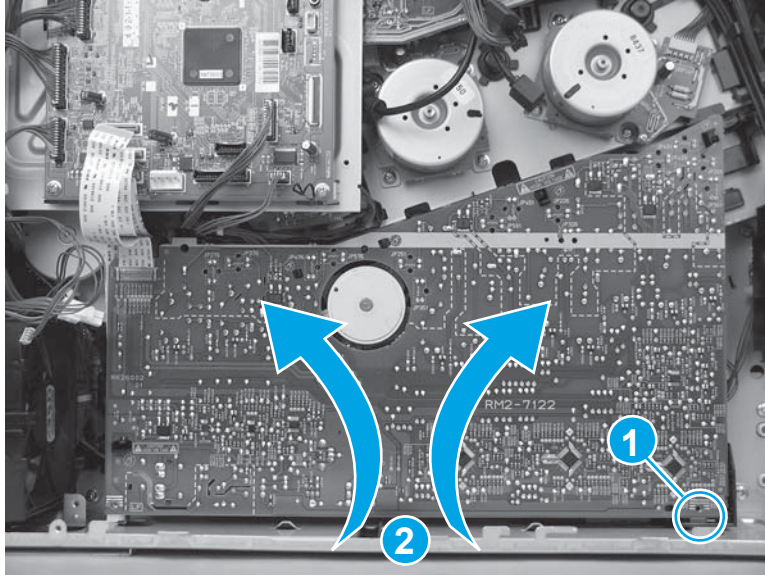

2. Press it onto five tabs (callout 2).

 **IMPORTANT:** Make sure that all five tabs snap into place.

Figure 1-4687 Press the tabs



3. Install two screws (callout 1), and then install one self tapping screw (callout 2) on the HVPSD.

Figure 1-4688 Install three screws

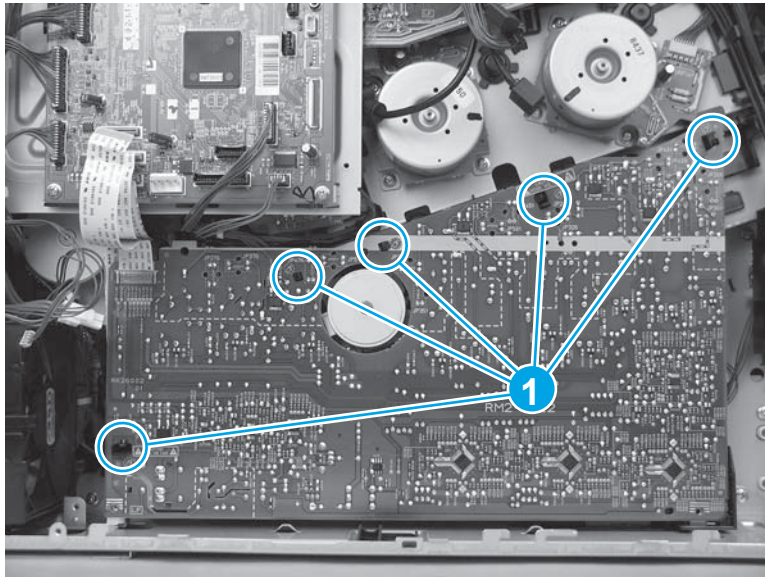
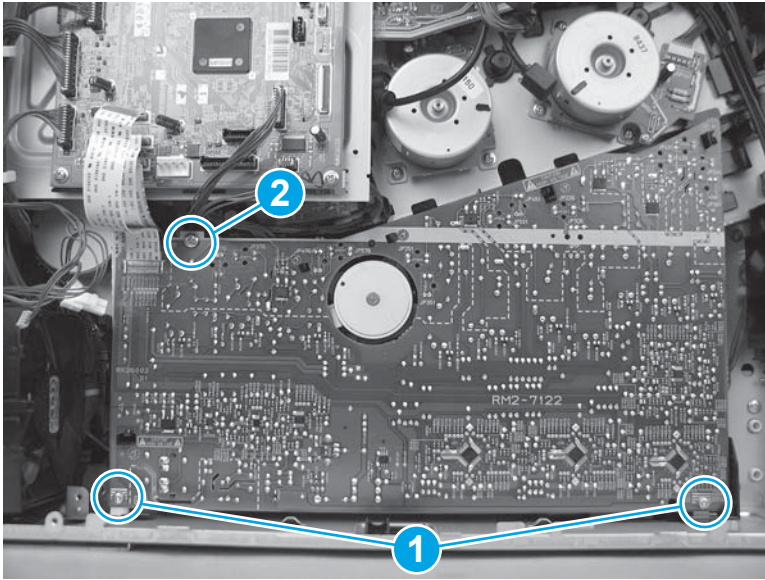

4. Connect one flat cable (callout 1) on the DC controller.

Figure 1-4689 Connect one flat cable

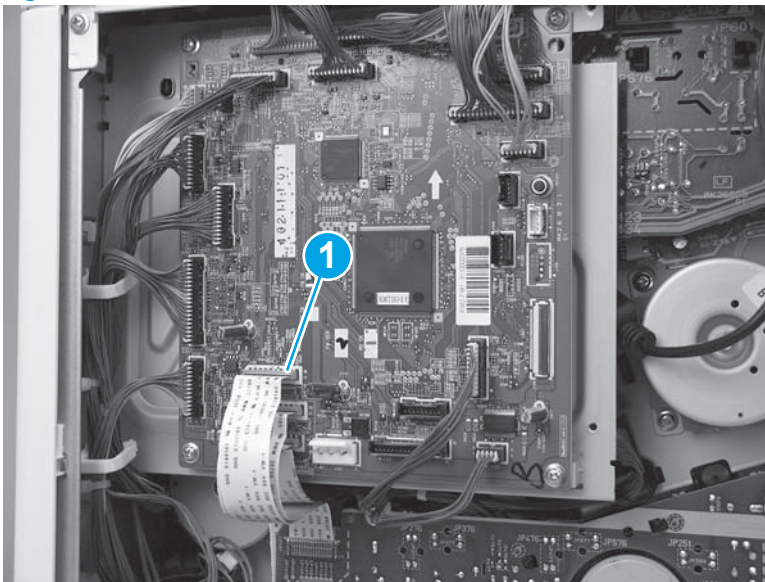

Step 44: Install the power-supply fan (FM1)

1. Slide the fan in (callout 1) and then down (callout 2) into the printer to install it.



NOTE: Make sure that the arrow (callout 3) embossed on the fan holder faces into the printer.

Figure 1-4690 Install the fan

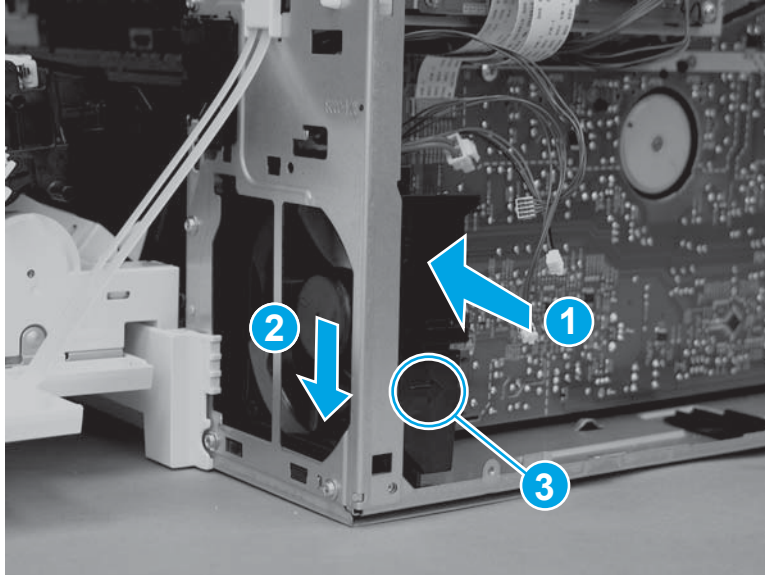

2. Place the wire harnesses in the retainer on the top of the fan bracket.

Figure 1-4691 Place the wire harnesses in the retainer

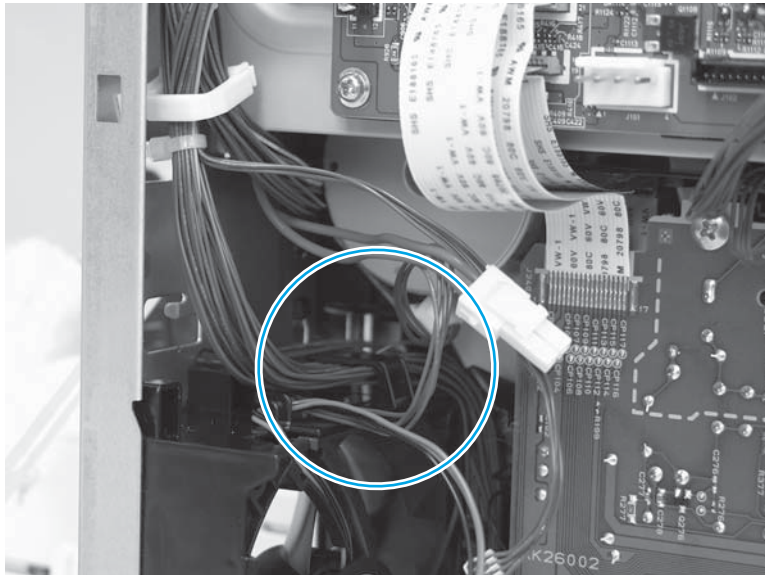

3. Install one screw (callout 1).

Figure 1-4692 Install one screw

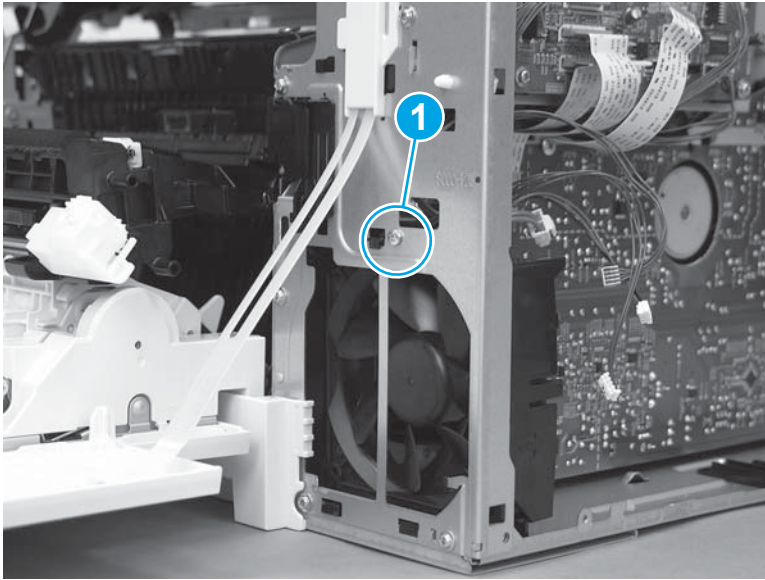

Step 45: Install the LVPS

 **IMPORTANT:** Some figures might show assemblies removed or installed that have not yet been removed or installed at that specific step. However, the procedures are correct for this printer and the target assembly. Always thoroughly read the instructions that accompany each figure.

 **CAUTION:**  ESD-sensitive part.

1. Position the bottom of the LVPS in the printer (callout 1) at a slight angle, and then rotate the top of it into the printer (callout 2) to install it.

Figure 1-4693 Install the LVPS

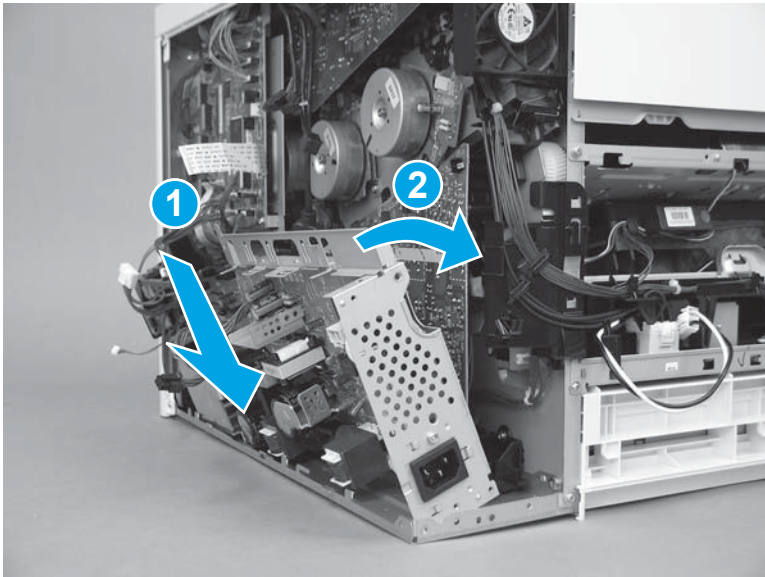

2. Install three screws (callout 1).

Figure 1-4694 Install three screws

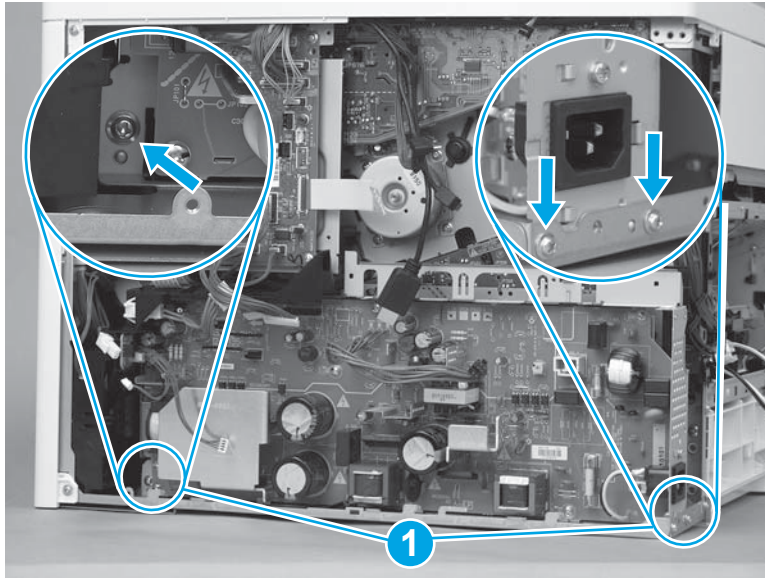

3. Pass the wire harnesses from the DC controller to the LVPS through the opening in the chassis (callout 1), and then install the wire harnesses in the retainer (callout 2).

Figure 1-4695 Pass the wire harnesses through the opening

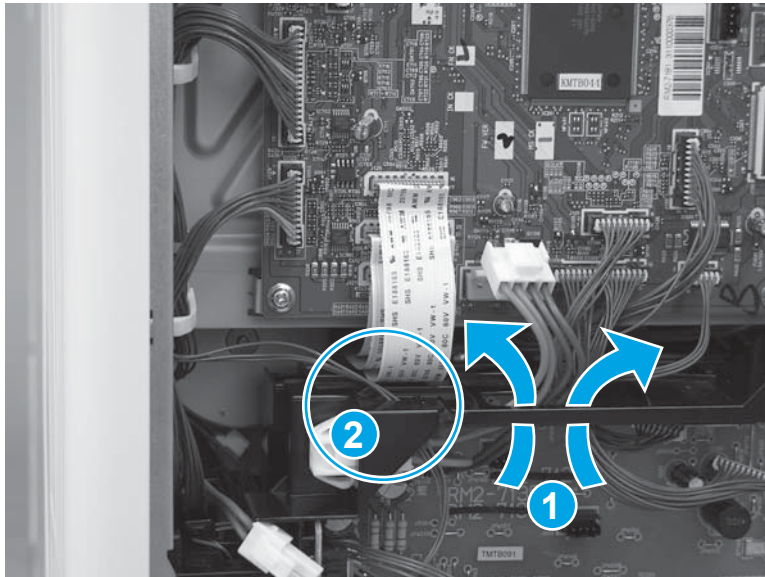

4. Connect three connectors on the DC controller (callout 1), and then connect four connectors (callout 2) on the LVPS.

Figure 1-4696 Connect seven connectors

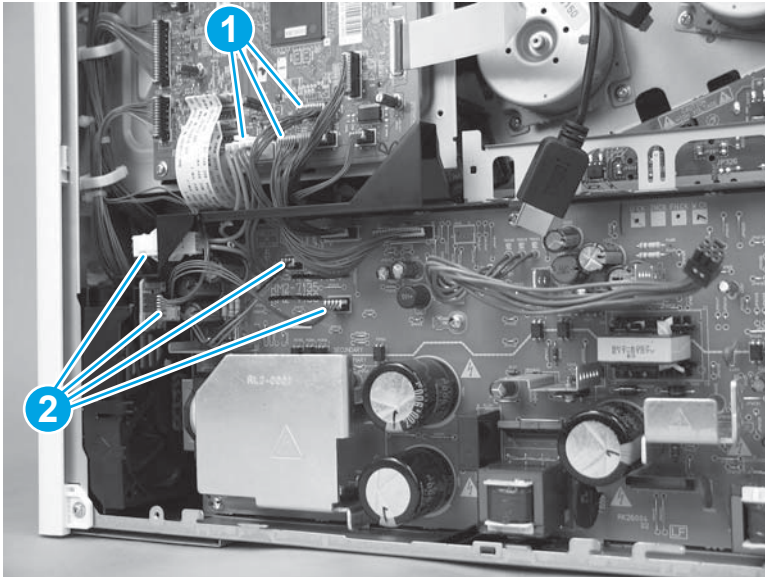

5. Pass the wire harness through the opening (callout 1) in the chassis, and then connect one wire harness (callout 2).

Figure 1-4697 Connect one wire harness

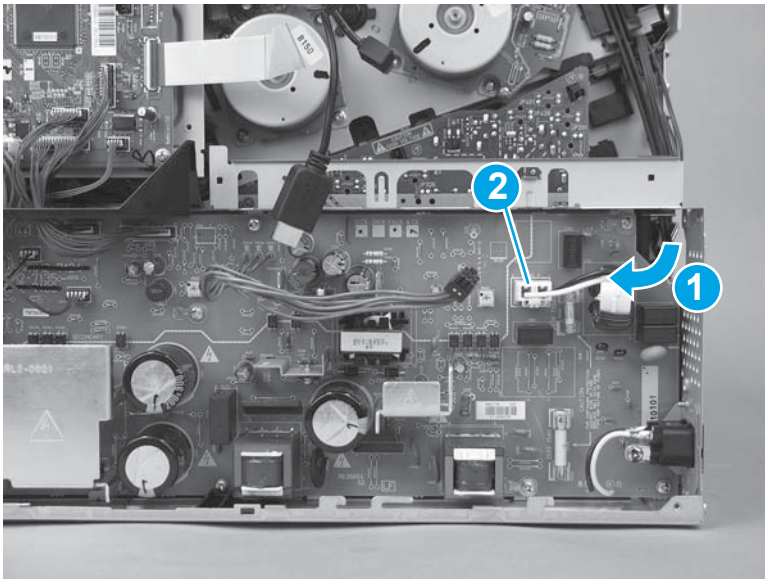

Step 46: Install the right rear cover

1. Position the cover on the printer.

Figure 1-4698 Install the cover

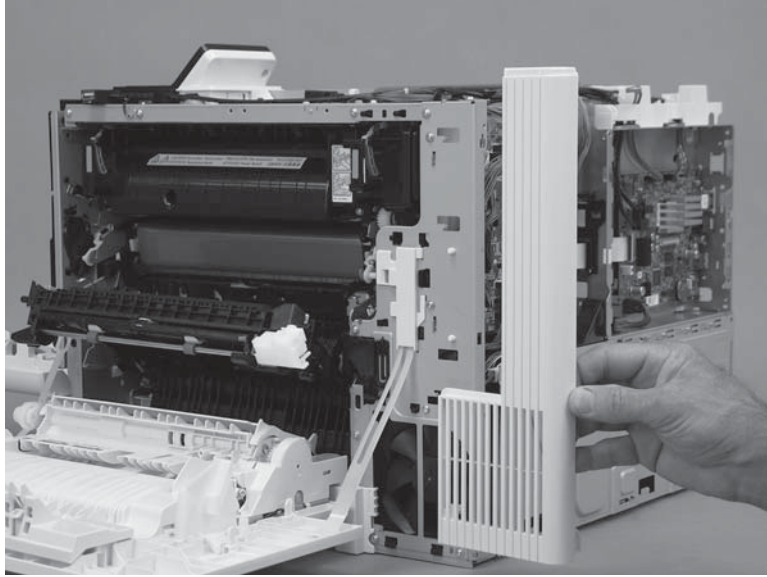

2. Slide the cover toward the right door (callout 1) to engage it with the printer, and then install one screw (callout 2).

Figure 1-4699 Install one screw

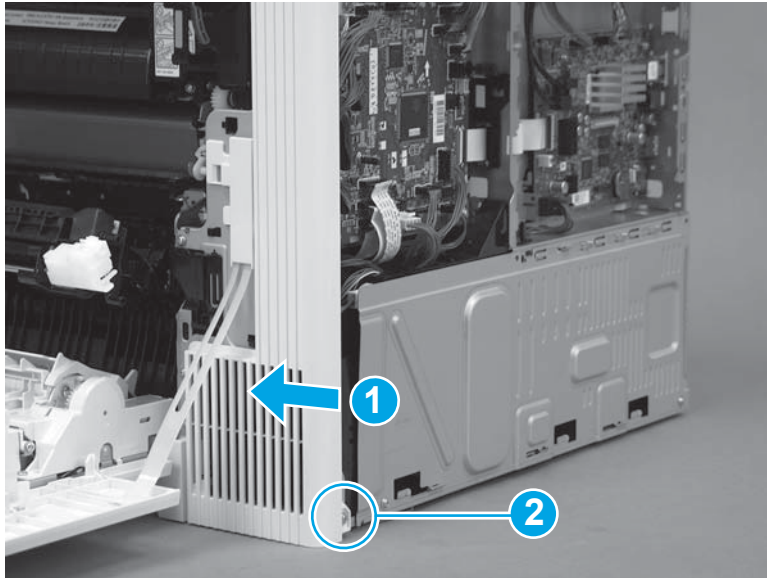

Step 47: Install the formatter case

1. Pass the wire harnesses through the opening in the formatter case.

Figure 1-4700 Pass the wire harnesses through the opening

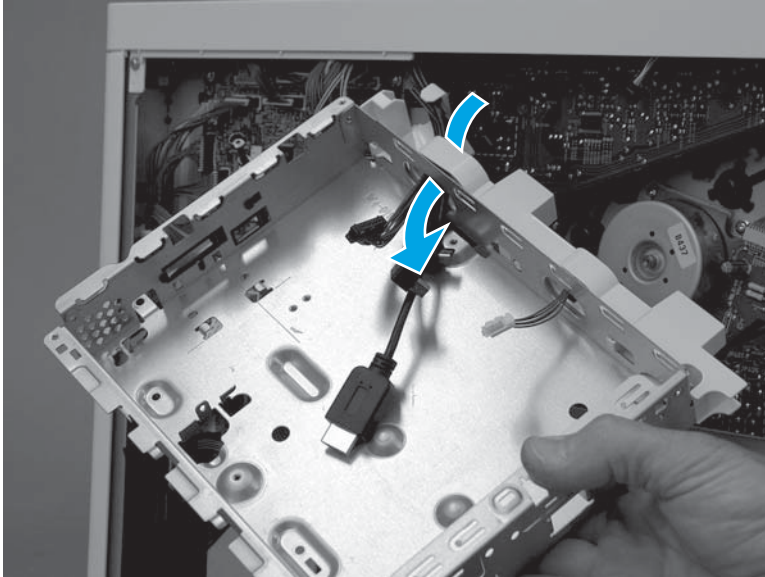

2. Position the top of the formatter case on the printer (callout 1), and then rotate the bottom of the case (callout 2) into the printer.

Figure 1-4701 Install the formatter case

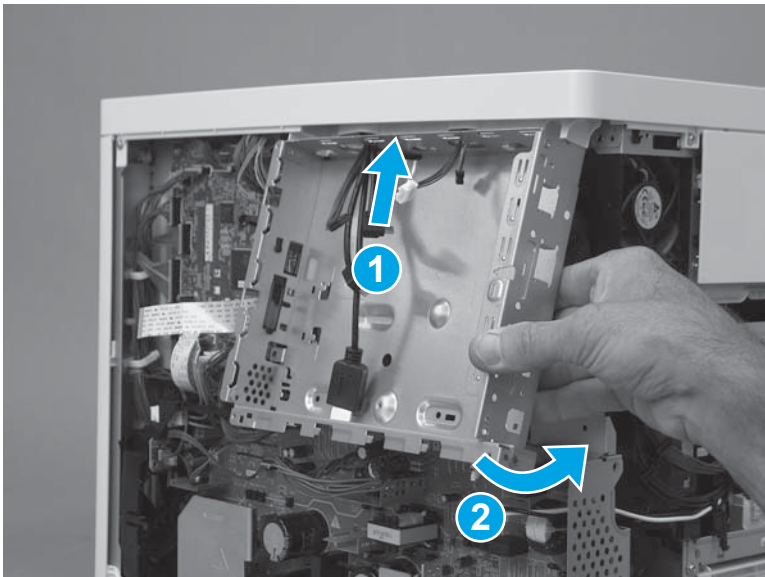

3. Install six screws (callout 1).

Figure 1-4702 Install six screws

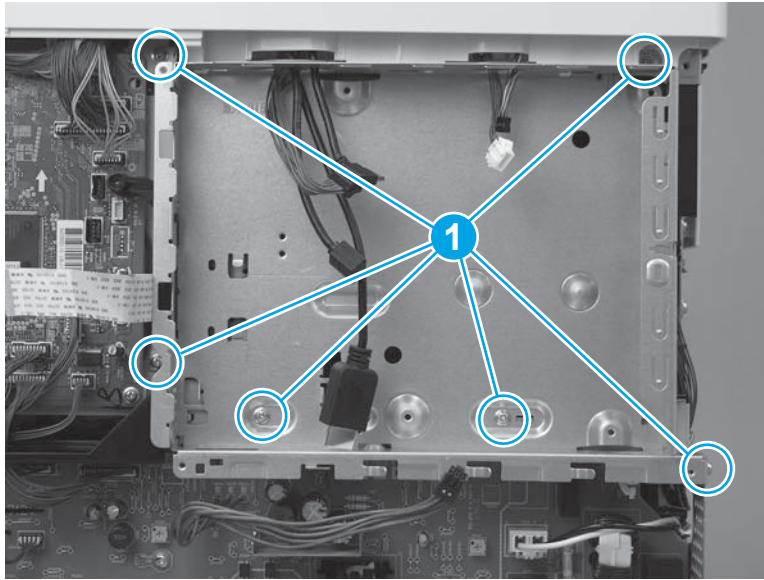

4. Pass two wire harnesses and one flat cable (callout 1) through the opening in the formatter case, and then install one wire harness in the retainer (callout 2).

 **IMPORTANT:** Make sure that the flat cable is securely fastened to the DC controller, and was not dislodged when the formatter case was removed.

Figure 1-4703 Install wire harnesses and flat cable



5. Position the LVPS cover on the printer, slide the cover to the left to install it, and then install two screws (callout 1).

Figure 1-4704 Install the LVPS cover

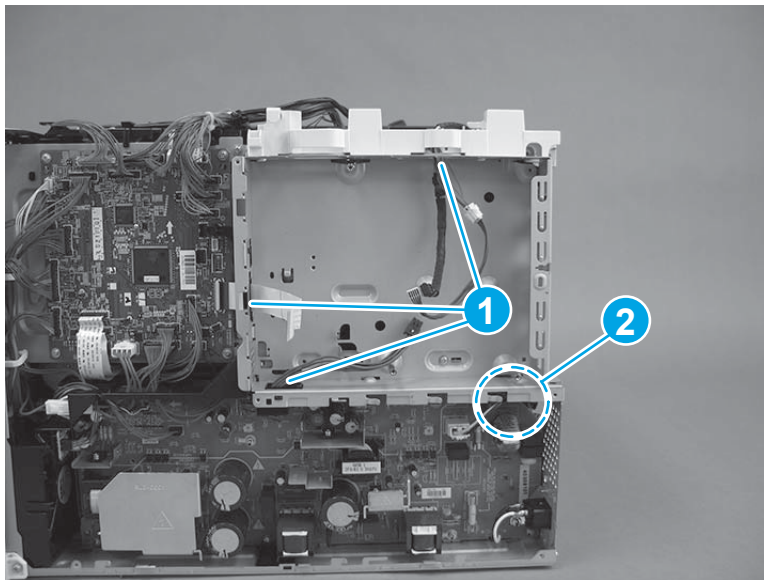
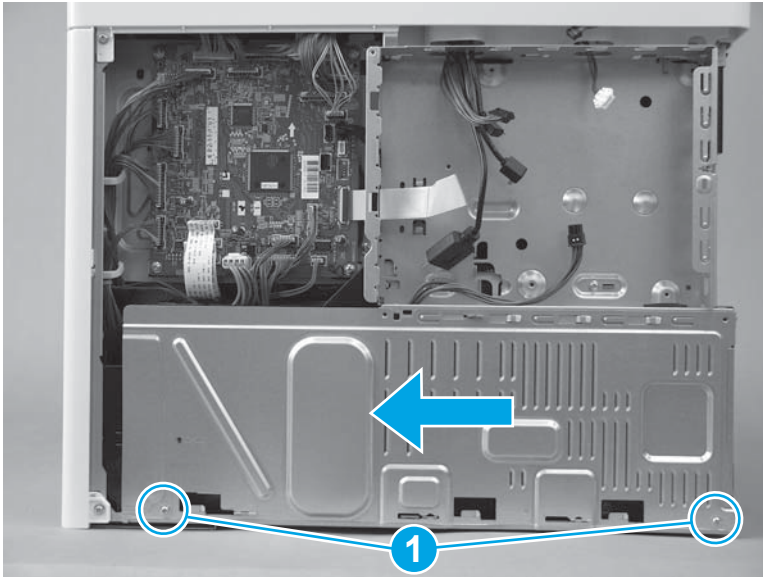

6. If no tape is affixed to the back of the flat cable, skip this step. If double-sided tape is affixed to the back of the flat cable, align the line (callout 1) on the cable with the edge (callout 2) of the opening in the sheet metal. Press to attach the flat cable to the formatter case.

Figure 1-4705 Attach the flat cable

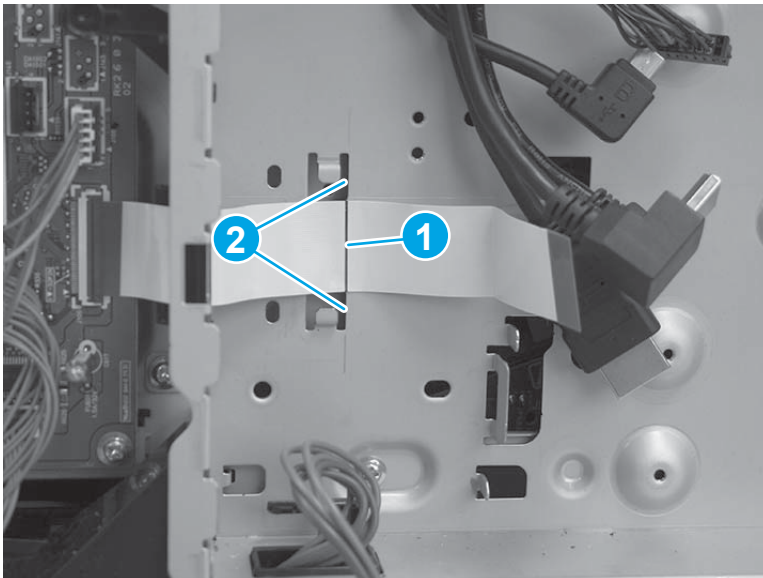

7. Position the bracket over the flat cable, and then slide the bracket to the left to install it. Make sure that the edges of the bracket fit under the sheet metal tabs (callout 1) on the formatter case and that the tabs (callout 2) snap into place.

Figure 1-4706 Position the bracket

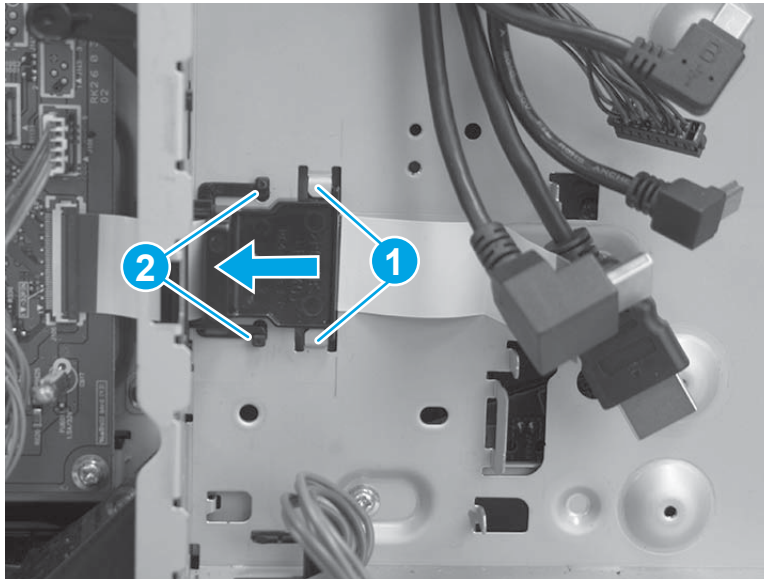

8. **M577 only:** Pass the wire harness (callout 1) through the openings in the formatter case (callout 2), and then connect one connector (callout 3).

Figure 1-4707 Connect one connector

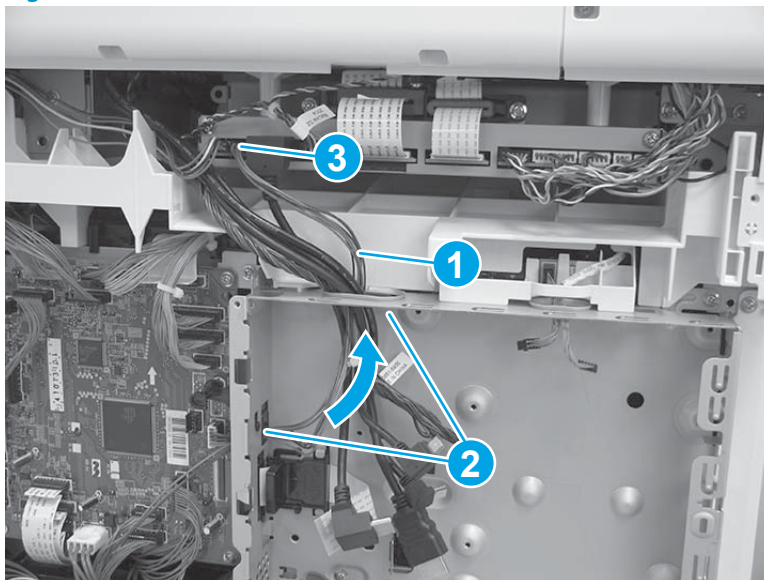

Step 48: Install the upper cover (M552 and M553)

 **NOTE:** This step is for the M552 and M553 models. For the M577 models, skip this step and go to [Step 49: Install the left cover on page 2609](#).

1. Position the cover on the printer.

 **NOTE:** For the M553x model, do not forget to pass the control-panel wire harness and USB cable through the opening in the cover.

Figure 1-4708 Install the cover



2. Push down on the rear corner of the cover to engage one tab (callout 1).

Figure 1-4709 Engage one tab

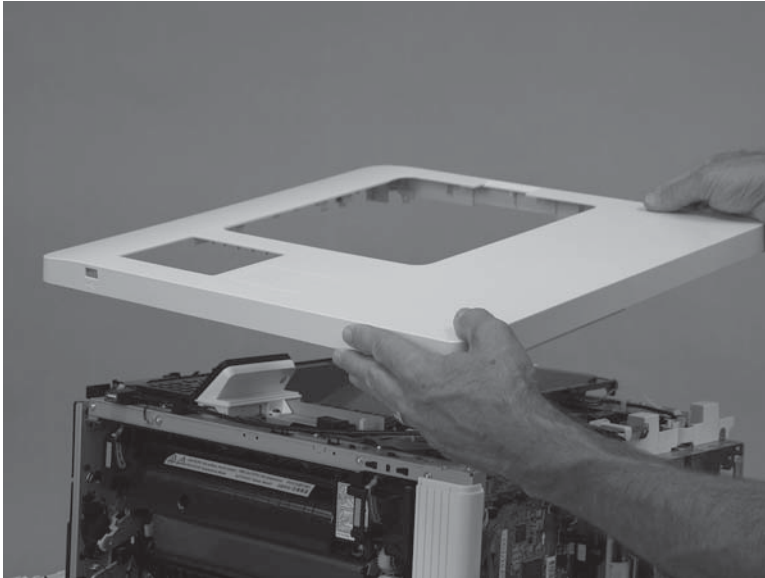
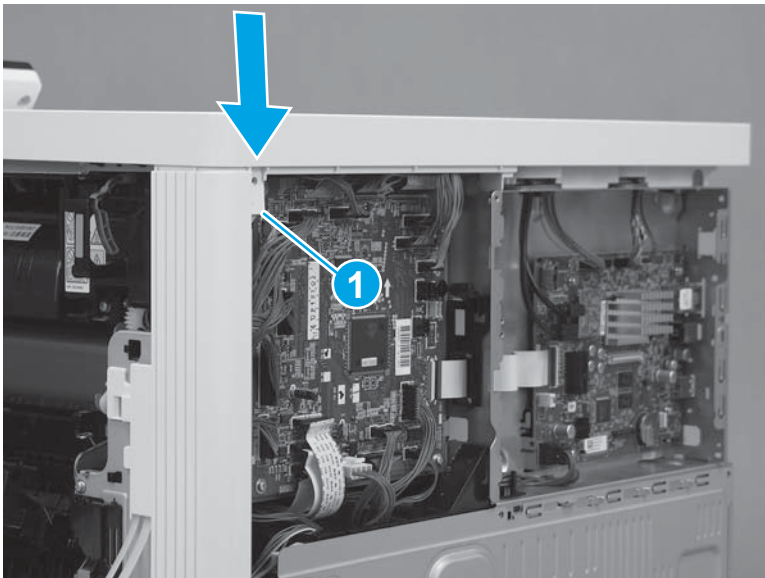

3. Push down on the front corner of the cover to engage one tab (callout 1), and then install one screw (callout 2).

 **NOTE:** This is a self-tapping plastic-thread screw. Make sure that this screw is used in this location when it is reinstalled.

Figure 1-4710 Engage one tab and install one screw



4. Install three screws (callout 1).

Figure 1-4711 Install three screws

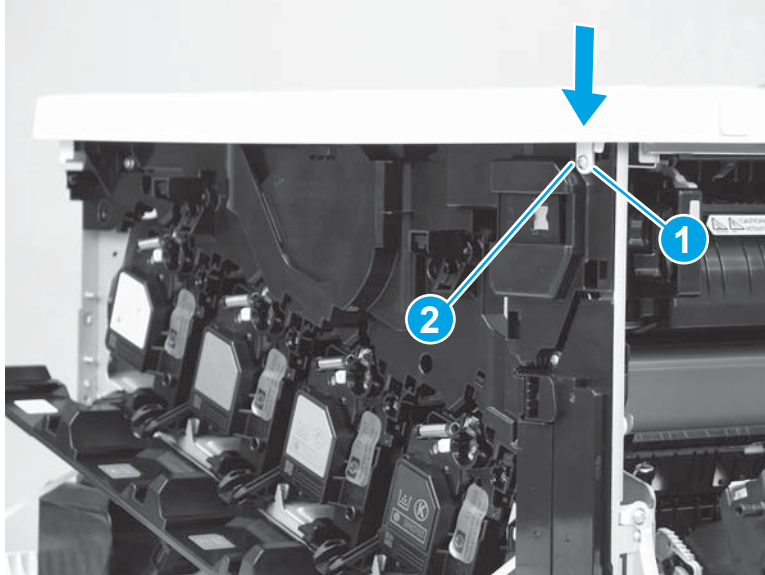
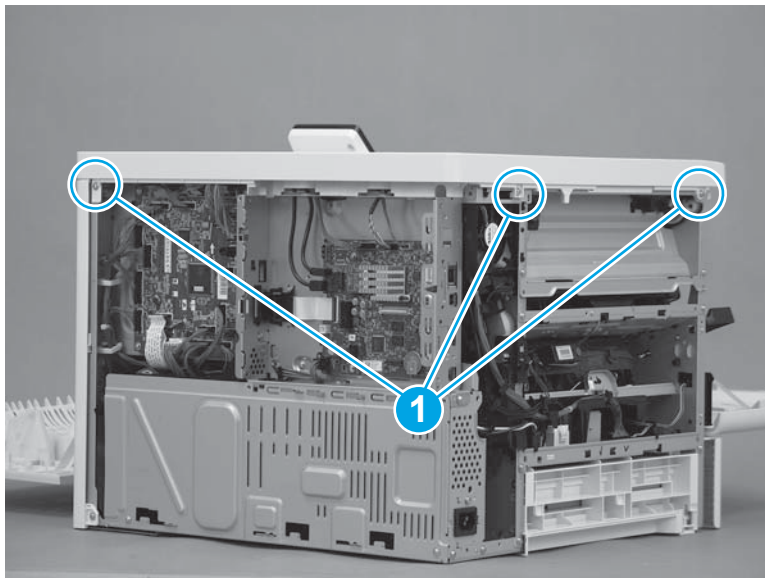

Step 49: Install the left cover

1. Position the cover on the printer.

 **NOTE:** Slightly offset the cover toward the rear of the printer.

Figure 1-4712 Install the cover

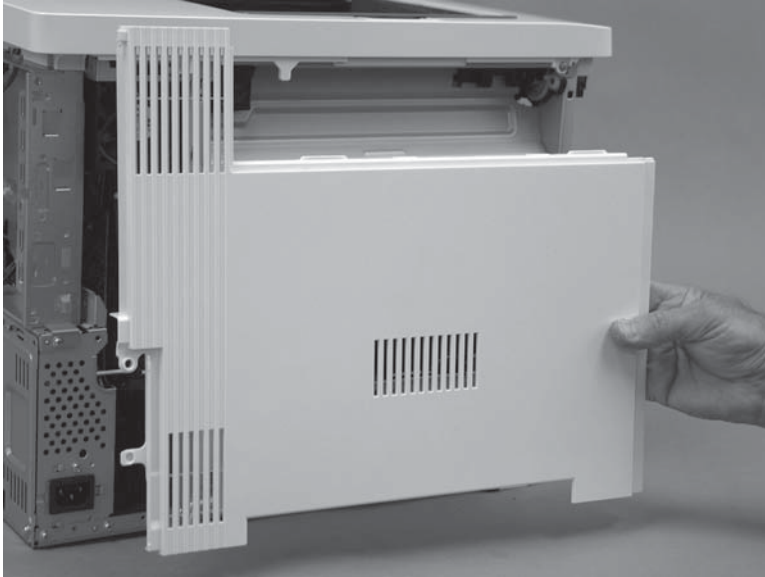

2. Slide the cover (callout 1) toward the front of the printer to engage it. Make sure that the tab (callout 2) snaps into place.

 **NOTE:** Locate the alignment pin (callout 3) on the cover from the front door side of the printer, and then make sure that it is fully engaged in the slot in the chassis.

 **TIP:** While sliding the cover into place, push in on the center of the cover (callout 1) to make sure that the hooks on the back of the cover engage with the slots in the chassis.

Figure 1-4713 Engage the cover



3. At the left side of the printer, install one screw (callout 1).

Figure 1-4714 Install one screw

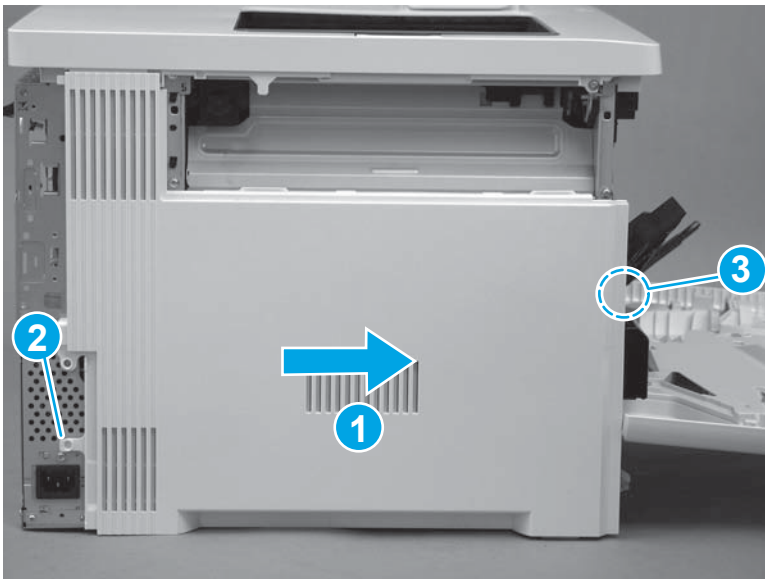

Step 50: Install the top bracket (M577)

 **NOTE:** This step is for the M577 models. For the M552 and M553 models, skip this step and go to [Step 62: Install the rear cover \(M552 and M553\) on page 2633](#).

1. Position the tabs (callout 1) on the bracket in the slots (callout 2) in the printer.

Figure 1-4715 Position the tabs in the slots

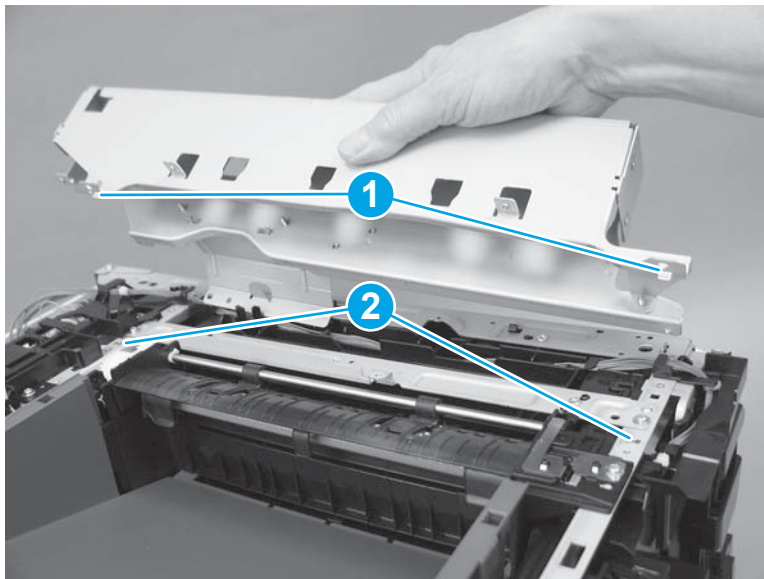

2. At the top of the printer, install two screws (callout 1).

Figure 1-4716 Install two screws

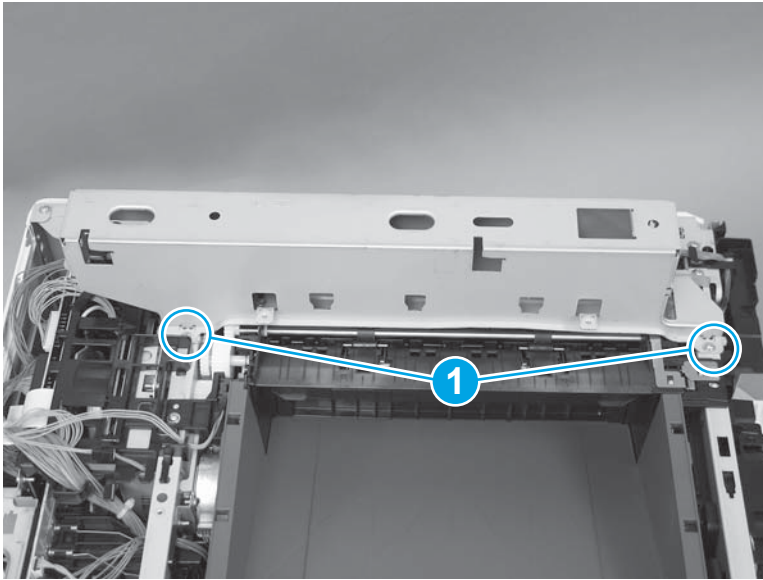

3. At the top of the printer, install three screws (callout 1).

Figure 1-4717 Install three screws

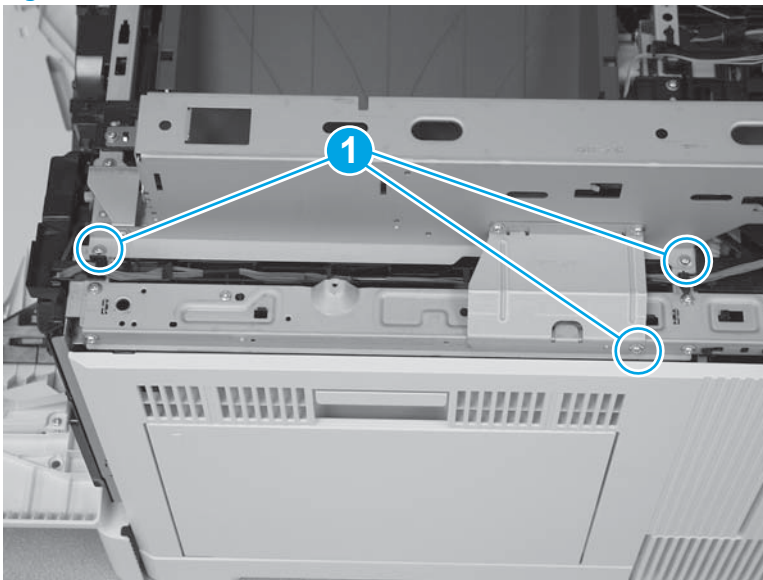

Step 51: Install the top cover (M577)



NOTE: This step is for the M577 models. For the M552 and M553 models, skip this step and go to [Step 62: Install the rear cover \(M552 and M553\) on page 2633](#).

1. Position the locator pins (callout 1) on the cover in the slots (callout 2) in the printer.

Figure 1-4718 Position the locator pins

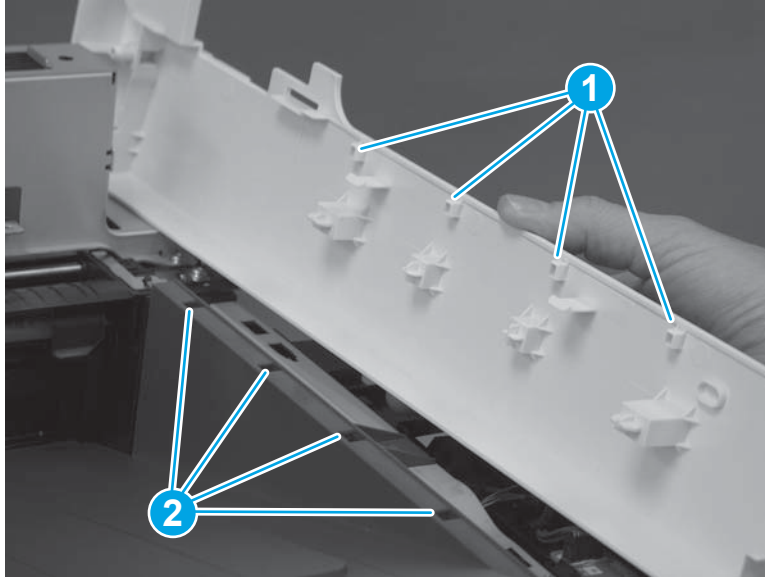

2. Press down on the cover to install it. Make sure that the tabs (callout 1) snap into place.

Figure 1-4719 Press down on the cover

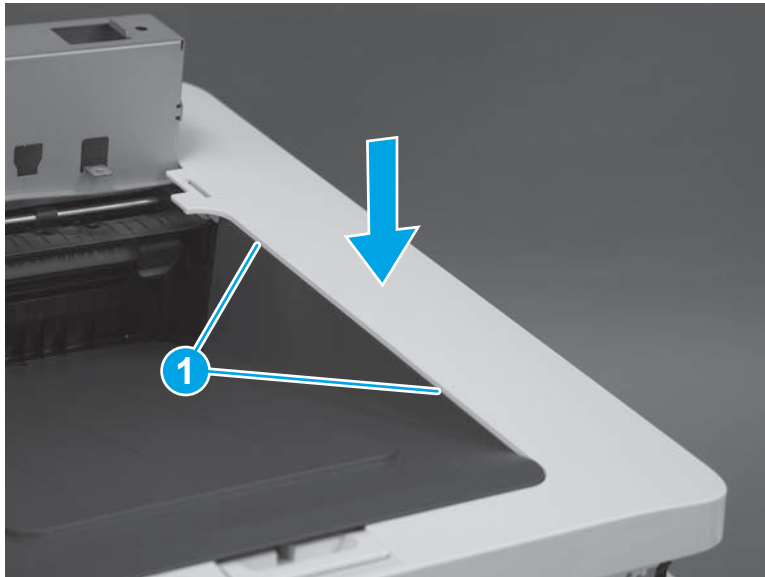

3. At the front of the printer, install one screw (callout 1).

 **Reinstallation tip:** This screw is longer and a different type of screw than the screw installed in the next step. Make sure that this screw is installed in the correct position.

Figure 1-4720 Install one screw



4. At the left side of the printer, install one screw (callout 1).

Figure 1-4721 Install one screw

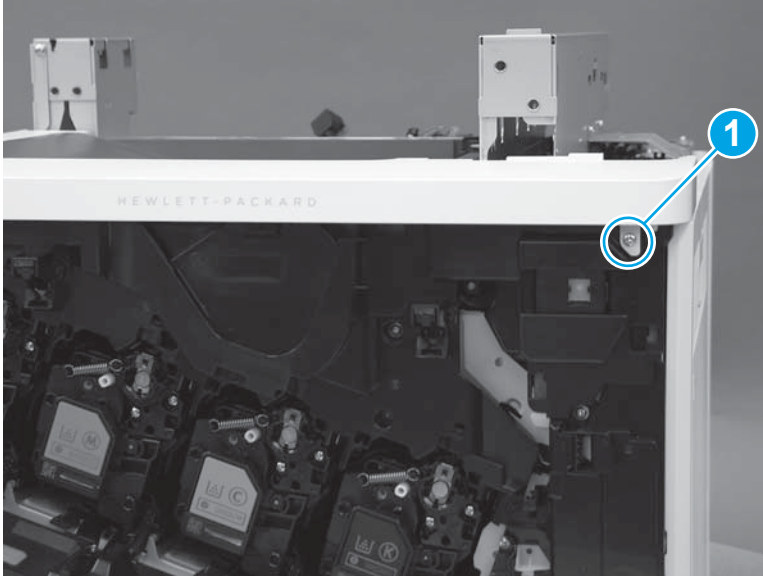
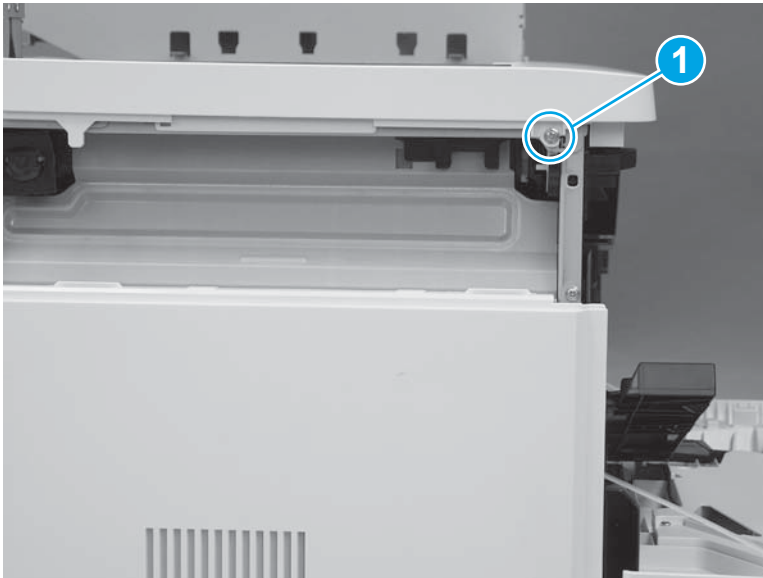

Step 52: Install the paper feed cover (M577)

 **NOTE:** This step is for the M577 models. For the M552 and M553 models, skip this step and go to [Step 62: Install the rear cover \(M552 and M553\) on page 2633](#).

1. Position the locator tabs (callout 1) on the cover in the slots (callout 2) in the printer. Press down until the cover snaps into place.

Figure 1-4722 Install the cover

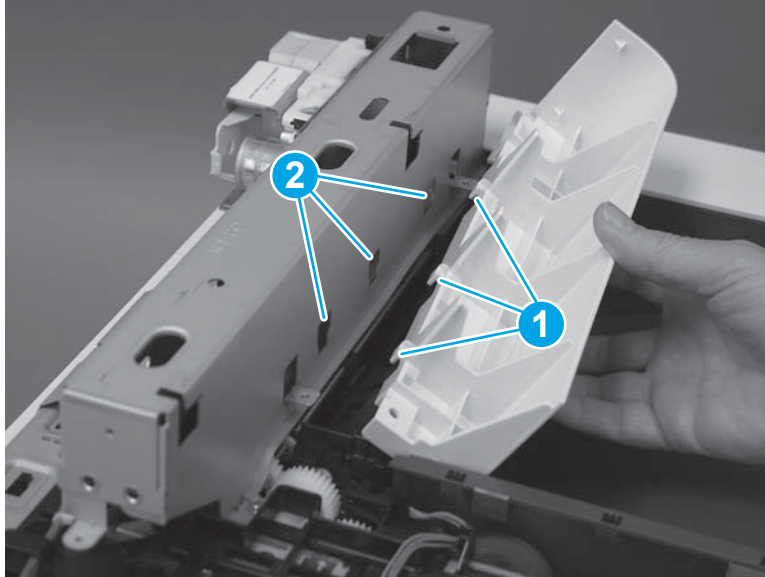

2. Install one screw (callout 1).

Figure 1-4723 Install one screw

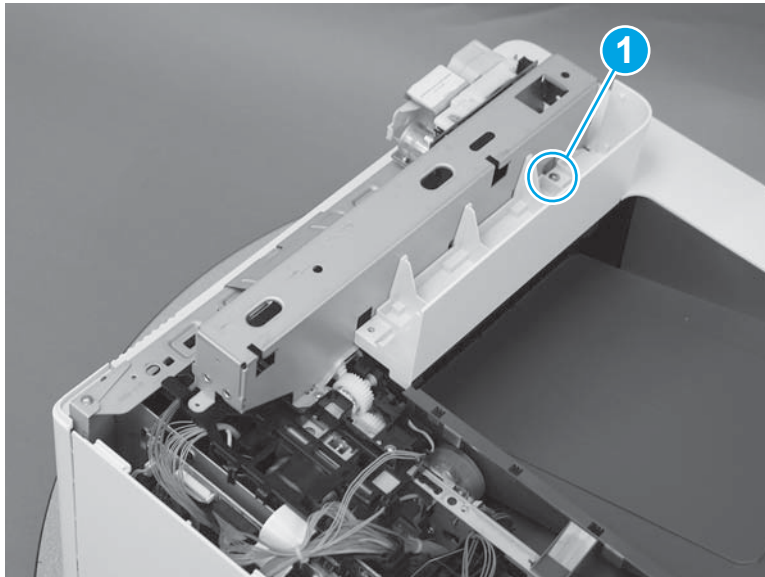

Step 53: Install the top rear cover (M577)

 **NOTE:** This step is for the M577 models. For the M552 and M553 models, skip this step and go to [Step 62: Install the rear cover \(M552 and M553\) on page 2633](#).

1. Align the locator tabs (callout 1) on the cover with the slots (callout 2) in the printer.

Figure 1-4724 Align the locator tabs

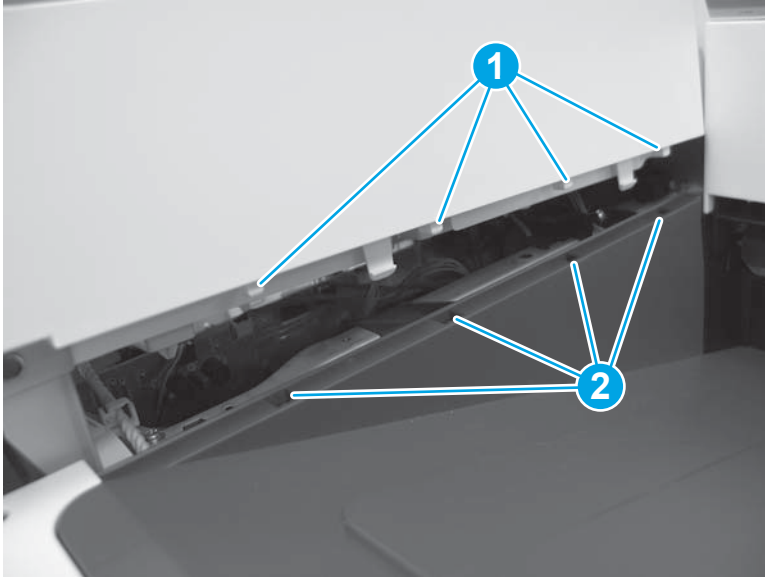

2. Press down to install the cover. Make sure that the tabs snap into place.

Figure 1-4725 Install the cover

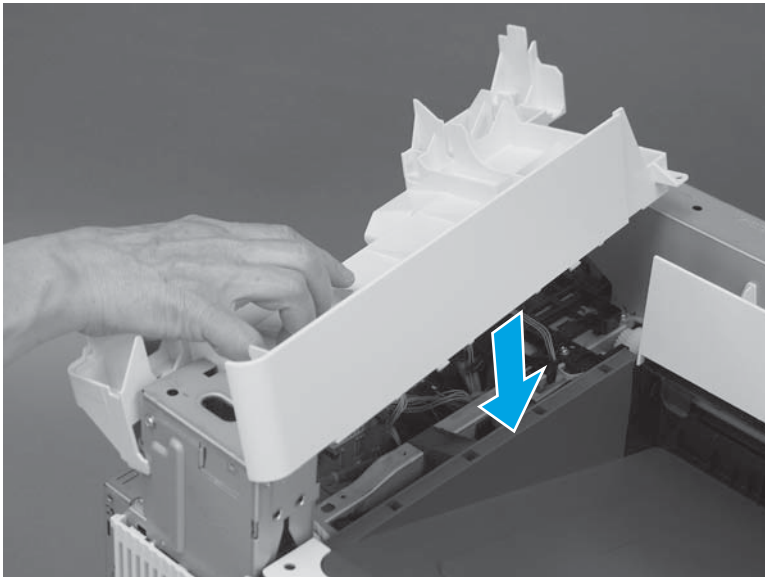

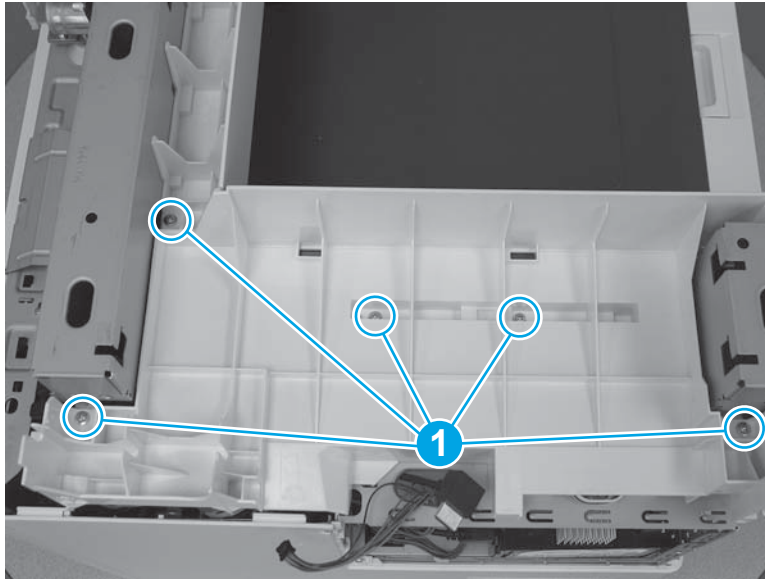

3. At the top of the printer, install five screws (callout 1).

Figure 1-4726 Install five screws



Step 54: Install the right upper cover (M577)

 **NOTE:** This step is for the M577 models. For the M552 and M553 models, skip this step and go to [Step 62: Install the rear cover \(M552 and M553\) on page 2633](#).

 **NOTE:** The figures below show the image scanner installed. The procedures for removing and installing the right upper cover are the same whether the image scanner is installed or removed."

1. **M577c/f/z only:** Install the cables (callout 1) through the slot (callout 2) in the printer.

Figure 1-4727 Install the cables

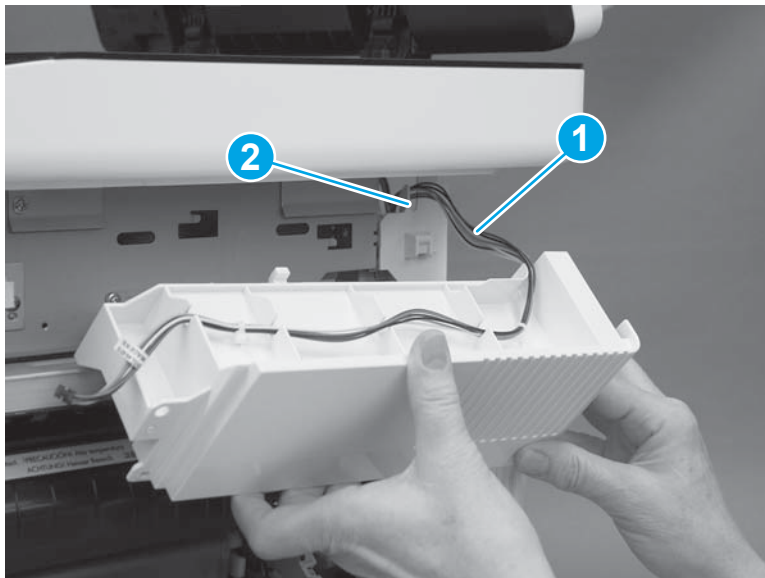

2. Position the hooks (callout 1) on the cover in the slots (callout 2) in the printer.

Figure 1-4728 Position the hooks

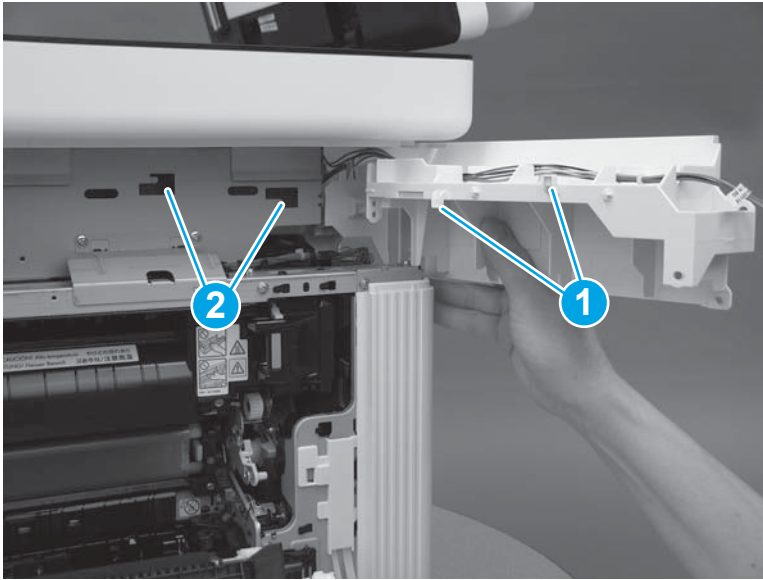

3. Slide the cover toward the front of the printer to install it.

Figure 1-4729 Install the cover

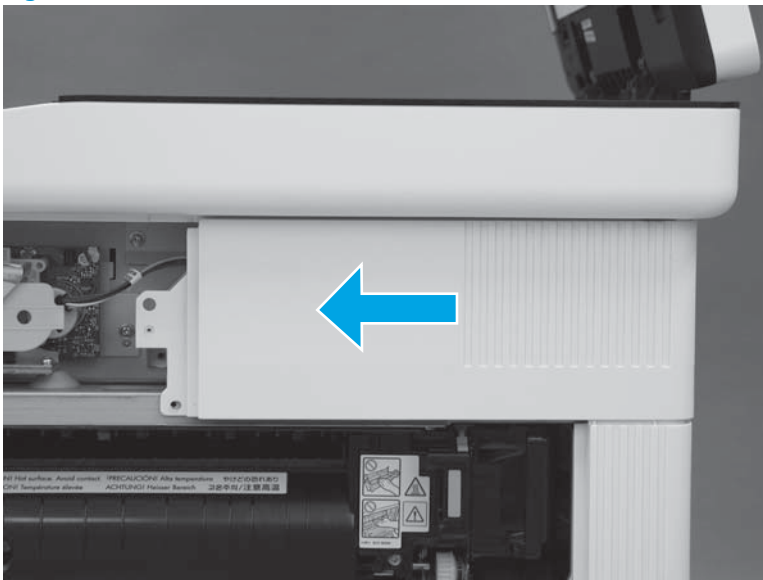

4. At the back of the printer, install one screw (callout 1).

M577c/f/z only: Connect one connector (callout 2), if the integrated scanner assembly is installed.

 **TIP:** This screw is smaller than the screws installed in the next step. Make sure that this screw is installed in the correct position.

Figure 1-4730 Install one screw and connector



5. At the right side of the printer, install two screws (callout 1).

M577c/f/z only: Connect one connector (callout 2), if the stapler is installed.

Figure 1-4731 Install one screw and connector

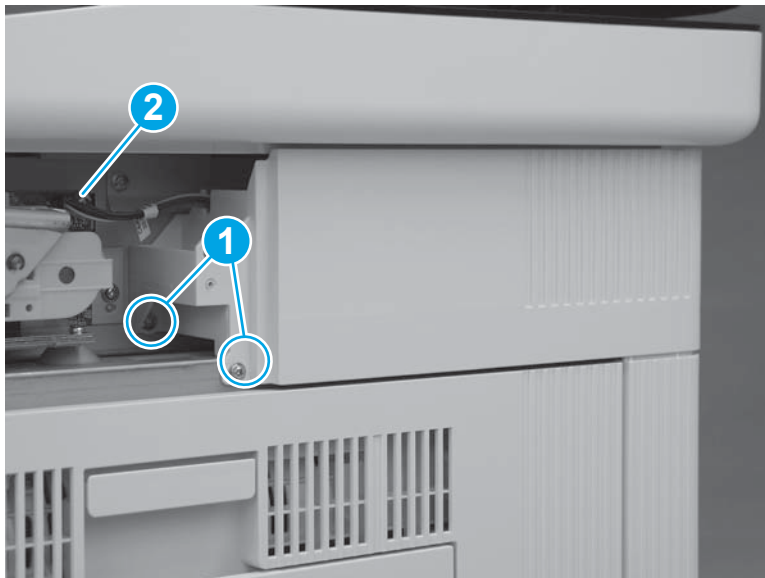

Step 55: Install the stapler unit (M577c/f/z)

 **NOTE:** This step is for the M577c/f/z models. For the M577dn model, skip this step and go to [Step 56: Install the integrated scanner assembly \(ISA\) \(M577\) on page 2621](#).

For the M552 and M553 models, skip this step and go to [Step 62: Install the rear cover \(M552 and M553\) on page 2633](#).

1. Position the hooks (callout 1) on the stapler unit in the slots (callout 2) in the printer.

Figure 1-4732 Position the hooks in the slots

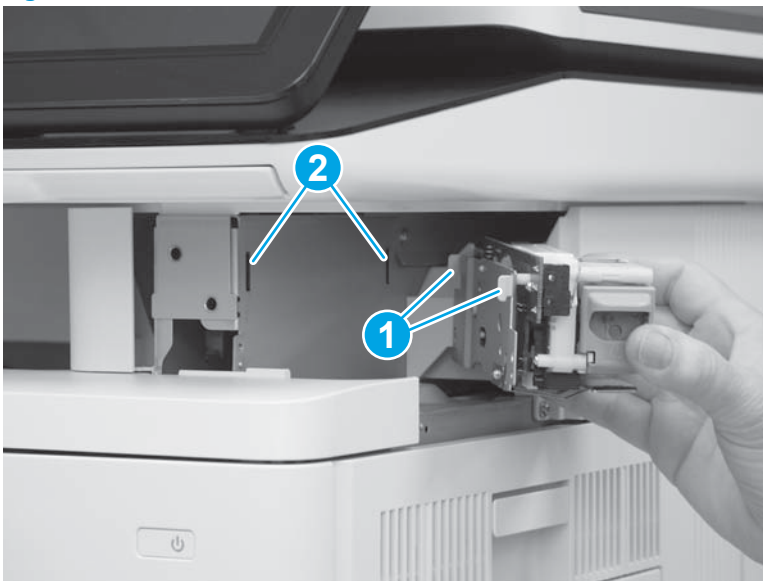

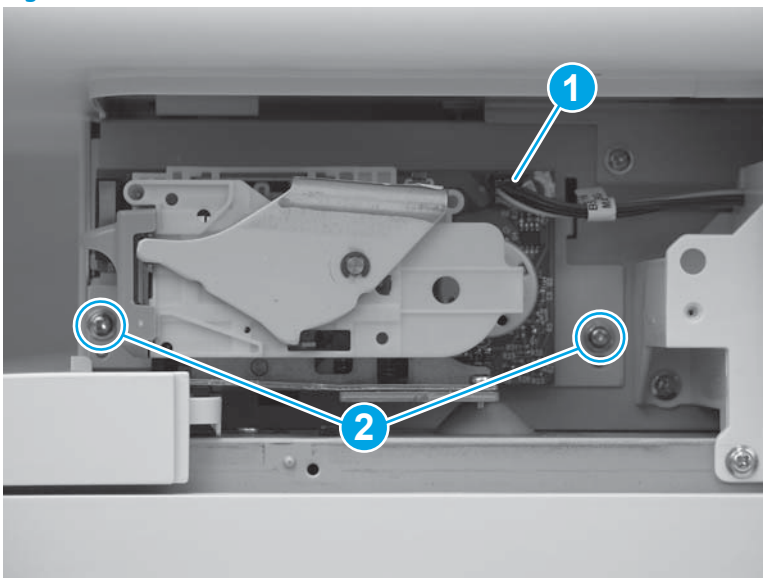

2. Connect one connector (callout 1), and then install two screws (callout 2).

Figure 1-4733 Connect connector and install screws



Step 56: Install the integrated scanner assembly (ISA) (M577)

 **NOTE:** This step is for the M577 models. For the M552 and M553 models, skip this step and go to [Step 62: Install the rear cover \(M552 and M553\) on page 2633](#).

 **NOTE:** The ISA includes the document feeder, image scanner, scanner control board (SCB), control panel, keyboard (M577c/z) and NFC PCA (M577z).

1. Before proceeding, locate the mounting pins (callout 1) on the bottom of the ISA and the slots (callout 2) on the printer base.

Figure 1-4734 Locate the ISA mounting pins and slots

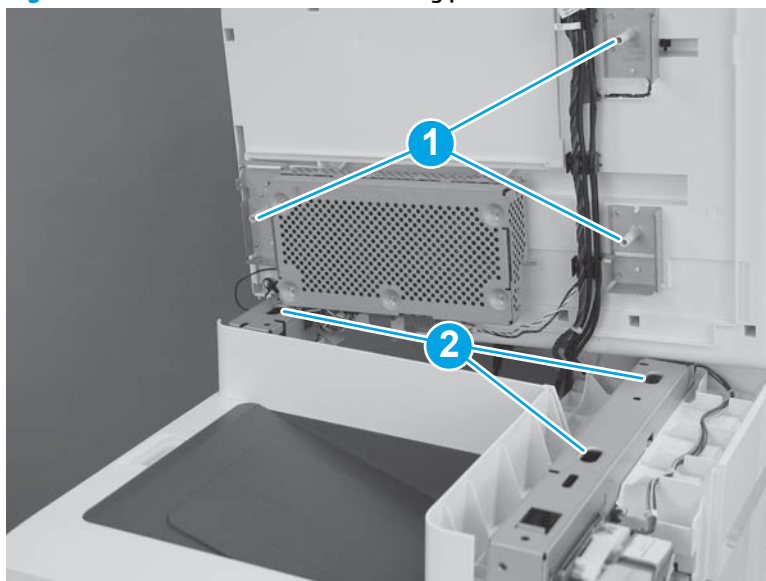

2. Position the ISA on the printer base with the pins in the slots.

 **NOTE:** To locate the pins and slots, see [Figure 1-395 Locate the ISA mounting pins and slots on page 250](#).

When installing the ISA, carefully pass the cables through the opening in the top of the formatter case.

Figure 1-4735 Install the ISA

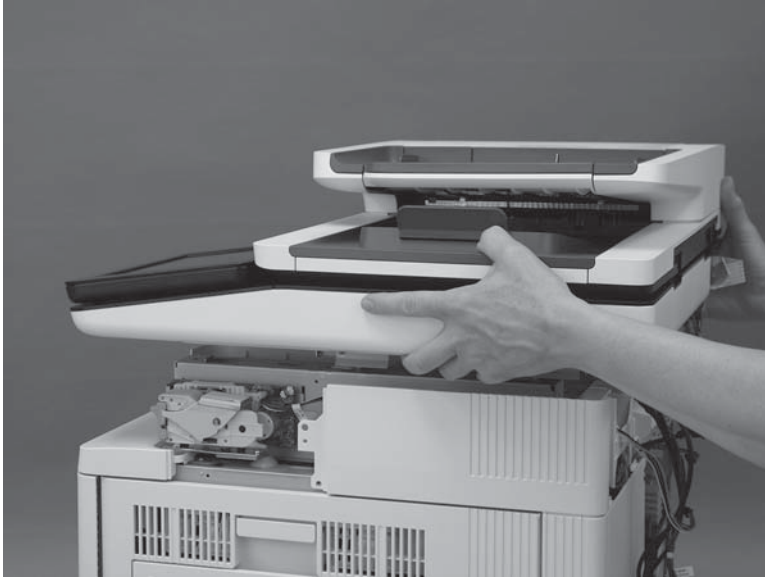

3. Slightly slide the ISA towards the front of the printer to engage it.

Figure 1-4736 Slide the ISA towards the front of the printer

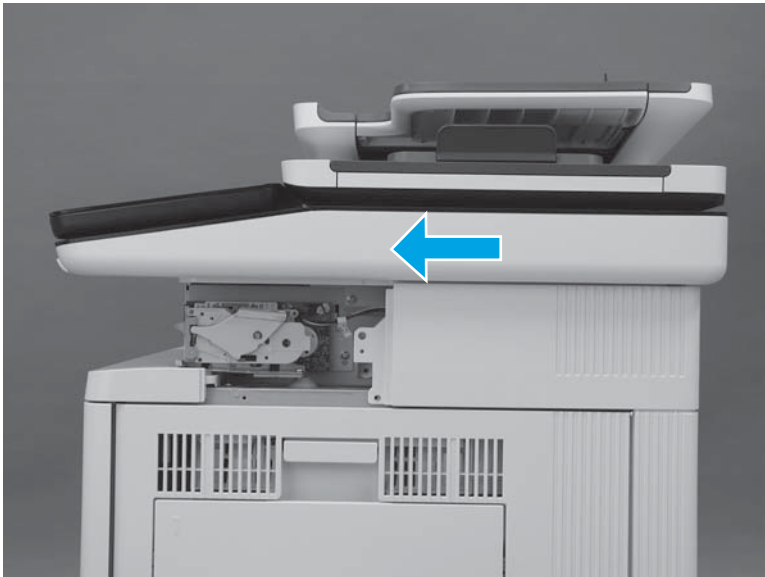

4. At the left side of the printer, install one screw (callout 1).

Figure 1-4737 Install one screw

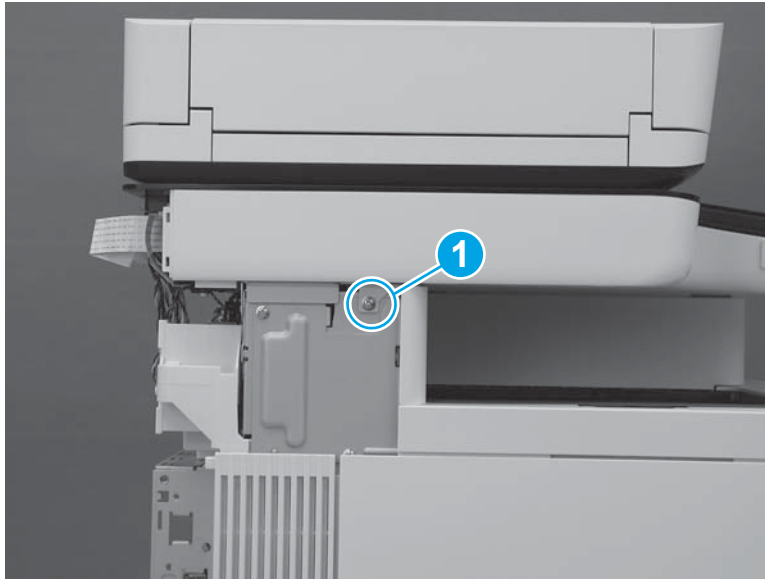

5. At the back of the printer, install two screws (callout 1).

Figure 1-4738 Install two screws

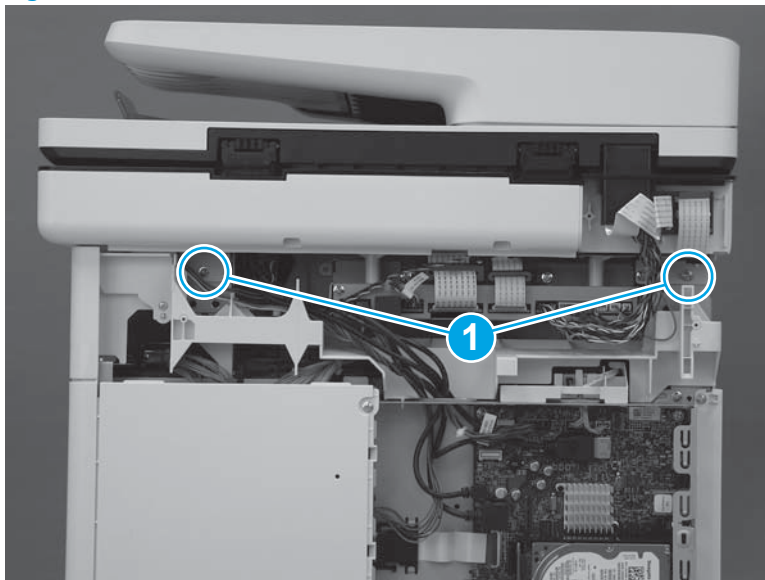

6. At the right side of the printer, install one screw (callout 1).

Figure 1-4739 Install one screw

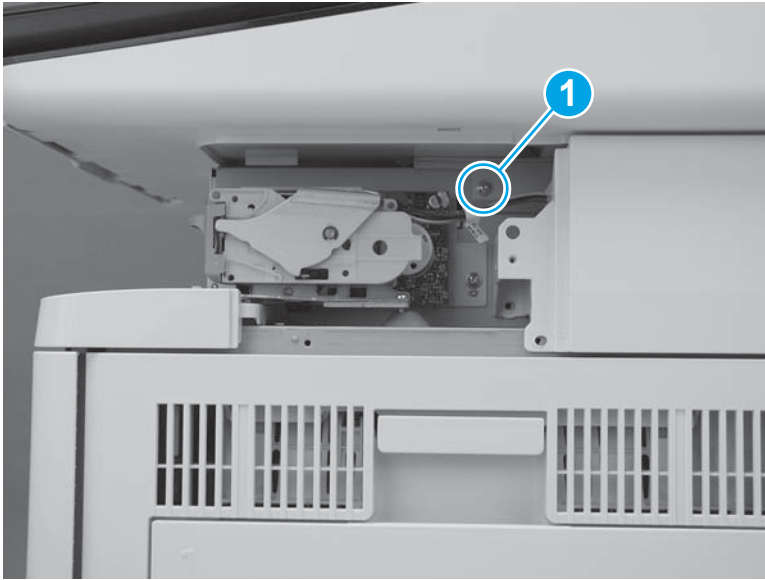

7. Connect two connectors on the scanner control board (callout 1).

M577c/f/z only: Connect one connector for the stapler on the scanner control board (callout 2).

Figure 1-4740 Connect connectors

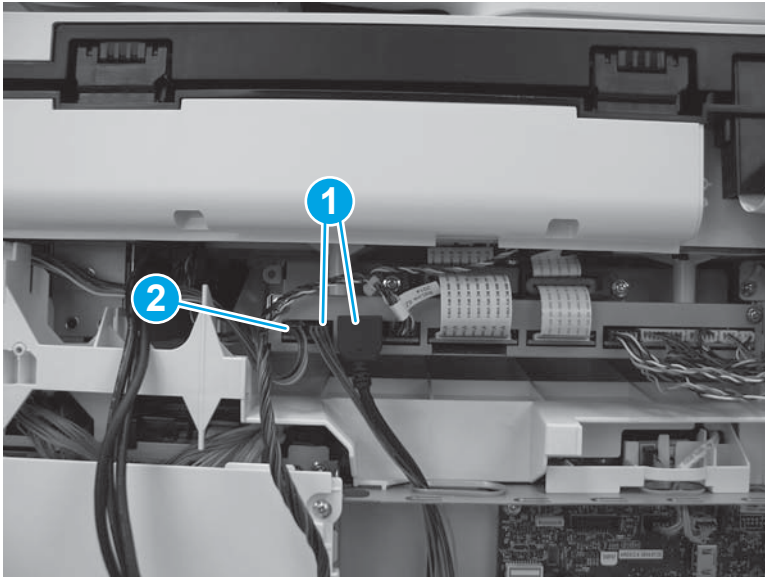

Step 57: Install the stapler cover assembly (M577c/f/z)

 **NOTE:** This step is for the M577c/f/z models only. For the M577dn model, skip this step and go to [Step 58: Install the right front upper cover \(M577dn\) on page 2626](#).

For the M552 and M553 models, skip this step and go to [Step 62: Install the rear cover \(M552 and M553\) on page 2633](#).

1. Install the tabs (callout 1) on the cover in the slots (callout 2) in the printer.

Figure 1-4741 Install two tabs



2. Press the cover toward the left side of the printer until it snaps into place.

Figure 1-4742 Install the cover assembly



3. Install one screw (callout 1).



 **IMPORTANT:** This is a self-tapping screw for plastic. Rotate it counterclockwise to align it with the existing thread pattern, and then carefully turn it clockwise to tighten. Do not overtighten. This will prevent stripping the threads inside the screw hole.

Figure 1-4743 Install one screw

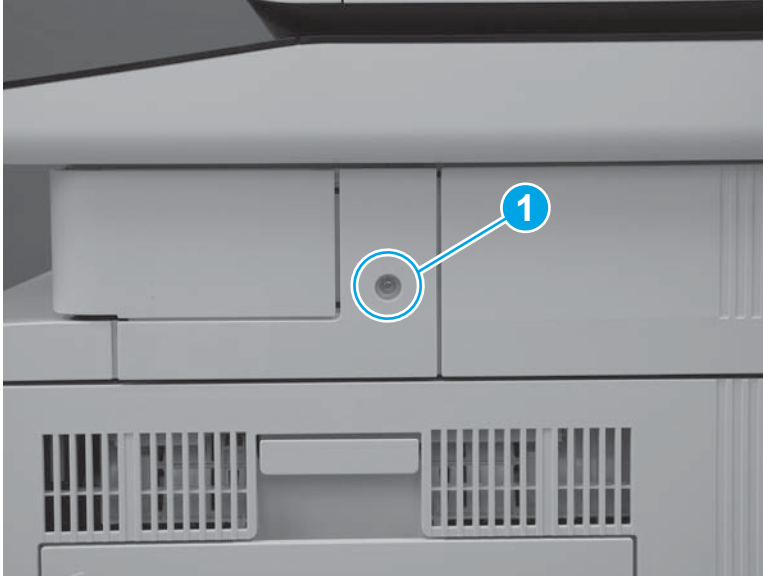

Step 58: Install the right front upper cover (M577dn)

 **NOTE:** This step is for the M577dn model only. For the M577c/f/z models, skip this step and go to [Step 59: Install the left upper cover \(M577\) on page 2628](#).

For the M552 and M553 models, skip this step and go to [Step 62: Install the rear cover \(M552 and M553\) on page 2633](#).

1. Slide the cover toward the left side of the printer to install it. Make sure that the slots (callout 1) in the cover fit over the tabs (callout 2) on the inside of the paper feeder cover.

Figure 1-4744 Install the cover



2. Press the right front upper cover (callout 1) and the paper feeder cover (callout 2) together until the tabs on the inside of the covers snap into place.

Figure 1-4745 Press the cover



3. Install one screw (callout 1).

Figure 1-4746 Install one screw

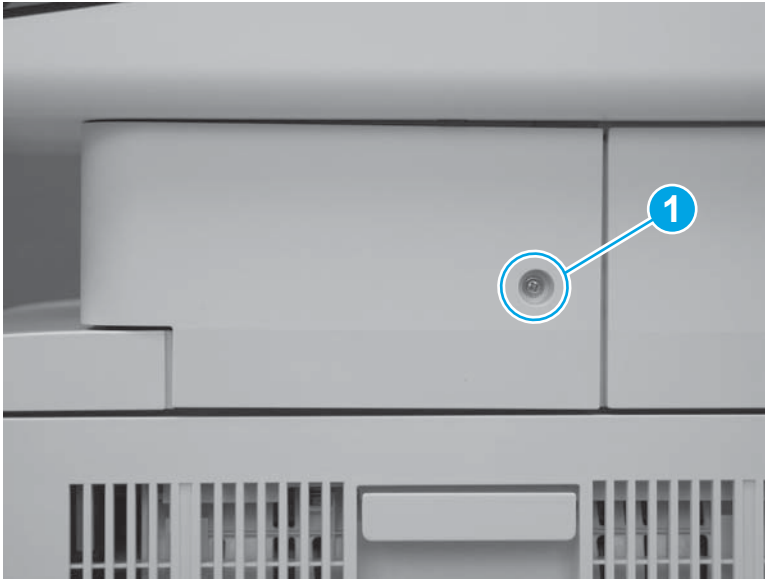

Step 59: Install the left upper cover (M577)



NOTE: This step is for the M577 models. For the M552 and M553 models, skip this step and go to [Step 62: Install the rear cover \(M552 and M553\) on page 2633](#).

1. Position the tab (callout 1) on the lower edge of the cover behind the left cover (callout 2).

Figure 1-4747 Position the tab

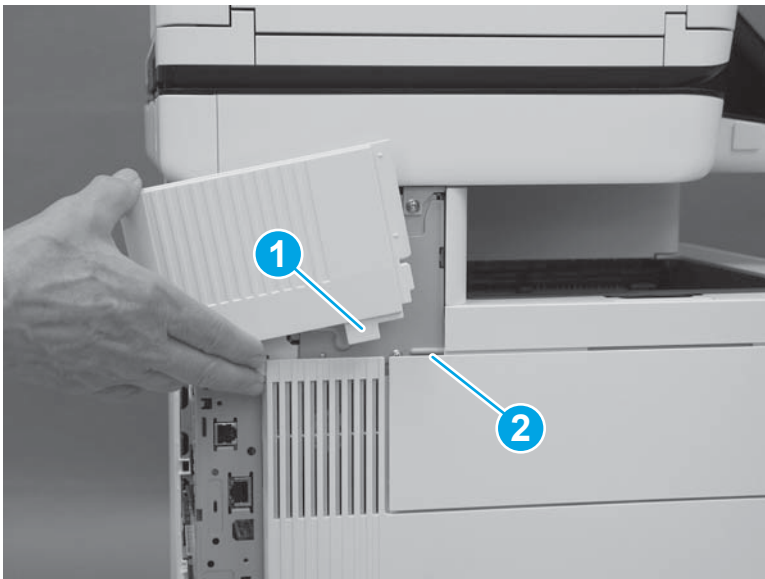

2. Slide the cover toward the front of the printer to install it. Make sure that the edge (callout 1) of the cover fits behind the edge (callout 2) of the top rear cover.

Figure 1-4748 Slide the cover

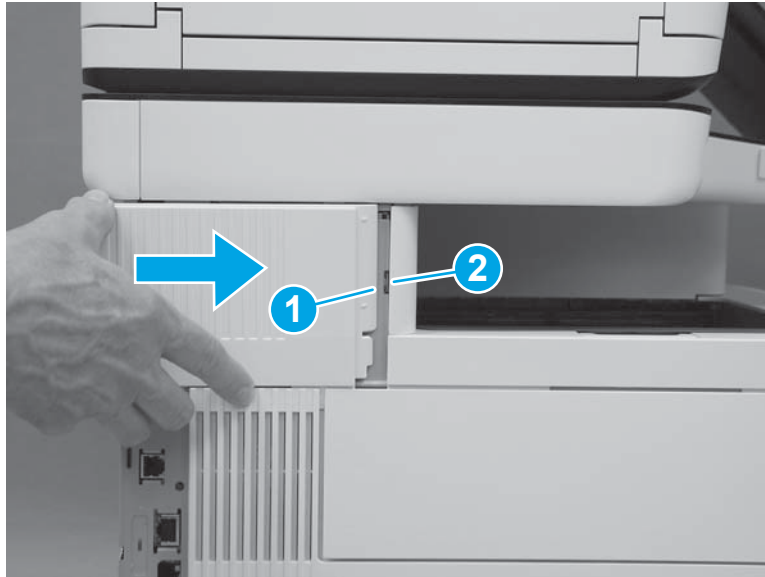

3. Make sure that the tab (callout 1) is fully installed.

Figure 1-4749 Check the tab

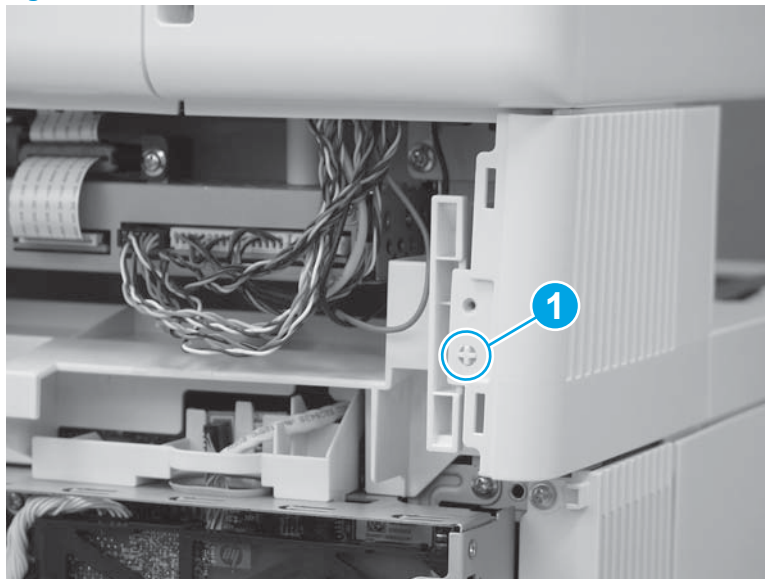

Step 60: Install the rear cover (M577)

 **NOTE:** This step is for the M577 models. For the M552 and M553 models, skip this step and go to [Step 62: Install the rear cover \(M552 and M553\) on page 2633](#).

1. Position the hooks (callout 1) on the cover in the slots (callout 2) in the printer.

Figure 1-4750 Position the hooks

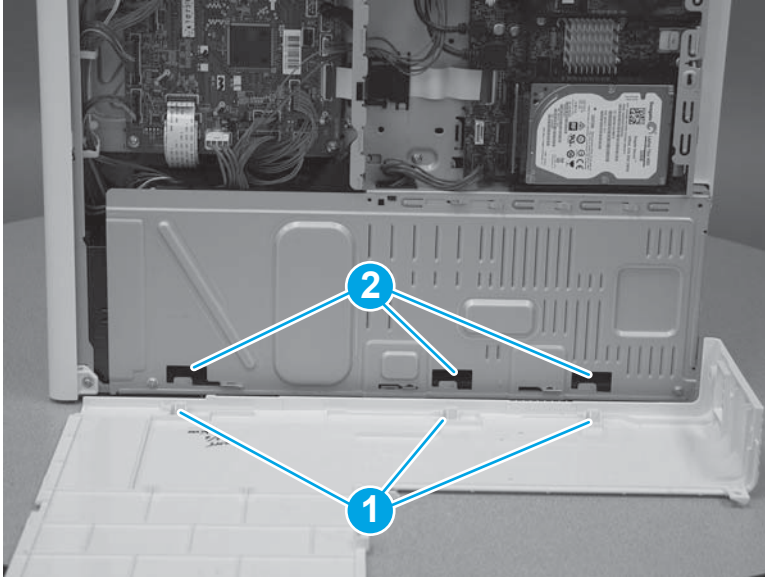

2. Position the back edge (callout 1) of the rear cover behind the edge (callout 2) of the right rear cover. Slide the cover to the left to install it.

Figure 1-4751 Install the cover

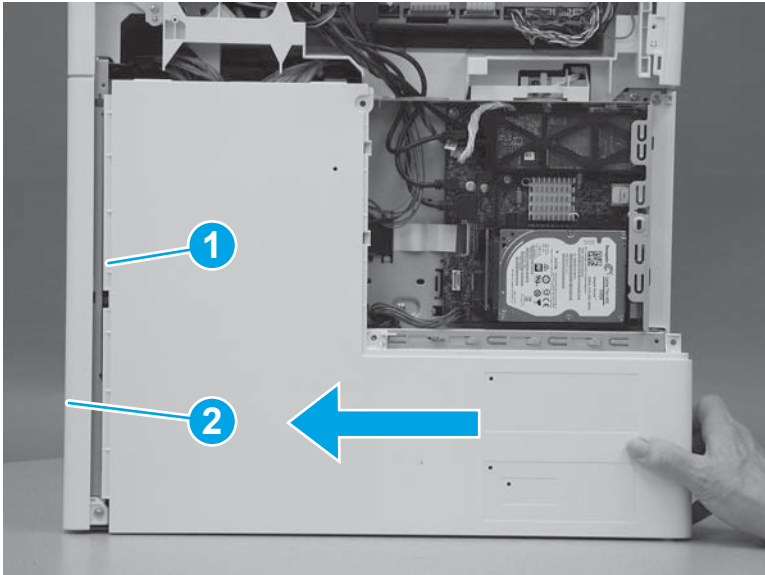

3. Install four screws (callout 1).

Figure 1-4752 Install four screws cover

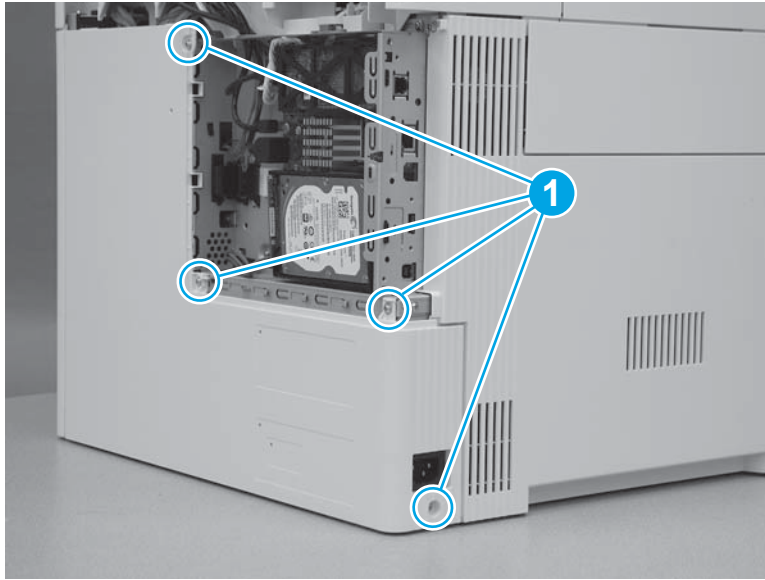

Step 61: Install the rear upper cover (M577)

 **NOTE:** This step is for the M577 models. For the M552 and M553 models, skip this step and go to [Step 62: Install the rear cover \(M552 and M553\) on page 2633](#).

1. Align the ridge (callout 1) on the lower edge of the rear upper cover in front of the tabs (callout 2) on the top edge of the rear cover.

Figure 1-4753 Align the cover

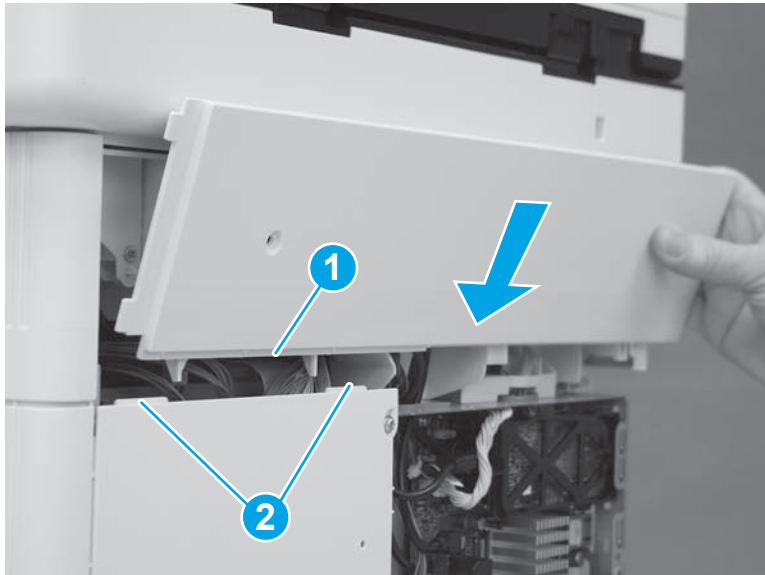

2. Rotate the top of the cover toward the printer.

Figure 1-4754 Rotate the top of the cover

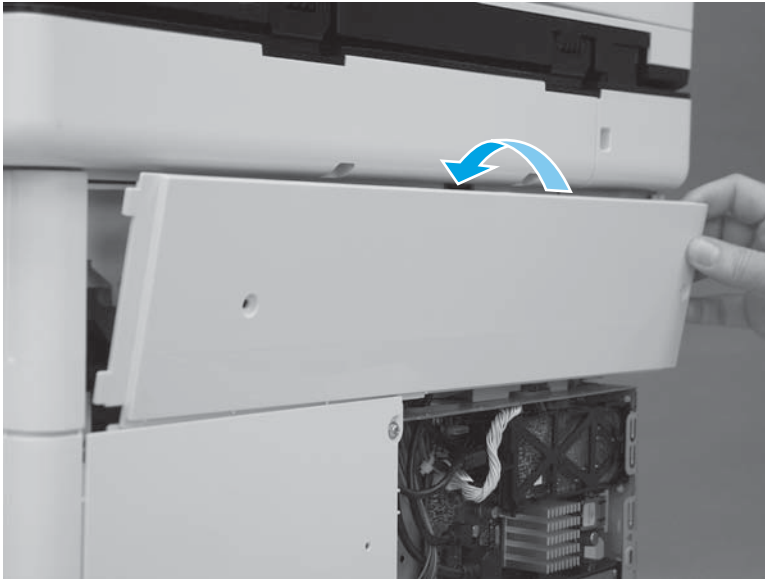

3. Slide the cover to the left (callout 1). Make sure that the tabs (callout 2) on the upper rear cover slide behind the edge (callout 3) of the right upper cover. Make sure that the cover is fully seated.

Figure 1-4755 Slide the cover

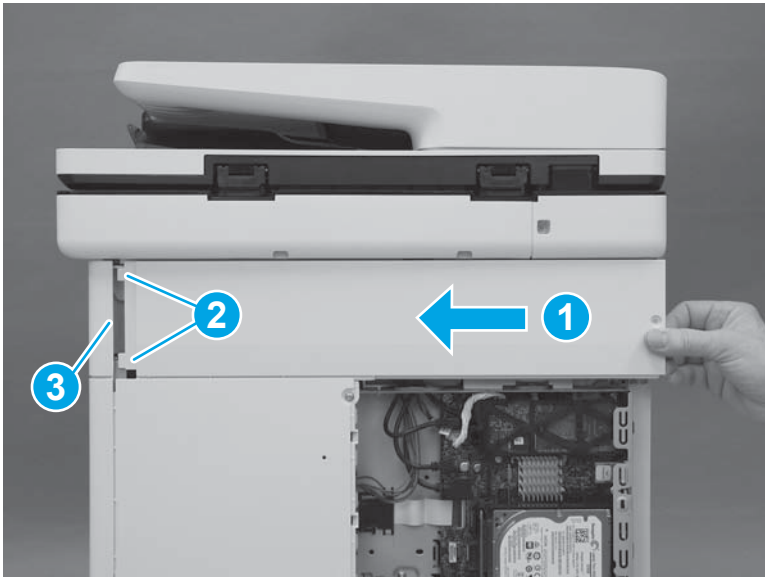

4. Install two screws (callout 1).

 **IMPORTANT:** These two screws are self-tapping screws for plastic. Rotate them counterclockwise to align them with the existing thread pattern, and then carefully turn them clockwise to tighten. Do not overtighten. This will prevent stripping the threads inside the screw holes.

Figure 1-4756 Install two screws



Step 62: Install the rear cover (M552 and M553)

 **NOTE:** This step is for the M552 and M553 models. For the M577 models, skip this step and go to [Step 63: Install the formatter \(M577\) on page 2634](#).

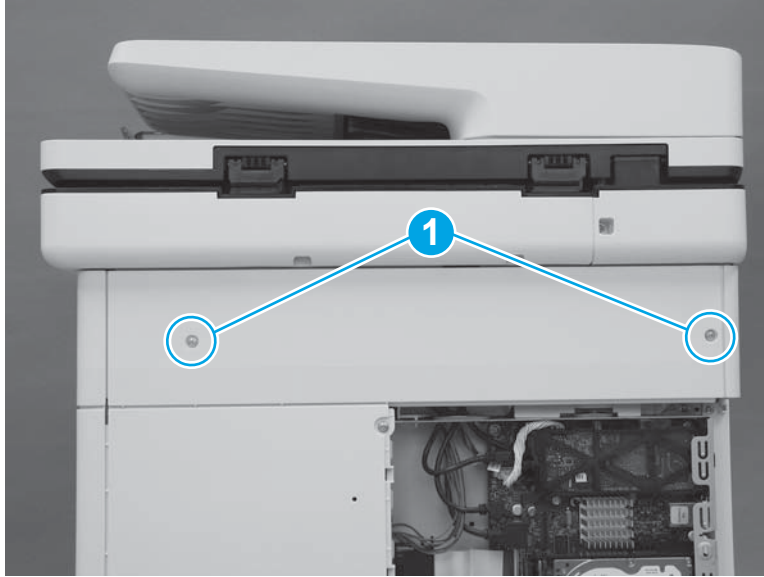
1. Position the top of the cover under the upper cover (callout 1), rotate the bottom of the cover onto the chassis (callout 2), and then slide the cover to the left (callout 3) to install it.

Figure 1-4757 Install the cover

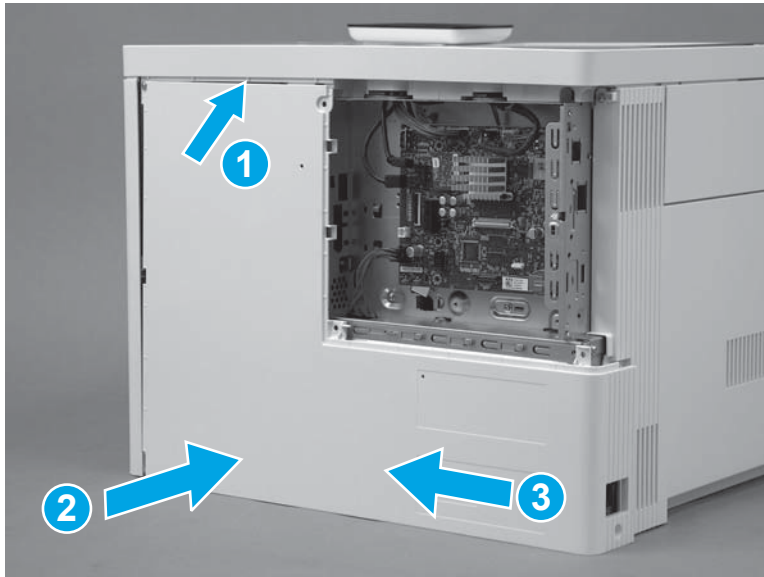

2. Install four screws (callout 1).

Figure 1-4758 Install four screws cover

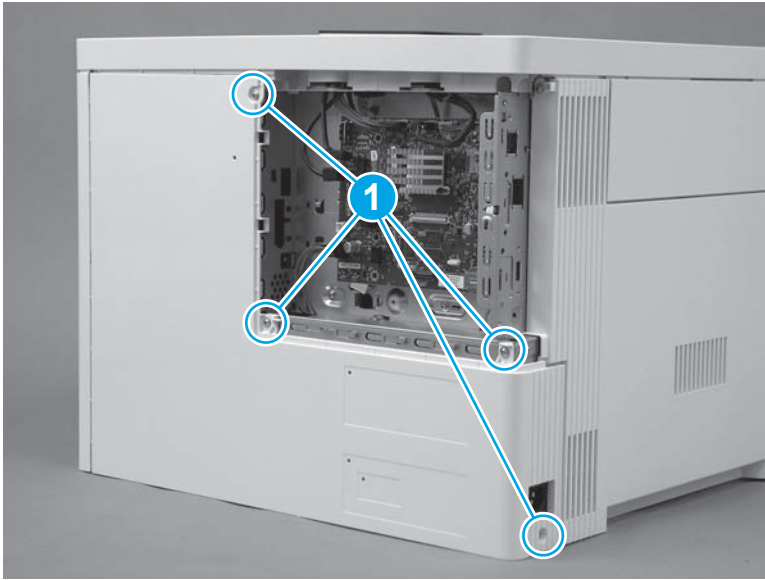

Step 63: Install the formatter (M577)



NOTE: This step is for the M577 models. For the M552 and M553 models, skip this step and to go [Step 66: Install the formatter \(M552 and M553\) on page 2639](#).



CAUTION:  ESD-sensitive part.

1. Position the formatter in the printer. Make sure that the network port (callout 1) fits through the opening (callout 2) in the formatter case.

Figure 1-4759 Install the formatter

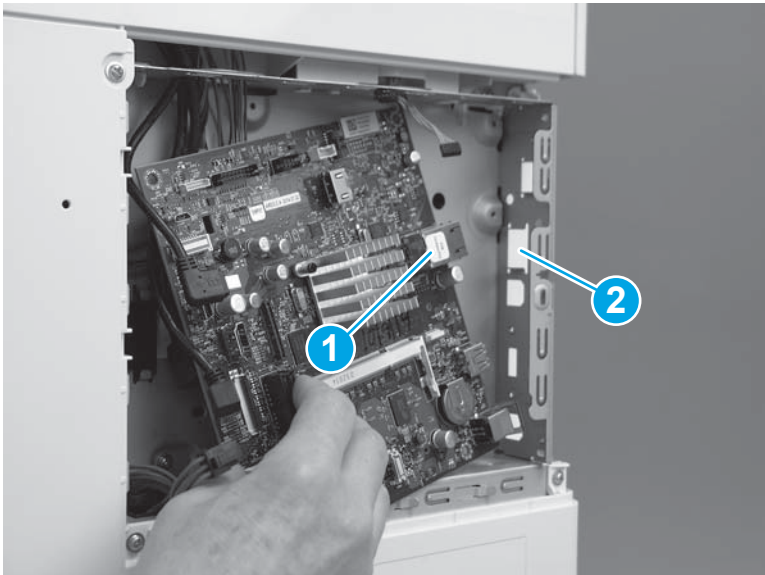

2. Install four screws (callout 1).

Figure 1-4760 Install four screws

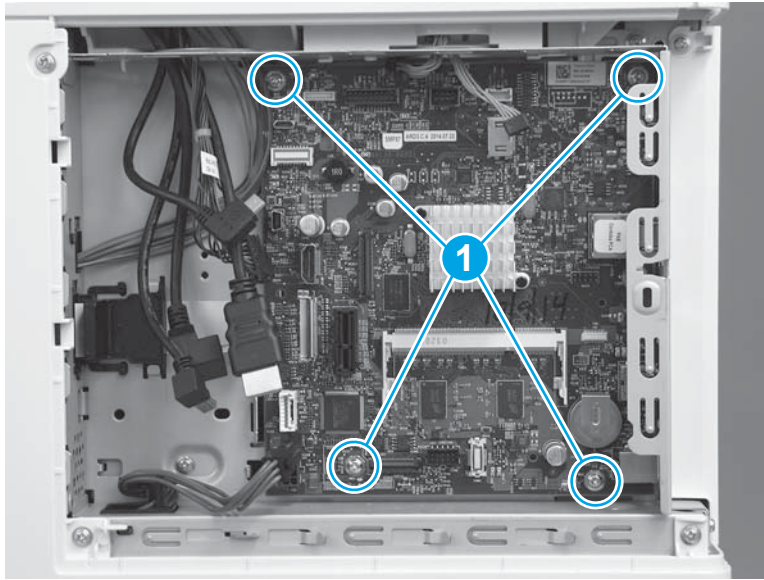

3. Connect all of the connectors on the formatter.

The following connectors are empty:

- All models: J1 (this connector is empty unless the optional DIMM is installed)
- All models: J3
- M577dn: J15 (this is the fax connector for the M577f/z/c models)
- All models: J21 (this connector is empty unless the optional internal USB ports component is installed)
- All models: J23
- All models: J24
- All models: J51
- All models: J57
- All models: J97
- All models: J98 (this connector is empty unless the optional trusted platform module (TPM) is installed)



 **IMPORTANT:** The flat-cable connector (callout 1) is a Zero Insertion Force (ZIF) connector that uses a hinged retainer to secure the flat cable. The hinged retainer must be opened to install the flat cable, and then closed after the cable is installed.

Figure 1-4761 Connect all connectors

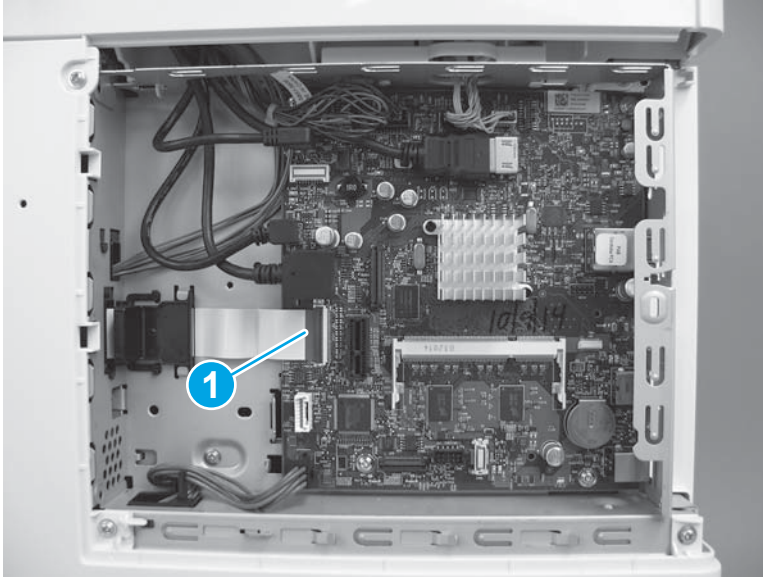

Step 64: Install the fax PCA (M577c/f/z)

 **NOTE:** This step is for the M577c/f/z models. For the M577nn model, skip this step and go to [Step 65: Install the HDD \(M577\) on page 2637](#).

For the M552 and M553 models, skip this step and go to [Step 66: Install the formatter \(M552 and M553\) on page 2639](#).

 **CAUTION:**  ESD-sensitive part.

1. Position the tab and telephone port (callout 1) on the fax PCA in the slots (callout 2) in the formatter case.

Figure 1-4762 Position the fax PCA

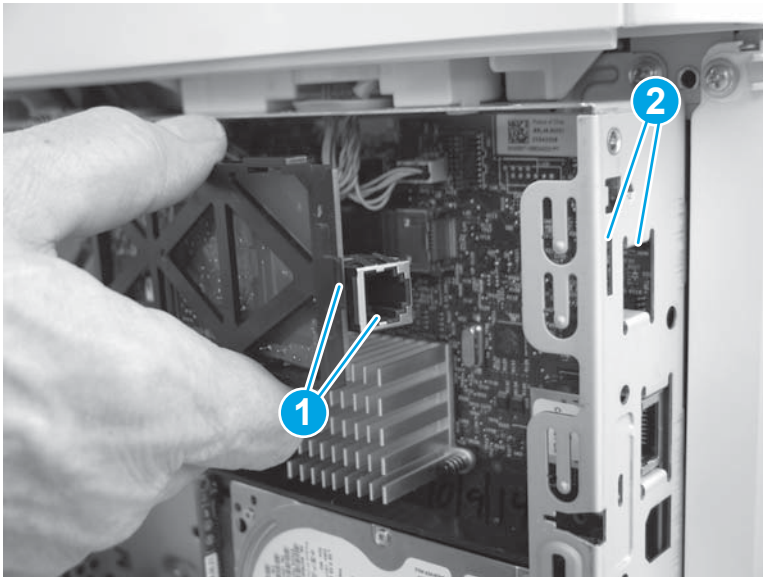

- Slide the fax PCA to the right (callout 1) until the tab and telephone port described in the previous step and seated in the formatter case. Position the retainer (callout 2) in the slot (callout 3) in the formatter. Rotate the end of the fax PCA toward the formatter (callout 4) until the retainer snaps into place.

Figure 1-4763 Install the fax PCA

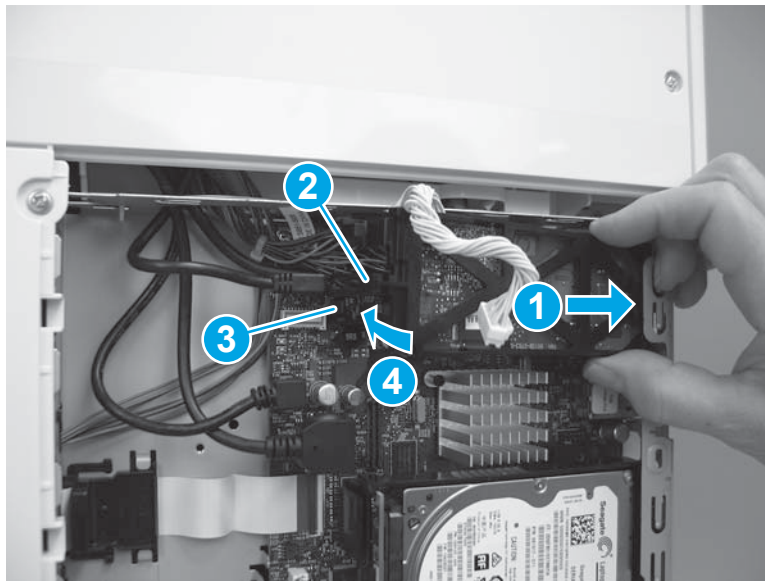

- Position the cable (callout 1) in the guide (callout 2), and then connect one connector (callout 3).

Figure 1-4764 Connect the connector

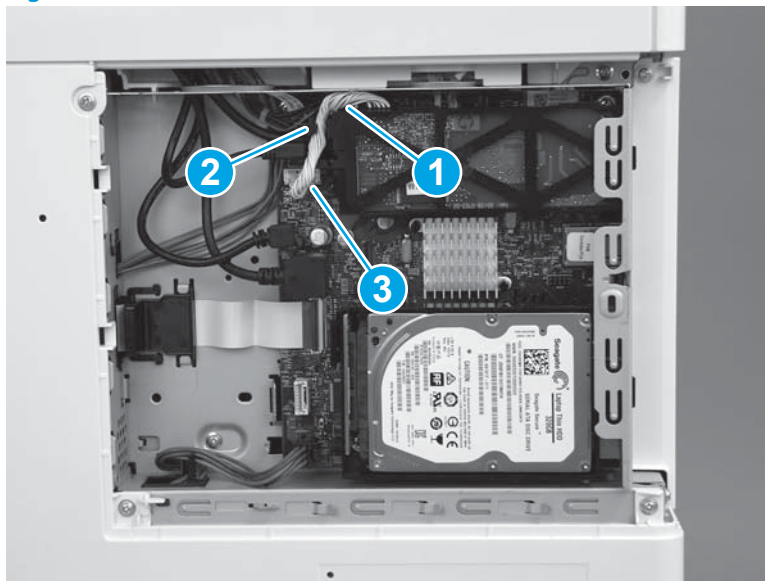

Step 65: Install the HDD (M577)

 **NOTE:** This step is for the M577 models. For the M552 and M553 models, skip this step and go to [Step 66: Install the formatter \(M552 and M553\) on page 2639.](#)

 **CAUTION:**  ESD-sensitive part.

1. Align the end of the bracket (callout 1) with the slot in the chassis (callout 2), and then slide the HDD into the printer (callout 3) to engage the bracket with the chassis.

Figure 1-4765 Install the holder

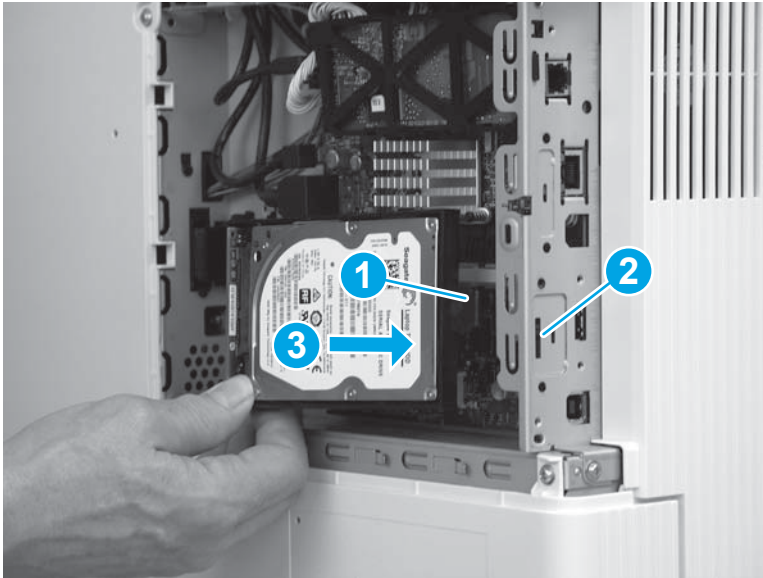

2. Hold the HDD connector latch (callout 1) in the released position, and then rotate the HDD down and into the connector on the formatter to install it.

 **NOTE:** Make sure that the tab (callout 2) snaps into place, and that the HDD is securely installed.

Figure 1-4766 Release the HDD

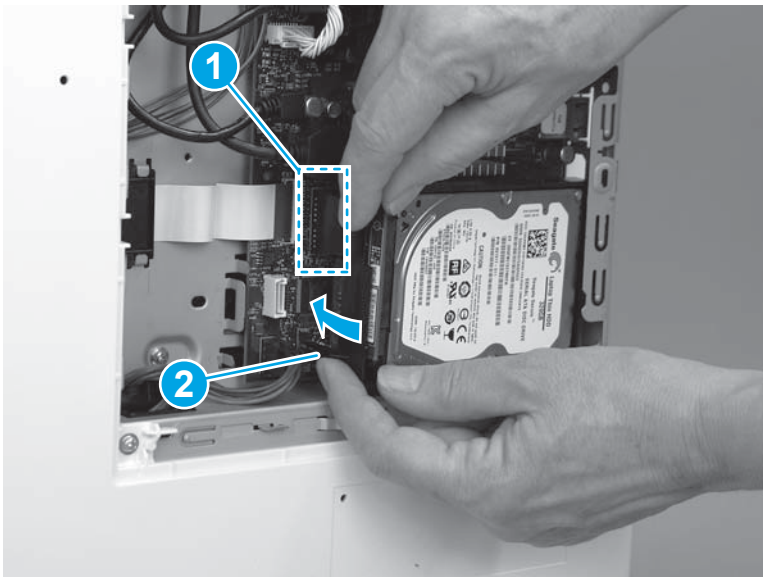

Step 66: Install the formatter (M552 and M553)

 **NOTE:** This step is for the M552 and M553 models. For the M577 models, skip this step and go to [Step 67: Install the formatter cover on page 2640](#).

If the optional hard-disk drive (HDD) was removed, do not forget to reinstall it after the formatter is reinstalled.

Engage the HDD holder with the chassis, rotate the HDD connector down and into the connector on the formatter. Make sure that the tabs snap into place.

 **CAUTION:**  ESD-sensitive part.

1. Position the formatter in the printer, and then install four screws (callout 1).

Figure 1-4767 Install the formatter

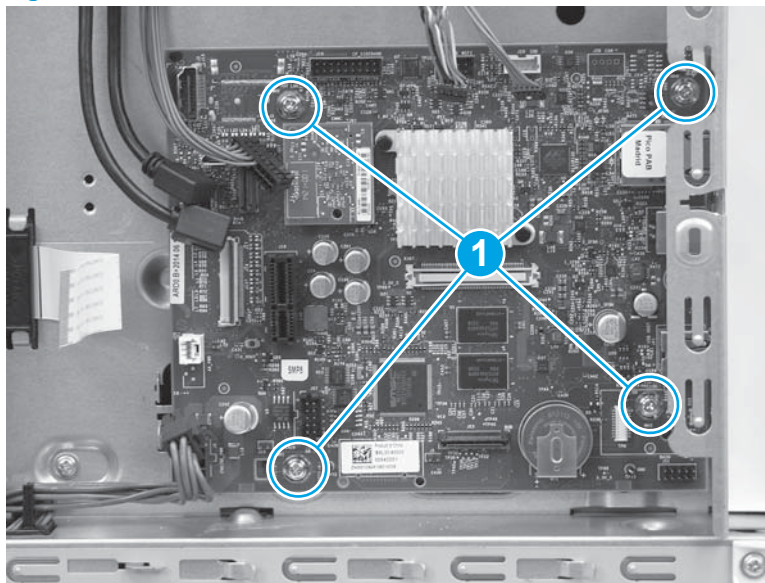

2. Connect all of the connectors on the formatter.

The following connectors are empty:

- All models: J1 (this connector is empty unless the optional DIMM is installed)
- M553n/dn and M552dn: J2 (callout 1; this is the touchscreen connector for the M553x model)
- All models: J9 (this connector is empty unless the optional internal USB ports component is installed)
- All models: J18 (this connector is empty unless the optional hard-disk-drive (HDD) is installed)
- All models: J23
- All models: J24
- M553n/dn and M552dn: J25 (this is the wireless connector for the M553x model)

- All models: J57
- All models: J98 (this connector is empty unless the optional trusted platform module (TPM) is installed)



 **IMPORTANT:** The flat-cable connector (callout 2) is a Zero Insertion Force (ZIF) connector that uses a hinged retainer to secure the flat cable. The hinged retainer must be opened to install the flat cable.

Figure 1-4768 Connect all connectors

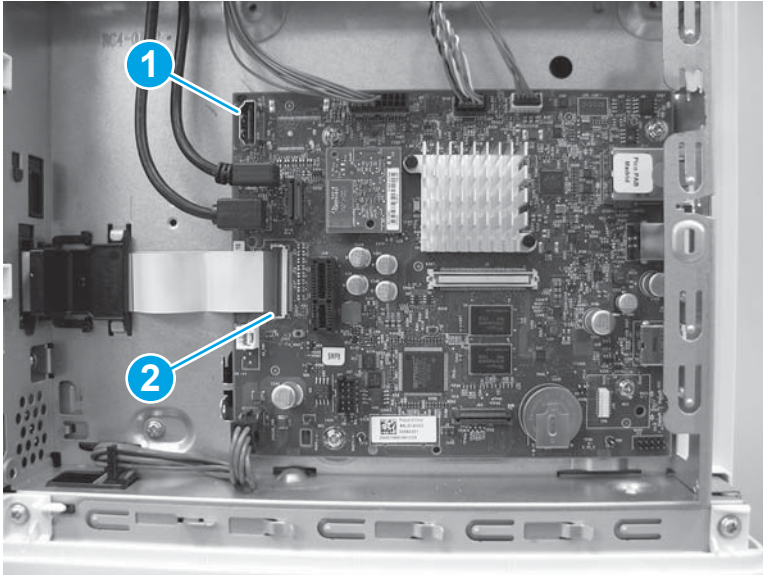

Step 67: Install the formatter cover

- ▲ Slide the cover onto the printer (callout 1) to install it.

 **NOTE:** Make sure that the tabs on the formatter cover align with the slots provided in the printer (callout 2). Tighten the two thumbscrews (callout 3).

 **TIP:** If needed, use the edge of a coin to turn the thumbscrews.

Figure 1-4769 Install the cover



Step 68: Install the TCU

1. Verify that the toner collection hatch cover is in the closed position on the TCU.

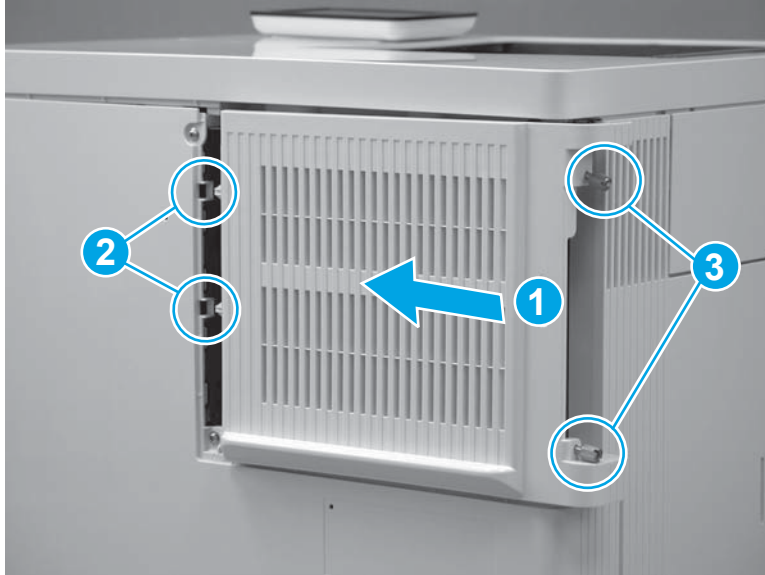
Figure 1-4770 Verify that the toner collection hatch cover is closed

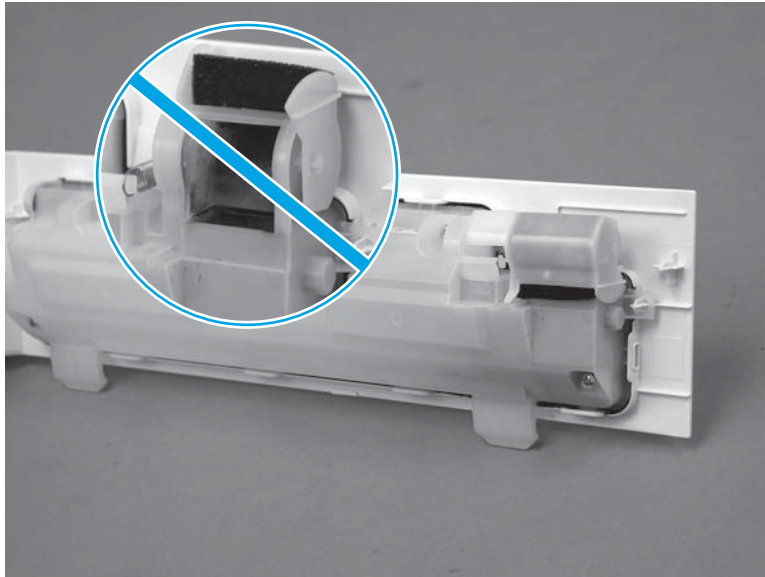

2. Position the TCU with the hinges in the slots provided in the printer (callout 1), and then rotate the TCU up and into the closed position.

 **NOTE:** The toner collection hatch cover automatically opens when the TCU is closed.

Figure 1-4771 Install the TCU



3. Close the front door.

Figure 1-4772 Close the front door

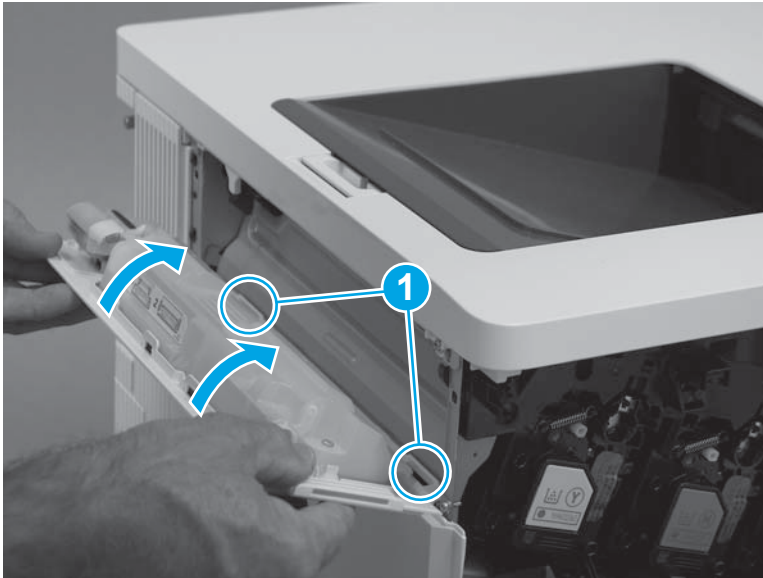

Step 69: Install the tray

1. With the front of the tray slightly lifted, align the sides of the tray with the rails in the printer, and then carefully slide the tray into the printer.

 **TIP:** As the tray slides into the printer, lower the front of it.

Figure 1-4773 Install the tray



2. Close the tray.

Figure 1-4774 Close the tray



Step 70: Install the control-panel assembly (M553x only)

 **NOTE:** For the M553n/dn and M552dn models, skip this step and go to [Step 73: Install the USB cover \(M552 and M553\) on page 2652](#).

For the M577 models, skip this step.

1. Place the control panel on the printer as shown.

Figure 1-4775 Place the control panel on the product

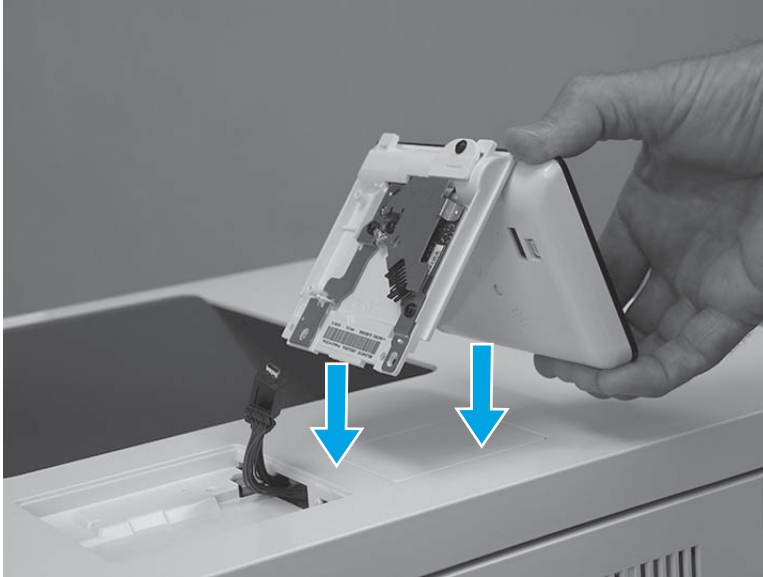

2. Connect one USB cable (callout 1), and one connector (callout 2).

 **IMPORTANT:** Take note of the location of the two mounting tabs (callout 3) on the control-panel assembly.

Figure 1-4776 Connect two connectors



3. Turn the control panel over, and then position the front edge tabs in the slots in the top cover.

Figure 1-4777 Turn the control panel over

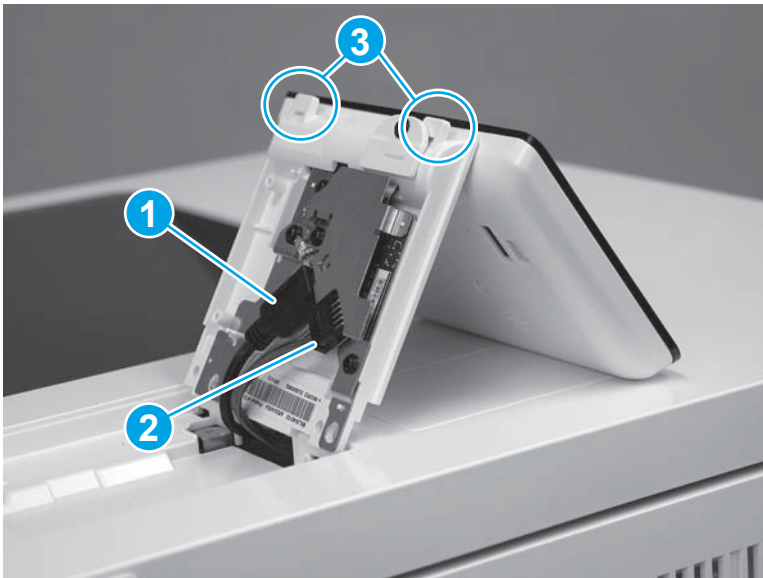
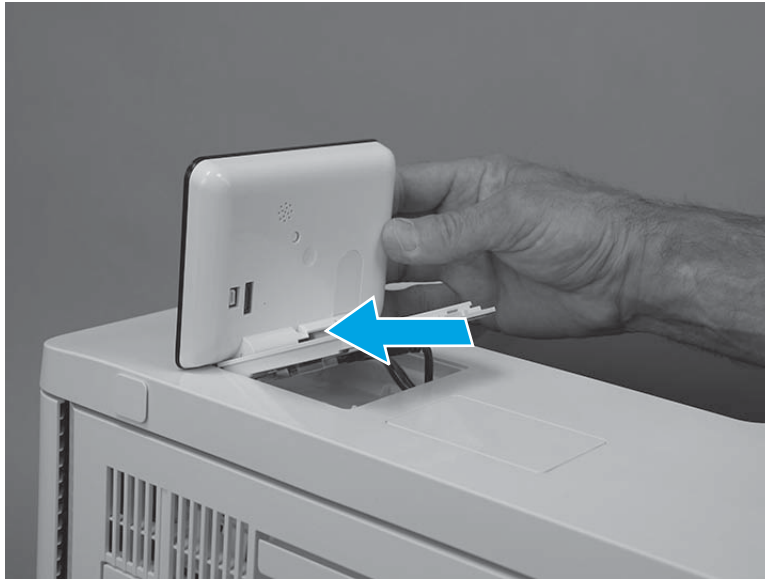

4. Rotate the control-panel base down onto the printer.

Figure 1-4778 Rotate the control-panel base down



5. Use a small Phillips screwdriver to install two screws (callout 1).

Figure 1-4779 Install two screws

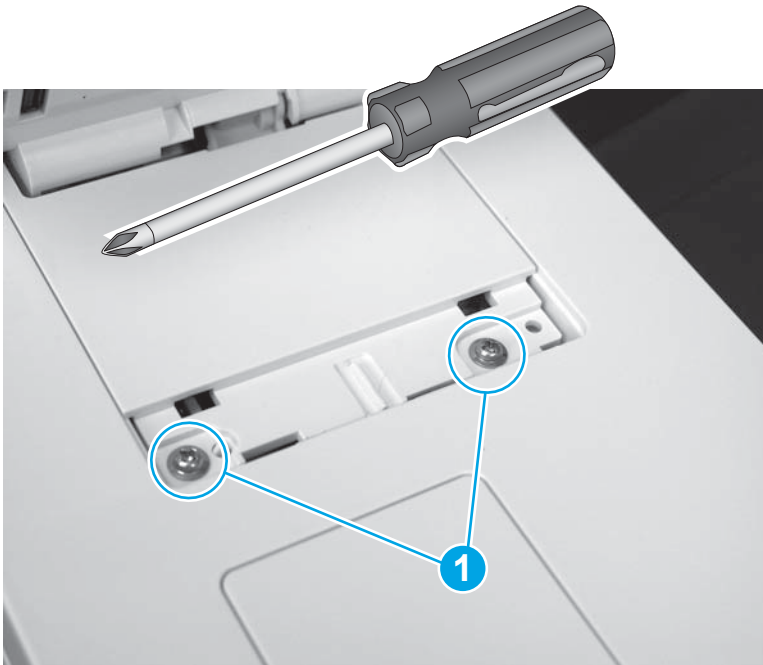

6. Position the screw cover mounting feet into the slots in the top cover (callout 1), and then rotate the cover down (callout 2) to install it.

 **NOTE:** Press down on the cover firmly to make sure that the tabs on the cover (callout 3) snap into place.

Figure 1-4780 Install the cover



Step 71: Install the ITB

CAUTION: Do not touch the grey-plastic belt. Skin oils and fingerprints on the belt can cause print-quality problems.

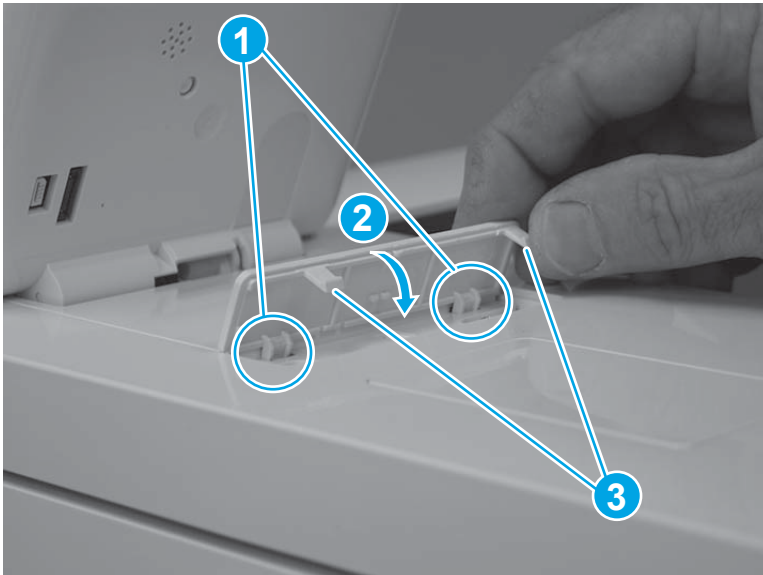
1. Handle the replacement ITB by the edges. Do not touch the grey-plastic belt. Skin oils and fingerprints on the belt can cause print-quality problems.

Figure 1-4781 Handle the ITB by the edges

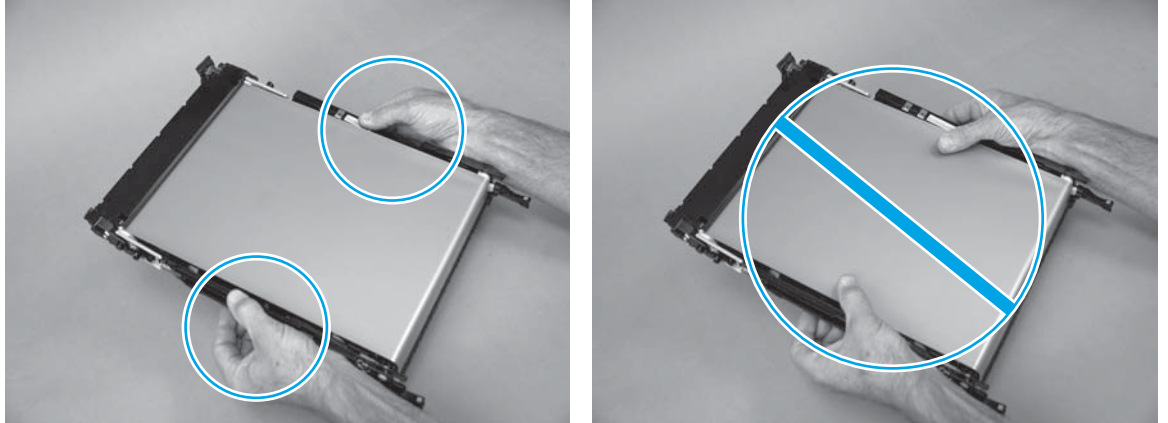

2. Align the ITB with the slots in the printer, and then carefully push it into the printer.

NOTE: Be careful. Do not dislodge the ITB retainer springs from the holders on the chassis. The springs can interfere with installing the ITB.

Figure 1-4782 Align the ITB with the slots in the product

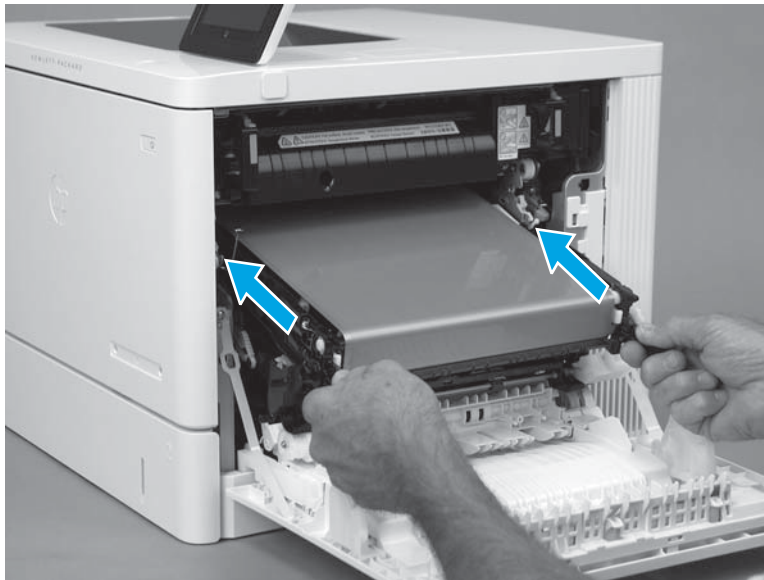

3. Continue to carefully push the ITB into the printer until it is fully installed.

Figure 1-4783 Install the ITB

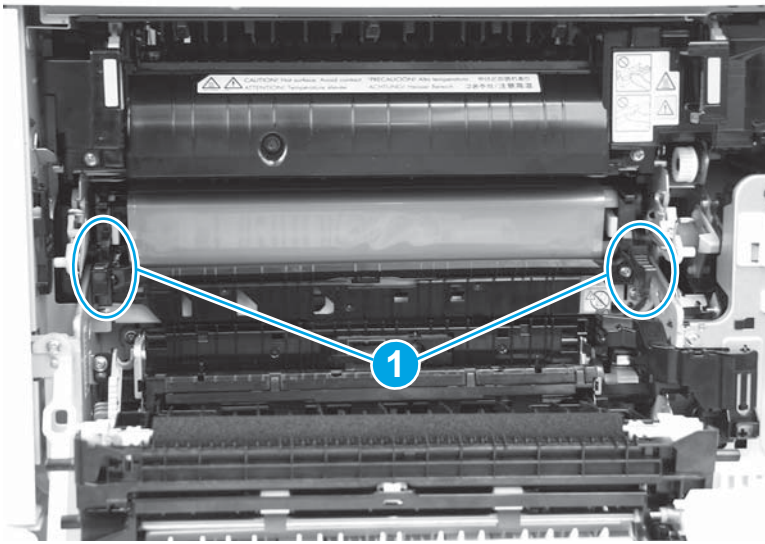

4. Remove the right-side ITB spring from the holder.

Figure 1-4784 Remove the spring from the holder



5. Fasten the right-side ITB spring (callout 1) under the tab (callout 2).

Figure 1-4785 Fasten the rear-side ITB spring

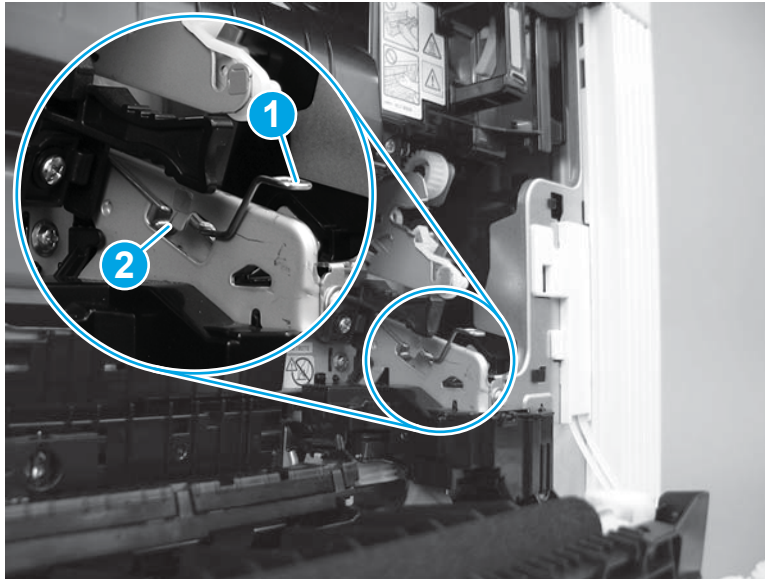

6. Remove the left-side ITB spring from the holder.

Figure 1-4786 Remove the spring from the holder

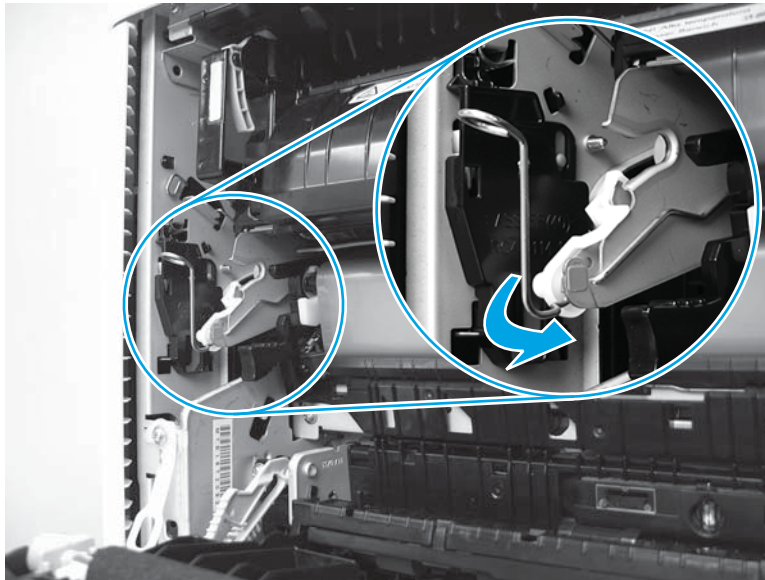

7. Fasten the left-side ITB spring (callout 1) under the tab (callout 2).

Figure 1-4787 Fasten the front-side ITB spring

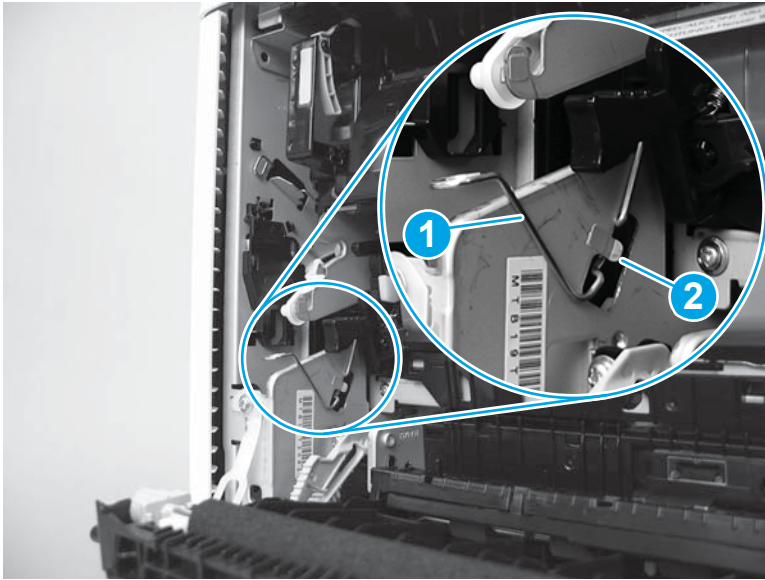

8. Push in the blue lever to engage the ITB drive coupling.

Figure 1-4788 Engage the ITB drive coupling

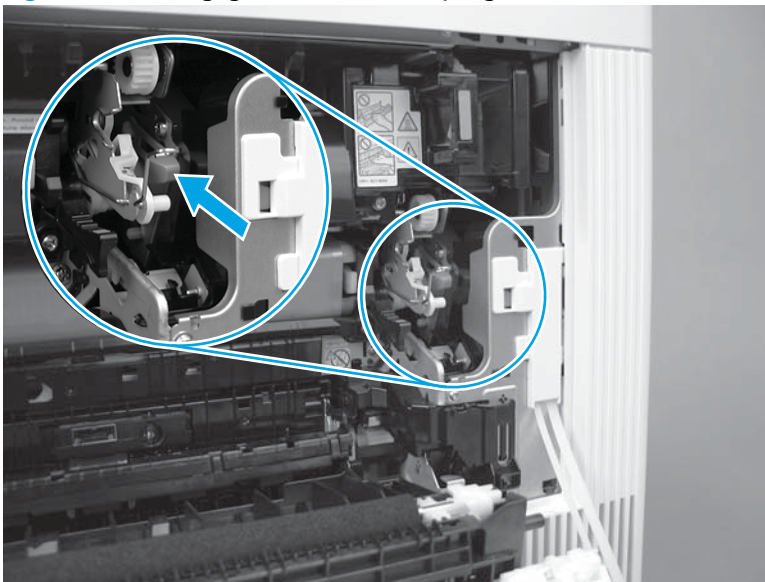

Step 72: Install the fuser

1. Align the fuser with the opening in the printer.

Figure 1-4789 Align the fuser with the opening

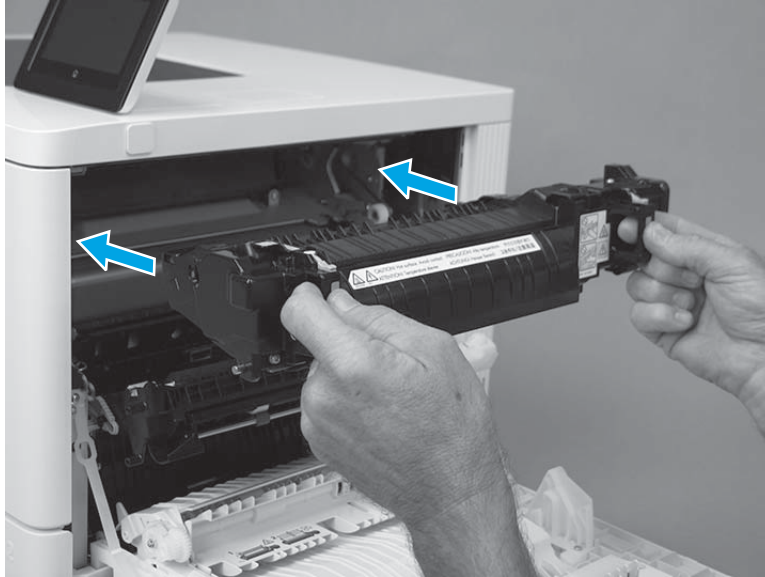

2. Slide the fuser into the printer, push in to install it, and then make sure that it is fully seated.

 **TIP:** When the fuser is fully seated, the two blue triggers on the handles make an audible click.

Figure 1-4790 Install the fuser



3. Close the right door.

Figure 1-4791 Close the right door

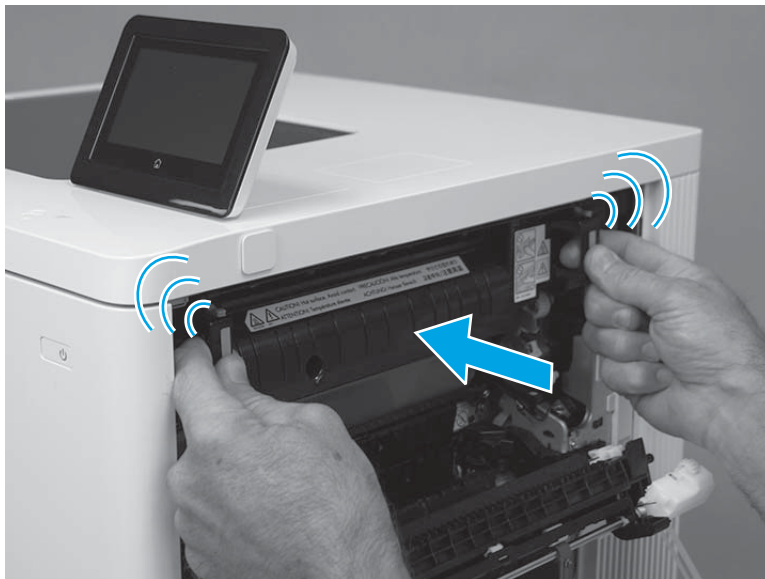

Step 73: Install the USB cover (M552 and M553)



NOTE: This step is for the M552 and M553 models. For the M577 models, skip this step.

1. Push the cover into the USB port to install it.

Figure 1-4792 Install the cover



2. Make sure that the USB cover is fully seated after installing it.

Figure 1-4793 Check the installation

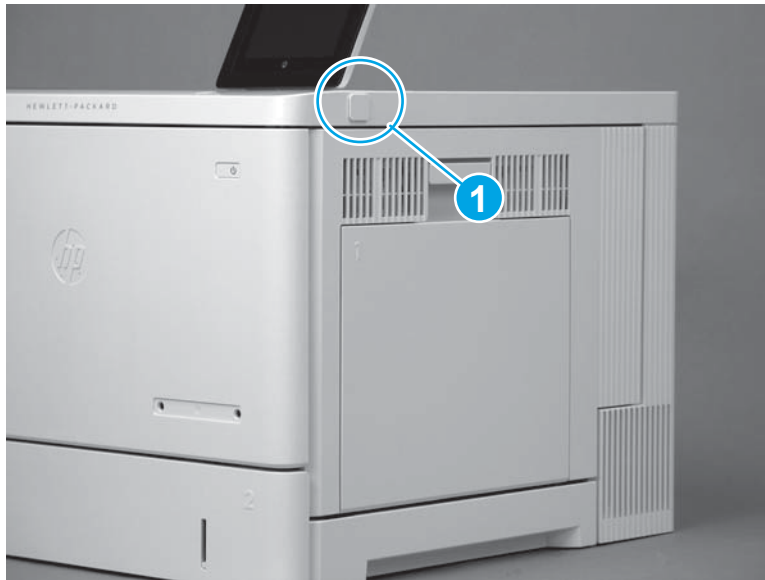

Step 74: Calibrate the printer

Calibrate the printer from a touchscreen control panel

1. From the [Home](#) screen on the printer control panel, scroll to and touch the [Device Maintenance](#) button.
2. Open the following menus:
 - [Calibration/Cleaning](#)
3. Touch [Full Calibrate](#) or [Quick Calibrate](#) to start the calibration process.
4. Wait while the printer calibrates, and then try printing again.

Calibrate the printer from an LCD control panel

1. From the [Home](#) screen on the printer control panel, use the down arrow ▼ button to scroll to [Device Maintenance](#), and then press the [OK](#) button.
2. Use the down arrow ▼ button to scroll to [Calibration/Cleaning](#), and then press the [OK](#) button.
3. If necessary, use the down arrow ▼ button to scroll to [Full Calibrate](#) or [Quick Calibrate](#), and then press the [OK](#) button to start the calibration process.
4. Wait while the printer calibrates, and then try printing again.

Step 75: Perform a color band test

Access the color band test from a touchscreen control panel

1. From the [Home](#) screen on the printer control panel, scroll to and touch the [Administration](#) button.
2. Open the following menus:

- [Troubleshooting](#)
 - [Print Quality Pages](#)
 - [Color Band Test](#)
3. Touch the [Print Test page](#) button, and then touch the [Print](#) button to print the pages.

Access the color band test from an LCD control panel

1. From the [Home](#) screen on the printer control panel, use the down arrow ▼ button to scroll to [Administration](#), and then press the [OK](#) button.
2. Use the down arrow ▼ button to scroll to [Troubleshooting](#), and then press the [OK](#) button to select it.
3. Use the down arrow ▼ button to scroll to [Print Quality Pages](#), and then press the [OK](#) button to select it.
4. Use the down arrow ▼ button to scroll to [Color Band Test](#), and then press the [OK](#) button to select it.

Removal and replacement: Document feeder and image scanner assemblies (M577)

- [Removal and replacement: Document feeder \(M577\)](#)
- [Removal and replacement: Scanner control board \(SCB\) \(M577\)](#)
- [Removal and replacement: Image scanner \(M577\)](#)

Removal and replacement: Document feeder (M577)

- [Introduction](#)
- [Step 1: Remove the formatter cover](#)
- [Step 2: Remove the rear upper cover](#)
- [Step 3: Remove the left upper cover](#)
- [Step 4: Remove the document feeder](#)
- [Step 5: Unpack the replacement assembly](#)
- [Step 6: Install the document feeder](#)
- [Step 7: Install the left upper cover](#)
- [Step 8: Install the rear upper cover](#)
- [Step 9: Install the formatter cover](#)
- [Step 10: Reset the firmware counter](#)

Introduction

This document provides the procedures to remove and replace the M577 document feeder .

Before performing service

Turn the printer power off

- Disconnect the power cable.

 **WARNING!** To avoid damage to the printer, turn the printer off, wait 30 seconds, and then remove the power cord before attempting to service the printer.

Use the table below to identify the correct part number for your printer. To order the part, go to www.hp.com/buy/parts.

Document feeder (M577) part numbers

B5L47-67901	ADF whole unit kit (M577dn/f)
B5L47-67902	ADF whole unit kit (M577c/z)

Required tools

- #2 Phillips screwdriver with a magnetic tip.
- Small flat-blade screwdriver.

After performing service

Turn the printer power on

- Connect the power cable.
- Use the power switch to turn the power on.

Post service test

Use the document feeder to make a copy to make sure that it is properly functioning.

Step 1: Remove the formatter cover

1. Locate the formatter cover.

Figure 1-4794 Locate the formatter cover

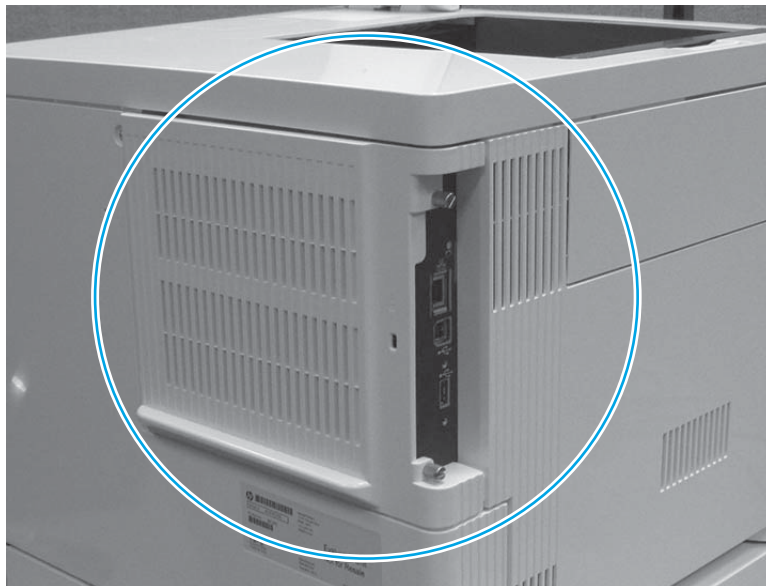

2. Loosen the two thumbscrews (callout 1). Grasp the two thumbscrews, and then slide the cover away from the printer (callout 2) to remove it.

 **TIP:** If needed, use the edge of a coin to turn the thumbscrews.

Figure 1-4795 Loosen the thumbscrews



Step 2: Remove the rear upper cover

1. Remove two screws (callout 1).

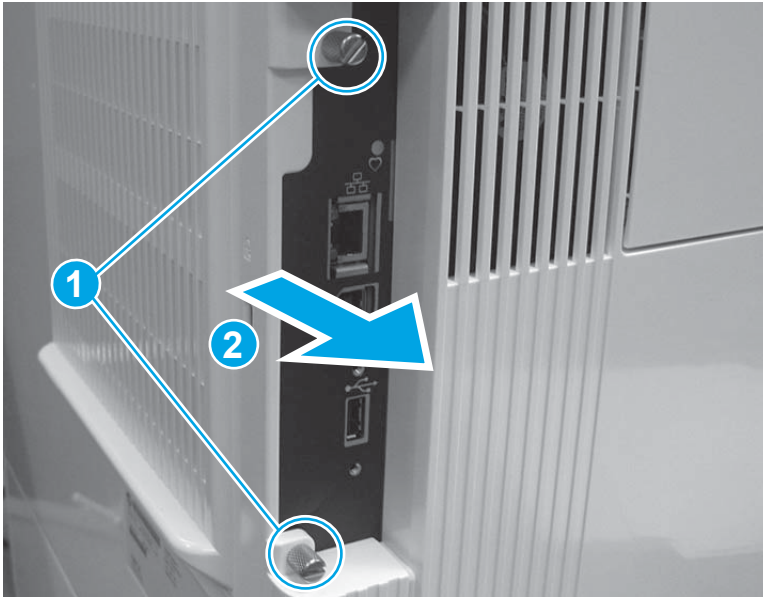
 **Reinstallation tip:** These two screws are self-tapping screws for plastic. When reinstalling them, rotate the screws counterclockwise to align them with the existing thread pattern, and then carefully turn them clockwise to tighten. Do not overtighten. This will prevent stripping the threads inside the screw holes.

Figure 1-4796 Remove two screws



2. Use a small, flat blade screwdriver to release the right edge of the cover.

Figure 1-4797 Release the right edge

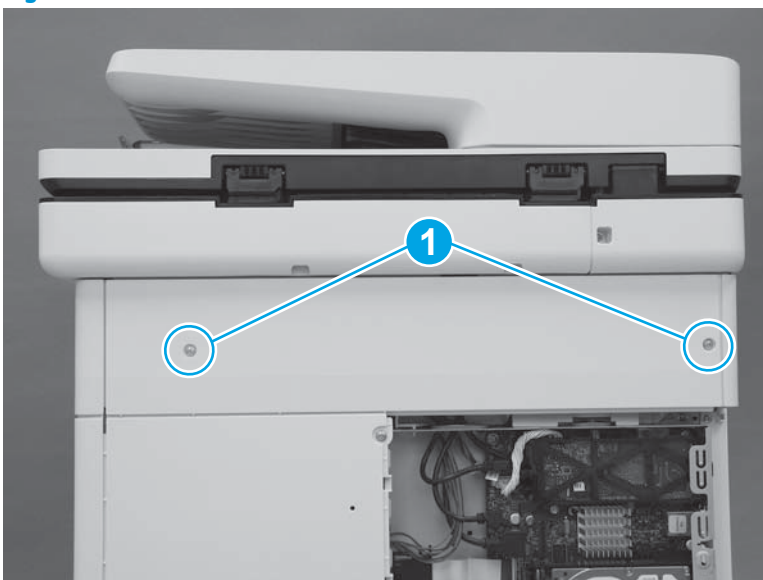
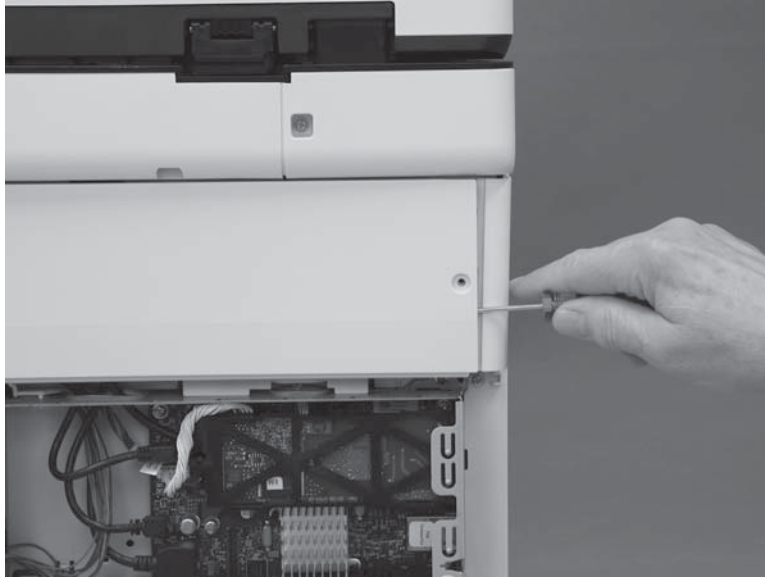

3. Pull the right edge of the cover (callout 1) away from the printer, and then slide the cover to the right (callout 2).

Figure 1-4798 Slide the cover right

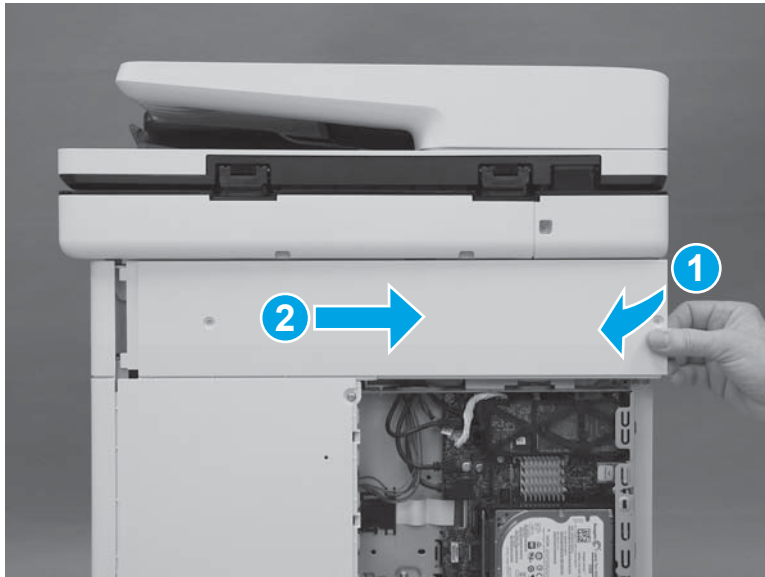

4. Remove the cover.

Figure 1-4799 Remove the cover

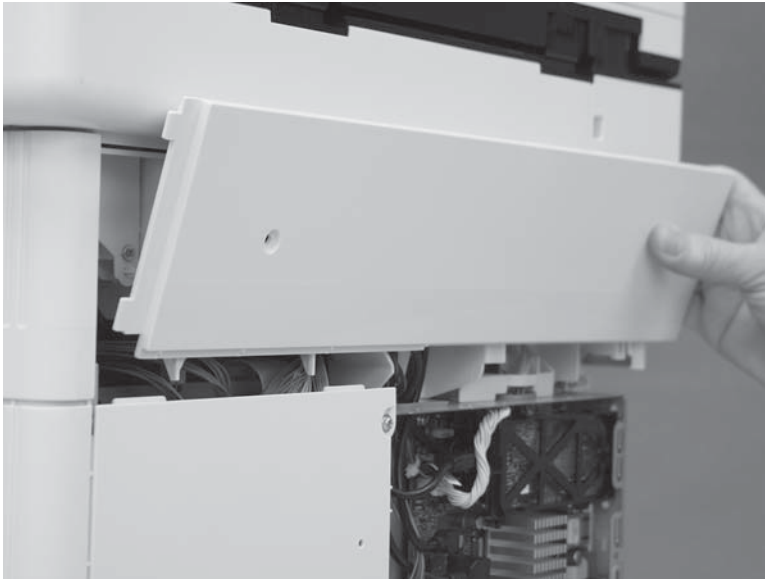

Step 3: Remove the left upper cover

1. At the left side of the printer, release one tab (callout 1).

Figure 1-4800 Release one tab

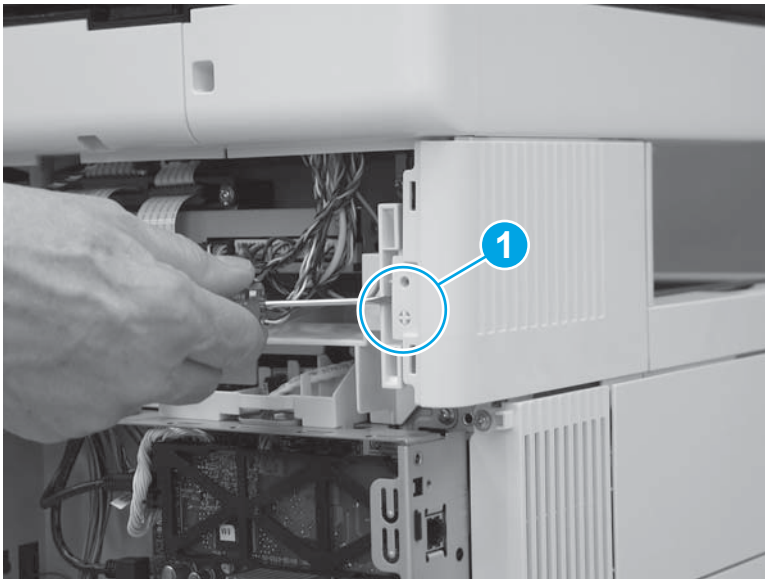

2. Slide the left upper cover toward the back of the printer.

Figure 1-4801 Slide the cover back

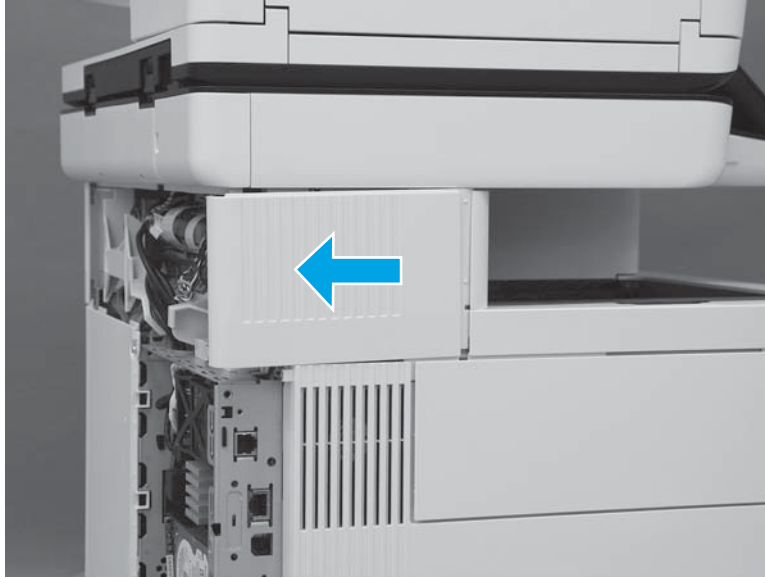

3. Rotate the cover up to remove it.

Figure 1-4802 Remove the left upper cover

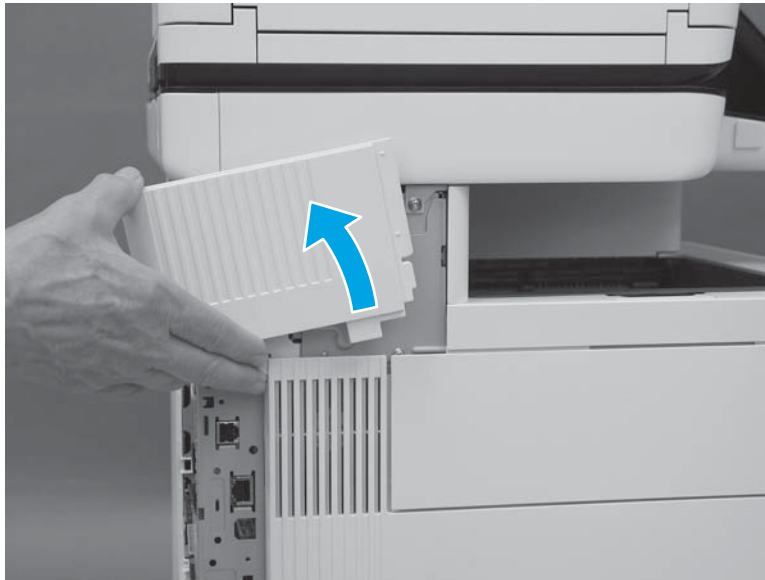

Step 4: Remove the document feeder

1. Remove one screw (callout 1).

 **Reinstallation tip:** This is a self-tapping screw for plastic. When reinstalling, rotate the screw in reverse a few turns to align the threads before installing it. This will prevent stripping the threads inside the hole in the plastic part.

Figure 1-4803 Remove one screw



2. Rotate the cover away from the printer to remove it.

Figure 1-4804 Remove the cover

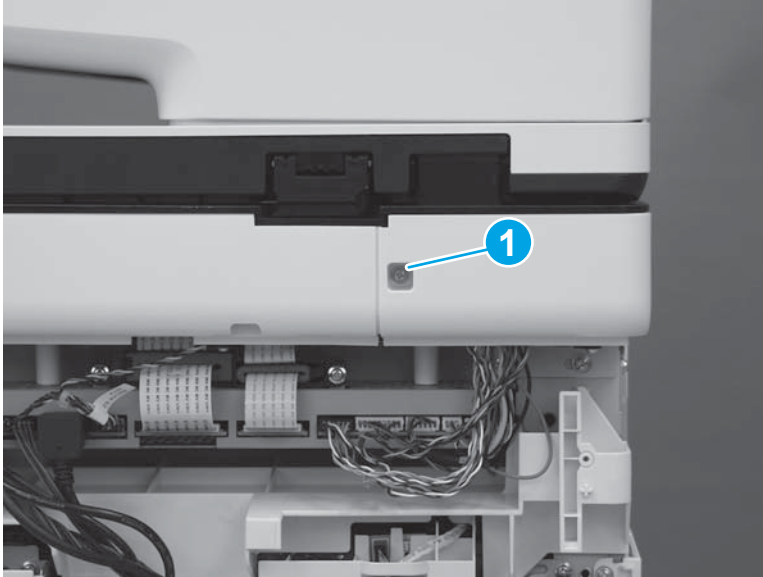
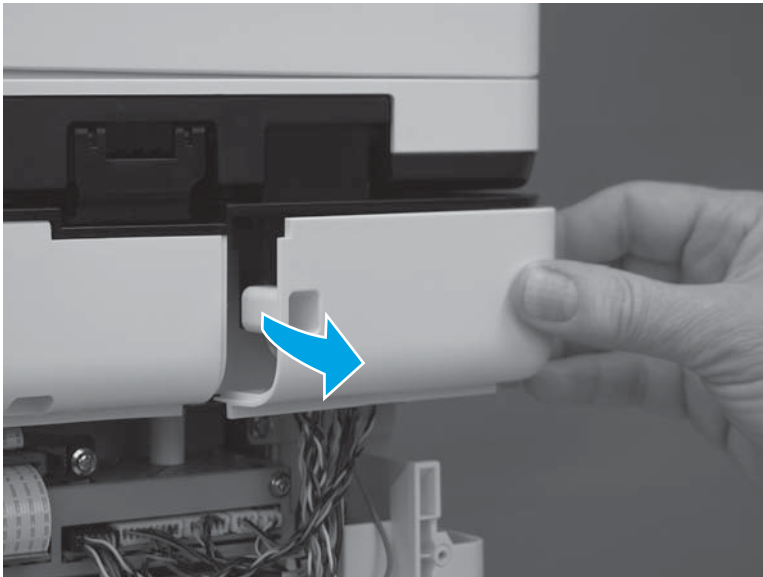

3. Disconnect one flat cable (callout 1), remove one ground screw (callout 2) to release the grounding cable, and then disconnect five connectors (callout 3).

Figure 1-4805 Disconnect the flat cable, ground cable, and connectors

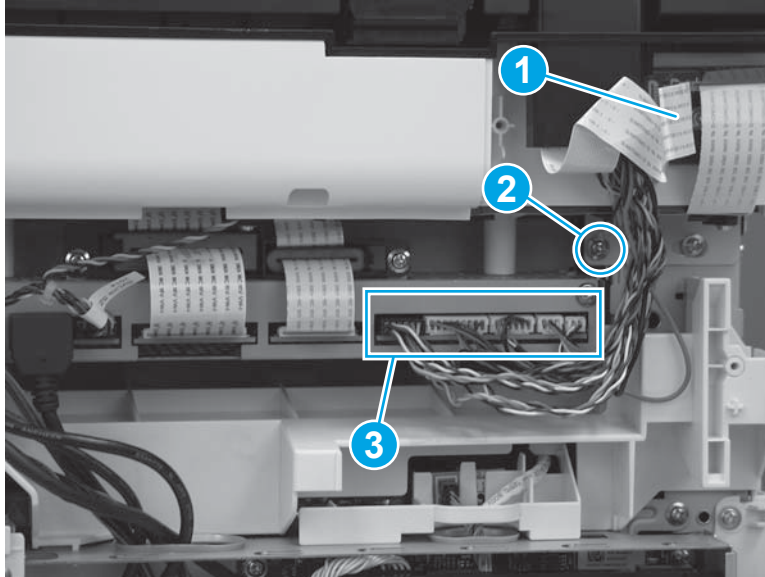

4. Open the document feeder.

Figure 1-4806 Open the document feeder



5. Tilt the document feeder back until it stops (callout 1), and then lift it off of the scanner until it stops (callout 2).

Figure 1-4807 Raise the document feeder



6. Support the document feeder, and then use a small flat-blade screwdriver to release two tabs on the document feeder hinges.

Figure 1-4808 Release two tabs



7. Lift the document feeder up top remove it.

 **NOTE:** While removing the document feeder, carefully pass the wire harnesses and the FFC through the opening in the scanner.

Figure 1-4809 Remove the document feeder



Step 5: Unpack the replacement assembly

Unpack the replacement assembly from the packaging.

For complete information on HP's recycling programs, go to [Product return and recycling](#).

 **NOTE:** HP recommends responsible disposal of the defective part.

Figure 1-4810 Recycle and unpack

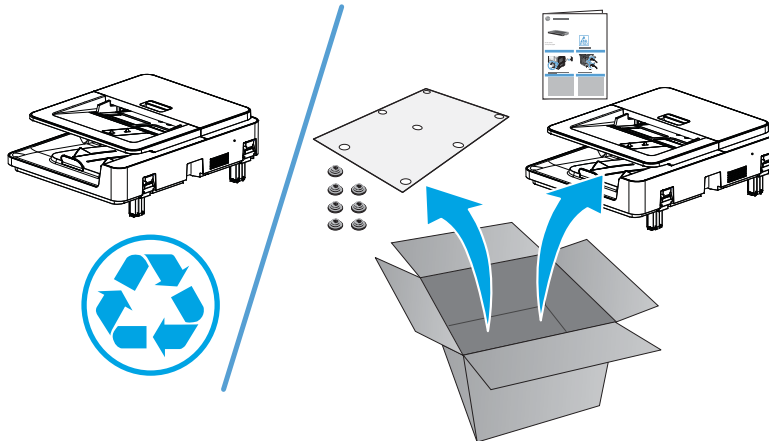

Step 6: Install the document feeder

1. Pass the flat cable and wire harnesses on the replacement document feeder through the hole in the scanner chassis (callout 1), and then align the hinges (callout 2) with the slots (callout 3) in the chassis.

Figure 1-4811 Install the document feeder

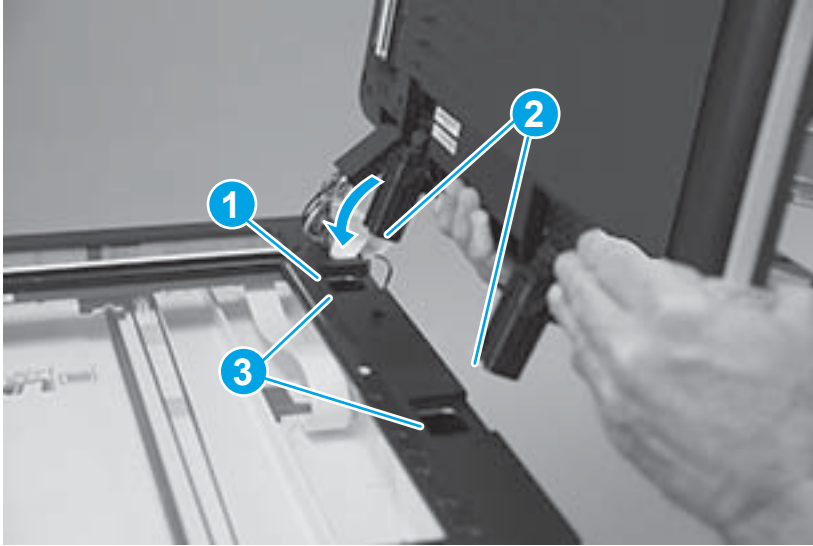

2. Continue to pass the flat cable and wire harnesses through the opening in the chassis (callout 1), and then insert the hinges (callout 2) into the slots.

⚠ CAUTION: Do not damage the flat cable or wire harnesses when the cable guide (callout 1) is installed in its slot.

Figure 1-4812 Lower the document feeder



3. Install the seven retention clips (supplied in this kit) in the document feeder. Position the clip (callout 1) in the opening (callout 2) in the document feeder. Repeat this step for the remaining retention clips.

Figure 1-4813 Install the retention clip

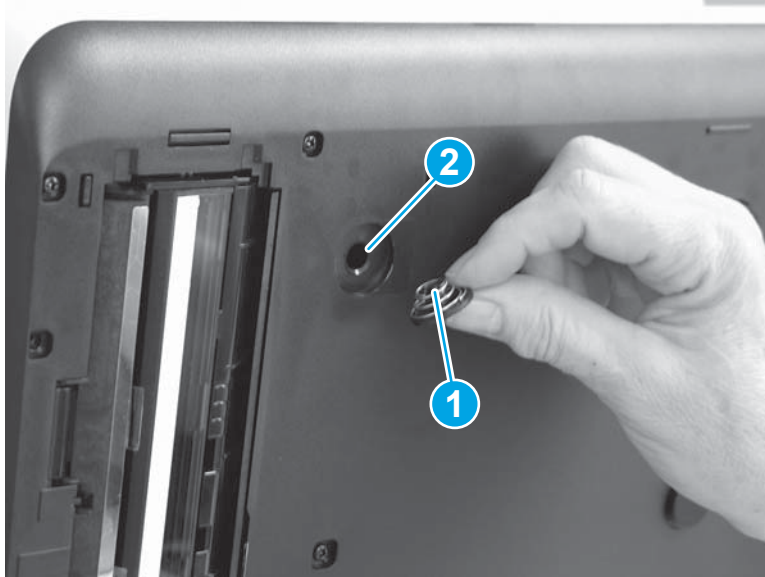

4. Press the clip to make sure it is securely installed. Repeat this step for the remaining retention clips.

Figure 1-4814 Press the retention clip

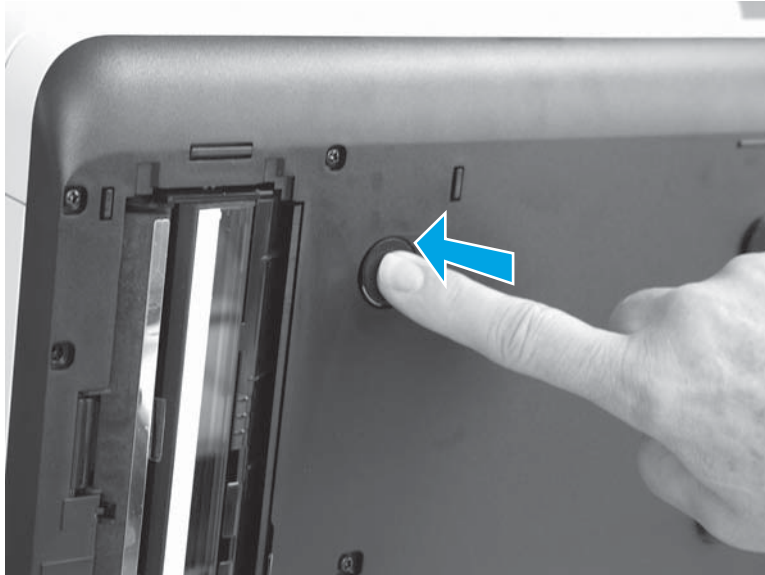

5. Place the replacement white backing (supplied in this kit), on the flatbed scanner glass as shown.

 **NOTE:** Place the corner of the backing that does not have a hook-and-loop fastener in the upper-left corner of the scanner glass.

Figure 1-4815 Install the white backing



6. Close the document feeder to attach the white backing.

Figure 1-4816 Attach the white backing

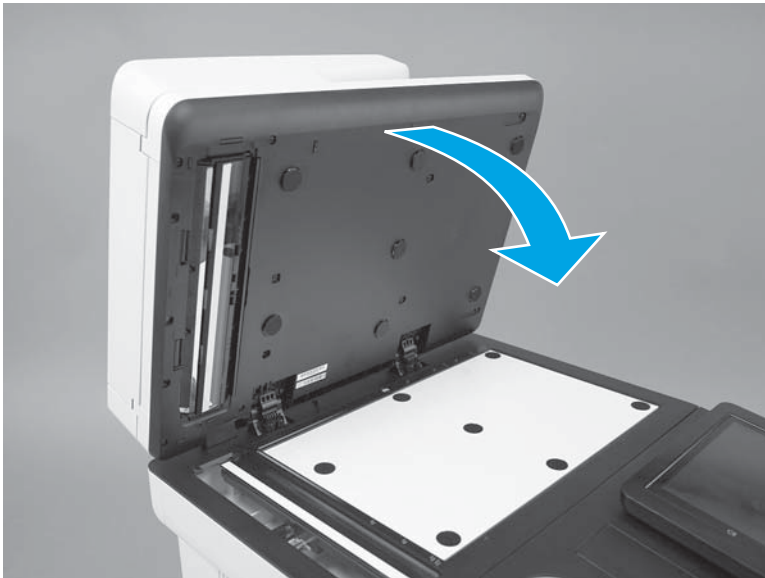

7. Open the document feeder and make sure that the white backing is securely attached.

Figure 1-4817 Check the white backing



8. Close the document feeder.

Figure 1-4818 Close the document feeder



9. Connect one flat cable (callout 1), install the grounding cable behind one ground screw (callout 2), and then connect five connectors (callout 3).

Figure 1-4819 Connect the flat cable, ground cable, and connectors

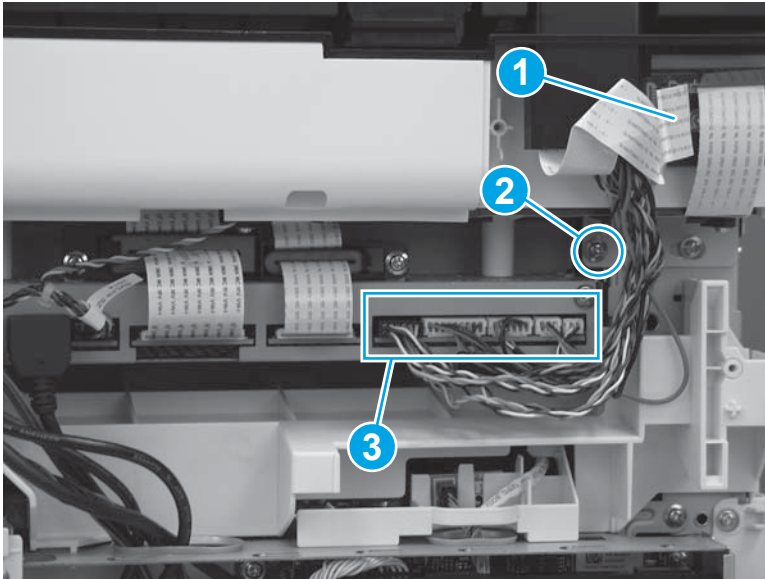

10. Position the tabs (callout 1) on the cover in the slots (callout 2) in the printer.

Figure 1-4820 Position the tabs

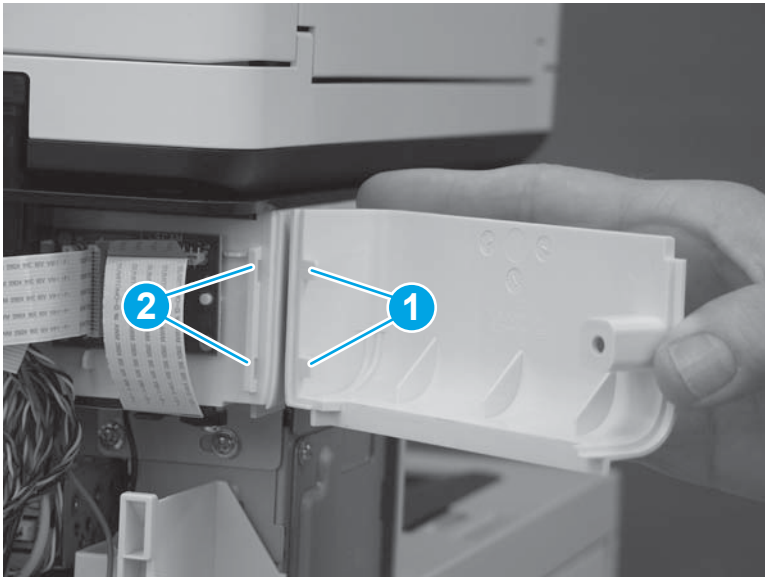

11. Rotate the cover toward the printer to install it.

Figure 1-4821 Install the cover

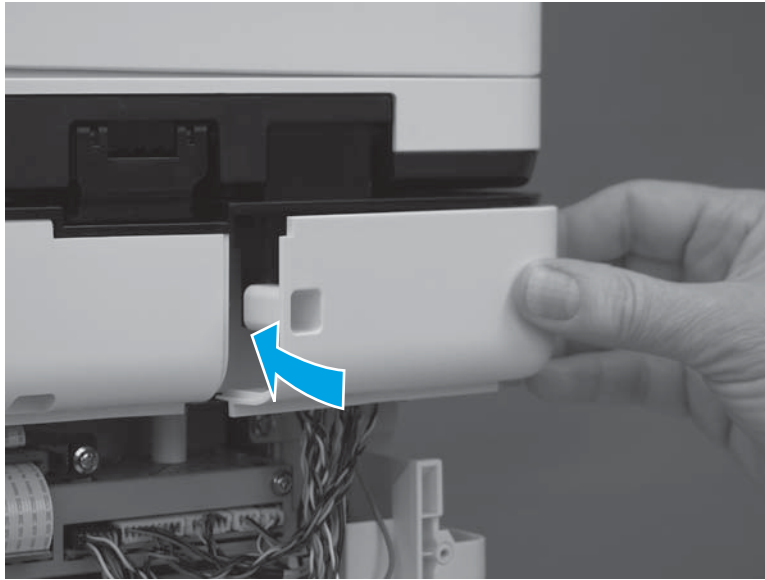

12. Install one screw (callout 1).

 **IMPORTANT:** This is a self-tapping screw for plastic. Rotate the screw in reverse a few turns to align the threads before installing it. This will prevent stripping the threads inside the hole in the plastic part.

Figure 1-4822 Install one screw

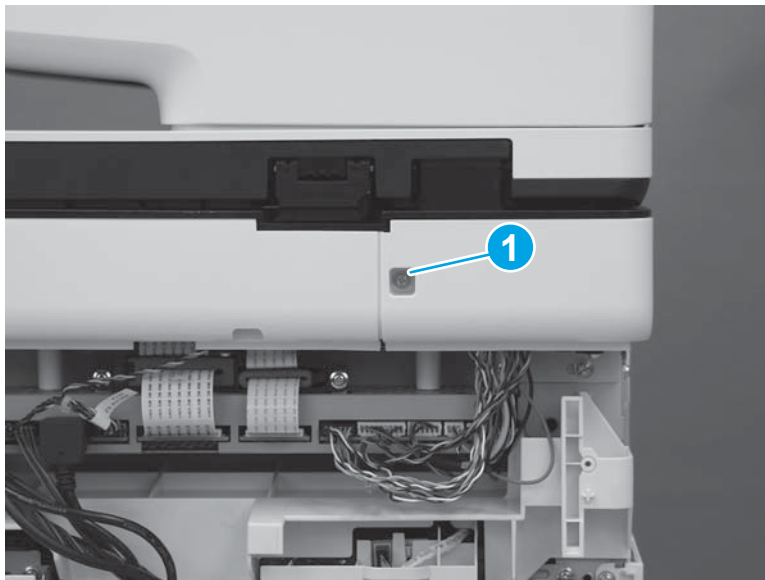

Step 7: Install the left upper cover

1. Position the tab (callout 1) on the lower edge of the cover behind the left cover (callout 2).

Figure 1-4823 Position the tab

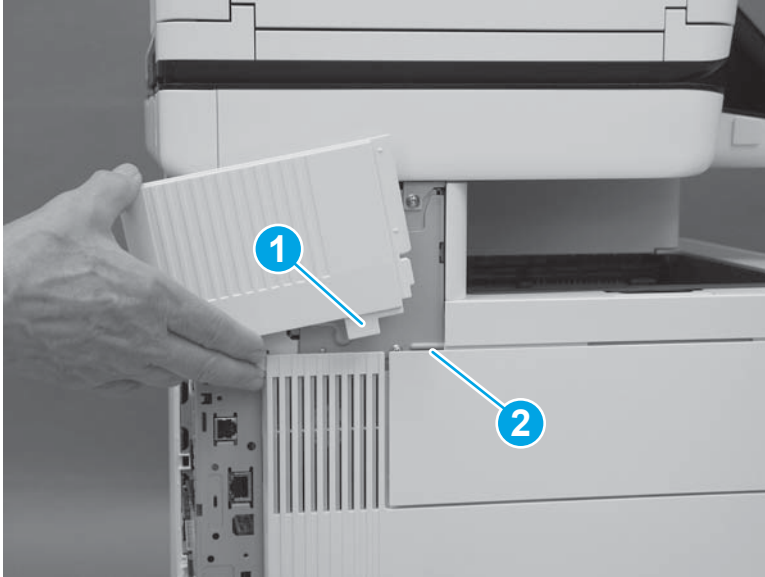

2. Slide the cover toward the front of the printer to install it. Make sure that the edge (callout 1) of the cover fits behind the edge (callout 2) of the top rear cover.

Figure 1-4824 Slide the cover

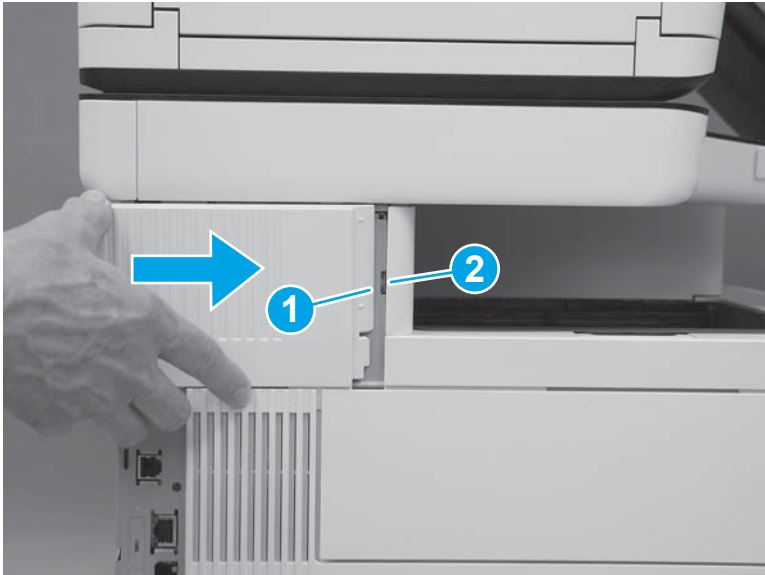

3. Make sure that the tab (callout 1) is fully installed.

Figure 1-4825 Check the tab

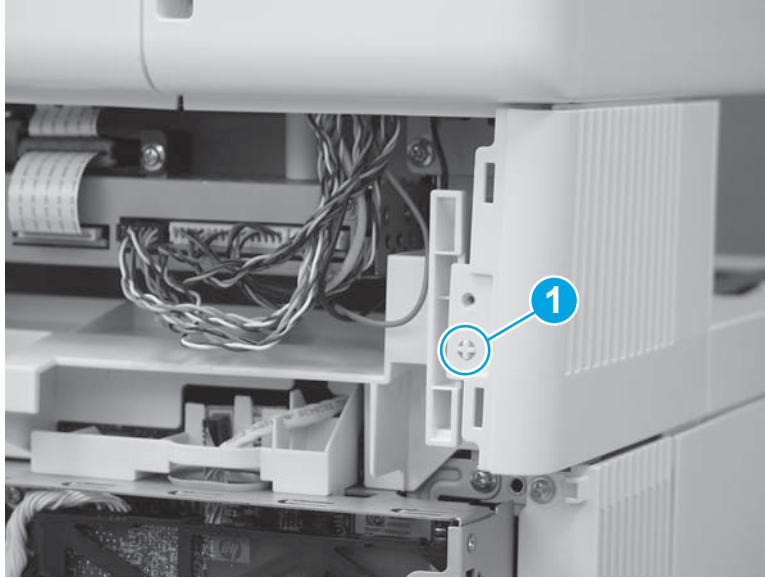

Step 8: Install the rear upper cover

1. Align the ridge (callout 1) on the lower edge of the rear upper cover in front of the tabs (callout 2) on the top edge of the rear cover.

Figure 1-4826 Align the cover

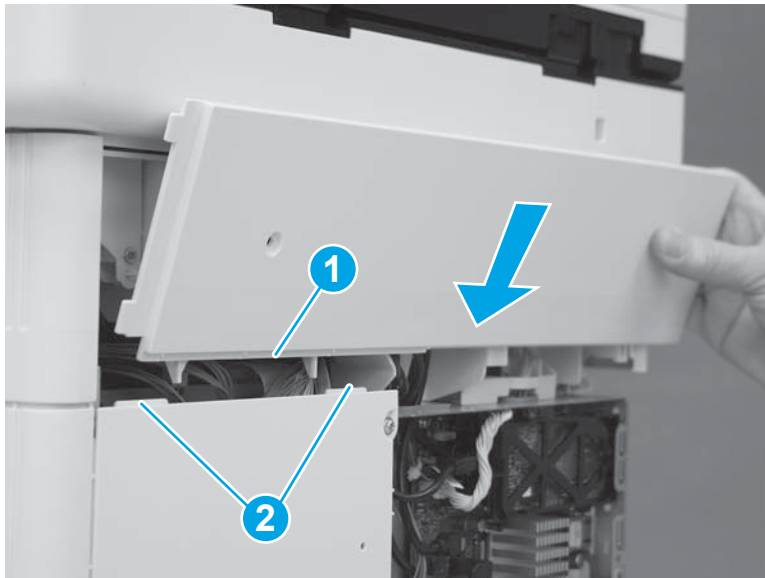

2. Rotate the top of the cover toward the printer.

Figure 1-4827 Rotate the top of the cover

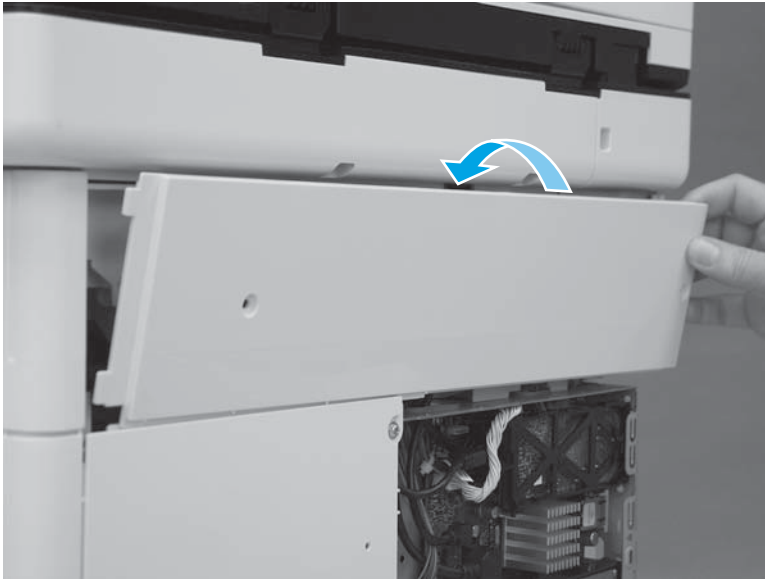

3. Slide the cover to the left (callout 1). Make sure that the tabs (callout 2) on the upper rear cover slide behind the edge (callout 3) of the right upper cover. Make sure that the cover is fully seated.

Figure 1-4828 Slide the cover

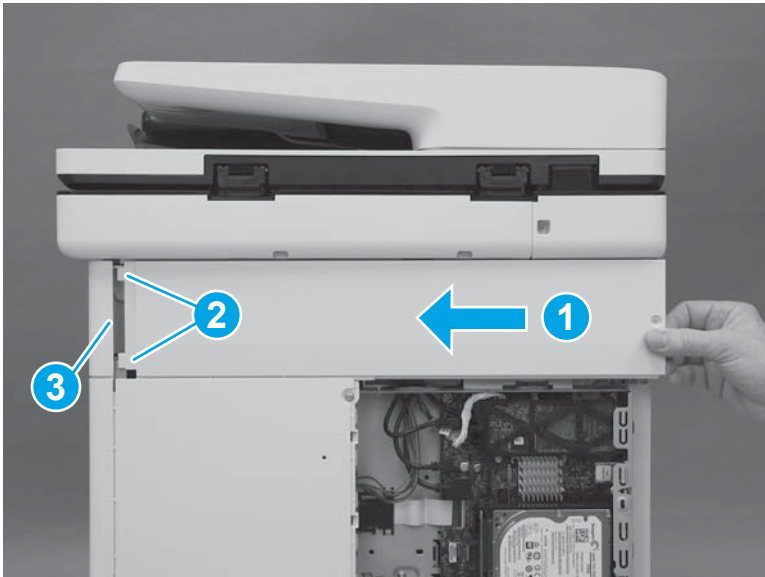

4. Install two screws (callout 1).



 **IMPORTANT:** These two screws are self-tapping screws for plastic. Rotate them counterclockwise to align them with the existing thread pattern, and then carefully turn them clockwise to tighten. Do not overtighten. This will prevent stripping the threads inside the screw holes.

Figure 1-4829 Install two screws

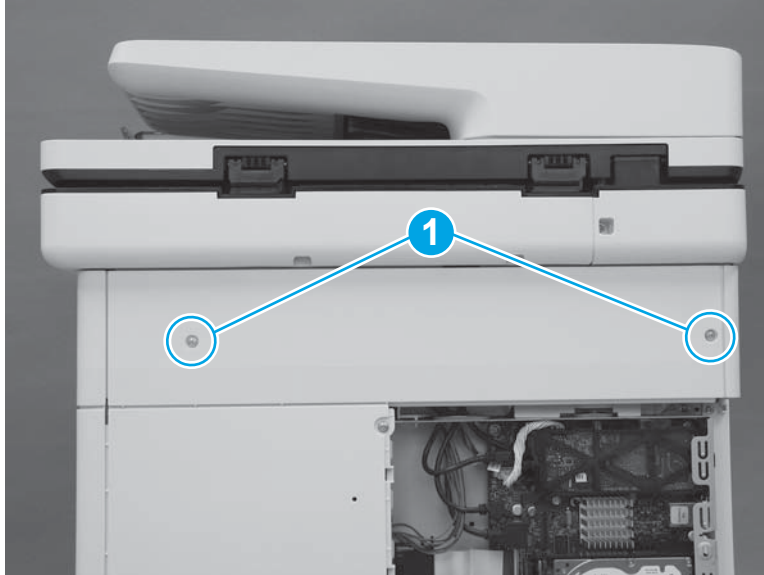

Step 9: Install the formatter cover

- ▲ Slide the cover onto the printer (callout 1) to install it.

 **NOTE:** Make sure that the tabs on the formatter cover align with the slots provided in the printer (callout 2). Tighten the two thumbscrews (callout 3).

 **TIP:** If needed, use the edge of a coin to turn the thumbscrews.

Figure 1-4830 Install the cover



Step 10: Reset the firmware counter

1. From the Home screen on the control panel, scroll to and touch the [Device Maintenance](#) button.
2. Scroll to and touch the [Service](#) button.
3. On the sign-in screen, select the [Service Access Code](#) option from the drop-down list.
4. Enter the following service access code for this printer: 11057715.
5. Scroll to and touch the [Cycle Counts](#) Item.
6. Reset the following items:
 - [Document Feeder Kit Interval](#); set to zero
 - [ADF Count](#); set to zero

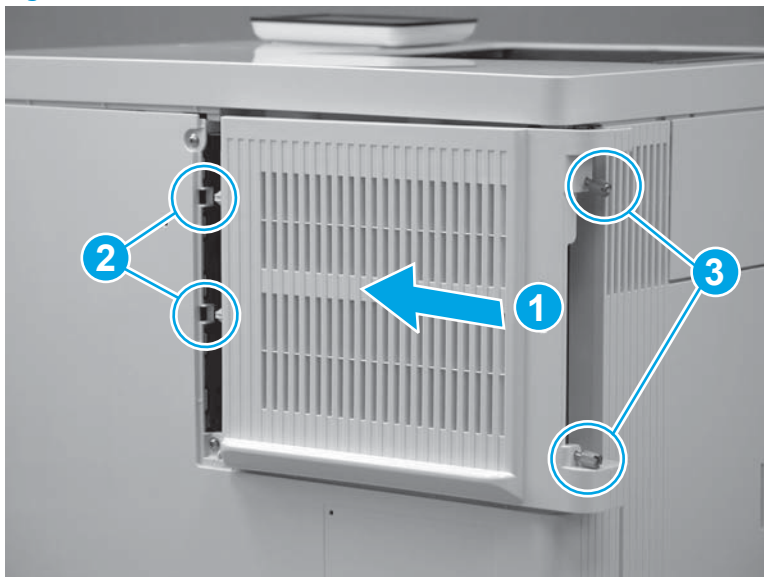
Removal and replacement: Scanner control board (SCB) (M577)

- [Introduction](#)
- [Step 1: Remove the formatter cover](#)
- [Step 2: Remove the rear upper cover](#)
- [Step 3: Remove the scanner control board \(SCB\)](#)
- [Step 4: Unpack the replacement assembly](#)
- [Step 5: Install the SCB](#)
- [Step 6: Install the rear upper cover](#)
- [Step 7: Install the formatter cover](#)

Introduction

This document provides the procedures to remove and replace the scanner control board (SCB) (M577).

Before performing service

Turn the printer power off

- Disconnect the power cable.

 **WARNING!** To avoid damage to the printer, turn the printer off, wait 30 seconds, and then remove the power cord before attempting to service the printer.

Use the table below to identify the correct part number for your printer. To order the part, go to www.hp.com/buy/parts.

Scanner control board (M577) part number	
B5L47-67903	Scanner control board (M577) kit with instruction guide

Required tools

- No special tools are required for this assembly.

After performing service

Turn the printer power on

- Connect the power cable.
- Use the power switch to turn the power on.

Post service test

Print a configuration page to make sure that the printer is functioning correctly.

Step 1: Remove the formatter cover

1. Locate the formatter cover.

Figure 1-4831 Locate the formatter cover

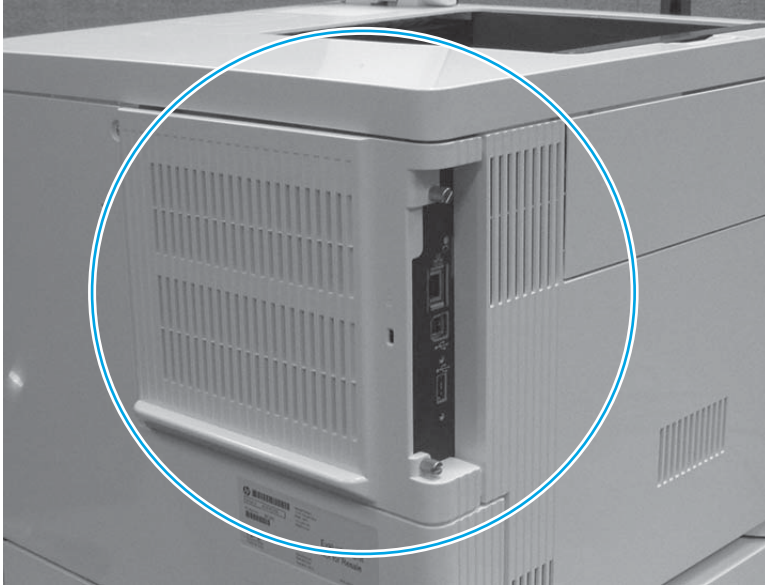

2. Loosen the two thumbscrews (callout 1). Grasp the two thumbscrews, and then slide the cover away from the printer (callout 2) to remove it.

 **TIP:** If needed, use the edge of a coin to turn the thumbscrews.

Figure 1-4832 Loosen the thumbscrews



Step 2: Remove the rear upper cover

1. Remove two screws (callout 1).

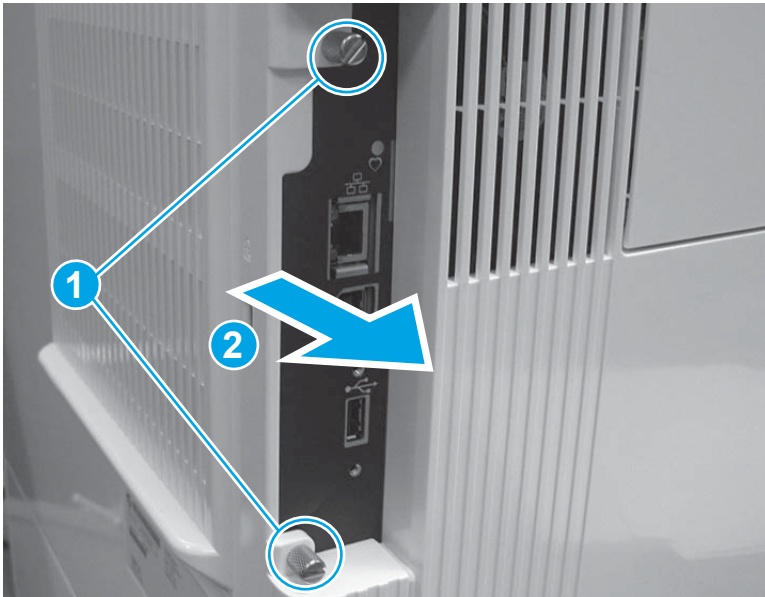
 **Reinstallation tip:** These two screws are self-tapping screws for plastic. When reinstalling them, rotate the screws counterclockwise to align them with the existing thread pattern, and then carefully turn them clockwise to tighten. Do not overtighten. This will prevent stripping the threads inside the screw holes.

Figure 1-4833 Remove two screws



2. Use a small, flat blade screwdriver to release the right edge of the cover.

Figure 1-4834 Release the right edge

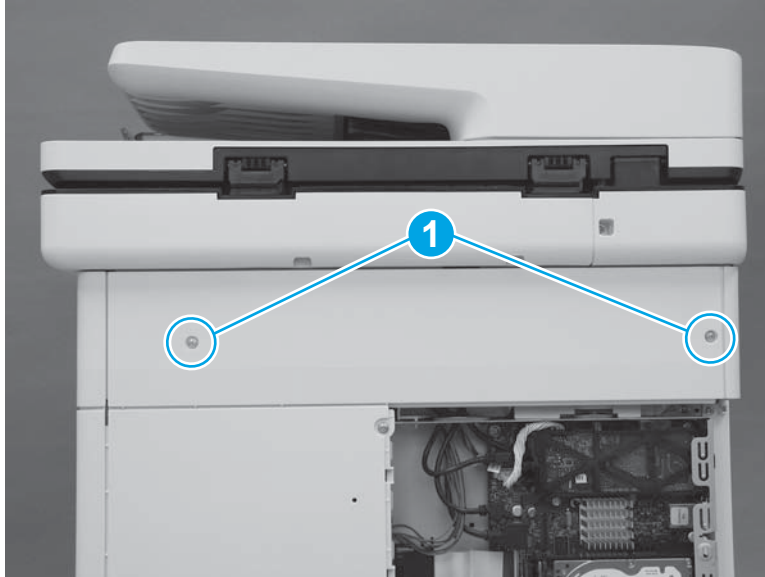
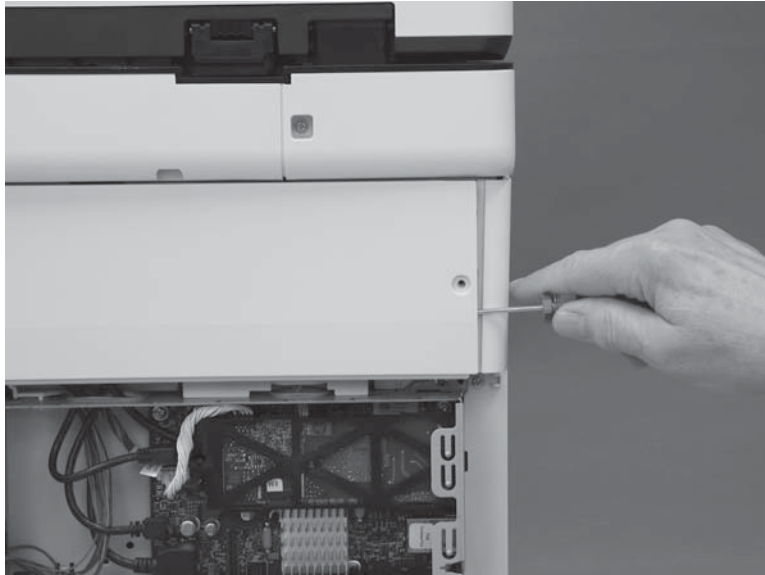

3. Pull the right edge of the cover (callout 1) away from the printer, and then slide the cover to the right (callout 2).

Figure 1-4835 Slide the cover right

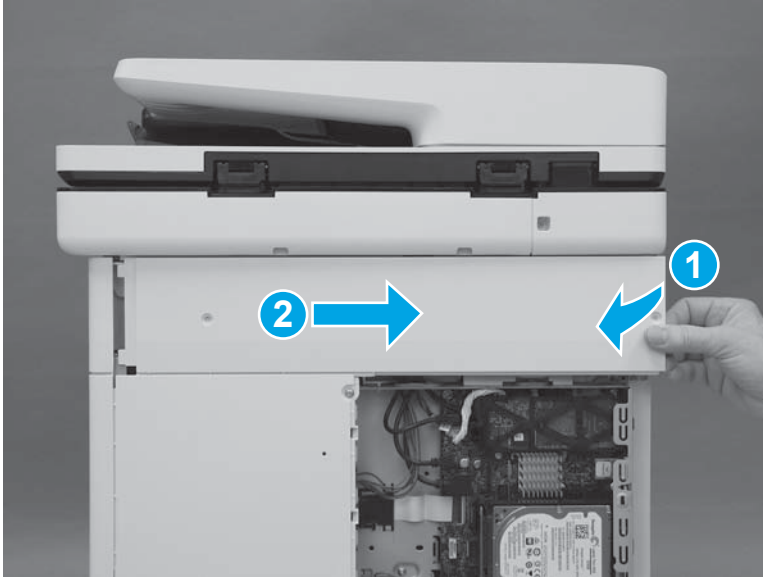

4. Remove the cover.

Figure 1-4836 Remove the cover

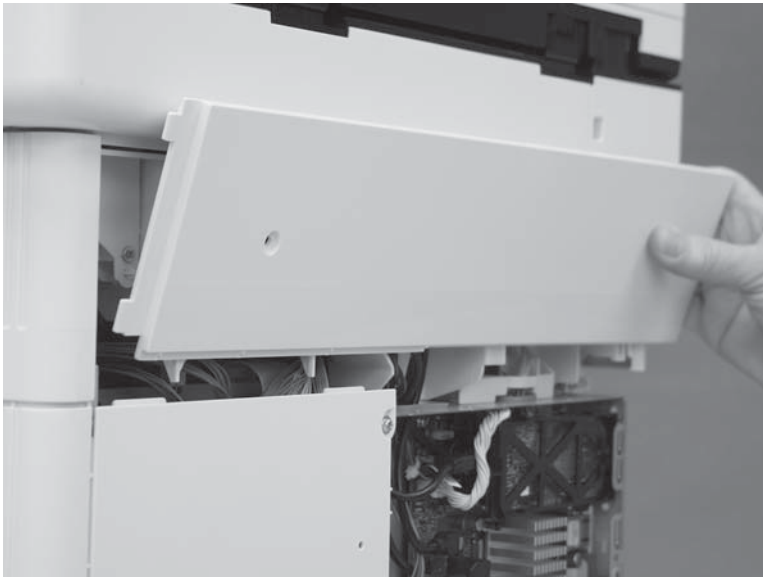

Step 3: Remove the scanner control board (SCB)

1. Disconnect all of the connectors (callout 1) from the SCB.

 **Reinstallation tip:** There are eight wire-harness connectors, two flat cables, and one high-definition multimedia interface (HDMI) cable connector.

Figure 1-4837 Disconnect all of the connectors



2. Disconnect three connectors (callout 1) from the formatter, and then release three black cables through the opening (callout 2) in the formatter case.

Figure 1-4838 Disconnect three connectors

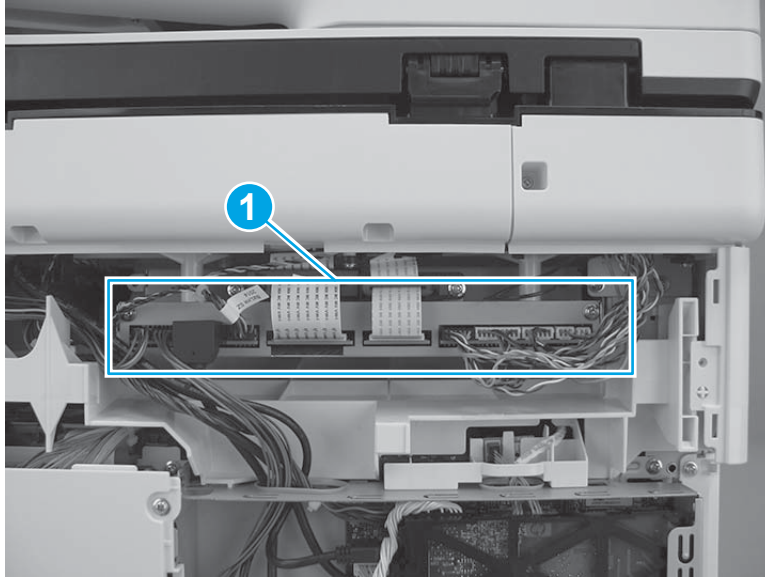
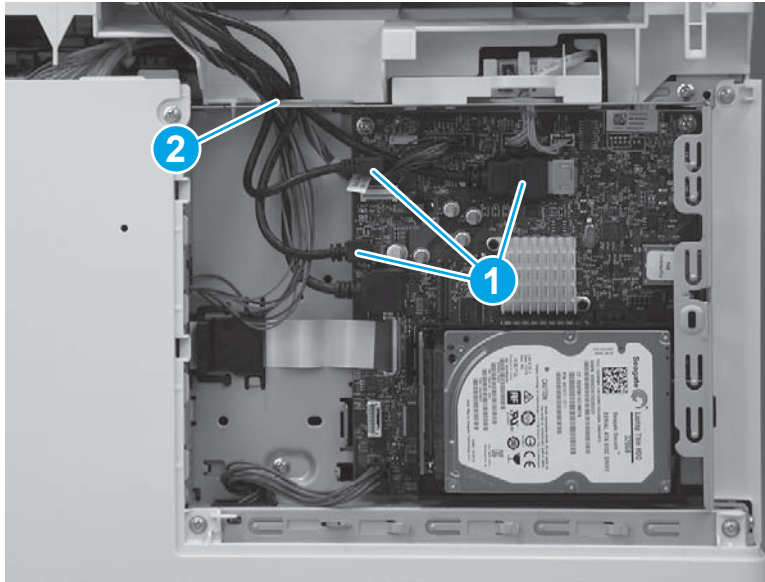

3. Remove two screws (callout 1).

Figure 1-4839 Remove two screws

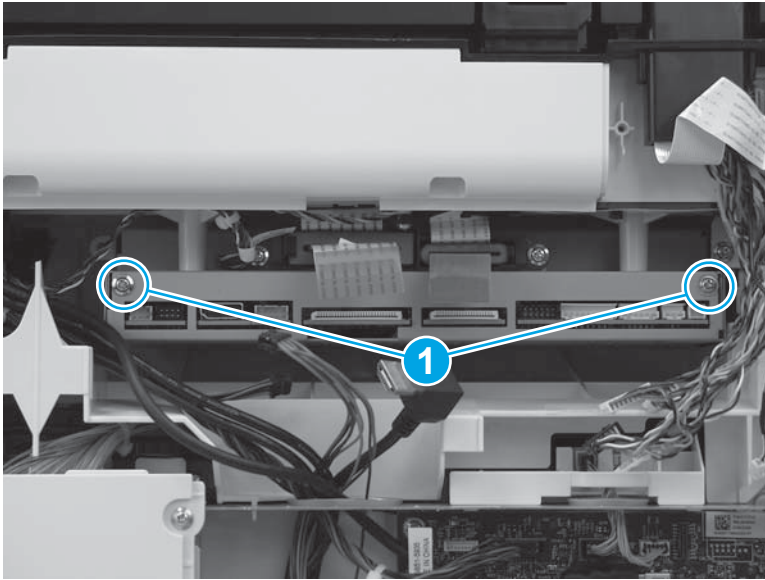

4. Remove the cables (callout 1) from the guide (callout 2), and then lower the SCB (callout 3).

Figure 1-4840 Slide the SCB out

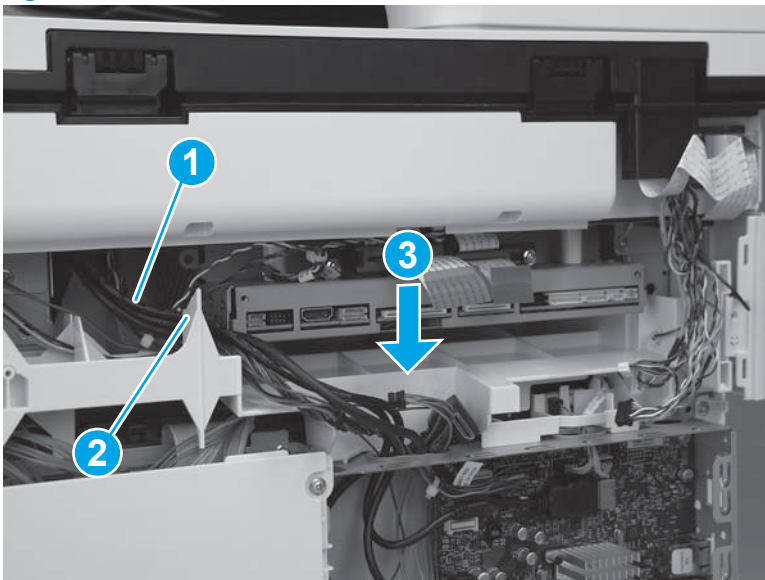

5. Rotate the SCB up and out of the printer. Make sure that the heat sink (callout 1) on the SCB does not get caught on the edge of the sheet metal (callout 2).

Figure 1-4841 Remove the SCB

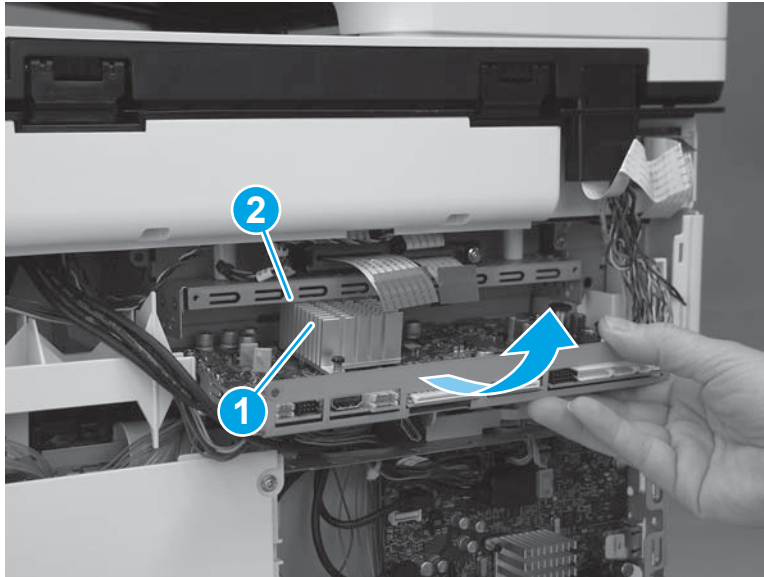

Step 4: Unpack the replacement assembly

Unpack the replacement assembly from the packaging.

For complete information on HP's recycling programs, go to [Product return and recycling](#).

 **NOTE:** HP recommends responsible disposal of the defective part.

Figure 1-4842 Recycle and unpack

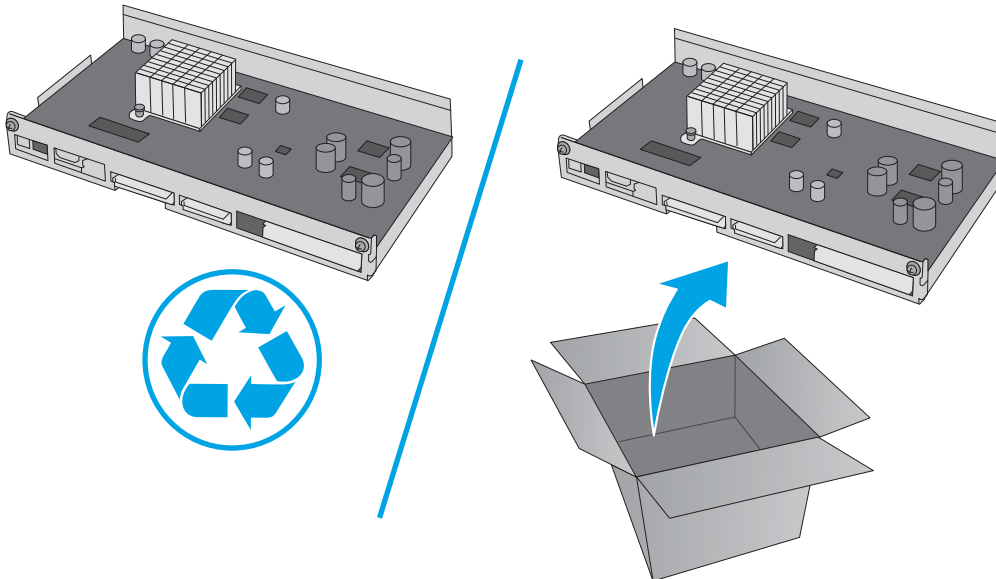

Step 5: Install the SCB

1. Align the slots on the SCB (callout 1) with the tabs (callout 2) inside the printer.

Figure 1-4843 Install the SCB

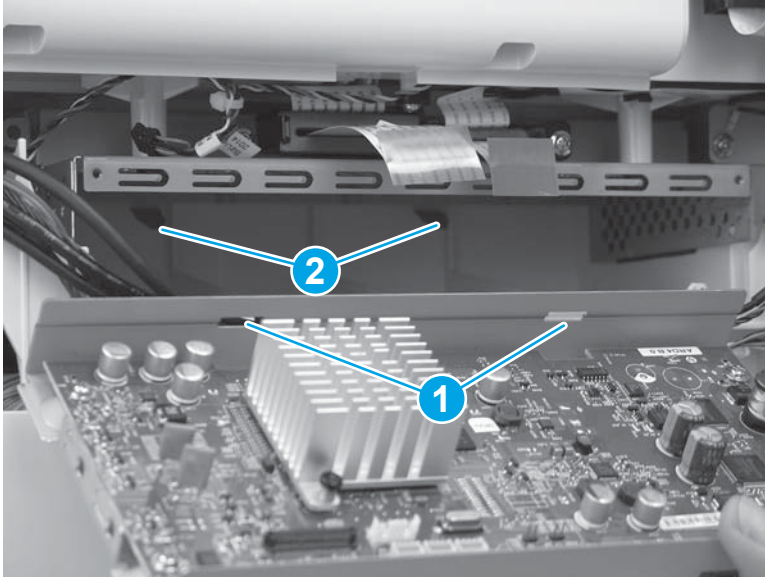

2. Slide the SCB into the printer until it stops. Make sure that the heat sink (callout 1) on the SCB does not get caught on the edge of the sheet metal (callout 2).

Figure 1-4844 Slide the SCB in

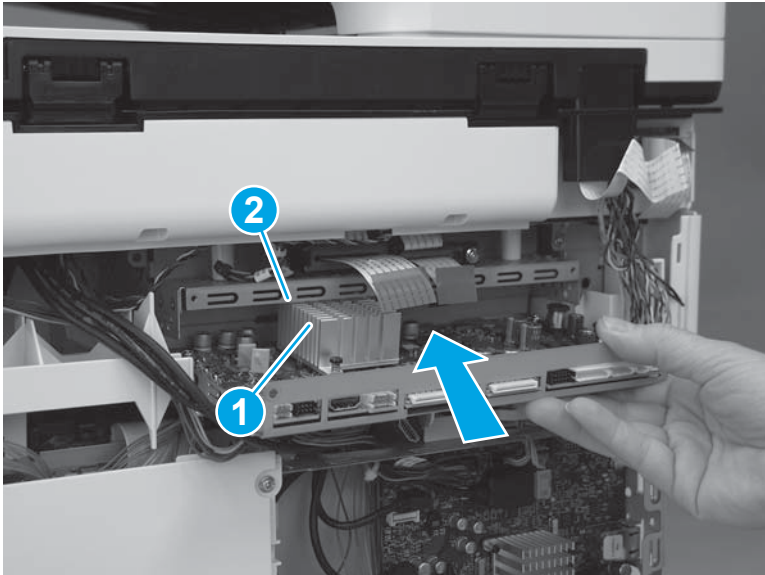

3. Raise the SCB up (callout 1), and then install the cables (callout 2) in the guide (callout 3).

Figure 1-4845 Raise the SCB and install cables

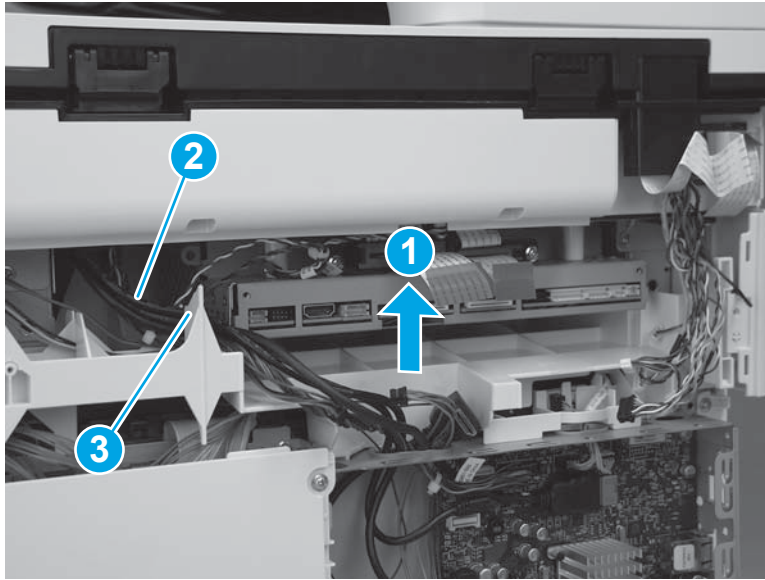

4. Install two screws (callout 1).

Figure 1-4846 Install two screws

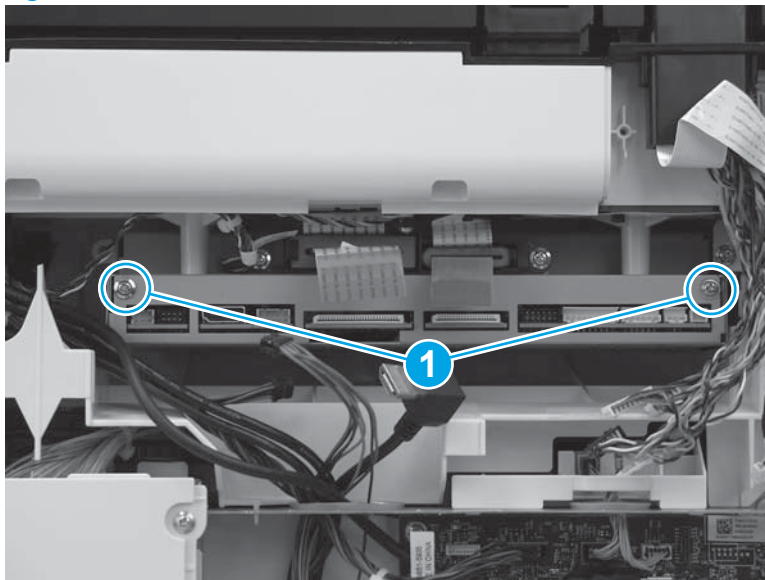

5. Install three black cables through the opening in the formatter case (callout 1), and then connect three connectors on the formatter (callout 2).

Figure 1-4847 Connect three connectors

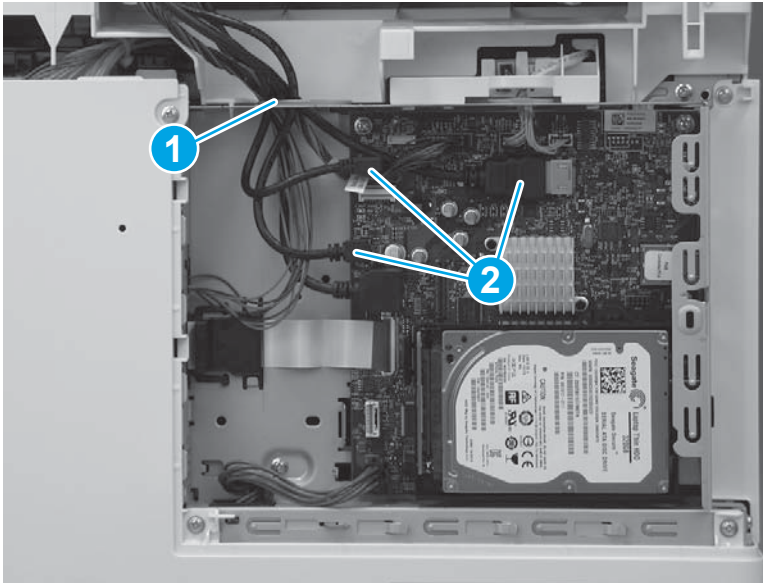

6. Connect all of the connectors (callout 1) to the SCB.

 **Reinstallation tip:** There are eight wire-harness connectors, two flat cables, and one high-definition multimedia interface (HDMI) cable connector.

Figure 1-4848 Connect all of the connectors



Step 6: Install the rear upper cover

1. Align the ridge (callout 1) on the lower edge of the rear upper cover in front of the tabs (callout 2) on the top edge of the rear cover.

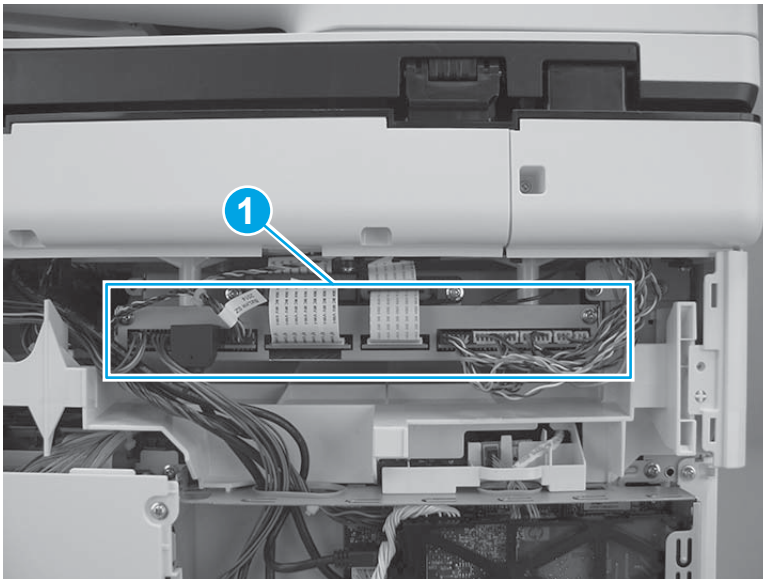
Figure 1-4849 Align the cover

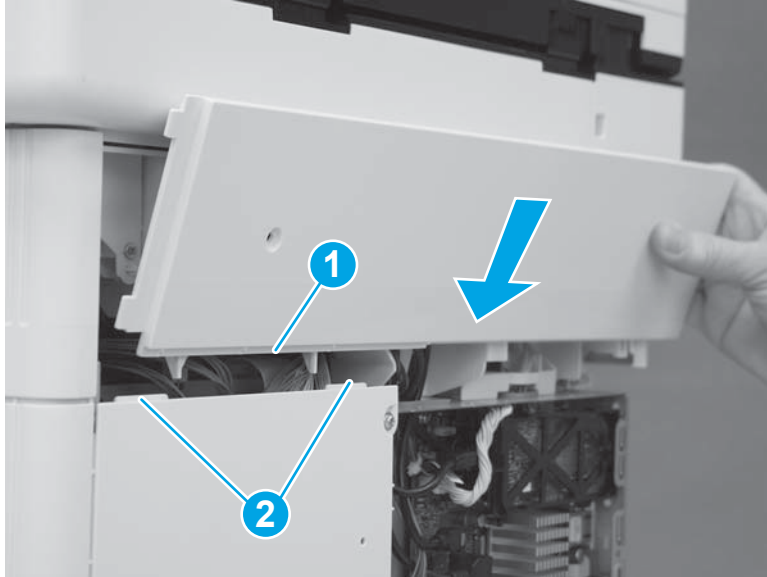

2. Rotate the top of the cover toward the printer.

Figure 1-4850 Rotate the top of the cover

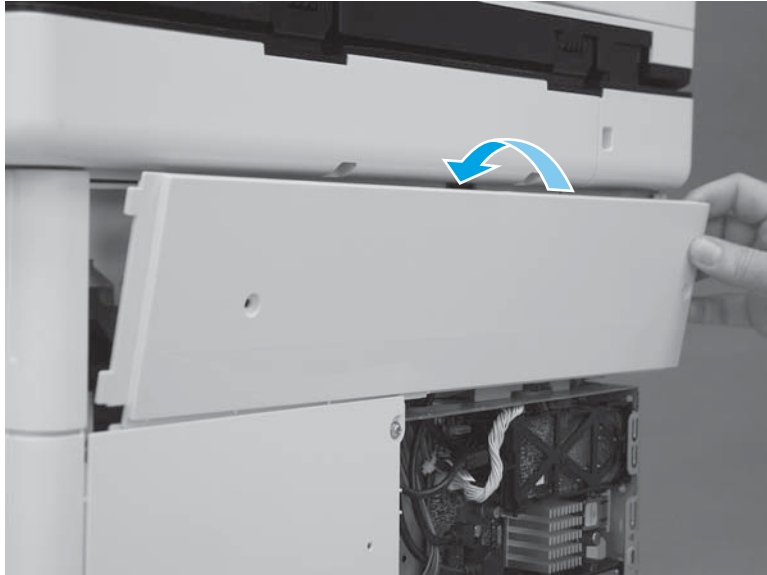

3. Slide the cover to the left (callout 1). Make sure that the tabs (callout 2) on the upper rear cover slide behind the edge (callout 3) of the right upper cover. Make sure that the cover is fully seated.

Figure 1-4851 Slide the cover

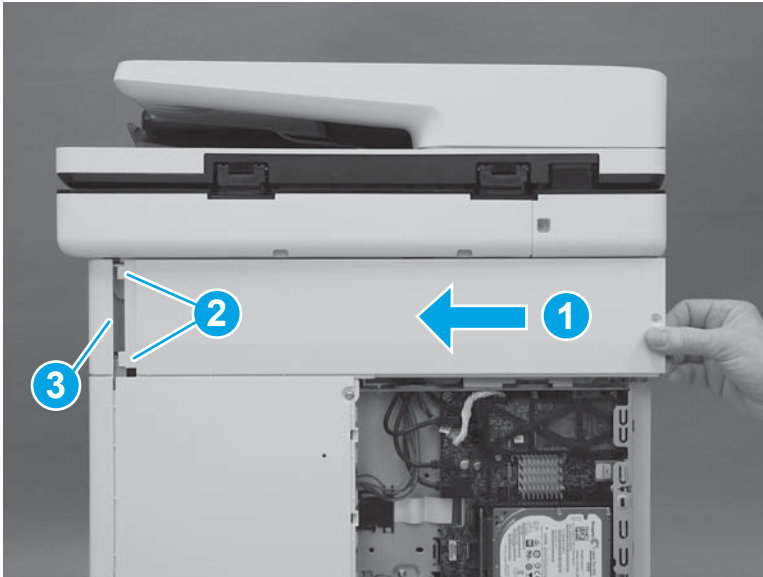

4. Install two screws (callout 1).



 **IMPORTANT:** These two screws are self-tapping screws for plastic. Rotate them counterclockwise to align them with the existing thread pattern, and then carefully turn them clockwise to tighten. Do not overtighten. This will prevent stripping the threads inside the screw holes.

Figure 1-4852 Install two screws

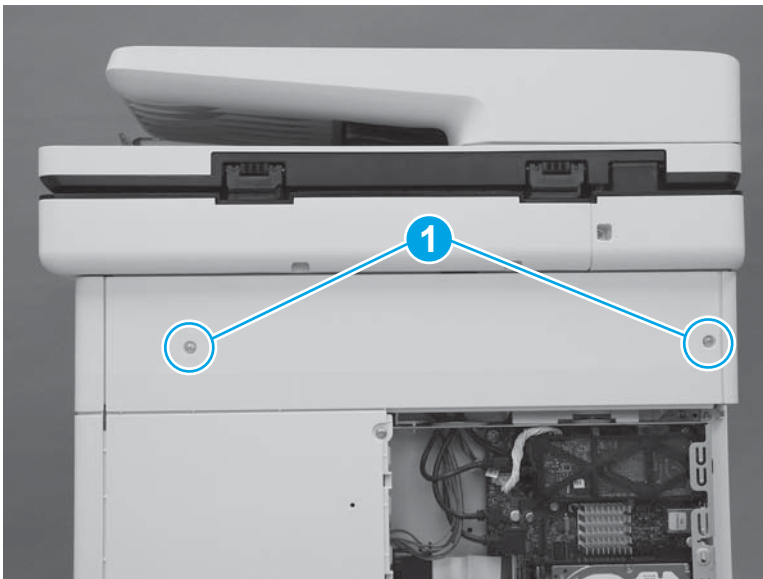

Step 7: Install the formatter cover

- ▲ Slide the cover onto the printer (callout 1) to install it.

 **NOTE:** Make sure that the tabs on the formatter cover align with the slots provided in the printer (callout 2). Tighten the two thumbscrews (callout 3).

 **TIP:** If needed, use the edge of a coin to turn the thumbscrews.

Figure 1-4853 Install the cover



Removal and replacement: Image scanner (M577)

- [Introduction](#)
- [Step 1: Remove the control-panel cover \(M577\)](#)
- [Step 2: Remove the white backing \(M577\)](#)
- [Step 3: Remove the keyboard \(M577c/z\)](#)
- [Step 4: Remove the control panel \(M577\)](#)
- [Step 5: Remove the formatter cover](#)
- [Step 6: Remove the fax PCA \(M577c/f/z\)](#)
- [Step 7: Remove the rear upper cover \(M577\)](#)
- [Step 8: Remove the left upper cover \(M577\)](#)
- [Step 9: Remove the right front upper cover \(M577dn\)](#)
- [Step 10: Remove the stapler cover assembly \(M577c/f/z\)](#)
- [Step 11: Remove the document feeder \(M577\)](#)
- [Step 12: Remove the scanner control board \(SCB\) \(M577\)](#)
- [Step 13: Remove the image scanner assembly \(M577\)](#)
- [Step 14: Unpack the replacement assembly](#)
- [Step 15: Install the image scanner assembly \(M577\)](#)
- [Step 16: Install the scanner control board \(M577\)](#)
- [Step 17: Install the document feeder \(M577\)](#)
- [Step 18: Install the stapler cover assembly \(M577c/f/z\)](#)
- [Step 19: Install the right front upper cover \(M577dn\)](#)
- [Step 20: Install the left upper cover \(M577\)](#)
- [Step 21: Install the rear upper cover \(M577\)](#)
- [Step 22: Install the fax PCA \(M577c/f/z\)](#)
- [Step 23: Install the formatter cover](#)
- [Step 24: Install the control panel \(M577\)](#)
- [Step 25: Install the keyboard \(M577c/z\)](#)
- [Step 26: Install the white backing \(M577\)](#)
- [Step 27: Install the control-panel cover \(M577\)](#)

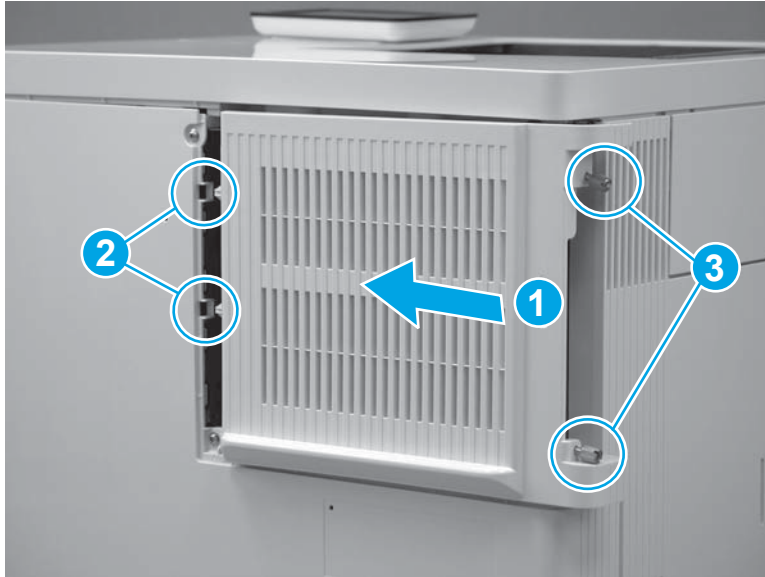
Introduction

This document provides the procedures to remove and replace the image scanner.

Before performing service

Turn the printer power off

- Disconnect the power cable.

 **WARNING!** To avoid damage to the printer, turn the printer off, wait 30 seconds, and then remove the power cord before attempting to service the printer.

Use the table below to identify the correct part number for your printer. To order the part, go to www.hp.com/buy/parts.

Image scanner part number	
B5L46-67904	Image scanner whole unit kit with instruction guide

Required tools

- Small flat-blade screwdriver.
- #2 Phillips screwdriver with a magnetic tip.

After performing service

Turn the printer power on

- Connect the power cable.
- Use the power switch to turn the power on.

Post service test

Print a configuration page, and then make a copy using the flatbed glass to make sure that it is properly functioning.

Print a configuration page, and then make a copy using the document feeder to make sure that it is properly functioning.

Step 1: Remove the control-panel cover (M577)

1. Open the document feeder (callout 1).

 **NOTE:** If the control panel is not fully tilted forward, tilt it forward now until it stops (callout 2).

Figure 1-4854 Open the document feeder



2. Beginning at the right side of the control-panel cover, carefully release five tabs along the top edge of the cover.



NOTE: The thin, black plastic cover will separate from the white plastic control-panel base.

Figure 1-4855 Release five tabs

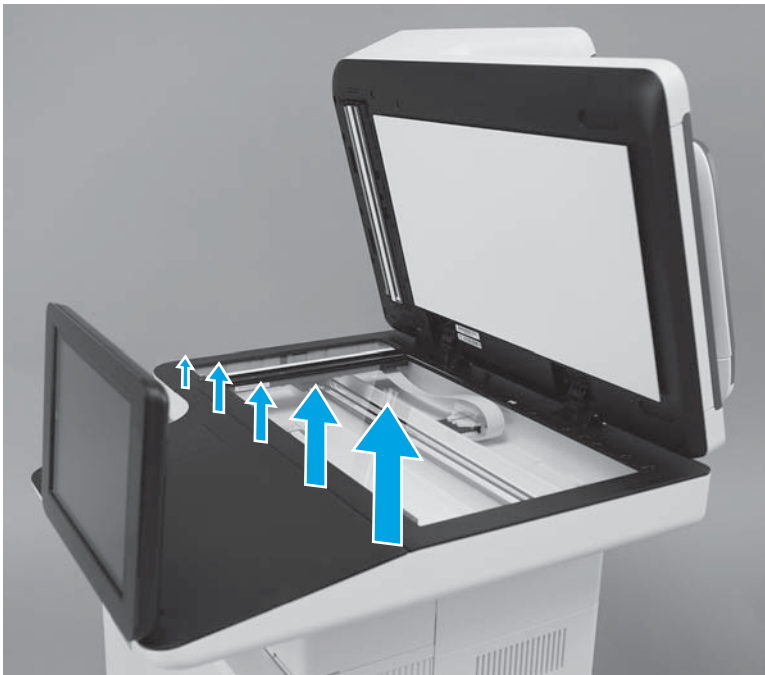

3. Continue to lift the top edge of the cover away from the printer, and then remove the cover.

Figure 1-4856 Remove the cover



Step 2: Remove the white backing (M577)

 **IMPORTANT:** When a replacement image scanner is installed, the white backing on the document feeder must be removed, and then a replacement white backing (supplied in the kit) must be installed.

1. Remove the white backing.

Figure 1-4857 Remove the white backing



2. One or more of the retention clips (callout 1) that fit in the openings (callout 2) in the document feeder might remain attached to the white backing when it is removed. If this happens, remove the clip from the white backing.

 **NOTE:** If none of the retention clips remain attached to the white backing, skip the remaining sub-steps in this removal procedure.

Figure 1-4858 Check the retention clips



3. If a spring comes off of a retention clip, make sure that it is correctly repositioned on the clip.

 **NOTE:** If any of the retention clips or springs are damaged, replace them with the clips supplied in this kit.

Figure 1-4859 Check the retention clip spring



4. Install the clip (callout 1) in the opening (callout 2) in the document feeder.

Figure 1-4860 Install the retention clip

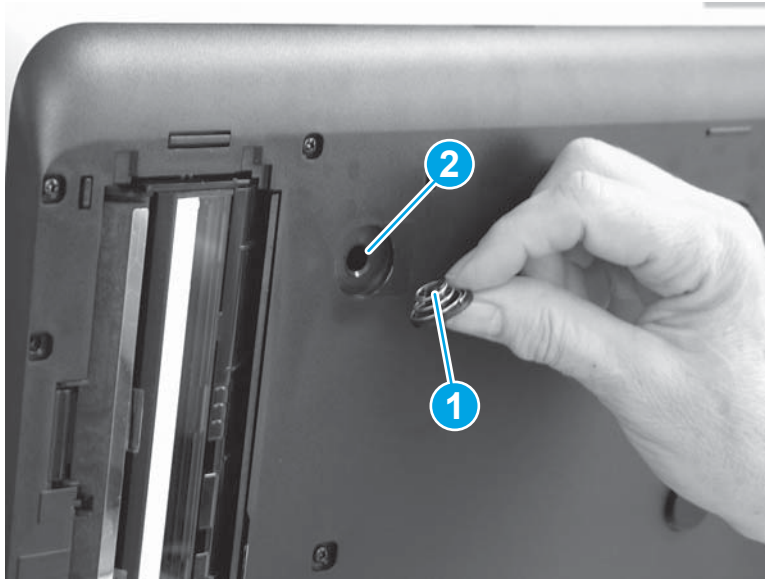

5. Press the clip to make sure it is securely installed.

Figure 1-4861 Press the retention clip

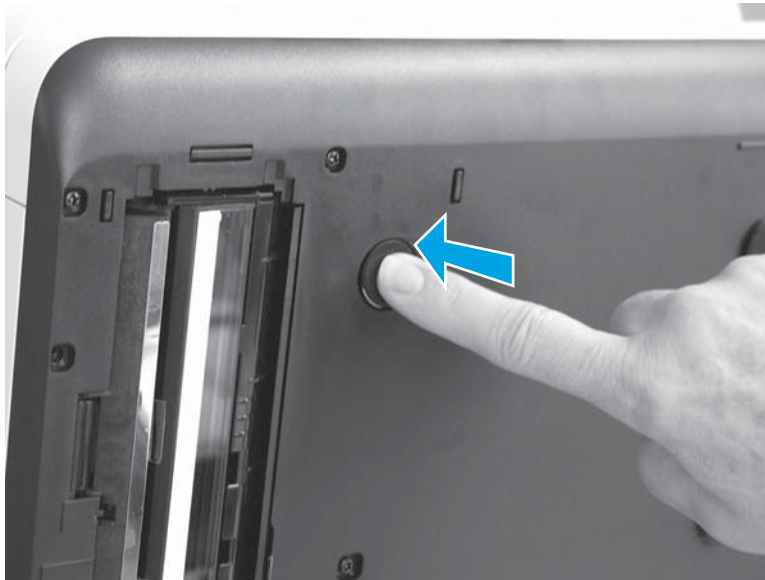

Step 3: Remove the keyboard (M577c/z)

 **NOTE:** This step is for the M577c/z models. For the M577dn/f models, skip this step and go to [Step 4: Remove the control panel \(M577\) on page 2697](#).

1. Open the latch (callout 1) to release the keyboard flat cable.

 **CAUTION:** The latch must be opened to release the cable.

Figure 1-4862 Disconnect the keyboard flat cable

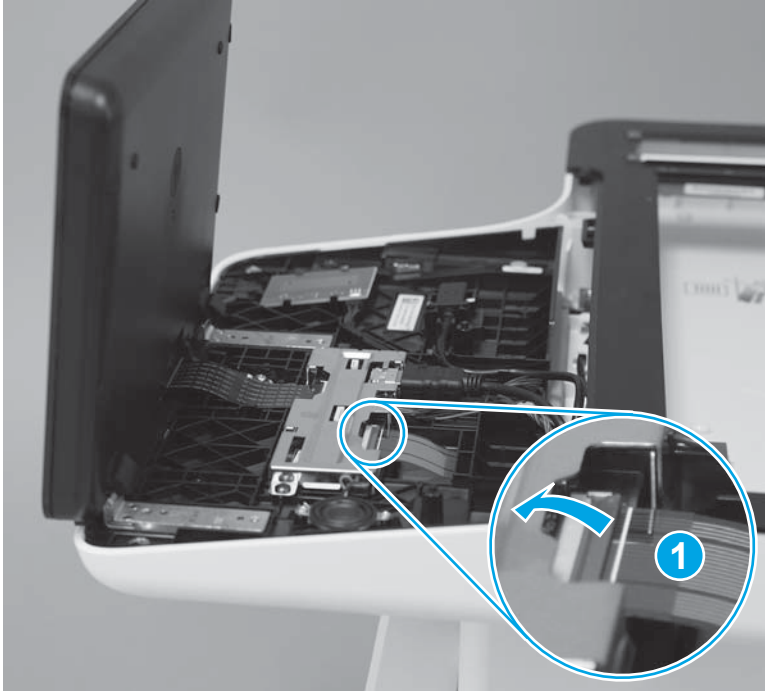

2. Slide the keyboard tray out until it stops.

Figure 1-4863 Slide the keyboard out



3. Push up on the keyboard tray to release two tabs on the bottom of the tray, and then slide the tray toward the front of the printer to disengage the tabs.

Figure 1-4864 Release two tabs

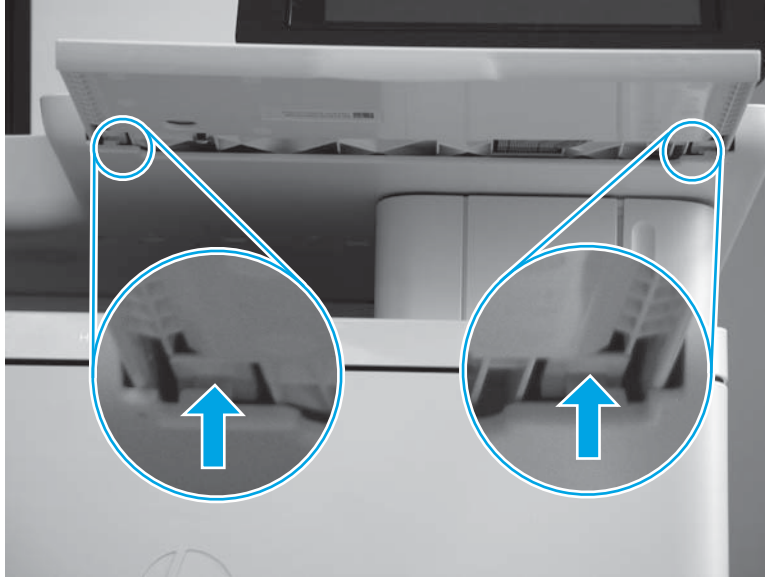

4. Slide the keyboard (callout 1) all of the way out of the printer to remove it.

Figure 1-4865 Remove the keyboard



Step 4: Remove the control panel (M577)

1. Disconnect one HDMI cable (callout 1) and one connector (callout 2).

Figure 1-4866 Disconnect connectors

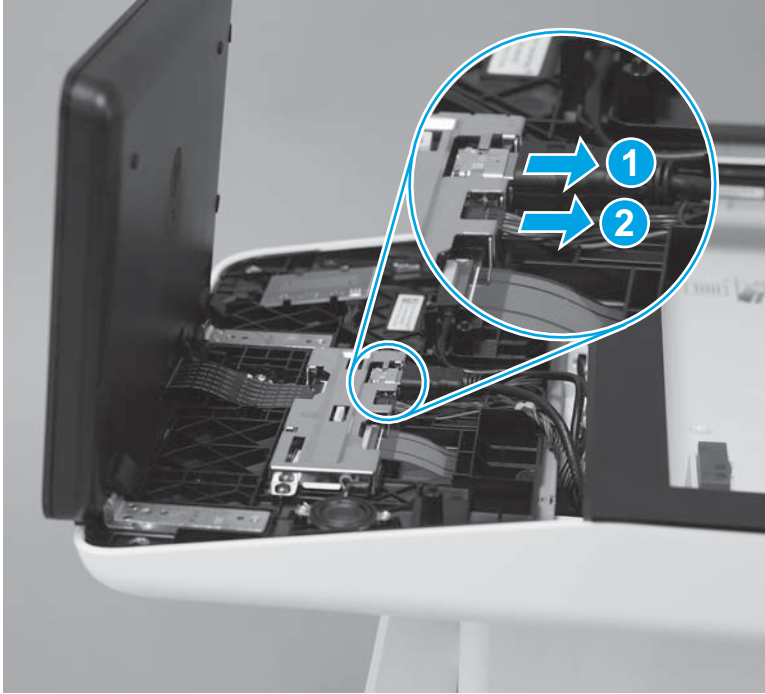

2. Remove the USB cable (callout 1) from the holder.
M577z only: Disconnect one connector (callout 2).

Figure 1-4867 Disconnect connectors

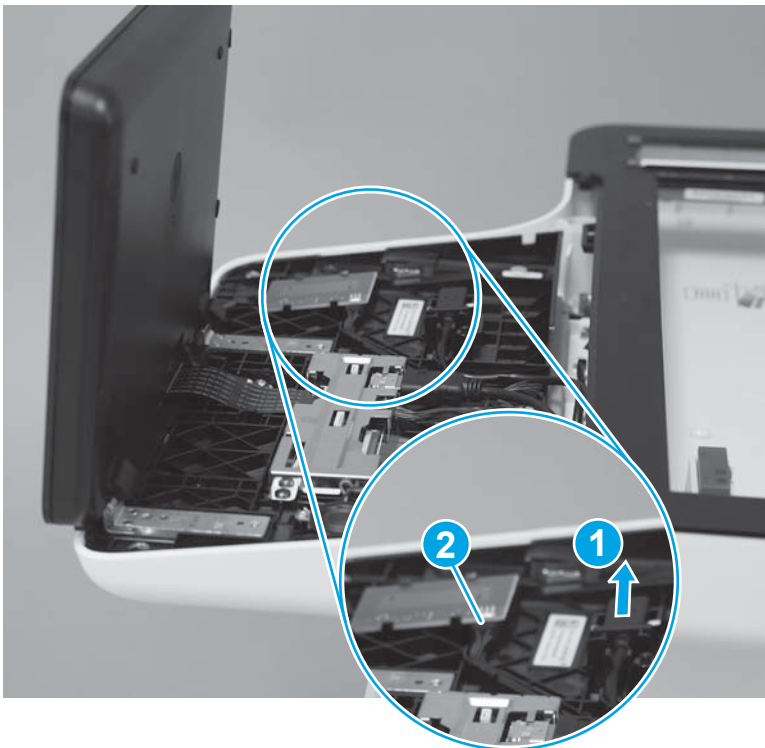

3. Remove three screws (callout 1).

Figure 1-4868 Remove three screws

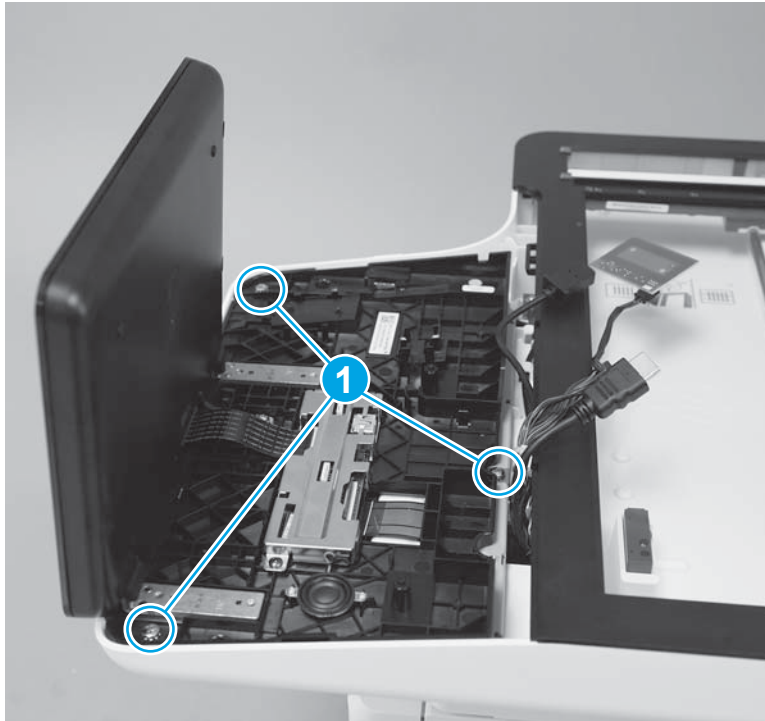

4. Lift the front of the control panel off of the printer (callout 1), and then slide it towards the front of the printer (callout 2) to remove it.

Figure 1-4869 Remove the control panel



Step 5: Remove the formatter cover

1. Locate the formatter cover.

Figure 1-4870 Locate the formatter cover

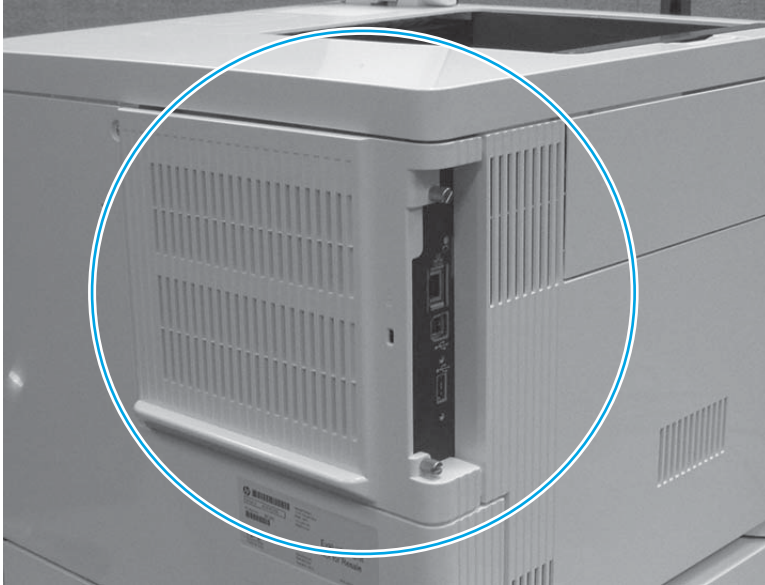

2. Loosen the two thumbscrews (callout 1). Grasp the two thumbscrews, and then slide the cover away from the printer (callout 2) to remove it.

 **TIP:** If needed, use the edge of a coin to turn the thumbscrews.

Figure 1-4871 Loosen the thumbscrews

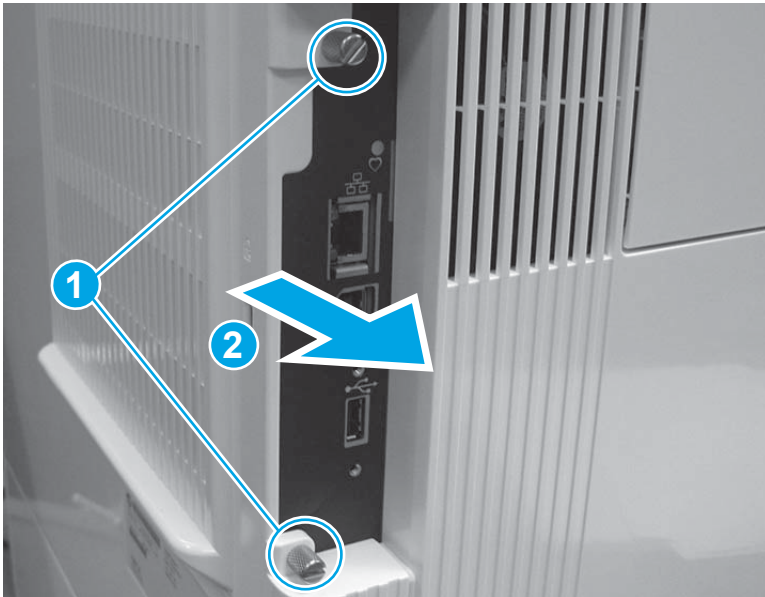

Step 6: Remove the fax PCA (M577c/f/z)

 **NOTE:** This step is for the M577c/f/z models. For the M577dn model, skip this step and go to [Step 7: Remove the rear upper cover \(M577\)](#) on page 2702.

 **CAUTION:**  ESD-sensitive part.

1. Locate the fax PCA component on the formatter.

Figure 1-4872 Locate the fax PCA

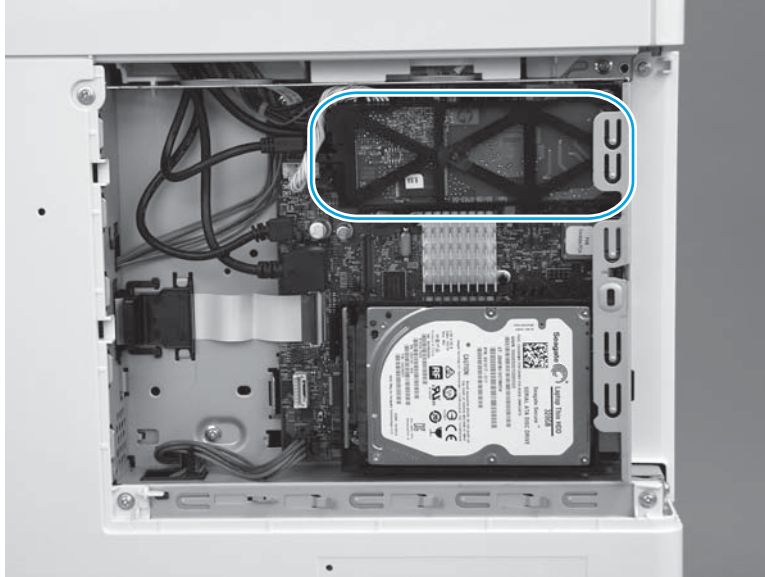

2. Release the connector latch (callout 1), and then pull the connector away from the formatter (callout 2) to disconnect it.

Figure 1-4873 Disconnect one connector

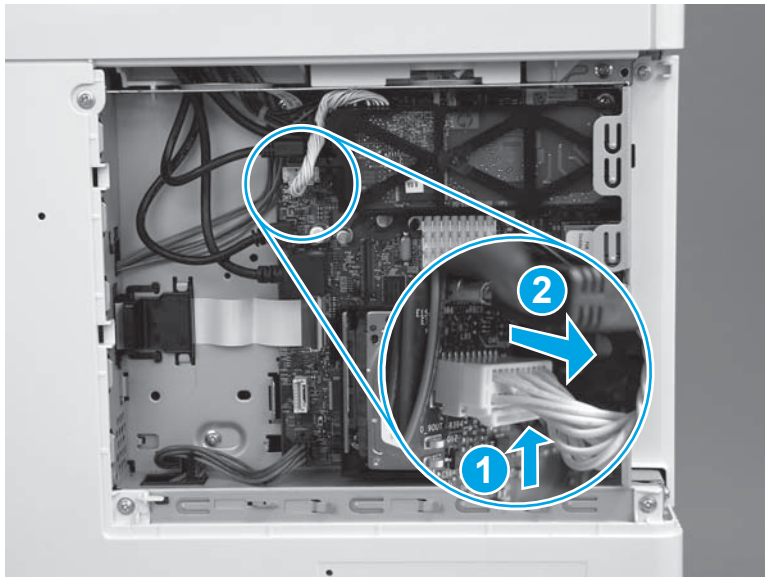

3. Release one retainer (callout 1) by pressing the bracket arms together.

Figure 1-4874 Release one latch

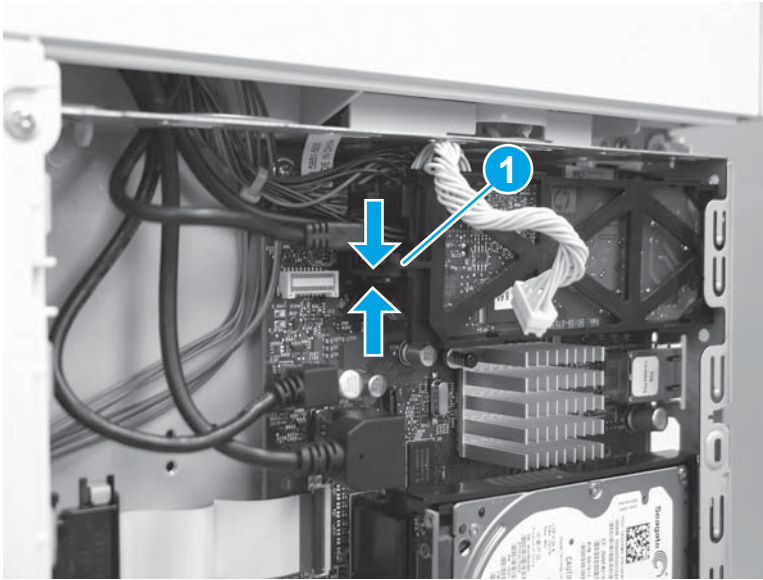

4. Rotate the end of the fax PCA (callout 1) away from the formatter, and then slide the PCA left (callout 2) to remove it.

Figure 1-4875 Remove the fax PCA

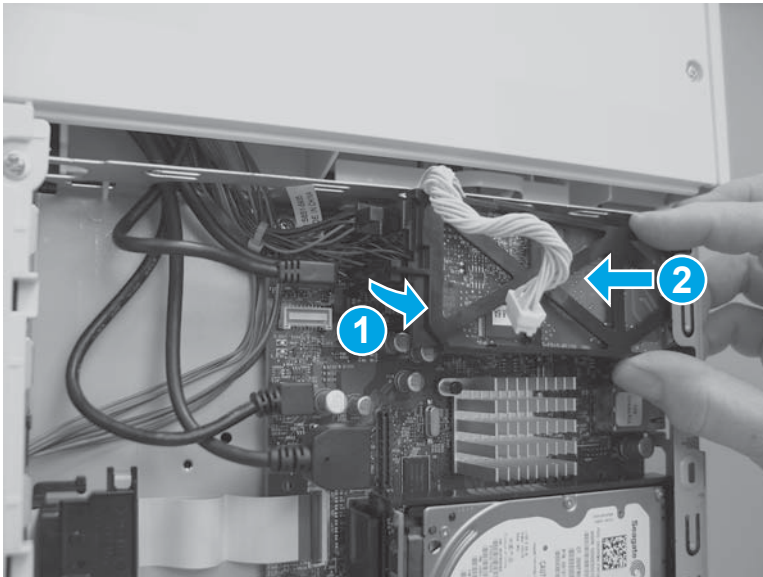

Step 7: Remove the rear upper cover (M577)

1. Remove two screws (callout 1).

 **Reinstallation tip:** These two screws are self-tapping screws for plastic. When reinstalling them, rotate the screws counterclockwise to align them with the existing thread pattern, and then carefully turn them clockwise to tighten. Do not overtighten. This will prevent stripping the threads inside the screw holes.

Figure 1-4876 Remove two screws



2. Use a small, flat blade screwdriver to release the right edge of the cover.

Figure 1-4877 Release the right edge

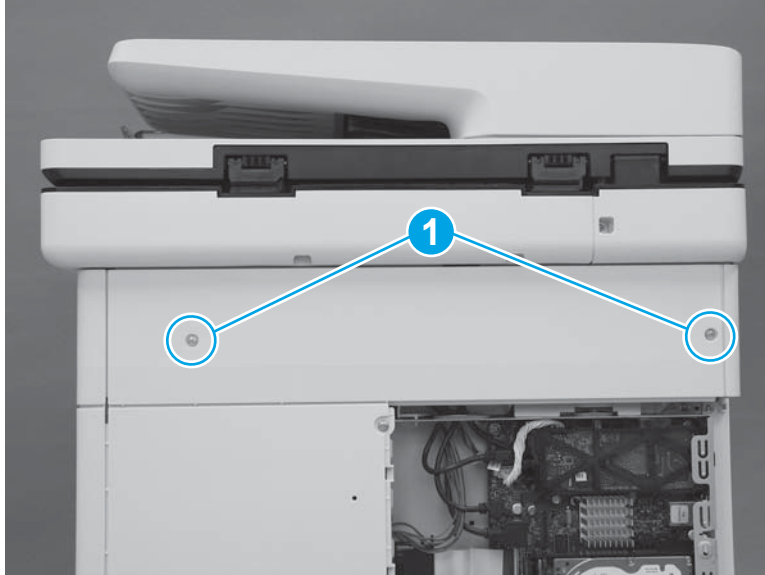
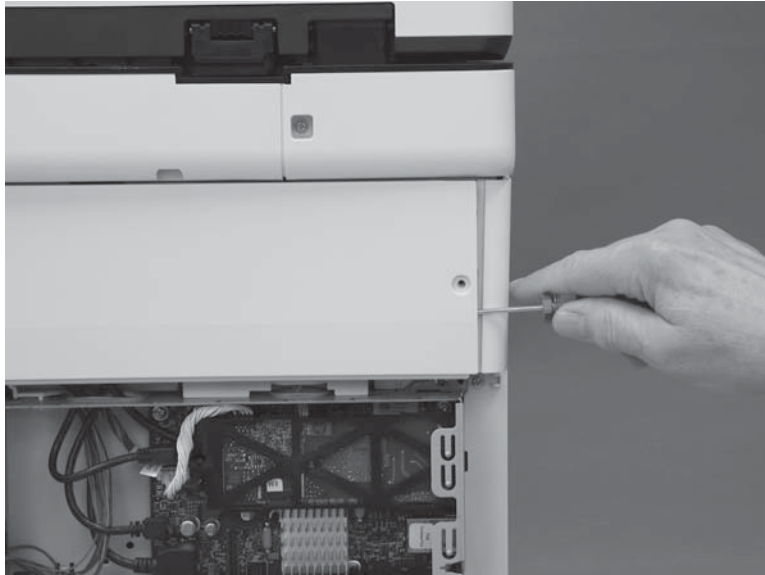

3. Pull the right edge of the cover (callout 1) away from the printer, and then slide the cover to the right (callout 2).

Figure 1-4878 Slide the cover right

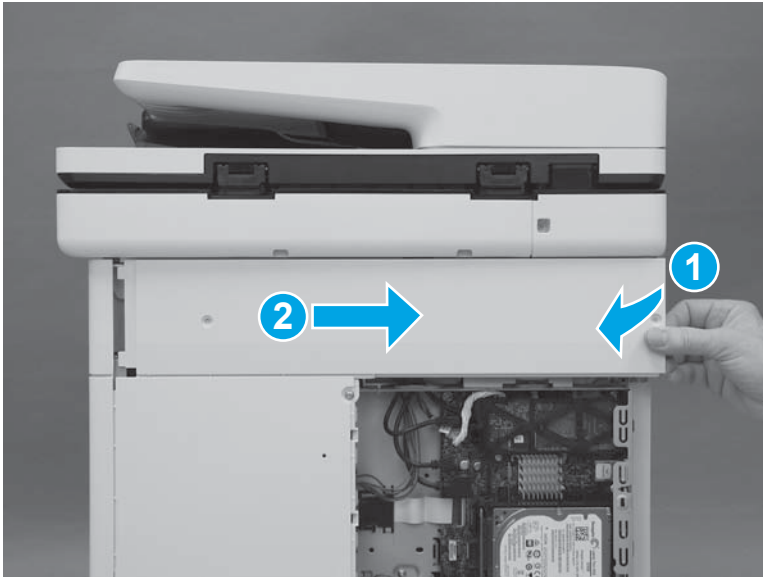

4. Remove the cover.

Figure 1-4879 Remove the cover

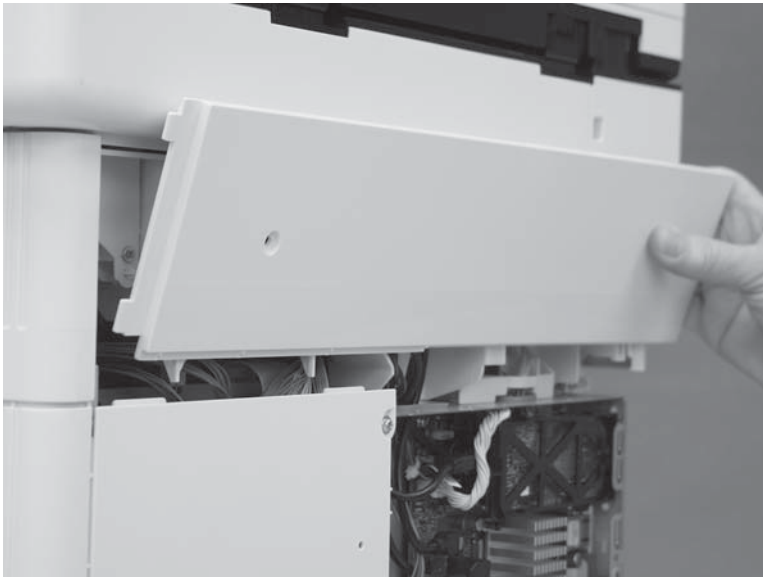

Step 8: Remove the left upper cover (M577)

1. At the left side of the printer, release one tab (callout 1).

Figure 1-4880 Release one tab

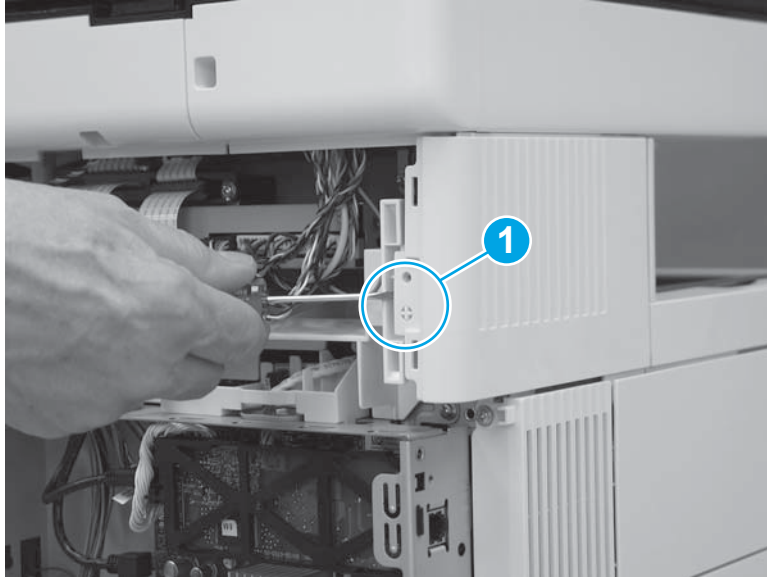

2. Slide the left upper cover toward the back of the printer.

Figure 1-4881 Slide the cover back

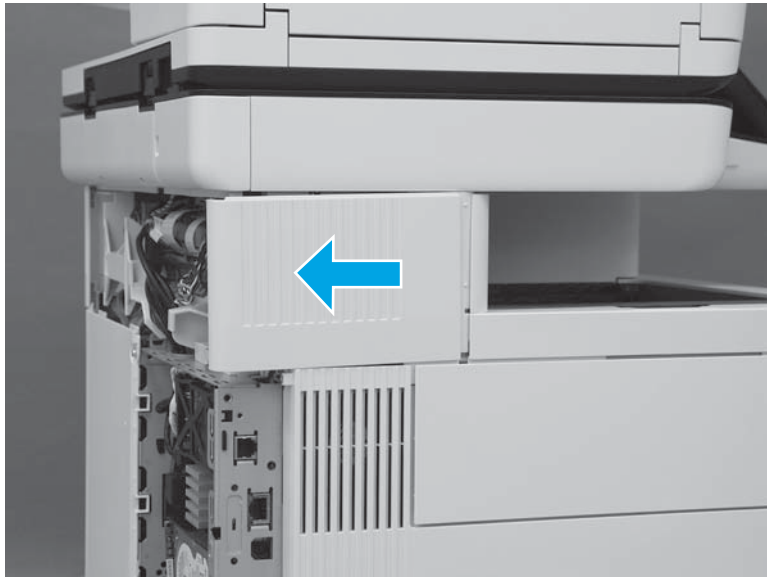

3. Rotate the cover up to remove it.

Figure 1-4882 Remove the left upper cover



Step 9: Remove the right front upper cover (M577dn)



NOTE: This step is for the M577dn model. For the M577c/f/z models, skip this step and go to [Step 10: Remove the stapler cover assembly \(M577c/f/z\) on page 2707.](#)

1. Remove one screw (callout 1).

Figure 1-4883 Remove one screw

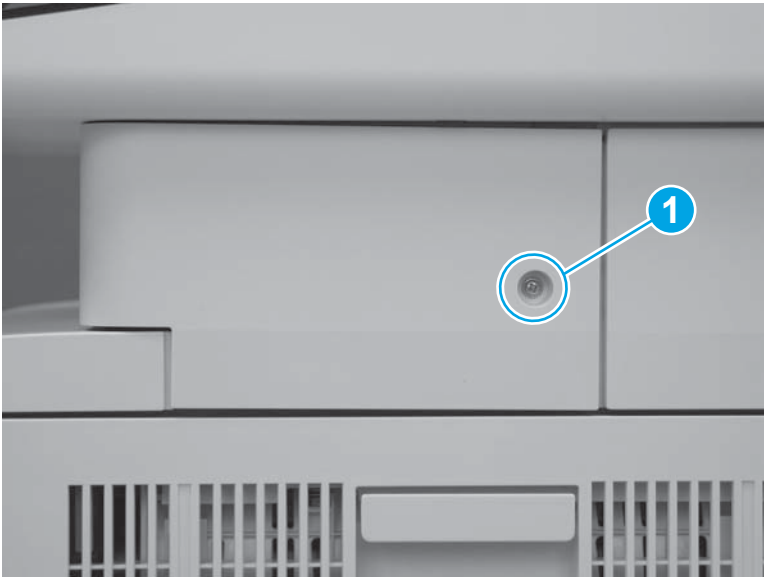

2. Release two tabs at the front edge of the cover (callout 1).

Figure 1-4884 Release two tabs



3. Rotate the front of the cover to the right to remove it.

Figure 1-4885 Rotate the cover



Step 10: Remove the stapler cover assembly (M577c/f/z)

 **NOTE:** This step is for the M577c/f/z models. For the M577dn model, skip this step and go to [Step 11: Remove the document feeder \(M577\) on page 2709.](#)

1. Remove one screw (callout 1).

 **Reinstallation tip:** This is a self-tapping screw for plastic. When reinstalling, rotate the screw counterclockwise to align it with the existing thread pattern, and then carefully turn it clockwise to tighten. Do not overtighten. This will prevent stripping the threads inside the screw hole.

Figure 1-4886 Remove one screw



2. Release two tabs at the front edge of the cover (callout 1).

Figure 1-4887 Release two tabs

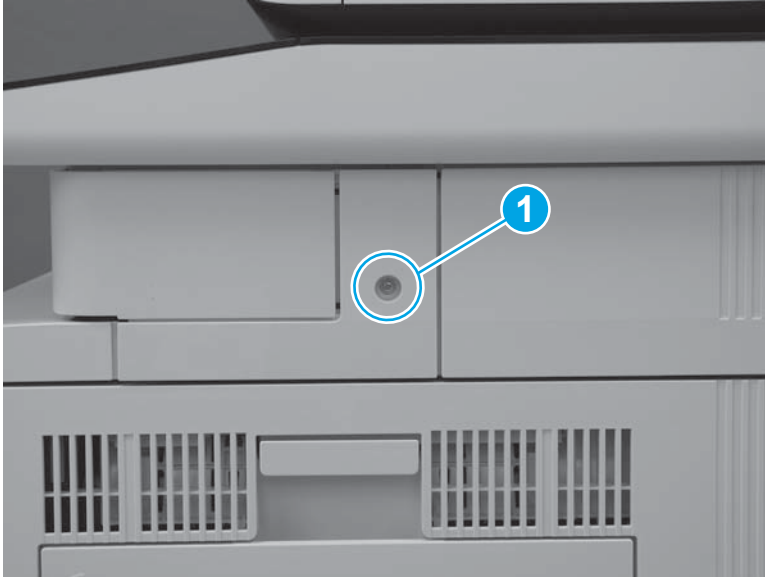

3. Release the back edge of the cover.

Figure 1-4888 Release the back edge of the cover



4. Rotate the cover away from the printer to remove it.

Figure 1-4889 Remove the cover



Step 11: Remove the document feeder (M577)

1. Remove one screw (callout 1).

 **Reinstallation tip:** This is a self-tapping screw for plastic. When reinstalling, rotate the screw counterclockwise to align it with the existing thread pattern, and then carefully turn it clockwise to tighten. Do not overtighten. This will prevent stripping the threads inside the screw hole.

Figure 1-4890 Remove one screw



2. Rotate the cover away from the printer to remove it.

Figure 1-4891 Remove the cover

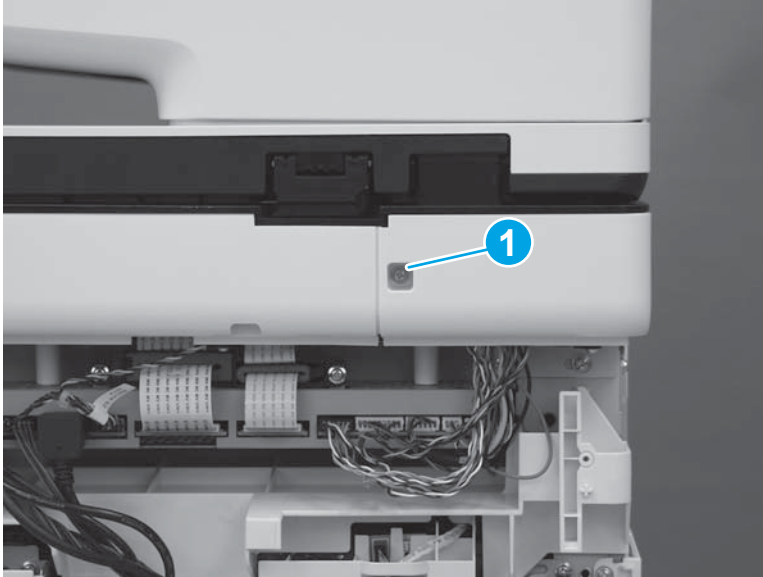
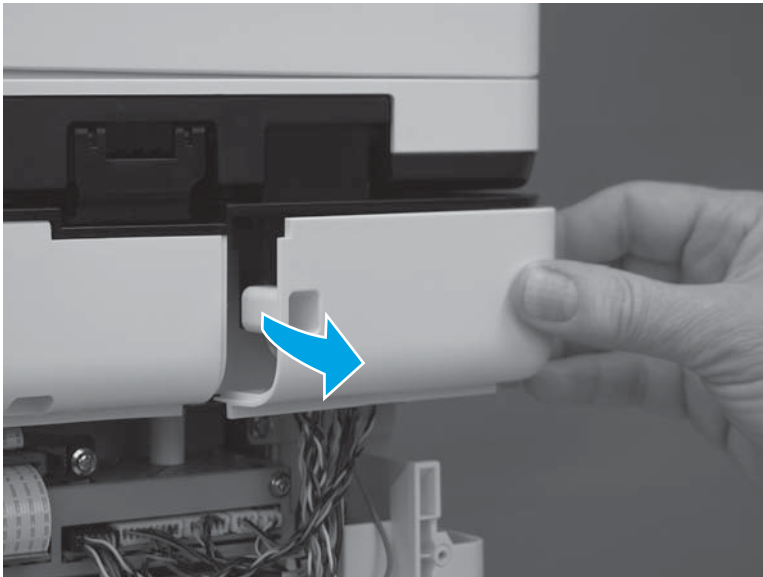

3. Disconnect one flat cable (callout 1), remove one ground screw (callout 2) to release the grounding cable, and then disconnect all of the connectors (callout 3) on the scanner control board.

 **Reinstallation tip:** There are eight wire-harness connectors, two flat cables, and one high-definition multimedia interface (HDMI) cable connector.

Figure 1-4892 Disconnect the flat cable, ground cable, and connectors



4. Disconnect three connectors (callout 1) from the formatter, and then release three black cables through the opening (callout 2) in the formatter case.

Figure 1-4893 Disconnect three connectors

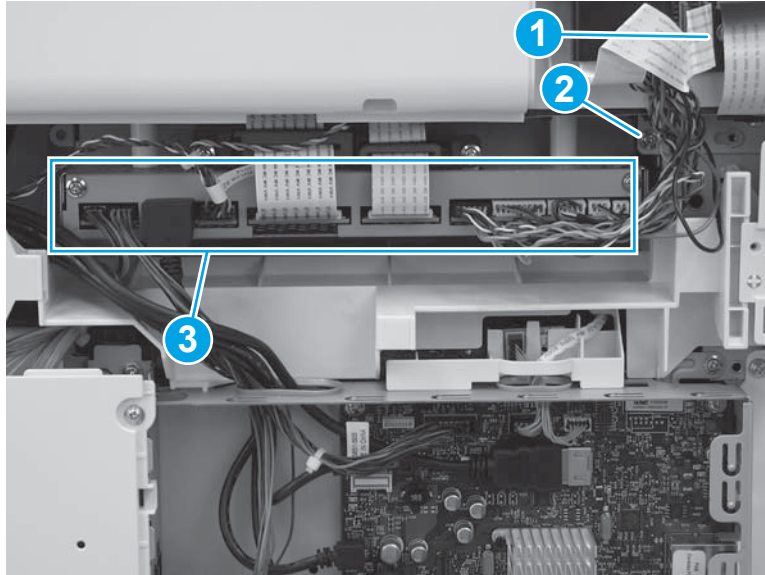
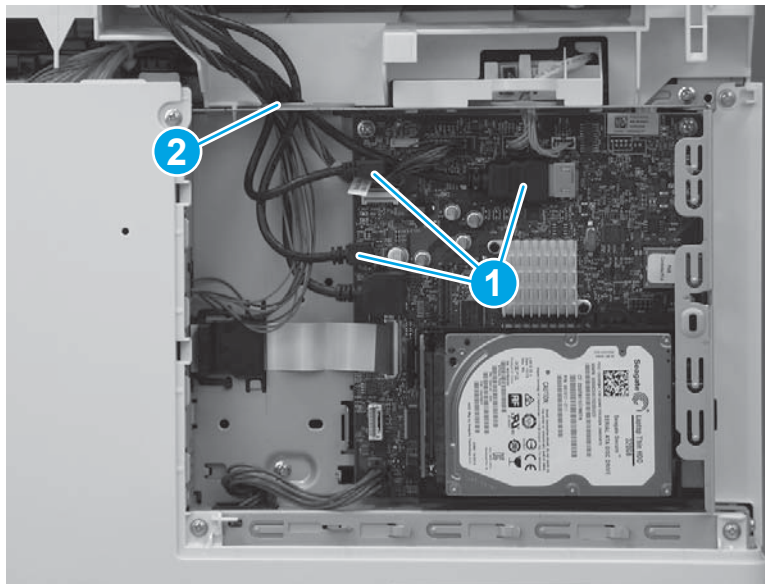

5. Open the document feeder.

Figure 1-4894 Open the document feeder



6. Tilt the document feeder back until it stops (callout 1), and then lift it off of the scanner until it stops (callout 2).

Figure 1-4895 Raise the document feeder



7. Support the document feeder, and then use a small flat-blade screwdriver to release two tabs on the document feeder hinges.

Figure 1-4896 Release two tabs



8. Lift the document feeder up to remove it.

 **NOTE:** While removing the document feeder, carefully pass the wire harnesses and the flat cable through the opening in the scanner.

Figure 1-4897 Remove the document feeder



Step 12: Remove the scanner control board (SCB) (M577)

1. Remove two screws (callout 1).

Figure 1-4898 Remove two screws

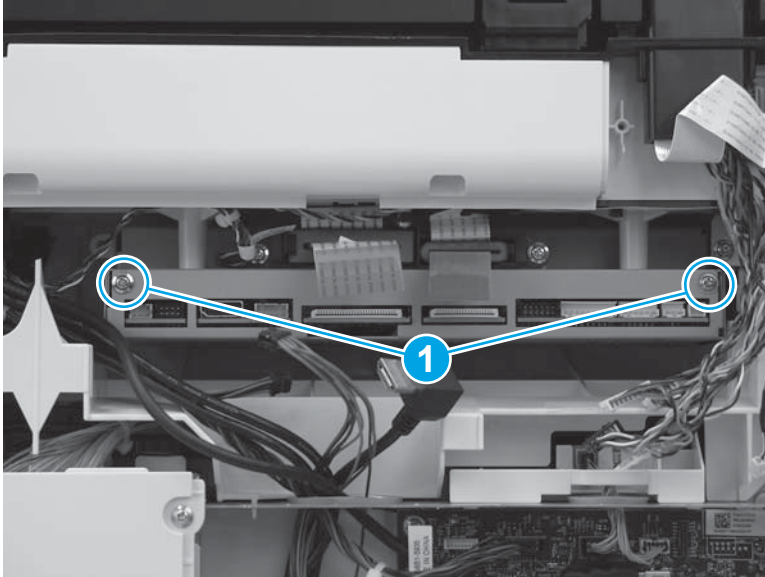

2. Remove the cables (callout 1) from the guide (callout 2) , and then lower the SCB (callout 3) .

Figure 1-4899 Slide the SCB out

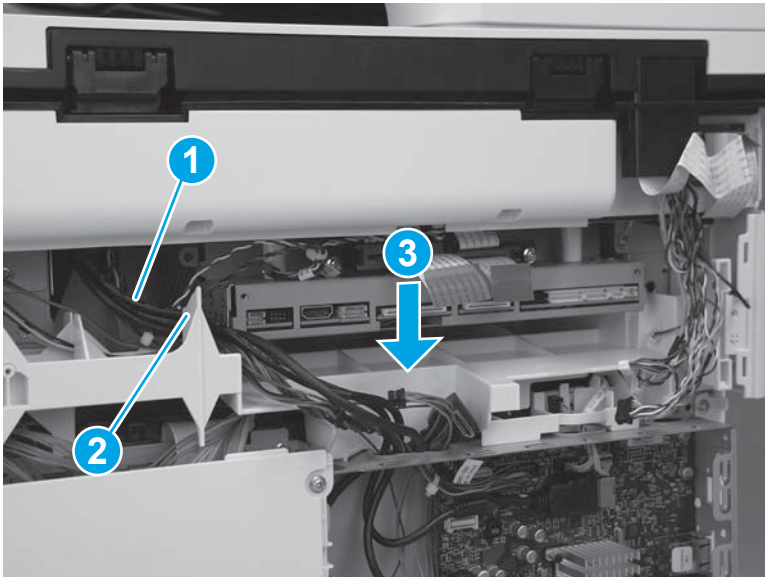

3. Rotate the SCB up and out of the printer. Make sure that the heat sink (callout 1) on the SCB does not get caught on the edge of the sheet metal (callout 2).

Figure 1-4900 Remove the SCB

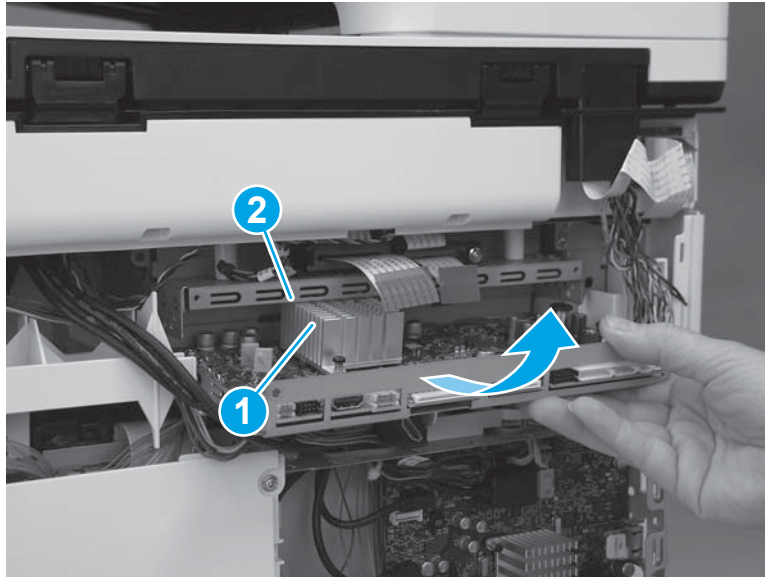

Step 13: Remove the image scanner assembly (M577)

1. Disconnect four connectors (callout 1) on the formatter, and then pass the wire harnesses and cables through the top opening in the formatter case (callout 2).

Figure 1-4901 Disconnect cables and connectors

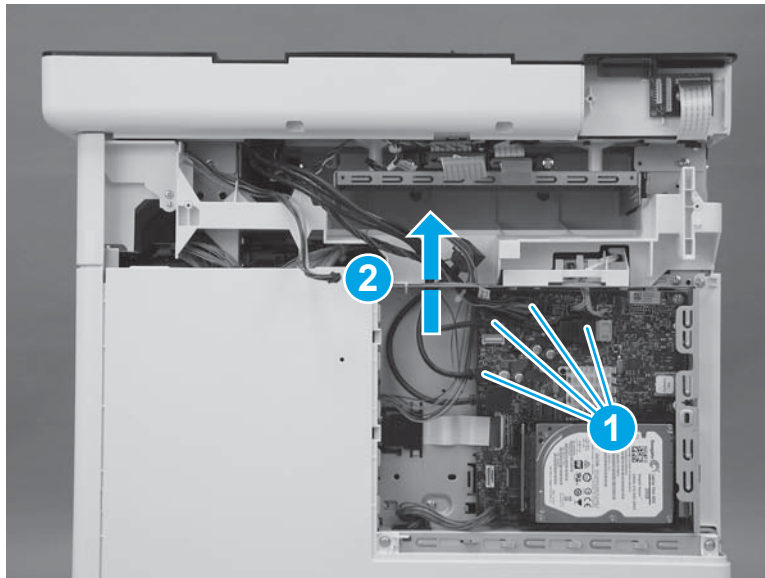

2. At the right side of the printer, remove one screw (callout 1).

 **NOTE:** The M577z is shown in the figure below. The procedure is correct for all M577 models.

Figure 1-4902 Remove one screw

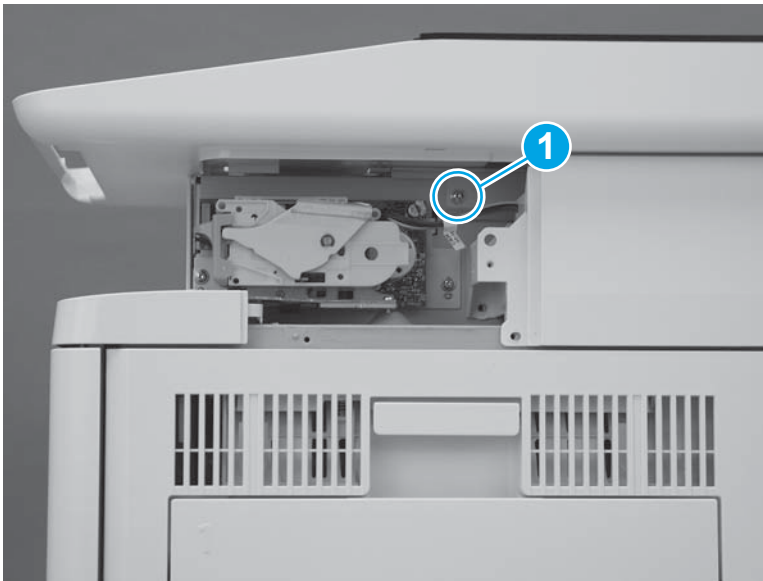

3. At the back of the printer, remove two screws (callout 1).

Figure 1-4903 Remove two screws

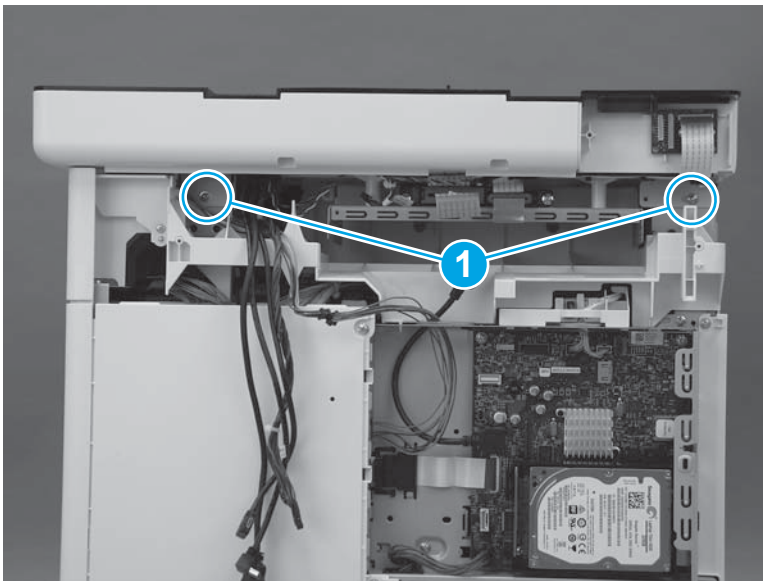

4. At the left side of the printer, remove one screw (callout 1).

Figure 1-4904 Remove one screw

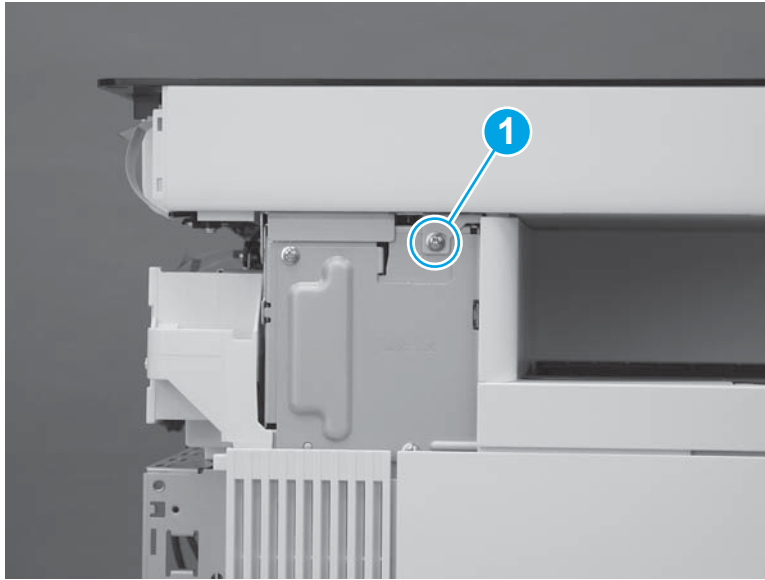

5. Slide the image scanner toward the back of the printer to release it.

Figure 1-4905 Release the image scanner

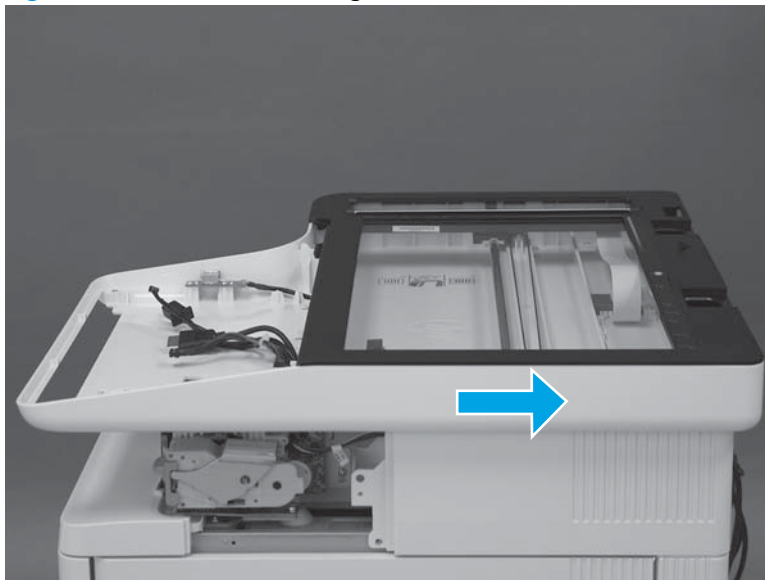

6. Lift the image scanner straight up to remove it.

Figure 1-4906 Remove the image scanner

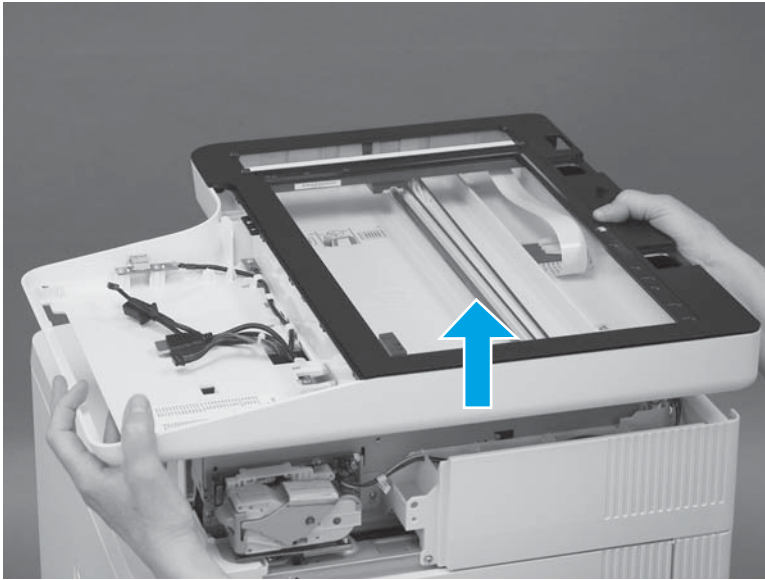

Step 14: Unpack the replacement assembly

Unpack the replacement assembly from the packaging.

For complete information on HP's recycling programs, go to [Product return and recycling](#).

 **NOTE:** HP recommends responsible disposal of the defective part.

Figure 1-4907 Recycle and unpack

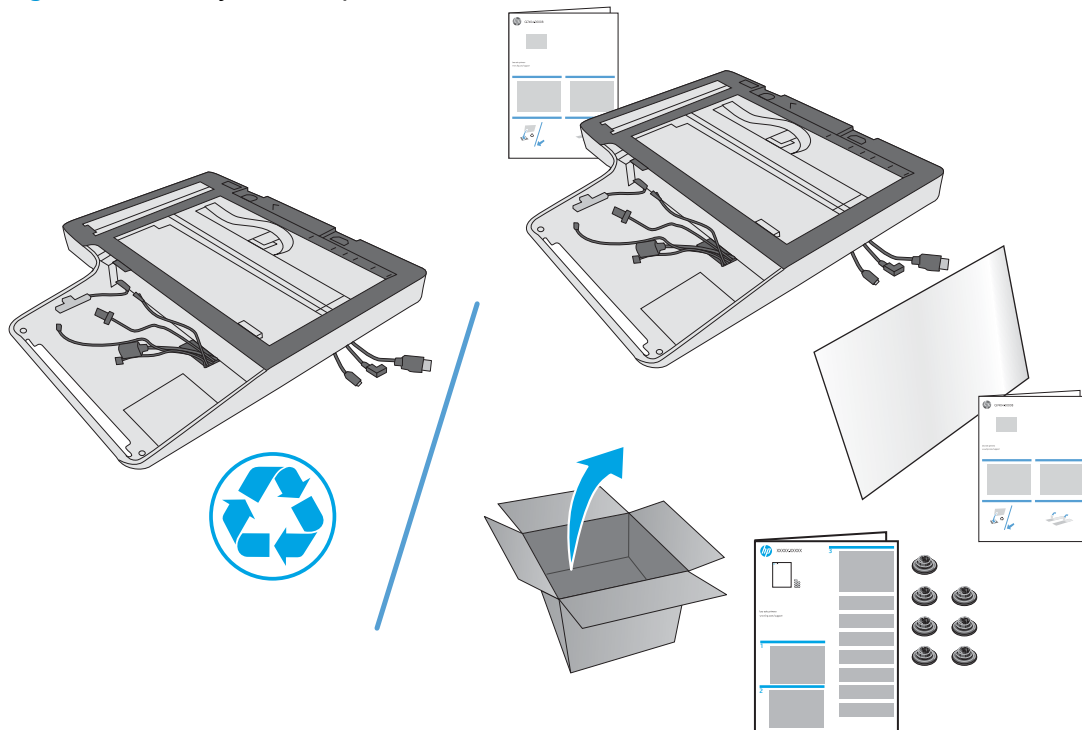

Step 15: Install the image scanner assembly (M577)

1. Before proceeding, locate the mounting pins (callout 1) on the bottom of the image scanner and the slots (callout 2) on the printer base.

Figure 1-4908 Locate the image scanner mounting pins and slots

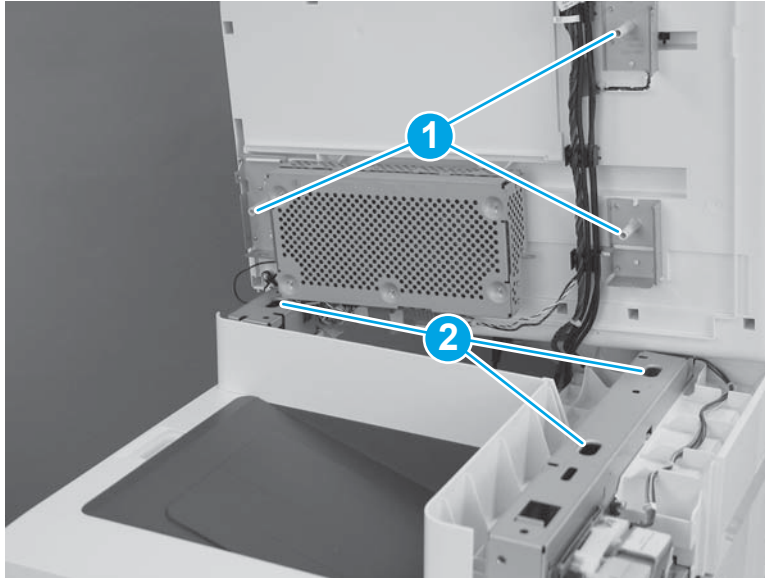

2. Position the image scanner on the printer base with the pins in the slots.



NOTE: To locate the pins and slots, see [Figure 1-4908 Locate the image scanner mounting pins and slots on page 2719](#).

Figure 1-4909 Install the image scanner

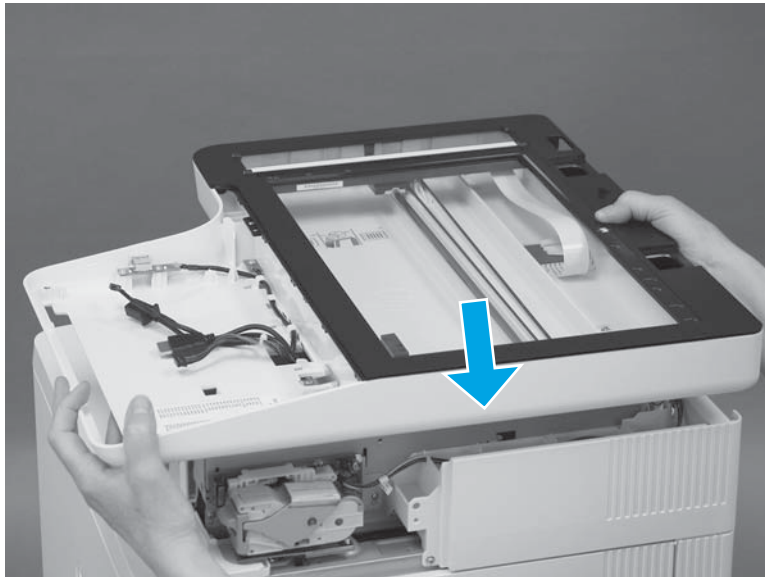

3. Slide the image scanner toward the front of the printer to engage it with the printer base.

Figure 1-4910 Engage the image scanner

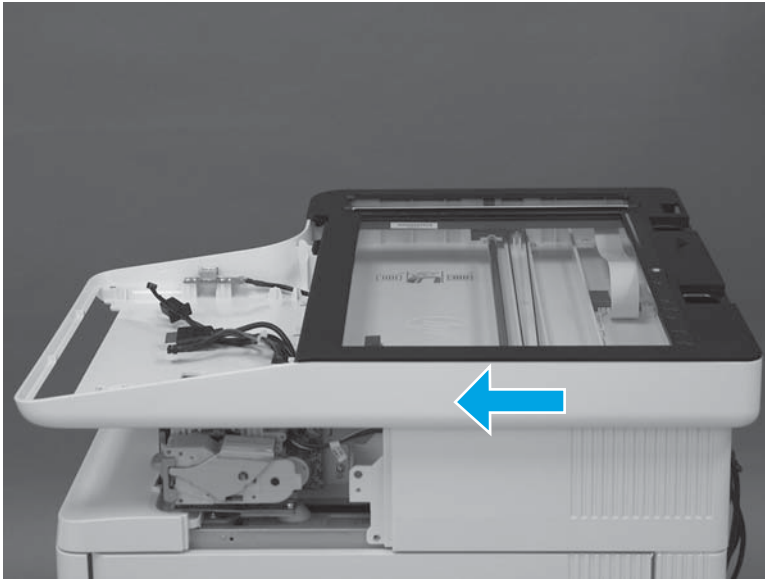

4. At the left side of the printer, install 1 screw (callout 1).

Figure 1-4911 Install one screw

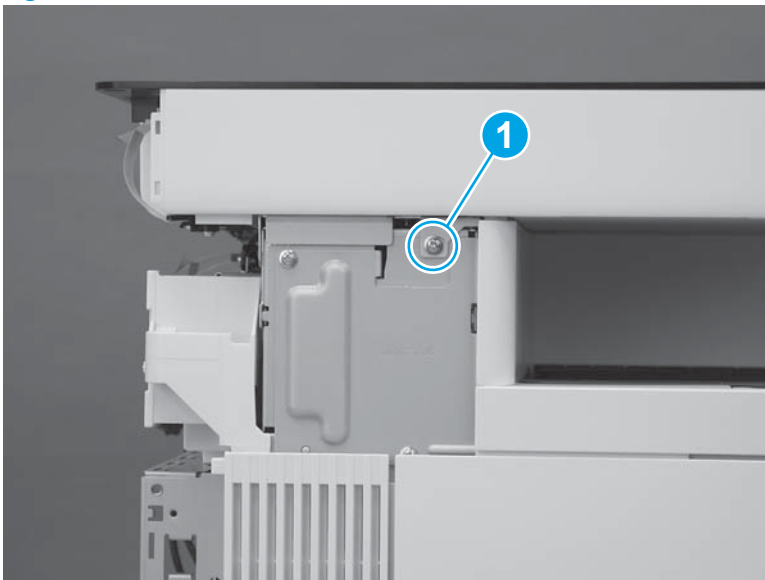

5. At the back of the printer, install two screws (callout 1).

Figure 1-4912 Install two screws

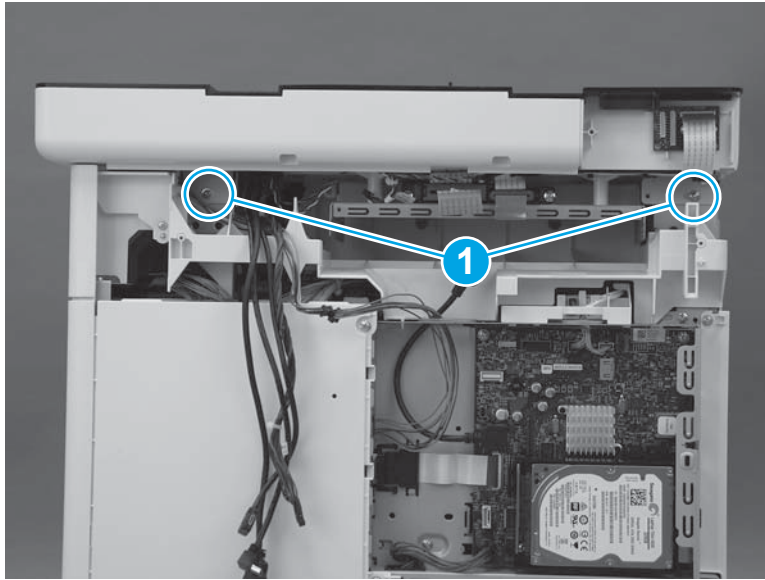

6. At the right side of the printer, install one screw (callout 1).

Figure 1-4913 Install one screw

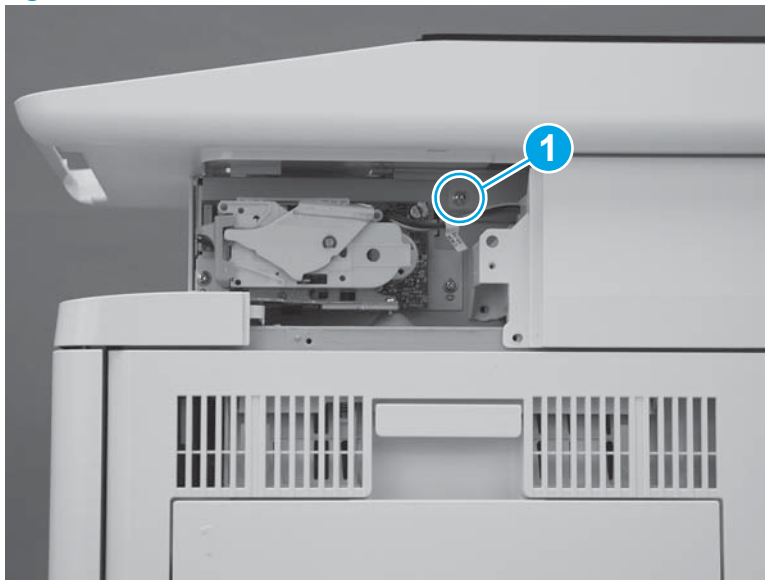

7. Install the wire harnesses and cables through the opening in the top of the formatter cover (callout 1), and then connect four connectors (callout 2).

Figure 1-4914 Connect connectors

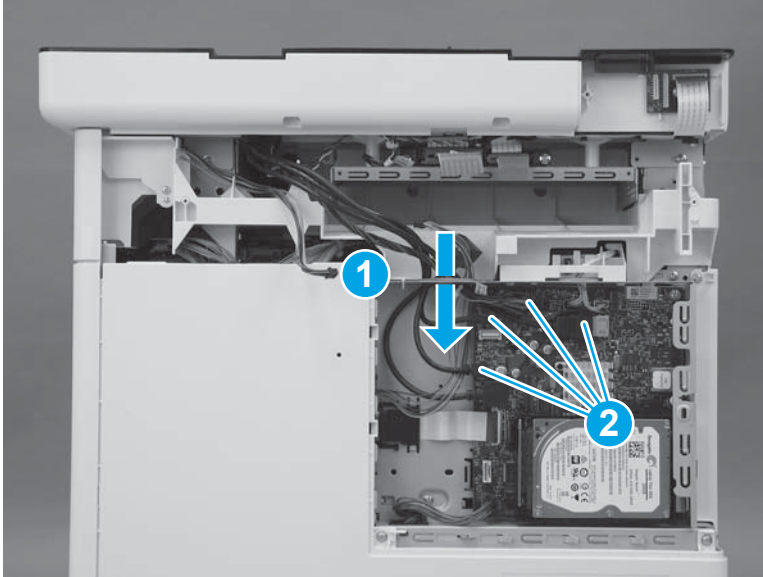

8. **M577dn and M577f only:** Do the following:
 - a. Before proceeding, take note of mounting slots and tabs on the keyboard cover (supplied in the kit).

Figure 1-4915 Keyboard cover mounting slots and tabs (M577dn and M577f)

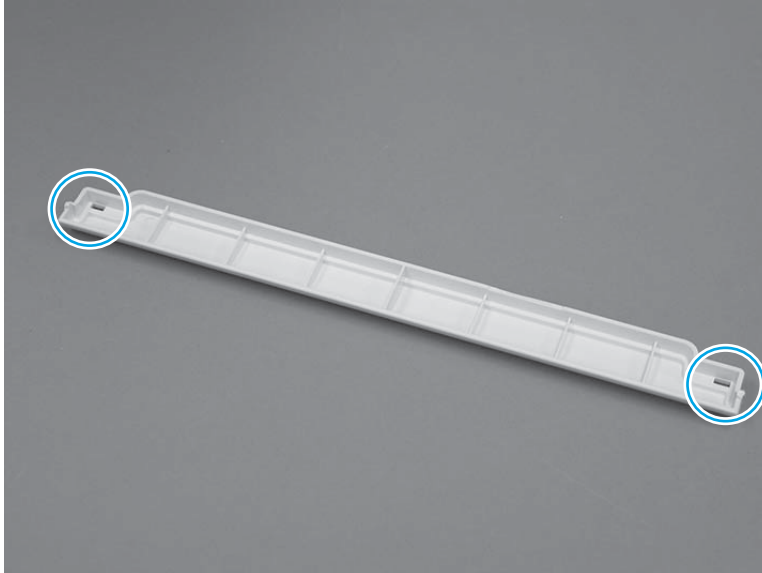

- b. Position the keyboard cover in the opening on the replacement image scanner, and then rotate it until it snaps into place.

Figure 1-4916 Install the keyboard cover (M577dn and M577f)

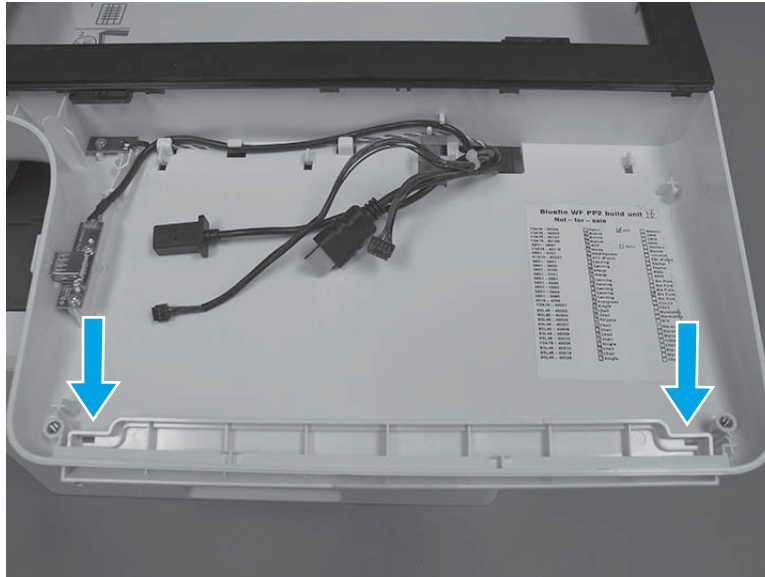

- c. Make sure that the cover is properly installed—the tabs snap into place and the slots snap over the bosses.

Figure 1-4917 Check the keyboard cover (M577dn and M577f)

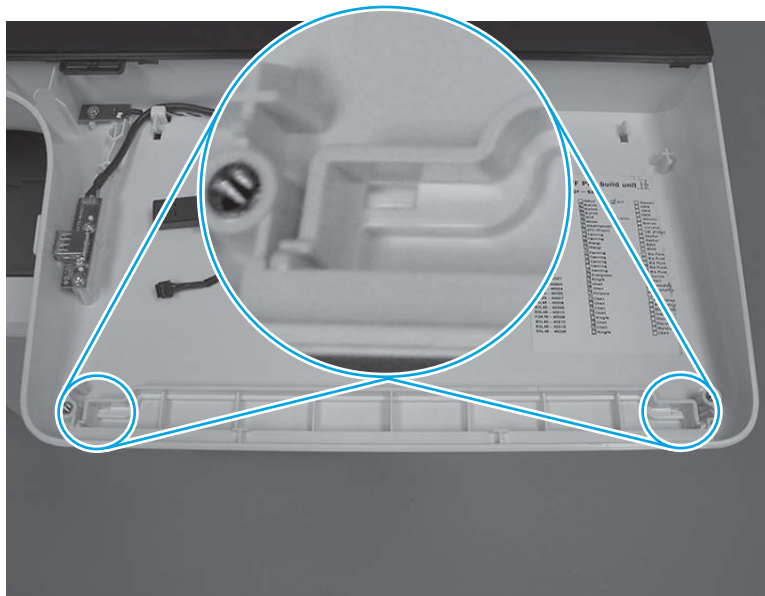

Step 16: Install the scanner control board (M577)

1. Align the slots on the SCB (callout 1) with the tabs (callout 2) inside the printer.

Figure 1-4918 Install the SCB

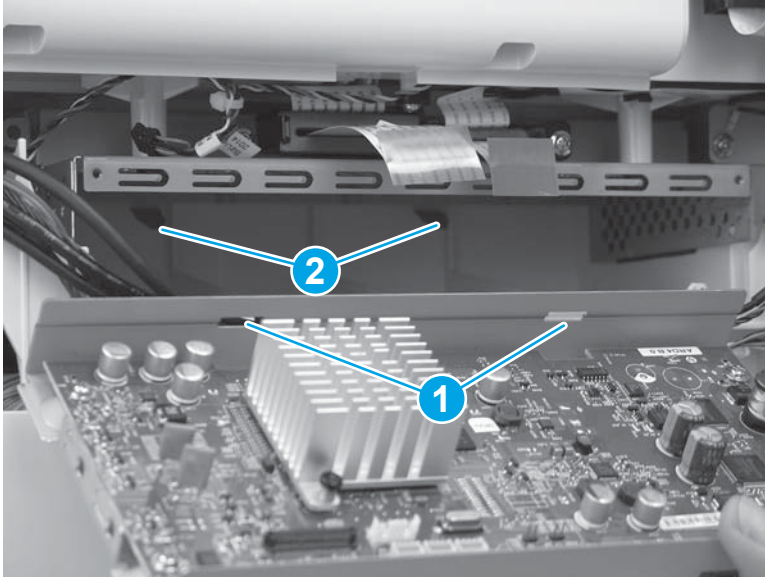

2. Slide the SCB into the printer until it stops. Make sure that the heat sink (callout 1) on the SCB does not get caught on the edge of the sheet metal (callout 2).

Figure 1-4919 Slide the SCB in

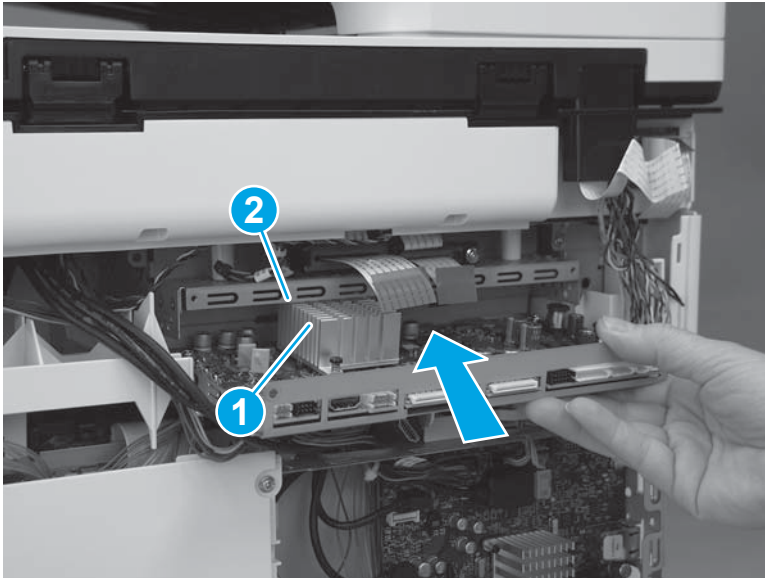

3. Raise the SCB up (callout 1), and then install the cables (callout 2) in the guide (callout 3).

Figure 1-4920 Raise the SCB and install cables

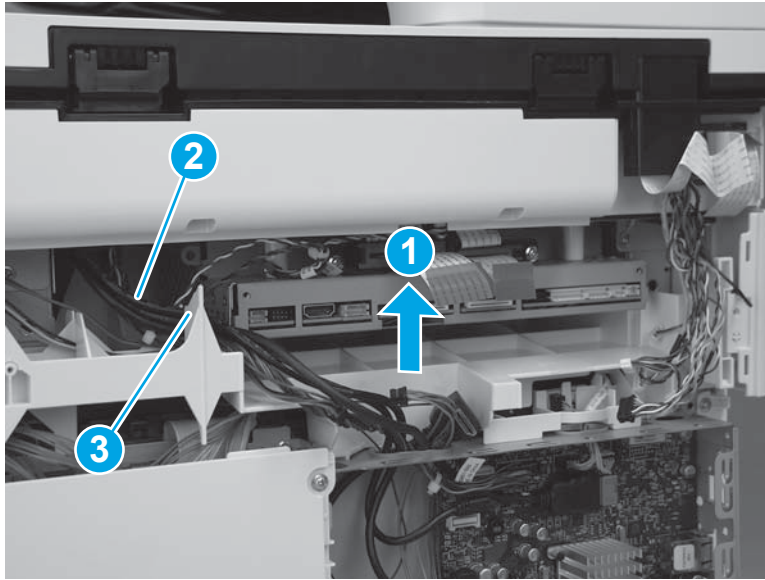

4. Install two screws (callout 1).

Figure 1-4921 Install two screws

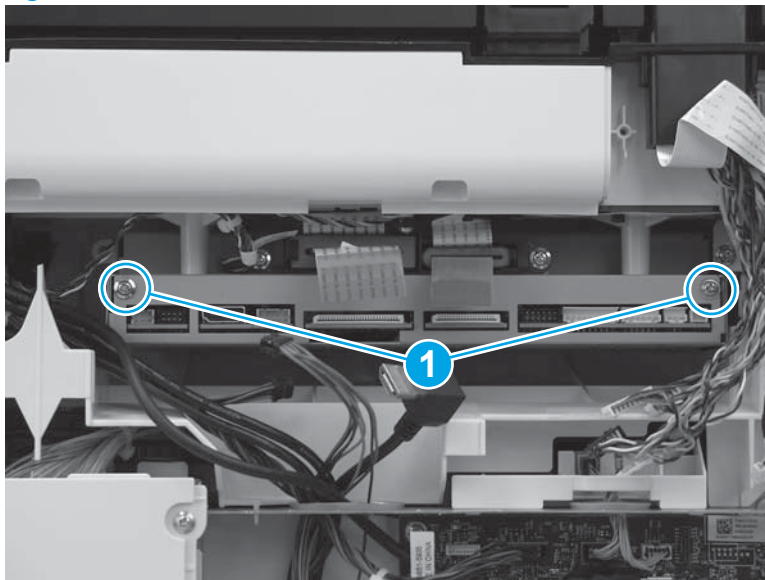

Step 17: Install the document feeder (M577)

1. Pass the flat cable and wire harness on the replacement document feeder through the hole in the scanner chassis (callout 1), and then align the hinges (callout 2) with the slots (callout 3) in the chassis.

Figure 1-4922 Install the document feeder

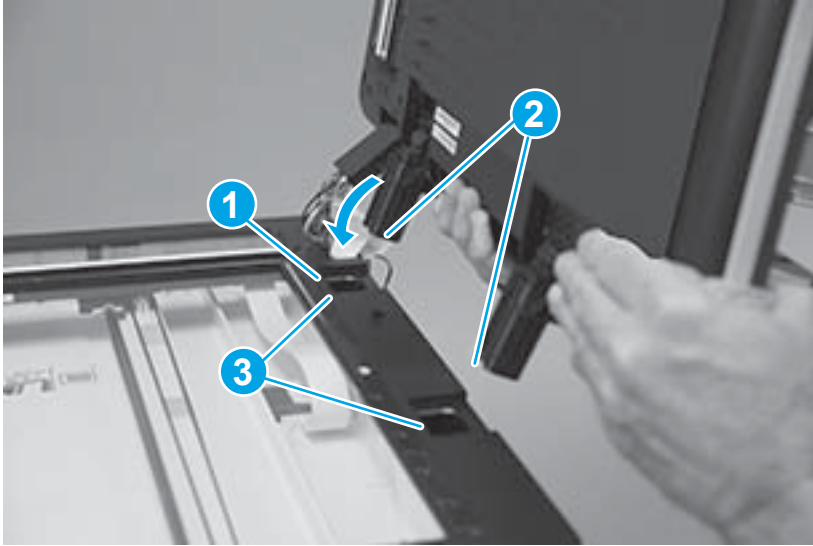

2. Continue to pass the flat cable and wire through the opening in the chassis (callout 1), and then insert the hinges (callout 2) into the slots.

CAUTION: Do not damage the flat cable or wire harnesses when the cable guide (callout 1) is installed in its slot.

Figure 1-4923 Lower the document feeder



3. Close the document feeder.

Figure 1-4924 Close the document feeder



4. Install three black cables through the opening in the formatter case (callout 1), and then connect three connectors on the formatter (callout 2).

Figure 1-4925 Connect three connectors

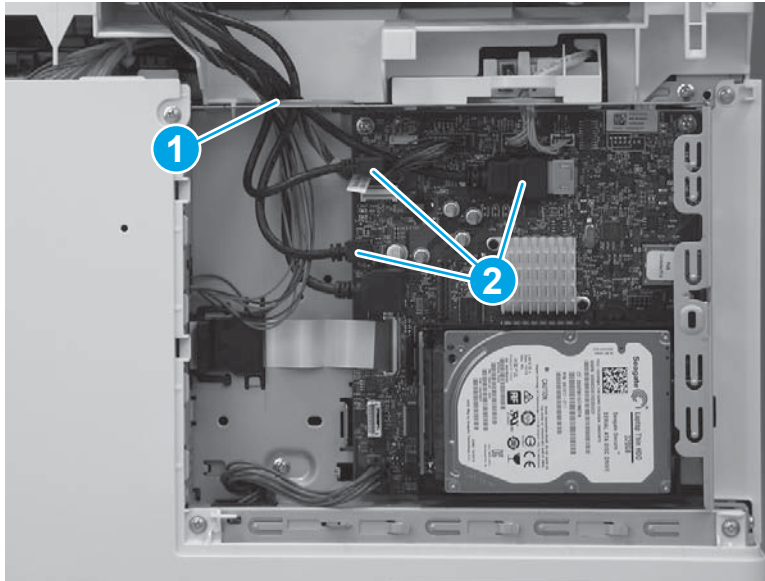

5. Connect one flat cable (callout 1), install the grounding cable behind one ground screw (callout 2), and then connect all of the connectors (callout 3) on the scanner control board.

 **Reinstallation tip:** There are eight wire-harness connectors, two flat cables, and one high-definition multimedia interface (HDMI) cable connector.

Figure 1-4926 Connect the flat cable, ground cable, and connectors



6. Position the tabs (callout 1) on the cover in the slots (callout 2) in the printer.

Figure 1-4927 Position the tabs

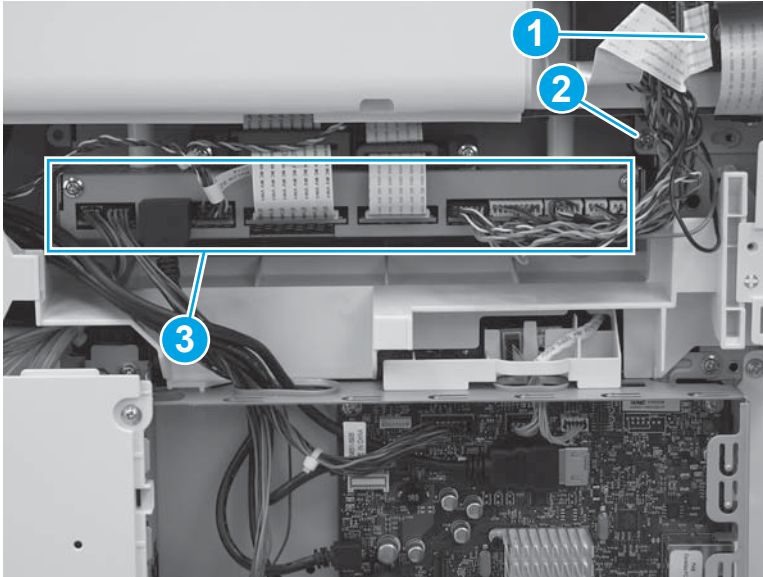
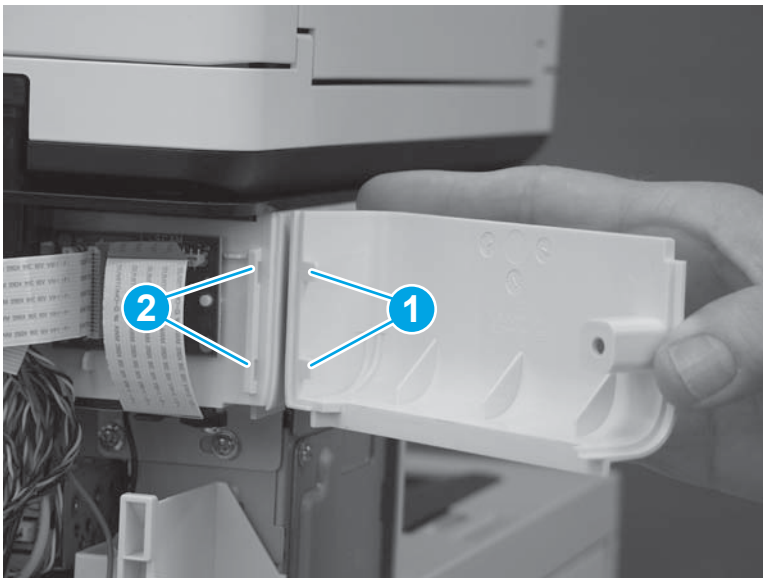

7. Rotate the cover toward the printer to install it.

Figure 1-4928 Install the cover

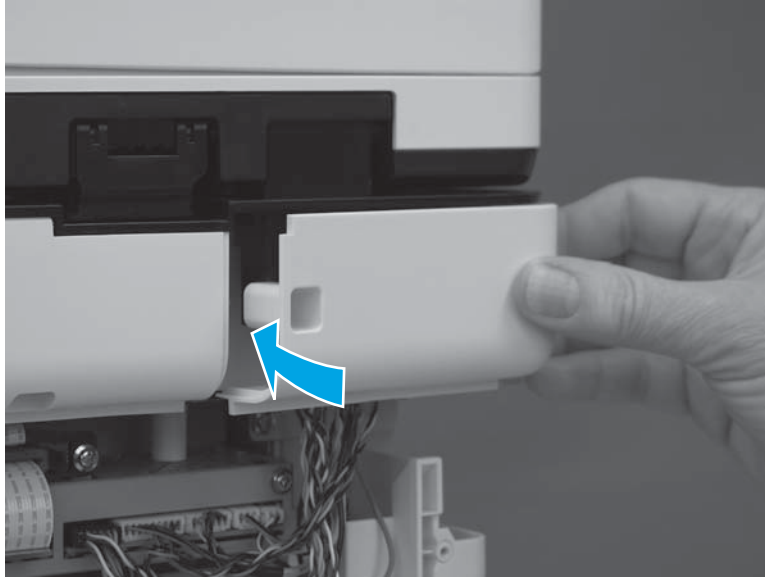

8. Install one screw (callout 1).



 **IMPORTANT:** This is a self-tapping screw for plastic. Rotate it counterclockwise to align it with the existing thread pattern, and then carefully turn it clockwise to tighten. Do not overtighten. This will prevent stripping the threads inside the screw hole.

Figure 1-4929 Install one screw

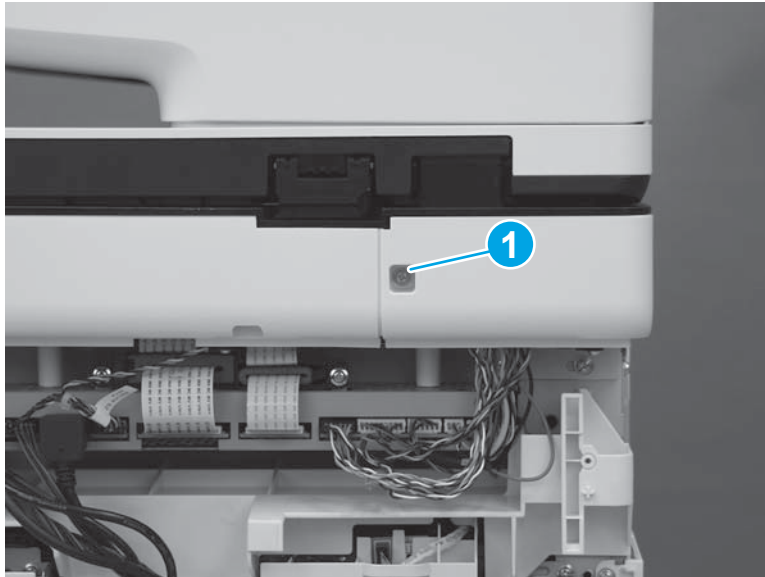

Step 18: Install the stapler cover assembly (M577c/f/z)

 **NOTE:** This step is for the M577c/f/z models. For the M577dn model, skip this step and go to [Step 19: Install the right front upper cover \(M577dn\) on page 2731](#).

1. Install the tabs (callout 1) on the cover in the slots (callout 2) in the printer.

Figure 1-4930 Install two tabs



2. Press the cover toward the left side of the printer until it snaps into place.

Figure 1-4931 Install the cover assembly



3. Install one screw (callout 1).



 **IMPORTANT:** This is a self-tapping screw for plastic. Rotate it counterclockwise to align it with the existing thread pattern, and then carefully turn it clockwise to tighten. Do not overtighten. This will prevent stripping the threads inside the screw hole.

Figure 1-4932 Install one screw

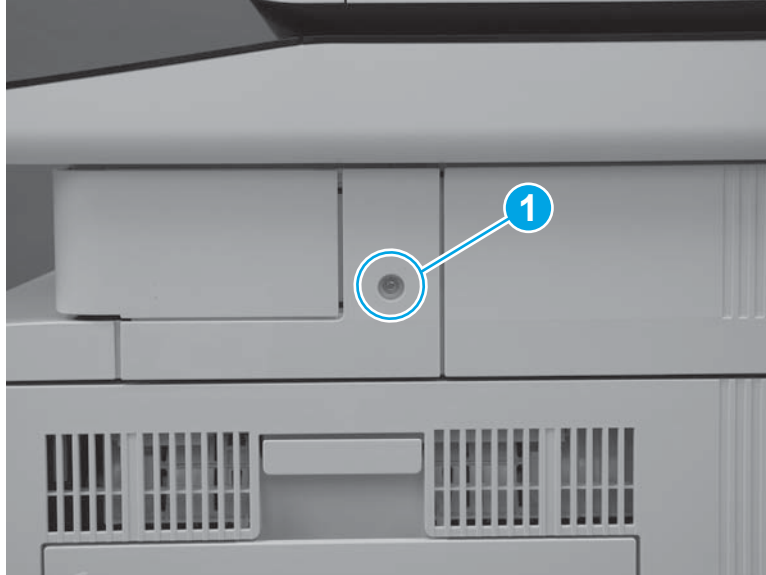

Step 19: Install the right front upper cover (M577dn)

 **NOTE:** This step is for the M577dn model. For the M577c/f/z models, skip this step and go to [Step 20: Install the left upper cover \(M577\) on page 2732](#).

1. Slide the cover toward the left side of the printer to install it. Make sure that the slots (callout 1) in the cover fit over the tabs (callout 2) on the inside of the paper feeder cover.

Figure 1-4933 Install the cover

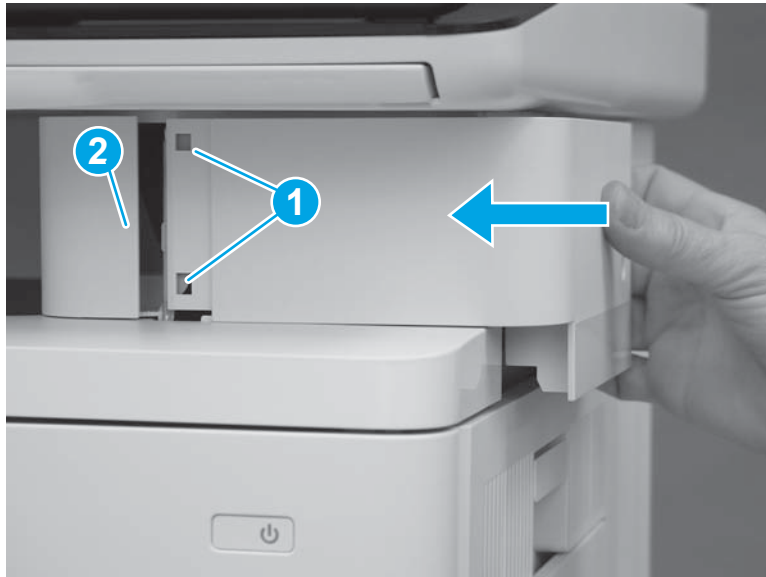

2. Press the right front upper cover (callout 1) and the paper feeder cover (callout 2) together until the tabs on the inside of the covers snap into place.

Figure 1-4934 Press the cover



3. Install one screw (callout 1).

Figure 1-4935 Install one screw

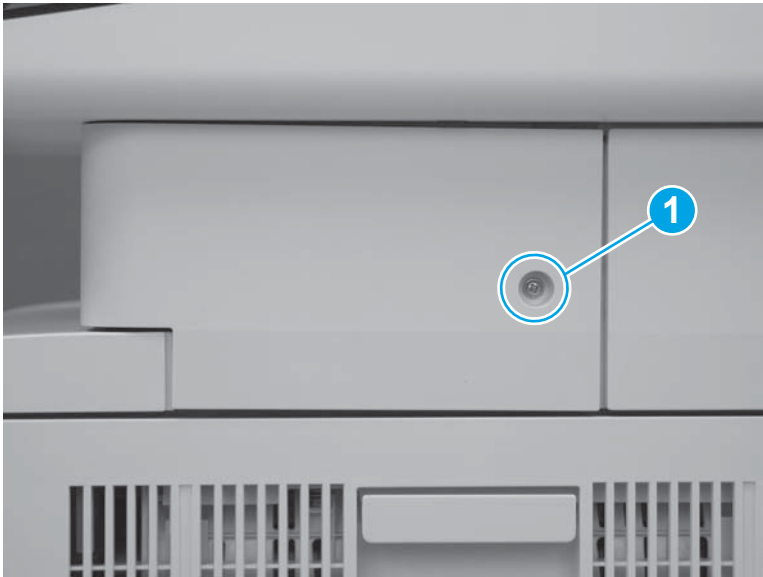

Step 20: Install the left upper cover (M577)

1. Position the tab (callout 1) on the lower edge of the cover behind the left cover (callout 2).

Figure 1-4936 Position the tab

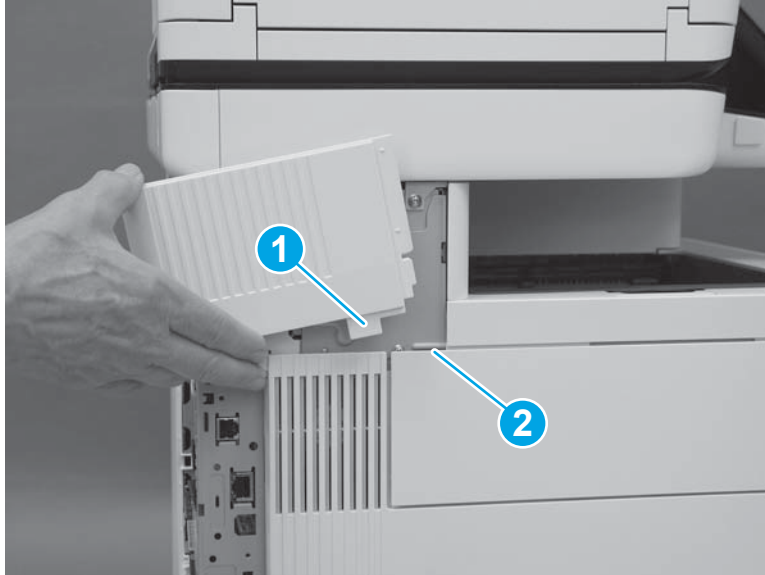

2. Slide the cover toward the front of the printer to install it. Make sure that the edge (callout 1) of the cover fits behind the edge (callout 2) of the top rear cover.

Figure 1-4937 Slide the cover

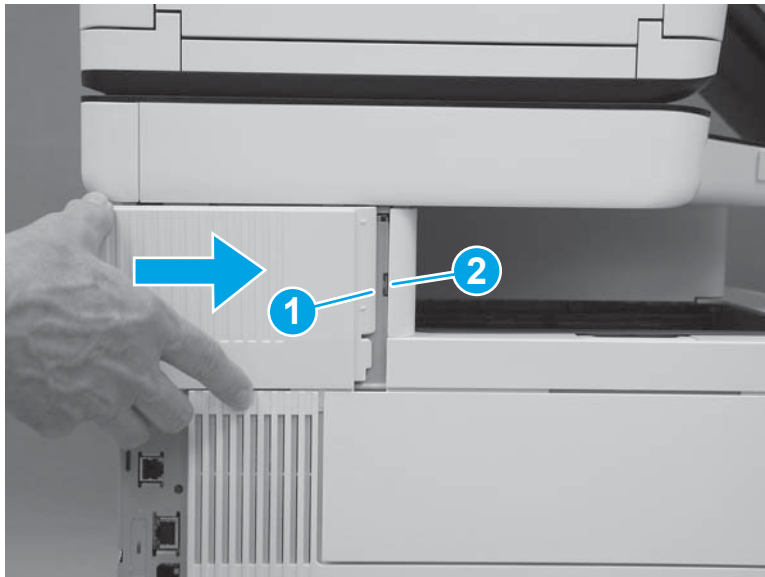

3. Make sure that the tab (callout 1) is fully installed.

Figure 1-4938 Check the tab

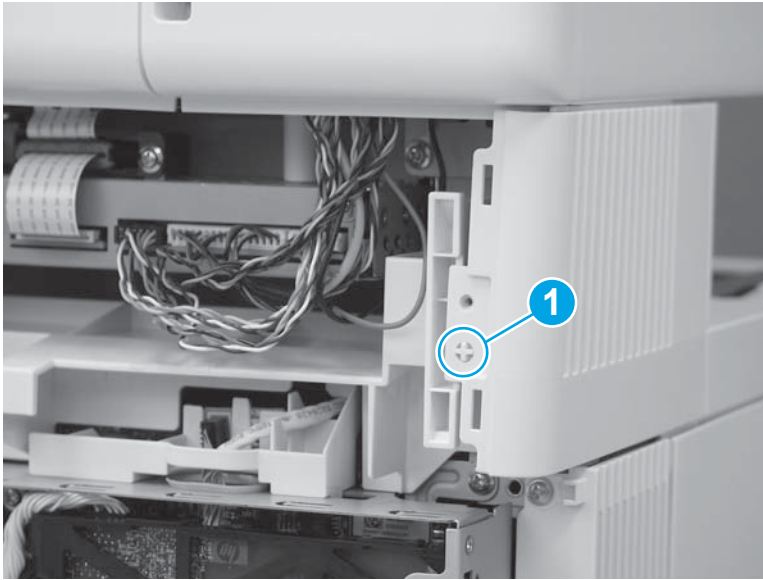

Step 21: Install the rear upper cover (M577)

1. Align the ridge (callout 1) on the lower edge of the rear upper cover in front of the tabs (callout 2) on the top edge of the rear cover.

Figure 1-4939 Align the cover

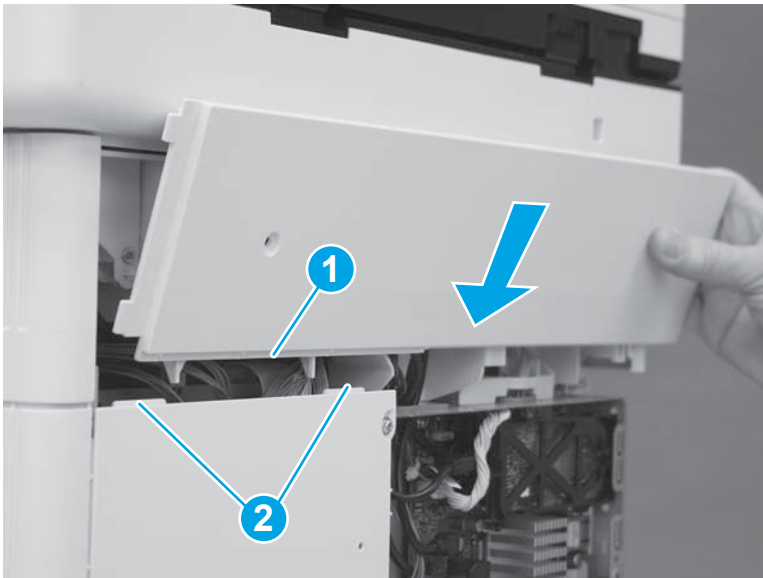

2. Rotate the top of the cover toward the printer.

Figure 1-4940 Rotate the top of the cover



3. Slide the cover to the left (callout 1). Make sure that the tabs (callout 2) on the upper rear cover slide behind the edge (callout 3) of the right upper cover. Make sure that the cover is fully seated.

Figure 1-4941 Slide the cover

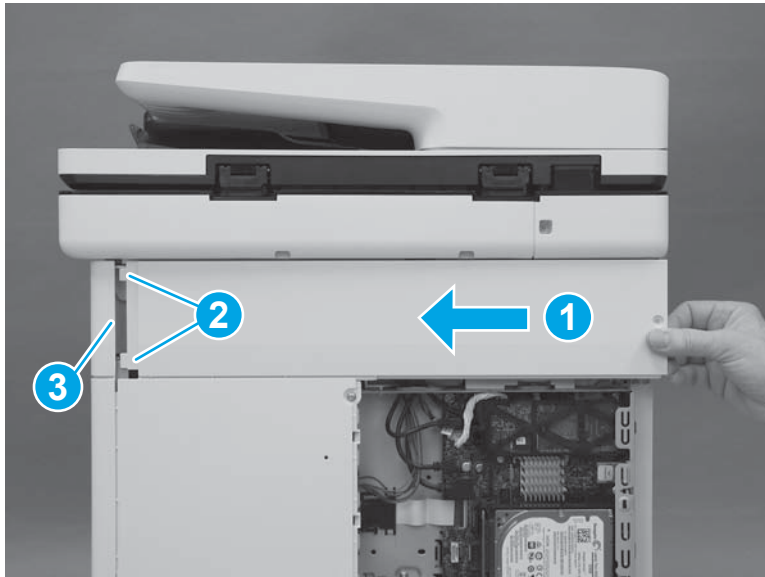

4. Install two screws (callout 1).



 **IMPORTANT:** These two screws are self-tapping screws for plastic. Rotate them counterclockwise to align them with the existing thread pattern, and then carefully turn them clockwise to tighten. Do not overtighten. This will prevent stripping the threads inside the screw holes.

Figure 1-4942 Install two screws

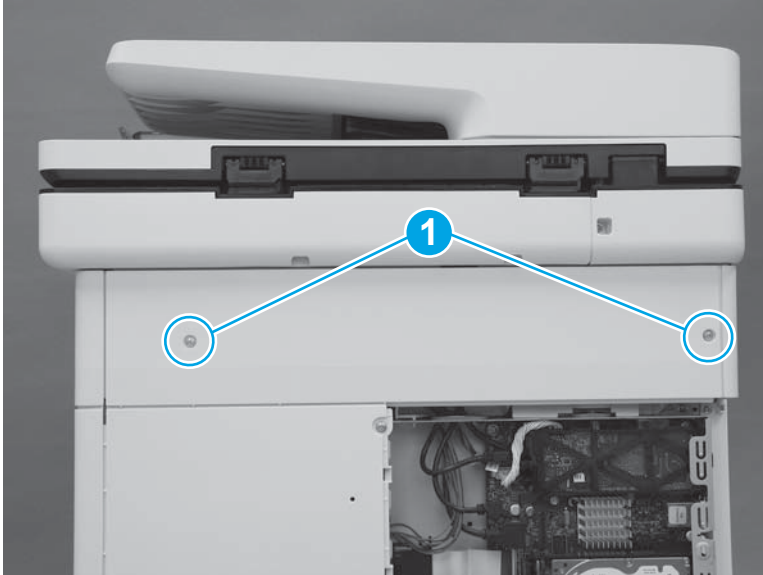

Step 22: Install the fax PCA (M577c/f/z)

 **NOTE:** This step is for the M577c/f/z models. For the M577dn model, skip this step and go to [Step 23: Install the formatter cover on page 2738](#).

 **CAUTION:**  ESD-sensitive part.

1. Position the tab and telephone port (callout 1) on the fax PCA in the slots (callout 2) in the formatter case.

Figure 1-4943 Position the fax PCA

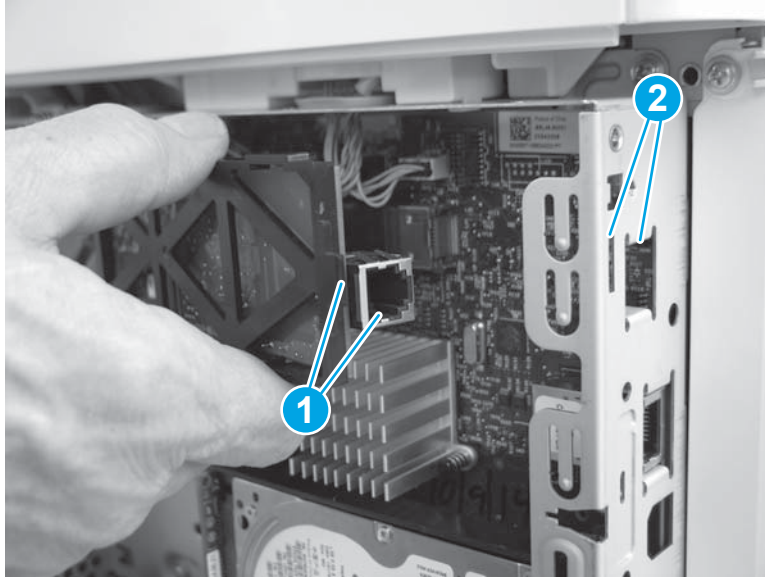

2. Slide the fax PCA to the right (callout 1) until the tab and telephone port described in the previous step and seated in the formatter case. Position the retainer (callout 2) in the slot (callout 3) in the formatter. Rotate the end of the fax PCA toward the formatter (callout 4) until the retainer snaps into place.

Figure 1-4944 Install the fax PCA

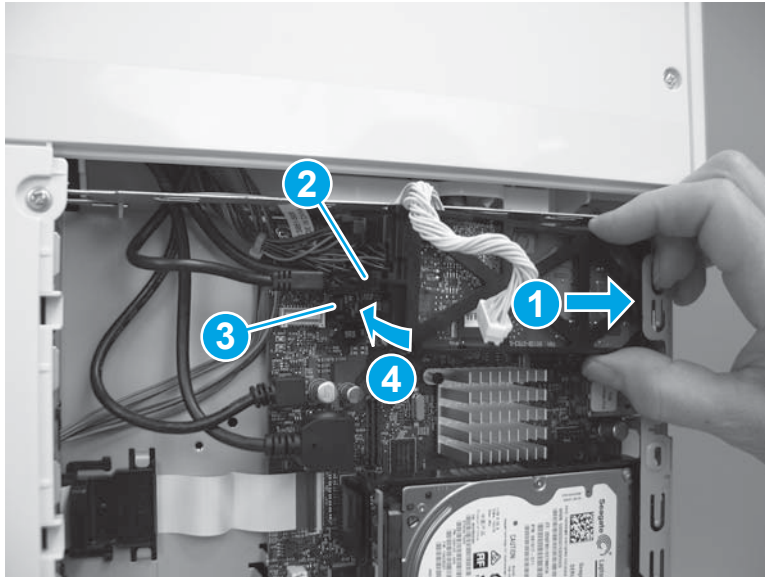

3. Position the cable (callout 1) in the guide (callout 2), and then connect one connector (callout 3).

Figure 1-4945 Connect the connector

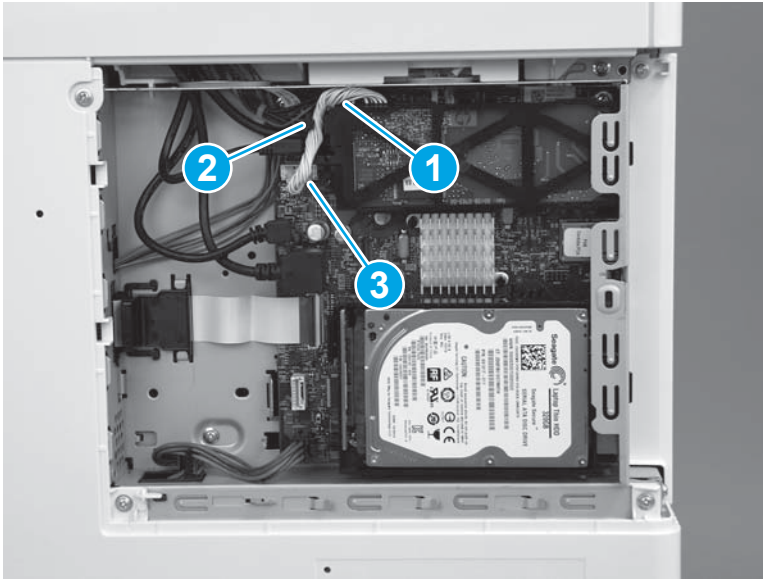

Step 23: Install the formatter cover

- ▲ Slide the cover onto the printer (callout 1) to install it.

 **NOTE:** Make sure that the tabs on the formatter cover align with the slots provided in the printer (callout 2). Tighten the two thumbscrews (callout 3).

 **TIP:** If needed, use the edge of a coin to turn the thumbscrews.

Figure 1-4946 Install the cover



Step 24: Install the control panel (M577)

1. Tilt the control panel away from the base plate.

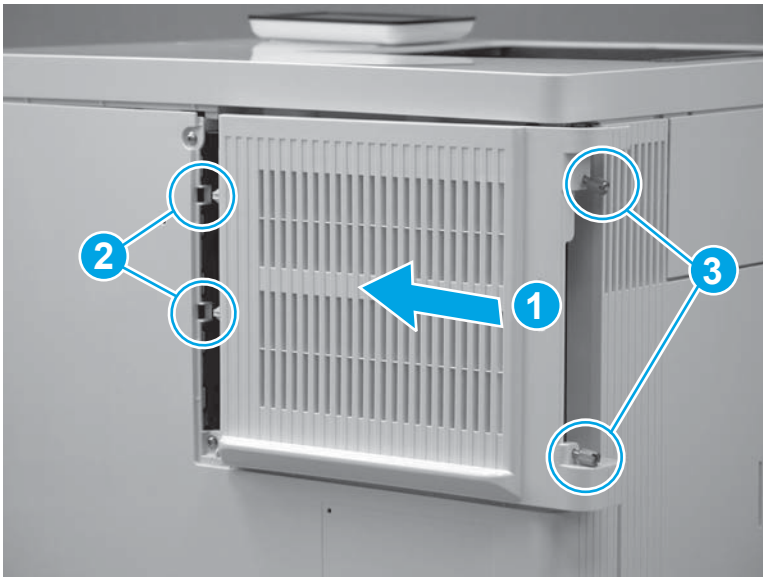
Figure 1-4947 Open the control panel



2. Locate the four hooks on the printer and matching slots in the control-panel base (callout 1). The hooks fit into the slots (callout 2) when the assembly is installed.

 **NOTE:** Make sure that the grounding clip (callout 3) is on top of the assembly base when it is installed.

Figure 1-4948 Locate hooks and grounding clip



3. Position the rear edge of the control panel in the printer (callout 1), and then lower the front edge down (callout 2) to install it.

 **NOTE:** If the control panel is difficult to install, make sure that the hooks, slots, and grounding clip are correctly engaged. See [Figure 1-138 Locate hooks and grounding clip on page 98](#).

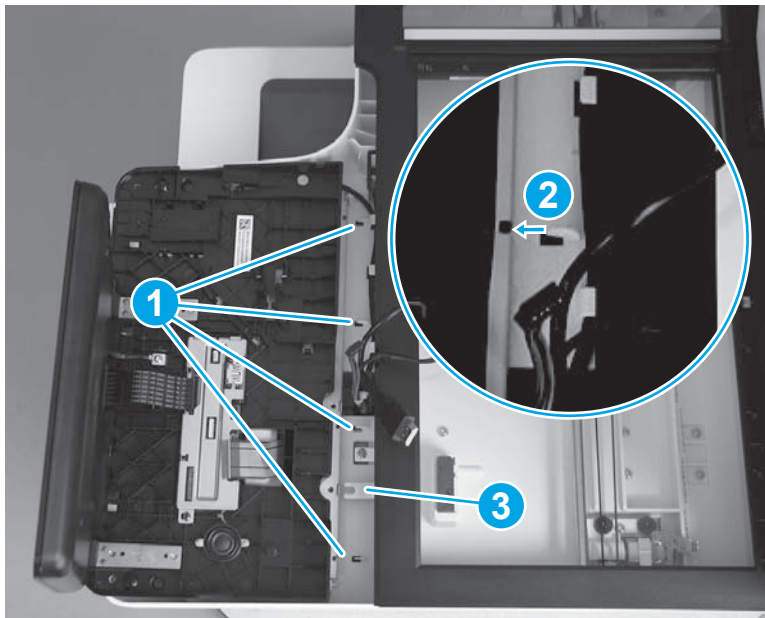
Figure 1-4949 Install the control-panel



4. Install three screws (callout 1), making sure that the grounding clip is correctly installed (callout 2).

Figure 1-4950 Install three screws

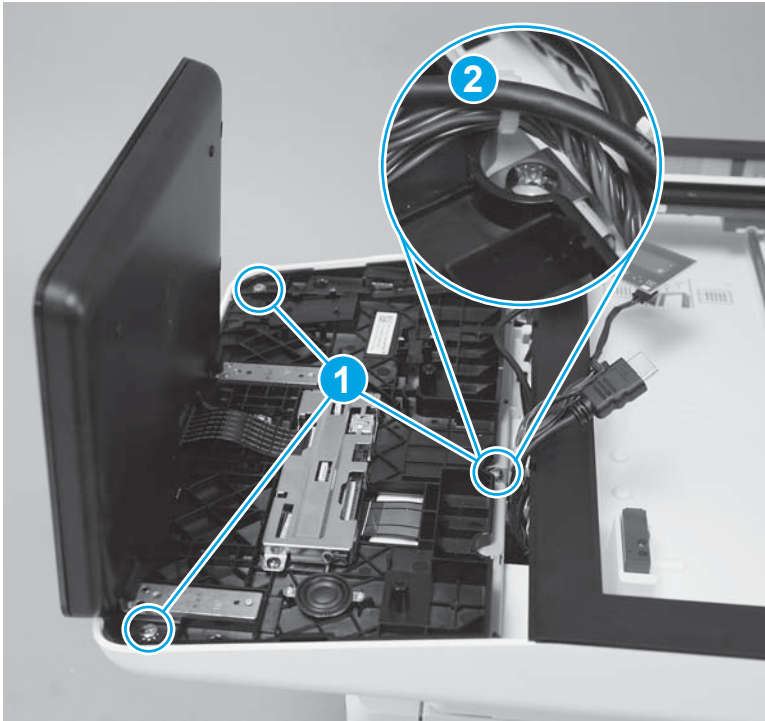

5. Connect one HDMI cable (callout 1), and one connector (callout 2).

Figure 1-4951 Connect connectors



6. Install the USB cable (callout 1) in the holder.
M577z only: Connect one connector (callout 2).

Figure 1-4952 Connect connectors

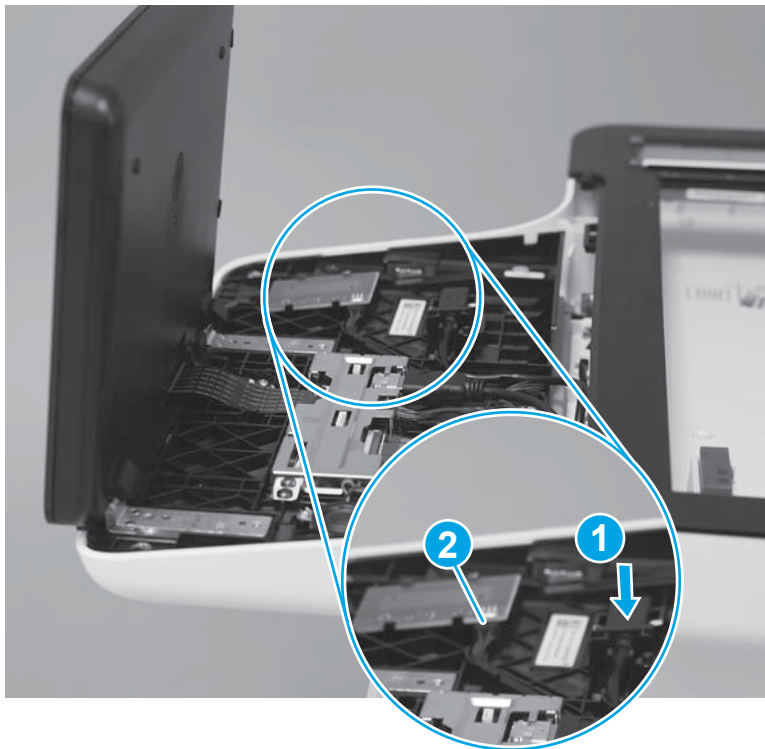

Step 25: Install the keyboard (M577c/z)

 **NOTE:** This step is for the M577c/z models. For the M577dn/f models, skip this step and go to [Step 26: Install the white backing \(M577\) on page 2744](#).

1. Position the flat cable (callout 1) on the keyboard into the keyboard slot (callout 2).

Figure 1-4953 Install the flat cable through the slot



2. Slide the keyboard tray into the slot.

 **NOTE:** Only slide the tray halfway into the opening. This makes connecting the cable in the next step easier.

Figure 1-4954 Slide the keyboard into the slot



3. If the flat cable (callout 1) is not in the opening (callout 2) in the control panel base, carefully reach in and thread the flat cable through the opening.

Figure 1-4955 Check the flat cable

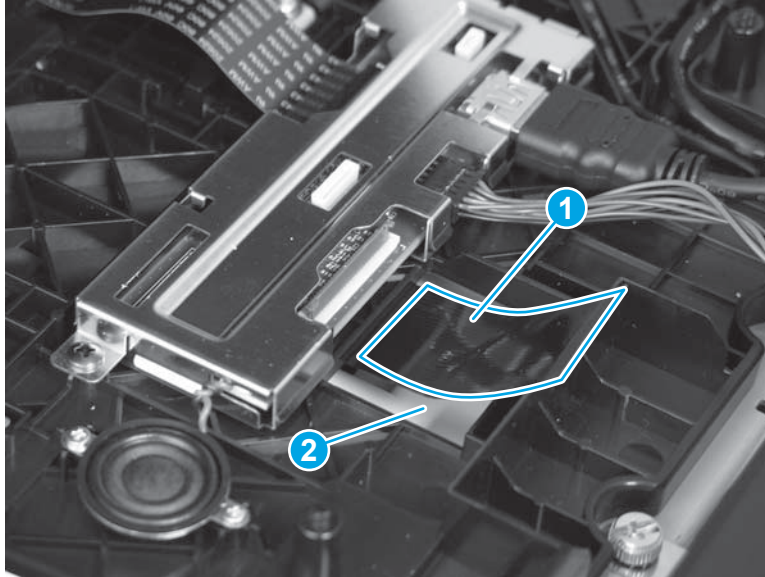

4. Position the keyboard flat cable in the connector, and then close the connector latch.

 **IMPORTANT:** Slightly tug on the cable to make sure that it is fully captured in the connector.



 **NOTE:** When the connector latch is closed and the cable is correctly installed, the white line on the cable is parallel to the connector latch.

Figure 1-4956 Connect the flat cable

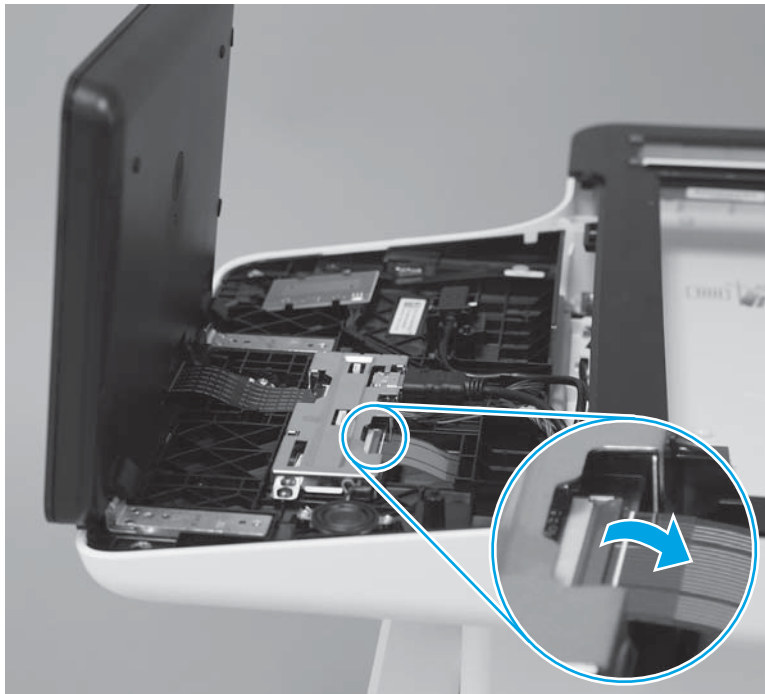

Step 26: Install the white backing (M577)

 **IMPORTANT:** When a replacement image scanner is installed, the white backing on the document feeder must be removed, and then a replacement white backing (supplied in the kit) must be installed.

1. Open the document feeder, and then place the replacement white backing on the flatbed scanner glass, as shown.

 **NOTE:** Place the corner of the backing that does not have a hook-and-loop fastener in the upper-left corner of the scanner glass.

Figure 1-4957 Install the white backing



2. Close the document feeder.

Figure 1-4958 Close the document feeder

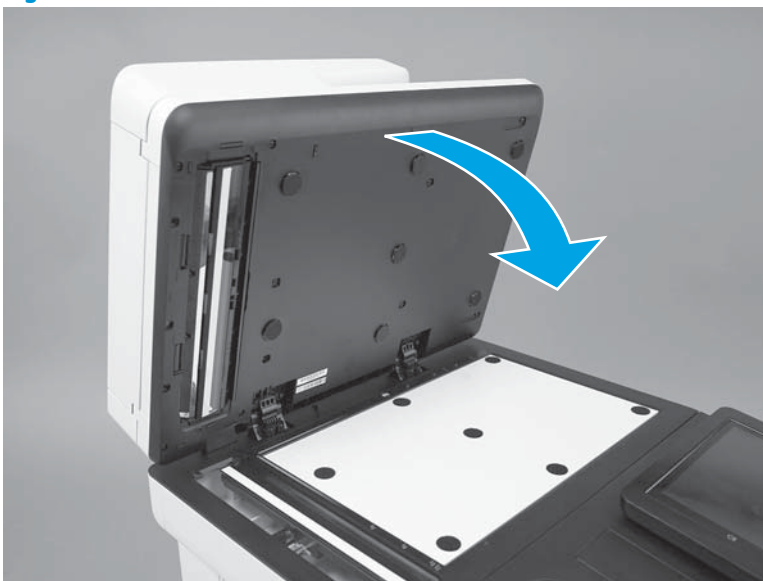

3. Open the document feeder and make sure that the white backing is securely attached.

Figure 1-4959 Check the white backing



Step 27: Install the control-panel cover (M577)

1. Position the control-panel cover on the printer.

Figure 1-4960 Position the control-panel cover on the printer



2. Beginning at the left side of the control-panel cover, carefully push down along the top edge of the cover to engage five tabs.

Figure 1-4961 Engage five tabs

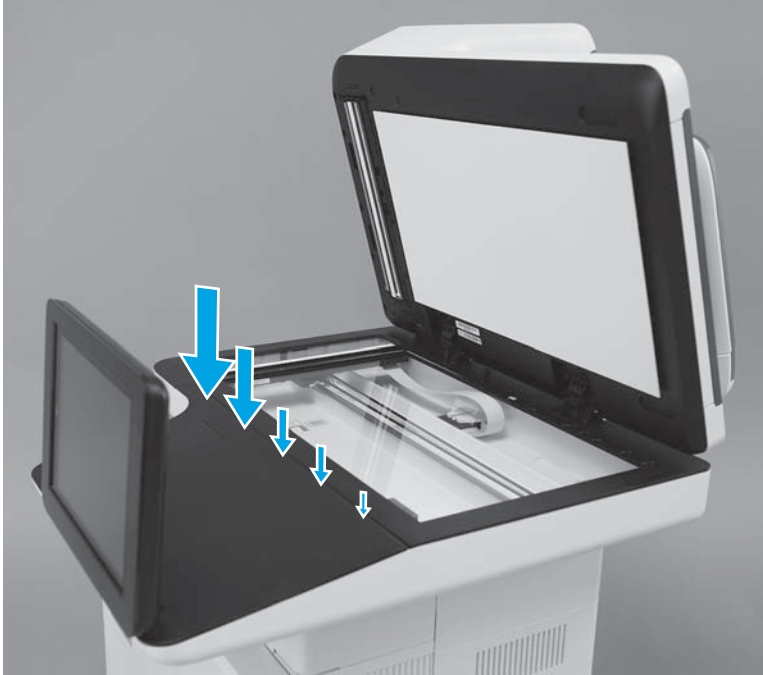

3. Close the document feeder.

 **NOTE:** Adjust the control panel to the desired angle.

Figure 1-4962 Close the document feeder



Removal and replacement: Trays

- [Removal and replacement: Tray 2](#)
- [Removal and replacement: Tray 3, Tray 4, or Tray 5](#)

Removal and replacement: Tray 2

- [Introduction](#)
- [Step 1: Remove the tray](#)
- [Step 2: Unpack the replacement assembly](#)
- [Step 3: Install the tray](#)

Introduction

This document provides the procedures to remove and replace Tray 2.

Before performing service

Use the table below to identify the correct part number for your printer, and then go to <http://h20141.www2.hp.com/hpparts> to order the part.

Tray 2 part number	
RM2-0007-000CN	Tray 2

Required tools

No special tools are required to install this part.

After performing service

Make sure that Tray 2 is fully closed after replacing it.

Post service test

Print a configuration page to make sure that the printer is functioning correctly.

Step 1: Remove the tray

1. Pull the tray out until it stops.

Figure 1-4963 Pull the tray out



2. Lift the front of the tray, and then pull it out of the printer to remove it.

Figure 1-4964 Remove the tray

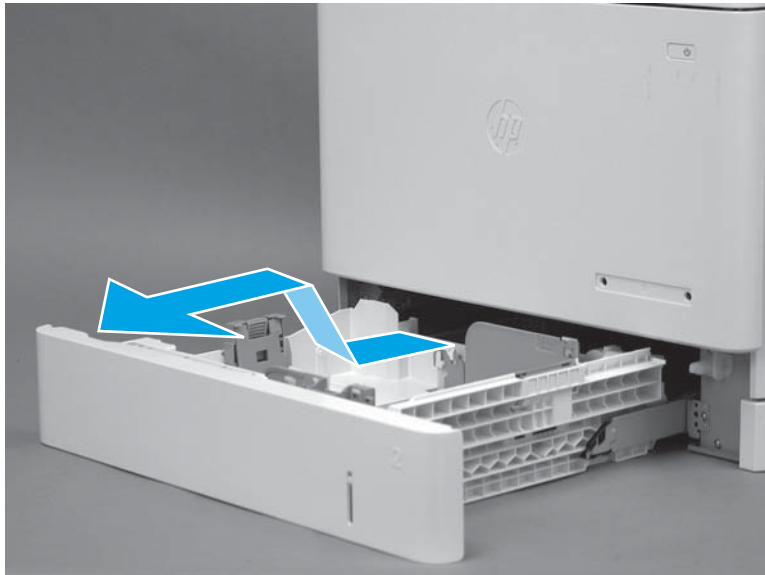

Step 2: Unpack the replacement assembly

Unpack the replacement assembly from the packaging.

For complete information on HP's recycling programs, go to [Product return and recycling](#).



NOTE: HP recommends responsible disposal of the defective assembly.

Figure 1-4965 Recycle and unpack

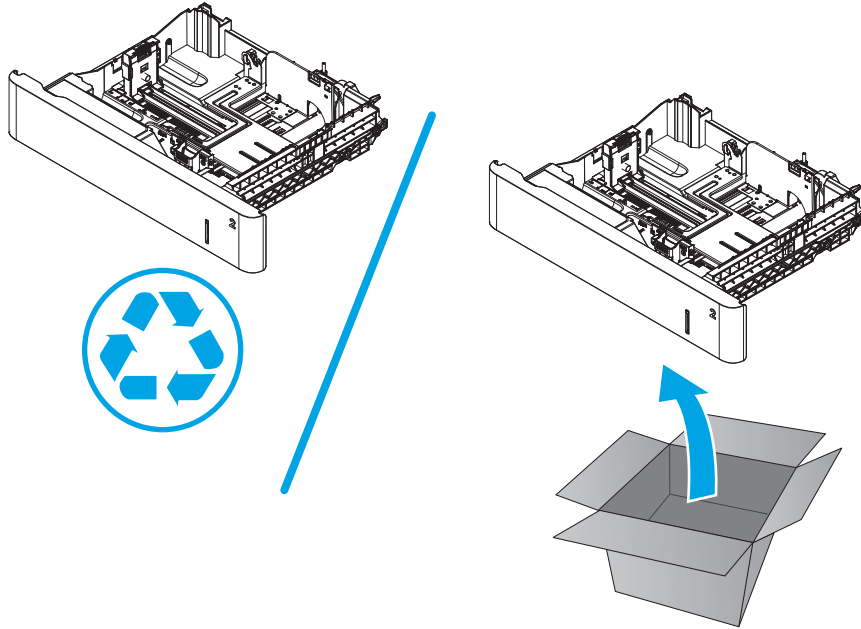

Step 3: Install the tray

1. With the front of the tray slightly lifted, align the sides of the tray with the rails in the printer, and then carefully slide the tray into the printer.

 **TIP:** As the tray slides into the printer, lower the front of it.

Figure 1-4966 Install the tray



2. Close the tray.

Figure 1-4967 Close the tray



Removal and replacement: Tray 3, Tray 4, or Tray 5

- [Introduction](#)
- [Step 1: Remove the tray](#)
- [Step 2: Unpack the replacement assembly](#)
- [Step 3: Install the tray](#)

Introduction

This document provides the procedures to remove and replace Tray 3, Tray 4, or Tray 5.

Before performing service

Use the table below to identify the correct part number for your printer, and then go to <http://h20141.www2.hp.com/hpparts> to order the part.

Tray 3/4/5 part number	
RM2-5150-000CN	Tray 3, Tray 4, or Tray 5

Required tools

No special tools are required to install this part.

After performing service

Make sure that Tray 3/4/5 is fully closed after replacing it.

Post service test

Print a page from a host computer using the appropriate tray as the source tray.

Step 1: Remove the tray

1. Pull the tray out until it stops.

Figure 1-4968 Pull the tray out

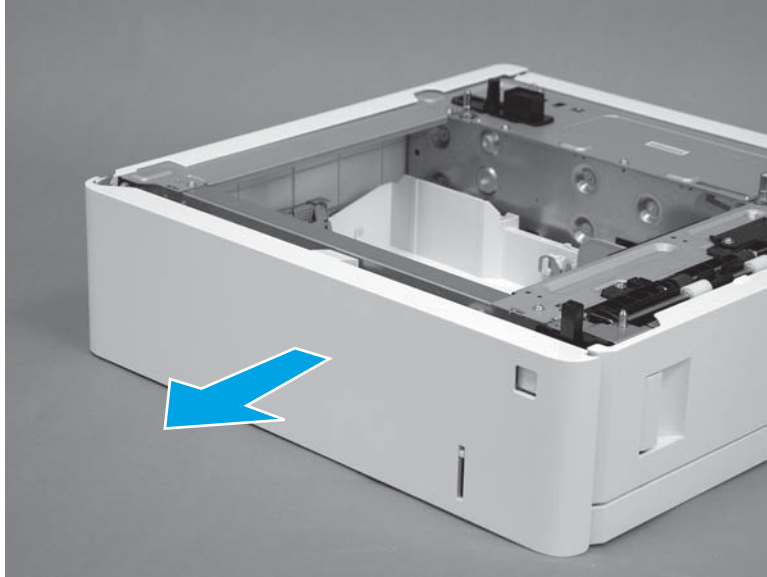

2. Lift the front of the tray, and then pull it out of the printer to remove it.

Figure 1-4969 Remove the tray

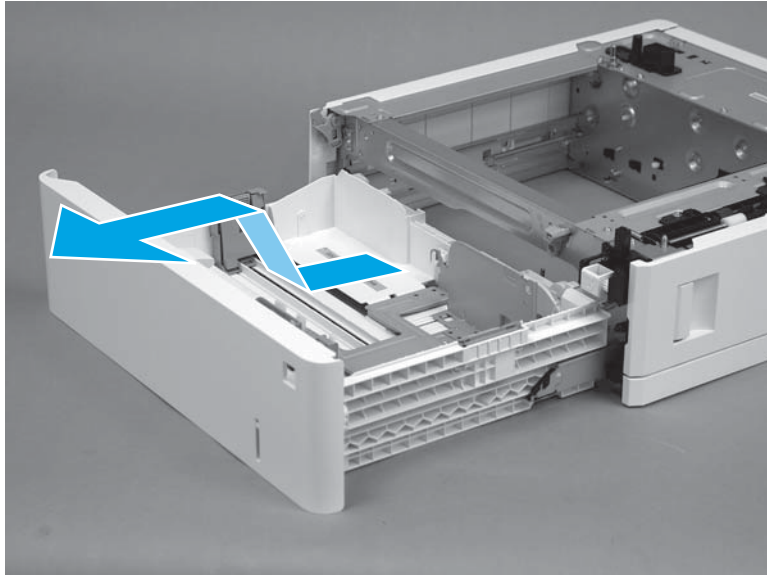

Step 2: Unpack the replacement assembly

Unpack the replacement assembly from the packaging.

For complete information on HP's recycling programs, go to [Product return and recycling](#).



NOTE: HP recommends responsible disposal of the defective assembly.

Figure 1-4970 Recycle and unpack

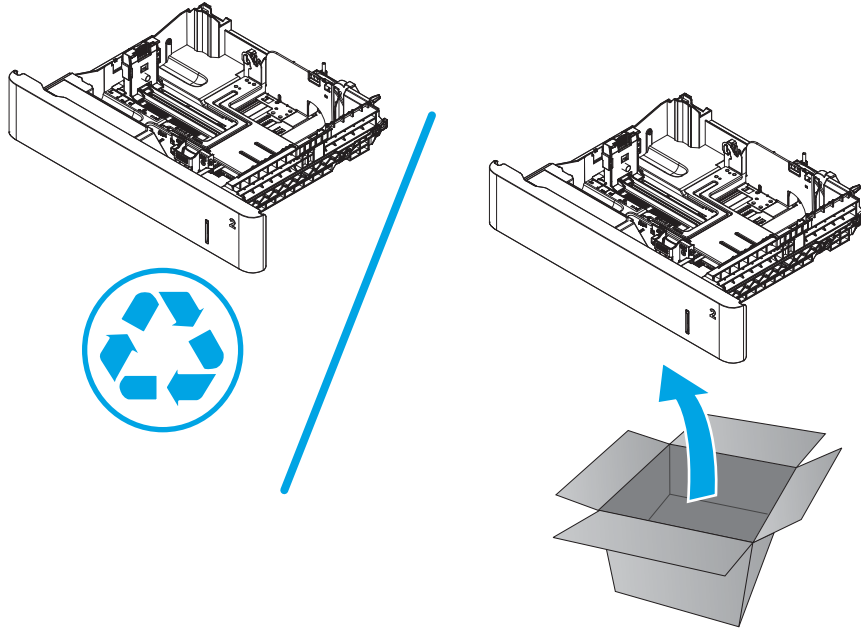

Step 3: Install the tray

1. With the front of the tray slightly lifted, align the sides of the tray with the rails in the printer, and then carefully slide the tray into the printer.

 **TIP:** As the tray slides into the accessory, lower the front of it.

Figure 1-4971 Install the tray



2. Close the tray.

Figure 1-4972 Close the tray

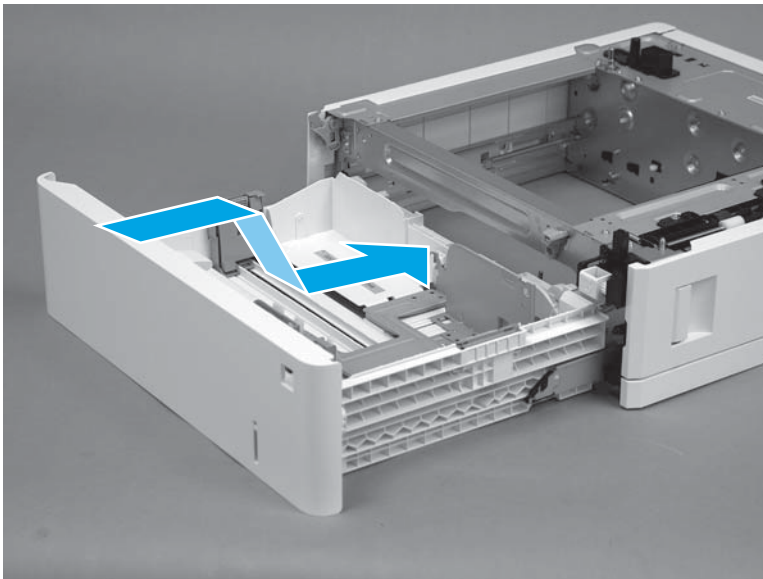
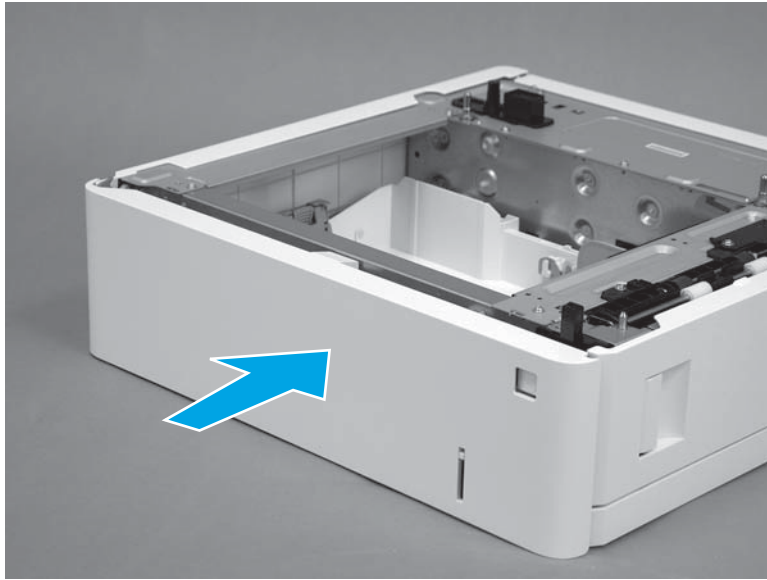

Removal and replacement: Accessories

- [Removal and replacement: 1x550-sheet paper feeder](#)
- [Removal and replacement: Trusted platform module \(M552 and M553\)](#)
- [Removal and replacement: Trusted platform module \(M577\)](#)
- [Removal and replacement: Internal USB ports \(M552 and M553\)](#)
- [Removal and replacement: Internal USB ports \(M577\)](#)
- [Removal and replacement: Fax PCA \(M577c/f/z\)](#)

Removal and replacement: 1x550-sheet paper feeder



NOTE: HP recommends removing the accessories from the product before servicing them.

- [Removal and replacement: Rear cover \(1x550-sheet paper feeder\)](#)
- [Removal and replacement: Right door \(1x550-sheet paper feeder\)](#)
- [Removal and replacement: Right door hinge bracket \(1x550-sheet paper feeder\)](#)
- [Removal and replacement: Right-lower cover \(1x550-sheet paper feeder\)](#)
- [Removal and replacement: Right-door link \(1x550-sheet paper feeder\)](#)
- [Removal and replacement: Left cover \(1x550-sheet paper feeder\)](#)
- [Removal and replacement: OP Drawer holder \(1x550-sheet paper feeder\)](#)
- [Removal and replacement: Auto close assembly \(1x550-sheet paper feeder\)](#)
- [Removal and replacement: Switch button \(SW12\) \(1x550-sheet paper feeder\)](#)
- [Removal and replacement: Drawer connector holder \(1x550-sheet paper feeder\)](#)
- [Removal and replacement: Paper-feeder drive PCA \(1x550-sheet paper feeder\)](#)
- [Removal and replacement: Paper feed assembly \(1x550-sheet paper feeder\)](#)
- [Removal and replacement: Paper pickup assembly \(1x550-sheet paper feeder\)](#)
- [Removal and replacement: Feeder drive assembly \(1x550-sheet paper feeder\)](#)
- [Removal and replacement: Lifter drive assembly \(1x550-sheet paper feeder\)](#)

Removal and replacement: Rear cover (1x550-sheet paper feeder)

- [Introduction](#)
- [Step 1: Remove the rear cover](#)
- [Step 2: Unpack the replacement assembly](#)
- [Step 3: Install the rear cover](#)

Introduction

This document provides the procedures to remove and replace the 1x550-sheet paper feeder rear cover.

Before performing service

Use the table below to identify the correct part number for your printer, and then go to <http://h20141.www2.hp.com/hpparts> to order the part.

Rear cover (1x550-sheet paper feeder) part number	
RC4-1792-000CN	Rear cover (1x550-sheet paper feeder)

Required tools

No special tools are required to install this part.

After performing service

Make sure that the rear cover is flush against the chassis after replacing it.

Step 1: Remove the rear cover

1. Release three tabs (callout 1).

Figure 1-4973 Release three tabs

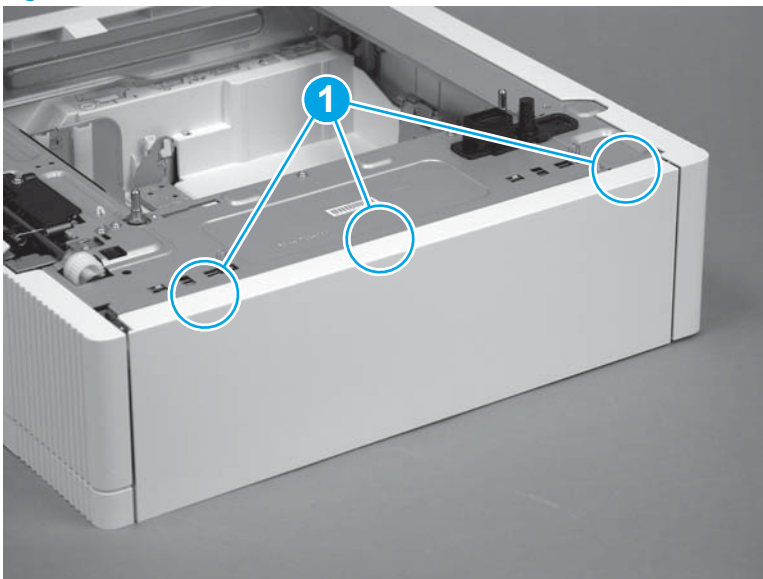

2. Rotate the top of the cover away from the accessory (callout 1), and then lift it up to remove it (callout 2).

Figure 1-4974 Remove the cover

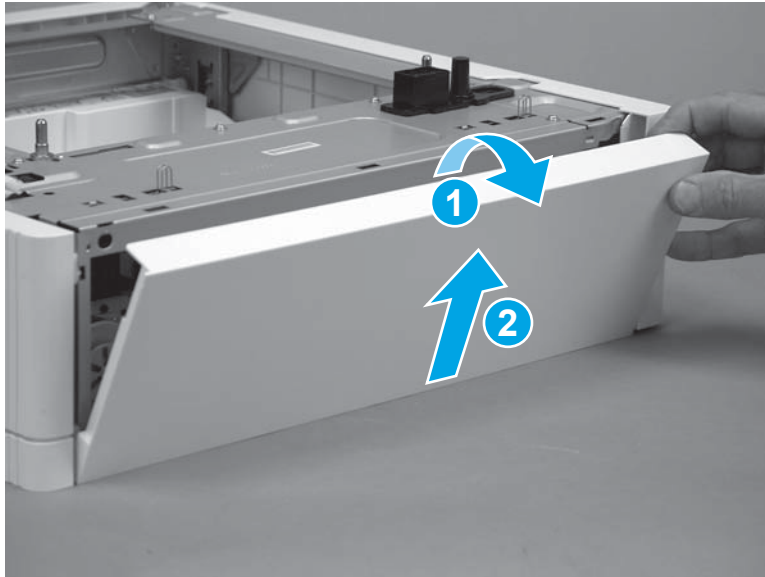

Step 2: Unpack the replacement assembly

Unpack the replacement assembly from the packaging.

For complete information on HP's recycling programs, go to [Product return and recycling](#).

 **NOTE:** HP recommends responsible disposal of the defective assembly.

Figure 1-4975 Recycle and unpack



Step 3: Install the rear cover

1. Align the three mounting tabs (callout 1) on the cover with the slots in the chassis.

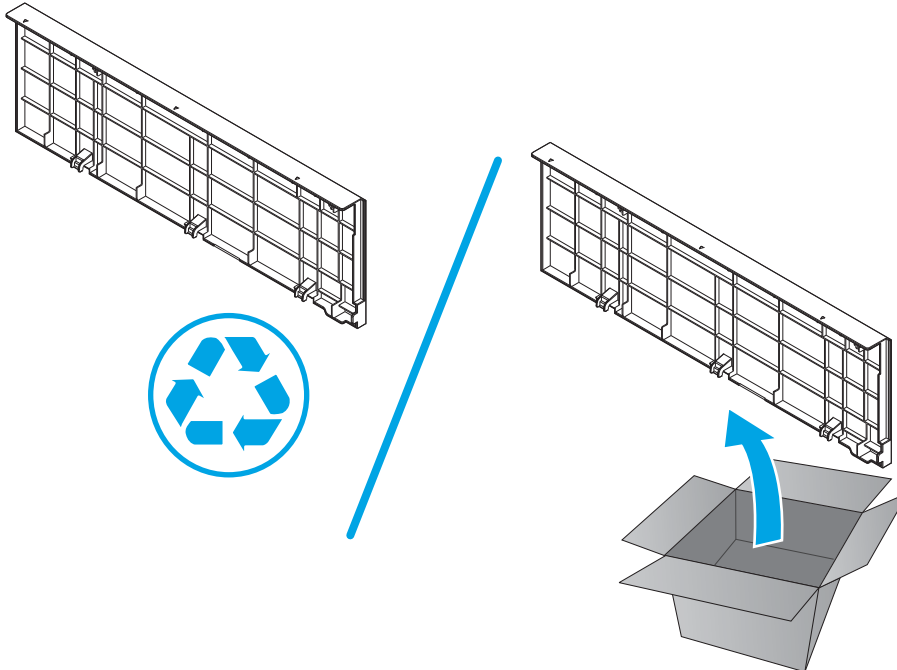
Figure 1-4976 Position the cover on the chassis

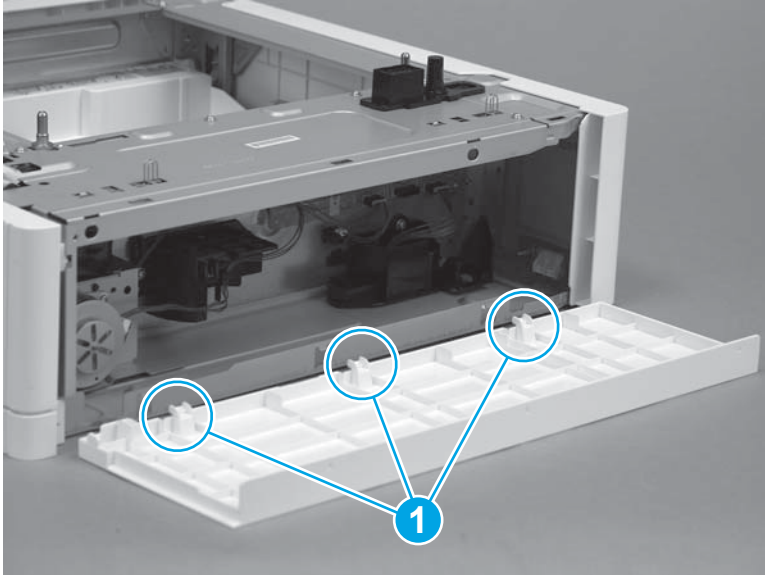

2. Position the cover on the accessory (callout 1), and then rotate the top of the cover up and onto the chassis (callout 2) to install it.

Figure 1-4977 Install the cover

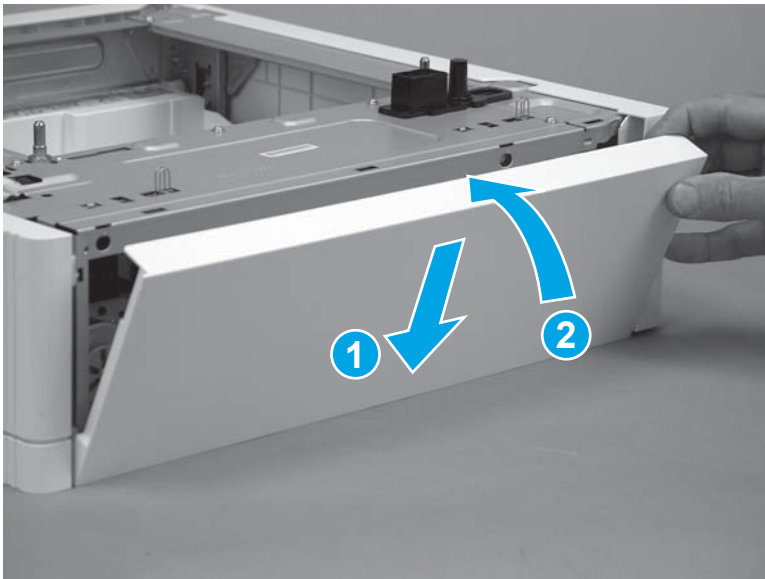

3. Make sure that the three tabs (callout 1) snap into place.

Figure 1-4978 Check the three tabs

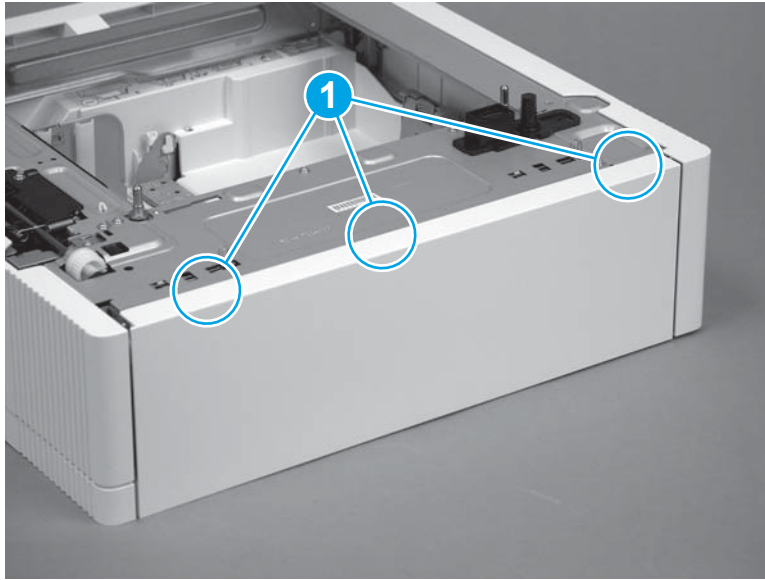

Removal and replacement: Right door (1x550-sheet paper feeder)

- [Introduction](#)
- [Step 1: Remove the rear cover](#)
- [Step 2: Remove the right door](#)
- [Step 3: Unpack the replacement assembly](#)
- [Step 4: Install the right door](#)
- [Step 5: Install the rear cover](#)

Introduction

This document provides the procedures to remove and replace the 1x550-sheet paper feeder right door.

Before performing service

Use the table below to identify the correct part number for your printer, and then go to <http://h20141.www2.hp.com/hpparts> to order the part.

Right door (1x550-sheet paper feeder) part number	
RM2-5146-000CN	Right door (1x550-sheet paper feeder)

Required tools

No special tools are required to install this part.

After performing service

Make sure that the right door latches correctly when closed after replacing it.

Step 1: Remove the rear cover

1. Release three tabs (callout 1).

Figure 1-4979 Release three tabs

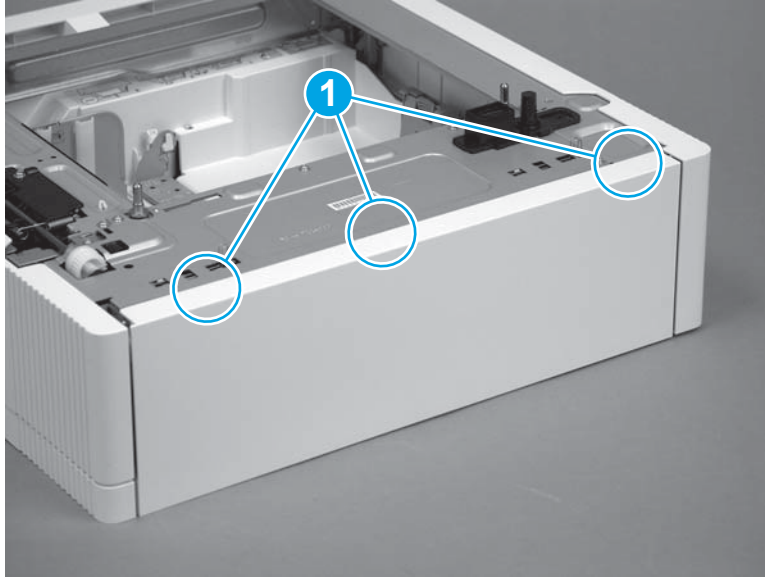

2. Rotate the top of the cover away from the accessory (callout 1), and then lift it up to remove it (callout 2).

Figure 1-4980 Remove the cover

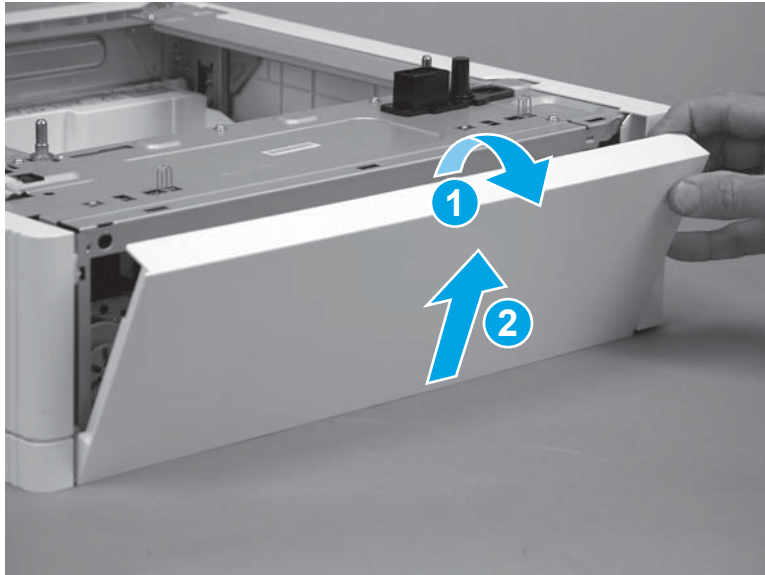

Step 2: Remove the right door

1. Open the door.

Figure 1-4981 Open the door

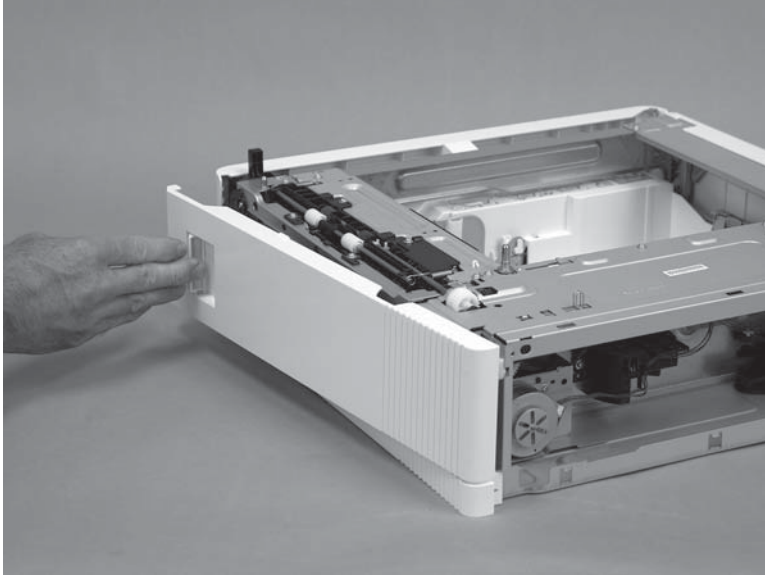

2. Release one tab (callout 1), and then slide the door-hinge bracket away from the chassis (callout 2) to release it.

Figure 1-4982 Release the hinge bracket

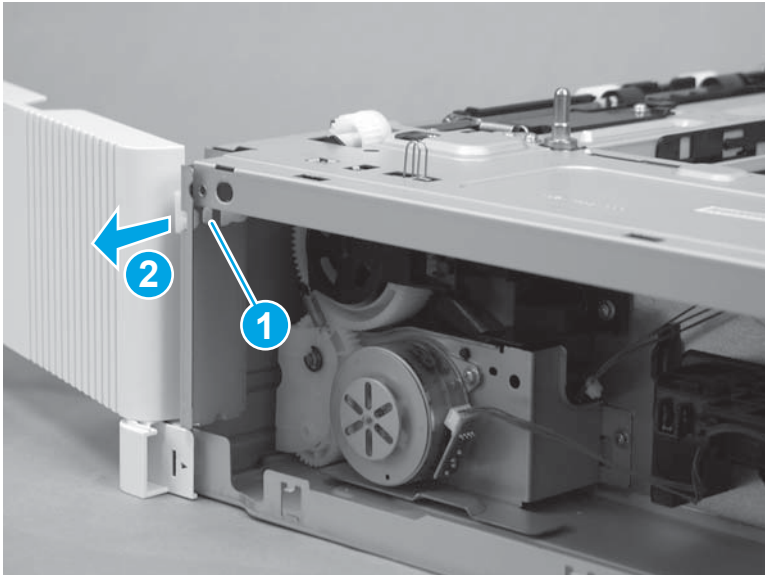

3. Remove the door-hinge bracket from the chassis.

CAUTION: The door is still attached to the accessory by the door link. Do not attempt to completely remove the door.

The door hinge bracket is not captive. Do not lose it when handling the door.

Figure 1-4983 Remove the hinge bracket

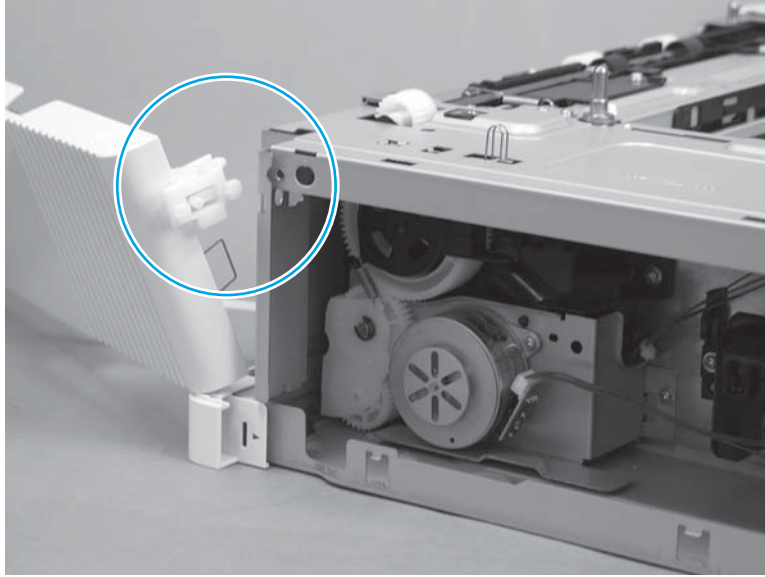

4. Release the door link from the slot in the door to remove the right door.

Figure 1-4984 Release the door link

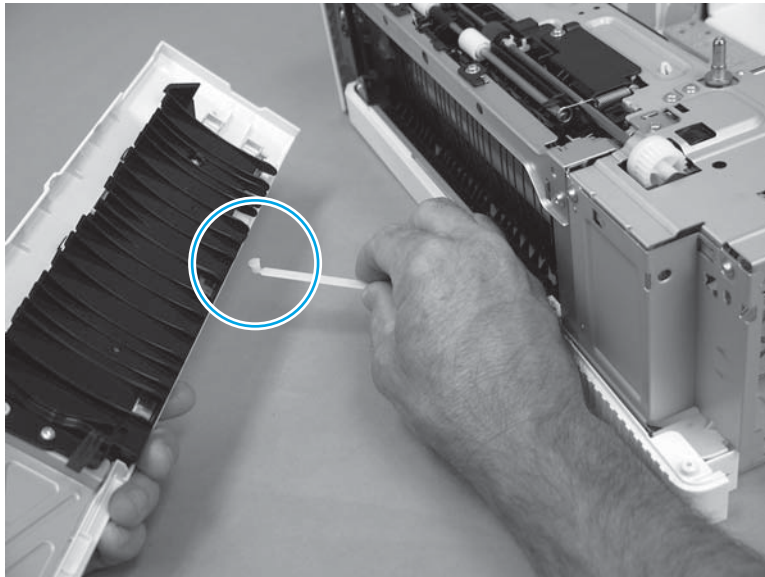

Step 3: Unpack the replacement assembly

Unpack the replacement assembly from the packaging.

For complete information on HP's recycling programs, go to [Product return and recycling](#).

 **NOTE:** HP recommends responsible disposal of the defective assembly.

Figure 1-4985 Recycle and unpack

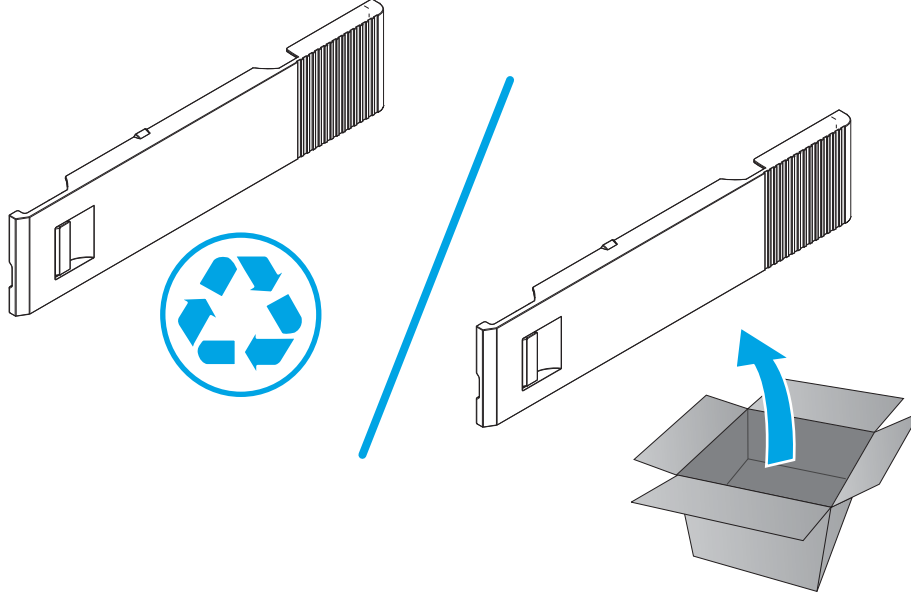

Step 4: Install the right door

 **NOTE:** If a replacement right door is installed, remove the right door hinge bracket from the discarded door, and then install it on the replacement door.

1. Install the door link in the slot in the door to attach the door.

Figure 1-4986 Install the door link

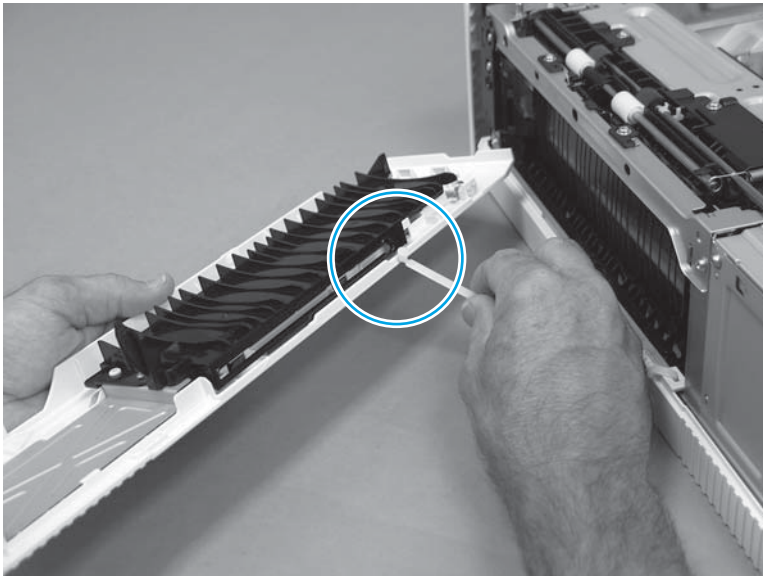

2. Position the lower hinge hole on the door (callout 2) on the lower hinge pin (callout 2) on the right-lower cover.

Figure 1-4987 Position the door on the lower hinge

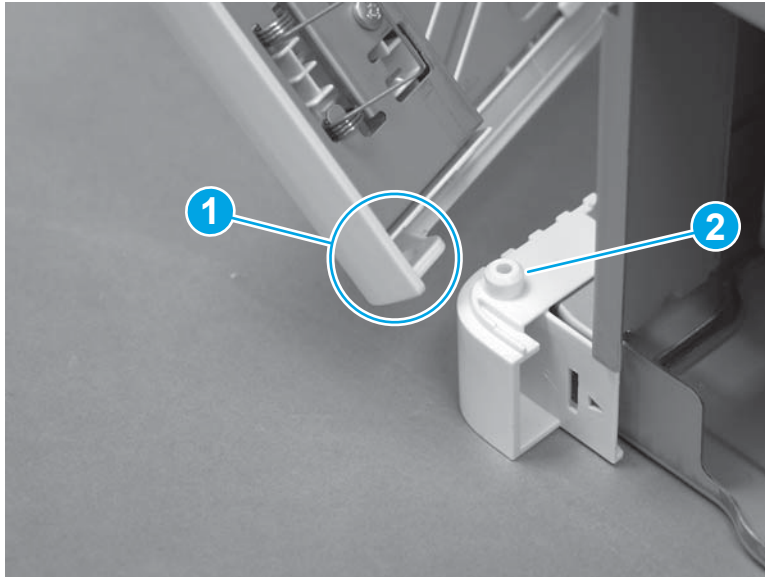

3. Align the pin of the door-hinge bracket (callout 1) with the hole in the chassis, and then align the mounting tabs (callout 2 and callout 3) with the slots in the chassis.

Figure 1-4988 Engage the hinge bracket

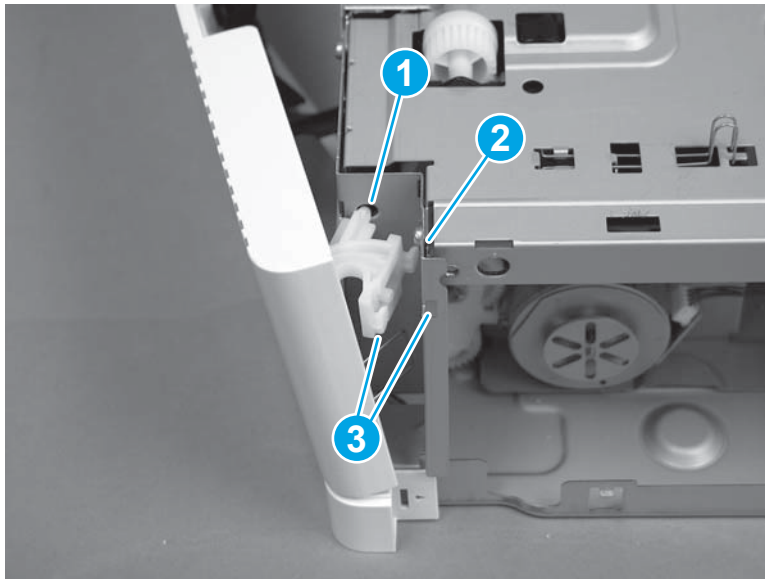

4. Push in on the door-hinge bracket (callout 1), and then slide it toward the chassis (callout 2) to install it.

Figure 1-4989 Install the hinge bracket

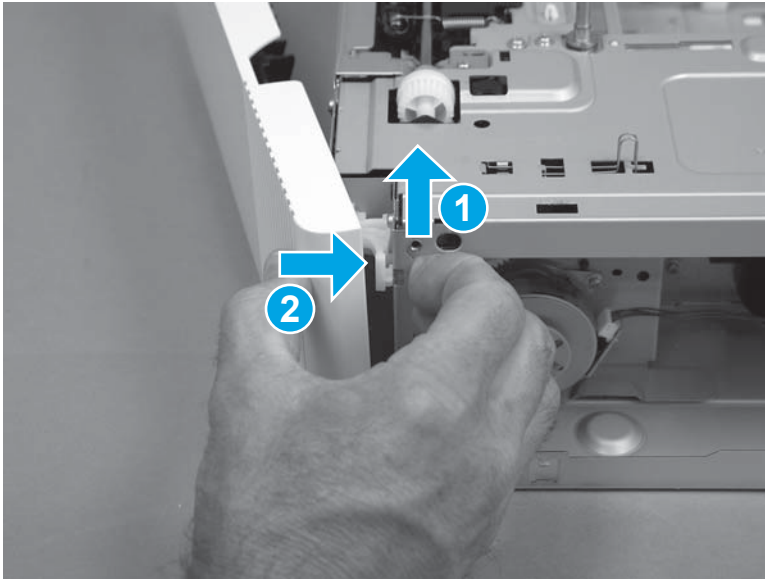

5. Close the door.

Figure 1-4990 Close the door

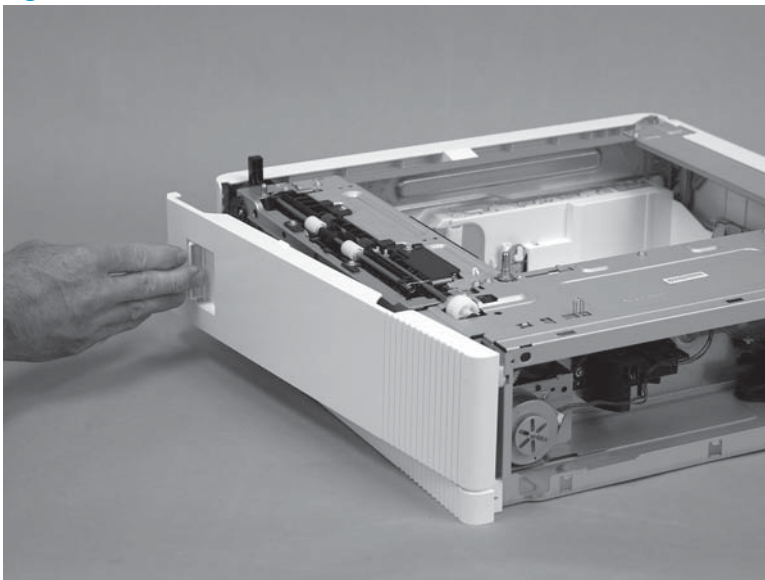

Step 5: Install the rear cover

1. Align the three mounting tabs (callout 1) on the cover with the slots in the chassis.

Figure 1-4991 Position the cover on the chassis

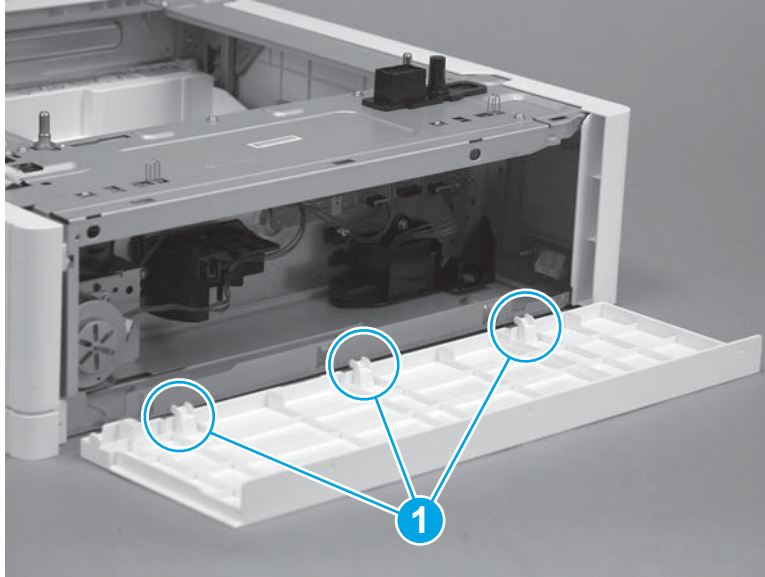

2. Position the cover on the accessory (callout 1), and then rotate the top of the cover up and onto the chassis (callout 2) to install it.

Figure 1-4992 Install the cover

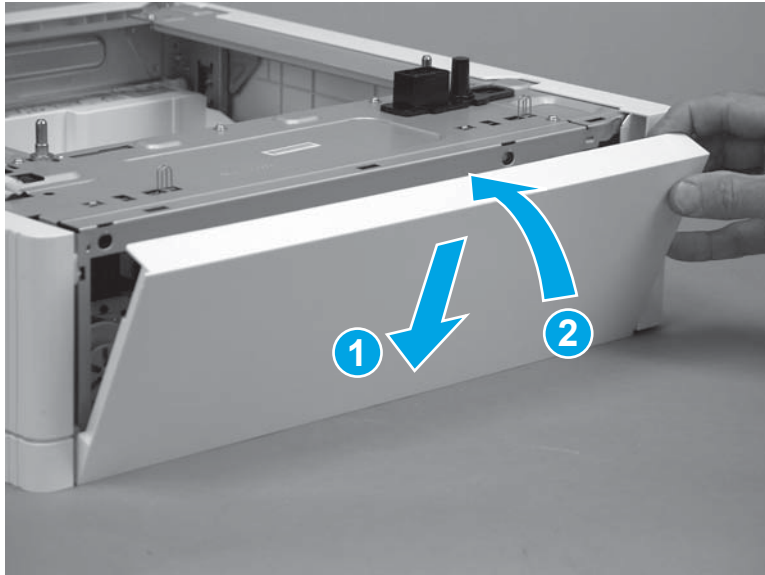

3. Make sure that the three tabs (callout 1) snap into place.

Figure 1-4993 Check the three tabs

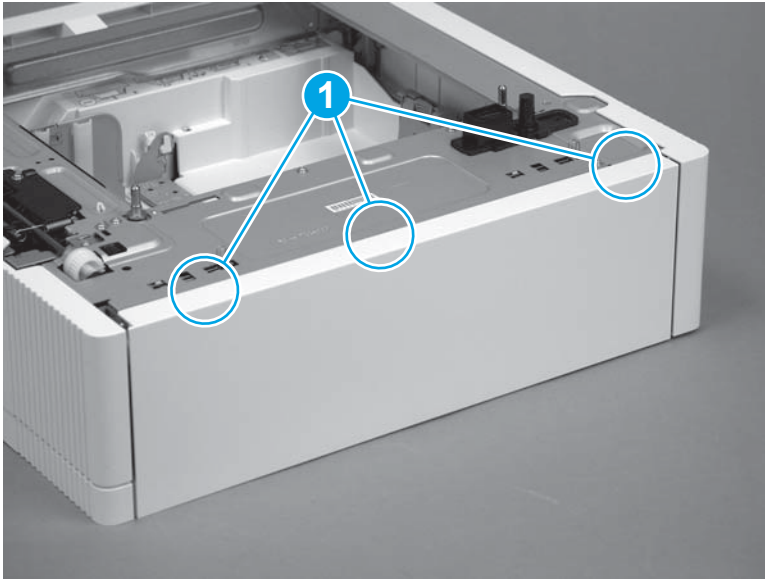

Removal and replacement: Right door hinge bracket (1x550-sheet paper feeder)

- [Introduction](#)
- [Step 1: Remove the rear cover](#)
- [Step 2: Remove the right door](#)
- [Step 3: Remove the right door hinge bracket](#)
- [Step 4: Unpack the replacement assembly](#)
- [Step 5: Install the right door hinge bracket](#)
- [Step 6: Install the right door](#)
- [Step 7: Install the rear cover](#)

Introduction

This document provides the procedures to remove and replace the 1x550-sheet paper feeder right door hinge bracket.

Before performing service

Use the table below to identify the correct part number for your printer, and then go to <http://h20141.www2.hp.com/hpparts> to order the part.

Right door hinge bracket (1x550-sheet paper feeder) part number	
RC4-1781-000CN	Right door hinge bracket (1x550-sheet paper feeder)

Required tools

No special tools are required to install this part.

After performing service

Make sure that the right door latches correctly when closed after replacing it.

Step 1: Remove the rear cover

1. Release three tabs (callout 1).

Figure 1-4994 Release three tabs

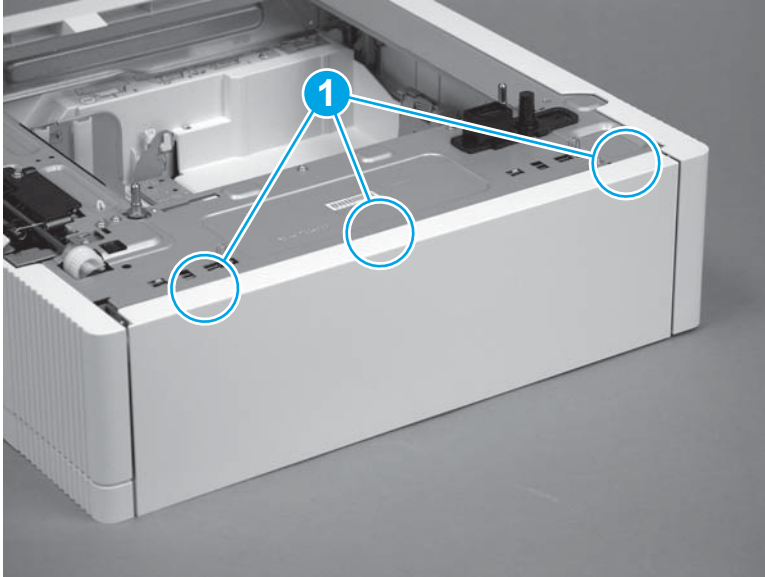

2. Rotate the top of the cover away from the accessory (callout 1), and then lift it up to remove it (callout 2).

Figure 1-4995 Remove the cover

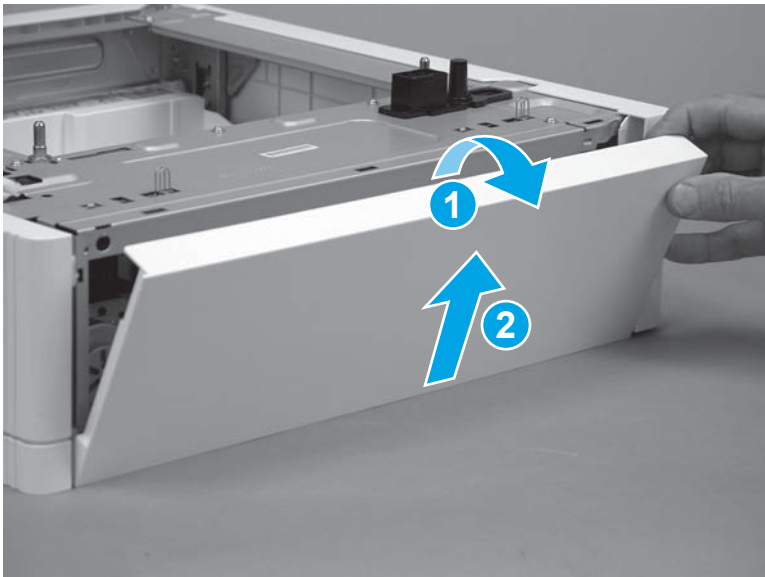

Step 2: Remove the right door

1. Open the door.

Figure 1-4996 Open the door

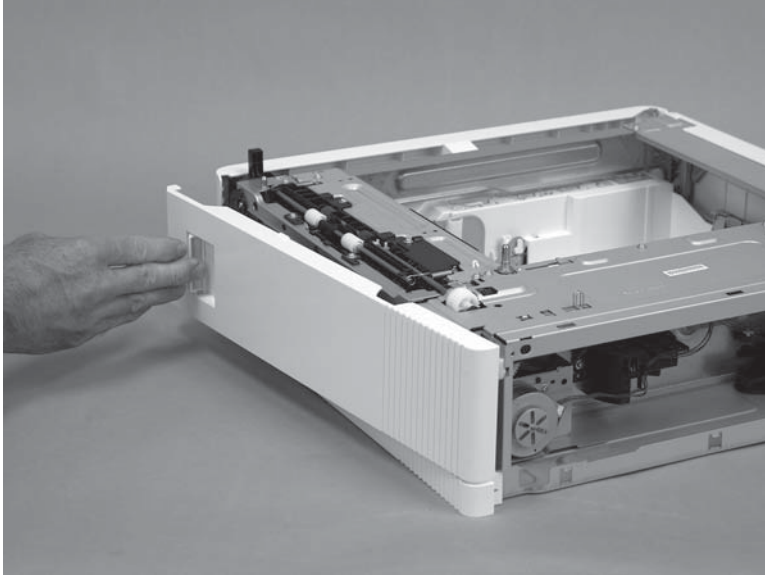

2. Release one tab (callout 1), and then slide the door-hinge bracket away from the chassis (callout 2) to release it.

Figure 1-4997 Release the hinge bracket

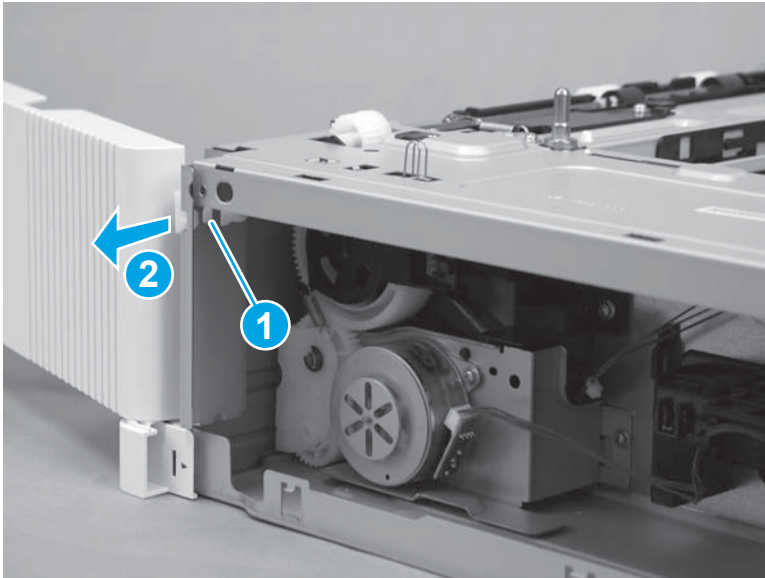

3. Remove the door-hinge bracket from the chassis.

⚠ CAUTION: The door is still attached to the accessory by the door link. Do not attempt to completely remove the door.

The door hinge bracket is not captive. Do not lose it when handling the door.

Figure 1-4998 Remove the hinge bracket

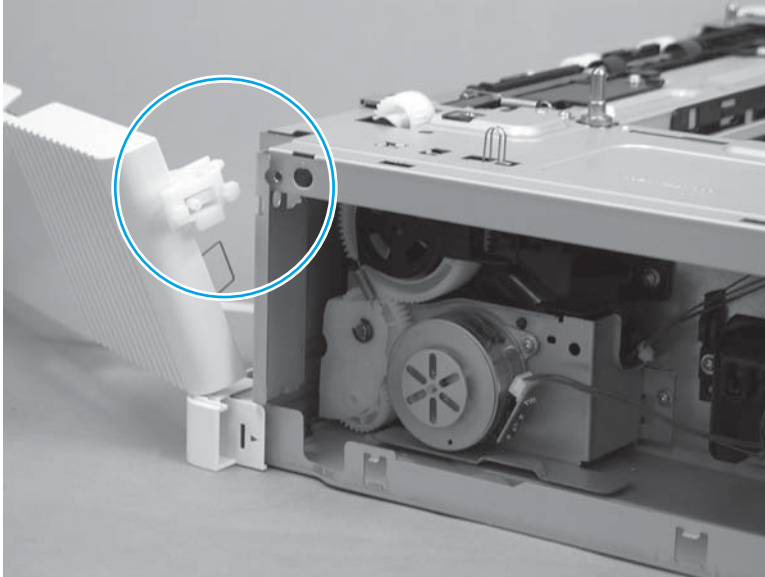

4. Release the door link from the slot in the door to remove the right door.

Figure 1-4999 Release the door link

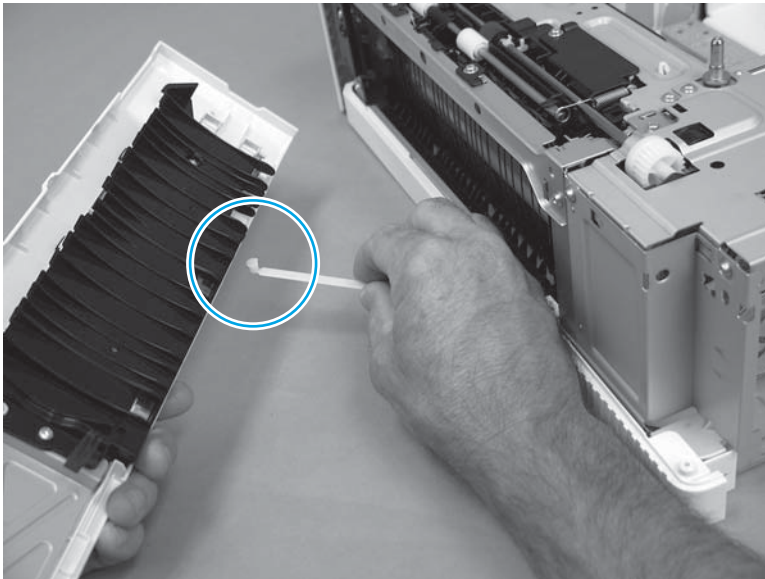

Step 3: Remove the right door hinge bracket

- ▲ Separate the right door hinge bracket from the door to remove it.

Figure 1-5000 Remove the hinge bracket

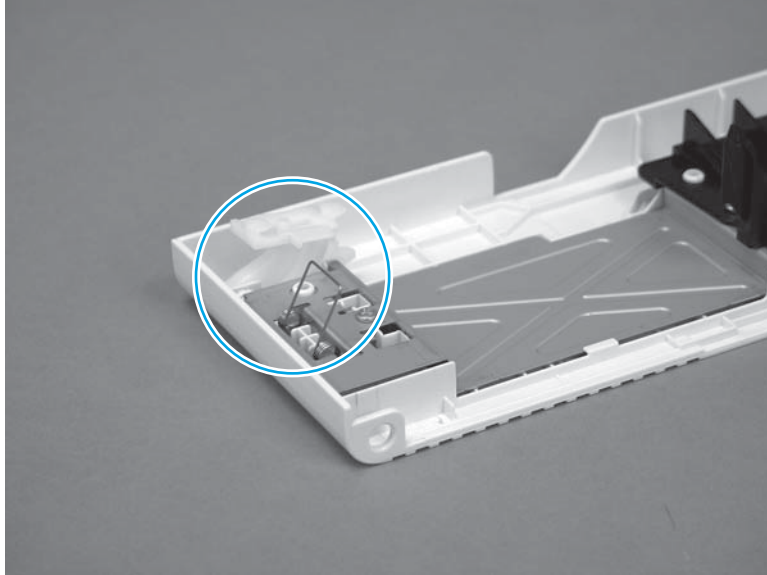

Step 4: Unpack the replacement assembly

Unpack the replacement assembly from the packaging.

For complete information on HP's recycling programs, go to [Product return and recycling](#).

 **NOTE:** HP recommends responsible disposal of the defective assembly.

Figure 1-5001 Recycle and unpack

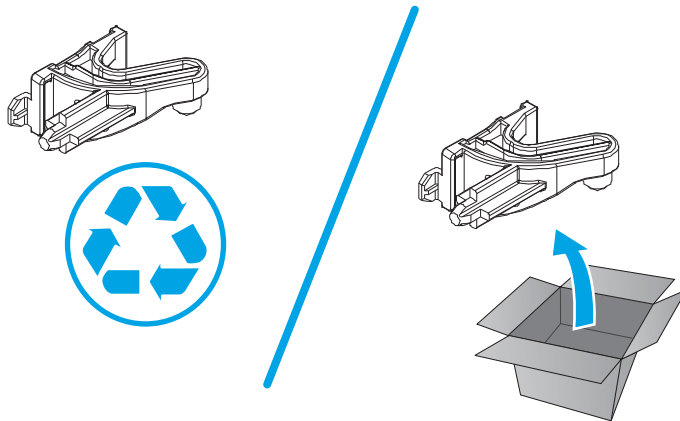

Step 5: Install the right door hinge bracket

- ▲ Install the right door hinge bracket on the door as shown.

Figure 1-5002 Install the hinge bracket



Step 6: Install the right door

1. Install the door link in the slot in the door to attach the door.

Figure 1-5003 Install the door link

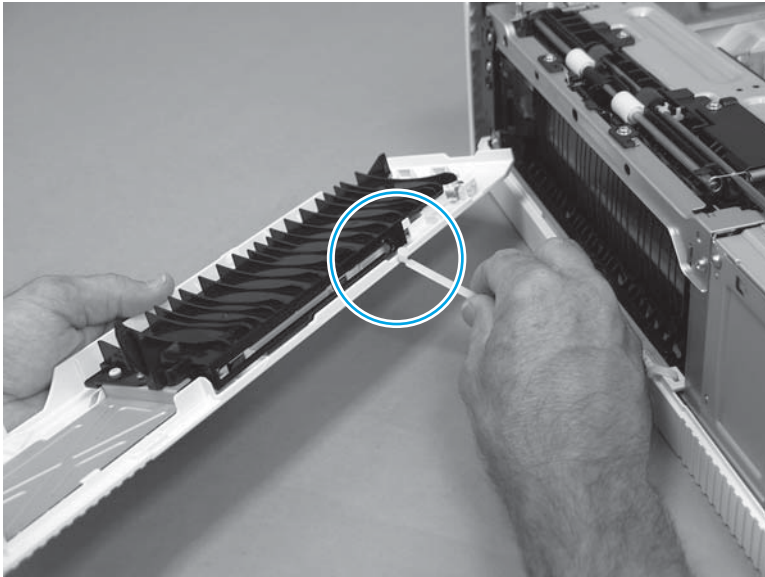

2. Position the lower hinge hole on the door (callout 2) on the lower hinge pin (callout 2) on the right-lower cover.

Figure 1-5004 Position the door on the lower hinge

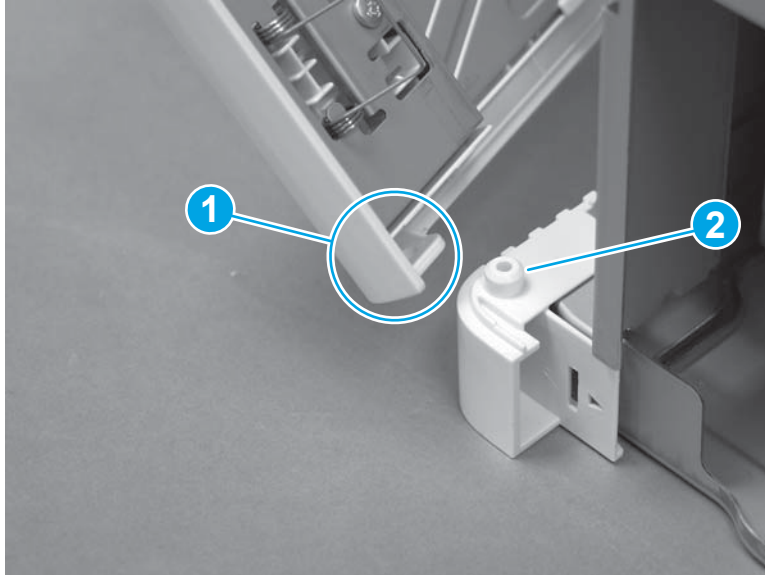

3. Align the pin of the door-hinge bracket (callout 1) with the hole in the chassis, and then align the mounting tabs (callout 2 and callout 3) with the slots in the chassis.

Figure 1-5005 Engage the hinge bracket

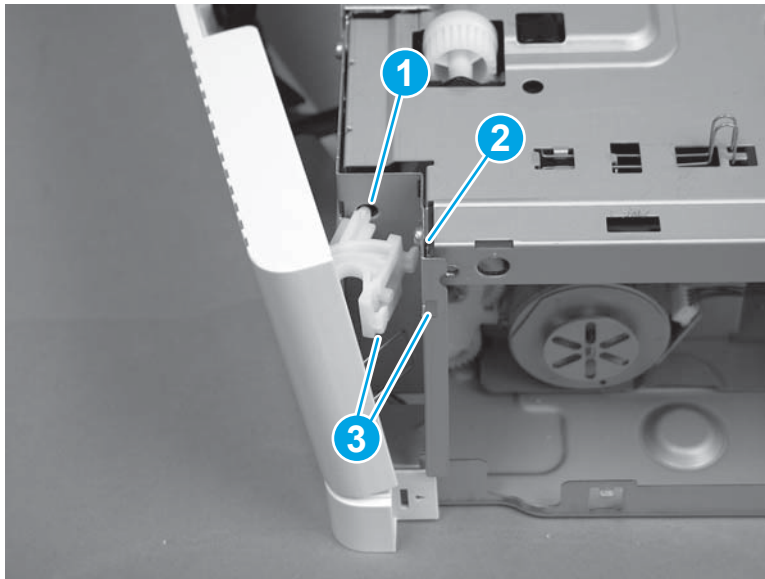

4. Push in on the door-hinge bracket (callout 1), and then slide it toward the chassis (callout 2) to install it.

Figure 1-5006 Install the hinge bracket

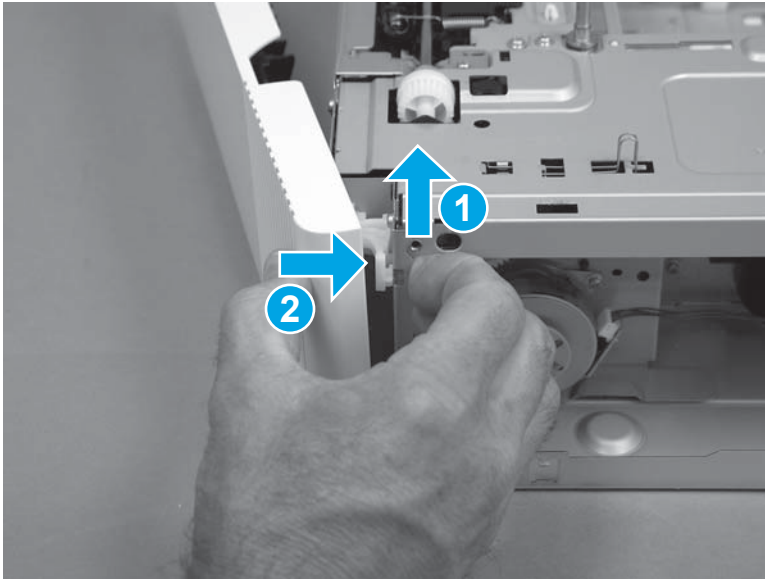

5. Close the door.

Figure 1-5007 Close the door

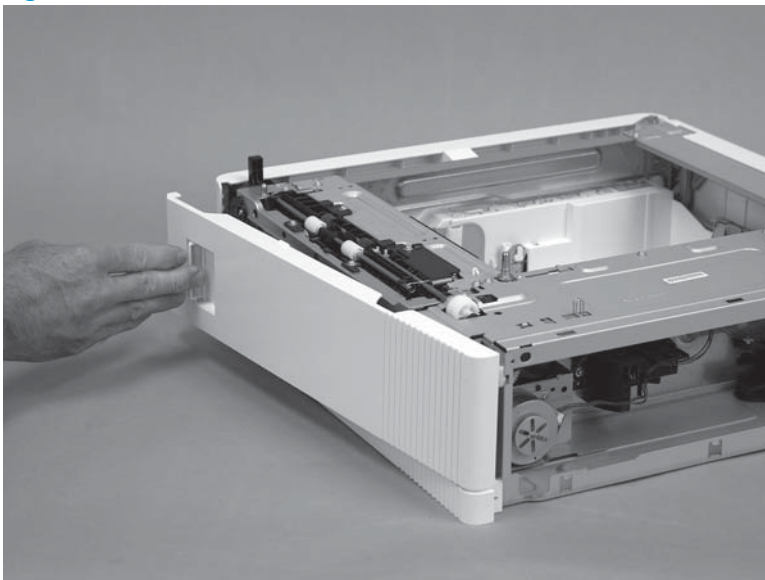

Step 7: Install the rear cover

1. Align the three mounting tabs (callout 1) on the cover with the slots in the chassis.

Figure 1-5008 Position the cover on the chassis

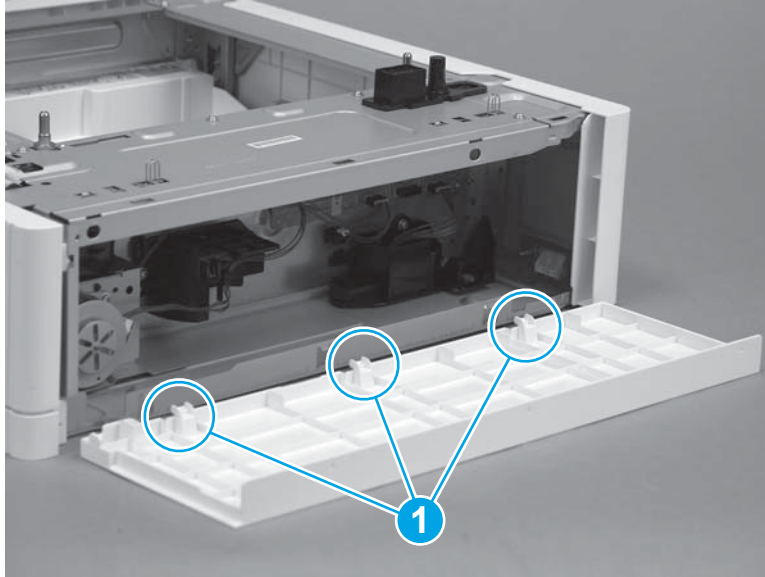

2. Position the cover on the accessory (callout 1), and then rotate the top of the cover up and onto the chassis (callout 2) to install it.

Figure 1-5009 Install the cover

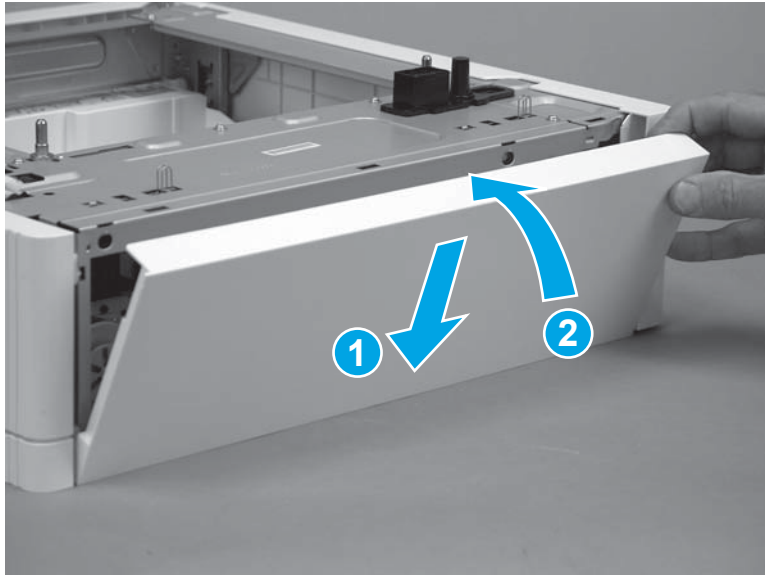

3. Make sure that the three tabs (callout 1) snap into place.

Figure 1-5010 Check the three tabs

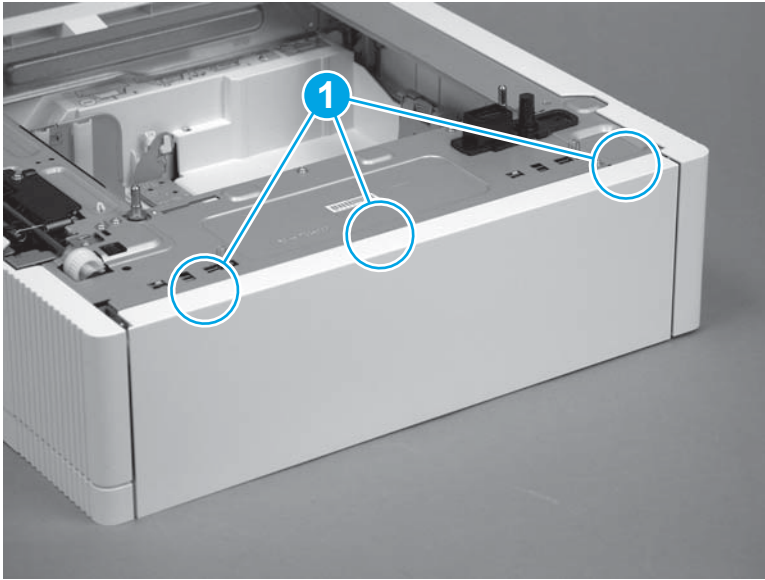

Removal and replacement: Right-lower cover (1x550-sheet paper feeder)

- [Introduction](#)
- [Step 1: Remove the rear cover](#)
- [Step 2: Remove the right door](#)
- [Step 3: Remove the right-lower cover](#)
- [Step 4: Remove the right-door link](#)
- [Step 5: Unpack the replacement assembly](#)
- [Step 6: Install the right-door link](#)
- [Step 7: Install the right-lower cover](#)
- [Step 8: Install the right door](#)
- [Step 9: Install the rear cover](#)

Introduction

This document provides the procedures to remove and replace the 1x550-sheet right-lower cover.

Before performing service

Use the table below to identify the correct part number for your printer, and then go to <http://h20141.www2.hp.com/hpparts> to order the part.

Right-lower cover (1x550-sheet paper feeder) part number	
RC4-1793-000CN	Right-lower cover (1x550-sheet paper feeder)

Required tools

No special tools are required to install this part.

After performing service

Make sure that the rear cover is flush against the chassis after replacing it.

Make sure that the right door latches correctly when closed after replacing it.

Step 1: Remove the rear cover

1. Release three tabs (callout 1).

Figure 1-5011 Release three tabs

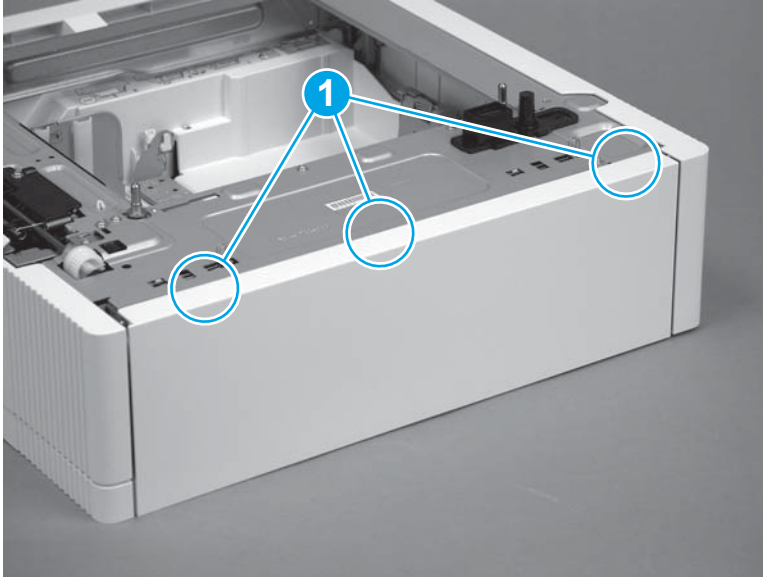

2. Rotate the top of the cover away from the accessory (callout 1), and then lift it up to remove it (callout 2).

Figure 1-5012 Remove the cover

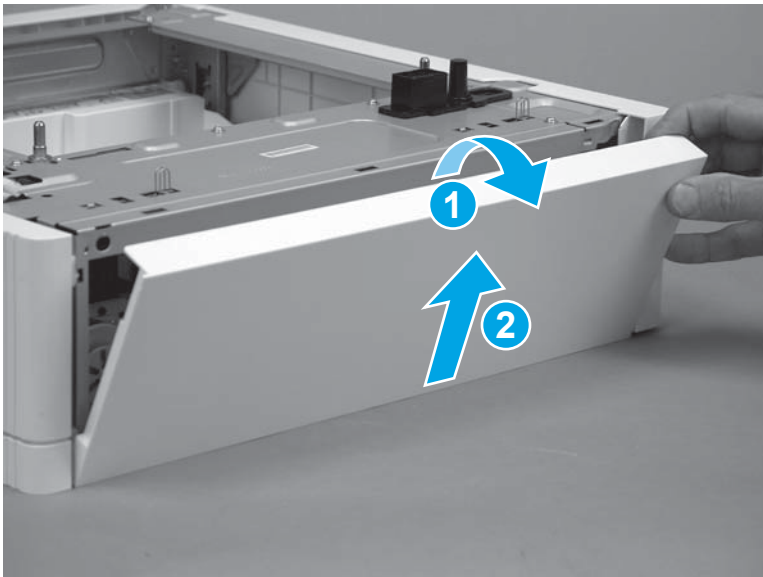

Step 2: Remove the right door

1. Open the door.

Figure 1-5013 Open the door

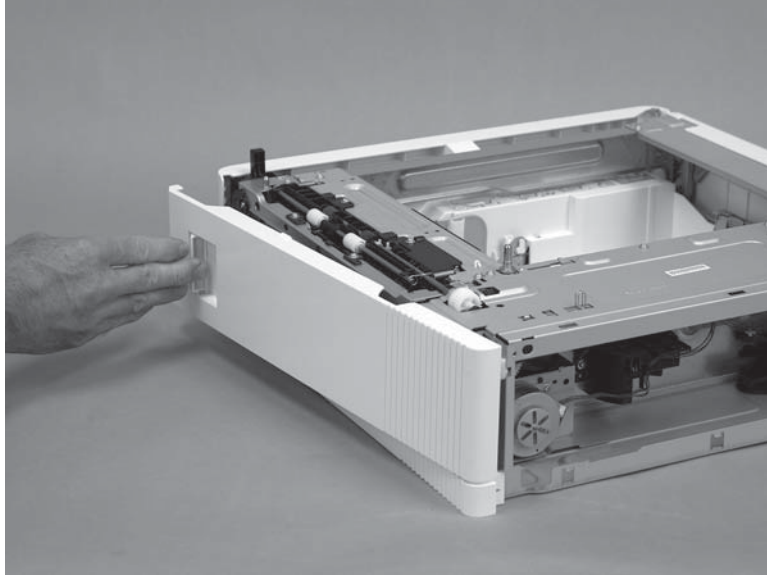

2. Release one tab (callout 1), and then slide the door-hinge bracket away from the chassis (callout 2) to release it.

Figure 1-5014 Release the hinge bracket

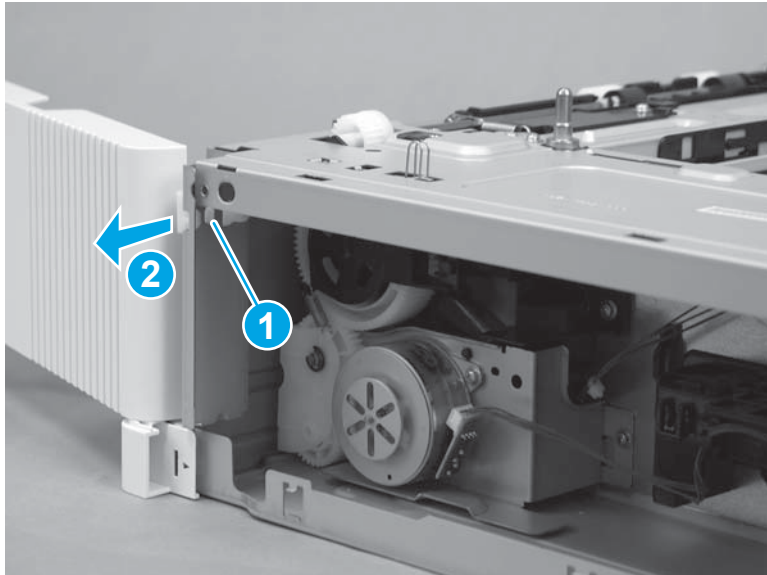

3. Remove the door-hinge bracket from the chassis.

⚠ CAUTION: The door is still attached to the accessory by the door link. Do not attempt to completely remove the door.

The door hinge bracket is not captive. Do not lose it when handling the door.

Figure 1-5015 Remove the hinge bracket

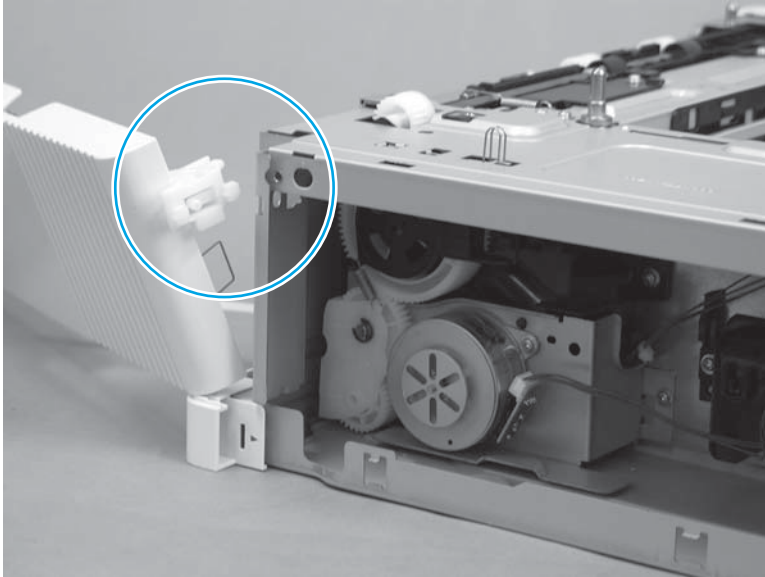

4. Release the door link from the slot in the door to remove the right door.

Figure 1-5016 Release the door link

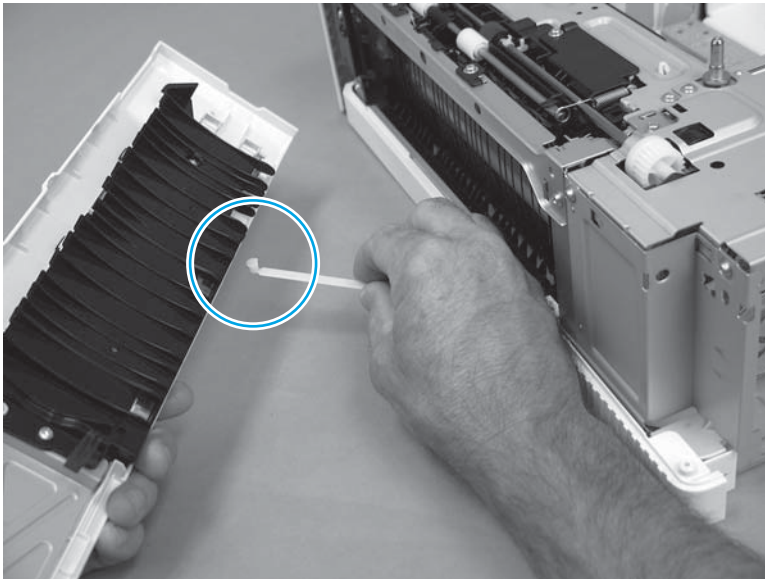

Step 3: Remove the right-lower cover

1. Before proceeding, take note of the location of the three mounting tabs on the back side of the cover.

Figure 1-5017 Cover mounting tabs

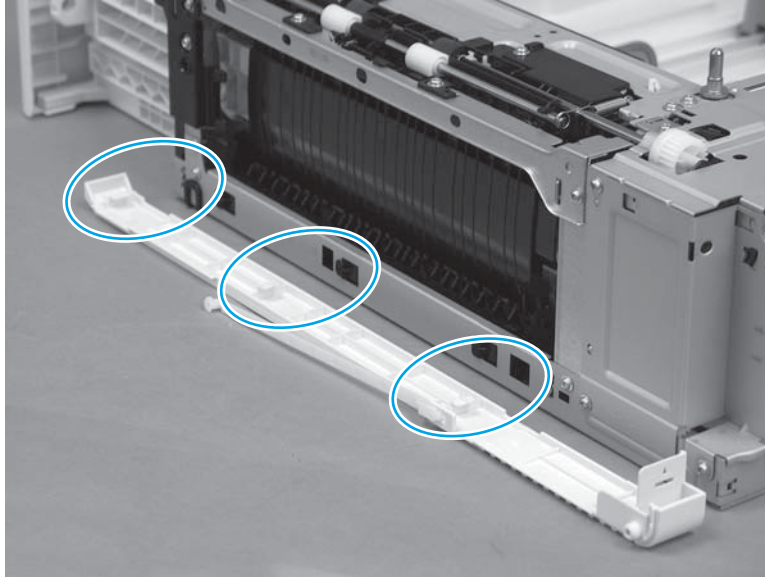

2. Partially open the tray, slightly flex the end of the cover away from the accessory (callout 1), and then slide it towards the front of the accessory (callout 2) to release it.

CAUTION: The three mounting tabs on the back side of the cover are easily damaged. Do not over flex the end of the cover when it is released. Push in on the middle tab to protect it when removing the cover.

Figure 1-5018 Release the cover

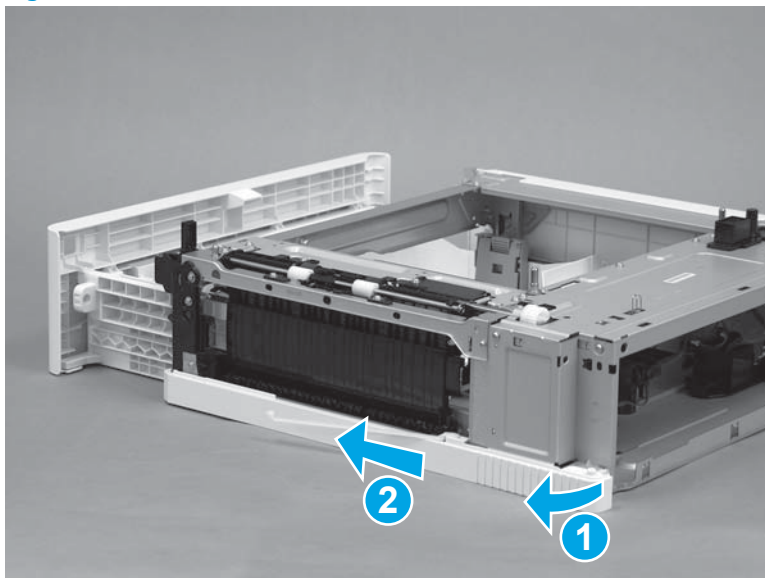

3. Remove the right-lower cover.

Figure 1-5019 Remove the right-lower cover

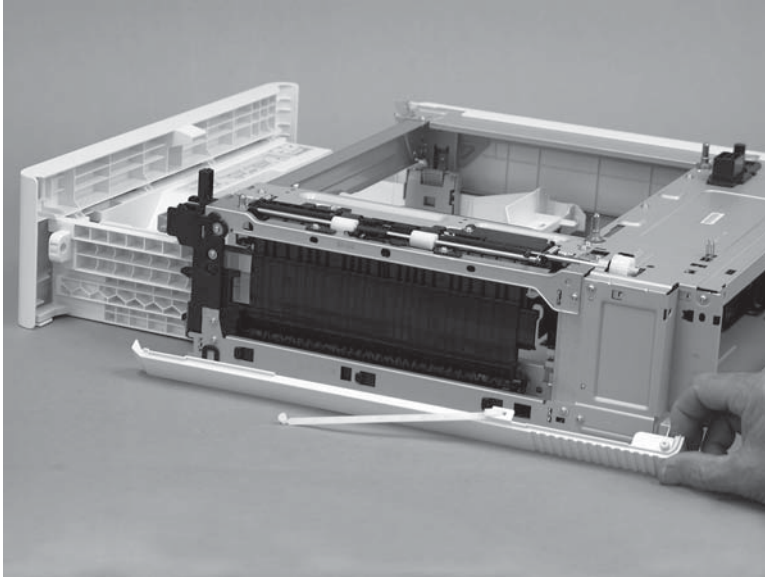

Step 4: Remove the right-door link

- ▲ Rotate the door link to align the keyed end of the link to pass through the keyed portion of the right-lower cover to remove it.

Figure 1-5020 Remove the right-door link

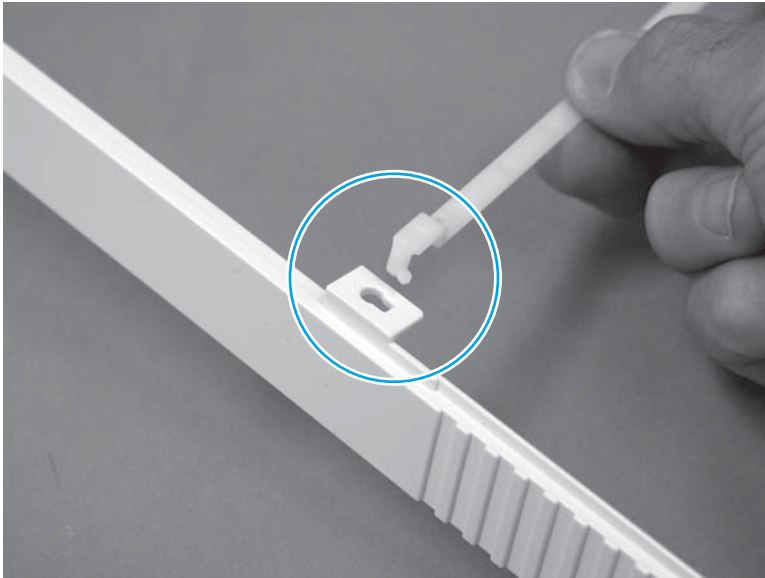

Step 5: Unpack the replacement assembly

Unpack the replacement assembly from the packaging.

For complete information on HP's recycling programs, go to [Product return and recycling](#).



NOTE: HP recommends responsible disposal of the defective assembly.

Figure 1-5021 Recycle and unpack

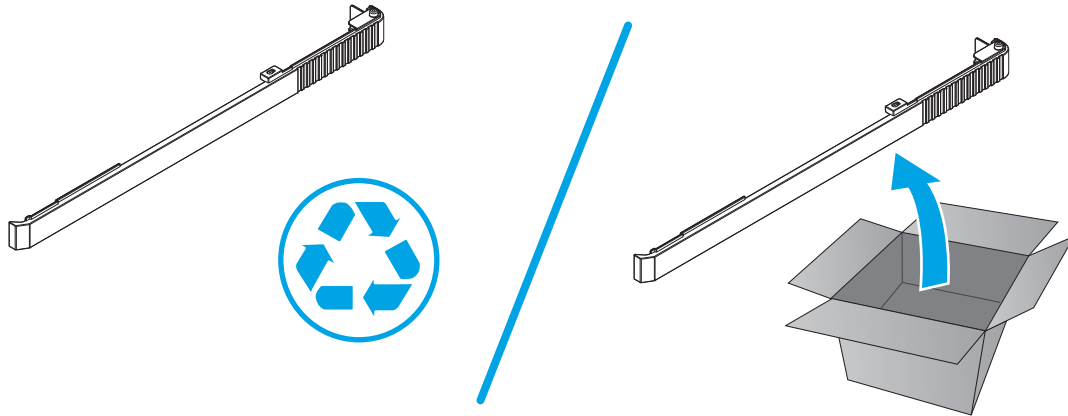

Step 6: Install the right-door link

- ▲ Rotate the door link to align the keyed end of the link to pass through the keyed portion of the right-lower cover to install it.

Figure 1-5022 Remove the right-door link

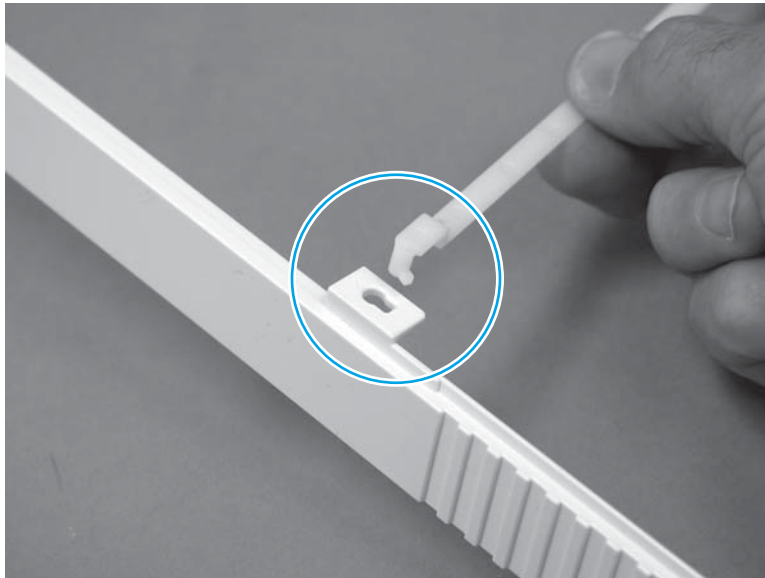

Step 7: Install the right-lower cover

1. Before proceeding, take note of the location of the three mounting tabs on the back side of the cover.

Figure 1-5023 Cover mounting tabs

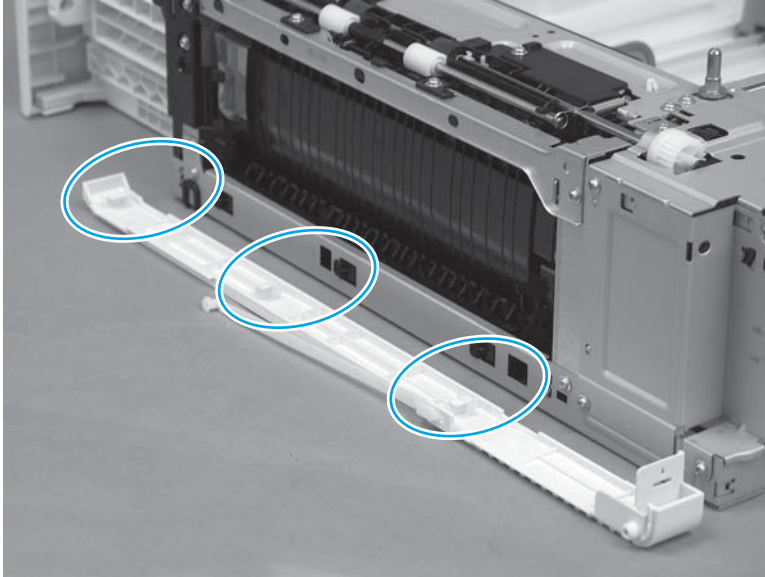

2. Align the three mounting tabs on the back side of the cover with the slots in the chassis.

Figure 1-5024 Install the right-lower cover

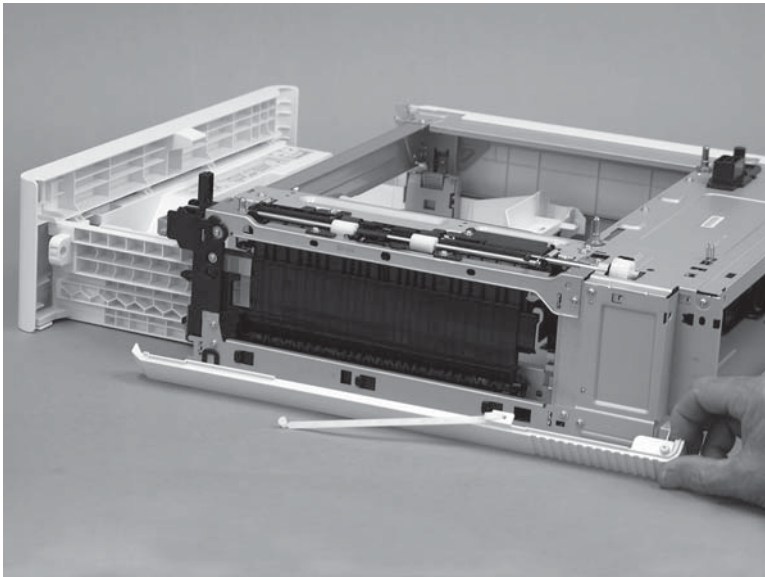

3. Press in on the middle tab (callout 1), slightly flex the end of the cover away from the accessory, and then slide it towards the rear of the accessory (callout 2) to engage the tabs with the slots.

CAUTION: The three mounting tabs on the back side of the cover are easily damaged. Do not over flex the end of the cover when it is installed.

Figure 1-5025 Engage the cover

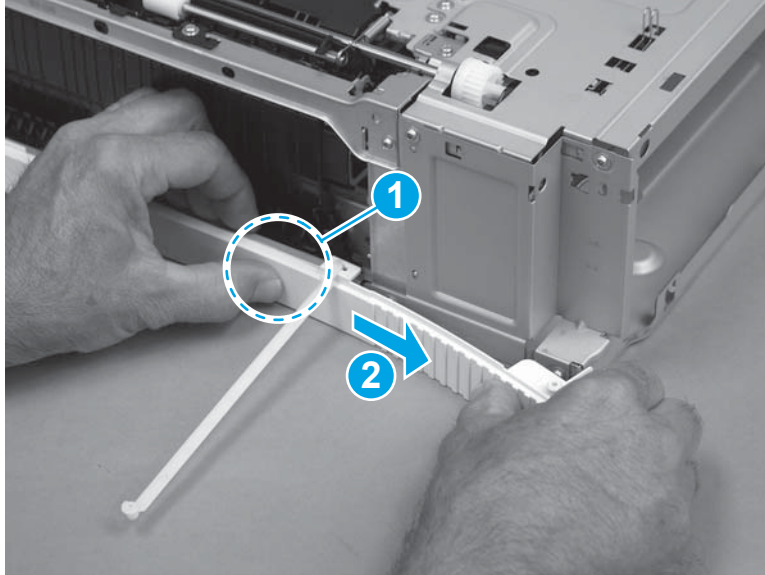

4. Verify that the end of the cover near the tray is correctly engaged with the chassis after installing the cover.

Figure 1-5026 Check the cover

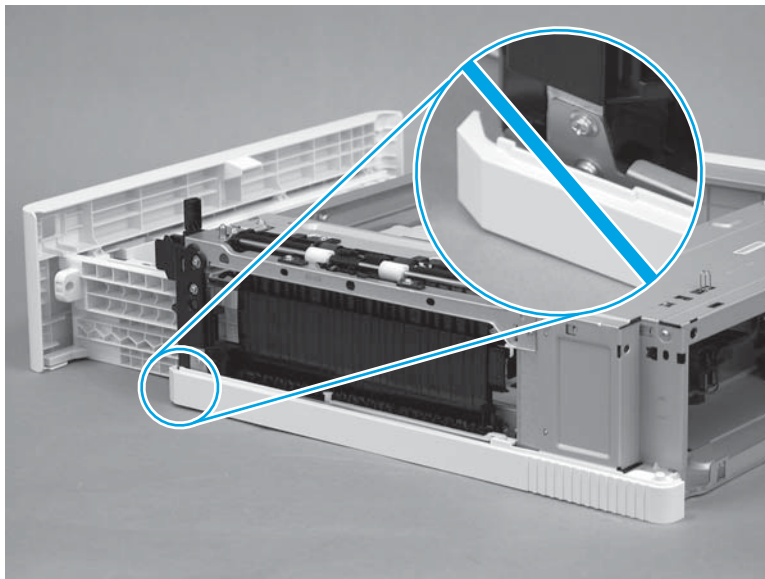

Step 8: Install the right door

1. Install the door link in the slot in the door to attach the door.

Figure 1-5027 Install the door link

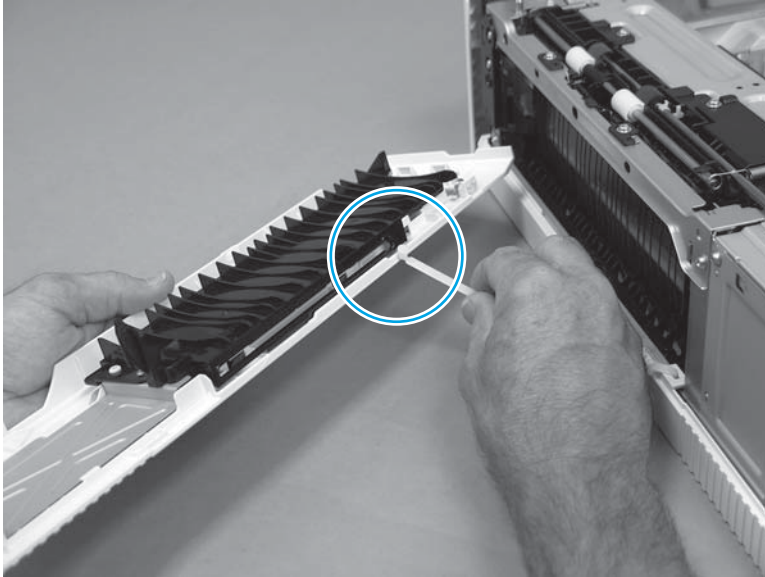

2. Position the lower hinge hole on the door (callout 2) on the lower hinge pin (callout 2) on the right-lower cover.

Figure 1-5028 Position the door on the lower hinge

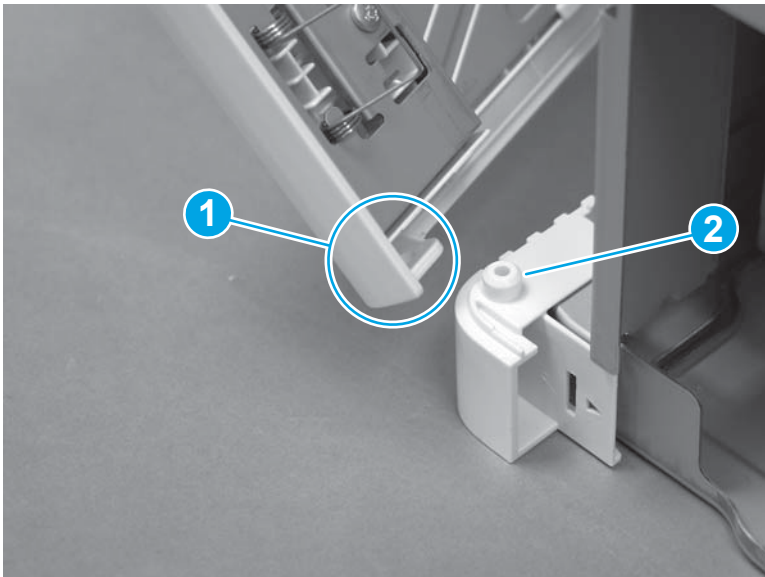

3. Align the pin of the door-hinge bracket (callout 1) with the hole in the chassis, and then align the mounting tabs (callout 2 and callout 3) with the slots in the chassis.

Figure 1-5029 Engage the hinge bracket

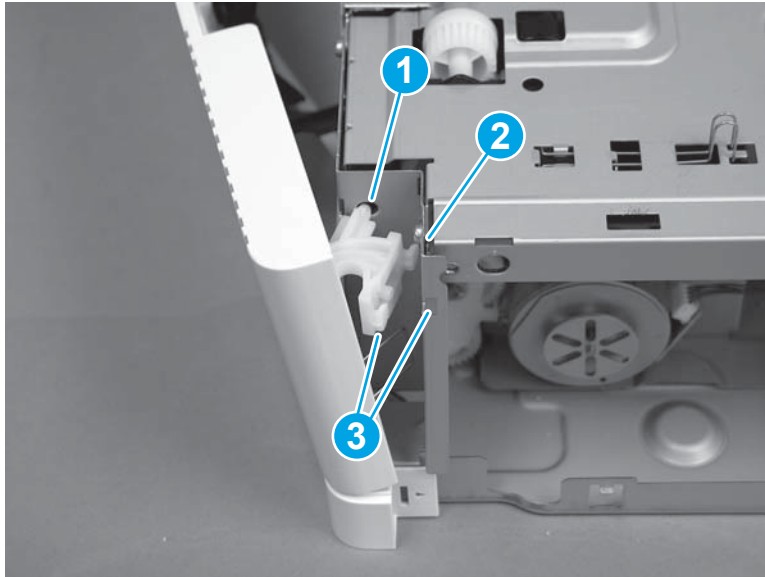

4. Push in on the door-hinge bracket (callout 1), and then slide it toward the chassis (callout 2) to install it.

Figure 1-5030 Install the hinge bracket

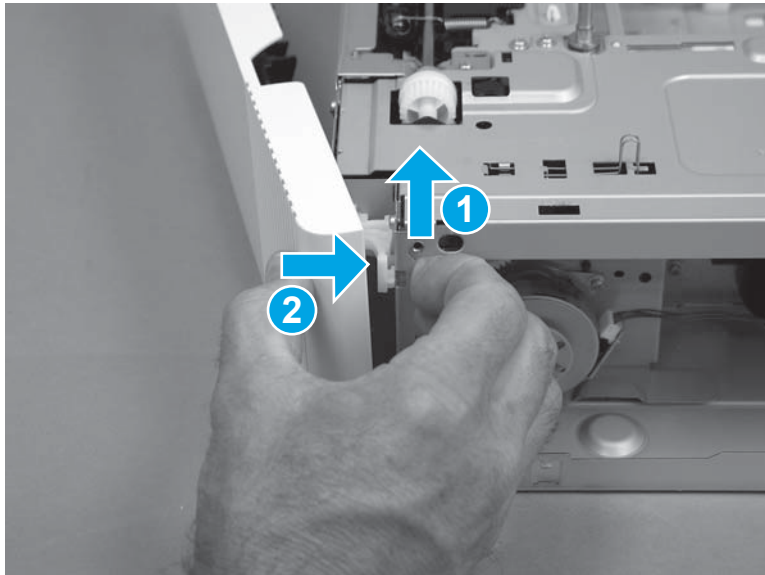

5. Close the door.

Figure 1-5031 Close the door

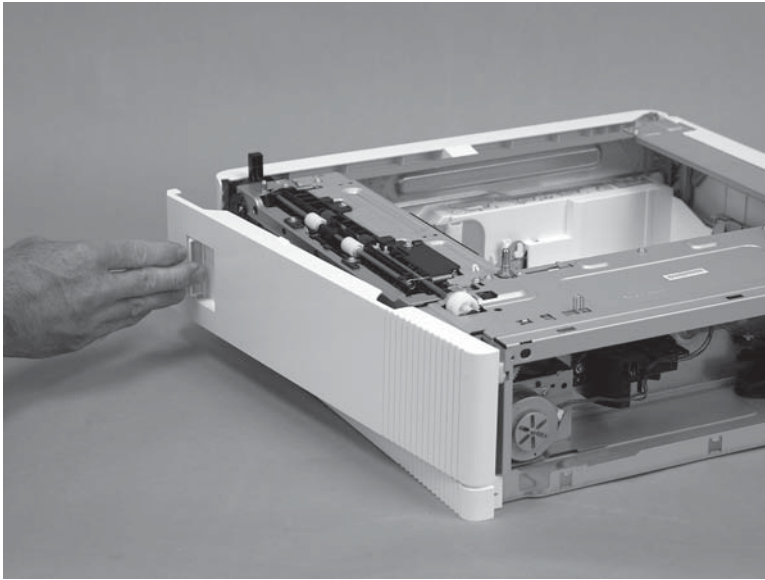

Step 9: Install the rear cover

1. Align the three mounting tabs (callout 1) on the cover with the slots in the chassis.

Figure 1-5032 Position the cover on the chassis

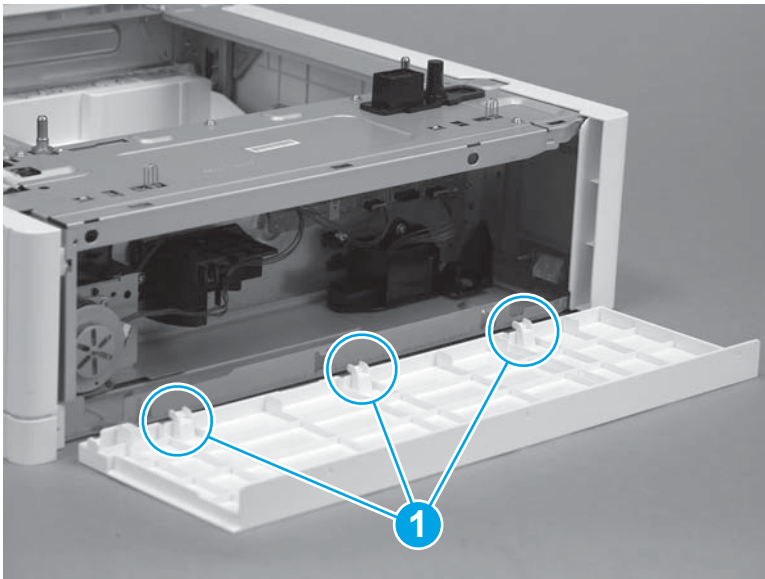

2. Position the cover on the accessory (callout 1), and then rotate the top of the cover up and onto the chassis (callout 2) to install it.

Figure 1-5033 Install the cover

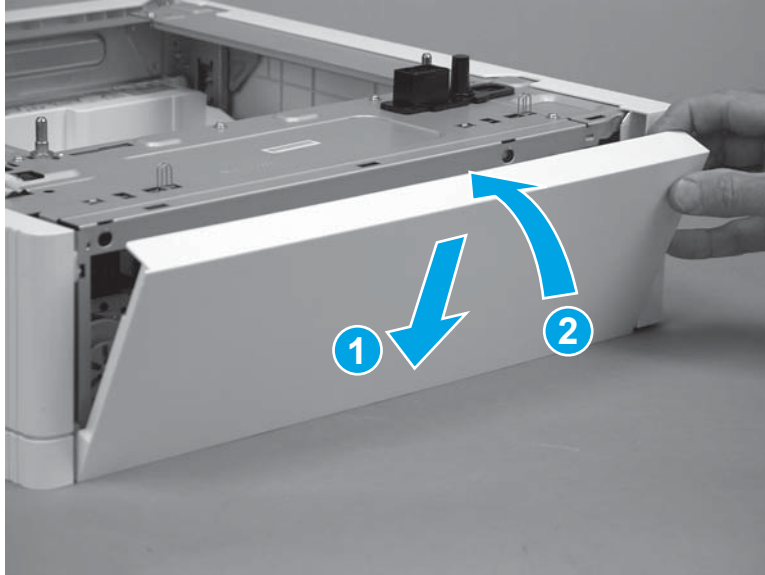

3. Make sure that the three tabs (callout 1) snap into place.

Figure 1-5034 Check the three tabs

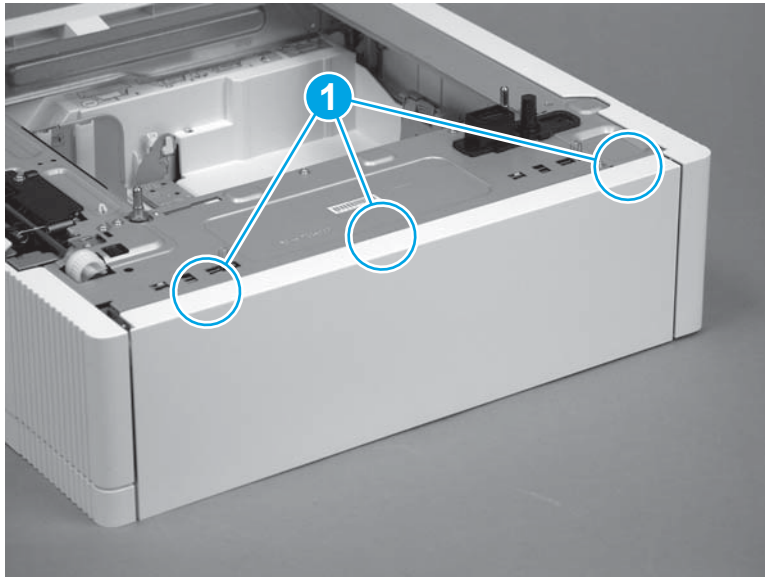

Removal and replacement: Right-door link (1x550-sheet paper feeder)

- [Introduction](#)
- [Step 1: Remove the rear cover](#)
- [Step 2: Remove the right door](#)
- [Step 3: Remove the right-lower cover](#)
- [Step 4: Remove the right-door link](#)
- [Step 5: Unpack the replacement assembly](#)
- [Step 6: Install the right-door link](#)
- [Step 7: Install the right-lower cover](#)
- [Step 8: Install the right door](#)
- [Step 9: Install the rear cover](#)

Introduction

This document provides the procedures to remove and replace the 1x550-sheet right-door link.

Before performing service

Use the table below to identify the correct part number for your printer, and then go to <http://h20141.www2.hp.com/hpparts> to order the part.

Right-door link (1x550-sheet paper feeder) part number	
RC4-1778-000CN	Right-door link (1x550-sheet paper feeder)

Required tools

No special tools are required to install this part.

After performing service

Make sure that the rear cover is flush against the chassis after replacing it.

Make sure that the right door latches correctly when closed after replacing it.

Step 1: Remove the rear cover

1. Release three tabs (callout 1).

Figure 1-5035 Release three tabs

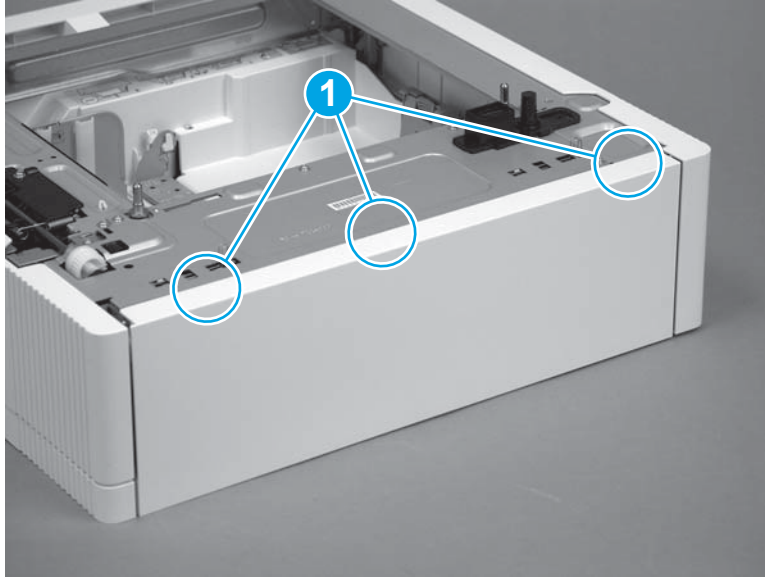

2. Rotate the top of the cover away from the accessory (callout 1), and then lift it up to remove it (callout 2).

Figure 1-5036 Remove the cover

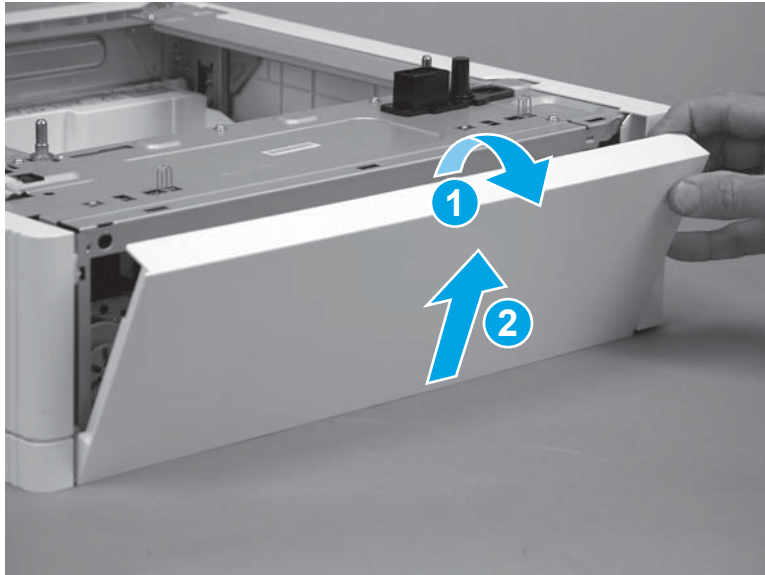

Step 2: Remove the right door

1. Open the door.

Figure 1-5037 Open the door

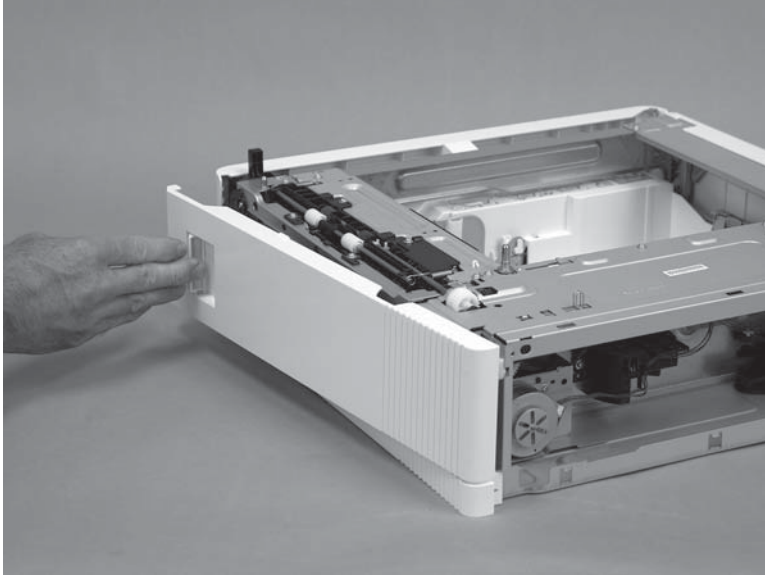

2. Release one tab (callout 1), and then slide the door-hinge bracket away from the chassis (callout 2) to release it.

Figure 1-5038 Release the hinge bracket

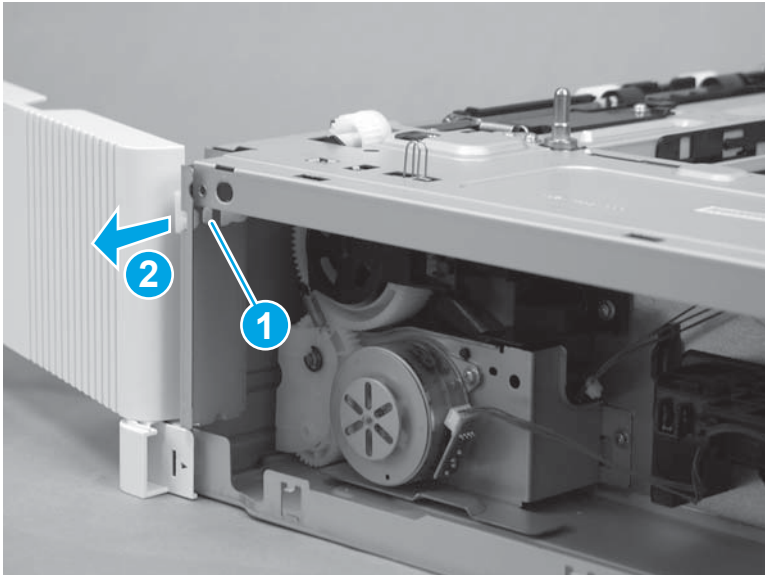

3. Remove the door-hinge bracket from the chassis.

CAUTION: The door is still attached to the accessory by the door link. Do not attempt to completely remove the door.

The door hinge bracket is not captive. Do not lose it when handling the door.

Figure 1-5039 Remove the hinge bracket

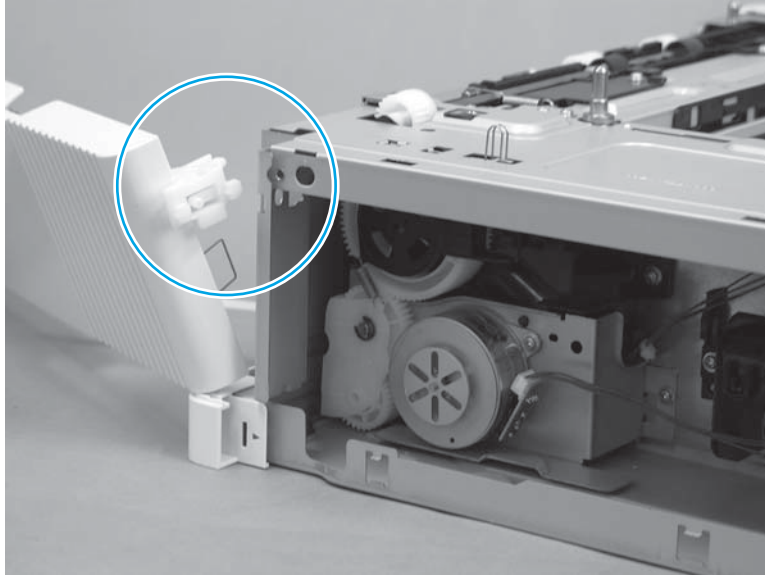

4. Release the door link from the slot in the door to remove the right door.

Figure 1-5040 Release the door link

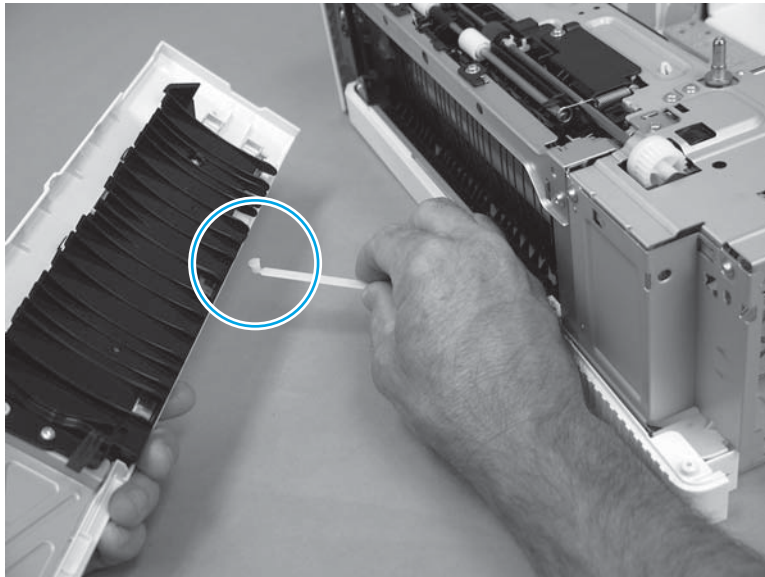

Step 3: Remove the right-lower cover

1. Before proceeding, take note of the location of the three mounting tabs on the back side of the cover.

Figure 1-5041 Cover mounting tabs

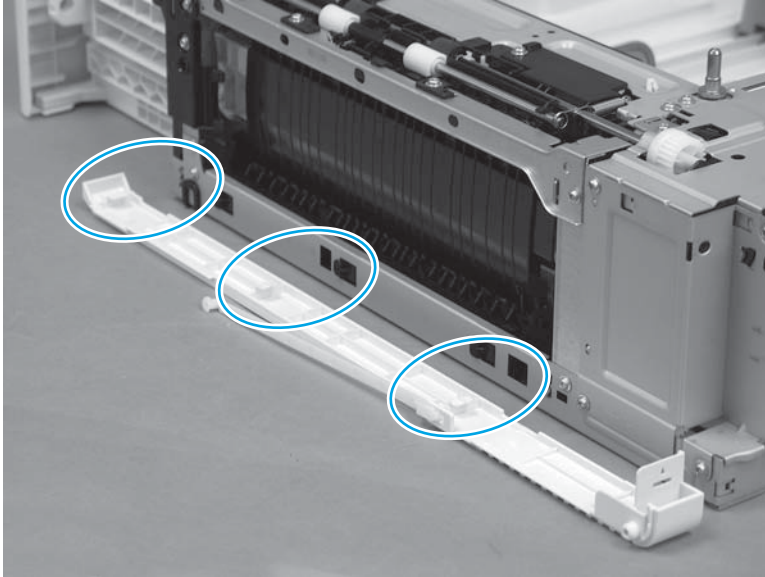

2. Partially open the tray, slightly flex the end of the cover away from the accessory (callout 1), and then slide it towards the front of the accessory (callout 2) to release it.

⚠ CAUTION: The three mounting tabs on the back side of the cover are easily damaged. Do not over flex the end of the cover when it is released. Push in on the middle tab to protect it when removing the cover.

Figure 1-5042 Release the cover

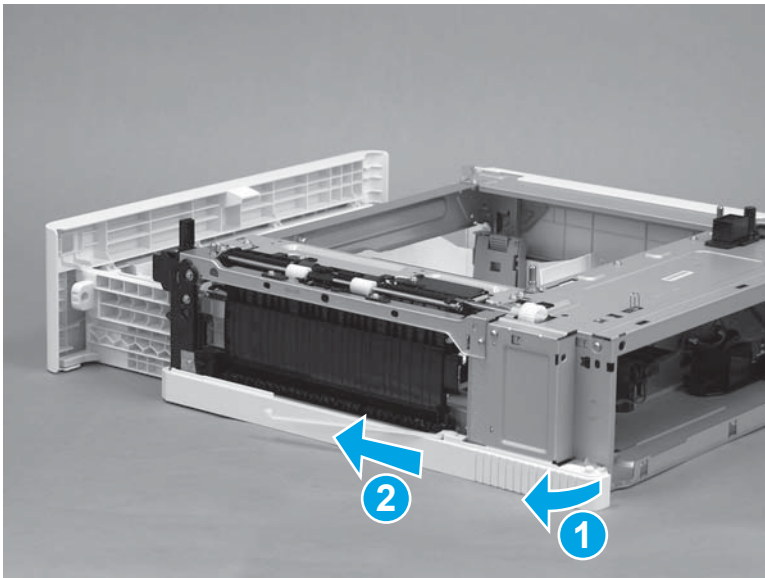

3. Remove the right-lower cover.

Figure 1-5043 Remove the right-lower cover

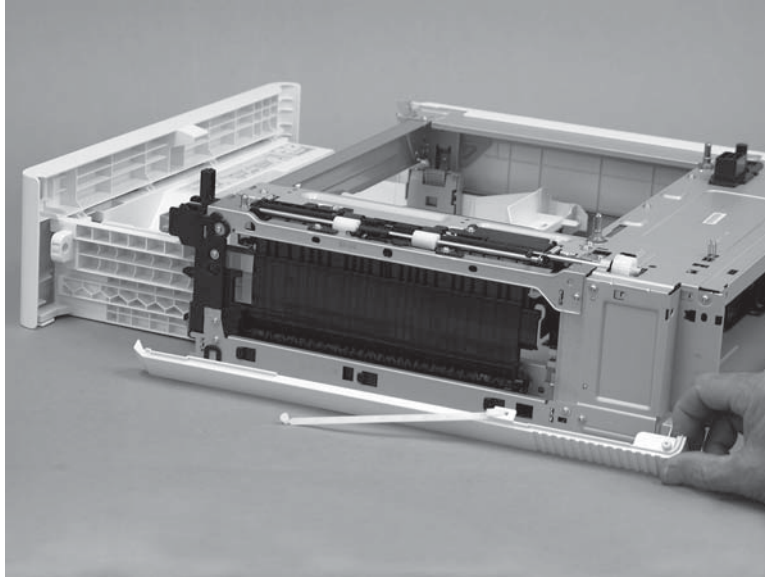

Step 4: Remove the right-door link

- ▲ Rotate the door link to align the keyed end of the link to pass through the keyed portion of the right-lower cover to remove it.

Figure 1-5044 Remove the right-door link

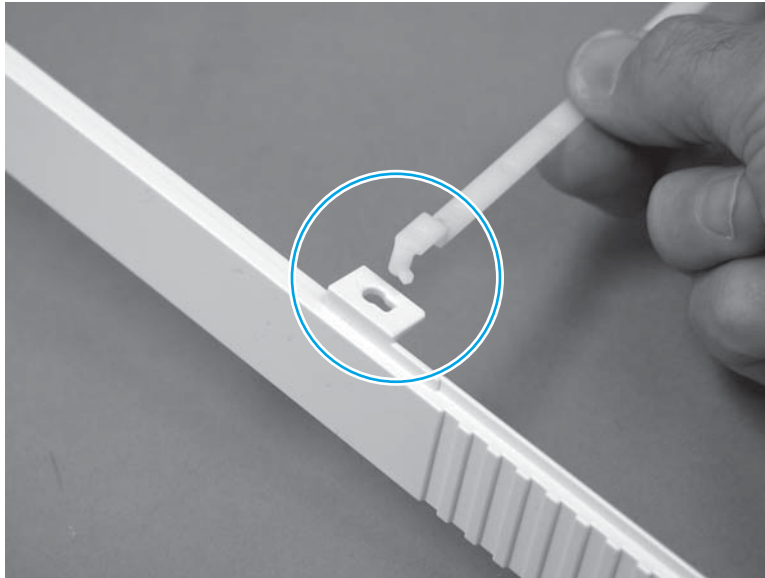

Step 5: Unpack the replacement assembly

Unpack the replacement assembly from the packaging.

For complete information on HP's recycling programs, go to [Product return and recycling](#).

 **NOTE:** HP recommends responsible disposal of the defective assembly.

Figure 1-5045 Recycle and unpack

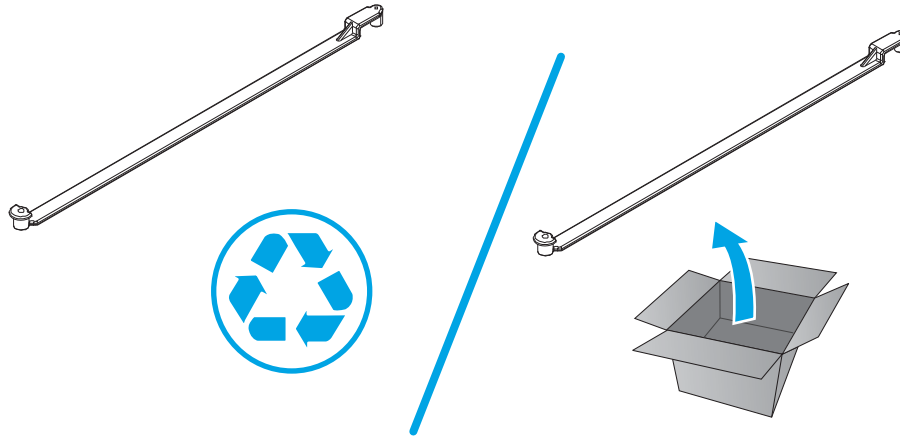

Step 6: Install the right-door link

- ▲ Rotate the door link to align the keyed end of the link to pass through the keyed portion of the right-lower cover to install it.

Figure 1-5046 Remove the right-door link

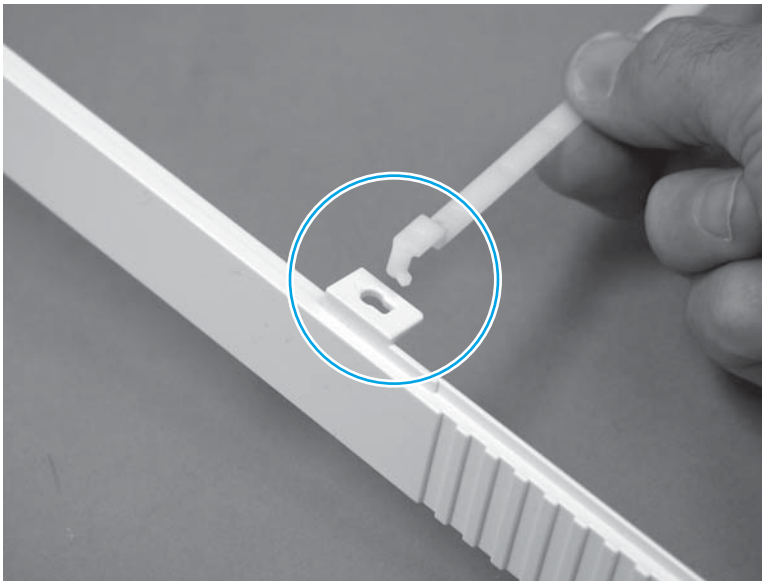

Step 7: Install the right-lower cover

1. Before proceeding, take note of the location of the three mounting tabs on the back side of the cover.

Figure 1-5047 Cover mounting tabs

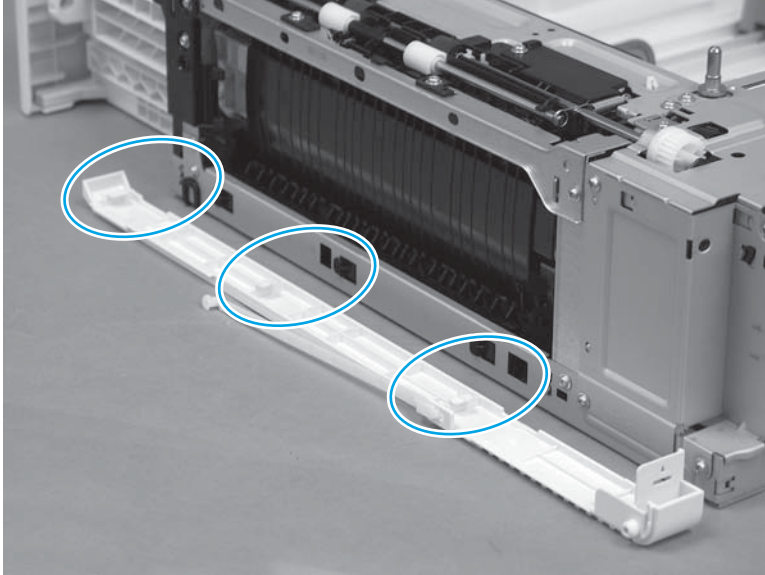

2. Align the three mounting tabs on the back side of the cover with the slots in the chassis.

Figure 1-5048 Install the right-lower cover

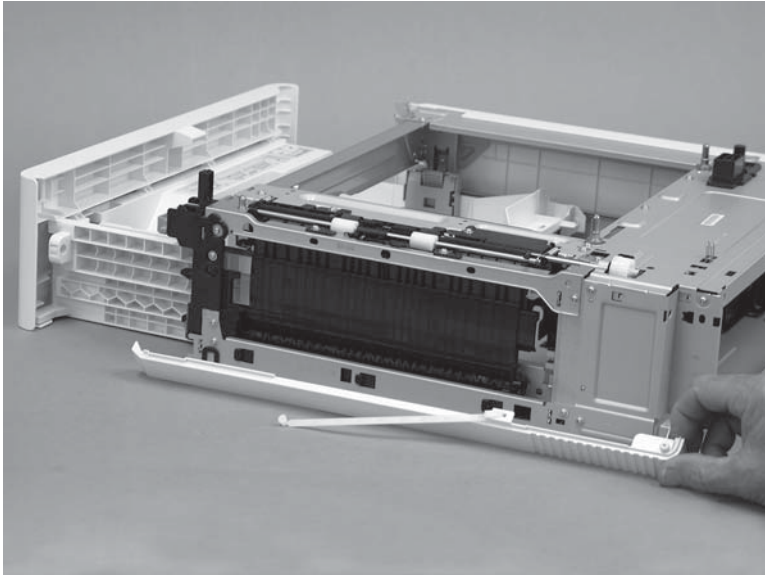

3. Press in on the middle tab (callout 1), slightly flex the end of the cover away from the accessory, and then slide it towards the rear of the accessory (callout 2) to engage the tabs with the slots.

⚠ CAUTION: The three mounting tabs on the back side of the cover are easily damaged. Do not over flex the end of the cover when it is installed.

Figure 1-5049 Engage the cover

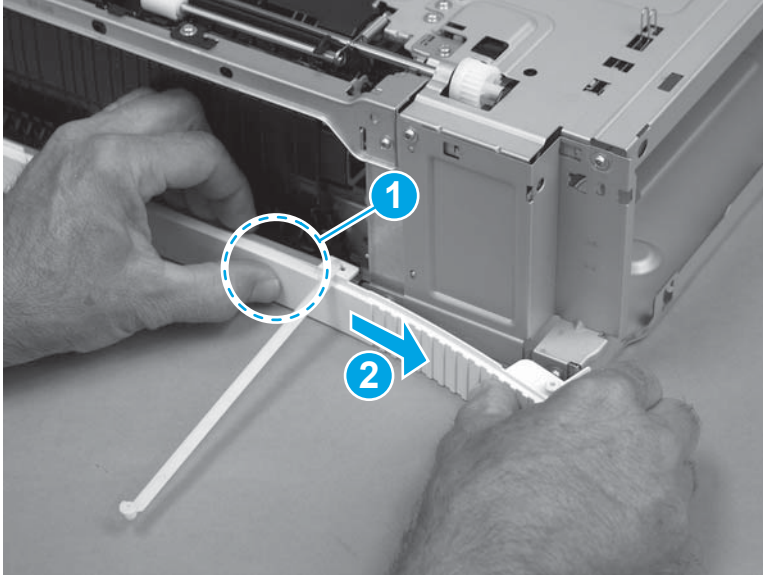

4. Verify that the end of the cover near the tray is correctly engaged with the chassis after installing the cover.

Figure 1-5050 Check the cover

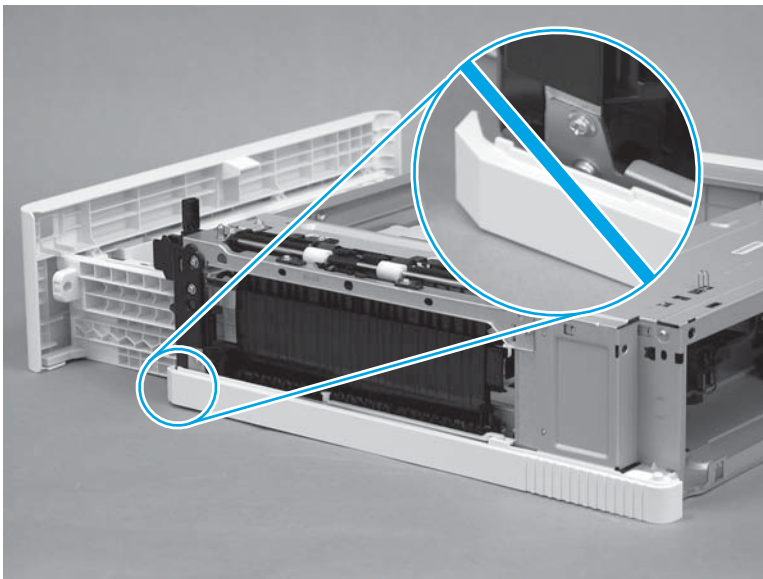

Step 8: Install the right door

1. Install the door link in the slot in the door to attach the door.

Figure 1-5051 Install the door link

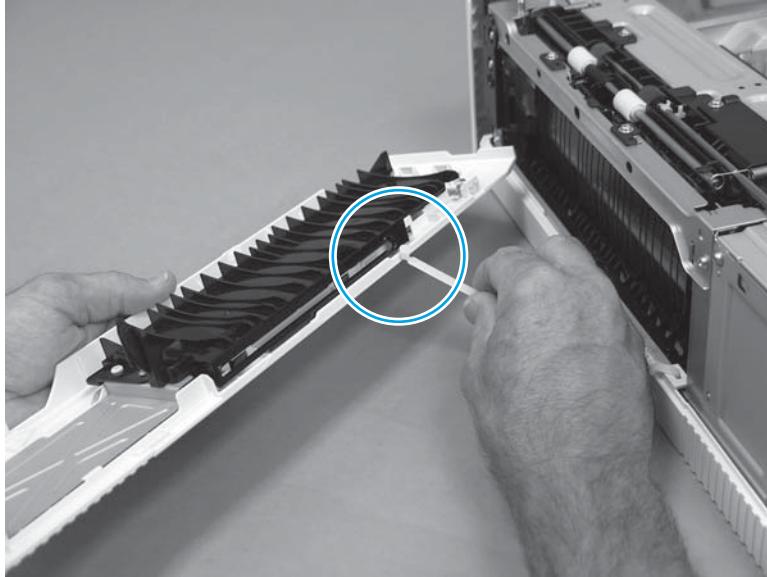

2. Position the lower hinge hole on the door (callout 2) on the lower hinge pin (callout 2) on the right-lower cover.

Figure 1-5052 Position the door on the lower hinge

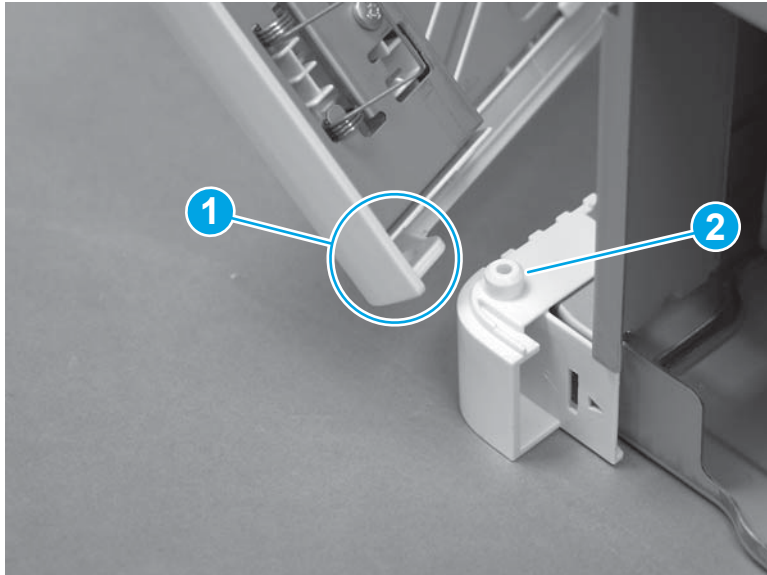

3. Align the pin of the door-hinge bracket (callout 1) with the hole in the chassis, and then align the mounting tabs (callout 2 and callout 3) with the slots in the chassis.

Figure 1-5053 Engage the hinge bracket

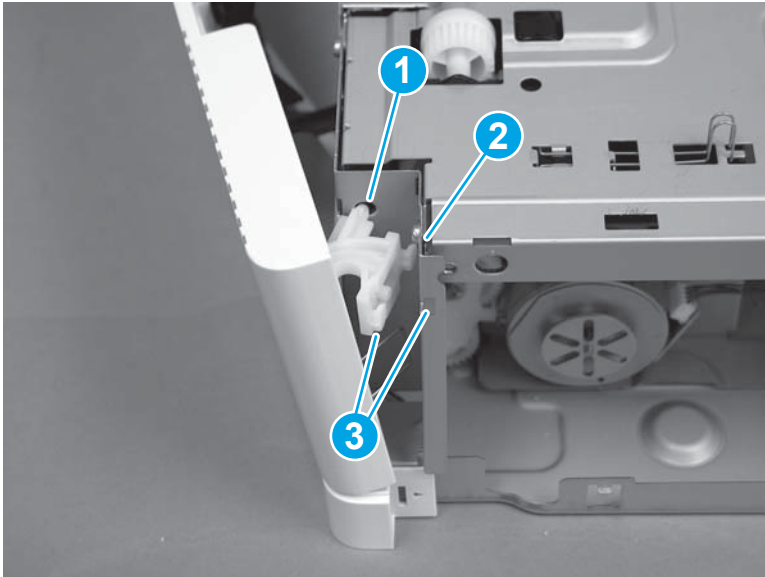

4. Push in on the door-hinge bracket (callout 1), and then slide it toward the chassis (callout 2) to install it.

Figure 1-5054 Install the hinge bracket

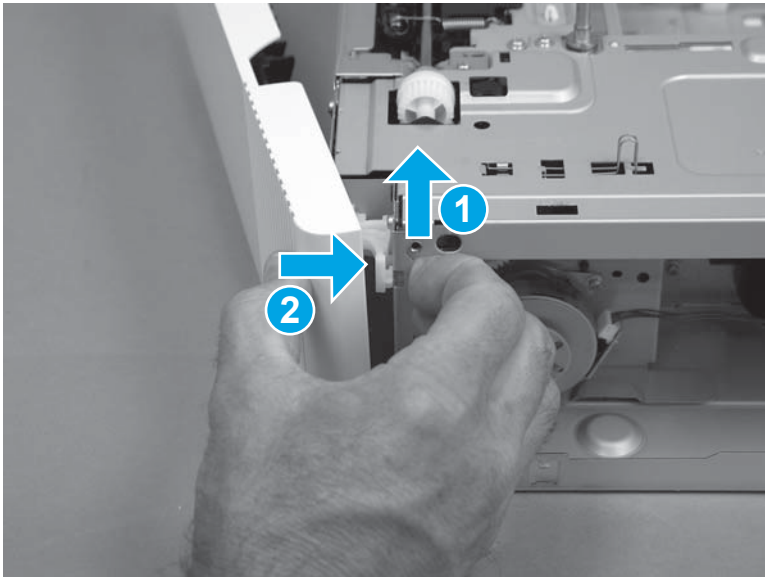

5. Close the door.

Figure 1-5055 Close the door

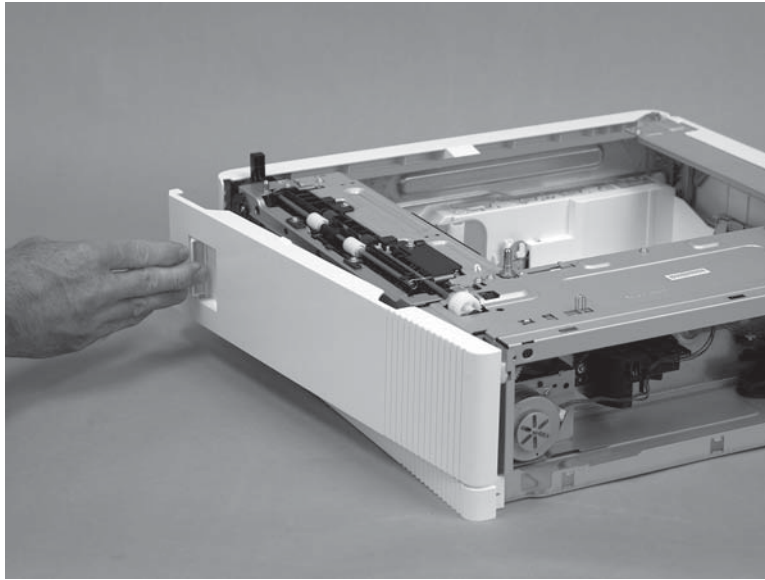

Step 9: Install the rear cover

1. Align the three mounting tabs (callout 1) on the cover with the slots in the chassis.

Figure 1-5056 Position the cover on the chassis

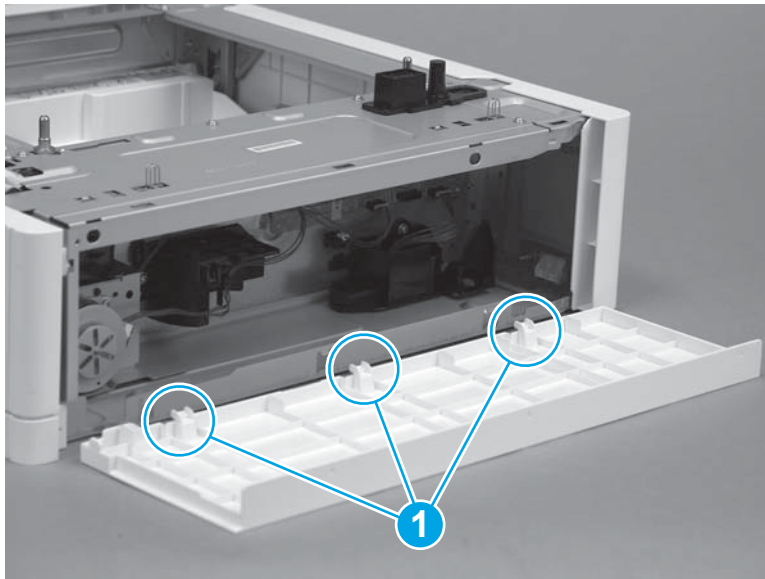

2. Position the cover on the accessory (callout 1), and then rotate the top of the cover up and onto the chassis (callout 2) to install it.

Figure 1-5057 Install the cover

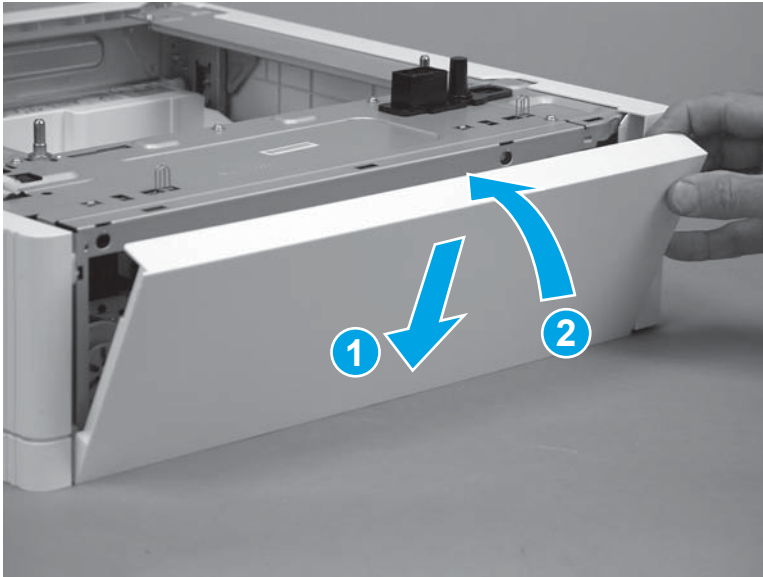

3. Make sure that the three tabs (callout 1) snap into place.

Figure 1-5058 Check the three tabs

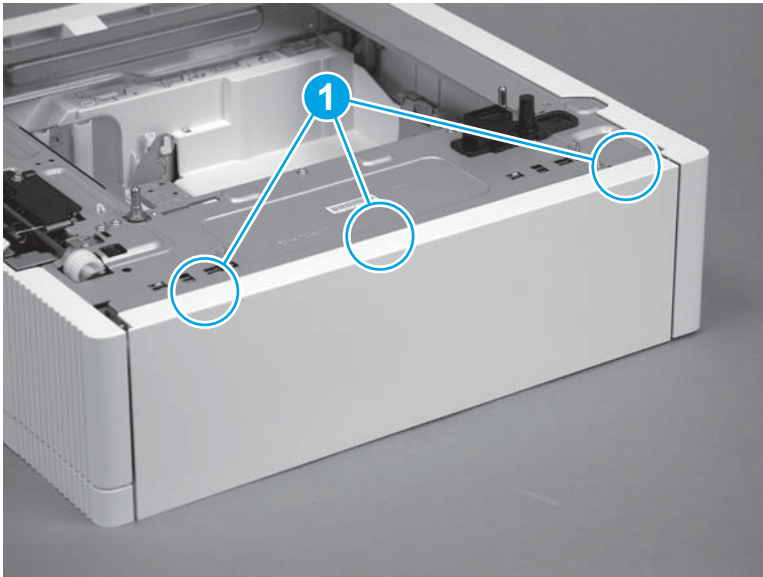

Removal and replacement: Left cover (1x550-sheet paper feeder)

- [Introduction](#)
- [Step 1: Remove the left cover](#)
- [Step 2: Unpack the replacement assembly](#)
- [Step 3: Install the left cover](#)

Introduction

This document provides the procedures to remove and replace the 1x550-sheet paper feeder left cover.

Before performing service

Use the table below to identify the correct part number for your printer, and then go to <http://h20141.www2.hp.com/hpparts> to order the part.

Left cover (1x550-sheet paper feeder) part number	
RC4-1791-000CN	Left cover (1x550-sheet paper feeder)

Required tools

No special tools are required to install this part.

After performing service

Make sure that the left cover is flush against the chassis after replacing it.

Step 1: Remove the left cover

1. Partially pull the tray out of the accessory, and then release three tabs (callout 1).

Figure 1-5059 Release three tabs

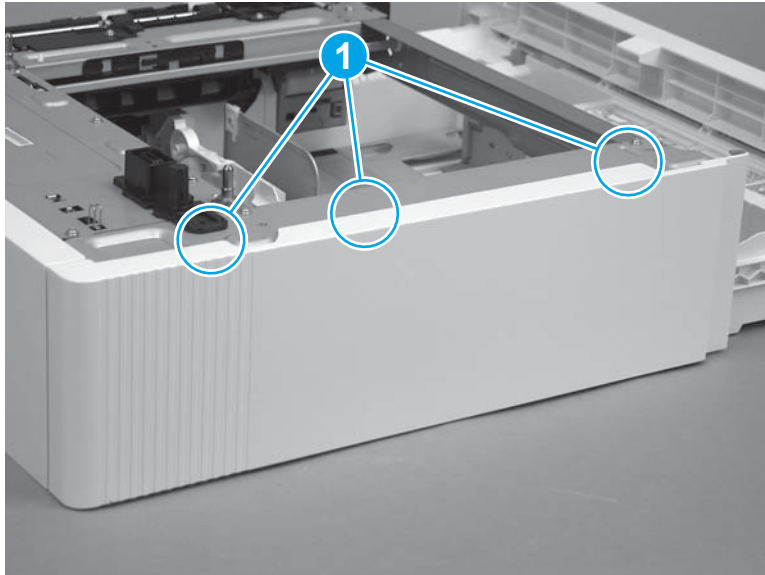

2. Rotate the top of the cover away from the accessory (callout 1), and then lift up the cover to remove it (callout 2).

Figure 1-5060 Remove the cover

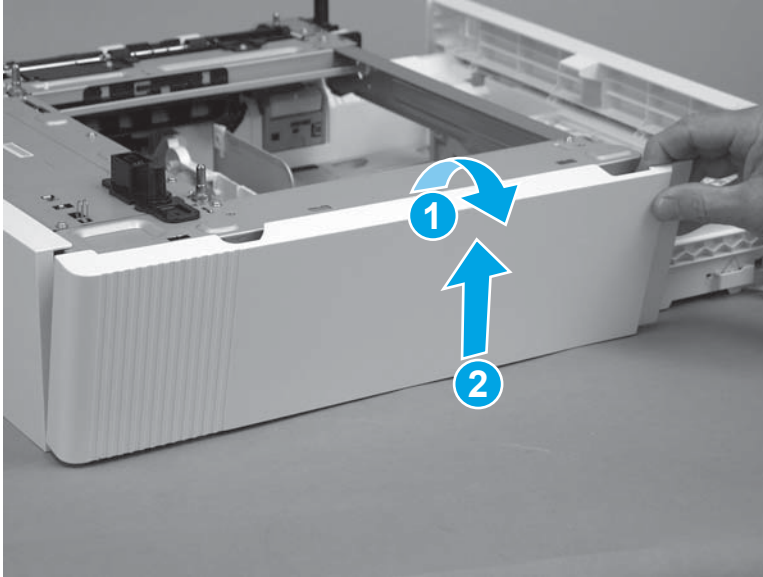

Step 2: Unpack the replacement assembly

Unpack the replacement assembly from the packaging.

For complete information on HP's recycling programs, go to [Product return and recycling](#).



NOTE: HP recommends responsible disposal of the defective assembly.

Figure 1-5061 Recycle and unpack

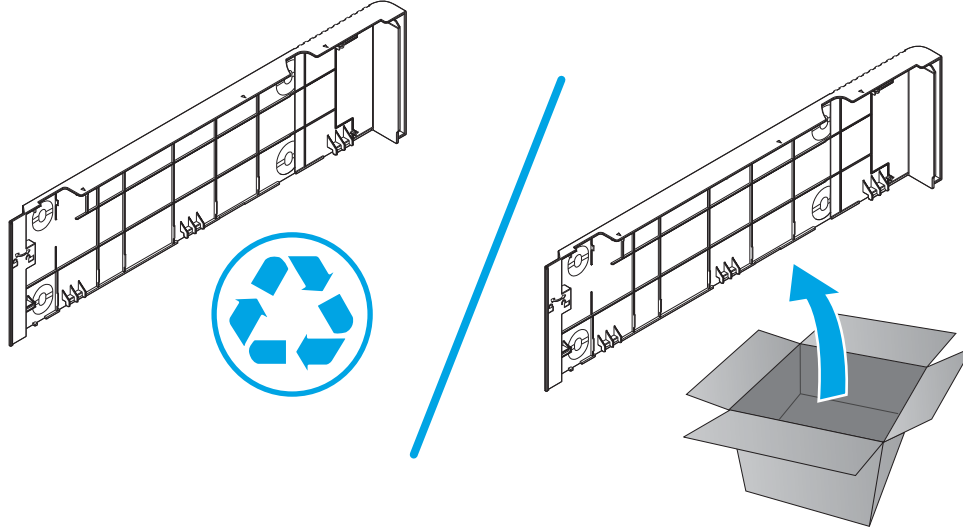

Step 3: Install the left cover

1. Align the three mounting tabs (callout 1) on the cover with the slots in the chassis.

Figure 1-5062 Position the cover on the chassis

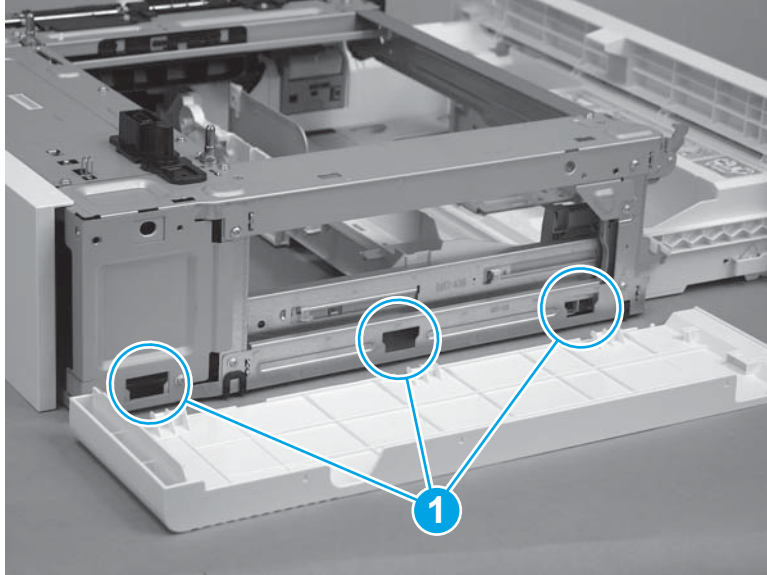

2. Place the bottom of the cover in position (callout 1), and then rotate the top of the cover up and onto the chassis (callout 2) to install it.

Figure 1-5063 Install the cover

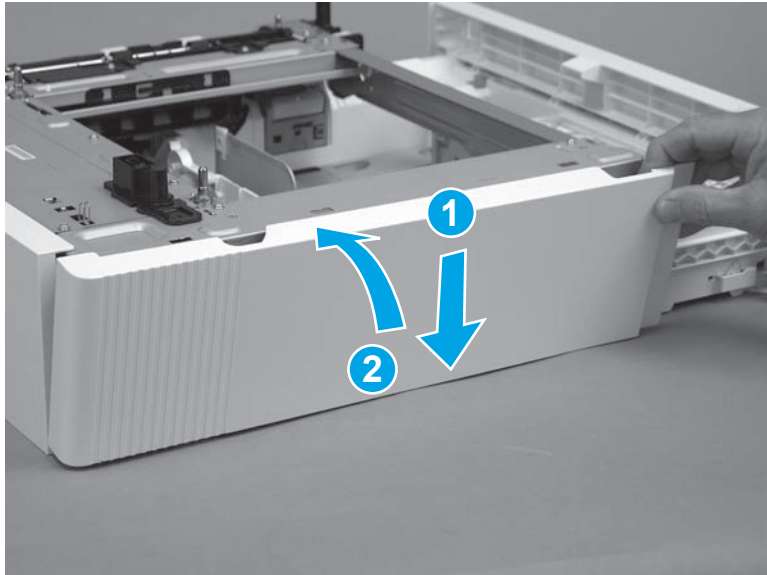

3. Make sure that the three tabs (callout 1) snap into place.

Figure 1-5064 Check the three tabs

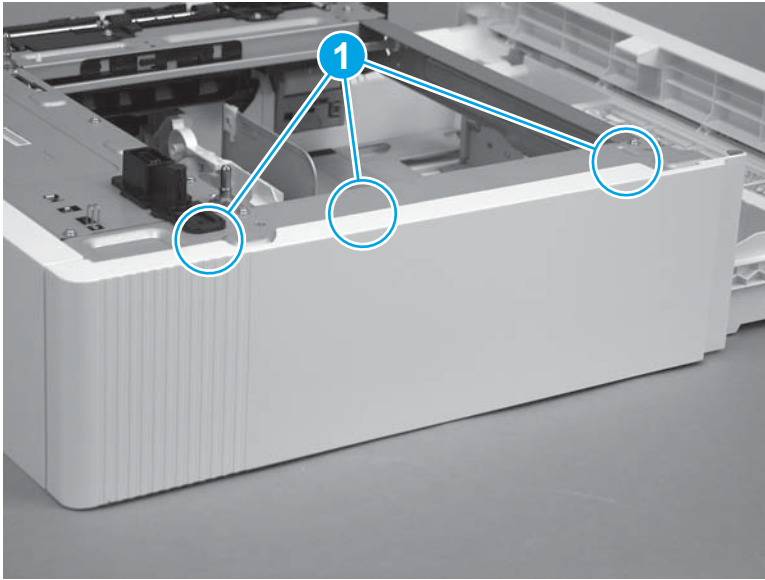

Removal and replacement: OP Drawer holder (1x550-sheet paper feeder)

- [Introduction](#)
- [Step 1: Remove the rear cover](#)
- [Step 2: Remove the OP drawer holder](#)
- [Step 3: Unpack the replacement assembly](#)
- [Step 4: Install the OP drawer holder](#)
- [Step 5: Install the rear cover](#)

Introduction

This document provides the procedures to remove and replace the 1x550-sheet paper feeder OP drawer holder.

Before performing service

Use the table below to identify the correct part number for your printer, and then go to <http://h20141.www2.hp.com/hpparts> to order the part.

OP drawer holder (1x550-sheet paper feeder) part number	
RC4-0445-000CN	OIP drawer holder (1x550-sheet paper feeder)

Required tools

- #2 Phillips screwdriver with a magnetic tip and a 152-mm (6-in) shaft length

After performing service

Make sure that the rear cover is flush against the chassis after replacing it.

Post service test

Print a page from a host computer using the appropriate tray as the source tray.

Step 1: Remove the rear cover

1. Release three tabs (callout 1).

Figure 1-5065 Release three tabs

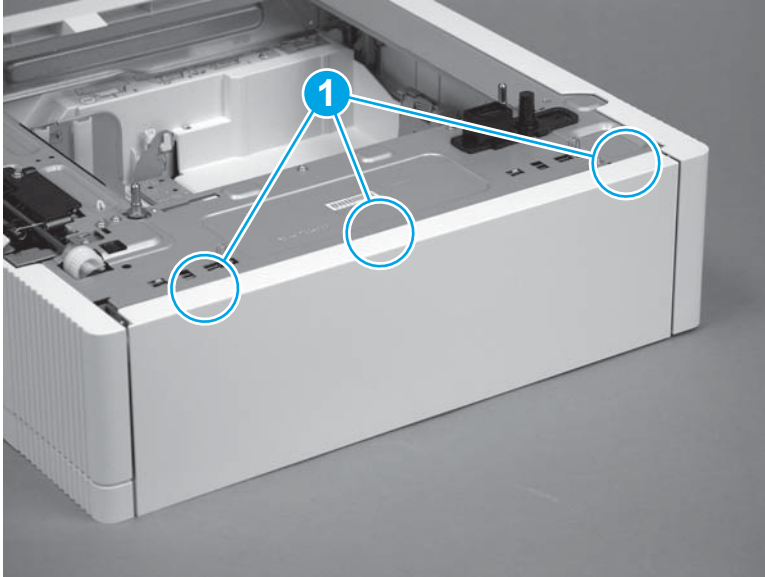

2. Rotate the top of the cover away from the accessory (callout 1), and then lift it up to remove it (callout 2).

Figure 1-5066 Remove the cover

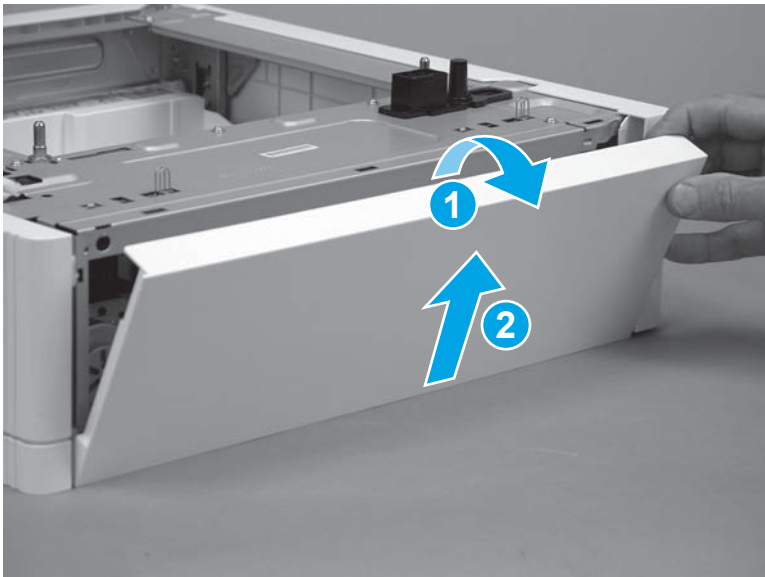

Step 2: Remove the OP drawer holder

1. Disconnect one connector (callout 1).

Figure 1-5067 Disconnect one connector

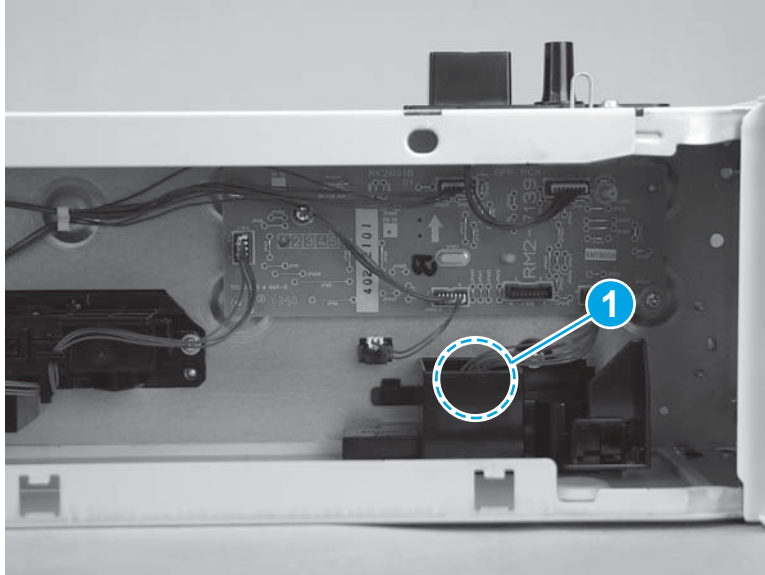

2. Remove one screw (callout 1), release one tab (callout 2), and then slide the OP drawer holder as shown (callout 3) to remove it.

Figure 1-5068 Remove the drawer holder

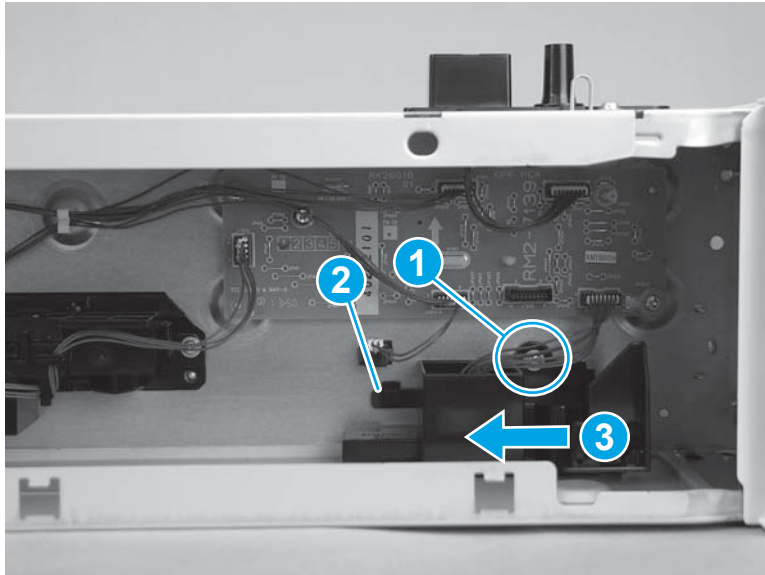

Step 3: Unpack the replacement assembly

Unpack the replacement assembly from the packaging.

For complete information on HP's recycling programs, go to [Product return and recycling](#).



NOTE: HP recommends responsible disposal of the defective assembly.

Figure 1-5069 Recycle and unpack

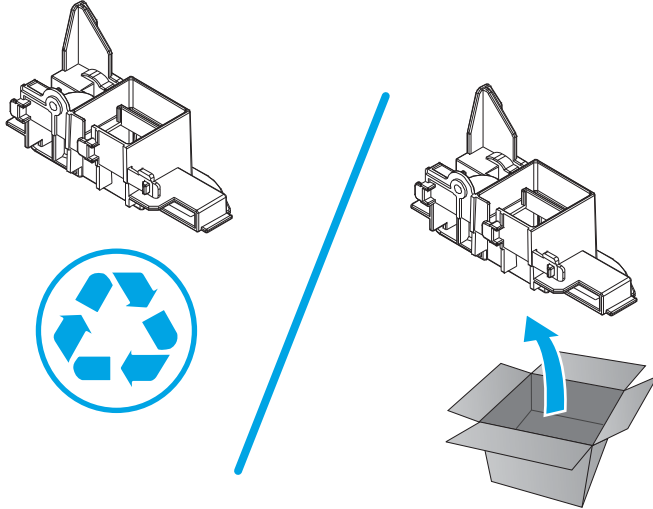

Step 4: Install the OP drawer holder

1. Position the OP drawer holder on the chassis and slide it as shown (callout 1) to install it, and then install one screw (callout 2). The tab (callout 3) on the holder fits into a slot in the chassis.

 **NOTE:** Remove the drawer connector from the holder, and install it in the replacement drawer holder.

Figure 1-5070 Install the drawer holder



2. Connect one connector (callout 1).

Figure 1-5071 Connect one connector

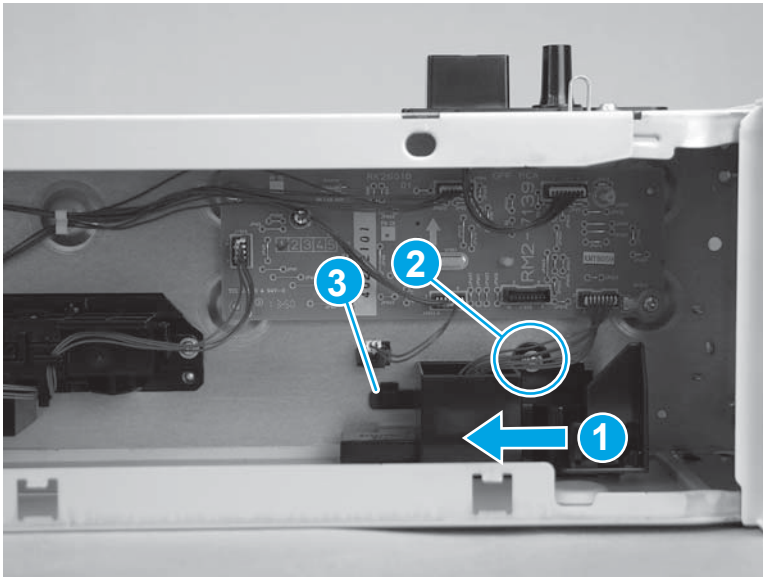
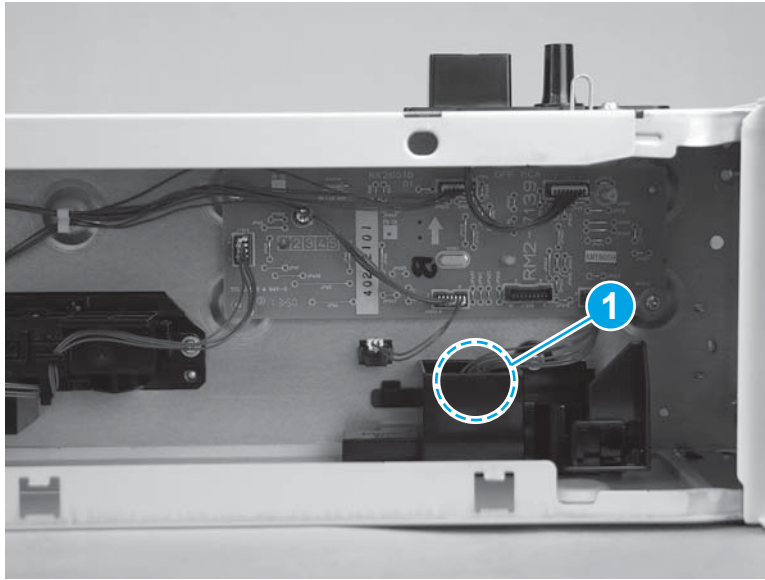

Step 5: Install the rear cover

1. Align the three mounting tabs (callout 1) on the cover with the slots in the chassis.

Figure 1-5072 Position the cover on the chassis

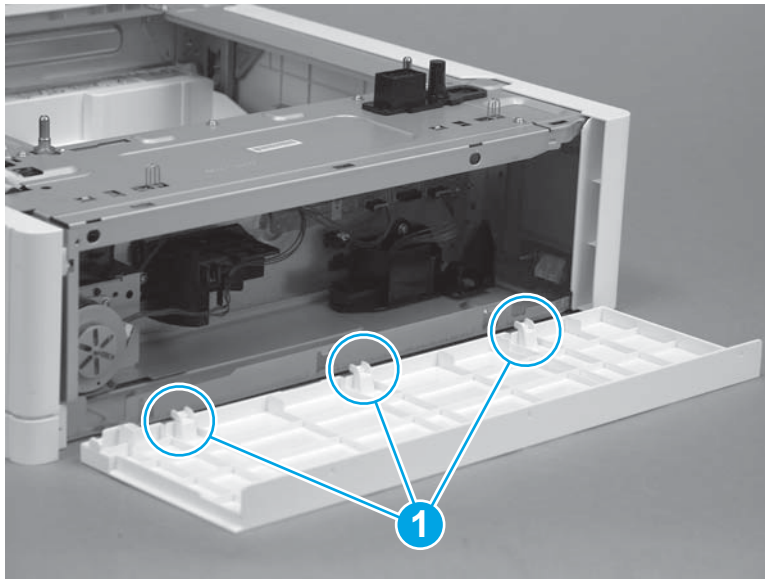

2. Position the cover on the accessory (callout 1), and then rotate the top of the cover up and onto the chassis (callout 2) to install it.

Figure 1-5073 Install the cover

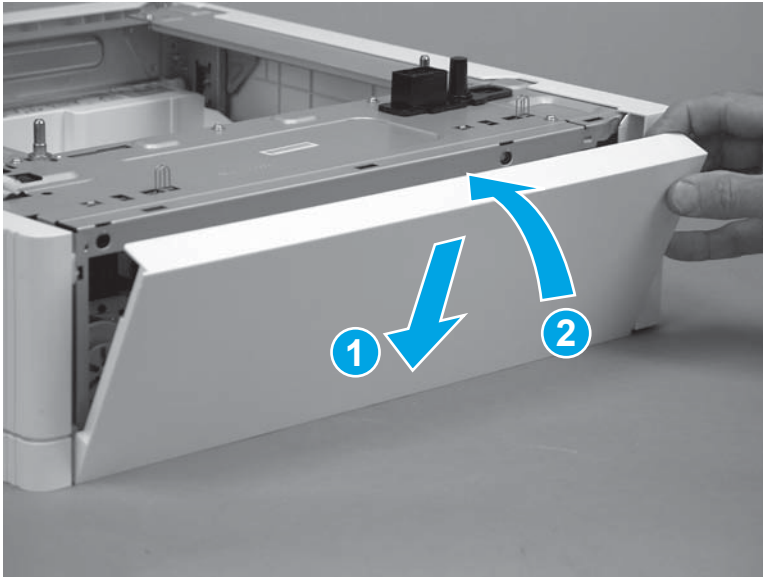

3. Make sure that the three tabs (callout 1) snap into place.

Figure 1-5074 Check the three tabs

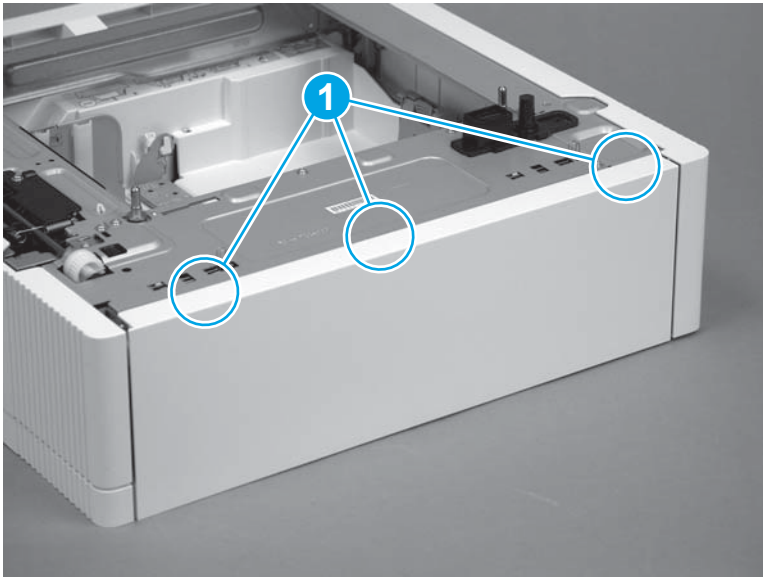

Removal and replacement: Auto close assembly (1x550-sheet paper feeder)

- [Introduction](#)
- [Step 1: Remove the tray](#)
- [Step 2: Remove the rear cover](#)
- [Step 3: Remove the auto close assembly](#)
- [Step 4: Unpack the replacement assembly](#)
- [Step 5: Install the auto close assembly](#)
- [Step 6: Install the rear cover](#)
- [Step 7: Install the tray](#)

Introduction

This document provides the procedures to remove and replace the 1x550-sheet paper feeder auto close assembly.

Before performing service

Use the table below to identify the correct part number for your printer, and then go to <http://h20141.www2.hp.com/hpparts> to order the part.

Right door hinge (1x550-sheet paper feeder) part number	
RM2-5147-000CN	Auto close assembly (1x550-sheet paper feeder)

Required tools

- #2 Phillips screwdriver with a magnetic tip

After performing service

Make sure that the rear cover is flush against the chassis after replacing it.

Make sure that the right door latches correctly when closed after replacing it.

Make sure that Tray 3 is fully closed after replacing it.

Post service test

Print a page from a host computer using the appropriate tray as the source tray.

Step 1: Remove the tray

1. Pull the tray out until it stops.

Figure 1-5075 Pull the tray out

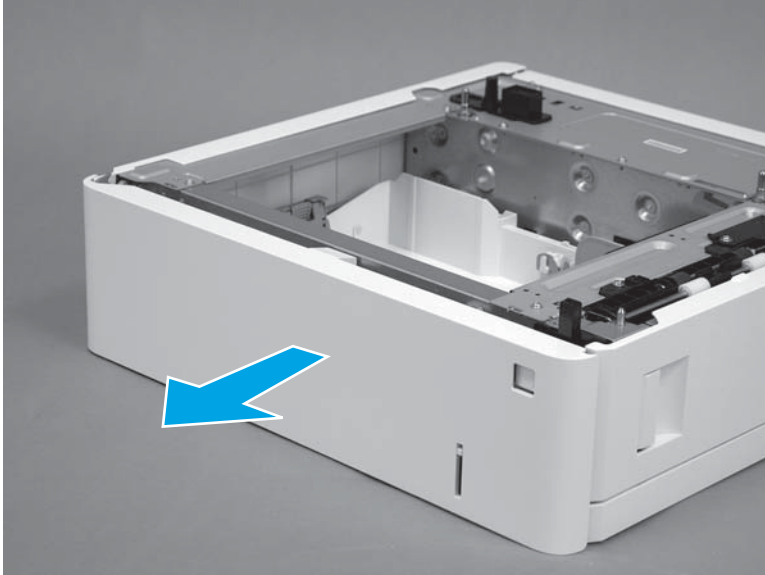

2. Lift the front of the tray, and then pull it out of the printer to remove it.

Figure 1-5076 Remove the tray

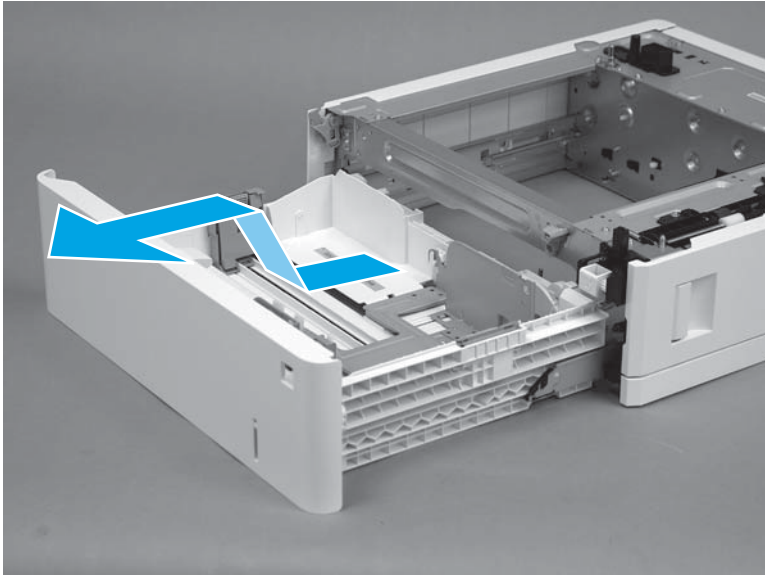

Step 2: Remove the rear cover

1. Release three tabs (callout 1).

Figure 1-5077 Release three tabs

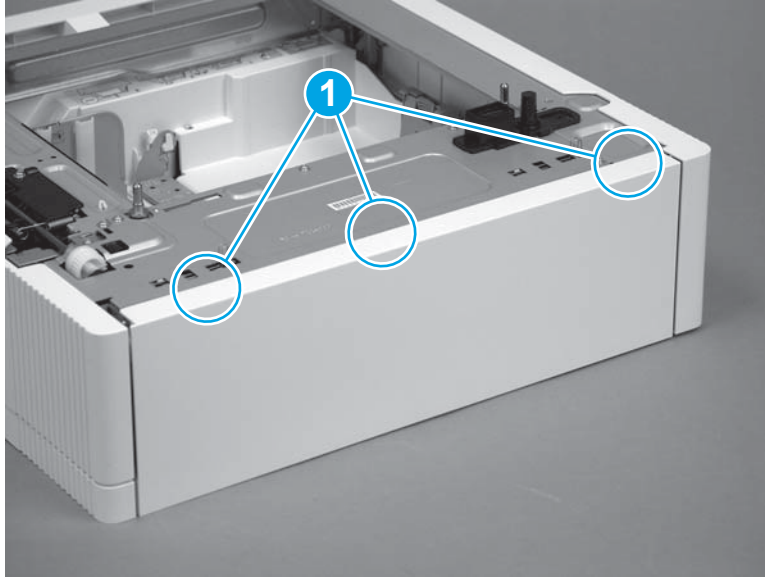

2. Rotate the top of the cover away from the accessory (callout 1), and then lift it up to remove it (callout 2).

Figure 1-5078 Remove the cover

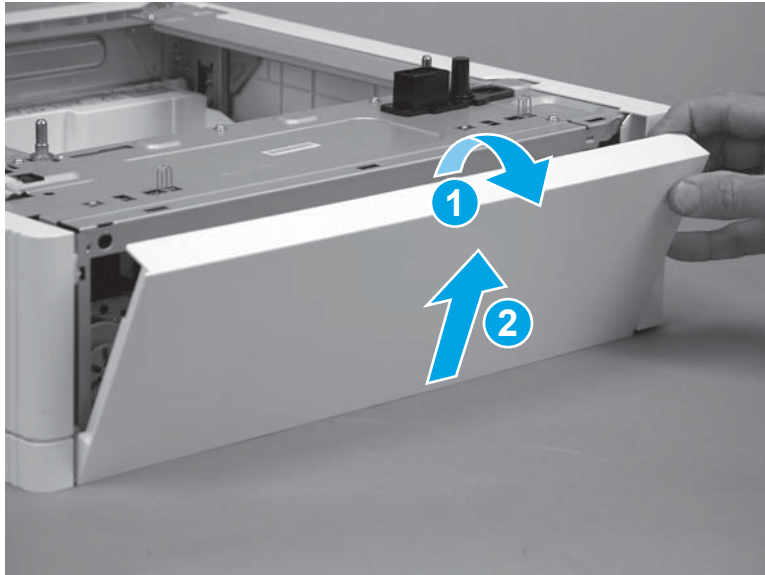

Step 3: Remove the auto close assembly

1. Disconnect one connector (callout 1; J903), and then release the wire harness from the retainer (callout 2).

Figure 1-5079 Disconnect one connector

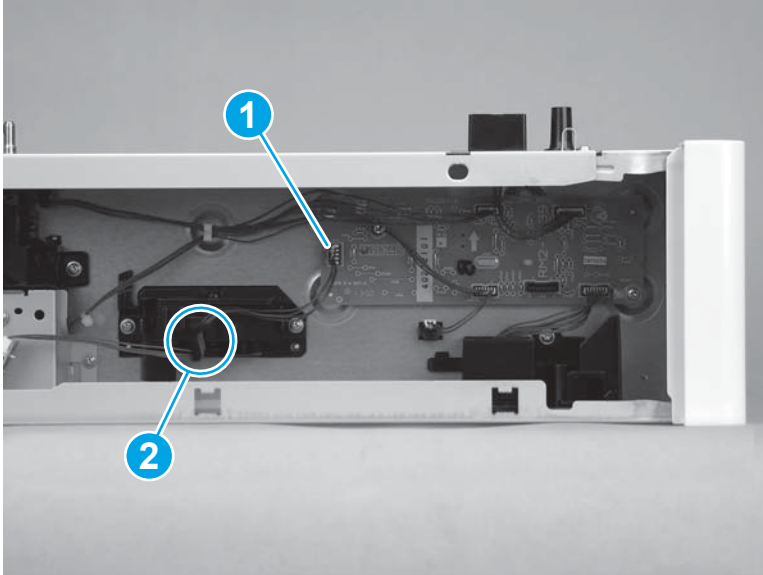

2. Remove two screws (callout 1).

Figure 1-5080 Remove two screws

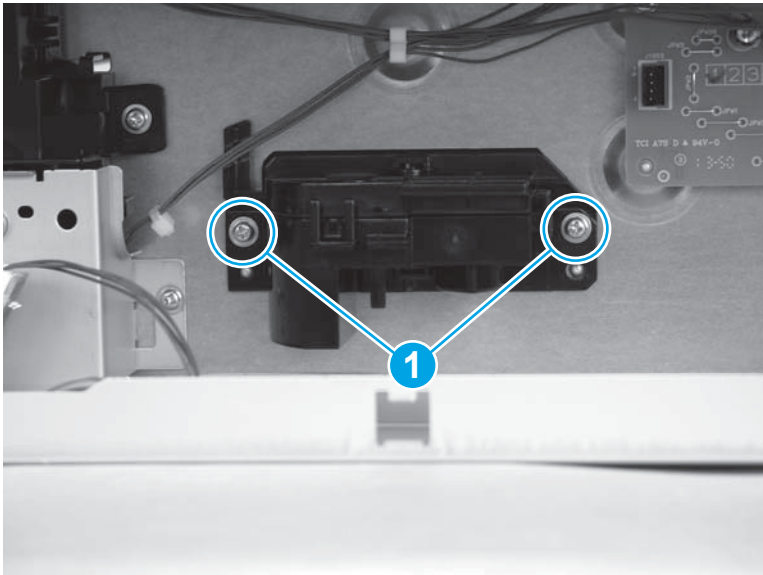

3. Lift up on the assembly to release it.

Figure 1-5081 Release the assembly

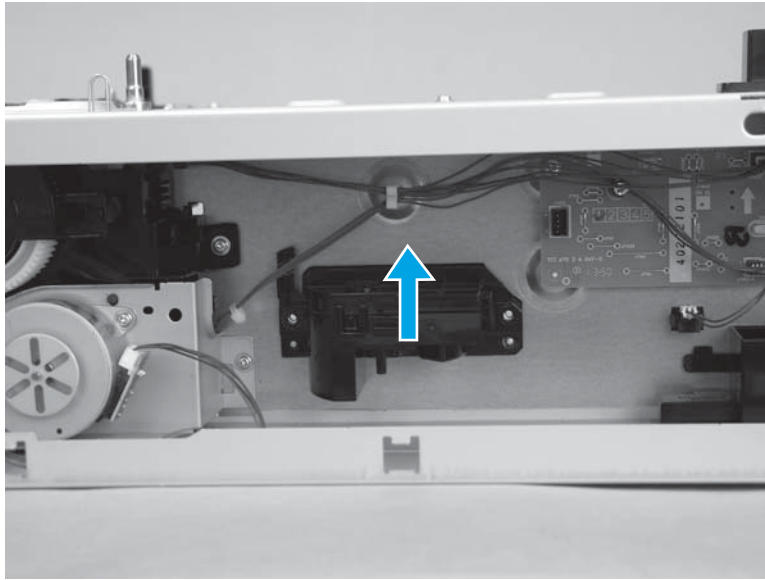

4. Remove the auto close assembly.

Figure 1-5082 Remove the assembly



Step 4: Unpack the replacement assembly

Unpack the replacement assembly from the packaging.

For complete information on HP's recycling programs, go to [Product return and recycling](#).

 **NOTE:** HP recommends responsible disposal of the defective assembly.

Figure 1-5083 Recycle and unpack

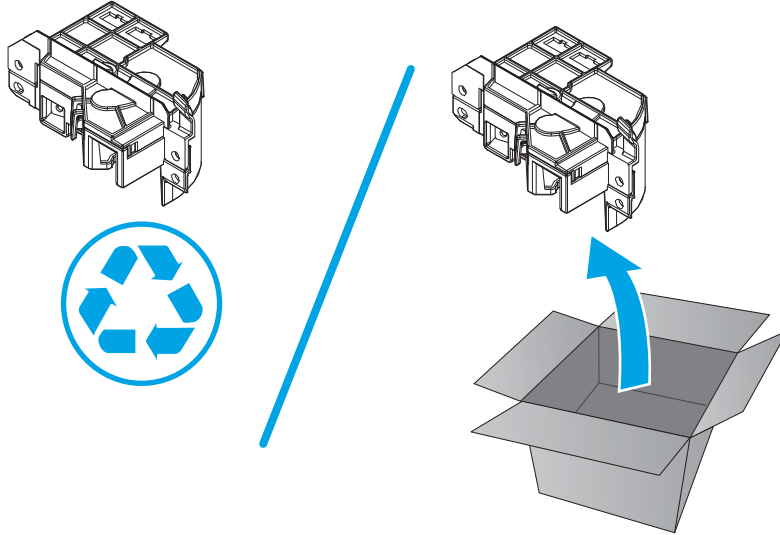

Step 5: Install the auto close assembly

1. Position the auto close assembly in the hole in the chassis.

Figure 1-5084 Install the assembly



2. Push down on the assembly to engage it.

Figure 1-5085 Engage the assembly

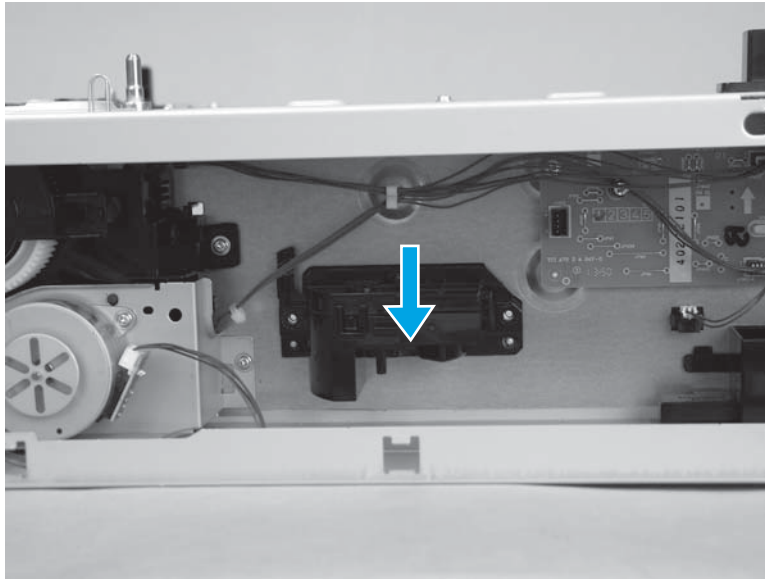

3. Install two screws (callout 1).

Figure 1-5086 Install two screws

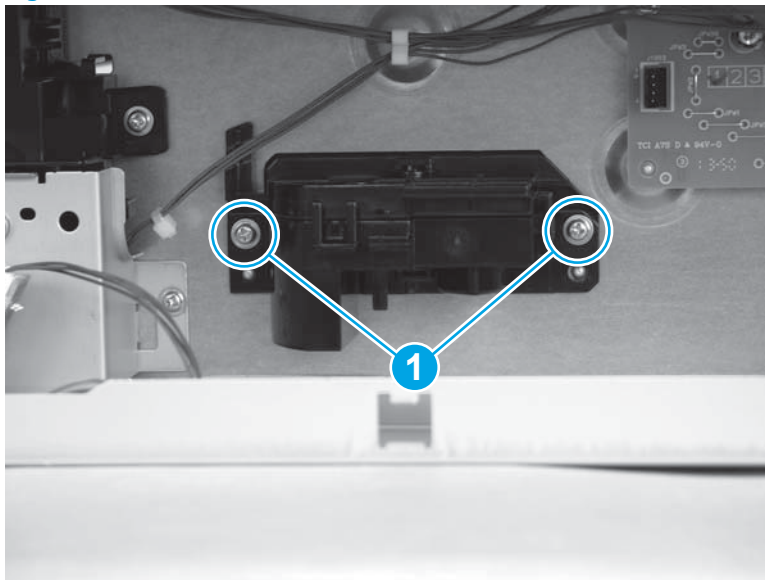

4. Install the wire harness in the retainer (callout 1), and then connect one connector (callout 2; J903).

Figure 1-5087 Disconnect one connector

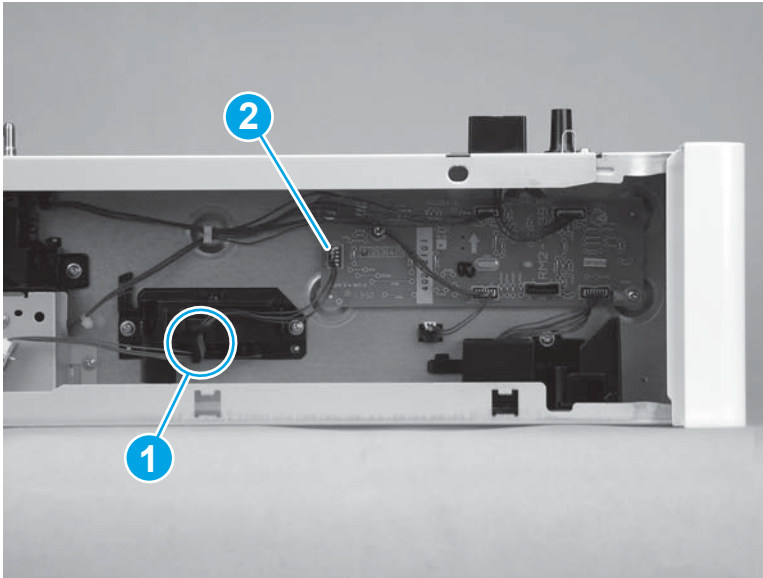

Step 6: Install the rear cover

1. Align the three mounting tabs (callout 1) on the cover with the slots in the chassis.

Figure 1-5088 Position the cover on the chassis

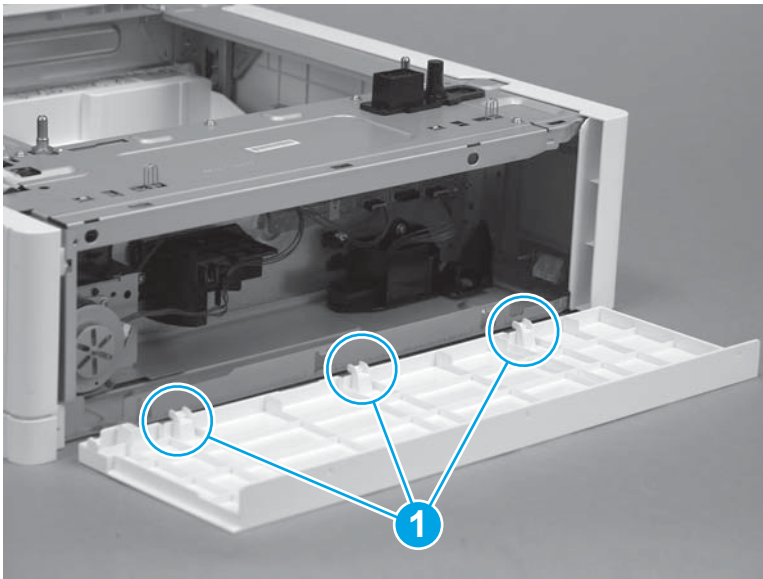

2. Position the cover on the accessory (callout 1), and then rotate the top of the cover up and onto the chassis (callout 2) to install it.

Figure 1-5089 Install the cover

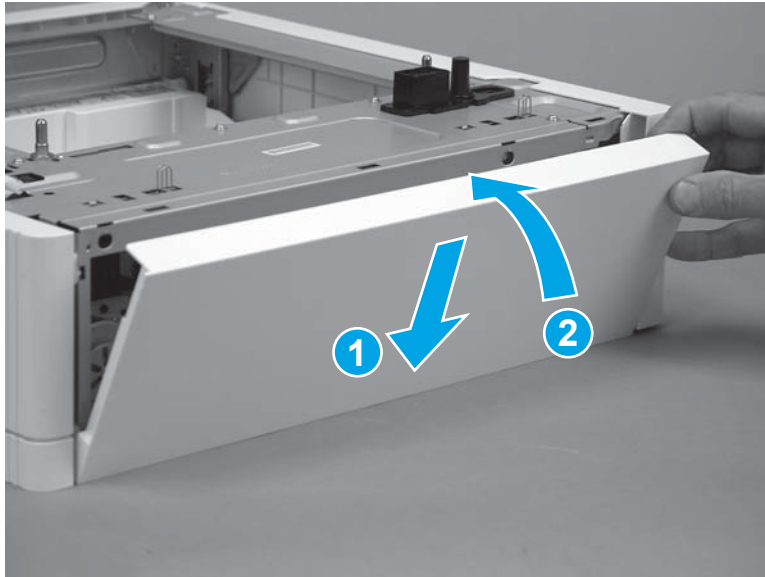

3. Make sure that the three tabs (callout 1) snap into place.

Figure 1-5090 Check the three tabs

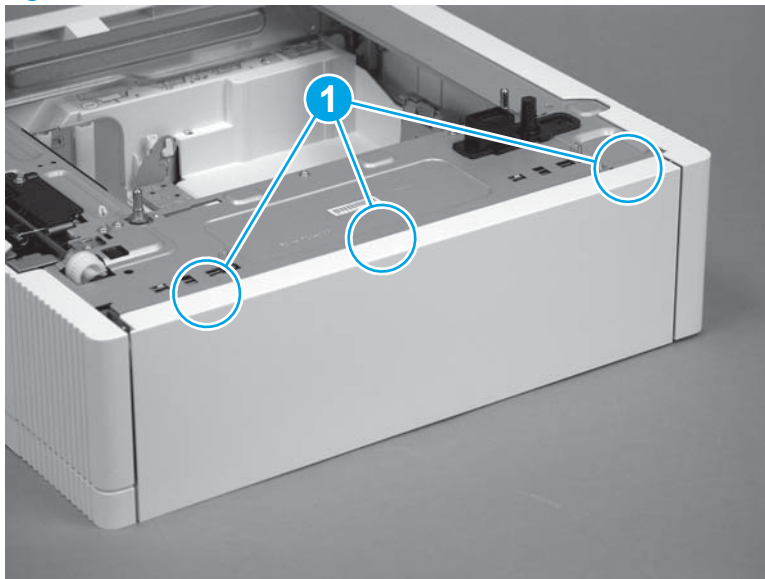

Step 7: Install the tray

1. With the front of the tray slightly lifted, align the sides of the tray with the rails in the printer, and then carefully slide the tray into the printer.

 **TIP:** As the tray slides into the accessory, lower the front of it.

Figure 1-5091 Install the tray



2. Close the tray.

Figure 1-5092 Close the tray

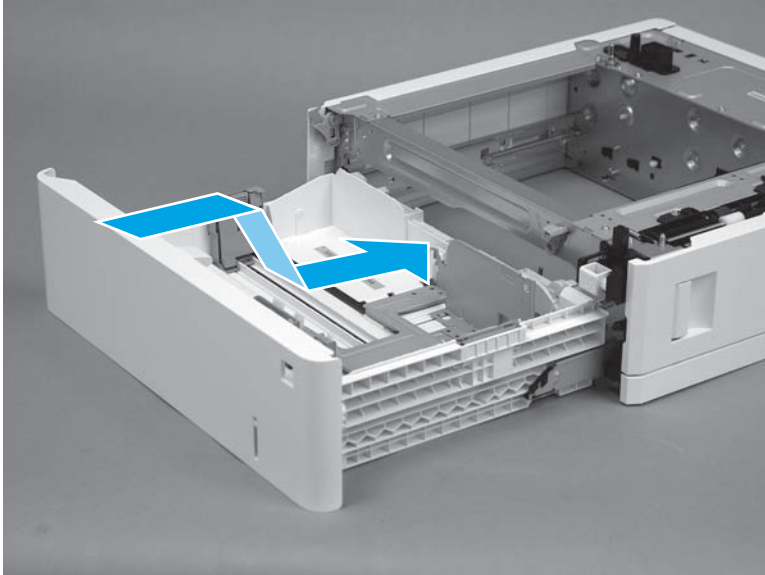
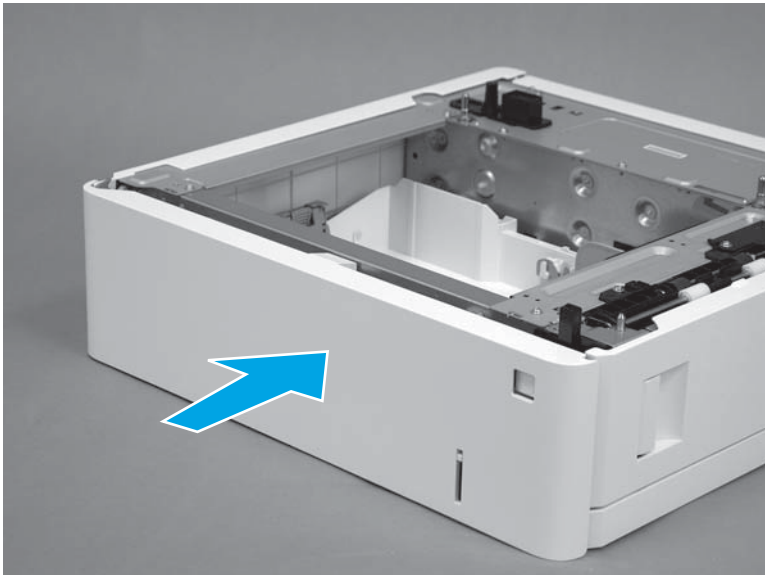

Removal and replacement: Switch button (SW12) (1x550-sheet paper feeder)

- [Introduction](#)
- [Step 1: Remove the tray](#)
- [Step 2: Remove the rear cover](#)
- [Step 3: Remove the switch button \(SW12\)](#)
- [Step 4: Unpack the replacement assembly](#)
- [Step 5: Install the switch button \(SW12\)](#)
- [Step 6: Install the rear cover](#)
- [Step 7: Install the tray](#)

Introduction

This document provides the procedures to remove and replace the 1x550-sheet paper feeder switch button (SW12).

Before performing service

Use the table below to identify the correct part number for your printer, and then go to <http://h20141.www2.hp.com/hpparts> to order the part.

Switch button (SW12) (1x550-sheet paper feeder) part number	
WC2-5806-000CN	Switch button (SW12) (1x550-sheet paper feeder)

Required tools

No special tools are required to install this part.

After performing service

Make sure that the rear cover is flush against the chassis after replacing it.

Make sure that Tray 3 is fully closed after replacing it.

Post service test

Print a page from a host computer using the appropriate tray as the source tray.

Step 1: Remove the tray

1. Pull the tray out until it stops.

Figure 1-5093 Pull the tray out

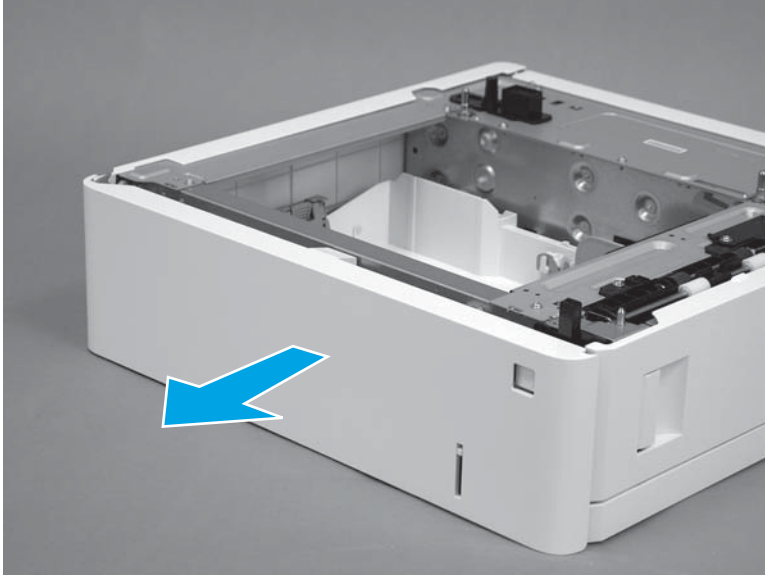

2. Lift the front of the tray, and then pull it out of the printer to remove it.

Figure 1-5094 Remove the tray

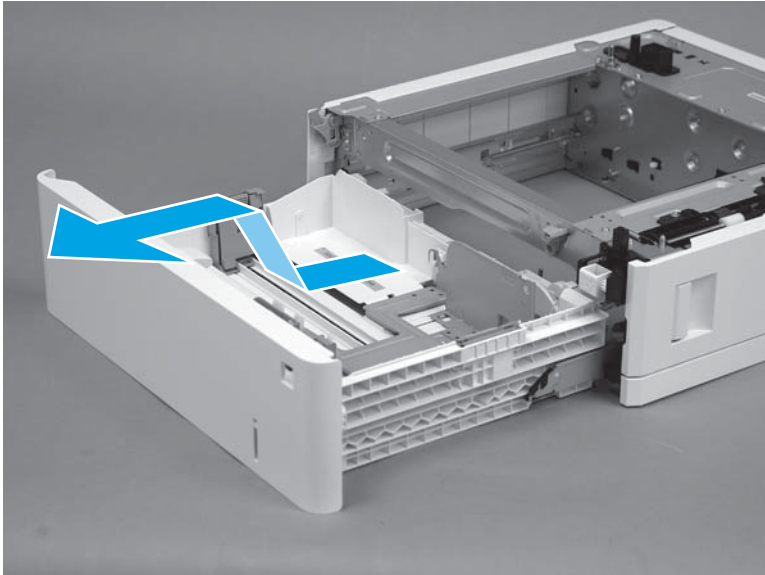

Step 2: Remove the rear cover

1. Release three tabs (callout 1).

Figure 1-5095 Release three tabs

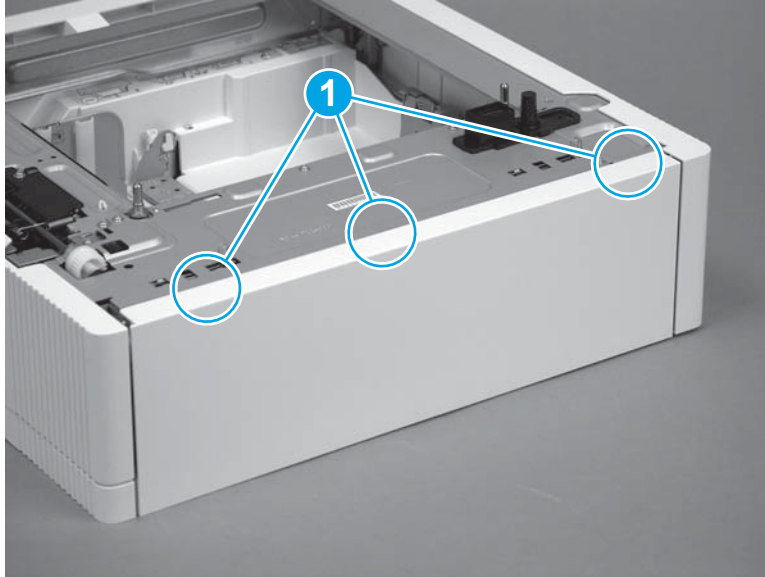

2. Rotate the top of the cover away from the accessory (callout 1), and then lift it up to remove it (callout 2).

Figure 1-5096 Remove the cover

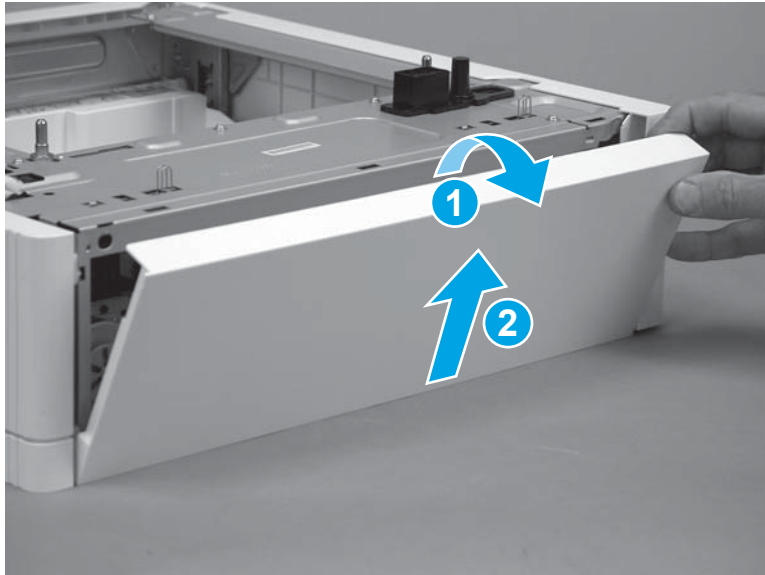

Step 3: Remove the switch button (SW12)

1. Disconnect one connector (callout 1).

Figure 1-5097 Disconnect one connector

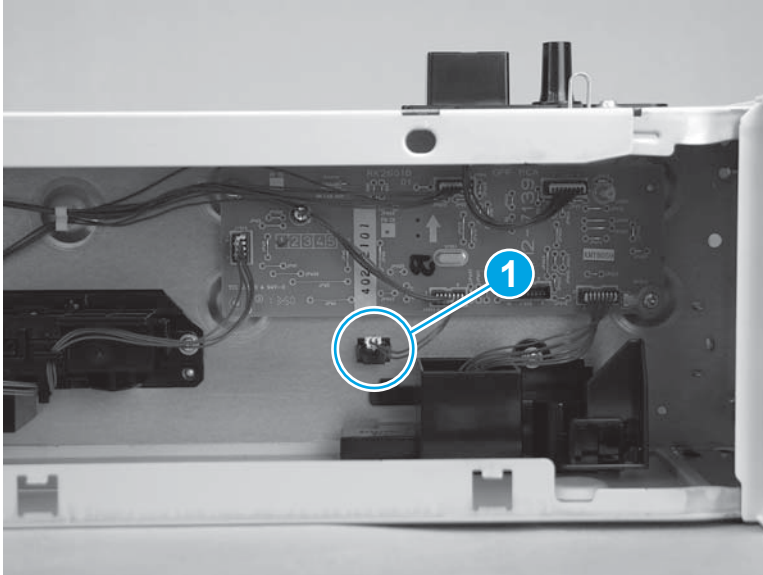

2. Squeeze two tabs to release them, and then push the switch through the opening in the chassis into the tray cavity.

Figure 1-5098 Squeeze two tabs

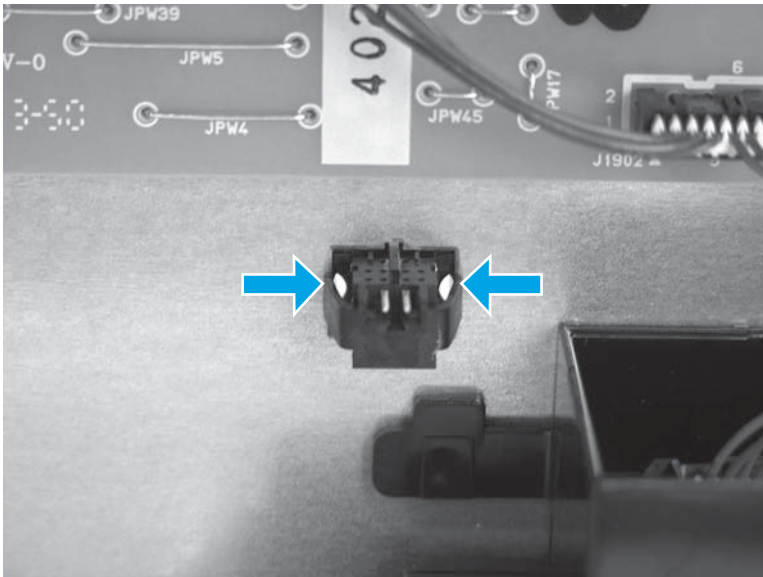

3. Remove the switch button (SW12).

Figure 1-5099 Remove the switch button (SW12)

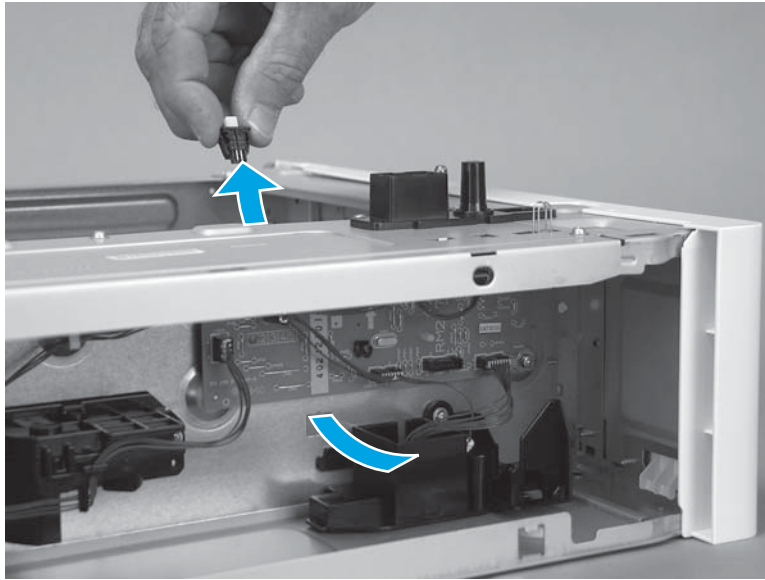

Step 4: Unpack the replacement assembly

Unpack the replacement assembly from the packaging.

For complete information on HP's recycling programs, go to [Product return and recycling](#).

 **NOTE:** HP recommends responsible disposal of the defective assembly.

Figure 1-5100 Recycle and unpack

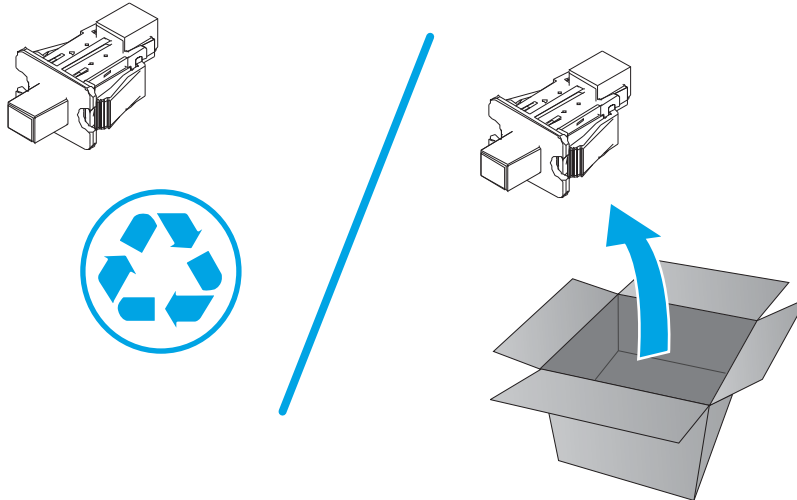

Step 5: Install the switch button (SW12)

1. From inside the tray cavity, push the switch through the opening in the chassis.

 **NOTE:** Orientate the switch button (SW12) with the contact pins face up.

Figure 1-5101 Install the switch button (SW12)



2. Make sure that the two tabs snap into place.

Figure 1-5102 Install the switch button (SW12)

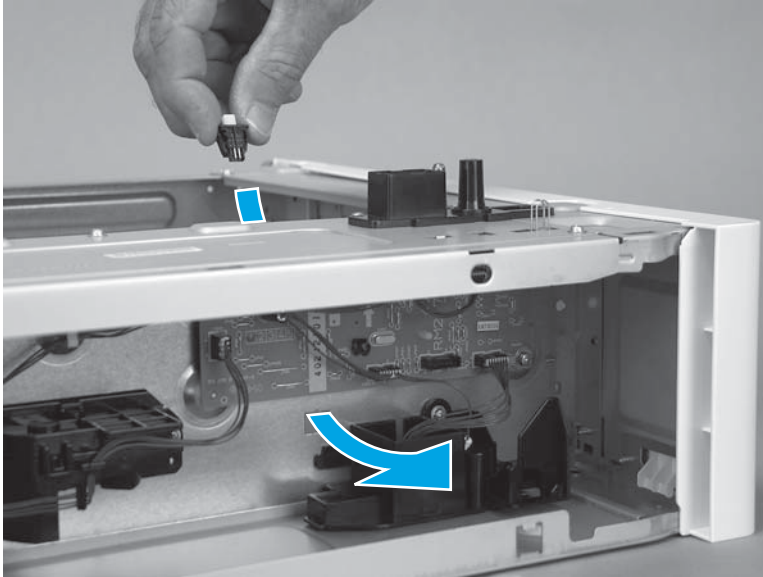
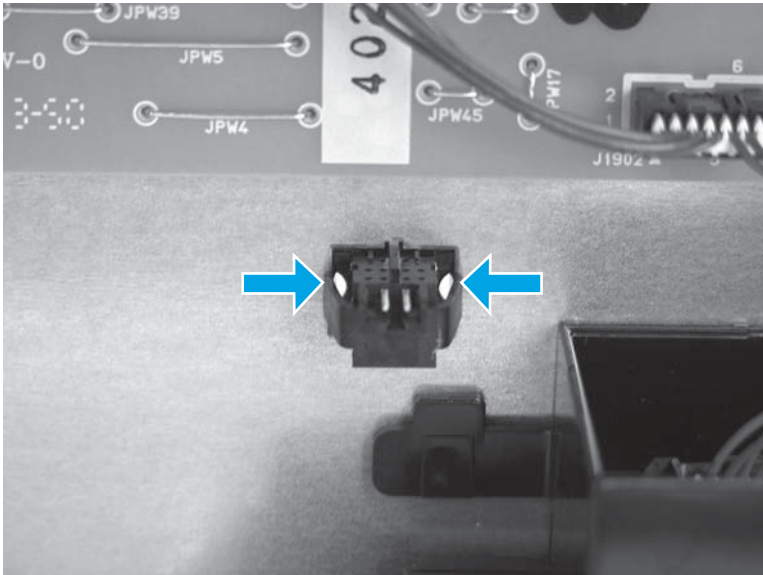

3. Connect one connector (callout 1).

Figure 1-5103 Connect one connector

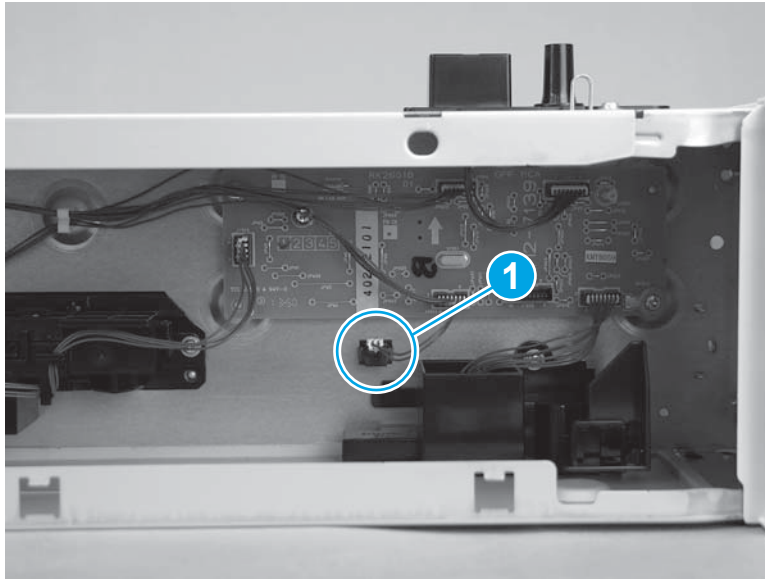

Step 6: Install the rear cover

1. Align the three mounting tabs (callout 1) on the cover with the slots in the chassis.

Figure 1-5104 Position the cover on the chassis

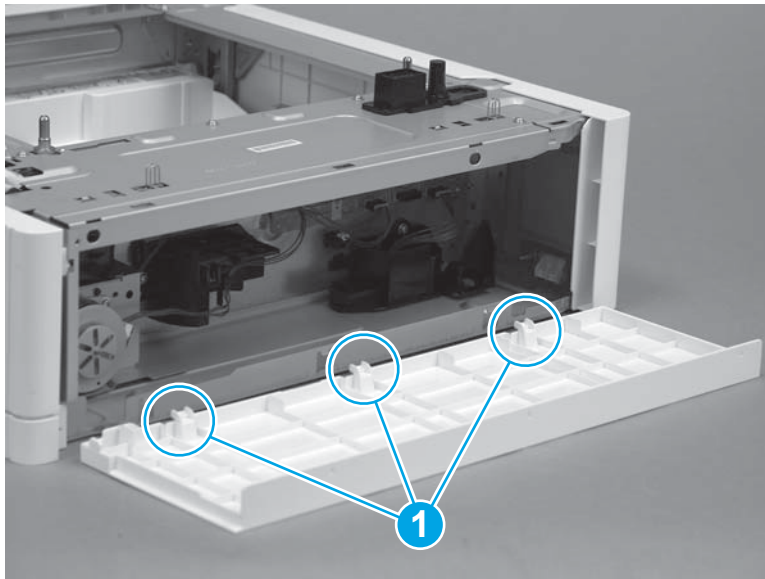

2. Position the cover on the accessory (callout 1), and then rotate the top of the cover up and onto the chassis (callout 2) to install it.

Figure 1-5105 Install the cover

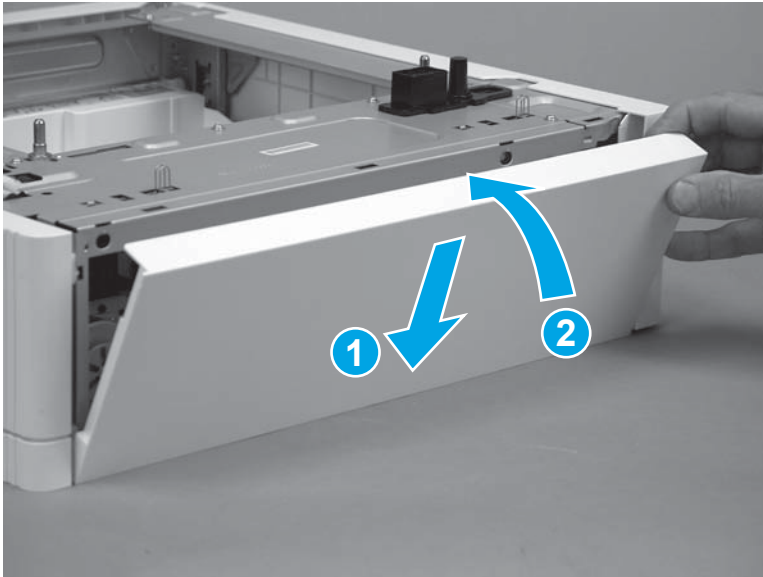

3. Make sure that the three tabs (callout 1) snap into place.

Figure 1-5106 Check the three tabs

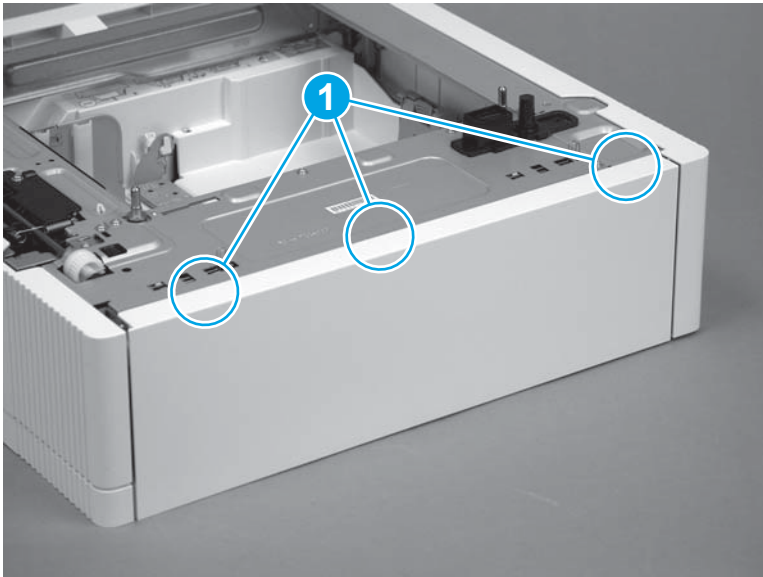

Step 7: Install the tray

1. With the front of the tray slightly lifted, align the sides of the tray with the rails in the printer, and then carefully slide the tray into the printer.

 **TIP:** As the tray slides into the accessory, lower the front of it.

Figure 1-5107 Install the tray



2. Close the tray.

Figure 1-5108 Close the tray

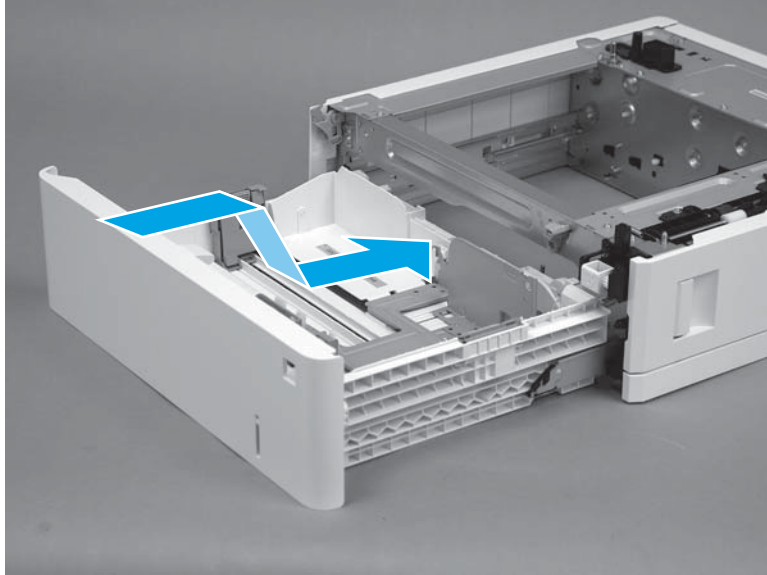
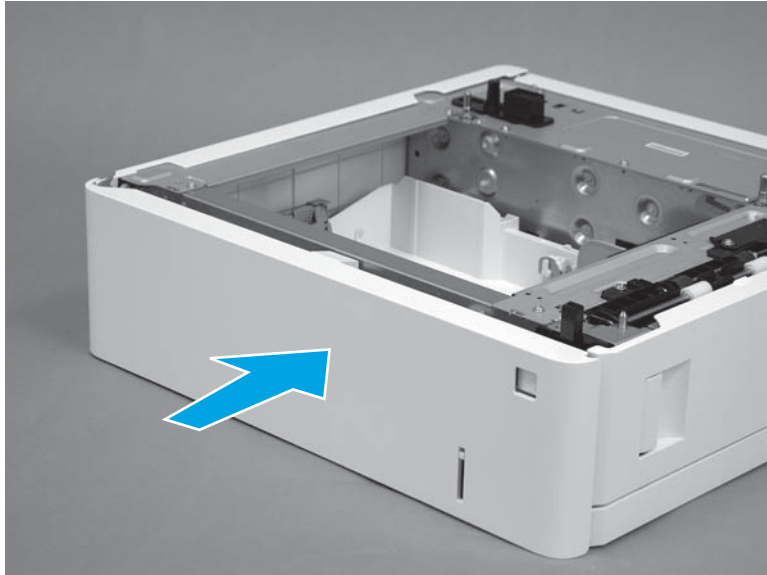

Removal and replacement: Drawer connector holder (1x550-sheet paper feeder)

- [Introduction](#)
- [Step 1: Remove the rear cover](#)
- [Step 2: Remove the drawer connector holder](#)
- [Step 3: Unpack the replacement assembly](#)
- [Step 4: Install the drawer connector holder](#)
- [Step 5: Install the rear cover](#)

Introduction

This document provides the procedures to remove and replace the 1x550-sheet paper feeder drawer connector holder.

Before performing service

Use the table below to identify the correct part number for your printer, and then go to <http://h20141.www2.hp.com/hpparts> to order the part.

Drawer connector holder (1x550-sheet paper feeder) part number	
RC4-1741-000CN	Drawer connector holder (1x550-sheet paper feeder)

Required tools

No special tools are required to install this part.

After performing service

Make sure that the rear cover is flush against the chassis after replacing it.

Post service test

Print a page from a host computer using the appropriate tray as the source tray.

Step 1: Remove the rear cover

1. Release three tabs (callout 1).

Figure 1-5109 Release three tabs

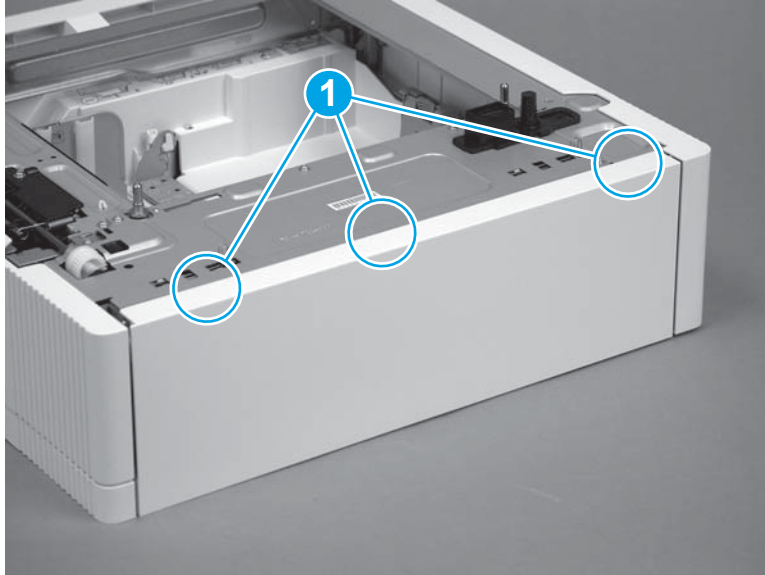

2. Rotate the top of the cover away from the accessory (callout 1), and then lift it up to remove it (callout 2).

Figure 1-5110 Remove the cover

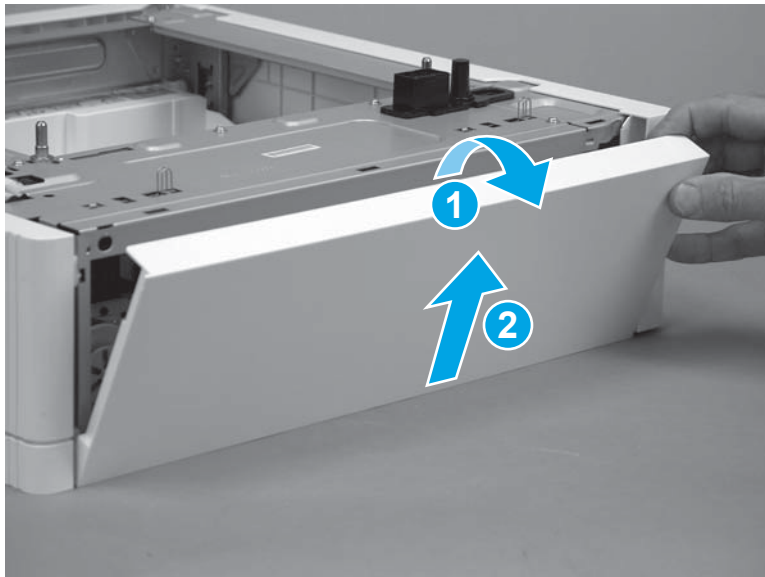

Step 2: Remove the drawer connector holder

1. Disconnect one connector (callout 1; J901).

Figure 1-5111 Disconnect one connector

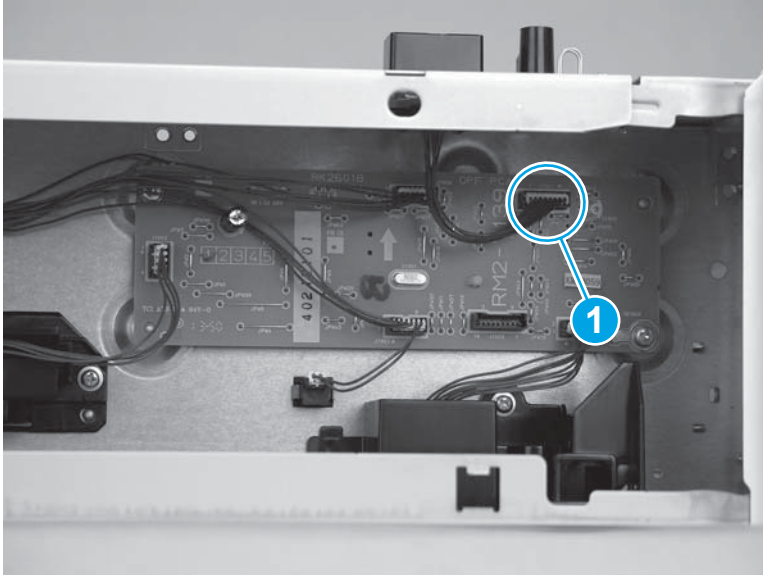

2. Release one tab (callout 1), and then slide the drawer connector holder as shown (callout 2) to release it.

Figure 1-5112 Release one tab

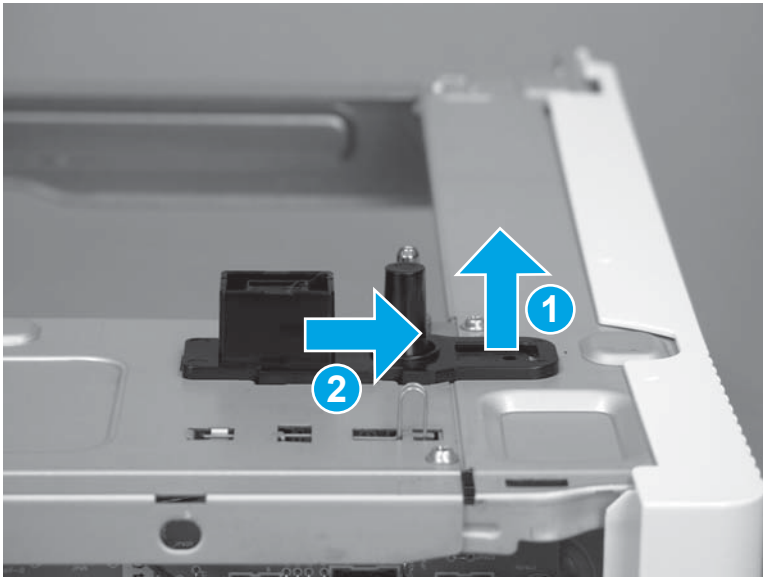

3. Remove the drawer connector holder.

Figure 1-5113 Remove the tray connector

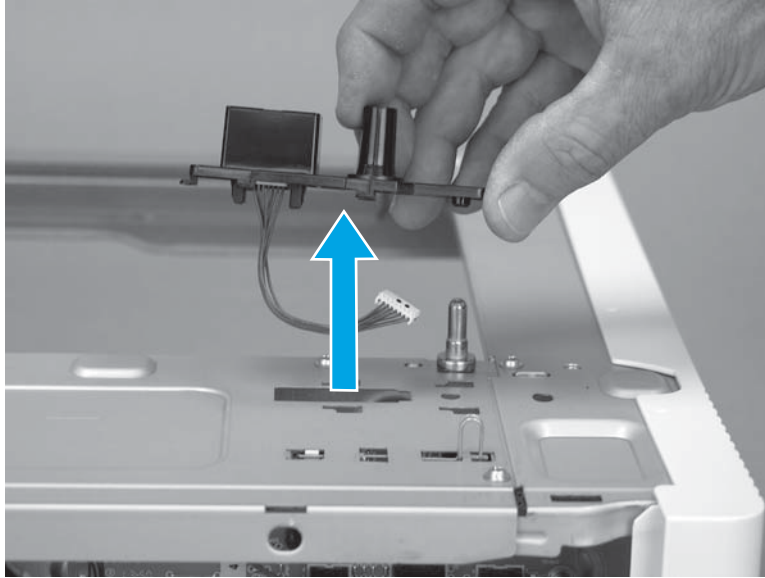

Step 3: Unpack the replacement assembly

Unpack the replacement assembly from the packaging.

For complete information on HP's recycling programs, go to [Product return and recycling](#).

 **NOTE:** HP recommends responsible disposal of the defective assembly.

Figure 1-5114 Recycle and unpack

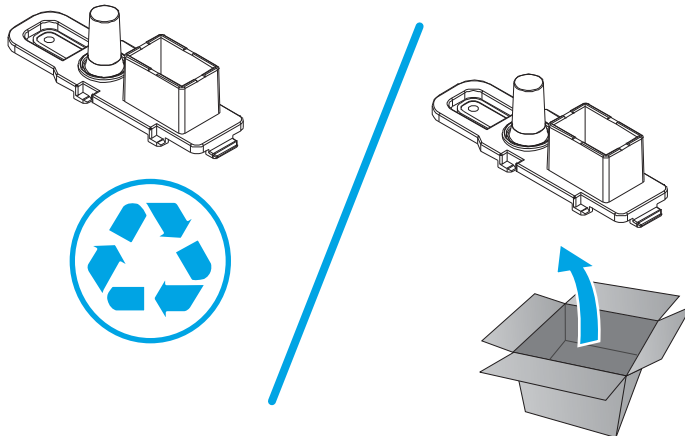

Step 4: Install the drawer connector holder

1. Position the drawer connector holder on the chassis.

 **NOTE:** Make sure that the wire harness (callout 1) was transferred from the discarded assembly to the replacement assembly.

Figure 1-5115 Place the tray connector on the accessory



2. Slide the drawer connector holder as shown (callout 1) to install it, and then make sure that one tab (callout 2) snaps into place .

Figure 1-5116 Install the tray connector

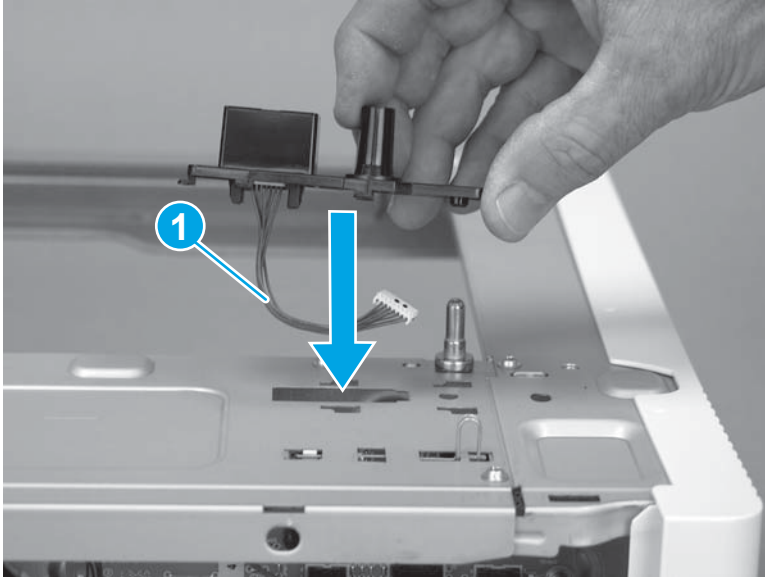
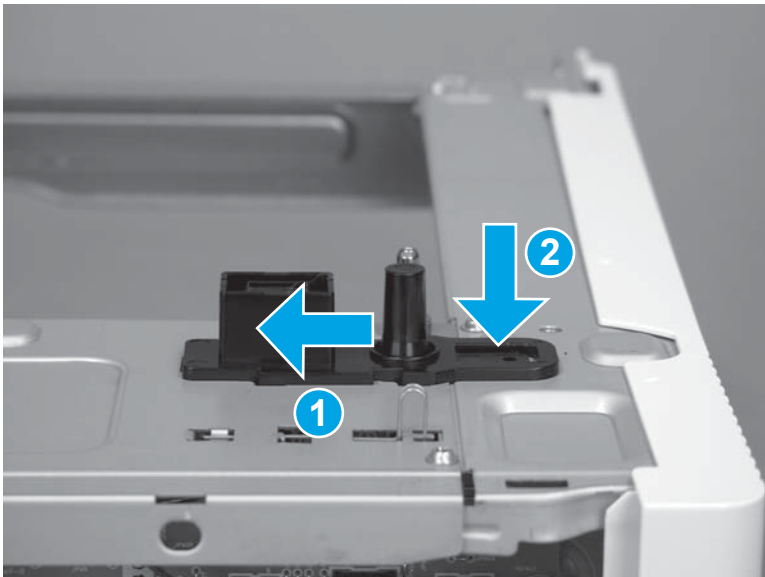

3. Connect one connector (callout 1; J901).

Figure 1-5117 Connect one connector

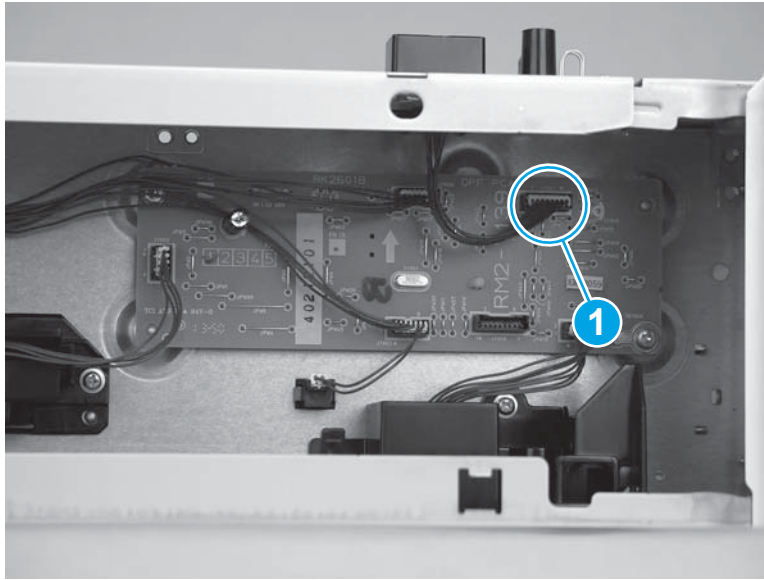

Step 5: Install the rear cover

1. Align the three mounting tabs (callout 1) on the cover with the slots in the chassis.

Figure 1-5118 Position the cover on the chassis

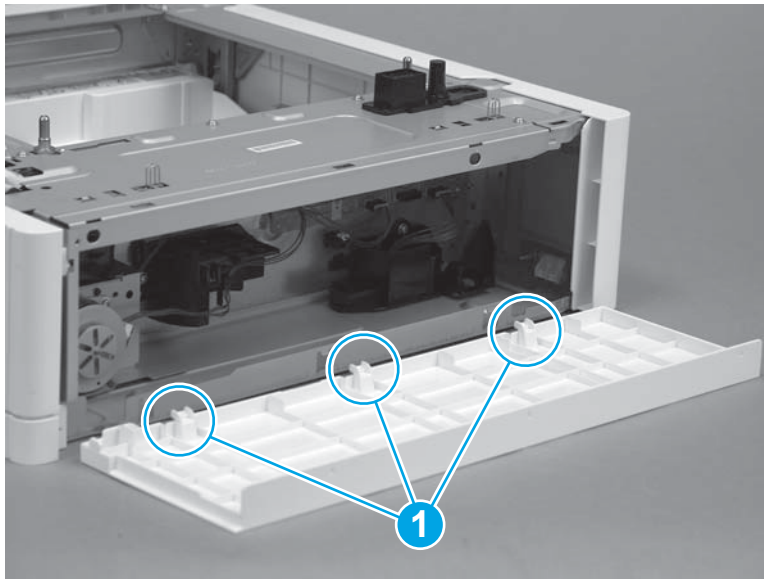

2. Position the cover on the accessory (callout 1), and then rotate the top of the cover up and onto the chassis (callout 2) to install it.

Figure 1-5119 Install the cover

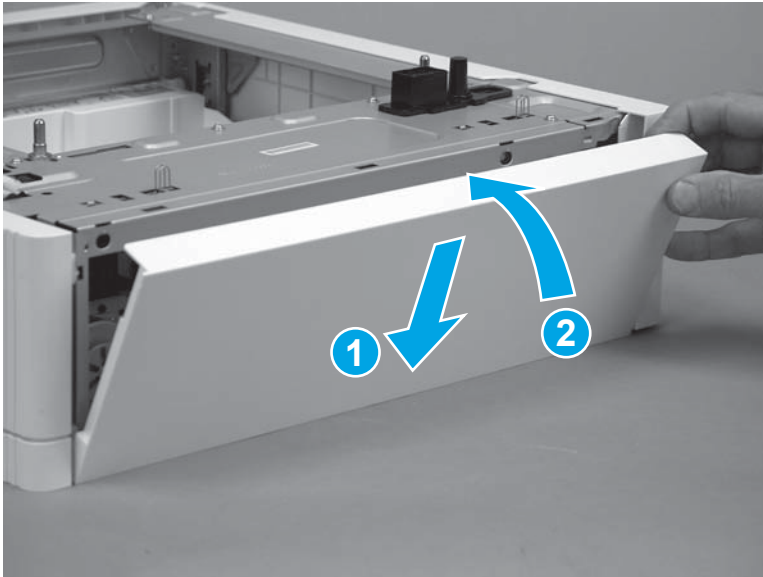

3. Make sure that the three tabs (callout 1) snap into place.

Figure 1-5120 Check the three tabs

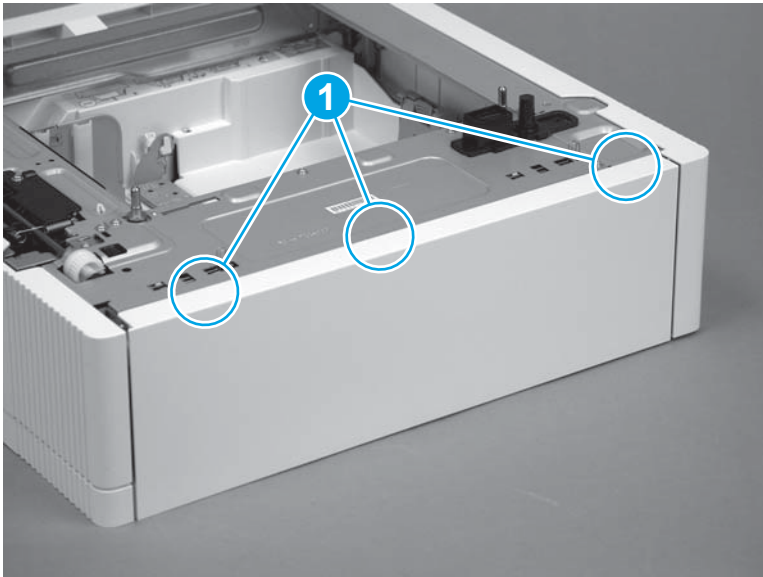



Removal and replacement: Paper-feeder drive PCA (1x550-sheet paper feeder)

- [Introduction](#)
- [Step 1: Remove the rear cover](#)
- [Step 2: Remove the paper-feeder drive PCA](#)
- [Step 3: Unpack the replacement assembly](#)
- [Step 4: Install the paper-feeder-drive PCA](#)
- [Step 5: Install the rear cover](#)

Introduction

This document provides the procedures to remove and replace the 1x550-sheet paper feeder paper-feeder drive PCA.

Before performing service

 **CAUTION:**  This part contains components that are electrostatic discharge (ESD) sensitive. To reduce the possibility of ESD damage, always touch the sheet-metal chassis to ground yourself before touching an ESD sensitive part.

Use the table below to identify the correct part number for your printer, and then go to <http://h20141.www2.hp.com/hpparts> to order the part.

Paper-feeder drive PCA (1x550-sheet paper feeder) part number	
RM2-7139-000CN	Paper-feeder drive PCA (1x550-sheet paper feeder)

Required tools

- #2 Phillips screwdriver with a magnetic tip

After performing service

Make sure that all of the connectors on the paper-feeder drive PCA are fully seated after replacing it.

Make sure that the rear cover is flush against the chassis after replacing it.

Post service test

Print a page from a host computer using the appropriate tray as the source tray.

Step 1: Remove the rear cover

1. Release three tabs (callout 1).

Figure 1-5121 Release three tabs

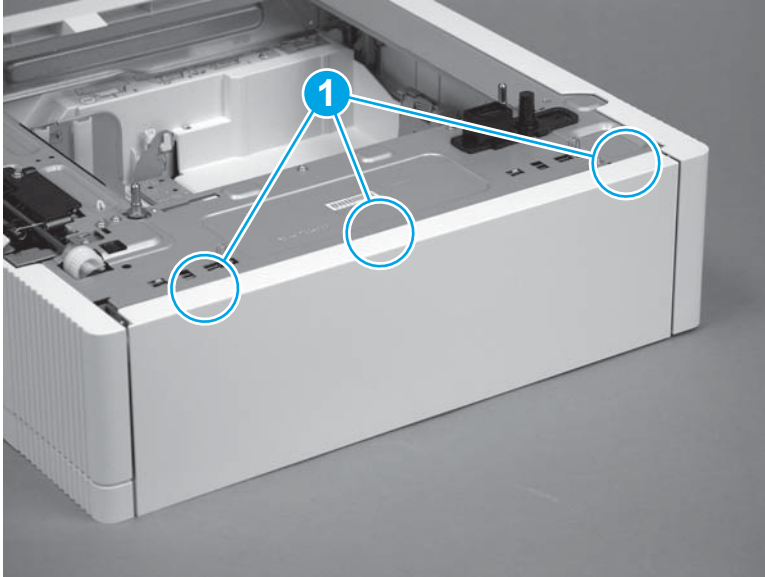

2. Rotate the top of the cover away from the accessory (callout 1), and then lift it up to remove it (callout 2).

Figure 1-5122 Remove the cover

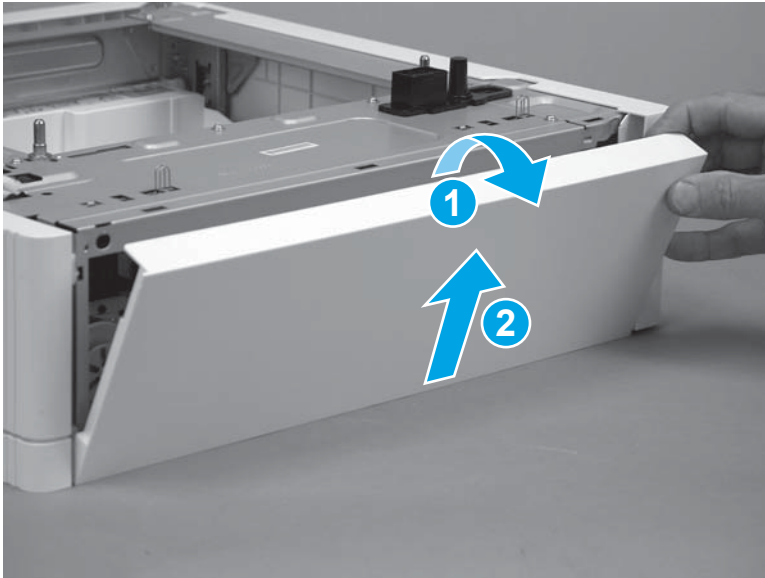

Step 2: Remove the paper-feeder drive PCA

 **CAUTION:**  ESD-sensitive part.

1. Disconnect 5 connectors (callout 1).
The following connectors are empty:
 - J908

Figure 1-5123 Disconnect all of the connectors

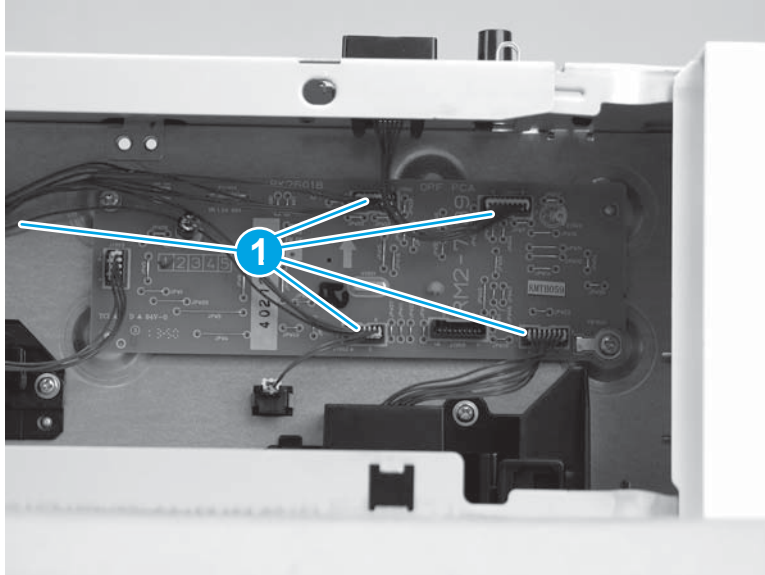

2. Remove two screws (callout 1), and then remove the paper-feeder drive PCA (callout 2).

Figure 1-5124 Remove the PCA

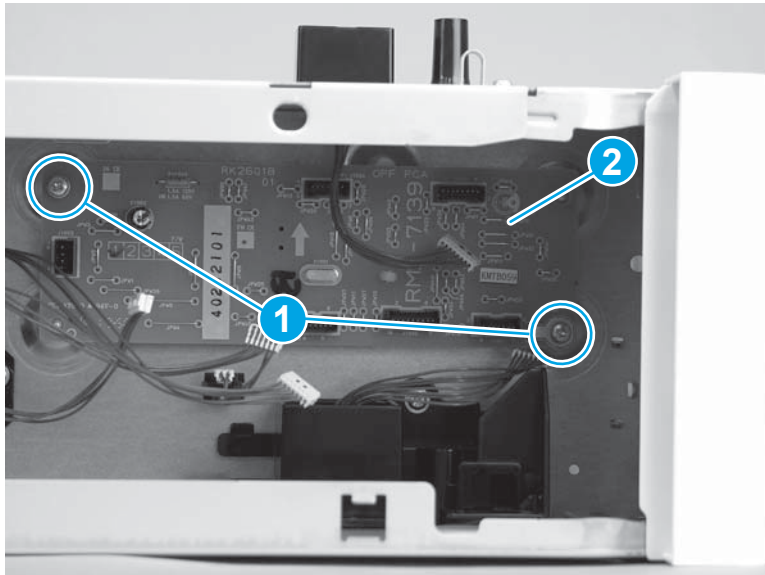

Step 3: Unpack the replacement assembly

Unpack the replacement assembly from the packaging.

 **CAUTION:**  ESD-sensitive part.

For complete information on HP's recycling programs, go to [Product return and recycling](#).

 **NOTE:** HP recommends responsible disposal of the defective assembly.

Figure 1-5125 Recycle and unpack

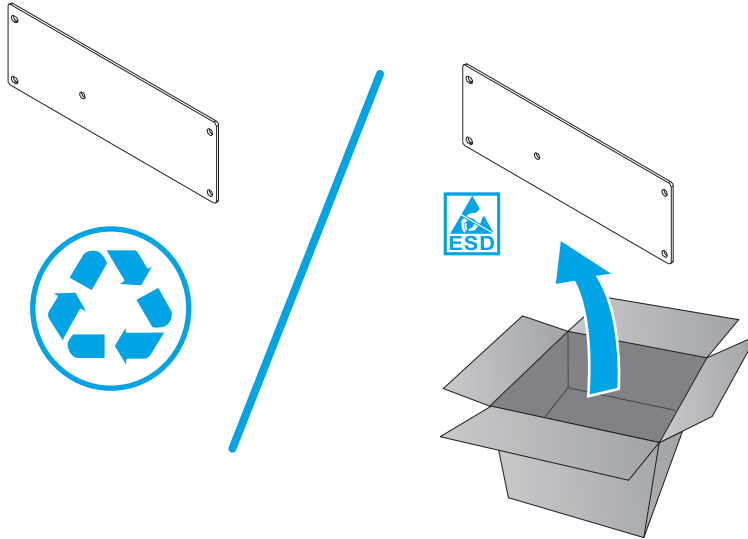

Step 4: Install the paper-feeder-drive PCA

CAUTION:  ESD-sensitive part.

1. Position the paper-feeder drive PCA (callout 1) in the chassis, and then install two screws (callout 2).

Figure 1-5126 Install the PCA

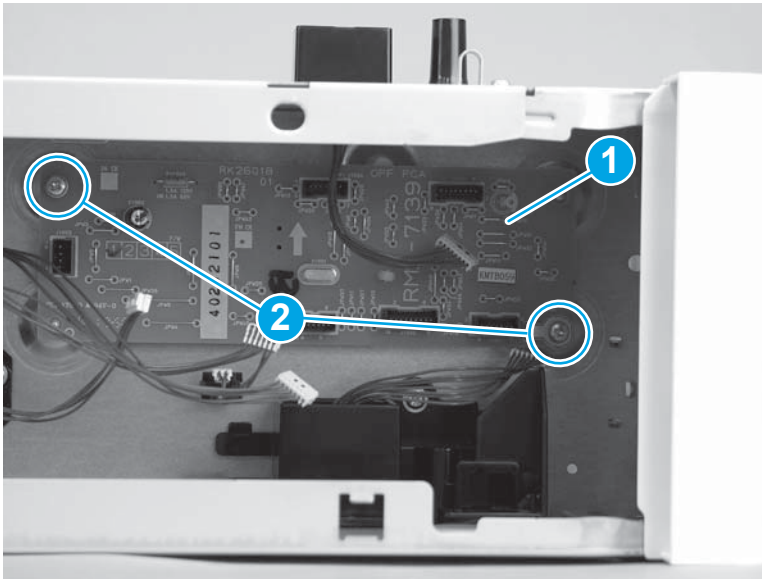

2. Connect 5 connectors (callout 1).

The following connectors are empty:

- J908

Figure 1-5127 Connect all of the connectors

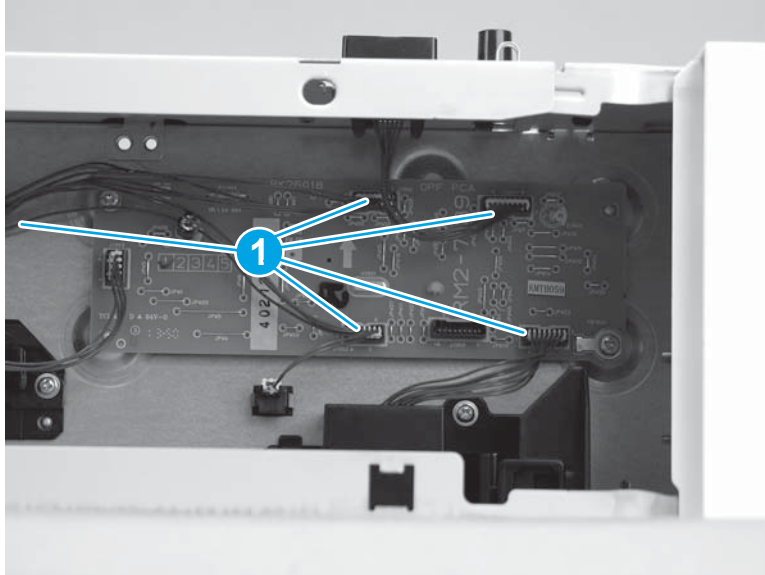

Step 5: Install the rear cover

1. Align the three mounting tabs (callout 1) on the cover with the slots in the chassis.

Figure 1-5128 Position the cover on the chassis

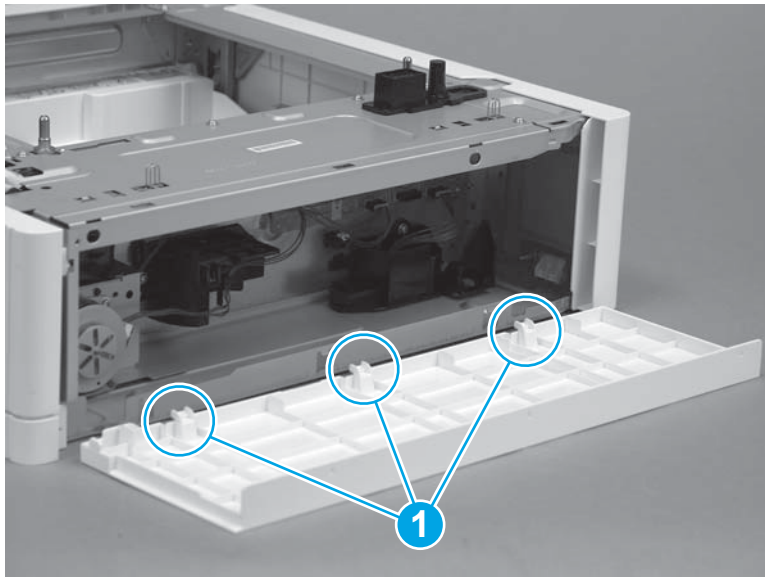

2. Position the cover on the accessory (callout 1), and then rotate the top of the cover up and onto the chassis (callout 2) to install it.

Figure 1-5129 Install the cover

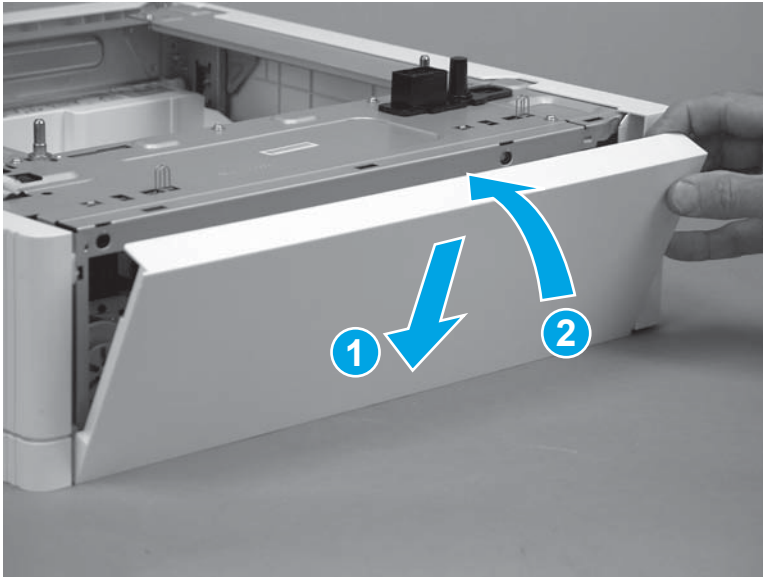

3. Make sure that the three tabs (callout 1) snap into place.

Figure 1-5130 Check the three tabs

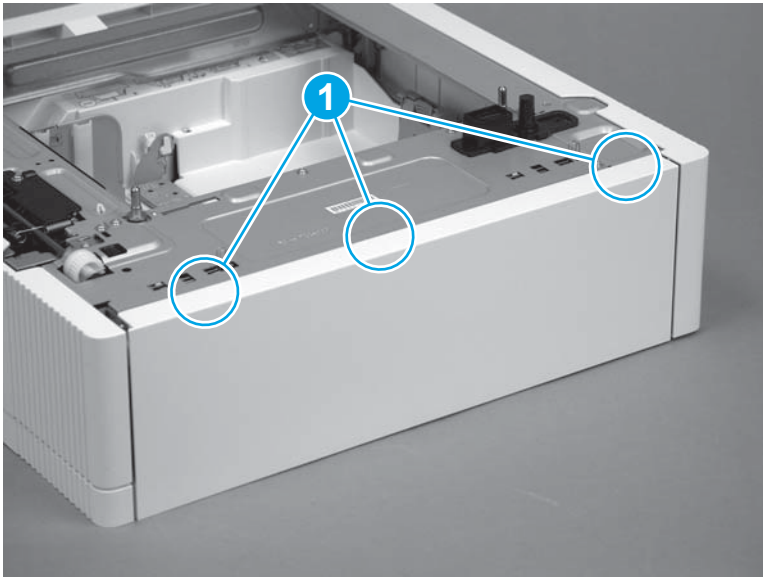

Removal and replacement: Paper feed assembly (1x550-sheet paper feeder)

- [Introduction](#)
- [Step 1: Remove the tray](#)
- [Step 2: Remove the rear cover](#)
- [Step 3: Remove the right door](#)
- [Step 4: Remove the drawer connector holder](#)
- [Step 5: Remove the paper feed assembly](#)
- [Step 6: Unpack the replacement assembly](#)
- [Step 7: Install the paper feed assembly](#)
- [Step 8: Install the drawer connector holder](#)
- [Step 9: Install the right door](#)
- [Step 10: Install the rear cover](#)
- [Step 11: Install the tray](#)

Introduction

This document provides the procedures to remove and replace the 1x550-sheet paper feeder paper feed assembly.

Before performing service

Use the table below to identify the correct part number for your printer, and then go to <http://h20141.www2.hp.com/hpparts> to order the part.

Paper feed assembly (1x550-sheet paper feeder) part number	
RM2-5145-000CN	Paper feed assembly (1x550-sheet paper feeder)

Required tools

- #2 Phillips screwdriver with a magnetic tip and a 152-mm (6-in) shaft length
- Small flat blade screwdriver

After performing service

Make sure that the rear cover is flush against the chassis after replacing it.

Make sure that the right door latches correctly when closed after replacing it.

Make sure that the tray is fully closed after replacing it.

Post service test

Print a page from a host computer using the appropriate tray as the source tray.

Step 1: Remove the tray

1. Pull the tray out until it stops.

Figure 1-5131 Pull the tray out

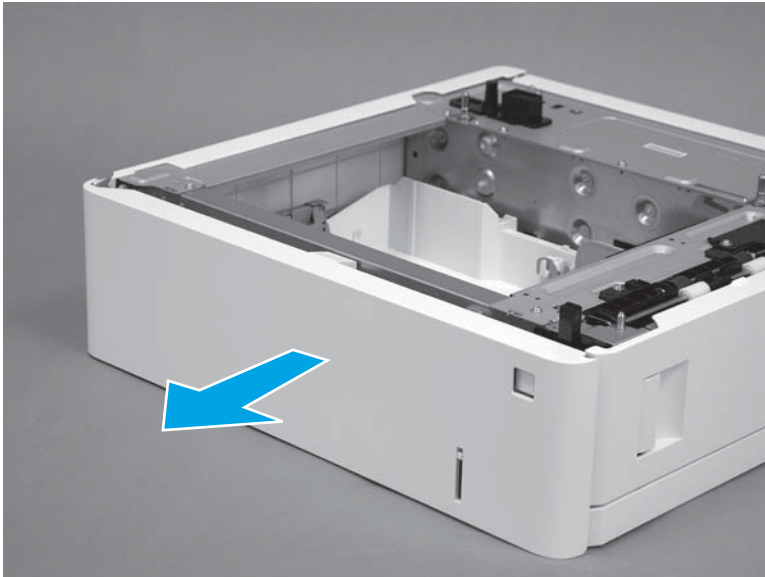

2. Lift the front of the tray, and then pull it out of the printer to remove it.

Figure 1-5132 Remove the tray

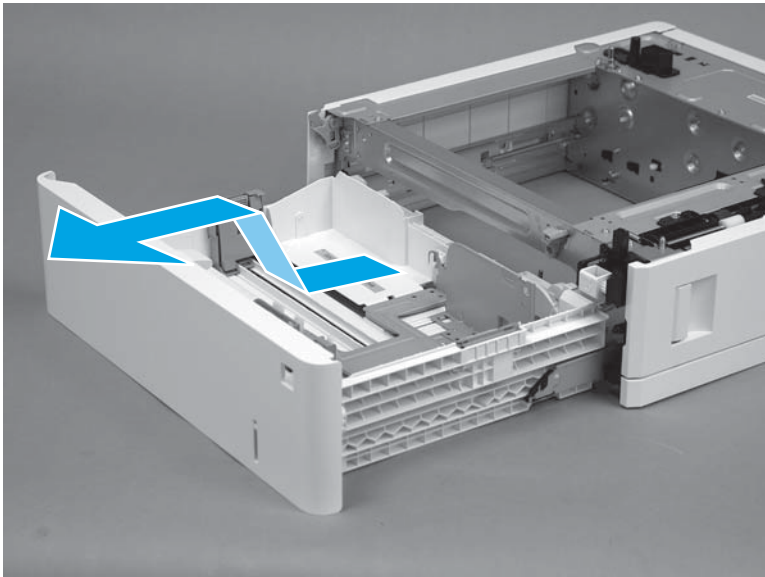

Step 2: Remove the rear cover

1. Release three tabs (callout 1).

Figure 1-5133 Release three tabs

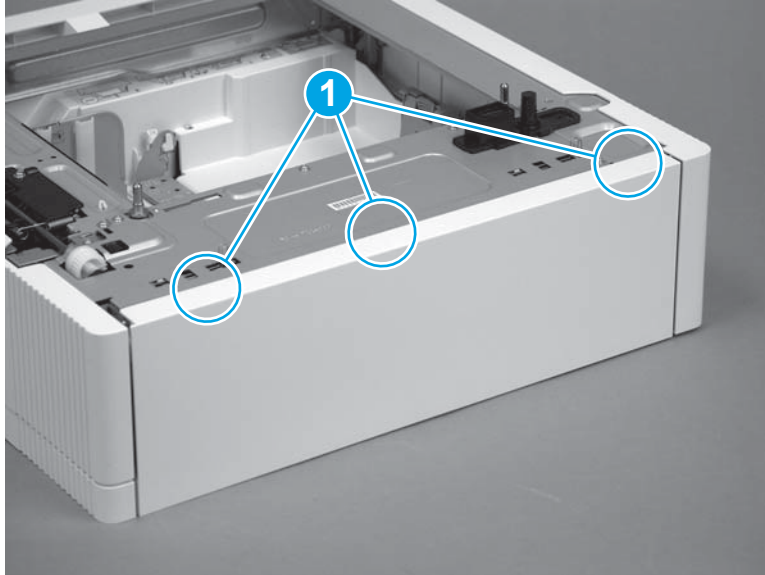

2. Rotate the top of the cover away from the accessory (callout 1), and then lift it up to remove it (callout 2).

Figure 1-5134 Remove the cover

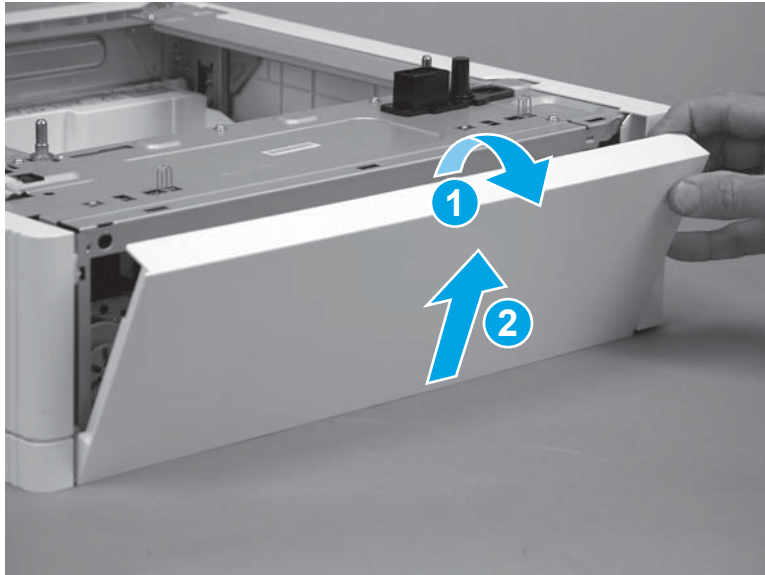

Step 3: Remove the right door

1. Open the door.

Figure 1-5135 Open the door

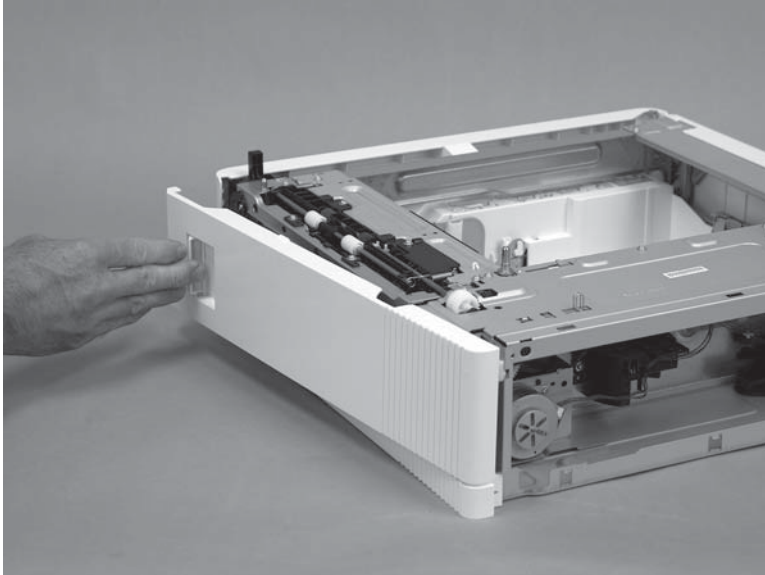

2. Release one tab (callout 1), and then slide the door-hinge bracket away from the chassis (callout 2) to release it.

Figure 1-5136 Release the hinge bracket

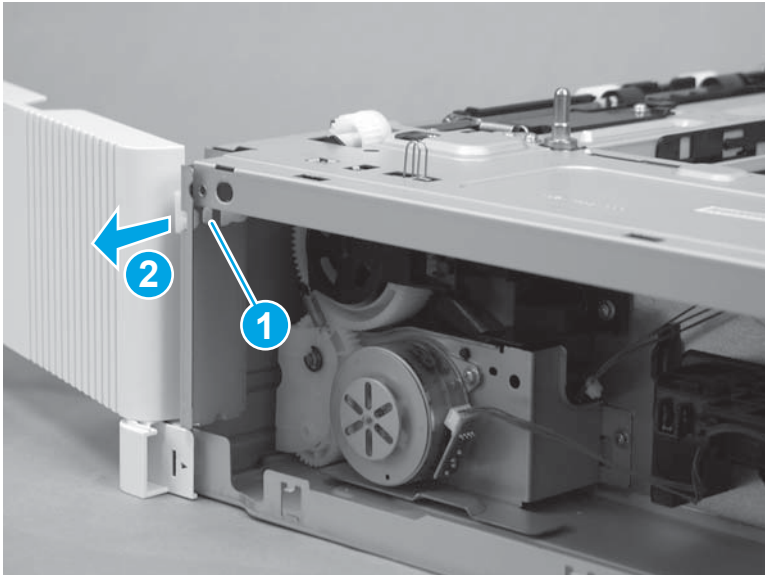

3. Remove the door-hinge bracket from the chassis.

CAUTION: The door is still attached to the accessory by the door link. Do not attempt to completely remove the door.

The door hinge bracket is not captive. Do not lose it when handling the door.

Figure 1-5137 Remove the hinge bracket

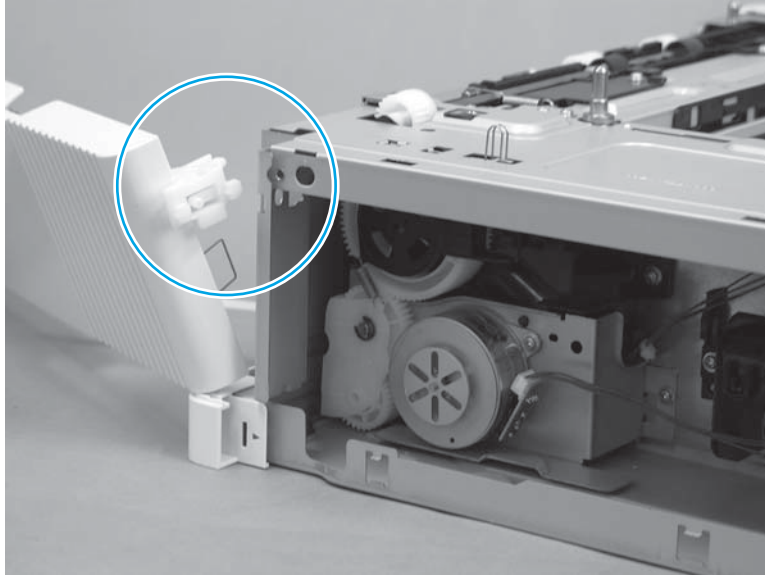

4. Release the door link from the slot in the door to remove the right door.

Figure 1-5138 Release the door link

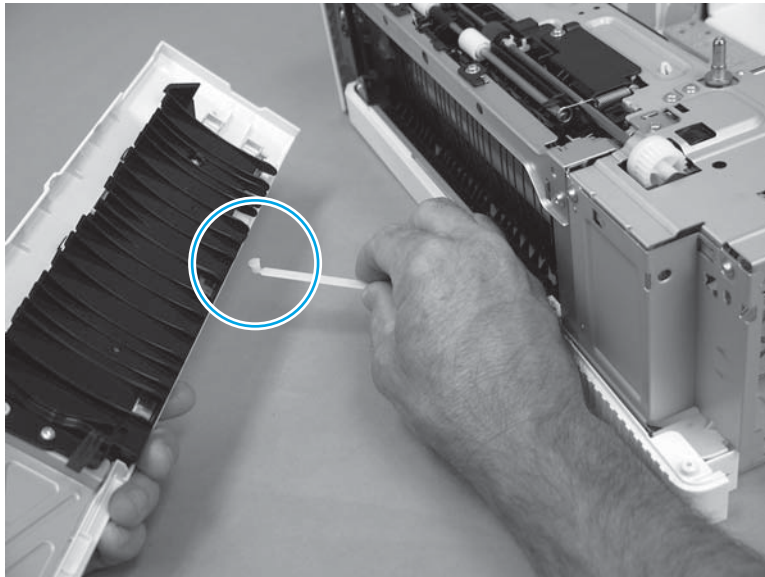

Step 4: Remove the drawer connector holder

1. Disconnect one connector (callout 1; J901).

Figure 1-5139 Disconnect one connector

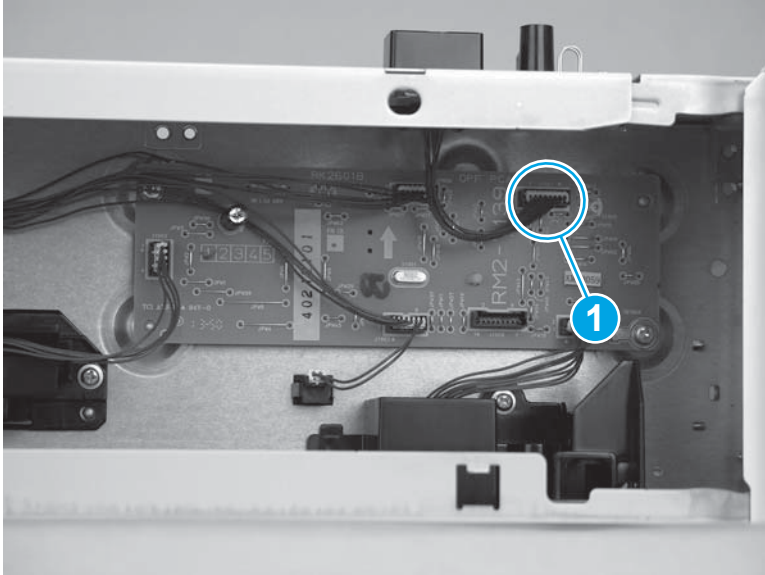

2. Release one tab (callout 1), and then slide the drawer connector holder as shown (callout 2) to release it.

Figure 1-5140 Release one tab

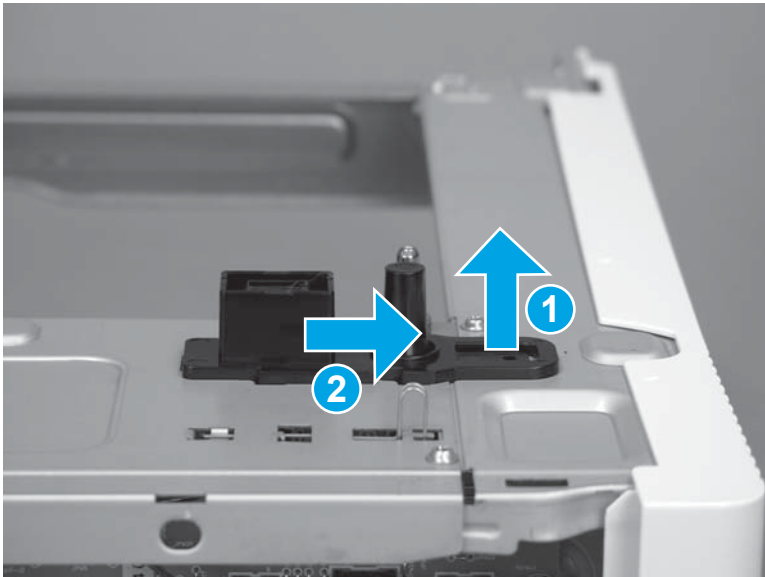

3. Remove the drawer connector holder.

Figure 1-5141 Remove the tray connector

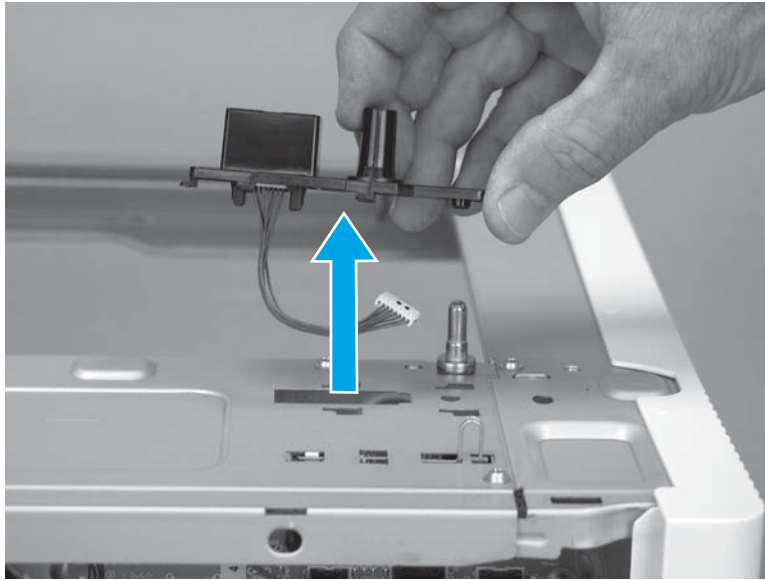

Step 5: Remove the paper feed assembly

1. Remove six screws (callout 1).

Figure 1-5142 Remove six screws

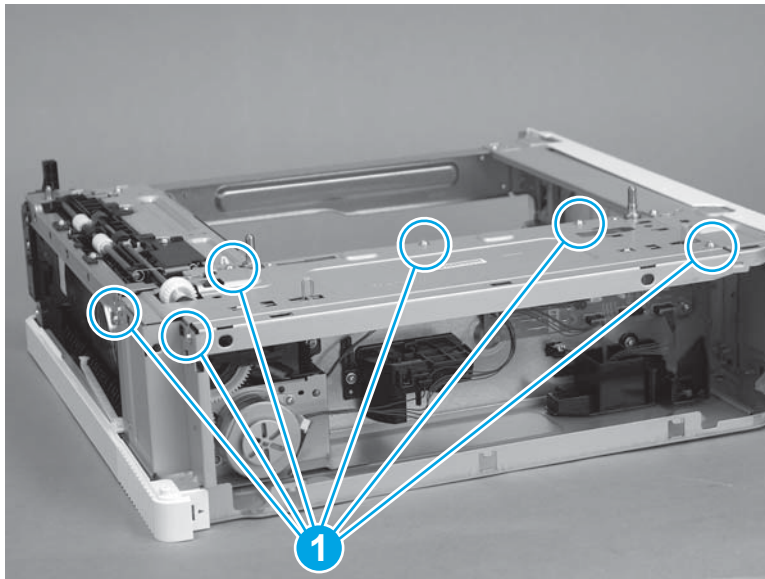

2. Remove the sheet-metal plate.

Figure 1-5143 Remove the sheet-metal plate

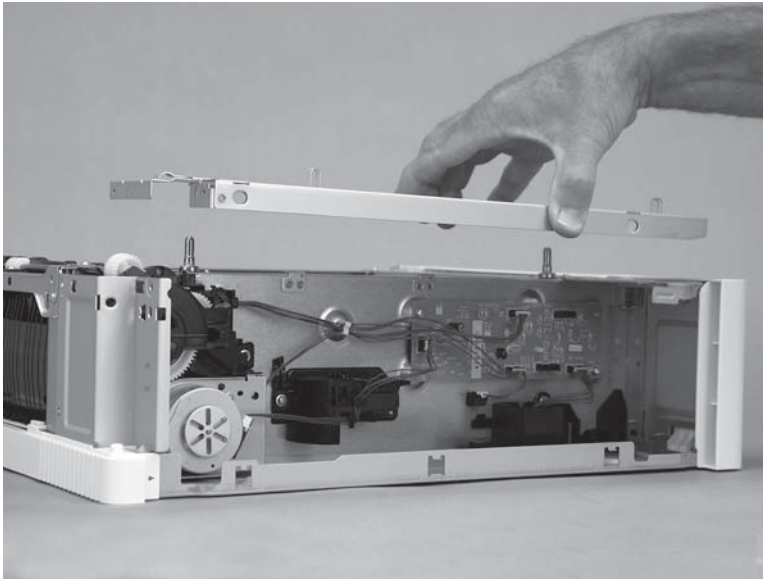

3. Release the green jam handle (callout 1), and then rotate the paper feed guide down (callout 2) and out of the way.

Figure 1-5144 Release the paper feed guide

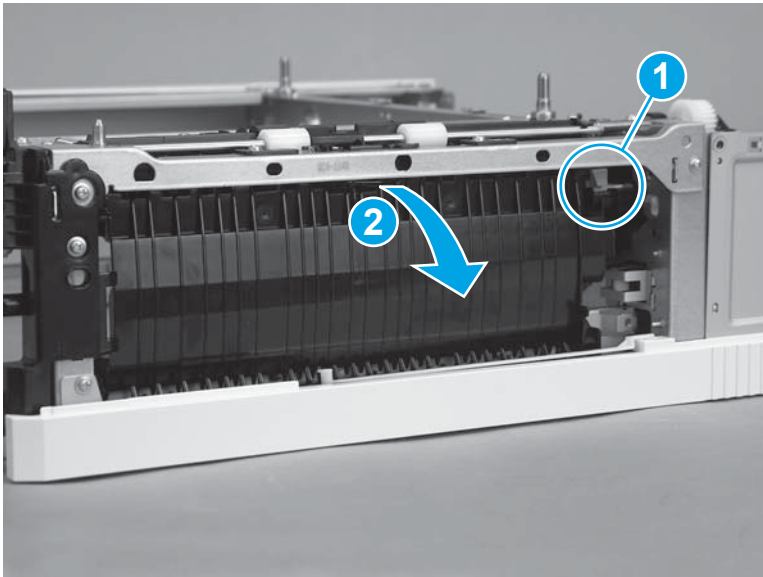

4. Remove one screw (callout 1), release one tab (callout 2), and then remove the cover (callout 3).

Figure 1-5145 Remove the cover

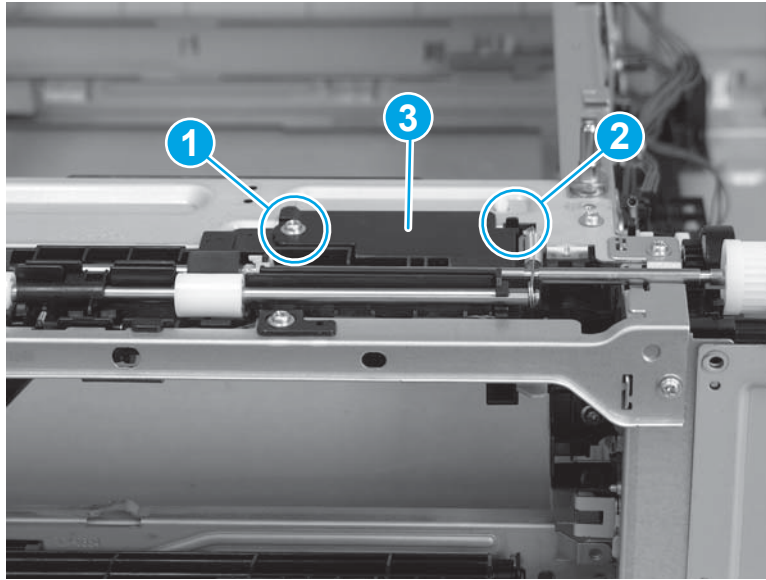

5. Disconnect one connector (callout 1).

Figure 1-5146 Disconnect one connector

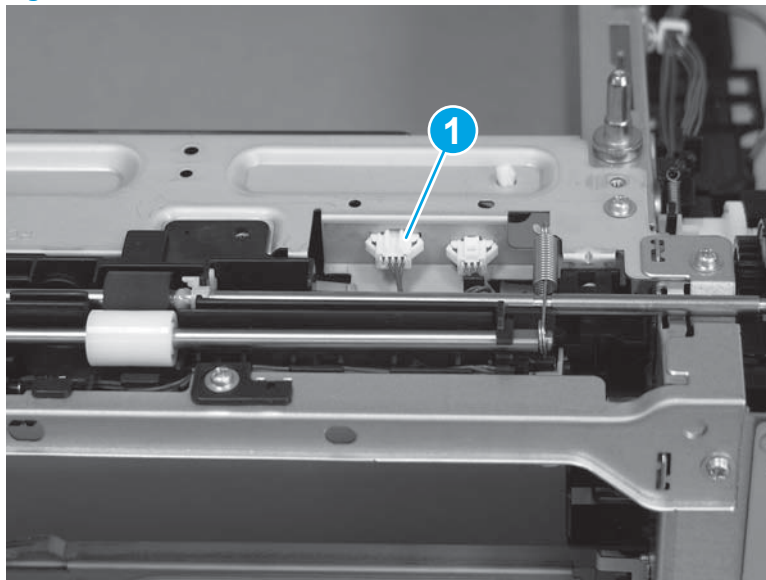

6. Remove two springs (callout 1).

Figure 1-5147 Remove two springs

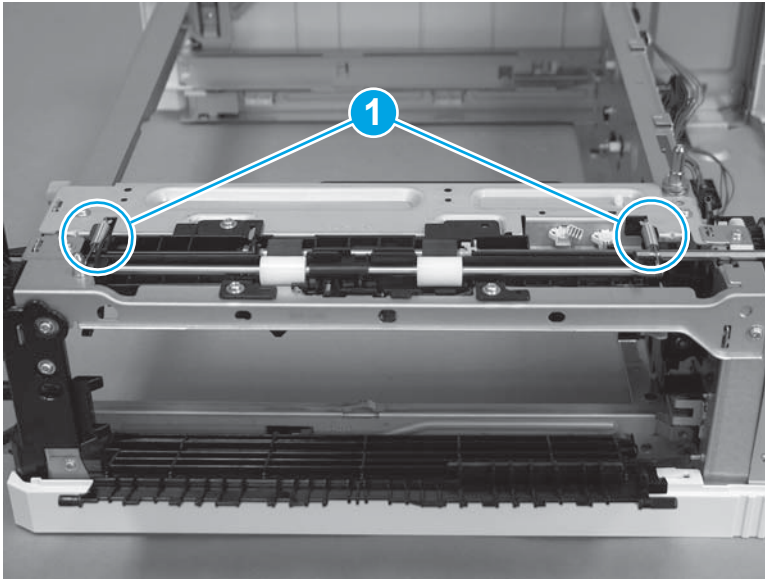

7. Remove three screws (callout 1).

Figure 1-5148 Remove three screws

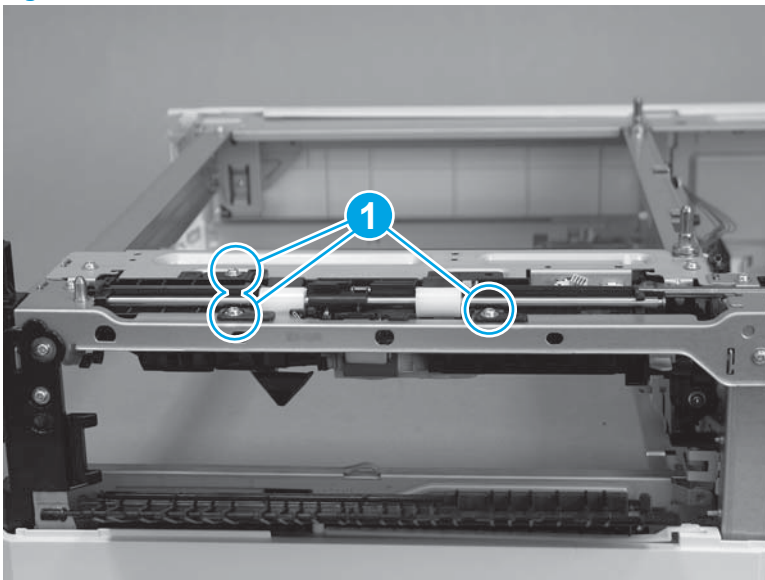

8. Slightly raise the tray end of the assembly, and then release two alignment pins (callout 1).

Figure 1-5149 Release two alignment pins

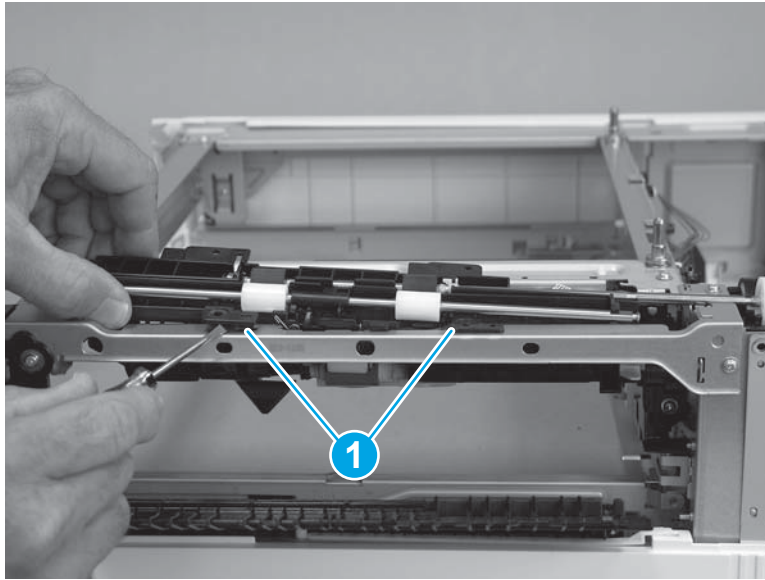

9. Release one tab on the gear (callout 1), slide the assembly away (callout 2) from the lifter drive assembly to release the shaft from the gear, and then remove the paper feed assembly.

Figure 1-5150 Remove the paper feed assembly

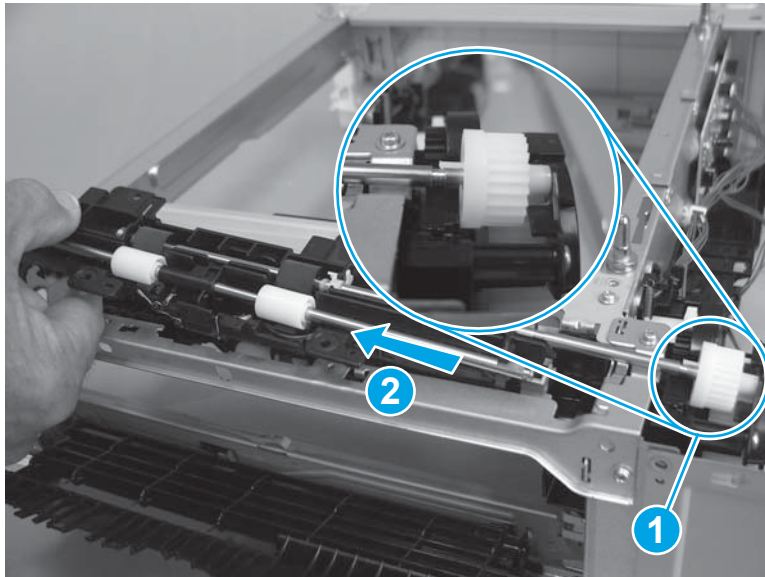

Step 6: Unpack the replacement assembly

Unpack the replacement assembly from the packaging.

For complete information on HP's recycling programs, go to [Product return and recycling](#).

 **NOTE:** HP recommends responsible disposal of the defective assembly.

Figure 1-5151 Recycle and unpack

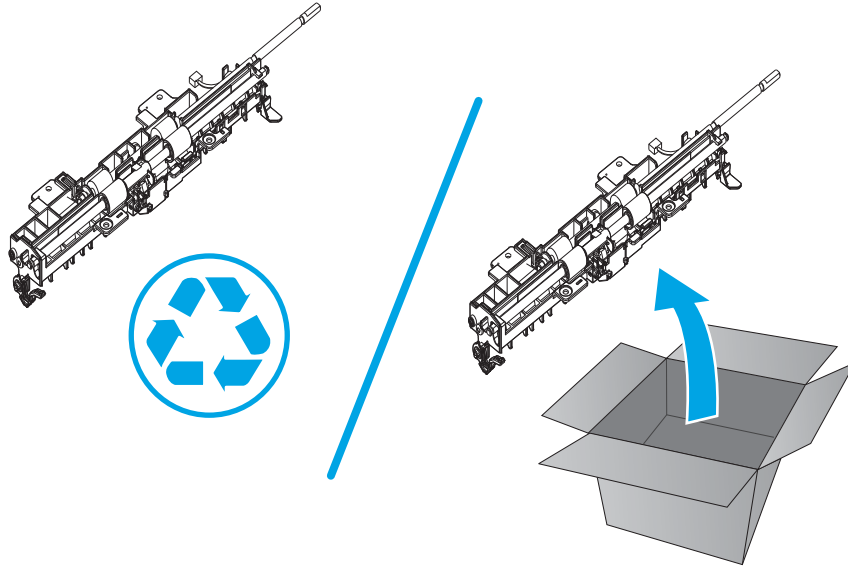

Step 7: Install the paper feed assembly

1. Be careful when handling the assembly. The left side flag (callout 1) is easily dislodged.

Figure 1-5152 Left side flag

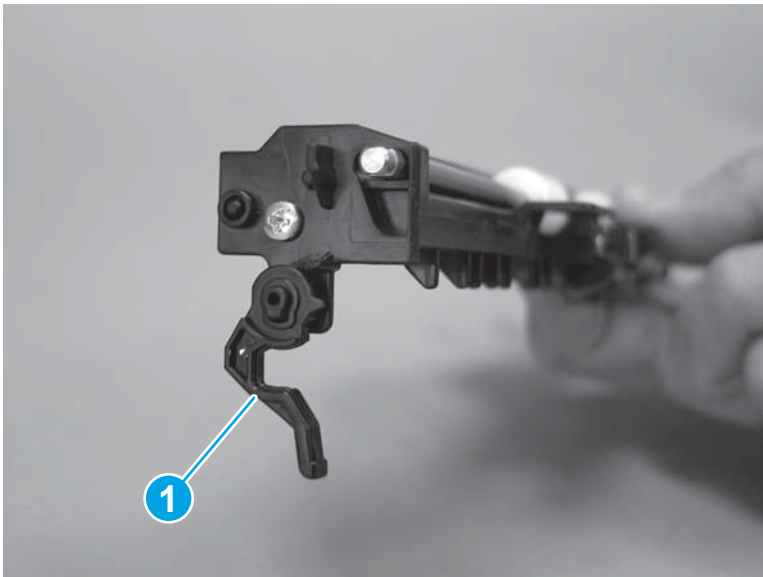

2. Insert the keyed end of the shaft (callout 1) into the gear (callout 2) on the lifter drive assembly—turn the shaft on the paper feed assembly or the gear on the lifter drive assembly to align the keyed shaft with the gear.

 **IMPORTANT:** Make sure that the tab on the gear snaps into place on the shaft.

Figure 1-5153 Install the assembly



3. Lower the tray end of the assembly into the chassis, and then make sure that the alignment pins (callout 1) are fully seated—the assembly must fit flush up against the chassis.

Figure 1-5154 Check the alignment pins

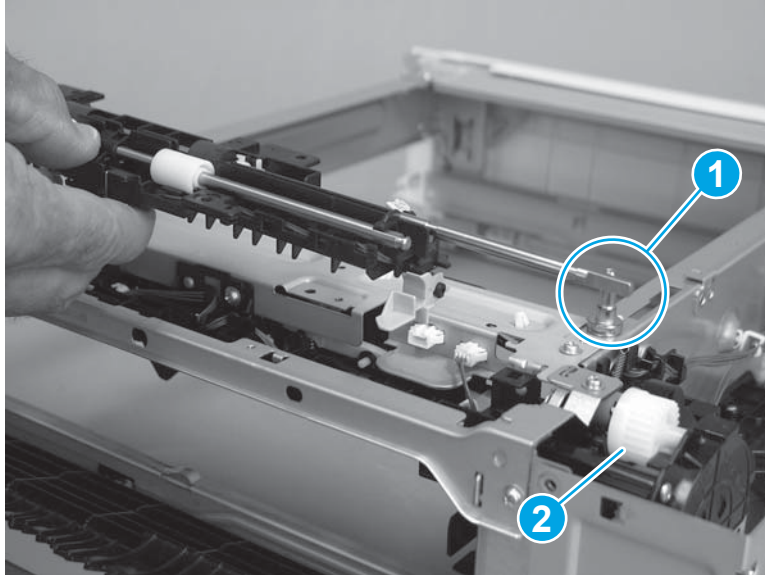
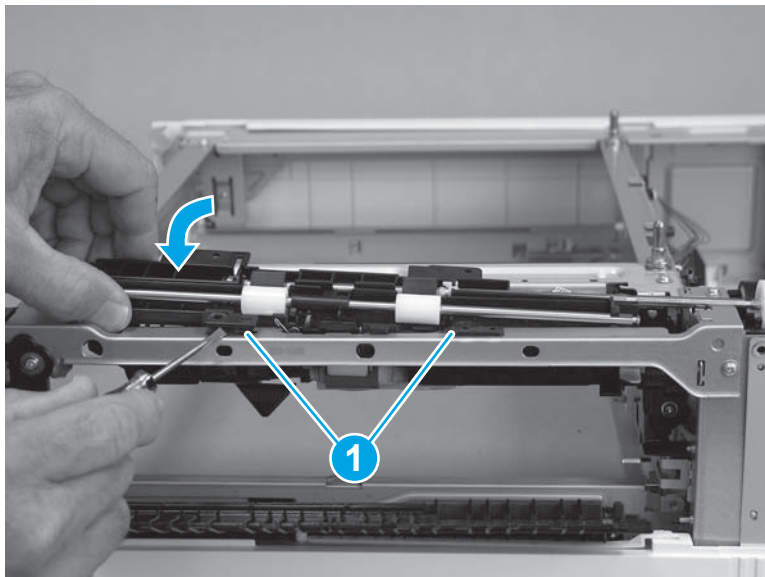

4. Install three screws (callout 1).

Figure 1-5155 Install three screws

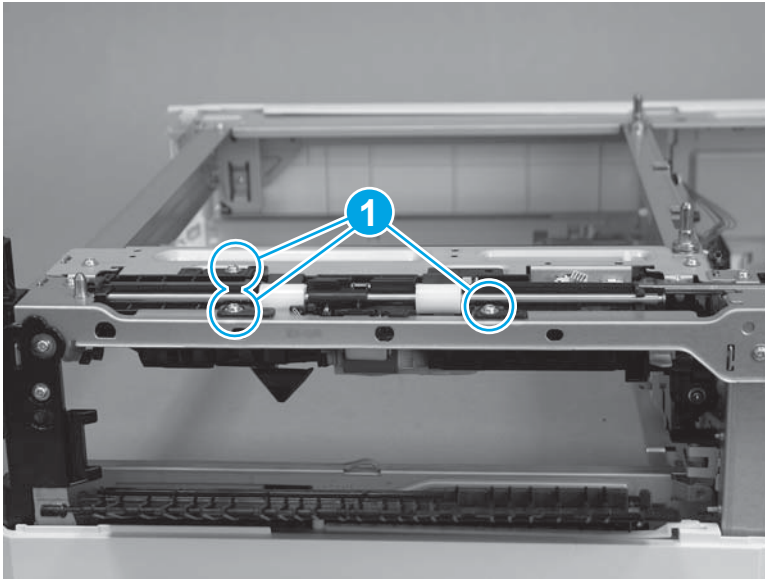

5. Install two springs (callout 1).

Figure 1-5156 Install two springs

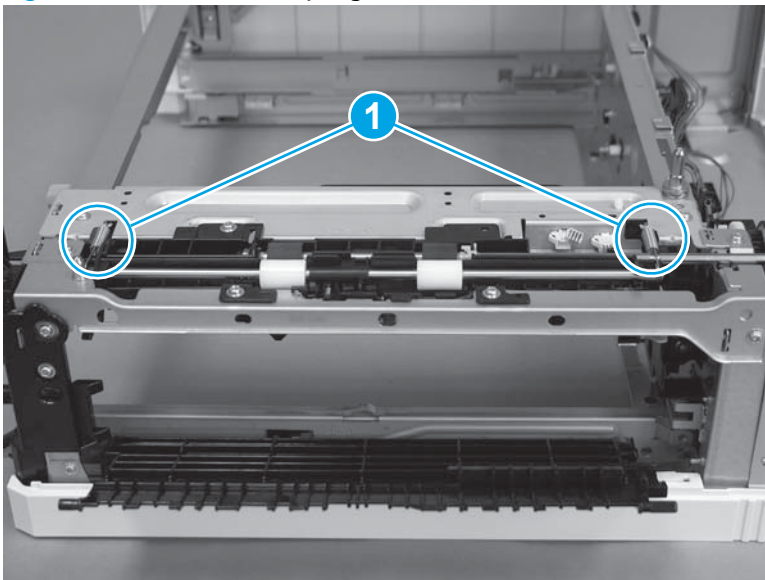

6. Connect one connector (callout 1).

Figure 1-5157 Connect one connector

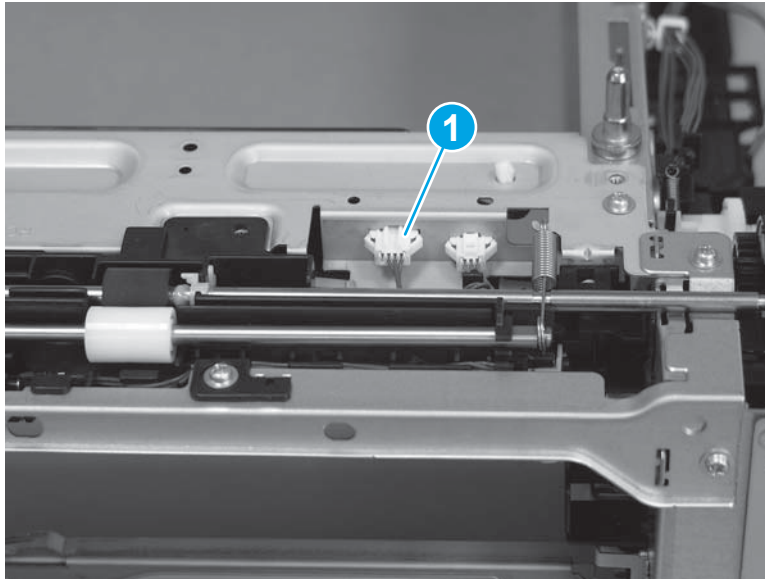

7. Position the cover (callout 1) on the chassis, make sure that the one tab (callout 2) snaps into place, and then install one screw (callout 3).

Figure 1-5158 Install the cover

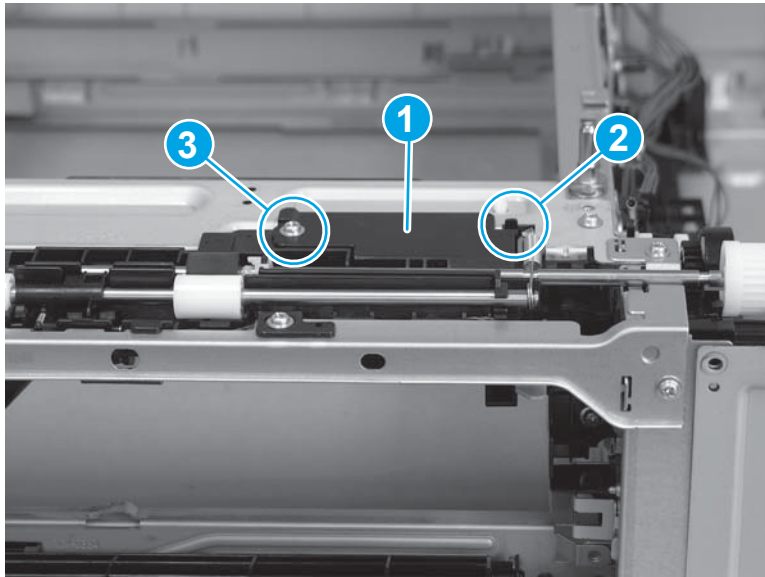

8. Rotate the paper feed guide up into position (callout 1)—the right side (green) jam handle (callout 2) automatically locks the guide in place.

Figure 1-5159 Raise the paper feed guide

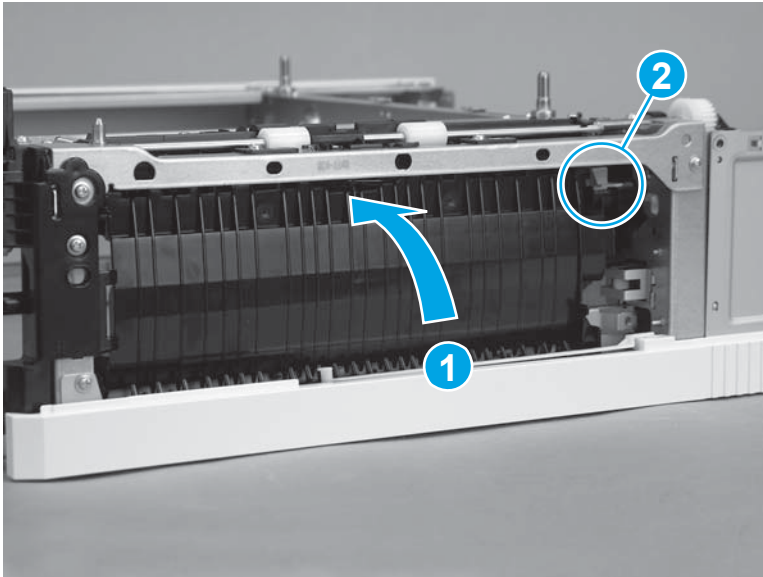

9. Position the sheet-metal plate on the chassis.

Figure 1-5160 Install the sheet-metal plate

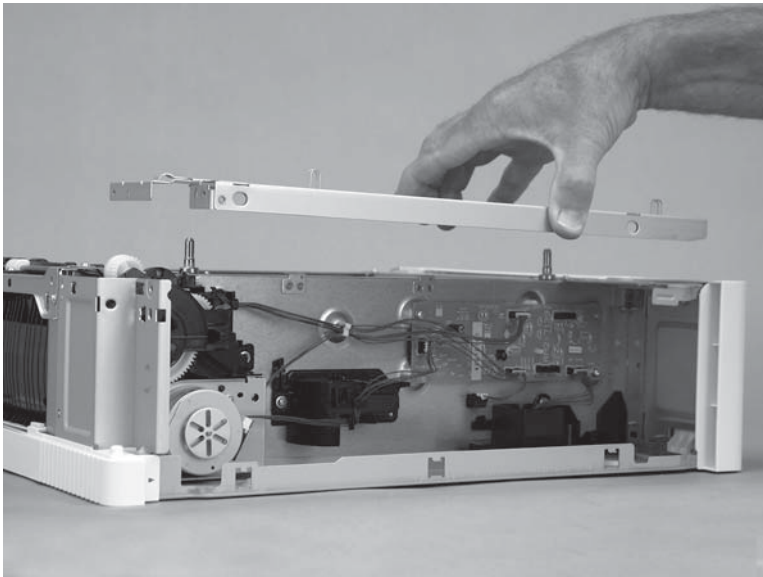

10. Install six screws (callout 1).

Figure 1-5161 Install six screws

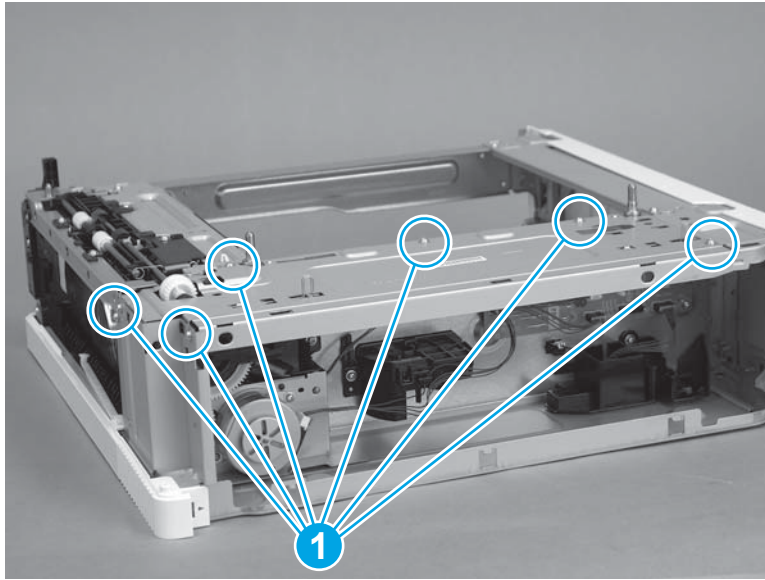

Step 8: Install the drawer connector holder

1. Position the drawer connector holder on the chassis.

 **NOTE:** Make sure that the wire harness (callout 1) was transferred from the discarded assembly to the replacement assembly.

Figure 1-5162 Place the tray connector on the accessory



2. Slide the drawer connector holder as shown (callout 1) to install it, and then make sure that one tab (callout 2) snaps into place .

Figure 1-5163 Install the tray connector

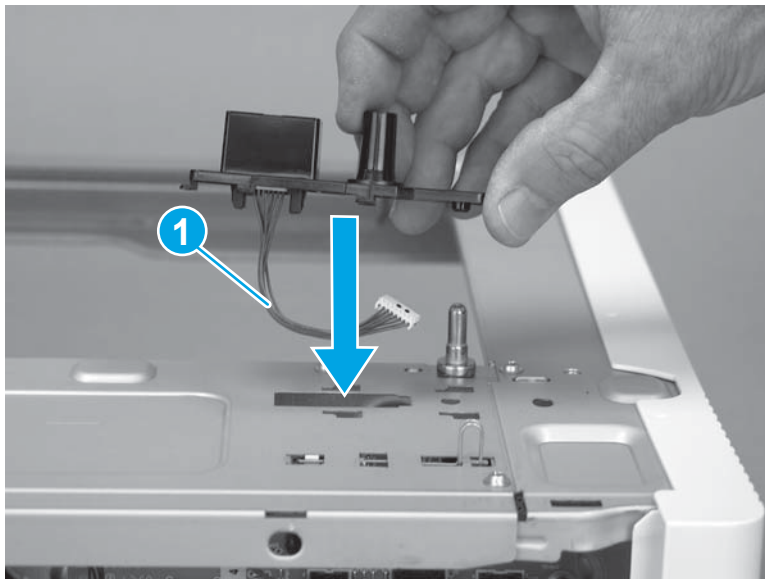
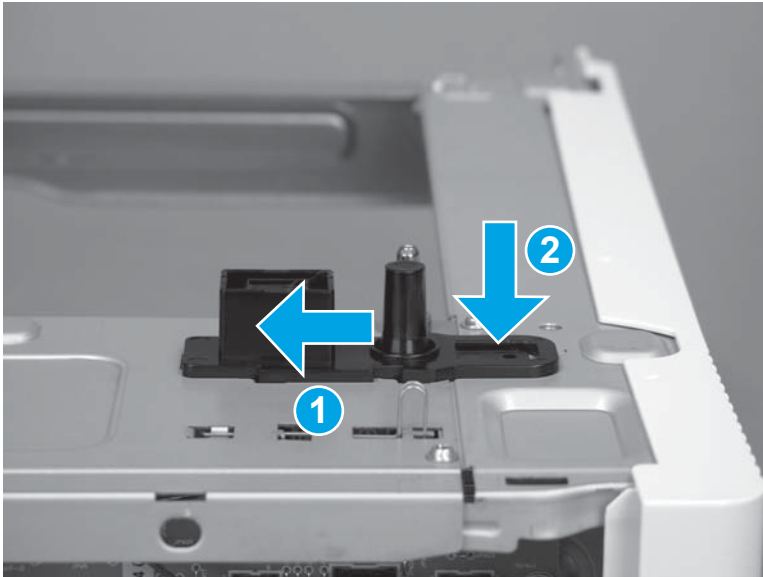

3. Connect one connector (callout 1; J901).

Figure 1-5164 Connect one connector

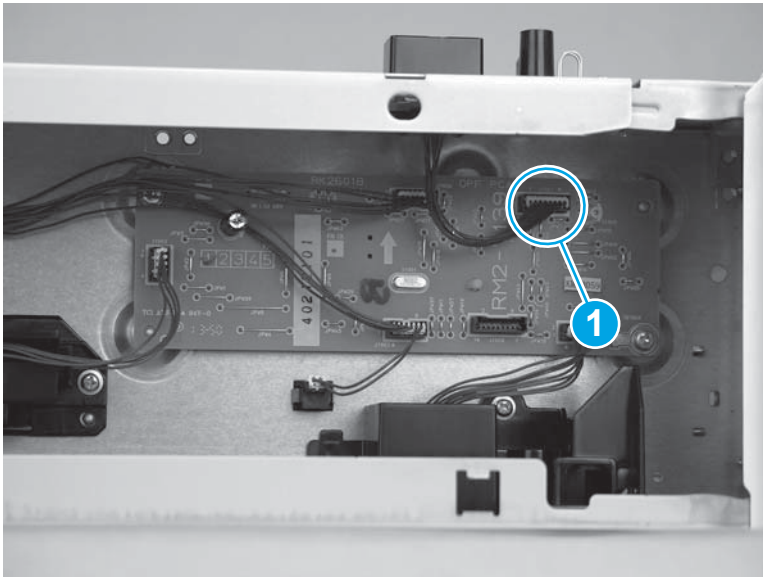

Step 9: Install the right door

1. Install the door link in the slot in the door to attach the door.

Figure 1-5165 Install the door link

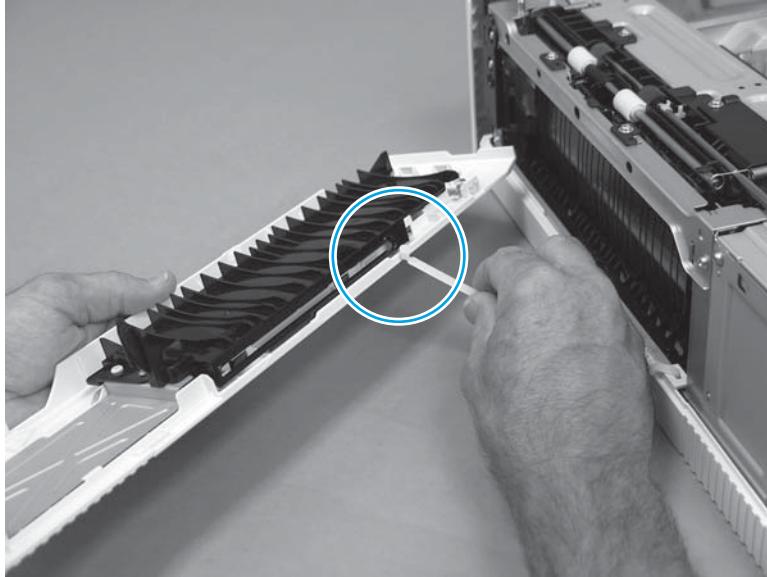

2. Position the lower hinge hole on the door (callout 2) on the lower hinge pin (callout 2) on the right-lower cover.

Figure 1-5166 Position the door on the lower hinge

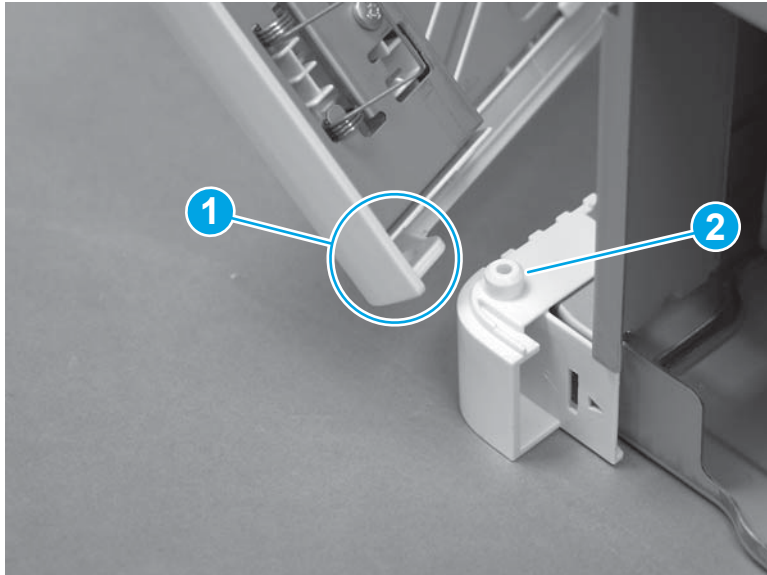

3. Align the pin of the door-hinge bracket (callout 1) with the hole in the chassis, and then align the mounting tabs (callout 2 and callout 3) with the slots in the chassis.

Figure 1-5167 Engage the hinge bracket

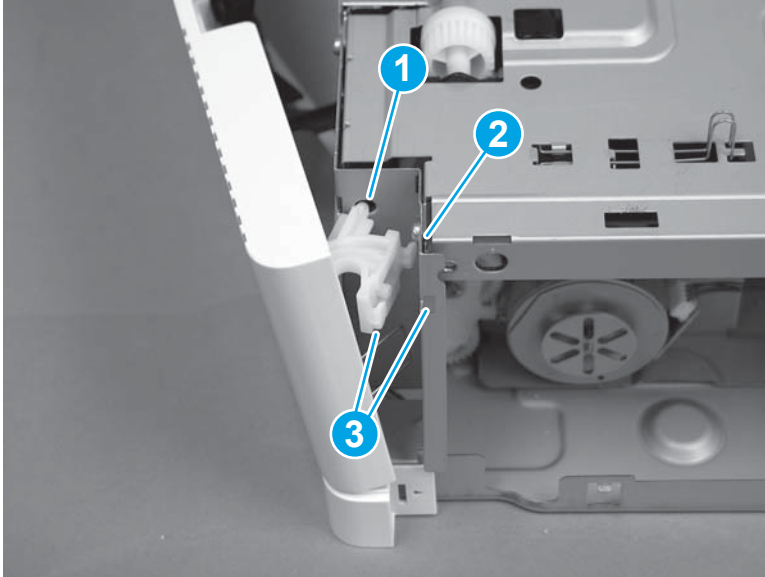

4. Push in on the door-hinge bracket (callout 1), and then slide it toward the chassis (callout 2) to install it.

Figure 1-5168 Install the hinge bracket

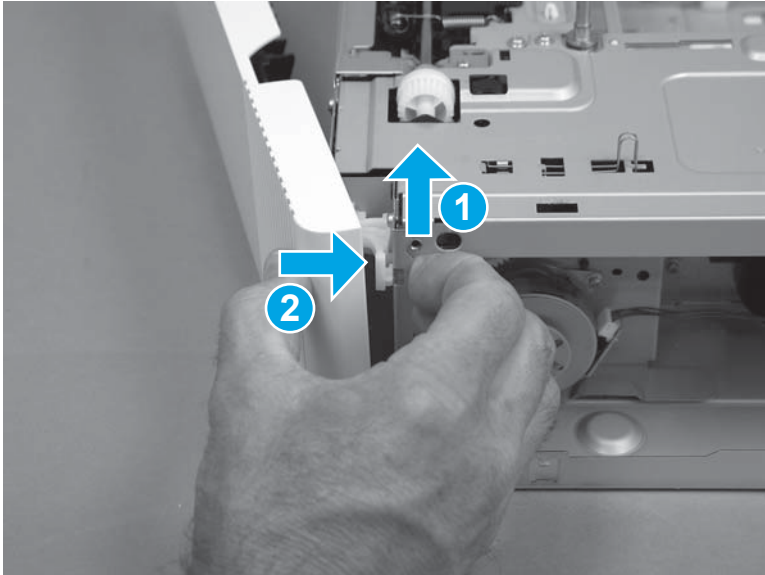

5. Close the door.

Figure 1-5169 Close the door

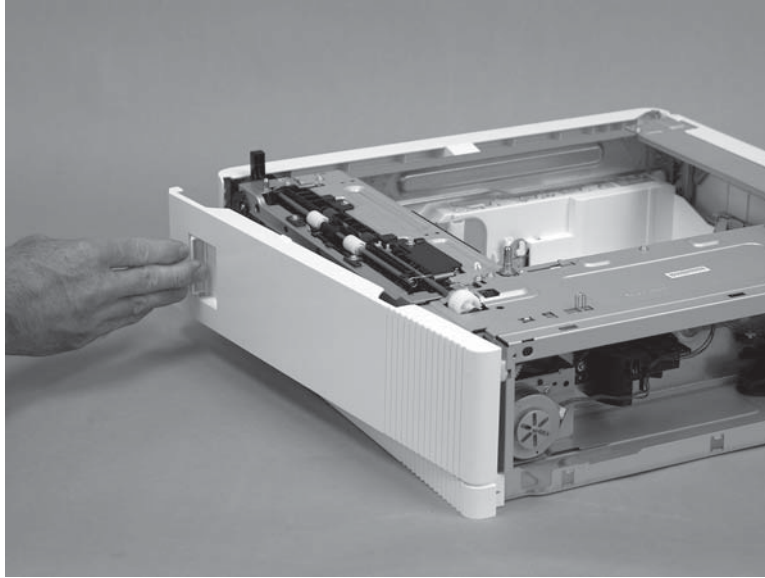

Step 10: Install the rear cover

1. Align the three mounting tabs (callout 1) on the cover with the slots in the chassis.

Figure 1-5170 Position the cover on the chassis

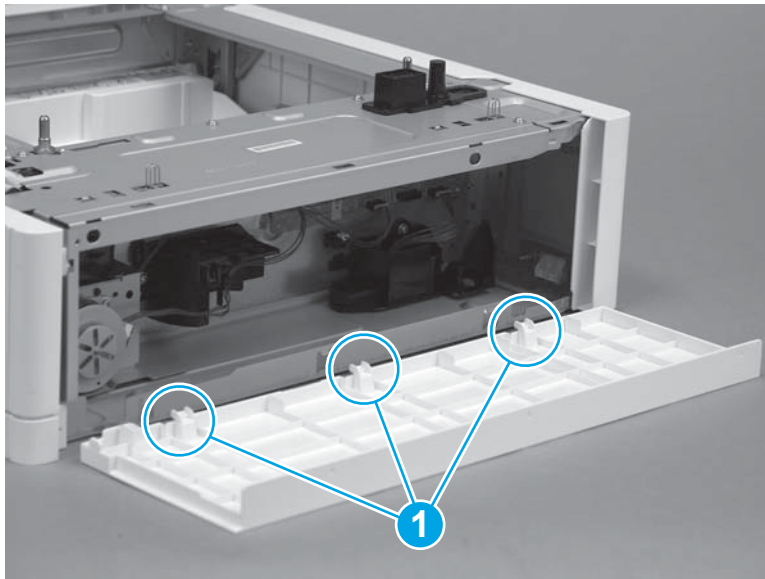

2. Position the cover on the accessory (callout 1), and then rotate the top of the cover up and onto the chassis (callout 2) to install it.

Figure 1-5171 Install the cover

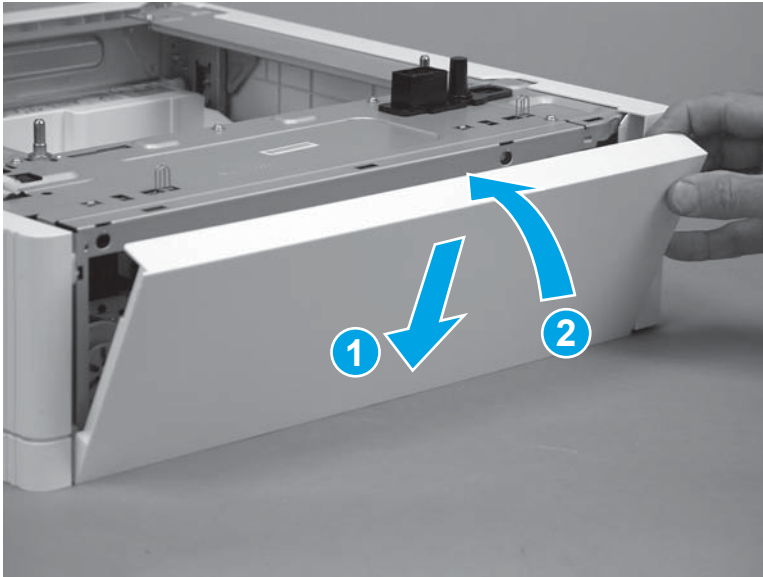

3. Make sure that the three tabs (callout 1) snap into place.

Figure 1-5172 Check the three tabs

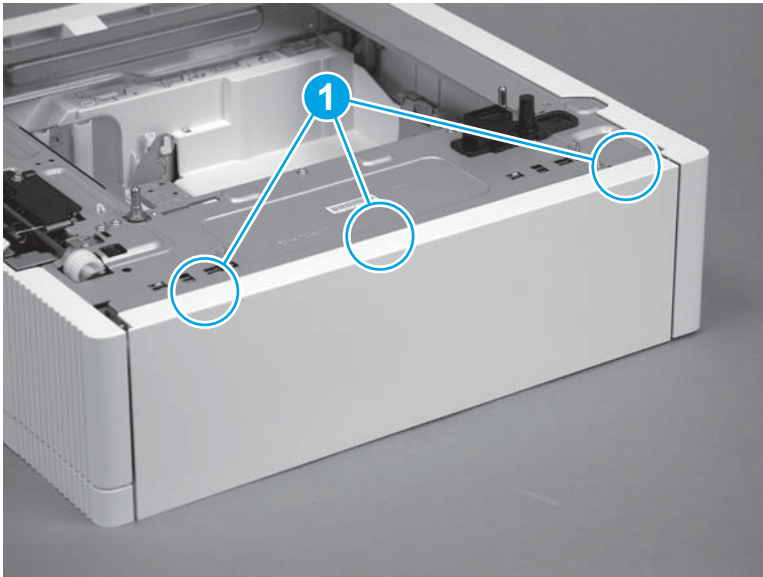

Step 11: Install the tray

1. With the front of the tray slightly lifted, align the sides of the tray with the rails in the printer, and then carefully slide the tray into the printer.

 **TIP:** As the tray slides into the accessory, lower the front of it.

Figure 1-5173 Install the tray



2. Close the tray.

Figure 1-5174 Close the tray

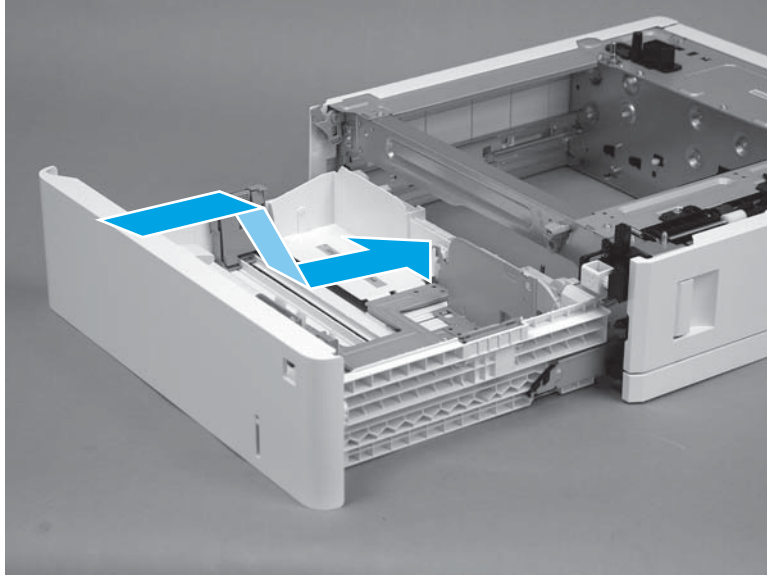
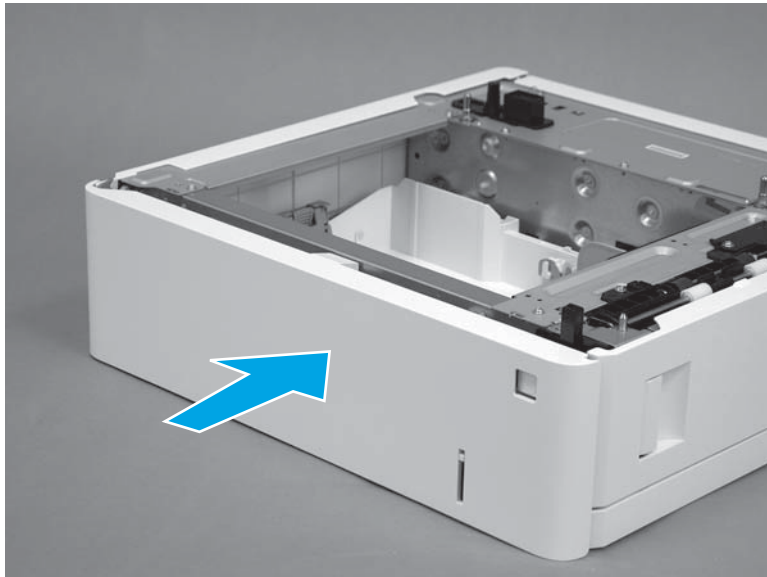

Removal and replacement: Paper pickup assembly (1x550-sheet paper feeder)

- [Introduction](#)
- [Step 1: Remove the tray](#)
- [Step 2: Remove the rear cover](#)
- [Step 3: Remove the right door](#)
- [Step 4: Remove the drawer connector holder](#)
- [Step 5: Remove the paper feed assembly](#)
- [Step 6: Remove the paper pickup assembly](#)
- [Step 7: Unpack the replacement assembly](#)
- [Step 8: Install the paper pickup assembly](#)
- [Step 9: Install the paper feed assembly](#)
- [Step 10: Install the drawer connector holder](#)
- [Step 11: Install the right door](#)
- [Step 12: Install the rear cover](#)
- [Step 13: Install the tray](#)

Introduction

This document provides the procedures to remove and replace the 1x550-sheet paper feeder paper pickup assembly.

Before performing service

Use the table below to identify the correct part number for your printer, and then go to <http://h20141.www2.hp.com/hpparts> to order the part.

Paper pickup assembly (1x550-sheet paper feeder) part number	
RM2-5154-000CN	Paper pickup assembly (1x550-sheet paper feeder)

NOTE: The tray pickup and separation roller assembly is included with the paper pickup assembly.

Required tools

- #2 Phillips screwdriver with a magnetic tip and a 152-mm (6-in) shaft length
- Small, flat-blade screwdriver

After performing service

Make sure that the rear cover is flush against the chassis after replacing it.

Make sure that the right door latches correctly when closed after replacing it.

Make sure that the tray is fully closed after replacing it.

Post service test

Print a page from a host computer using the appropriate tray as the source tray.

Step 1: Remove the tray

1. Pull the tray out until it stops.

Figure 1-5175 Pull the tray out

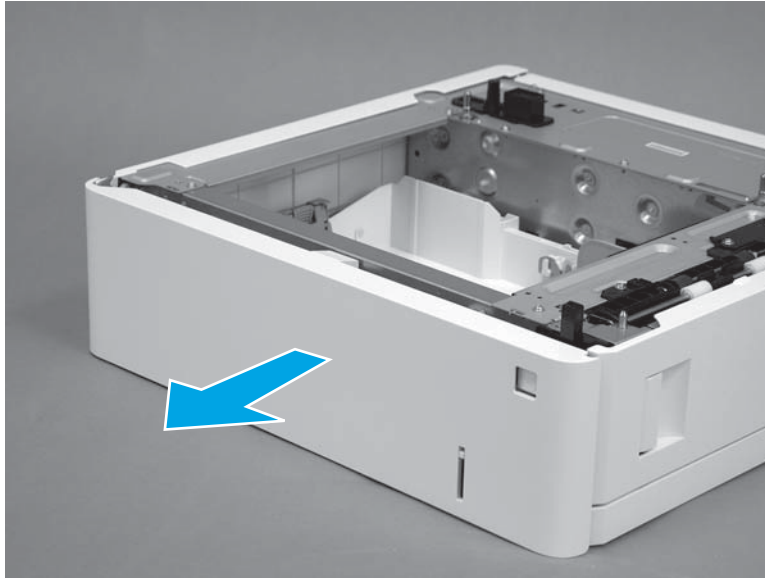

2. Lift the front of the tray, and then pull it out of the printer to remove it.

Figure 1-5176 Remove the tray

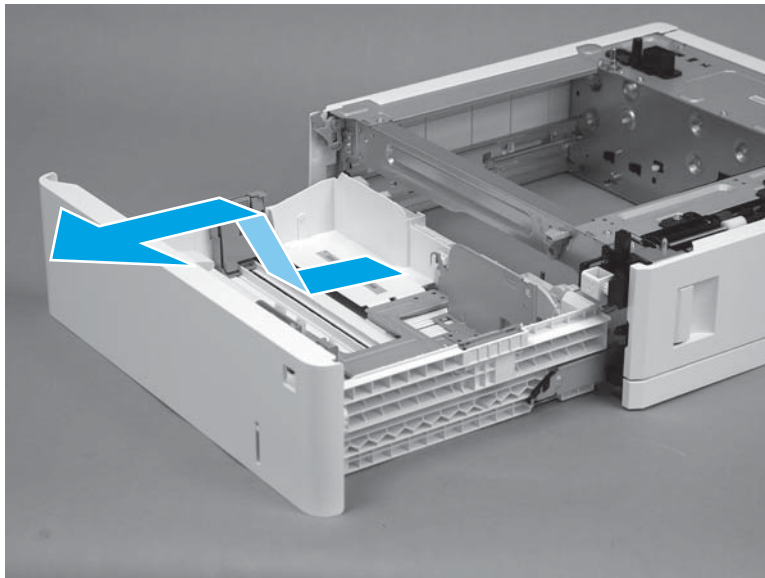

Step 2: Remove the rear cover

1. Release three tabs (callout 1).

Figure 1-5177 Release three tabs

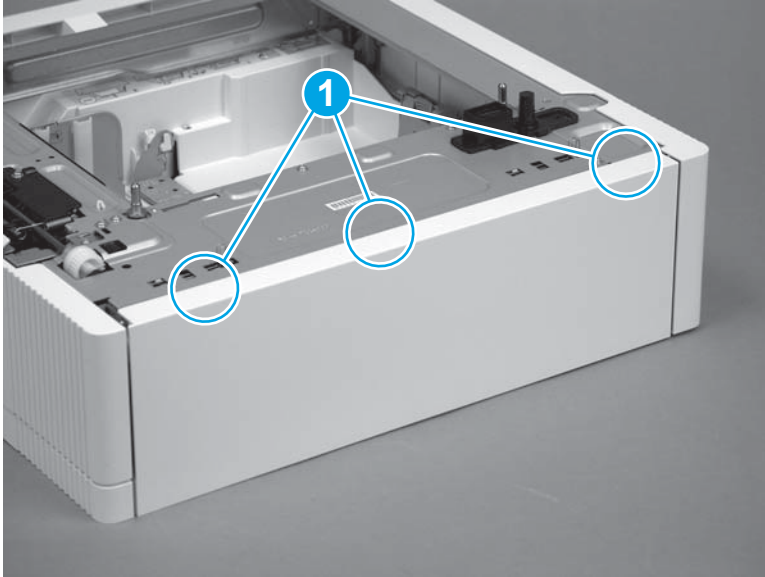

2. Rotate the top of the cover away from the accessory (callout 1), and then lift it up to remove it (callout 2).

Figure 1-5178 Remove the cover

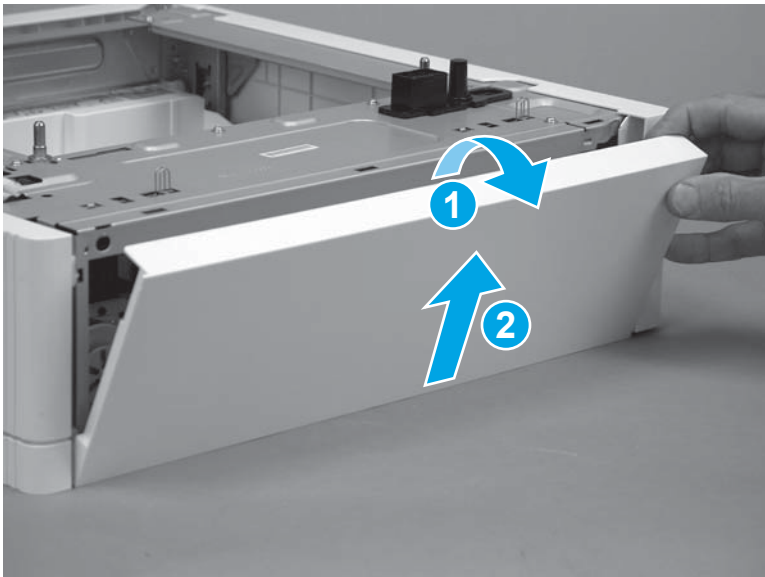

Step 3: Remove the right door

1. Open the door.

Figure 1-5179 Open the door

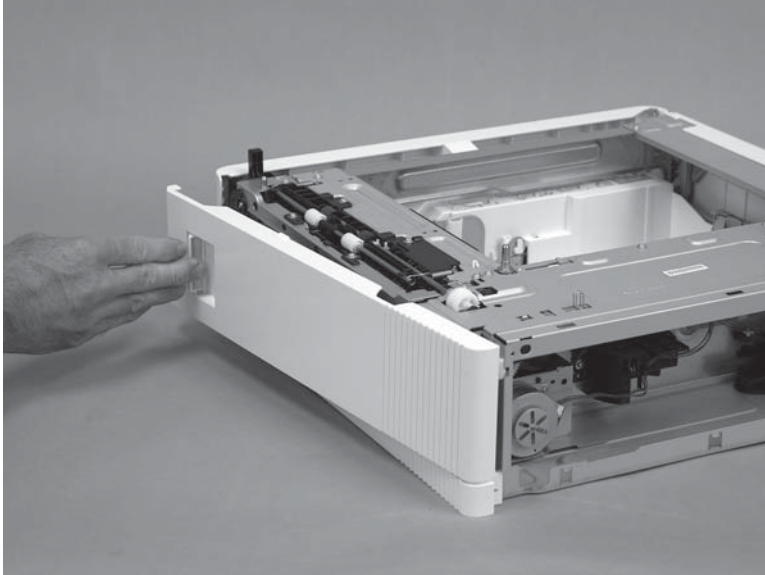

2. Release one tab (callout 1), and then slide the door-hinge bracket away from the chassis (callout 2) to release it.

Figure 1-5180 Release the hinge bracket

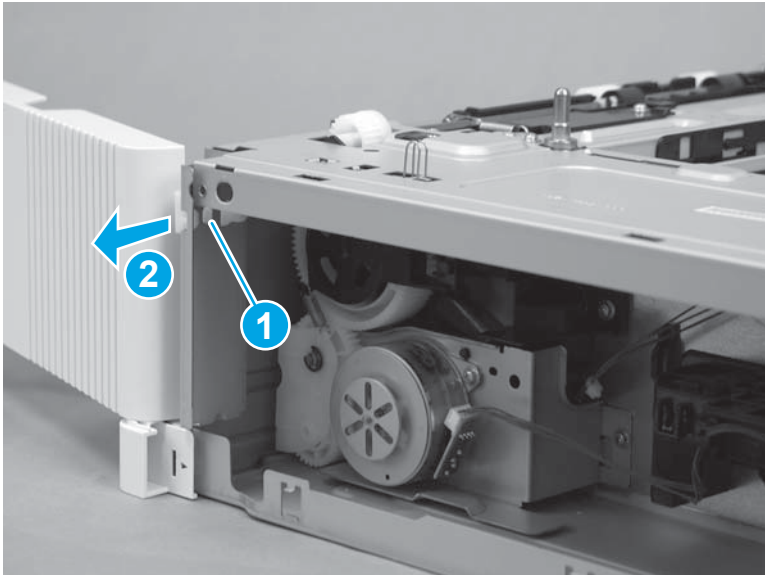

3. Remove the door-hinge bracket from the chassis.

⚠ CAUTION: The door is still attached to the accessory by the door link. Do not attempt to completely remove the door.

The door hinge bracket is not captive. Do not lose it when handling the door.

Figure 1-5181 Remove the hinge bracket

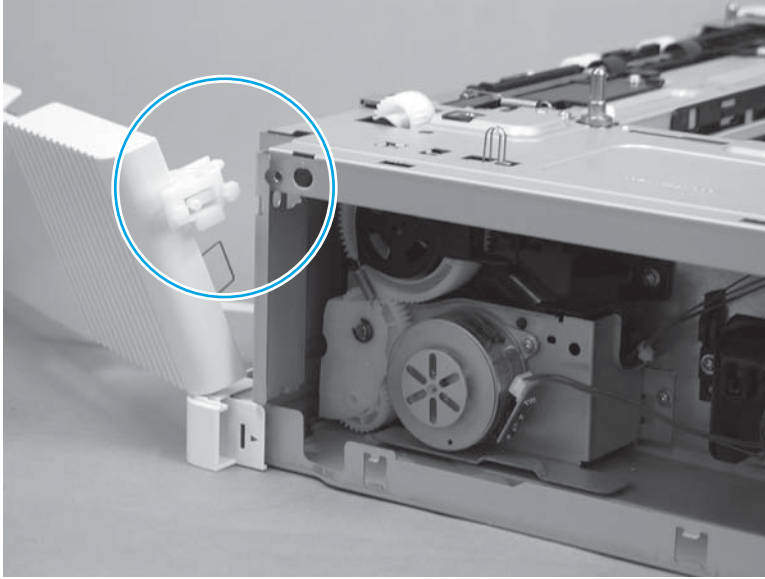

4. Release the door link from the slot in the door to remove the right door.

Figure 1-5182 Release the door link

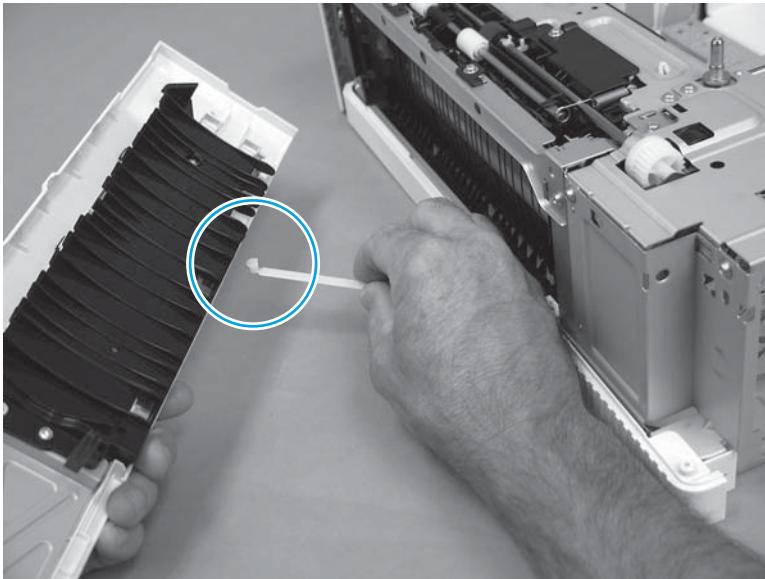

Step 4: Remove the drawer connector holder

1. Disconnect one connector (callout 1; J901).

Figure 1-5183 Disconnect one connector

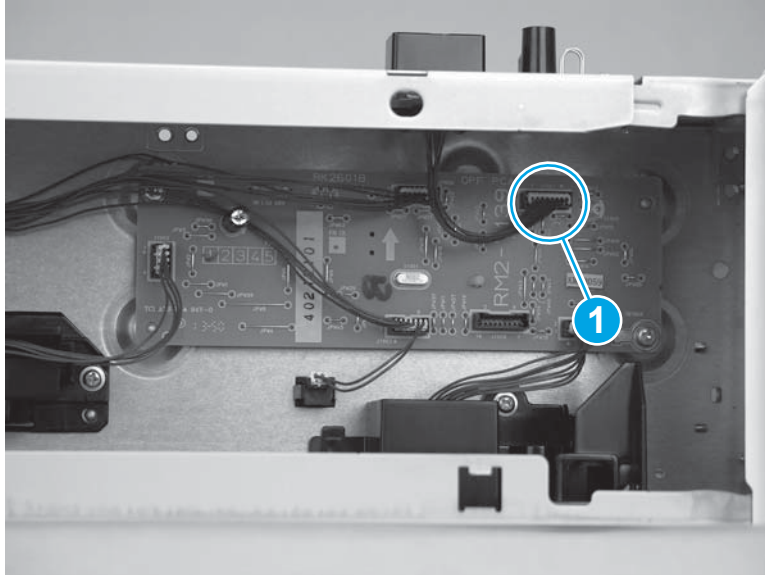

2. Release one tab (callout 1), and then slide the drawer connector holder as shown (callout 2) to release it.

Figure 1-5184 Release one tab

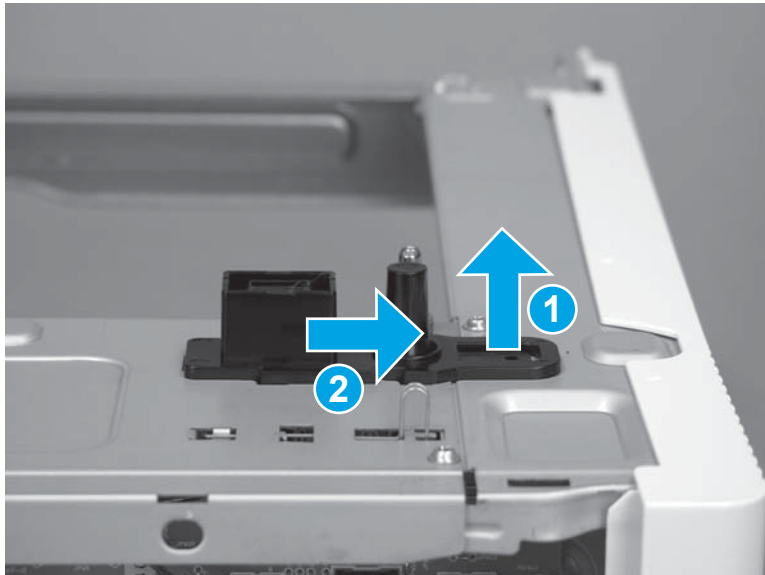

3. Remove the drawer connector holder.

Figure 1-5185 Remove the tray connector

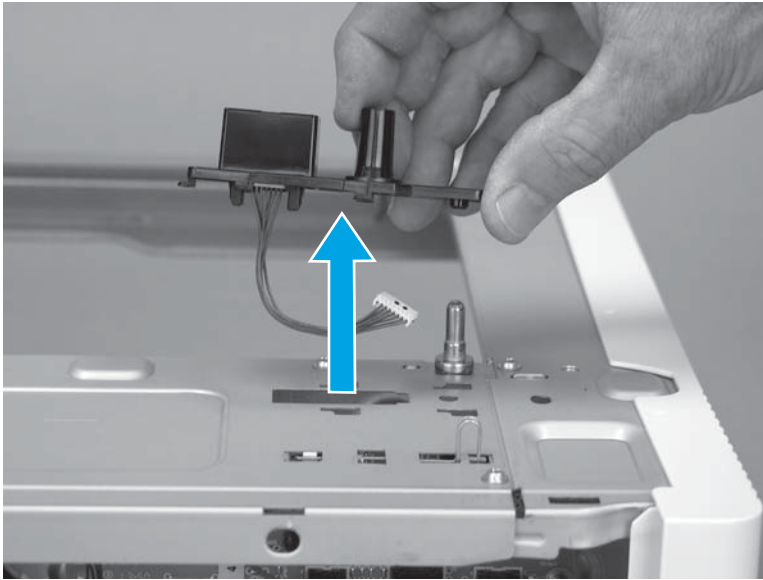

Step 5: Remove the paper feed assembly

1. Remove six screws (callout 1).

Figure 1-5186 Remove six screws

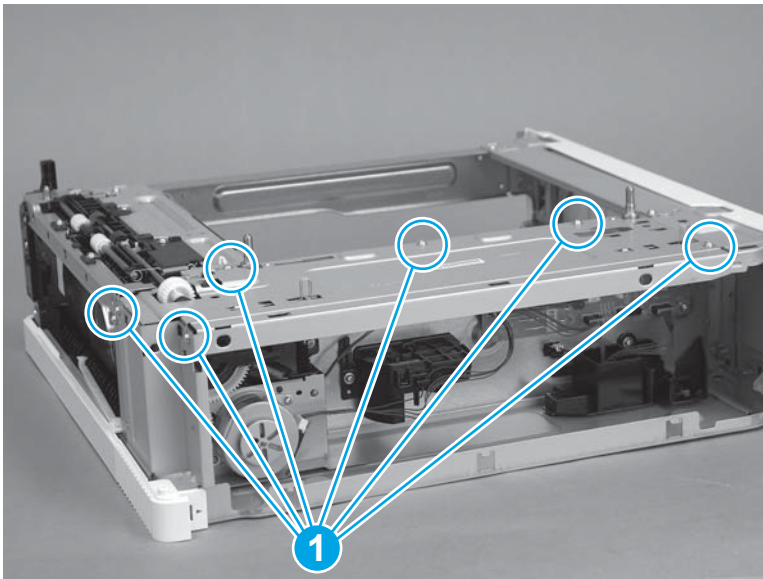

2. Remove the sheet-metal plate.

Figure 1-5187 Remove the sheet-metal plate

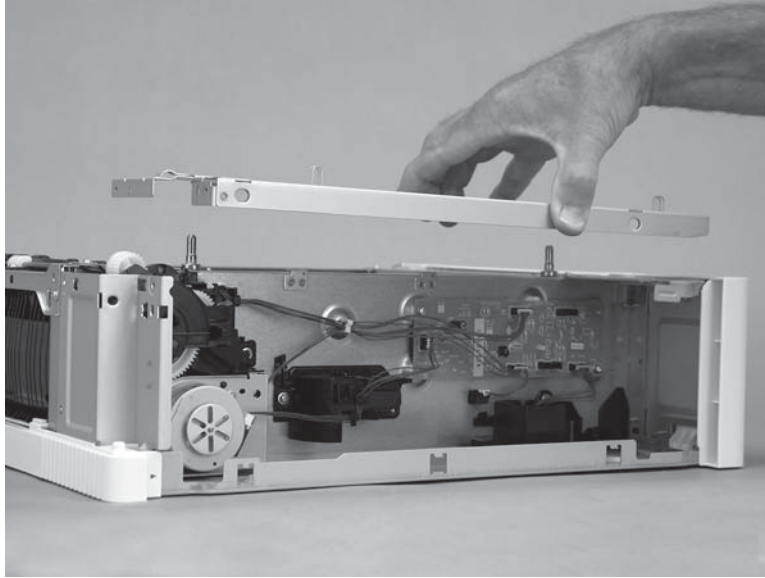

3. Release the green jam handle (callout 1), and then rotate the paper feed guide down (callout 2) and out of the way.

Figure 1-5188 Release the paper feed guide

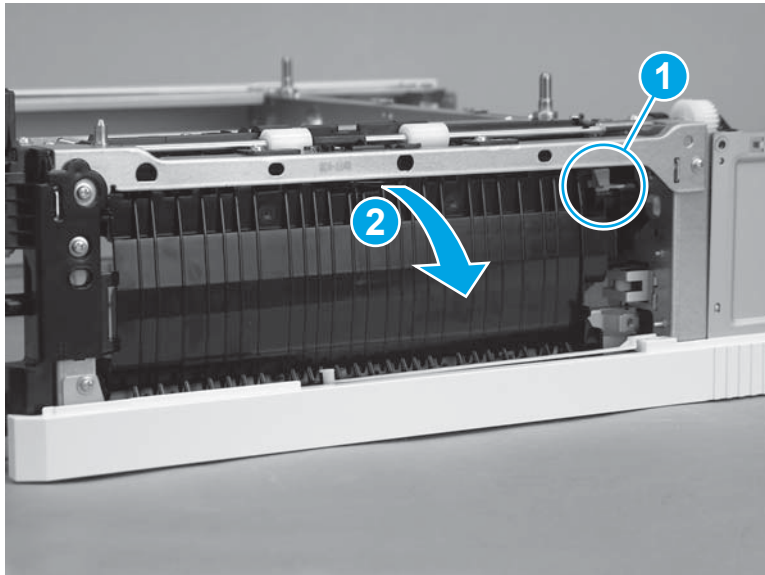

4. Remove one screw (callout 1), release one tab (callout 2), and then remove the cover (callout 3).

Figure 1-5189 Remove the cover

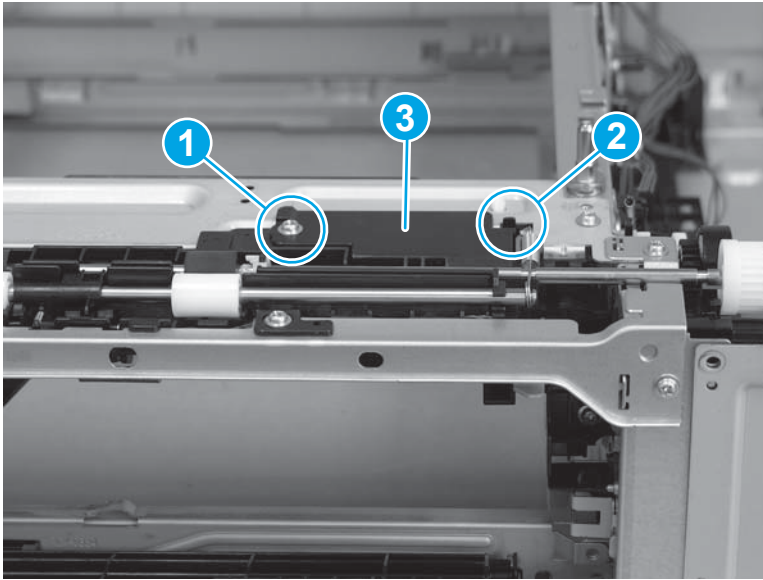

5. Disconnect one connector (callout 1).

Figure 1-5190 Disconnect one connector

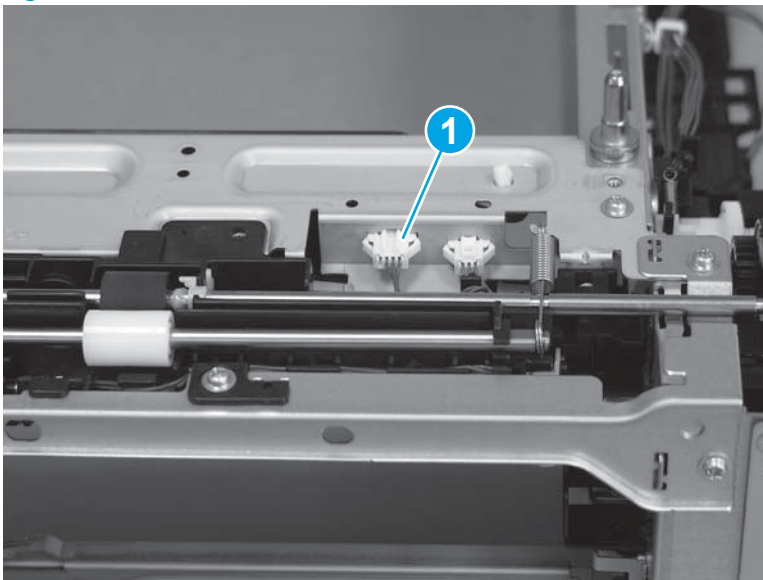

6. Remove two springs (callout 1).

Figure 1-5191 Remove two springs

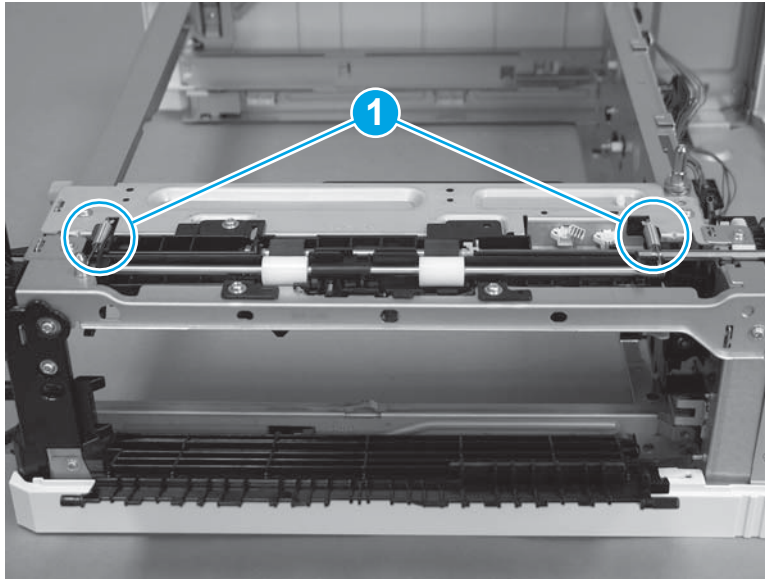

7. Remove three screws (callout 1).

Figure 1-5192 Remove three screws

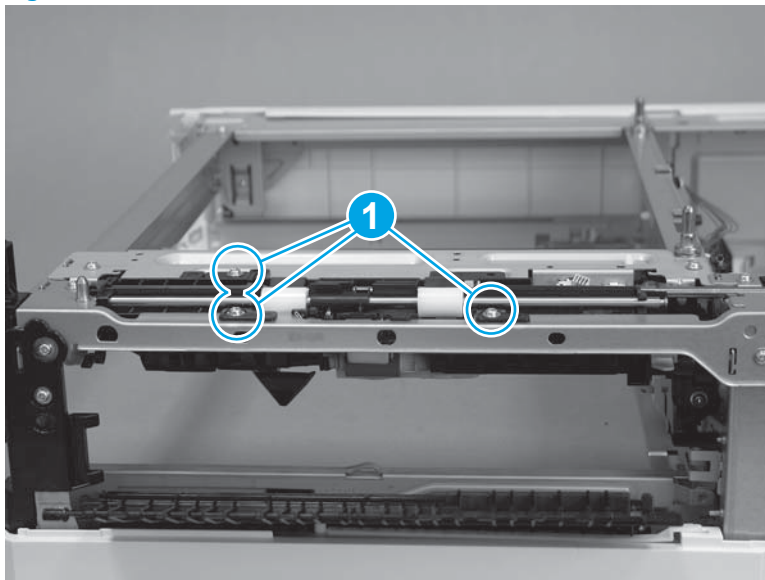

8. Slightly raise the tray end of the assembly, and then release two alignment pins (callout 1).

Figure 1-5193 Release two alignment pins

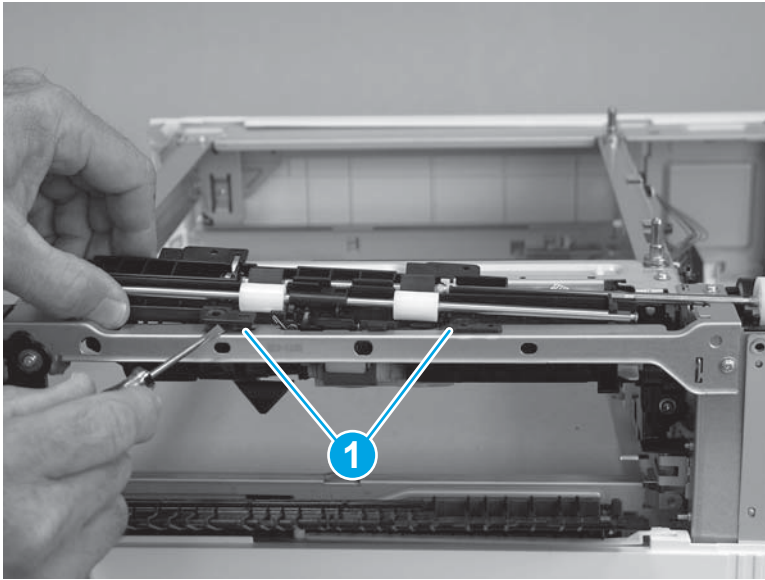

9. Release one tab on the gear (callout 1), slide the assembly away (callout 2) from the lifter drive assembly to release the shaft from the gear, and then remove the paper feed assembly.

Figure 1-5194 Remove the paper feed assembly

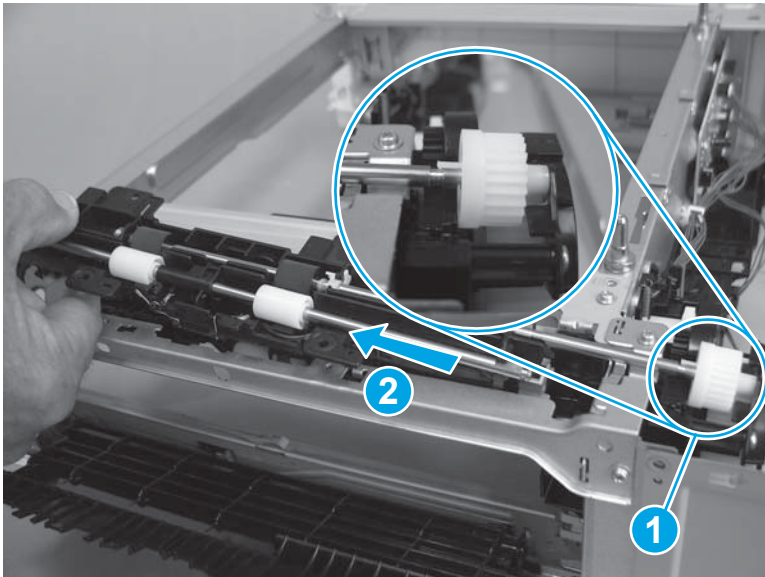

Step 6: Remove the paper pickup assembly

1. Disconnect one connector (callout 1).

Figure 1-5195 Disconnect one connector

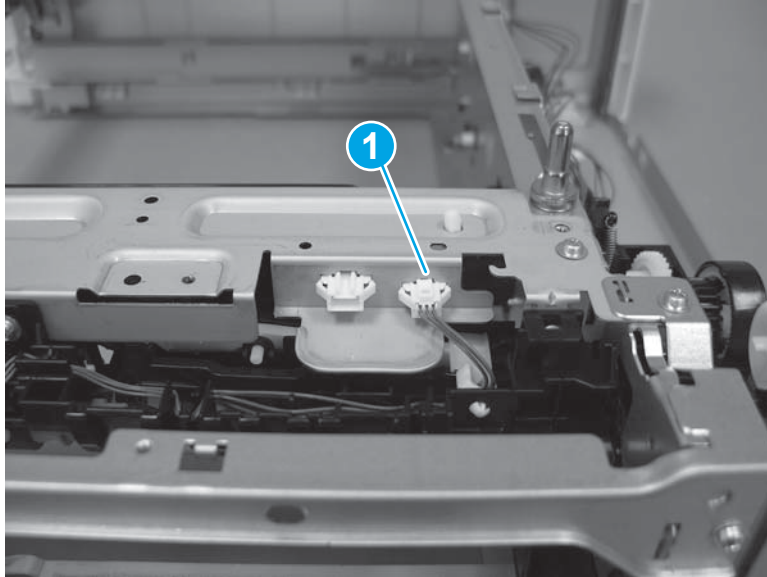

2. Remove three screws (callout 1).

Figure 1-5196 Remove three screws

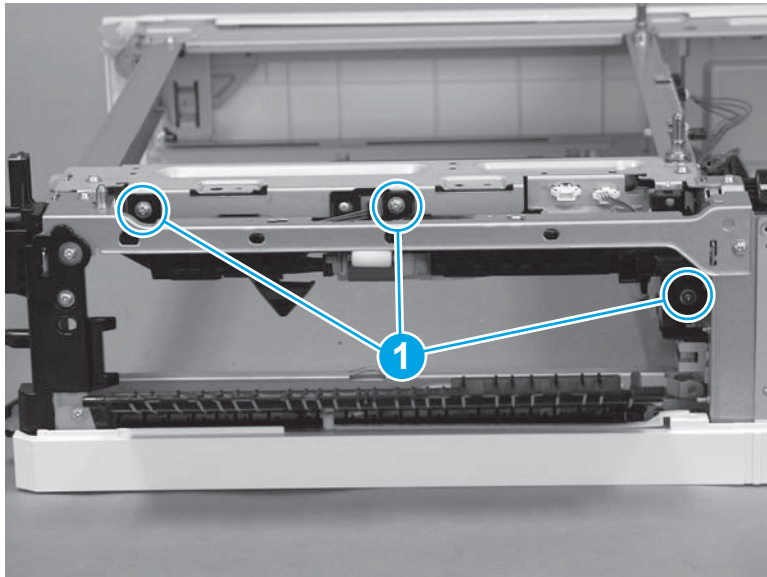

3. Release one alignment pins (callout 1), and then lower the left end of the assembly (callout 2)—the end near the tray cavity.

Figure 1-5197 Lower the end of the assembly

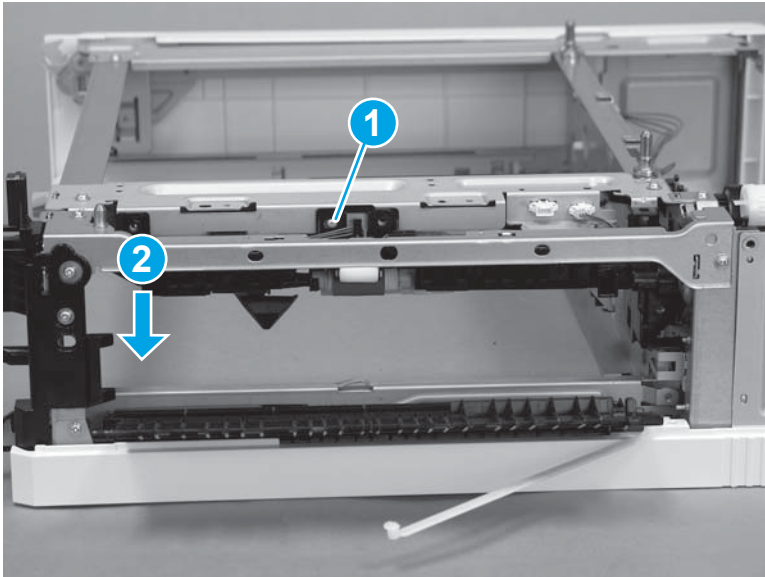

4. Slide the paper pickup assembly to the left to release it from the drive gear on the lifter drive assembly.

Figure 1-5198 Release the assembly from the drive gear

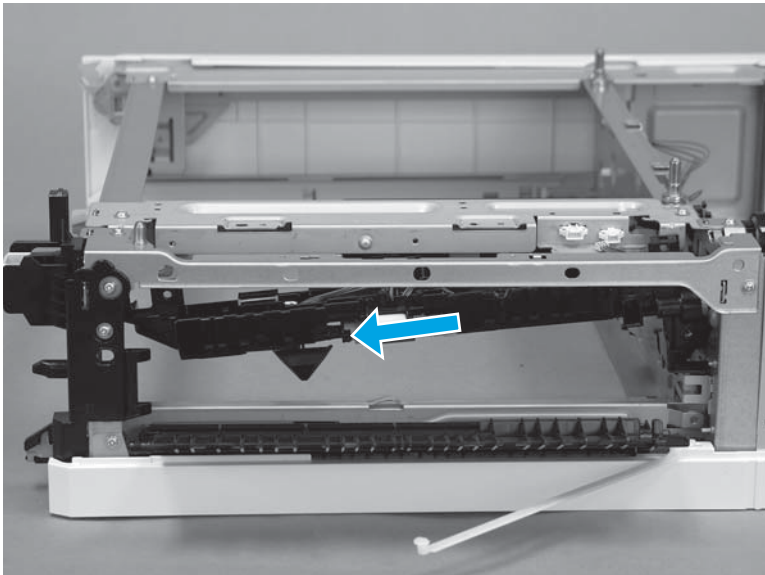

5. Remove the paper pickup assembly through the tray cavity.

Figure 1-5199 Remove the assembly

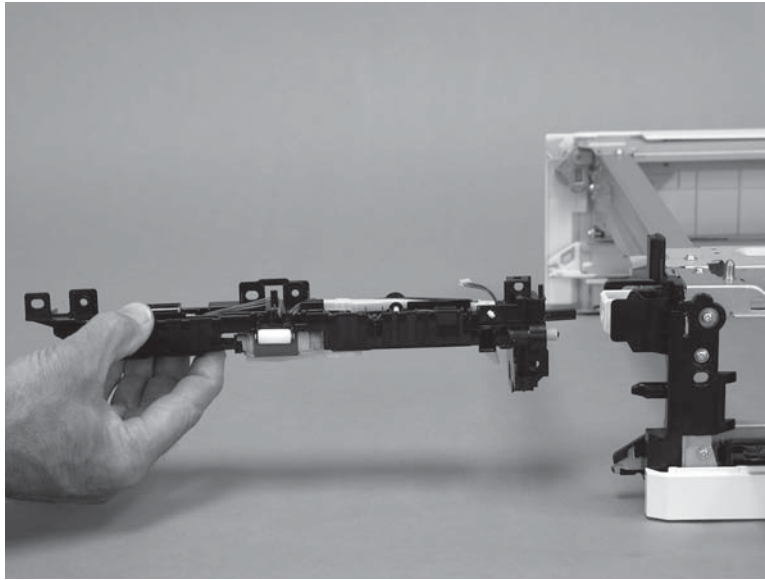

Step 7: Unpack the replacement assembly

Unpack the replacement assembly from the packaging.

CAUTION: Avoid touching the surface of the rollers on the replacement assembly. Skin oils on the rollers can cause print-quality problems. Thoroughly wash your hands with soap and water to remove skin oils, and then completely dry them.

For complete information on HP's recycling programs, go to [Product return and recycling](#).

NOTE: HP recommends responsible disposal of the defective assembly.

Figure 1-5200 Recycle and unpack

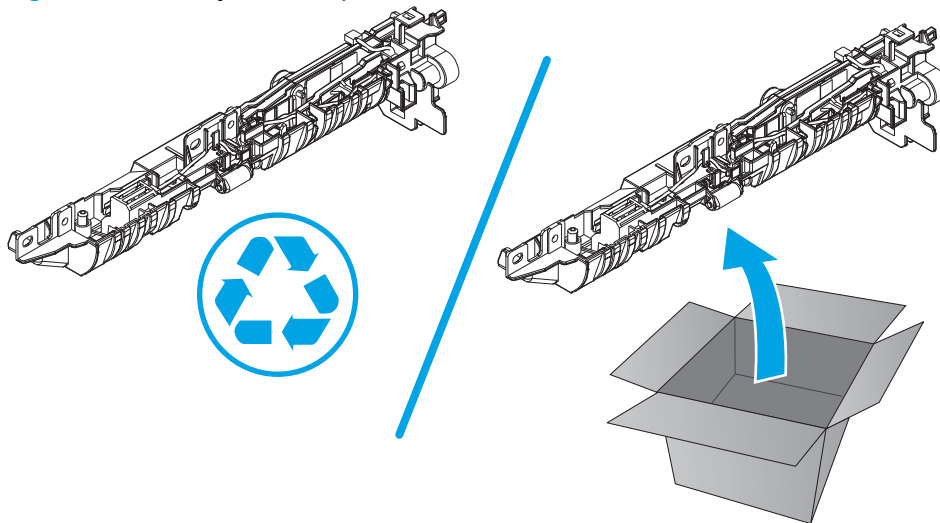

Step 8: Install the paper pickup assembly

1. Install the paper pickup assembly through the tray cavity, and then slide the assembly to the right to engage it with the drive gear on the lifter drive assembly.

⚠ CAUTION: Avoid touching the surface of the rollers on the replacement assembly. Skin oils on the rollers can cause print-quality problems. Thoroughly wash your hands with soap and water to remove skin oils, and then completely dry them.

📝 NOTE: If a replacement assembly is installed, remove the white drive gear from the discarded assembly, and then install it on the replacement paper pickup assembly.

Figure 1-5201 Install the assembly

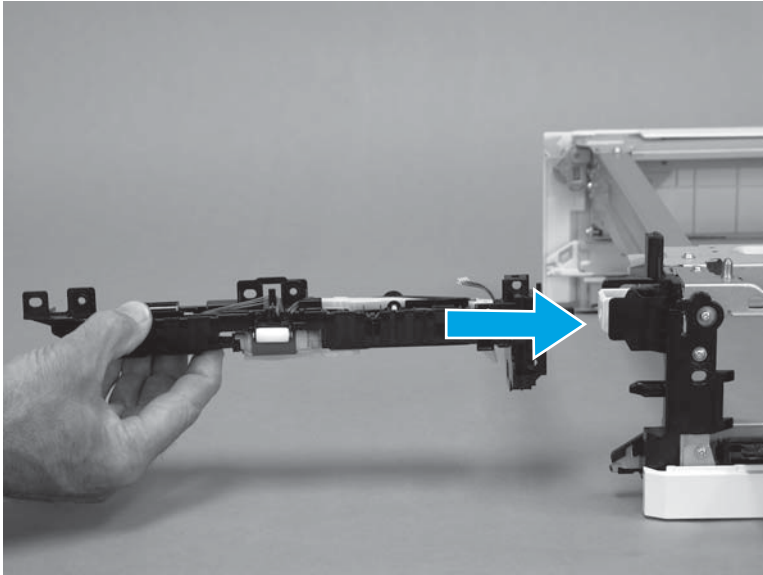

2. Raise the left end of the assembly (callout 1)—the end near the tray cavity—and engage one alignment pin (callout 2).

Figure 1-5202 Raise the end of the assembly

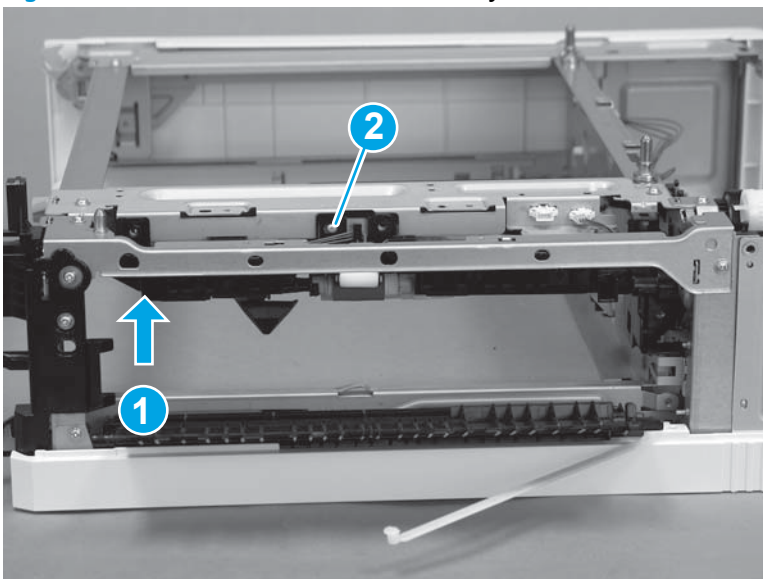

3. Install three screws (callout 1).

Figure 1-5203 Install three screws

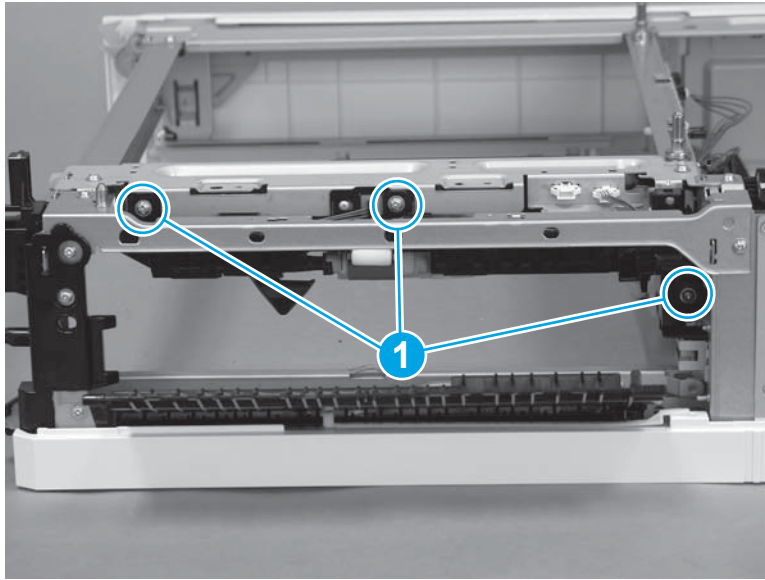

4. Connect one connector (callout 1).

Figure 1-5204 Connect one connector

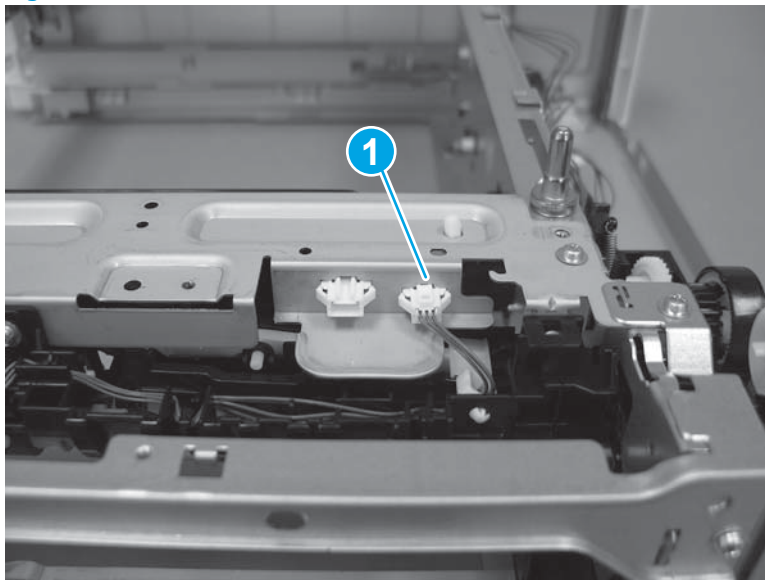

Step 9: Install the paper feed assembly

1. Be careful when handling the assembly. The left side flag (callout 1) is easily dislodged.

Figure 1-5205 Left side flag

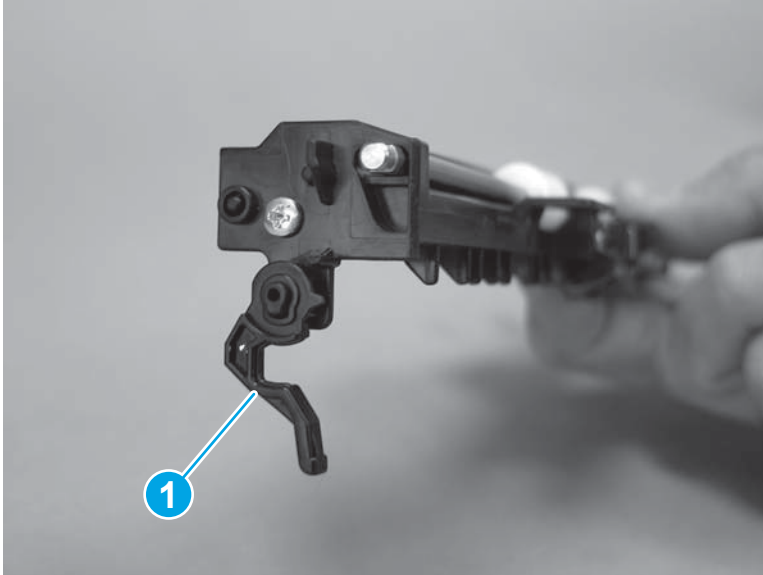

2. Insert the keyed end of the shaft (callout 1) into the gear (callout 2) on the lifter drive assembly—turn the shaft on the paper feed assembly or the gear on the lifter drive assembly to align the keyed shaft with the gear.

 **IMPORTANT:** Make sure that the tab on the gear snaps into place on the shaft.

Figure 1-5206 Install the assembly



3. Lower the tray end of the assembly into the chassis, and then make sure that the alignment pins (callout 1) are fully seated—the assembly must fit flush up against the chassis.

Figure 1-5207 Check the alignment pins

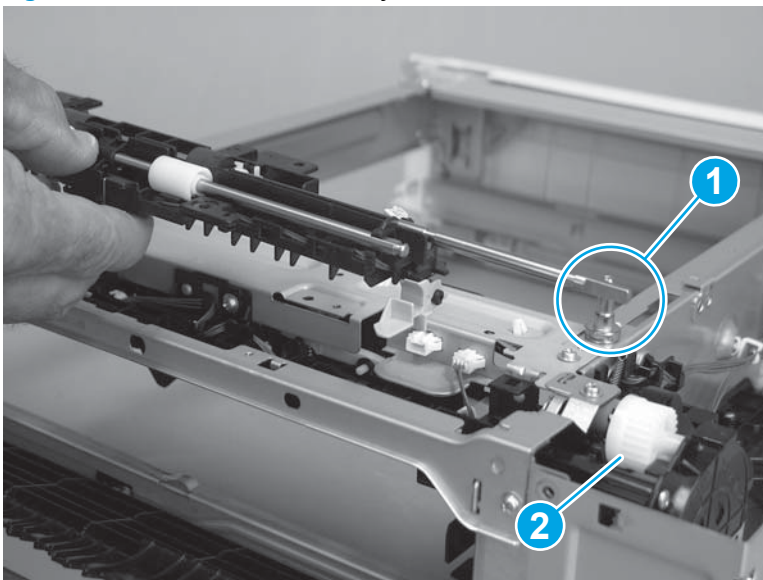
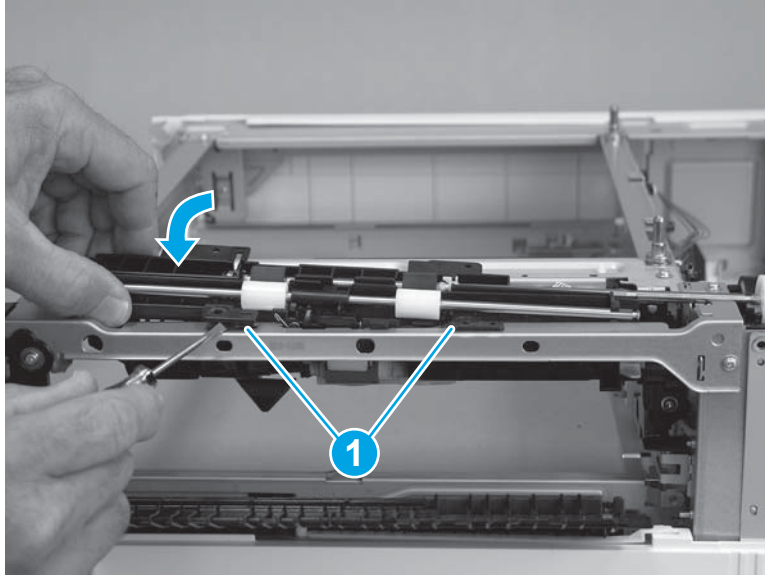

4. Install three screws (callout 1).

Figure 1-5208 Install three screws

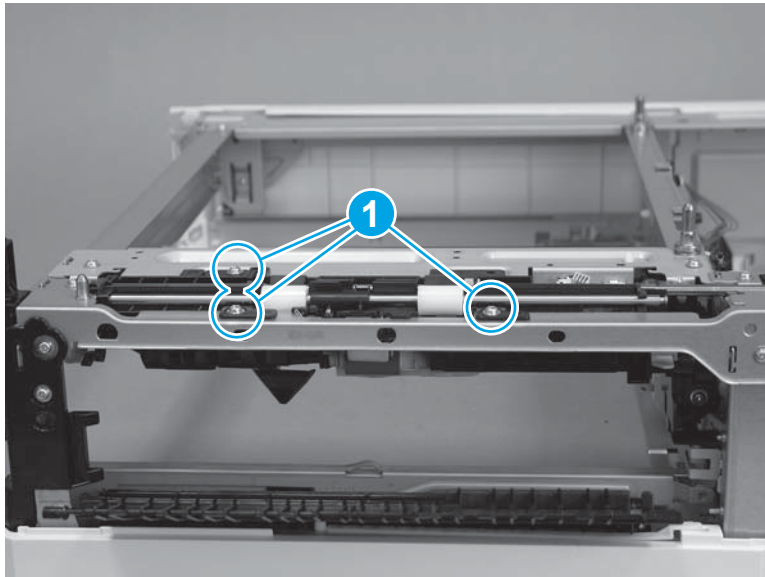

5. Install two springs (callout 1).

Figure 1-5209 Install two springs

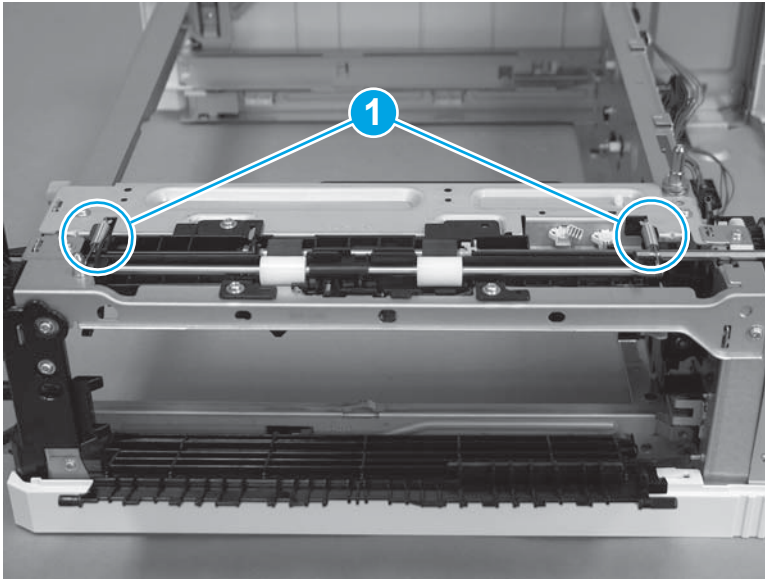

6. Connect one connector (callout 1).

Figure 1-5210 Connect one connector

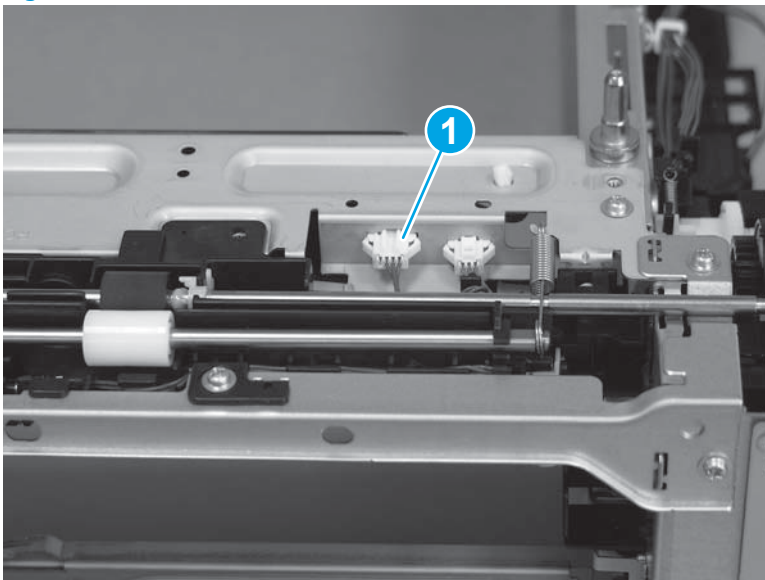

7. Position the cover (callout 1) on the chassis, make sure that the one tab (callout 2) snaps into place, and then install one screw (callout 3).

Figure 1-5211 Install the cover

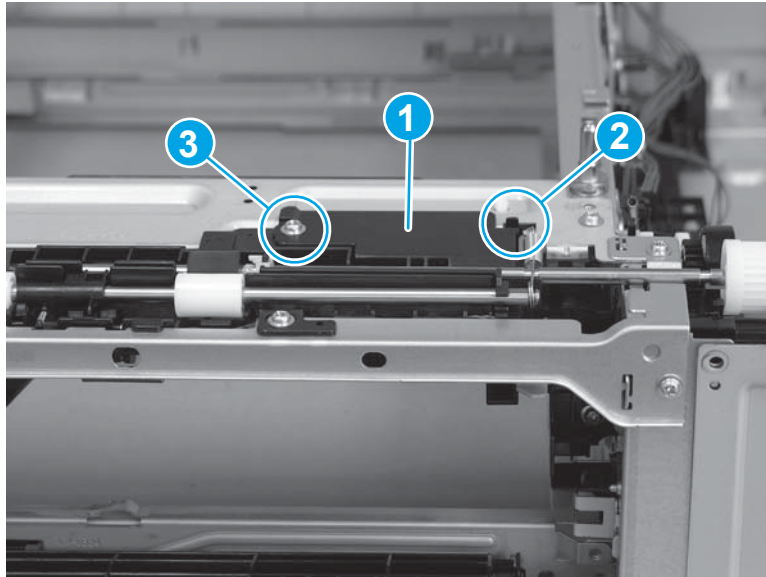

8. Rotate the paper feed guide up into position (callout 1)—the right side (green) jam handle (callout 2) automatically locks the guide in place.

Figure 1-5212 Raise the paper feed guide

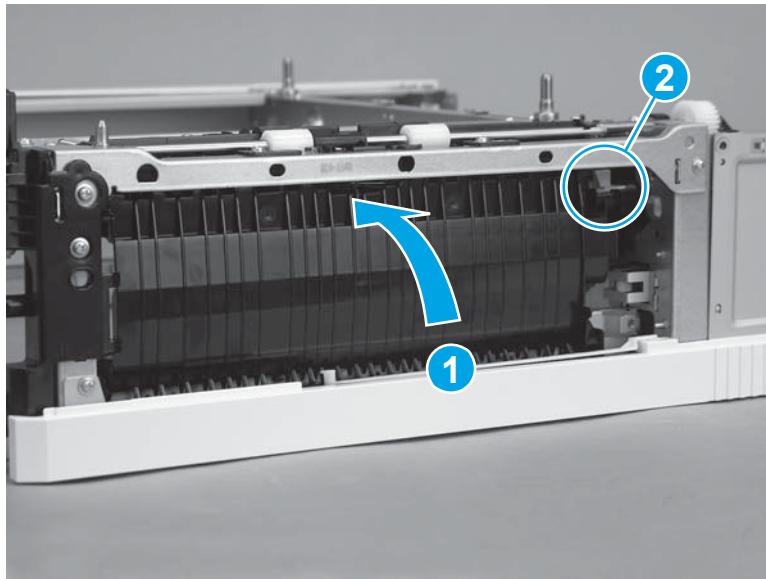

9. Position the sheet-metal plate on the chassis.

Figure 1-5213 Install the sheet-metal plate

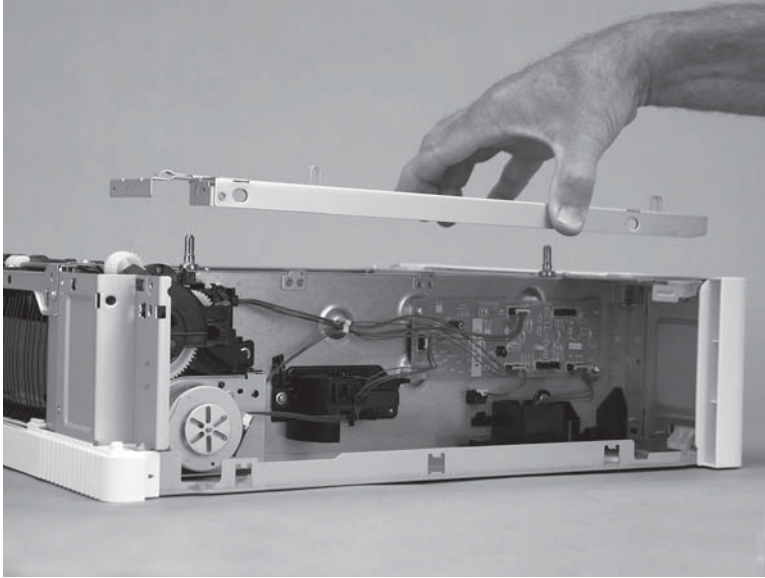

10. Install six screws (callout 1).

Figure 1-5214 Install six screws

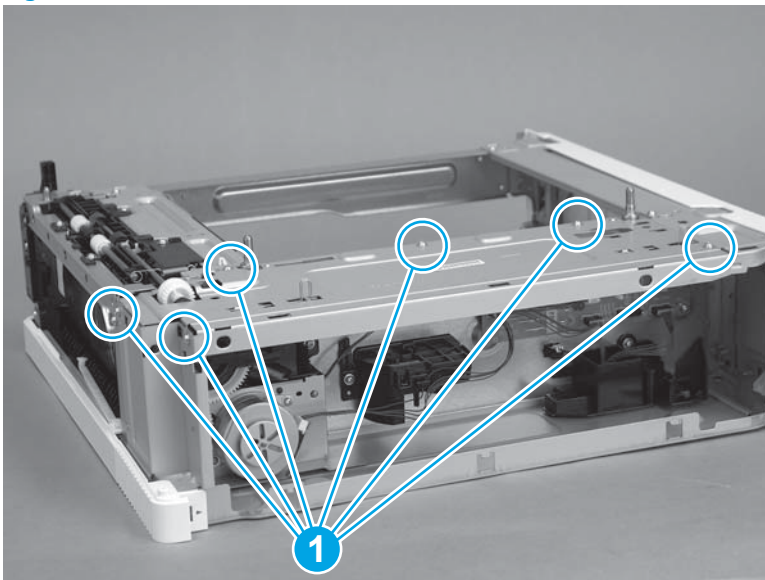

Step 10: Install the drawer connector holder

1. Position the drawer connector holder on the chassis.



NOTE: Make sure that the wire harness (callout 1) was transferred from the discarded assembly to the replacement assembly.

Figure 1-5215 Place the tray connector on the accessory

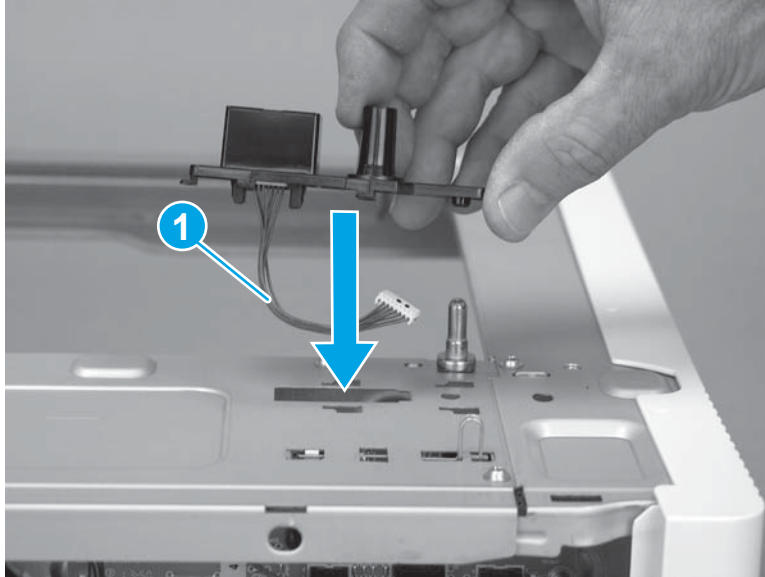

2. Slide the drawer connector holder as shown (callout 1) to install it, and then make sure that one tab (callout 2) snaps into place .

Figure 1-5216 Install the tray connector

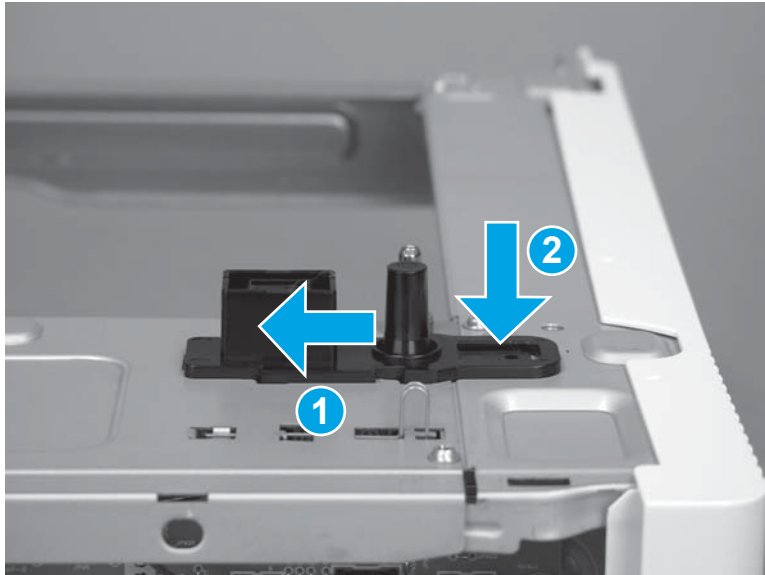

3. Connect one connector (callout 1; J901).

Figure 1-5217 Connect one connector

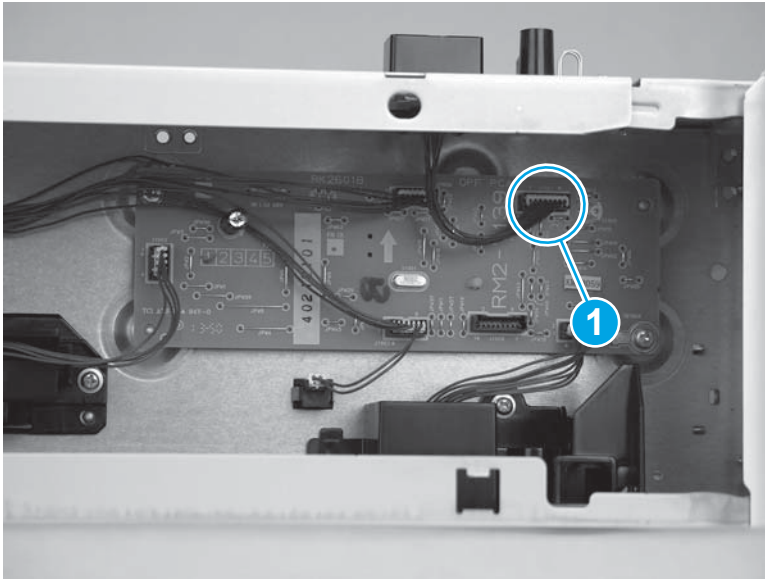

Step 11: Install the right door

1. Install the door link in the slot in the door to attach the door.

Figure 1-5218 Install the door link

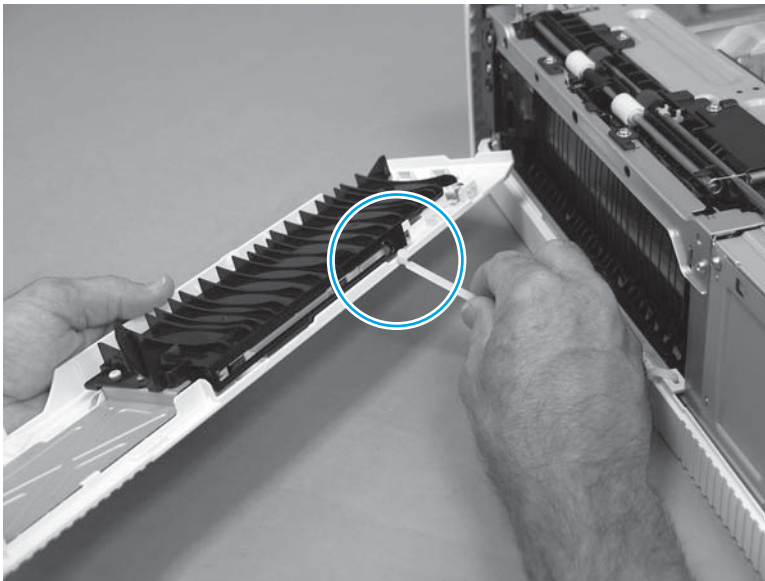

2. Position the lower hinge hole on the door (callout 2) on the lower hinge pin (callout 2) on the right-lower cover.

Figure 1-5219 Position the door on the lower hinge

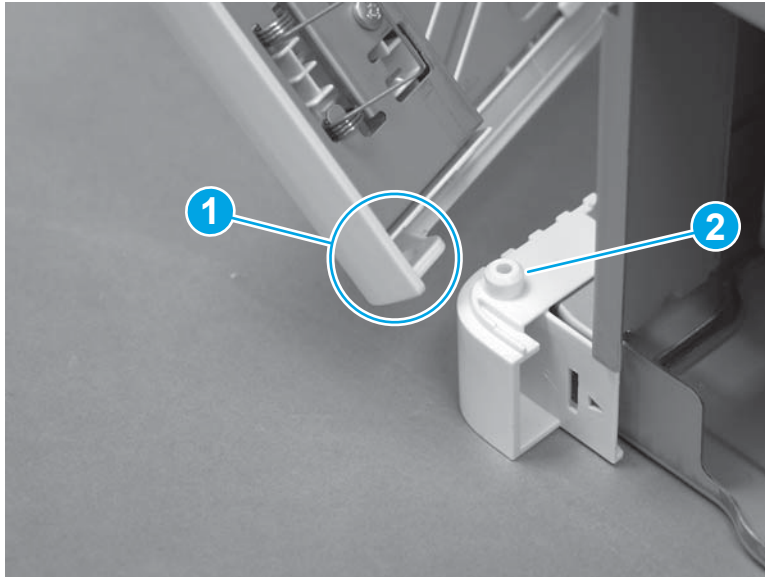

3. Align the pin of the door-hinge bracket (callout 1) with the hole in the chassis, and then align the mounting tabs (callout 2 and callout 3) with the slots in the chassis.

Figure 1-5220 Engage the hinge bracket

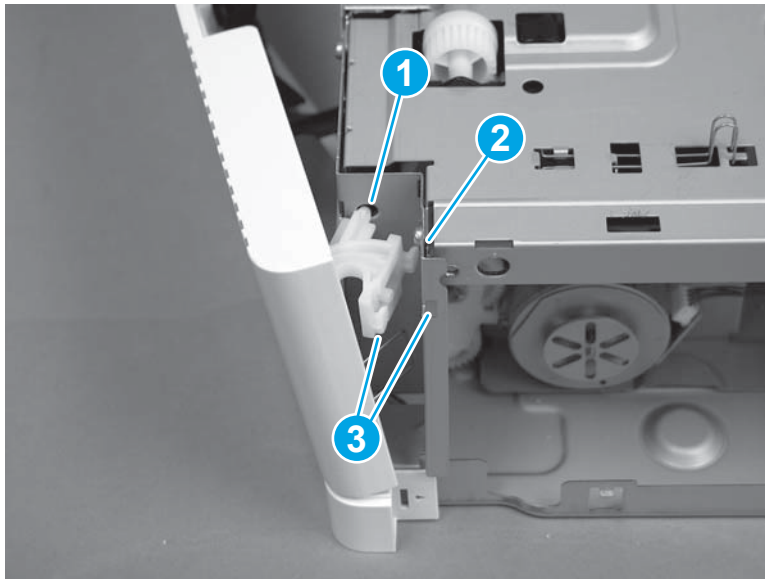

4. Push in on the door-hinge bracket (callout 1), and then slide it toward the chassis (callout 2) to install it.

Figure 1-5221 Install the hinge bracket

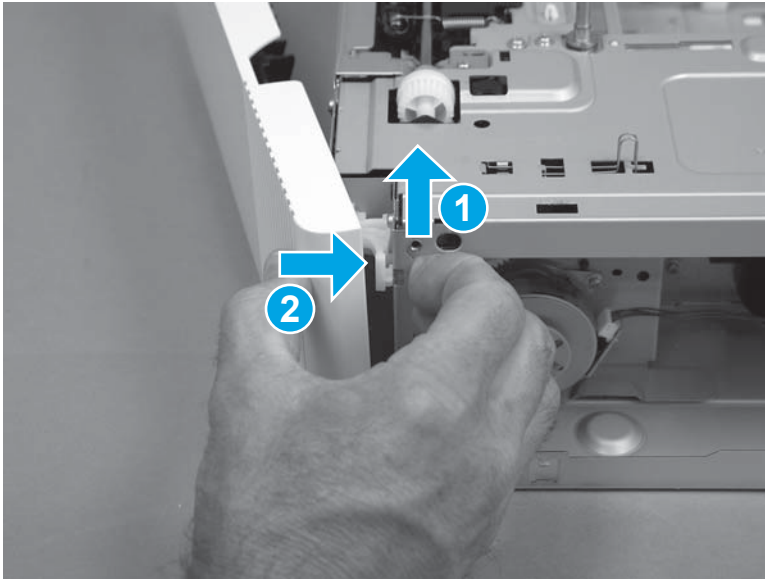

5. Close the door.

Figure 1-5222 Close the door

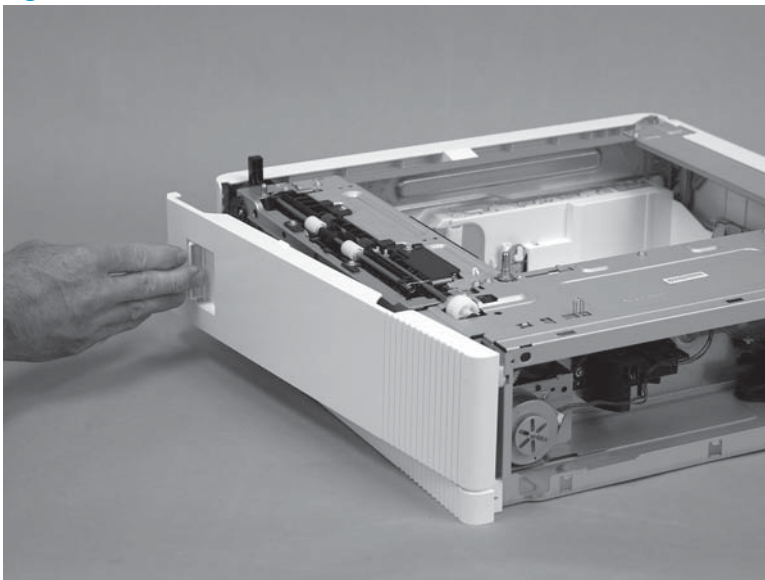

Step 12: Install the rear cover

1. Align the three mounting tabs (callout 1) on the cover with the slots in the chassis.

Figure 1-5223 Position the cover on the chassis

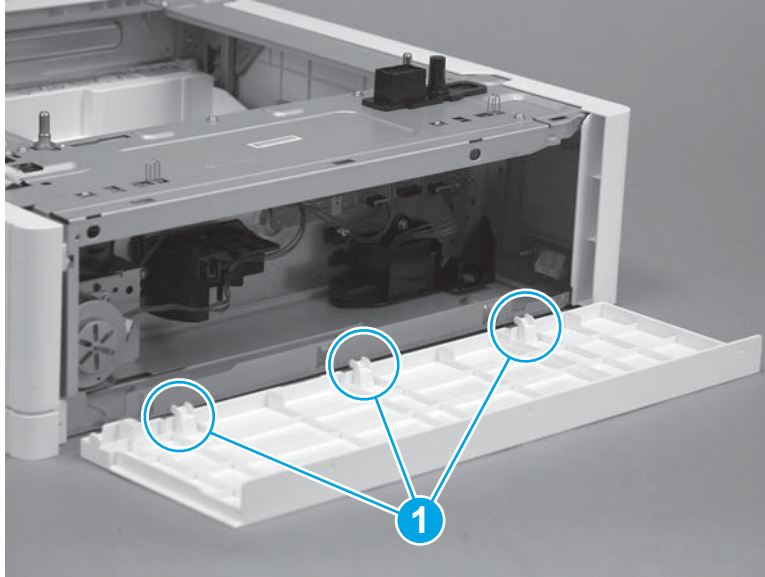

2. Position the cover on the accessory (callout 1), and then rotate the top of the cover up and onto the chassis (callout 2) to install it.

Figure 1-5224 Install the cover

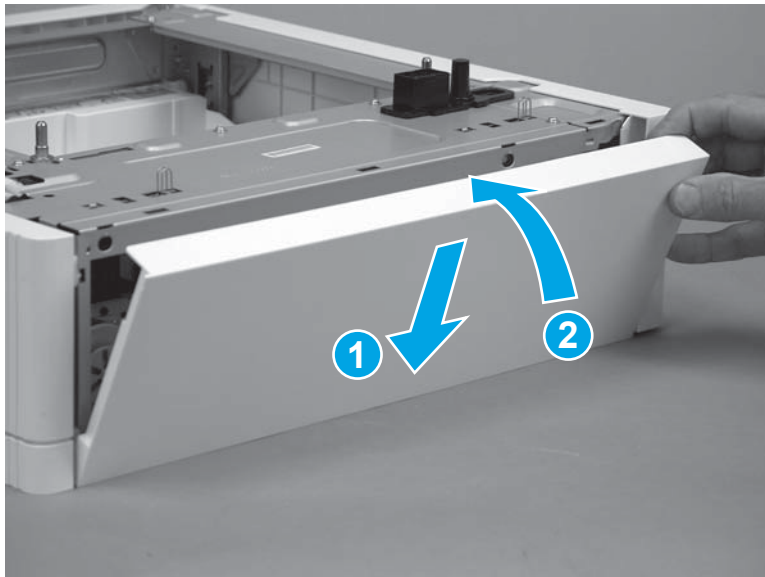

3. Make sure that the three tabs (callout 1) snap into place.

Figure 1-5225 Check the three tabs

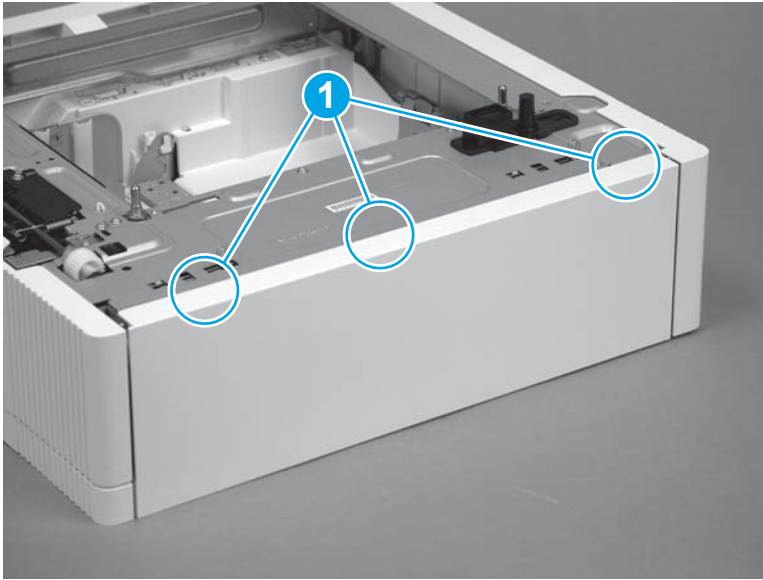

Step 13: Install the tray

1. With the front of the tray slightly lifted, align the sides of the tray with the rails in the printer, and then carefully slide the tray into the printer.

 **TIP:** As the tray slides into the accessory, lower the front of it.

Figure 1-5226 Install the tray



2. Close the tray.

Figure 1-5227 Close the tray

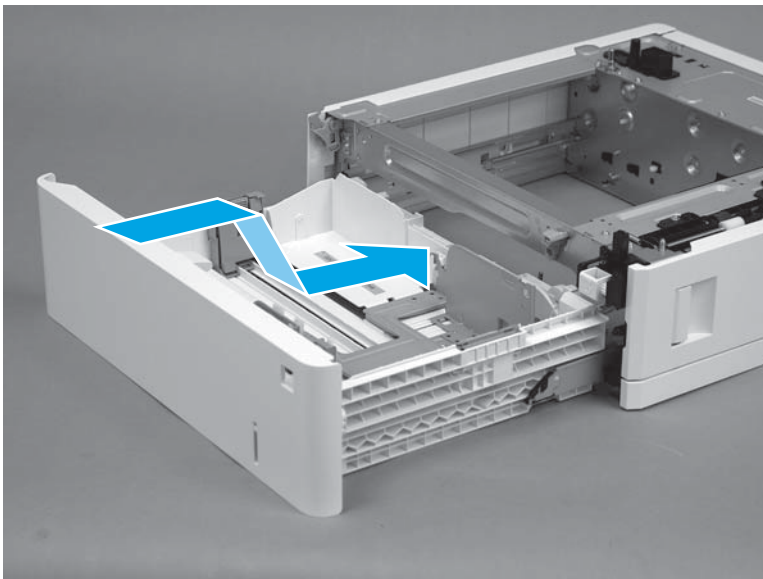
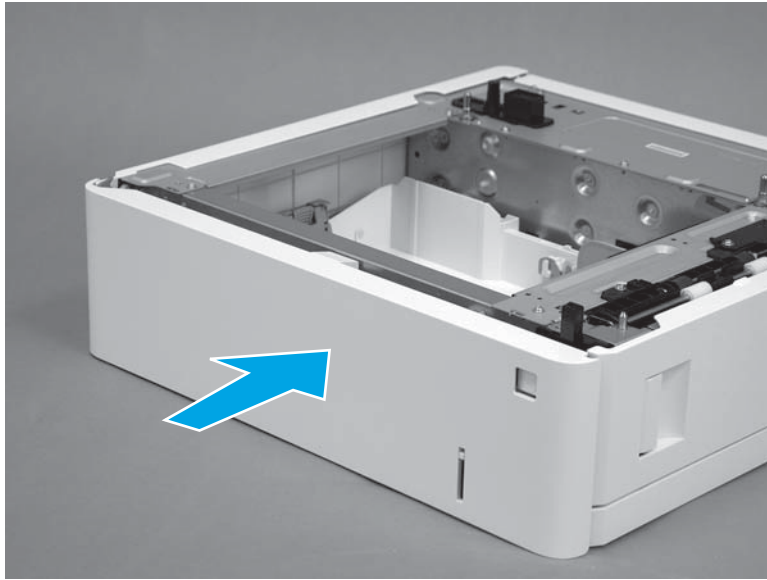

Removal and replacement: Feeder drive assembly (1x550-sheet paper feeder)

- [Introduction](#)
- [Step 1: Remove the tray](#)
- [Step 2: Remove the rear cover](#)
- [Step 3: Remove the right door](#)
- [Step 4: Remove the lower-right cover](#)
- [Step 5: Remove the drawer connector holder](#)
- [Step 6: Remove the feeder drive assembly](#)
- [Step 7: Unpack the replacement assembly](#)
- [Step 8: Install the feeder drive assembly](#)
- [Step 9: Install the drawer connector holder](#)
- [Step 10: Install the lower-right cover](#)
- [Step 11: Install the right door](#)
- [Step 12: Install the rear cover](#)
- [Step 13: Install the tray](#)

Introduction

This document provides the procedures to remove and replace the 1x550-sheet paper feeder drive assembly.

Before performing service

Use the table below to identify the correct part number for your printer, and then go to <http://h20141.www2.hp.com/hpparts> to order the part.

Feeder drive assembly (1x550-sheet paper feeder) part number	
RM2-5148-000CN	Feeder drive assembly (1x550-sheet paper feeder)

Required tools

- #2 Phillips screwdriver with a magnetic tip and a 152-mm (6-in) shaft length
- Small, flat-blade screwdriver

After performing service

Make sure that the rear cover is flush against the chassis after replacing it.

Make sure that the right door latches correctly when closed after replacing it.

Make sure that Tray 3 is fully closed after replacing it.

Post service test

Print a page from a host computer using the appropriate tray as the source tray.

Step 1: Remove the tray

1. Pull the tray out until it stops.

Figure 1-5228 Pull the tray out

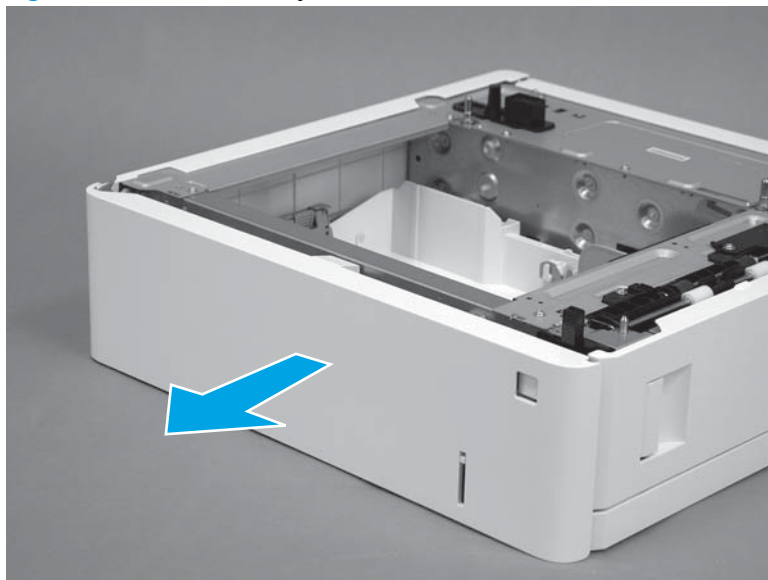

2. Lift the front of the tray, and then pull it out of the printer to remove it.

Figure 1-5229 Remove the tray

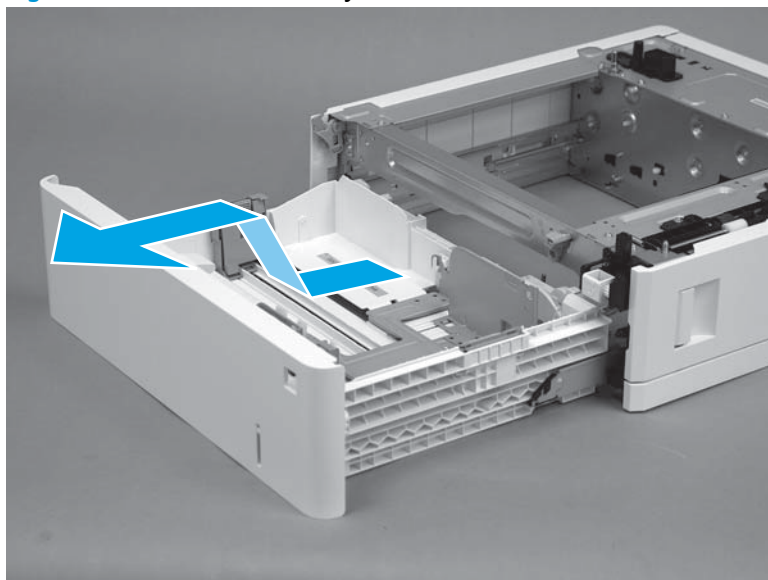

Step 2: Remove the rear cover

1. Release three tabs (callout 1).

Figure 1-5230 Release three tabs

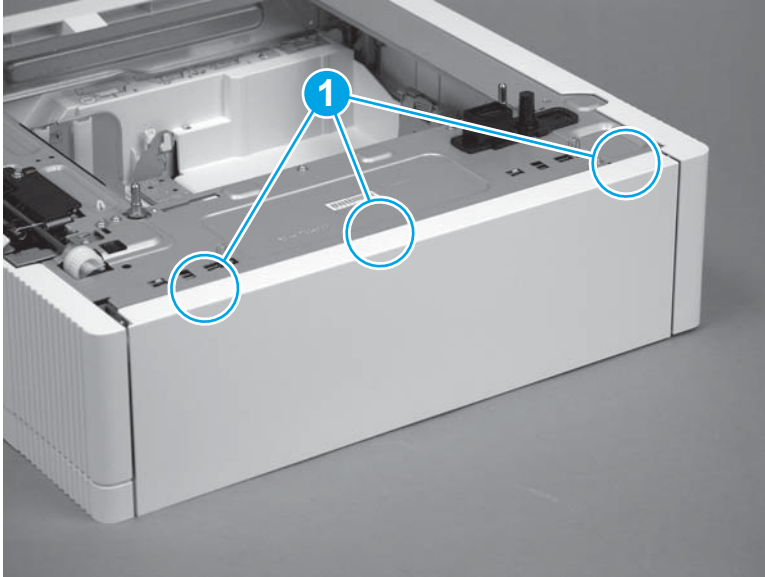

2. Rotate the top of the cover away from the accessory (callout 1), and then lift it up to remove it (callout 2).

Figure 1-5231 Remove the cover

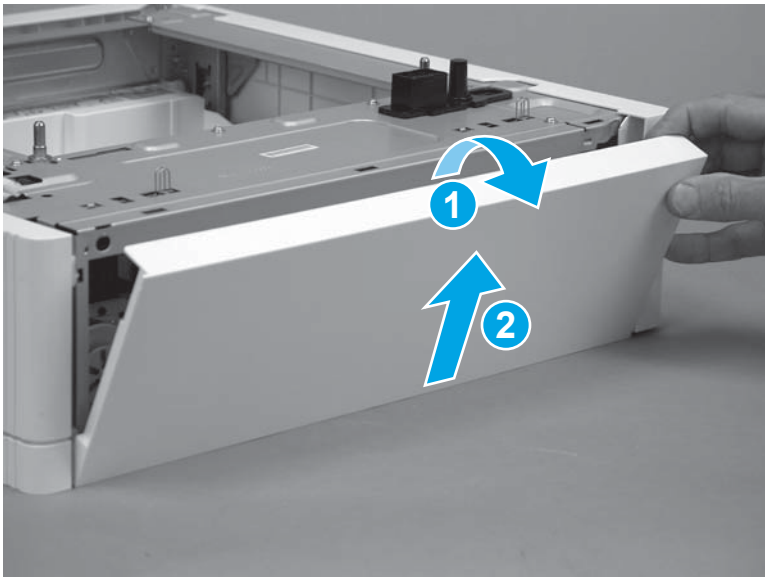

Step 3: Remove the right door

1. Open the door.

Figure 1-5232 Open the door

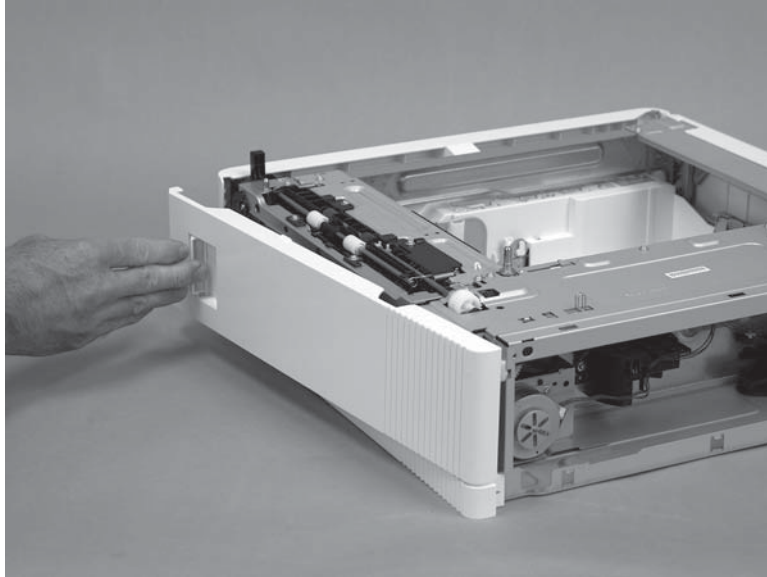

2. Release one tab (callout 1), and then slide the door-hinge bracket away from the chassis (callout 2) to release it.

Figure 1-5233 Release the hinge bracket

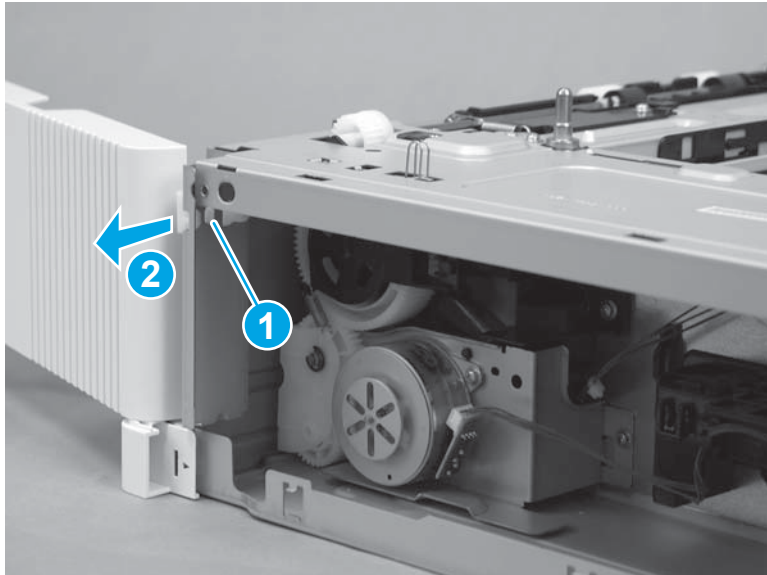

3. Remove the door-hinge bracket from the chassis.

CAUTION: The door is still attached to the accessory by the door link. Do not attempt to completely remove the door.

The door hinge bracket is not captive. Do not lose it when handling the door.

Figure 1-5234 Remove the hinge bracket

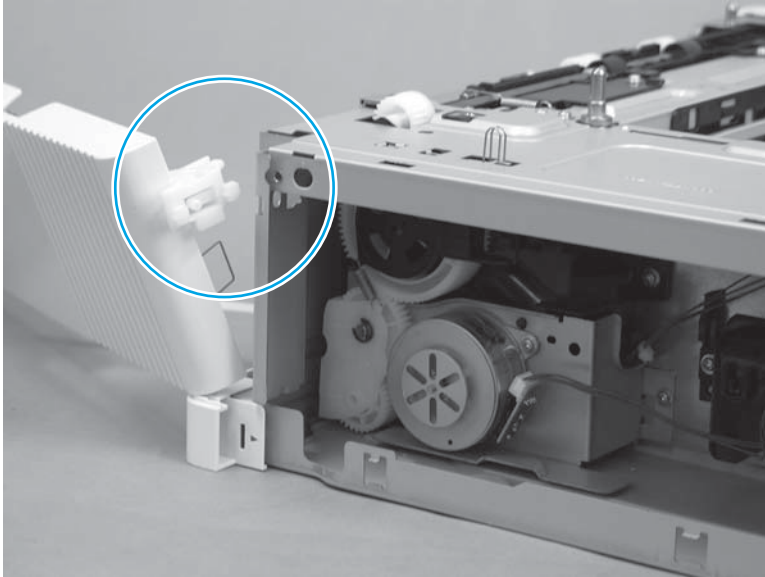

4. Release the door link from the slot in the door to remove the right door.

Figure 1-5235 Release the door link

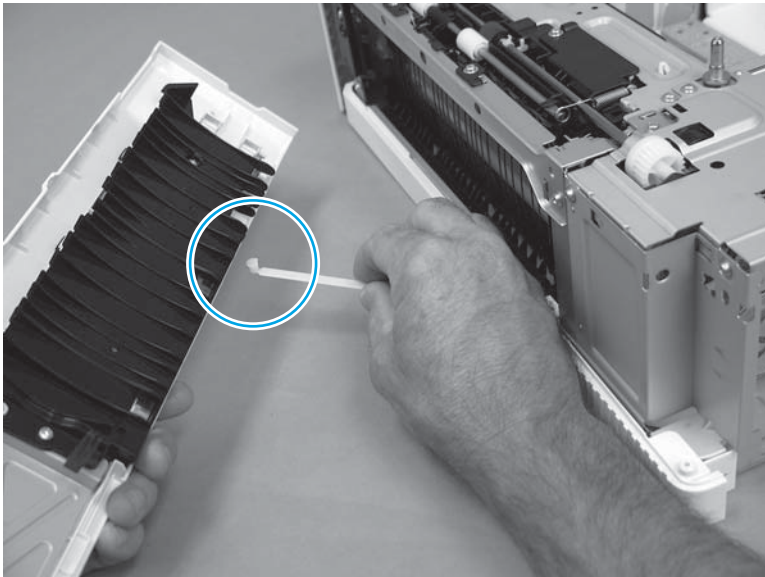

Step 4: Remove the lower-right cover

1. Before proceeding, take note of the location of the three mounting tabs on the back side of the cover.

Figure 1-5236 Cover mounting tabs

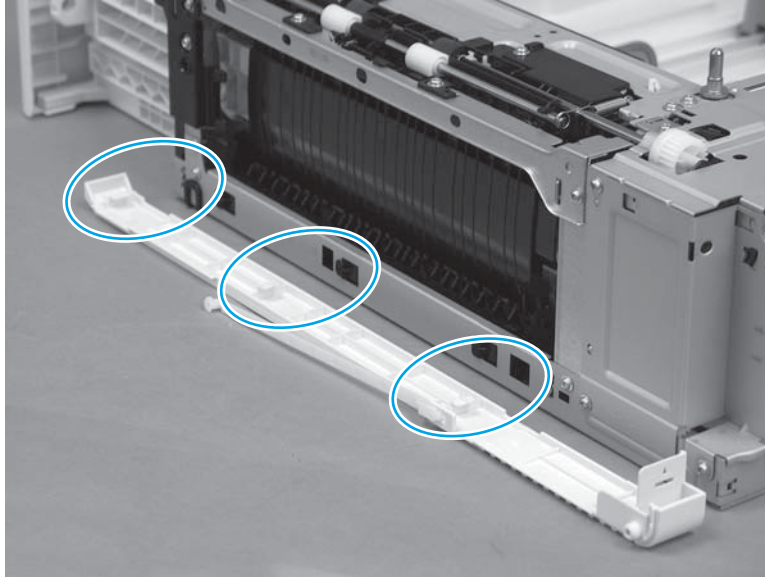

2. Partially open the tray, slightly flex the end of the cover away from the accessory (callout 1), and then slide it towards the front of the accessory (callout 2) to release it.

CAUTION: The three mounting tabs on the back side of the cover are easily damaged. Do not over flex the end of the cover when it is released. Push in on the middle tab to protect it when removing the cover.

Figure 1-5237 Release the cover

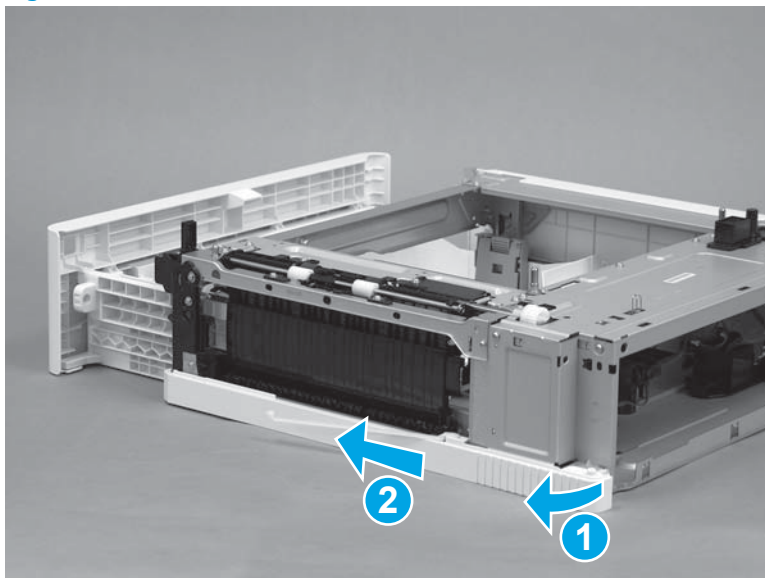

3. Remove the right-lower cover.

Figure 1-5238 Remove the right-lower cover

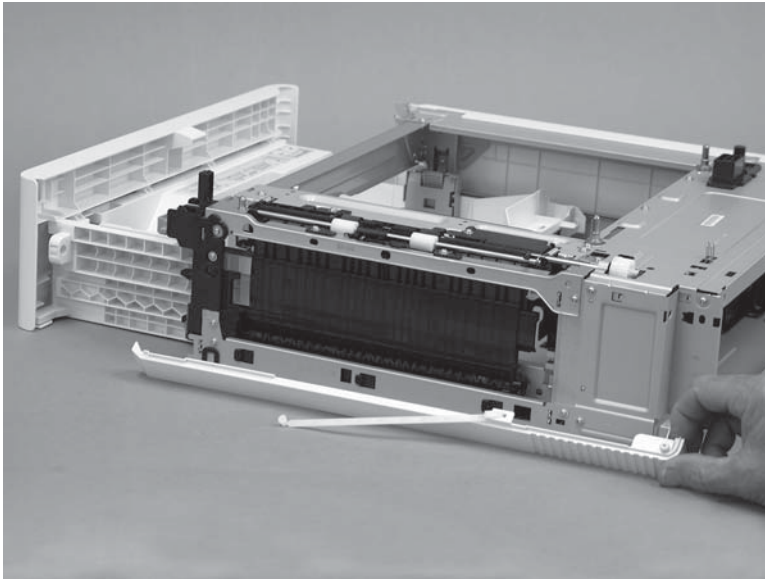

Step 5: Remove the drawer connector holder

1. Disconnect one connector (callout 1; J901).

Figure 1-5239 Disconnect one connector

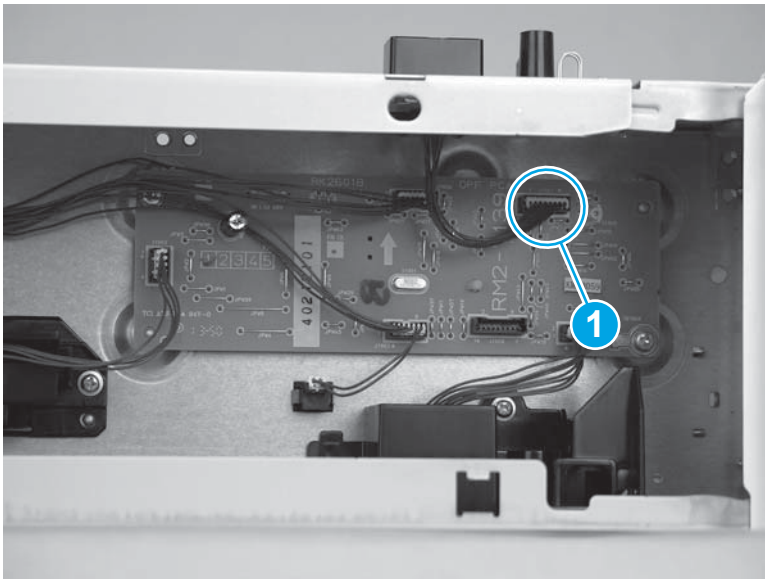

2. Release one tab (callout 1), and then slide the drawer connector holder as shown (callout 2) to release it.

Figure 1-5240 Release one tab

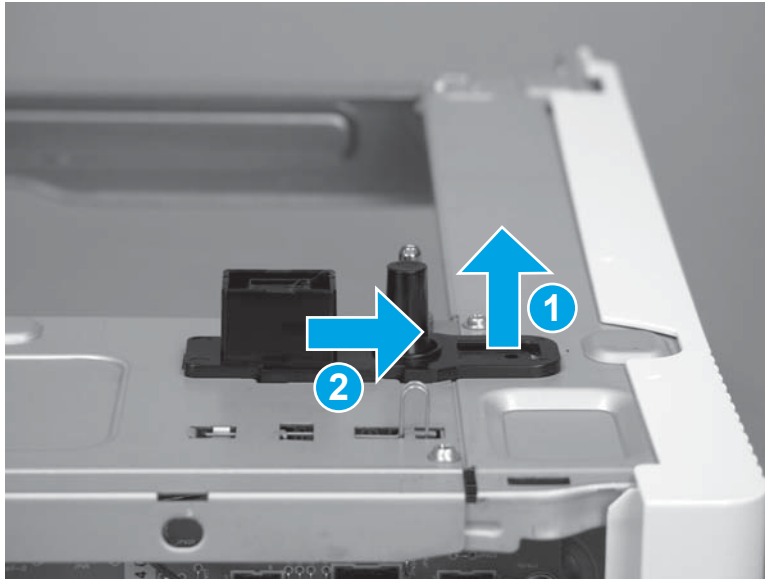

3. Remove the drawer connector holder.

Figure 1-5241 Remove the tray connector

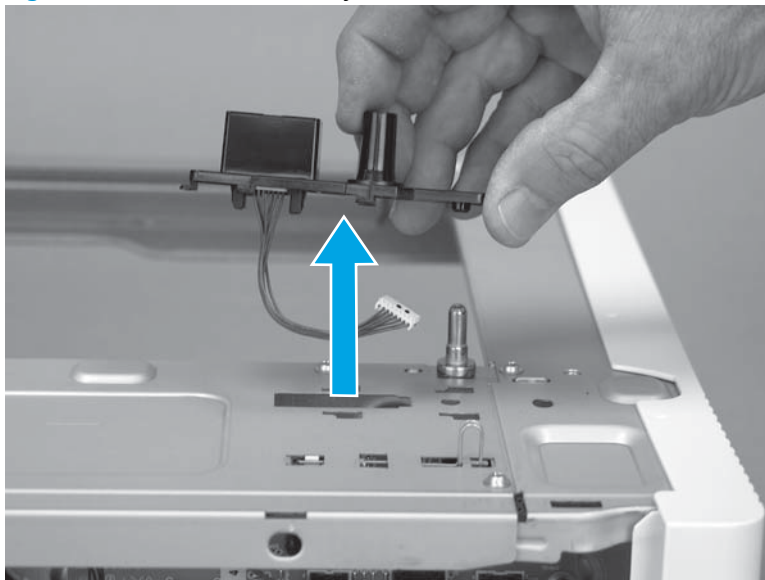

Step 6: Remove the feeder drive assembly

1. Remove six screws (callout 1).

Figure 1-5242 Remove six screws

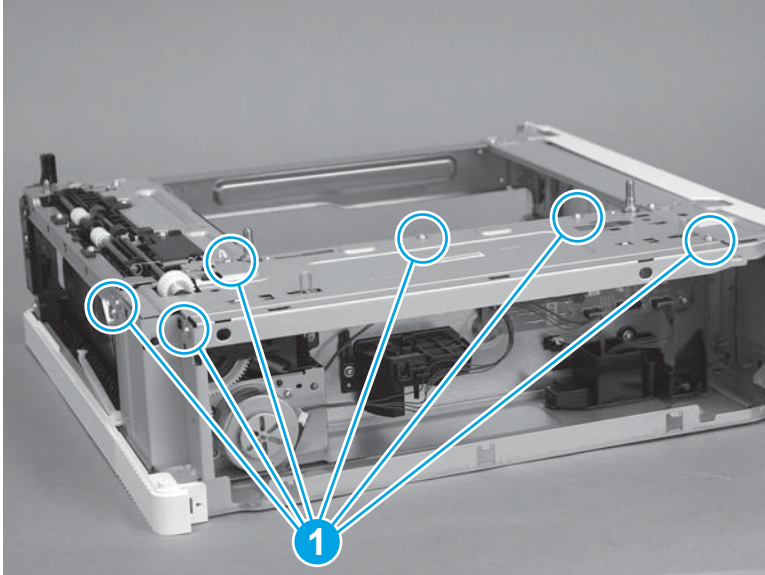

2. Remove the sheet-metal plate.

Figure 1-5243 Remove the sheet-metal plate

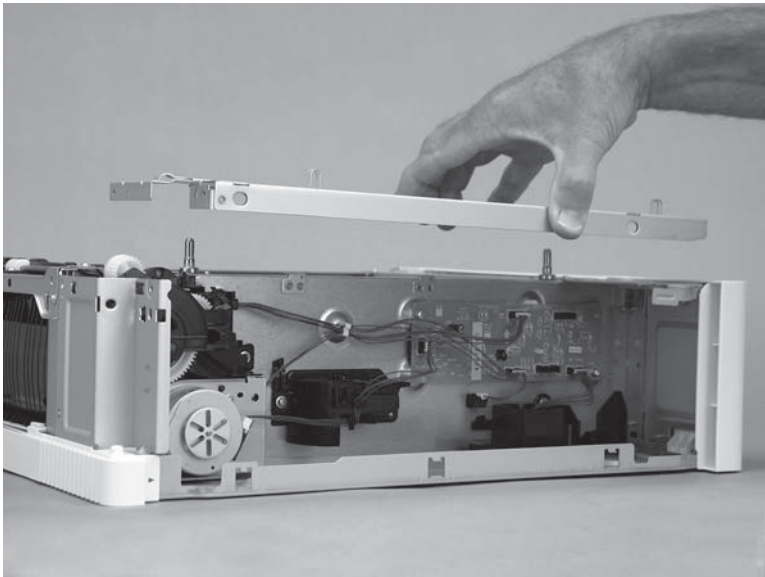

3. Remove two screws (callout 1).

Figure 1-5244 Remove two screws

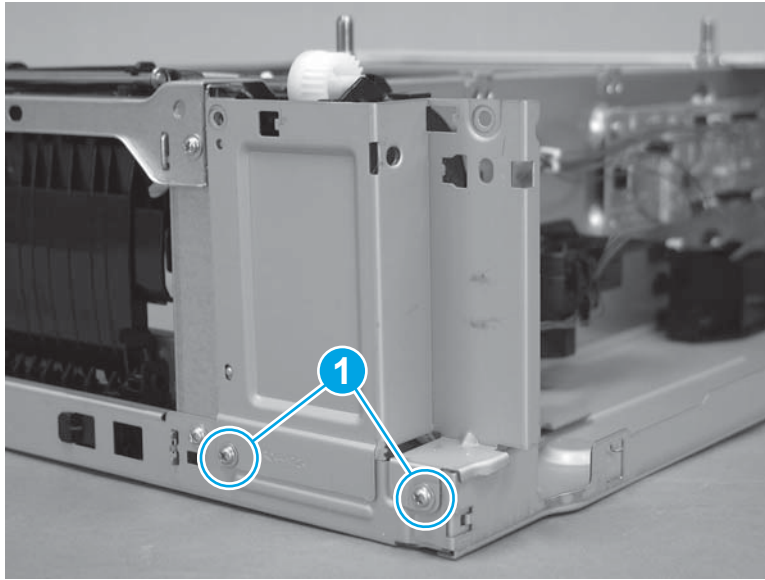

4. Remove the sheet-metal plate.

Figure 1-5245 Remove the sheet-metal plate

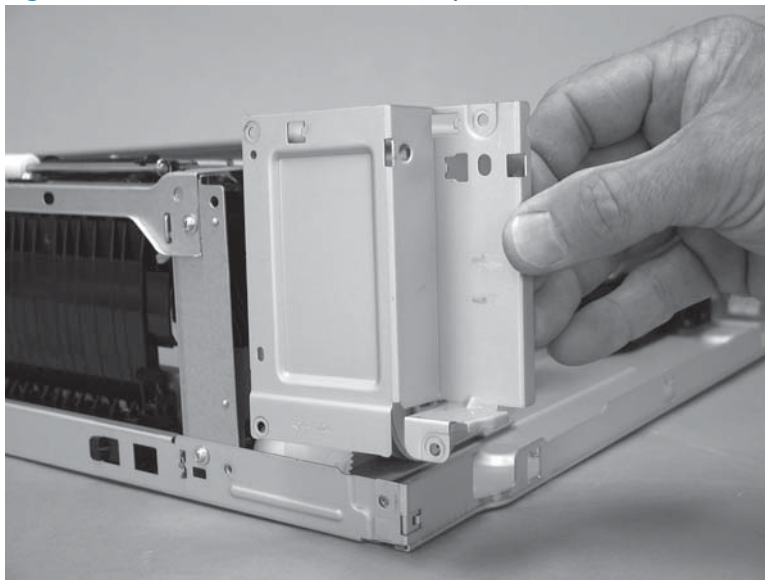

5. Disconnect one connector (callout 1).

Figure 1-5246 Disconnect one connector

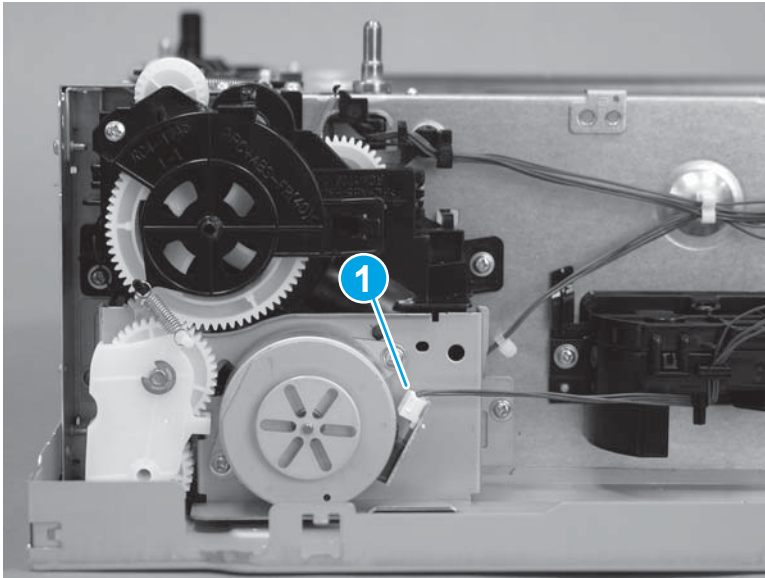

6. Remove one spring (callout 1).

Figure 1-5247 Remove one spring

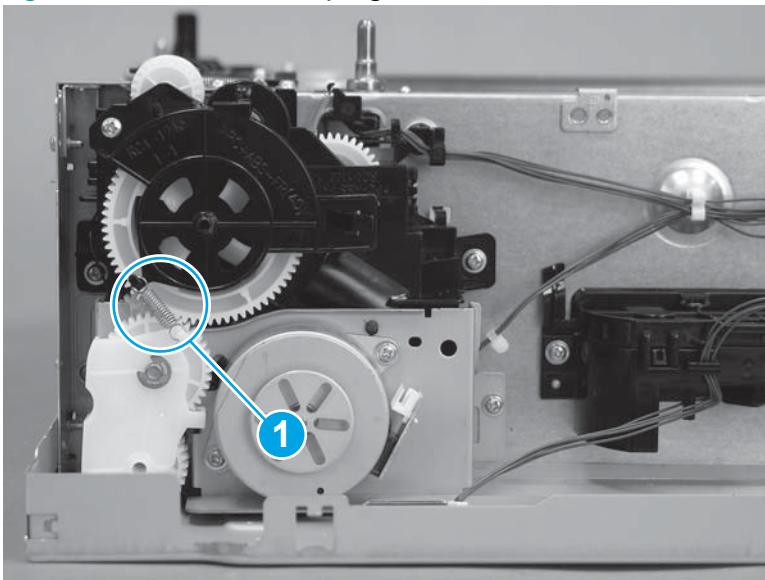

7. Remove two screws (callout 1).

Figure 1-5248 Remove two screws

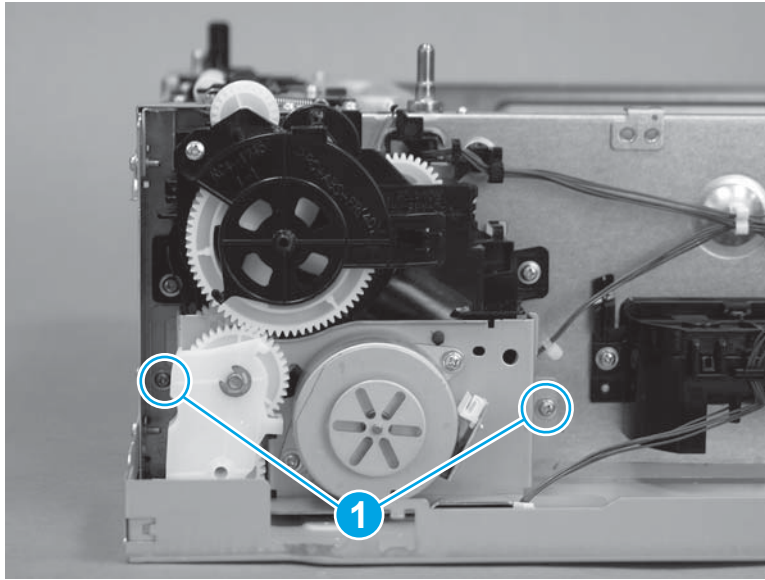

8. Remove the feeder drive assembly.

CAUTION: If the assembly is being removed to access another part, take care not to wipe any of the grease off of the gears.

Figure 1-5249 Remove the assembly

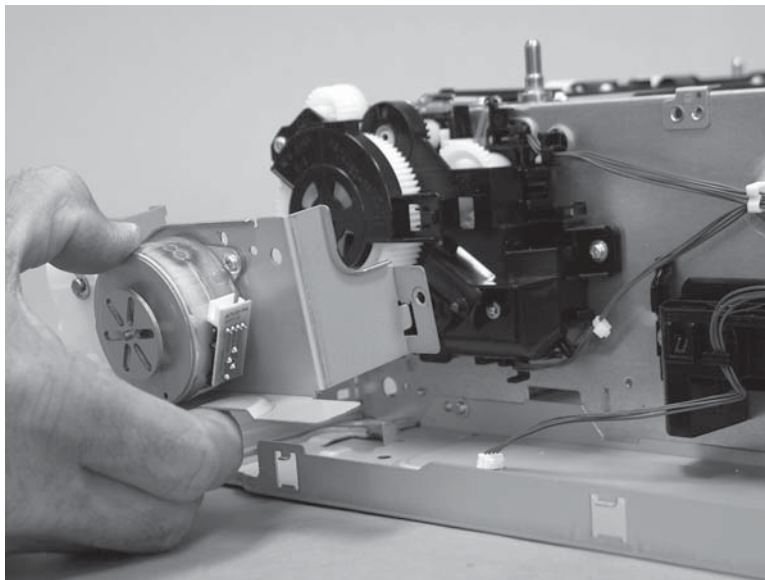

Step 7: Unpack the replacement assembly

Unpack the replacement assembly from the packaging.

For complete information on HP's recycling programs, go to [Product return and recycling](#).

CAUTION: When handling the replacement assembly, take care not to wipe any of the grease off of the gears.

 **NOTE:** HP recommends responsible disposal of the defective assembly.

Figure 1-5250 Recycle and unpack

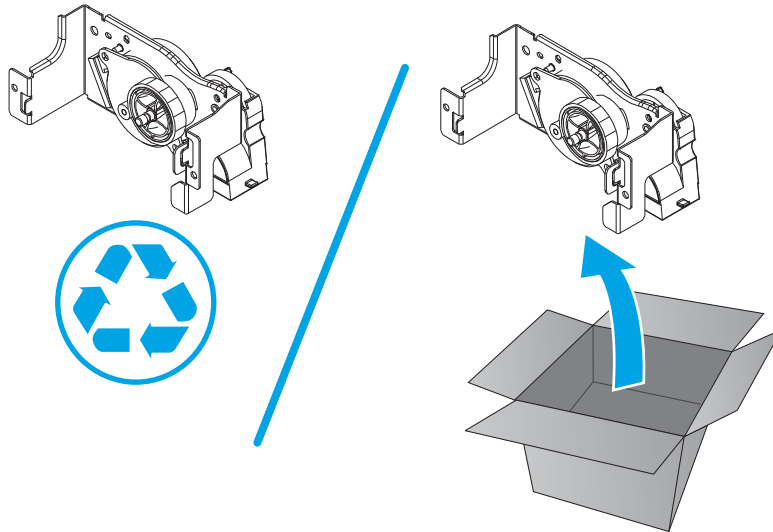

Step 8: Install the feeder drive assembly

1. Position the feeder drive assembly in the chassis.

 **CAUTION:** When handling the assembly, take care not to wipe any of the grease off of the gears.

Figure 1-5251 Install the assembly



2. Install two screws (callout 1).

Figure 1-5252 Install two screws

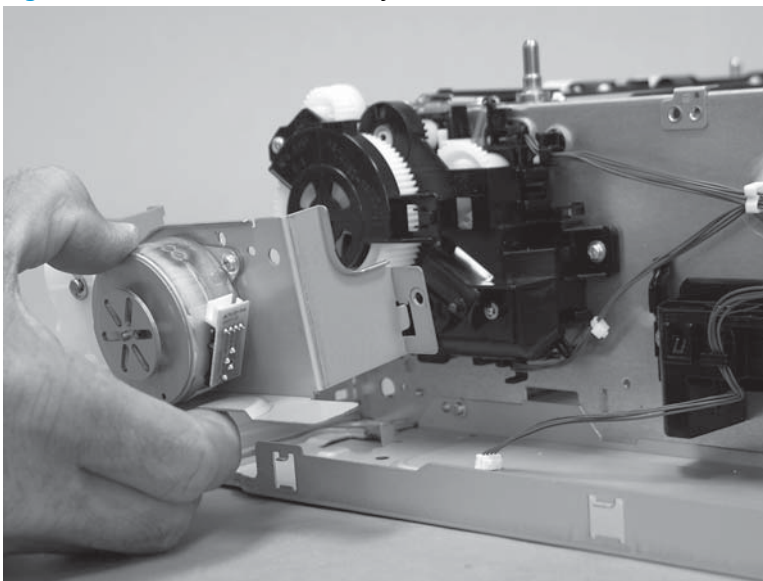
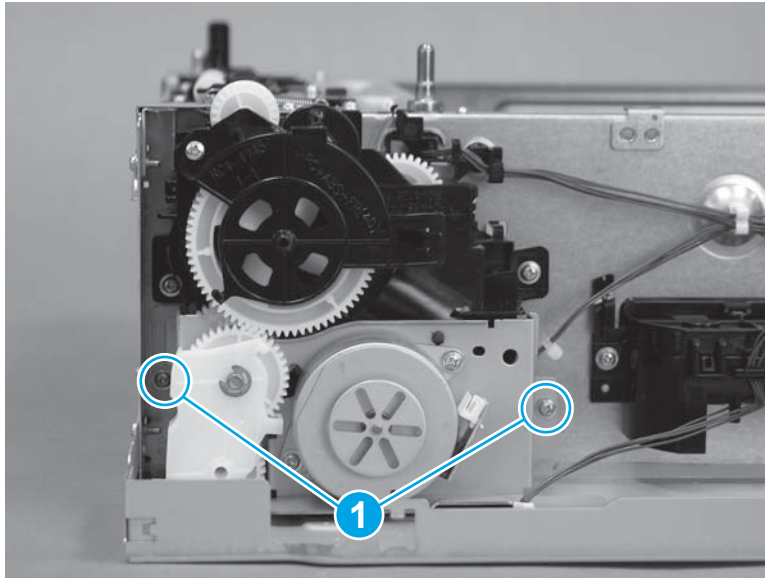

3. Install one spring (callout 1).

Figure 1-5253 Install one spring

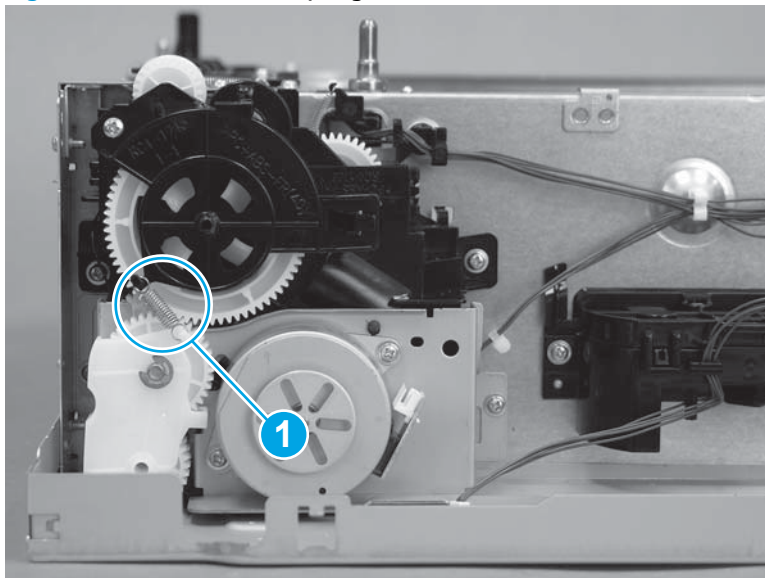

4. Connect one connector (callout 1).

Figure 1-5254 Connect one connector

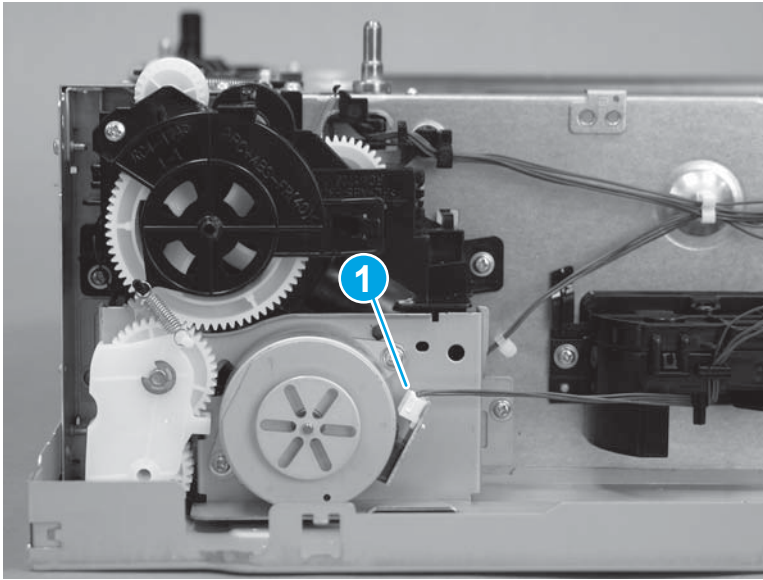

5. Position the sheet-metal plate on the chassis.

Figure 1-5255 Install the sheet-metal plate

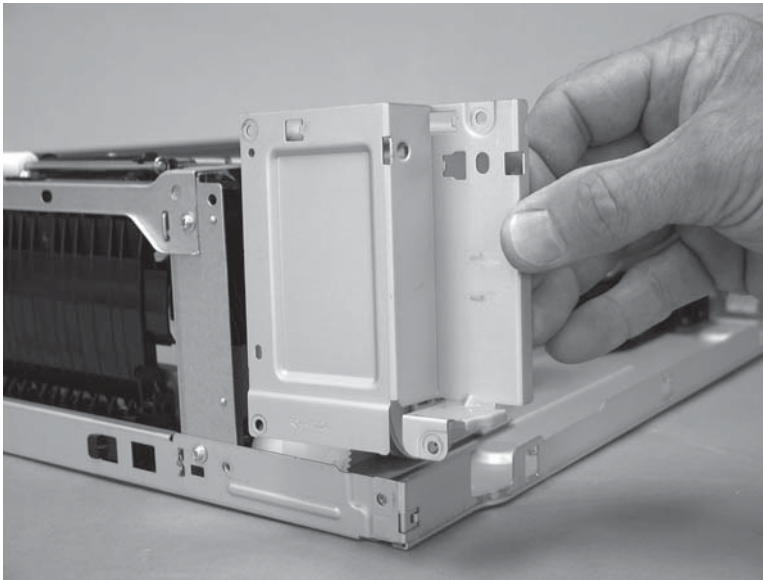

6. Install two screws (callout 1).

Figure 1-5256 Install two screws

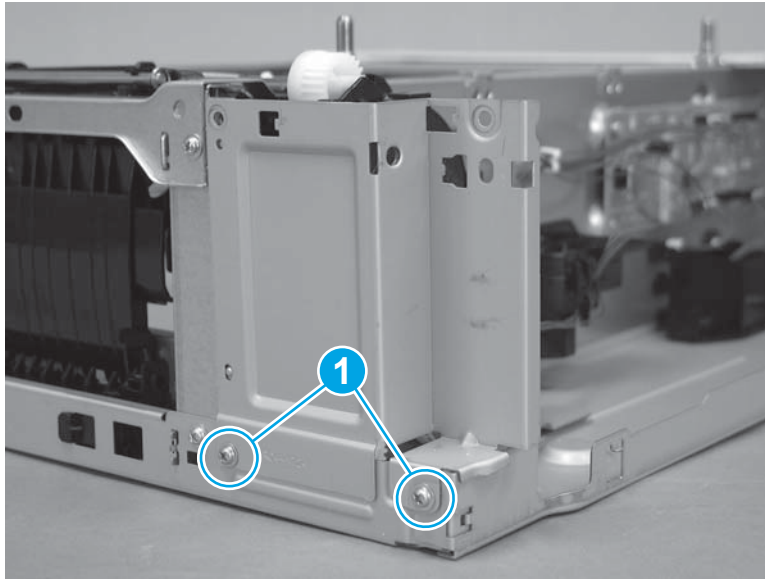

7. Position the sheet-metal plate on the chassis.

Figure 1-5257 Install the sheet-metal plate

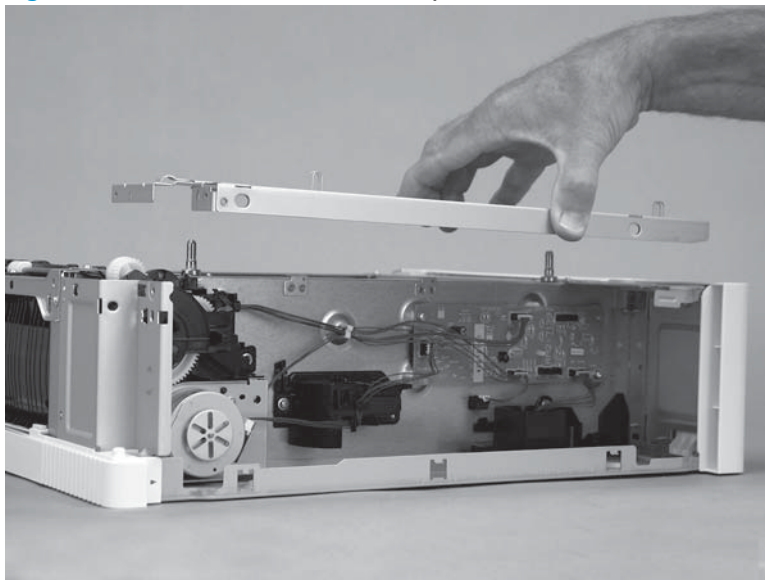

8. Install six screws (callout 1).

Figure 1-5258 Install six screws

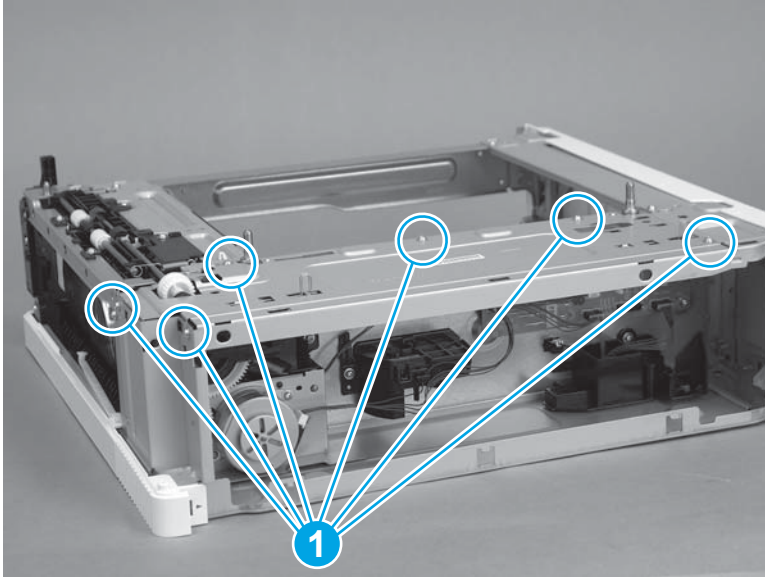

Step 9: Install the drawer connector holder

1. Position the drawer connector holder on the chassis.

 **NOTE:** Make sure that the wire harness (callout 1) was transferred from the discarded assembly to the replacement assembly.

Figure 1-5259 Place the tray connector on the accessory



2. Slide the drawer connector holder as shown (callout 1) to install it, and then make sure that one tab (callout 2) snaps into place .

Figure 1-5260 Install the tray connector

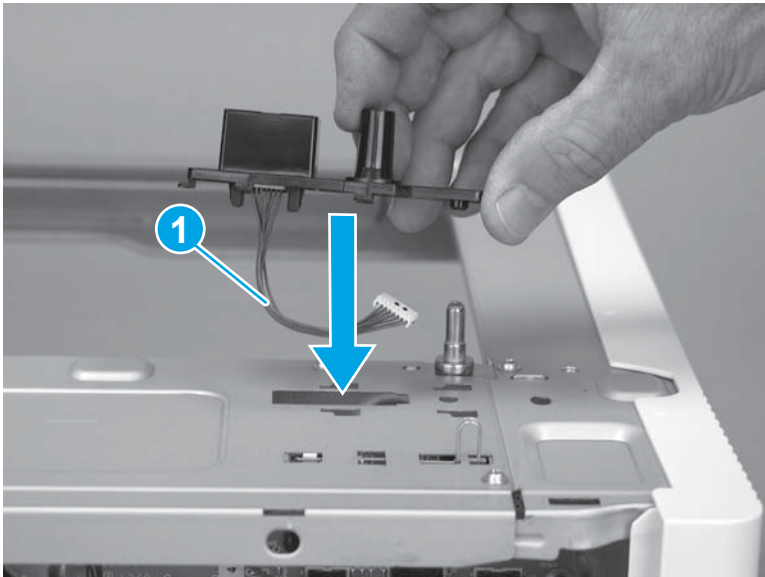
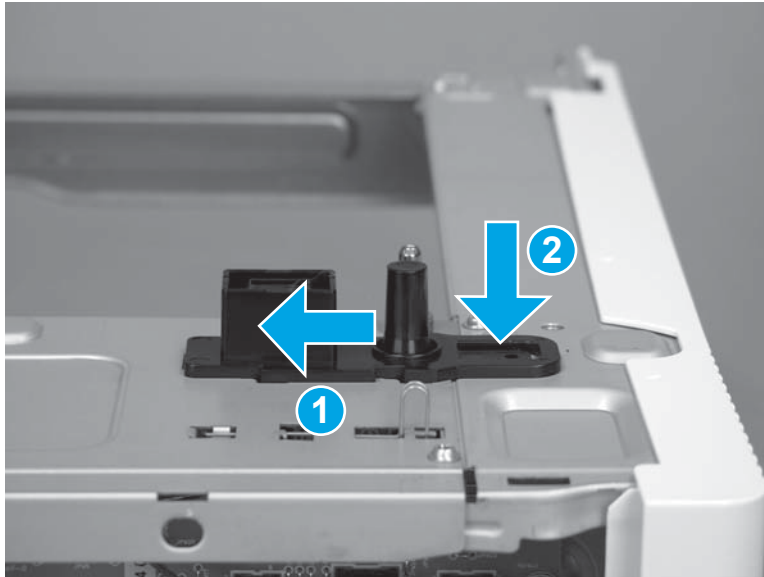

3. Connect one connector (callout 1; J901).

Figure 1-5261 Connect one connector

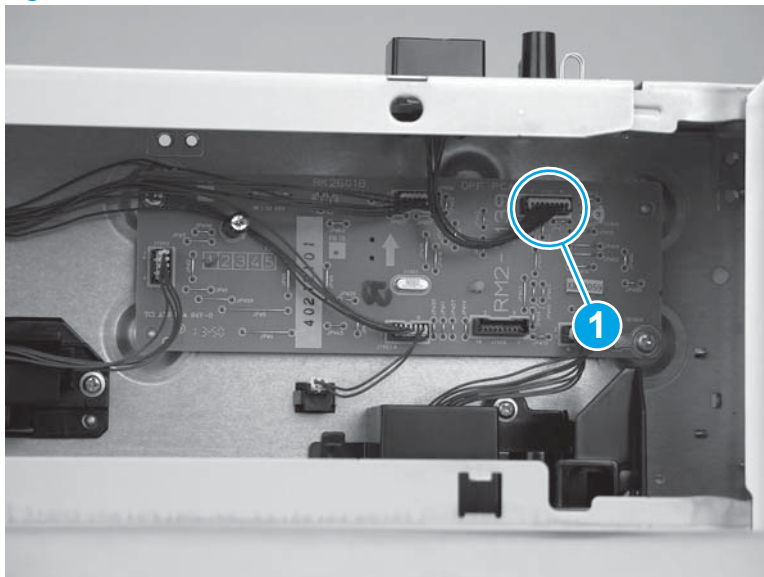

Step 10: Install the lower-right cover

1. Before proceeding, take note of the location of the three mounting tabs on the back side of the cover.

Figure 1-5262 Cover mounting tabs

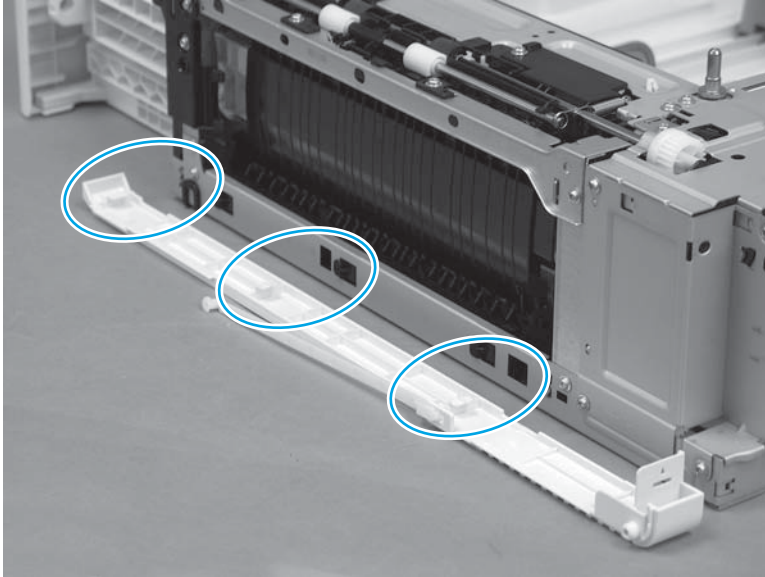

2. Align the three mounting tabs on the back side of the cover with the slots in the chassis.

Figure 1-5263 Install the right-lower cover

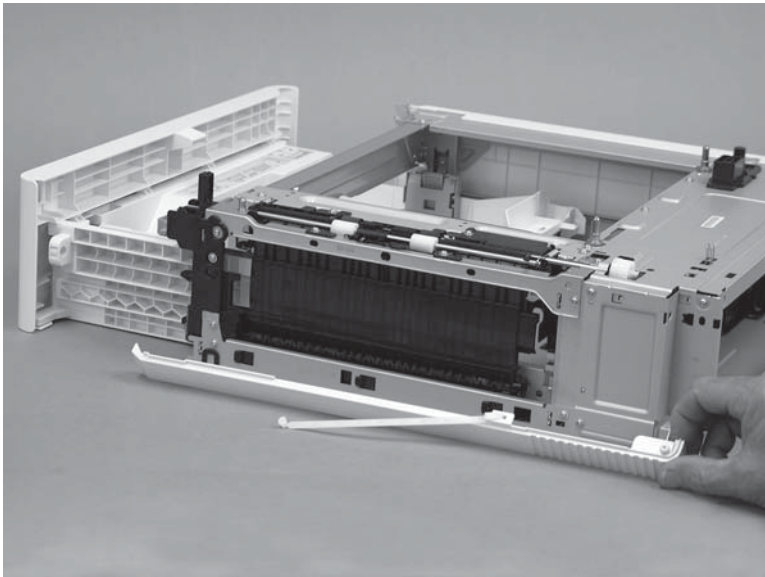

3. Press in on the middle tab (callout 1), slightly flex the end of the cover away from the accessory, and then slide it towards the rear of the accessory (callout 2) to engage the tabs with the slots.

CAUTION: The three mounting tabs on the back side of the cover are easily damaged. Do not over flex the end of the cover when it is installed.

Figure 1-5264 Engage the cover

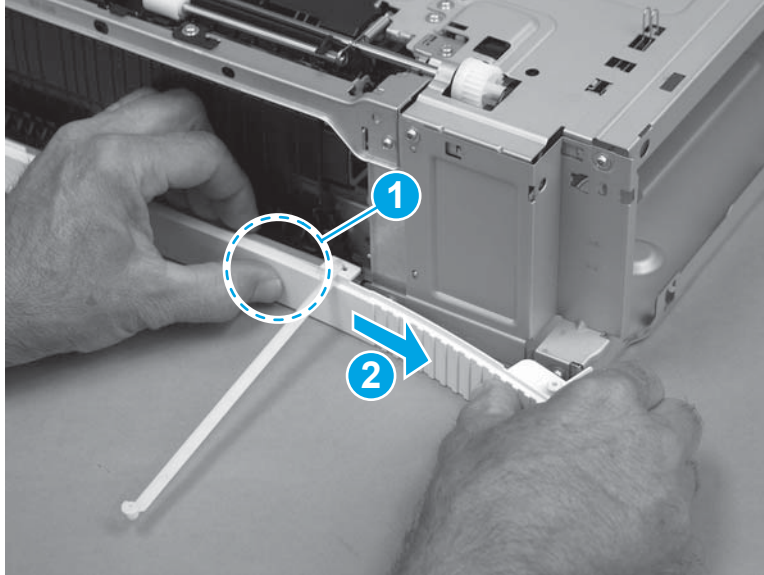

4. Verify that the end of the cover near the tray is correctly engaged with the chassis after installing the cover.

Figure 1-5265 Check the cover

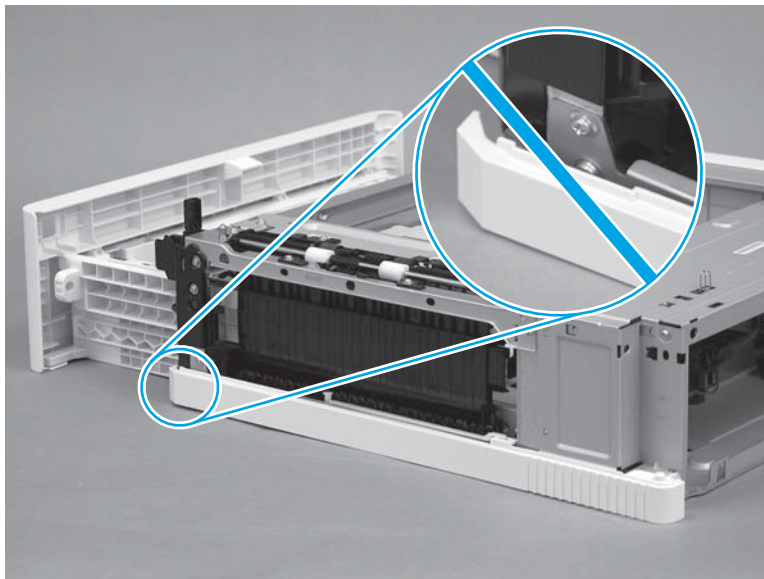

Step 11: Install the right door

1. Install the door link in the slot in the door to attach the door.

Figure 1-5266 Install the door link

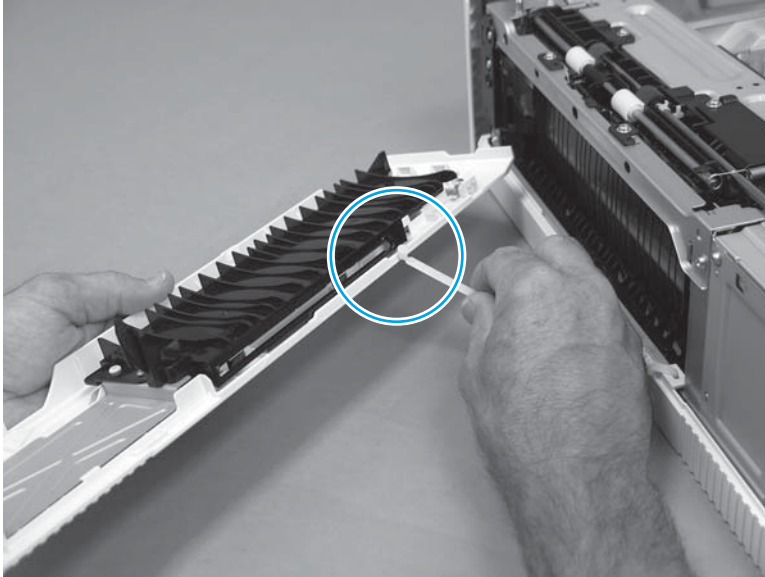

2. Position the lower hinge hole on the door (callout 2) on the lower hinge pin (callout 2) on the right-lower cover.

Figure 1-5267 Position the door on the lower hinge

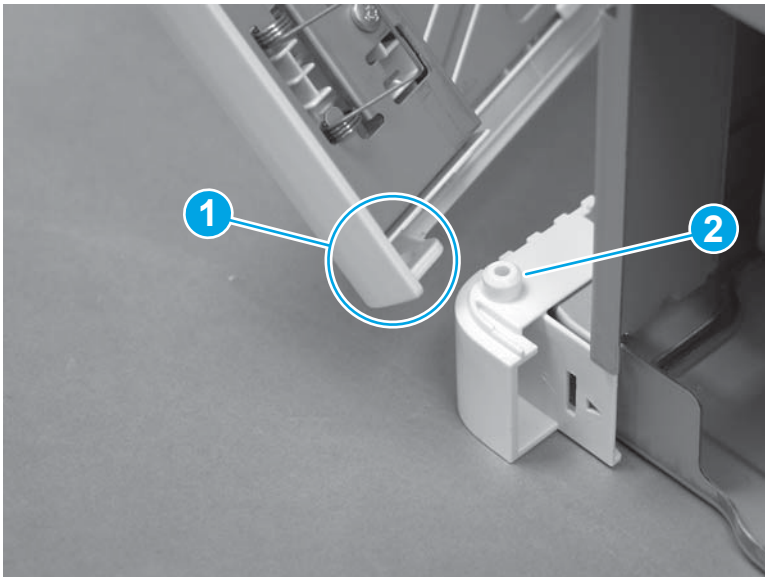

3. Align the pin of the door-hinge bracket (callout 1) with the hole in the chassis, and then align the mounting tabs (callout 2 and callout 3) with the slots in the chassis.

Figure 1-5268 Engage the hinge bracket

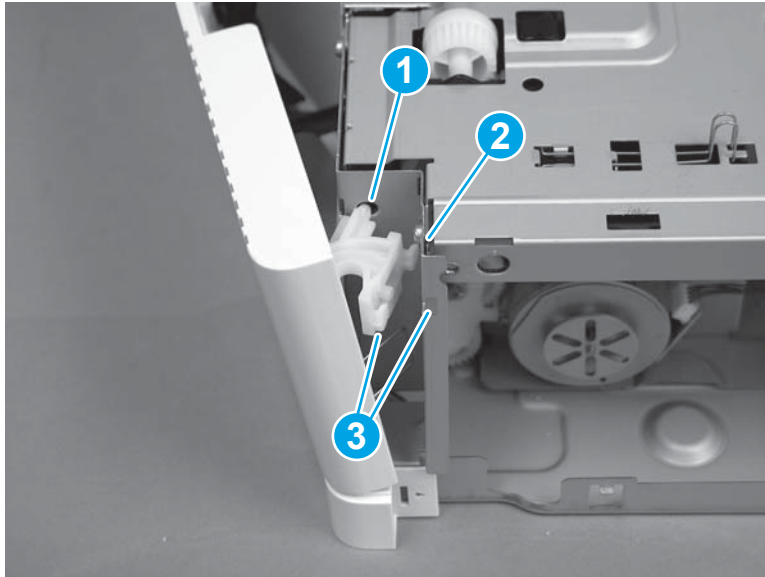

4. Push in on the door-hinge bracket (callout 1), and then slide it toward the chassis (callout 2) to install it.

Figure 1-5269 Install the hinge bracket

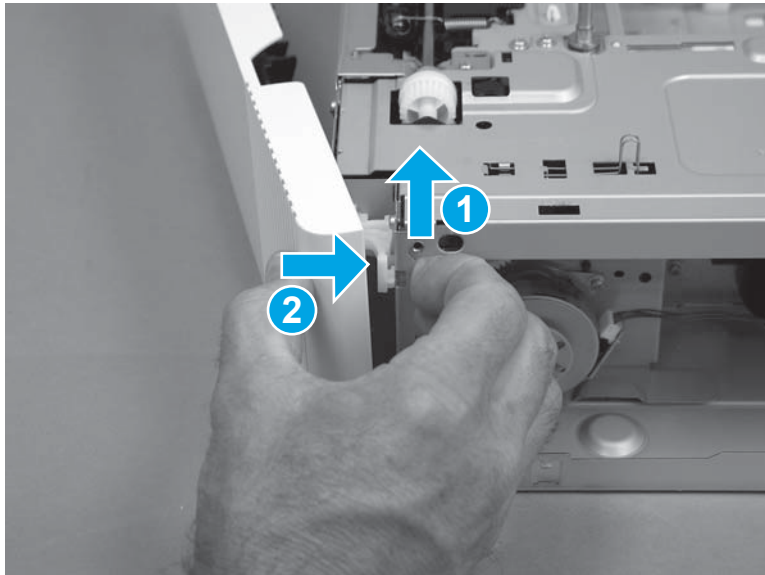

5. Close the door.

Figure 1-5270 Close the door

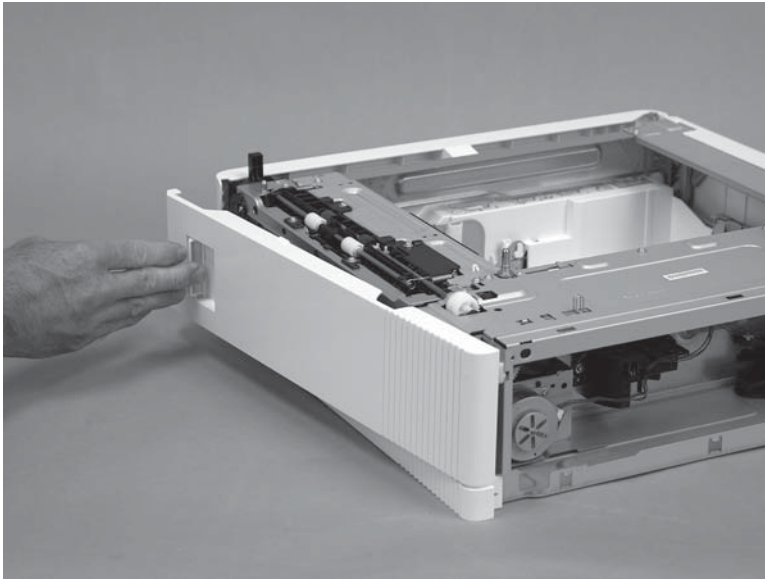

Step 12: Install the rear cover

1. Align the three mounting tabs (callout 1) on the cover with the slots in the chassis.

Figure 1-5271 Position the cover on the chassis

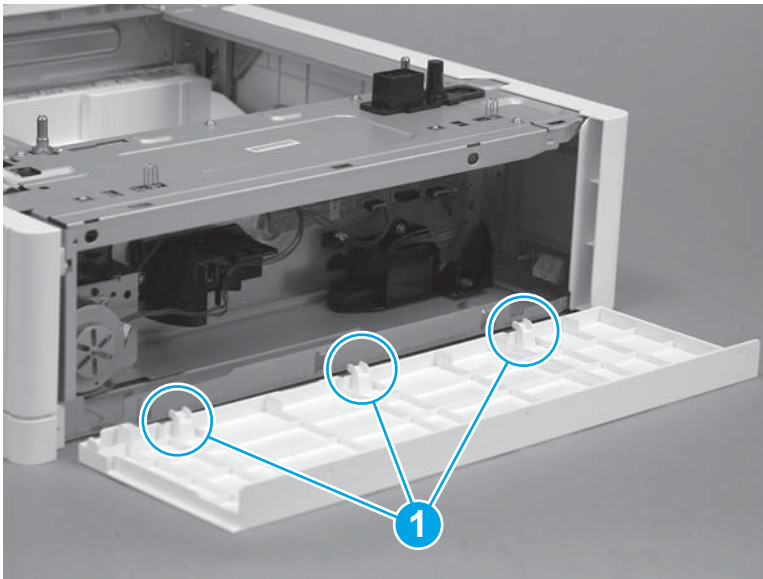

2. Position the cover on the accessory (callout 1), and then rotate the top of the cover up and onto the chassis (callout 2) to install it.

Figure 1-5272 Install the cover

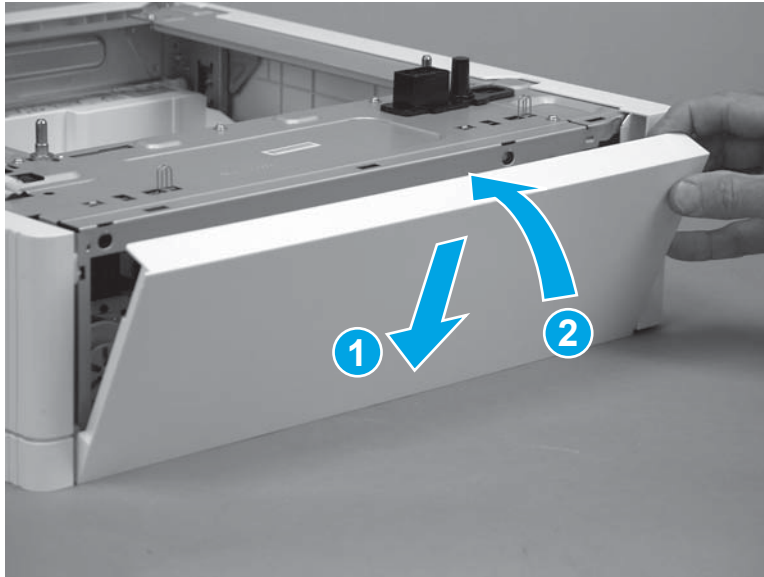

3. Make sure that the three tabs (callout 1) snap into place.

Figure 1-5273 Check the three tabs

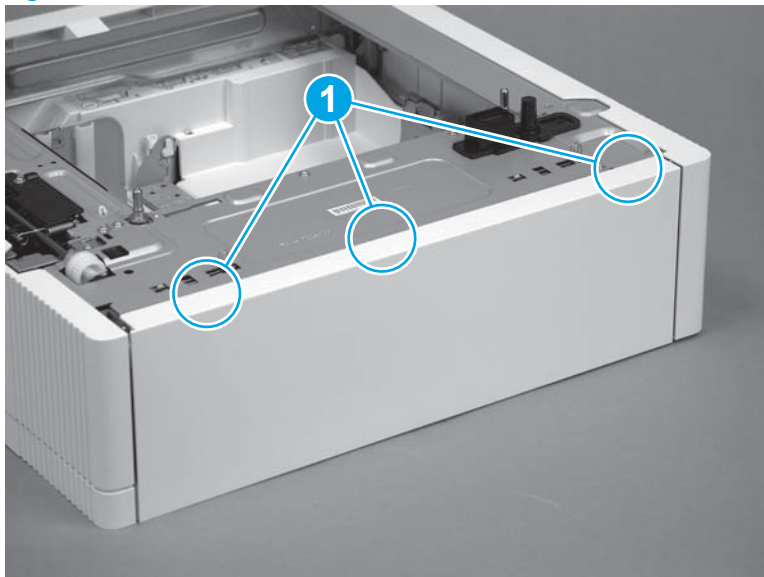

Step 13: Install the tray

1. With the front of the tray slightly lifted, align the sides of the tray with the rails in the printer, and then carefully slide the tray into the printer.

 **TIP:** As the tray slides into the accessory, lower the front of it.

Figure 1-5274 Install the tray



2. Close the tray.

Figure 1-5275 Close the tray

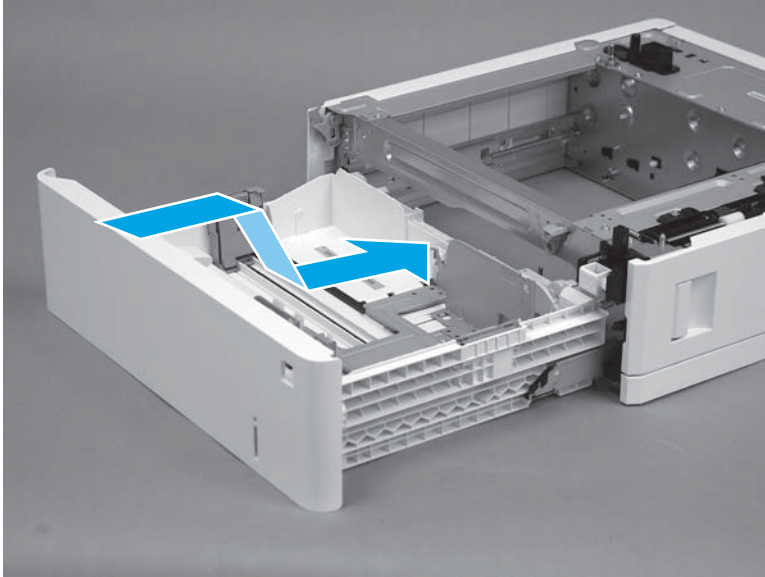
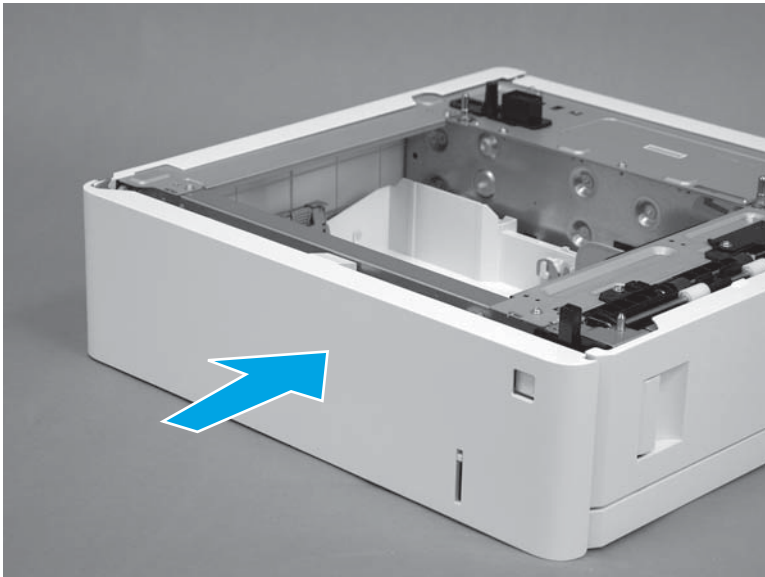

Removal and replacement: Lifter drive assembly (1x550-sheet paper feeder)

- [Introduction](#)
- [Step 1: Remove the tray](#)
- [Step 2: Remove the rear cover](#)
- [Step 3: Remove the right door](#)
- [Step 4: Remove the lower-right cover](#)
- [Step 5: Remove the drawer connector holder](#)
- [Step 6: Remove the feeder drive assembly](#)
- [Step 7: Remove the lifter drive assembly](#)
- [Step 8: Unpack the replacement assembly](#)
- [Step 9: Install the lifter drive assembly](#)
- [Step 10: Install the feeder drive assembly](#)
- [Step 11: Install the drawer connector holder](#)
- [Step 12: Install the lower-right cover](#)
- [Step 13: Install the right door](#)
- [Step 14: Install the rear cover](#)
- [Step 15: Install the tray](#)

Introduction

This document provides the procedures to remove and replace the 1x550-sheet paper feeder lifter drive assembly.

Before performing service

Use the table below to identify the correct part number for your printer, and then go to <http://h20141.www2.hp.com/hpparts> to order the part.

Lifter drive assembly (1x550-sheet paper feeder) part number	
RM2-5149-000CN	Lifter drive assembly (1x550-sheet paper feeder)

Required tools

- #2 Phillips screwdriver with a magnetic tip and a 152-mm (6-in) shaft length
- Small, flat-blade screwdriver

After performing service

Make sure that the rear cover is flush against the chassis after replacing it.

Make sure that the right door latches correctly when closed after replacing it.

Make sure that Tray 3 is fully closed after replacing it.

Post service test

Print a page from a host computer using the appropriate tray as the source tray.

Step 1: Remove the tray

1. Pull the tray out until it stops.

Figure 1-5276 Pull the tray out

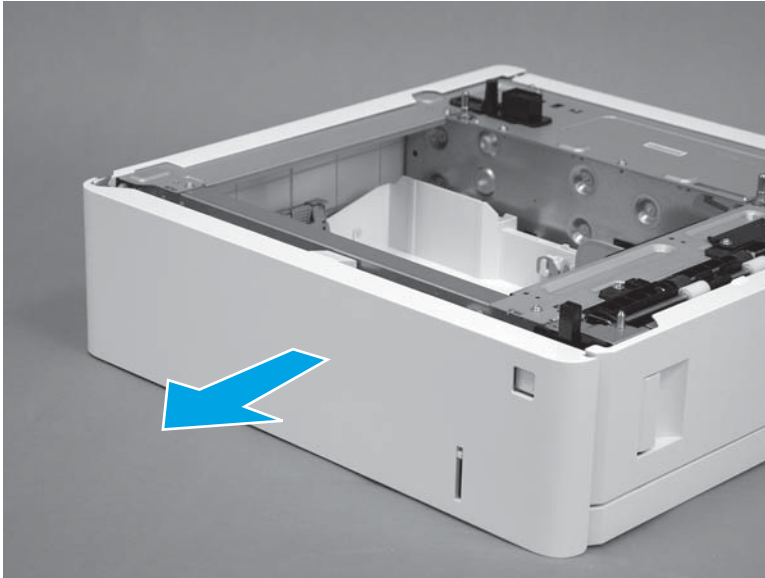

2. Lift the front of the tray, and then pull it out of the printer to remove it.

Figure 1-5277 Remove the tray

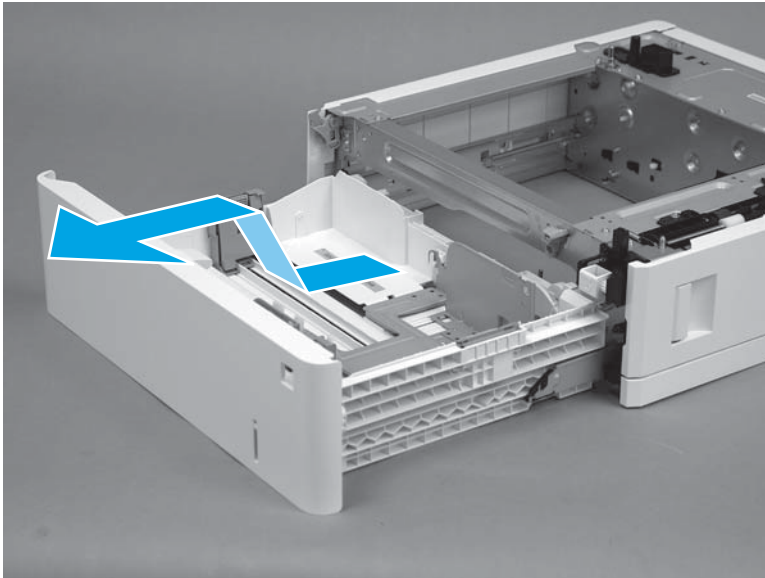

Step 2: Remove the rear cover

1. Release three tabs (callout 1).

Figure 1-5278 Release three tabs

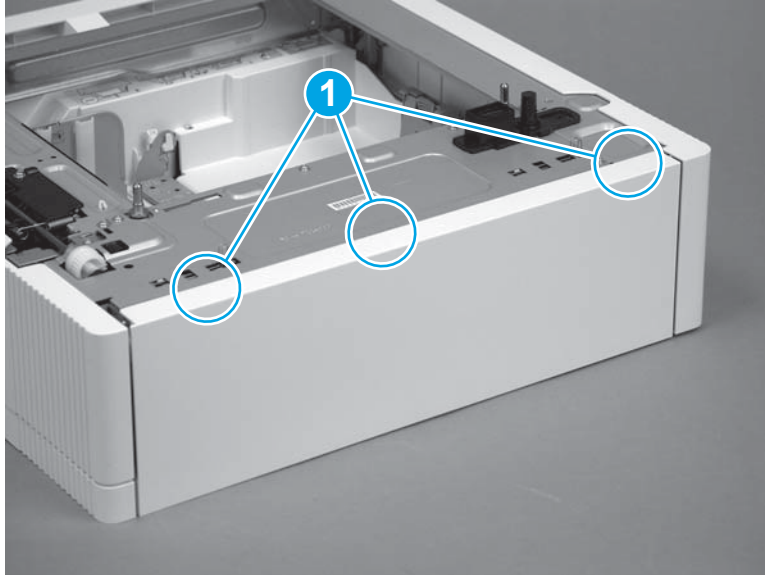

2. Rotate the top of the cover away from the accessory (callout 1), and then lift it up to remove it (callout 2).

Figure 1-5279 Remove the cover

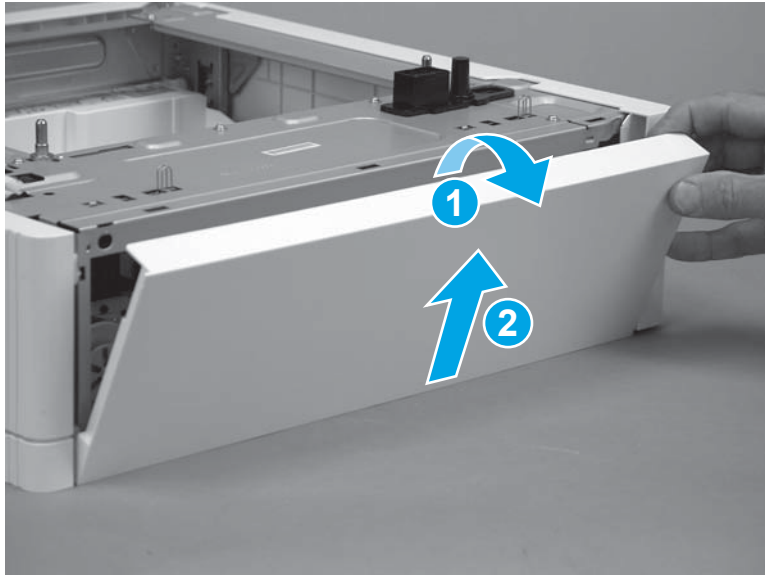

Step 3: Remove the right door

1. Open the door.

Figure 1-5280 Open the door

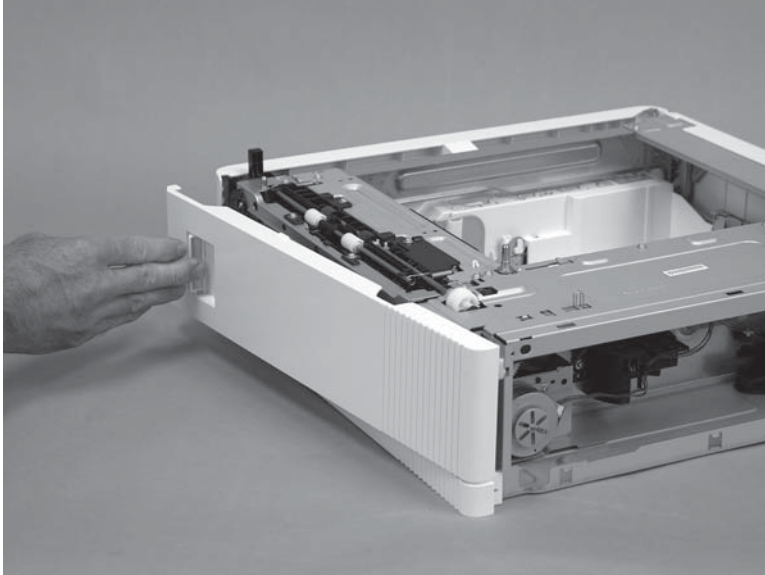

2. Release one tab (callout 1), and then slide the door-hinge bracket away from the chassis (callout 2) to release it.

Figure 1-5281 Release the hinge bracket

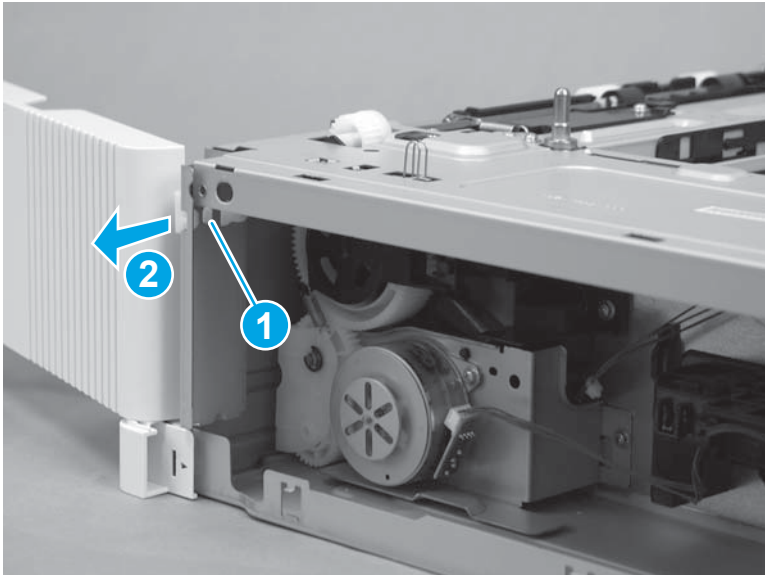

3. Remove the door-hinge bracket from the chassis.

CAUTION: The door is still attached to the accessory by the door link. Do not attempt to completely remove the door.

The door hinge bracket is not captive. Do not lose it when handling the door.

Figure 1-5282 Remove the hinge bracket

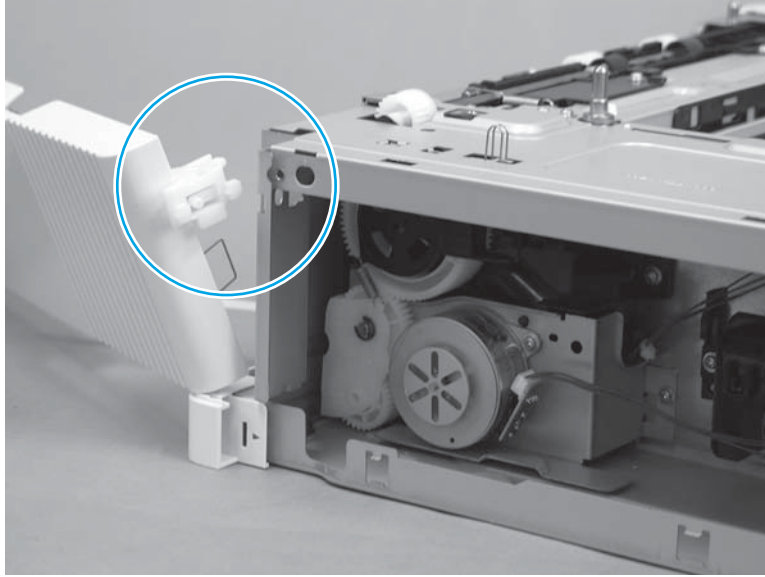

4. Release the door link from the slot in the door to remove the right door.

Figure 1-5283 Release the door link

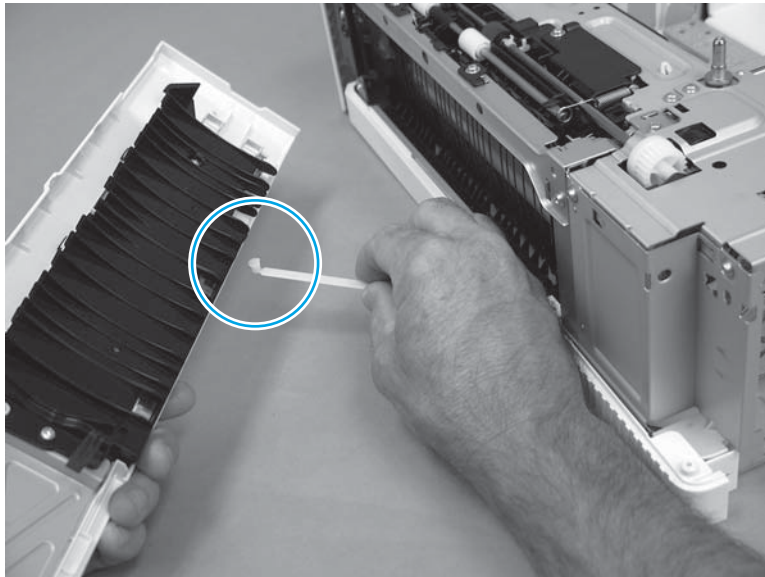

Step 4: Remove the lower-right cover

1. Before proceeding, take note of the location of the three mounting tabs on the back side of the cover.

Figure 1-5284 Cover mounting tabs

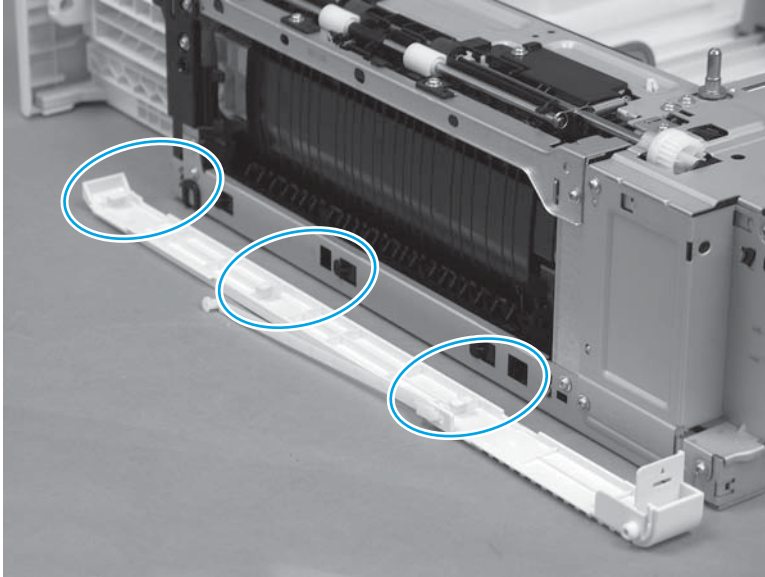

2. Partially open the tray, slightly flex the end of the cover away from the accessory (callout 1), and then slide it towards the front of the accessory (callout 2) to release it.

⚠ CAUTION: The three mounting tabs on the back side of the cover are easily damaged. Do not over flex the end of the cover when it is released. Push in on the middle tab to protect it when removing the cover.

Figure 1-5285 Release the cover

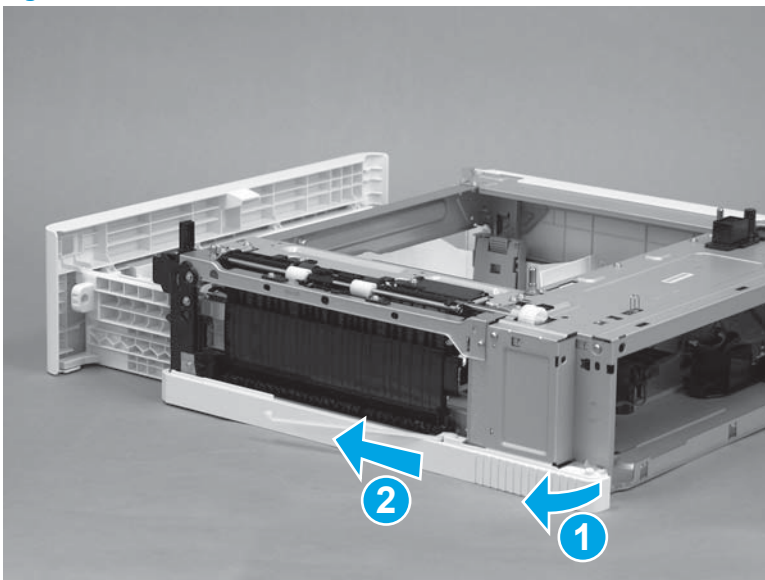

3. Remove the right-lower cover.

Figure 1-5286 Remove the right-lower cover

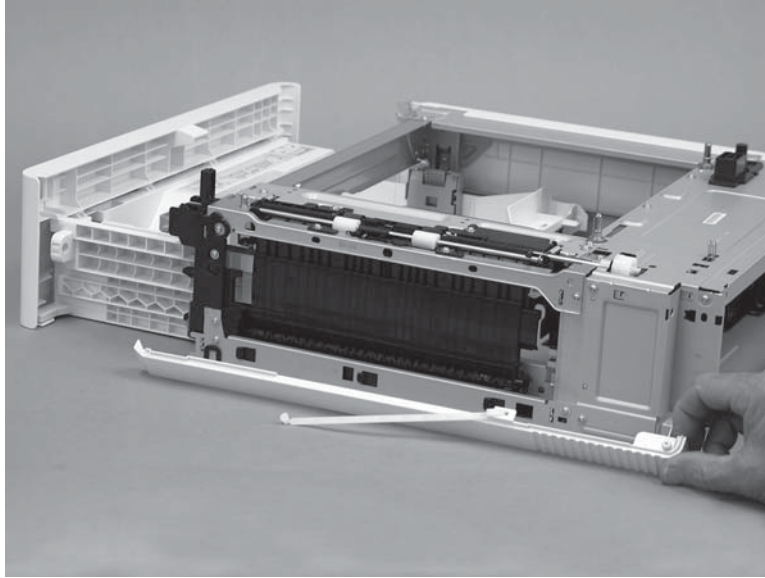

Step 5: Remove the drawer connector holder

1. Disconnect one connector (callout 1; J901).

Figure 1-5287 Disconnect one connector

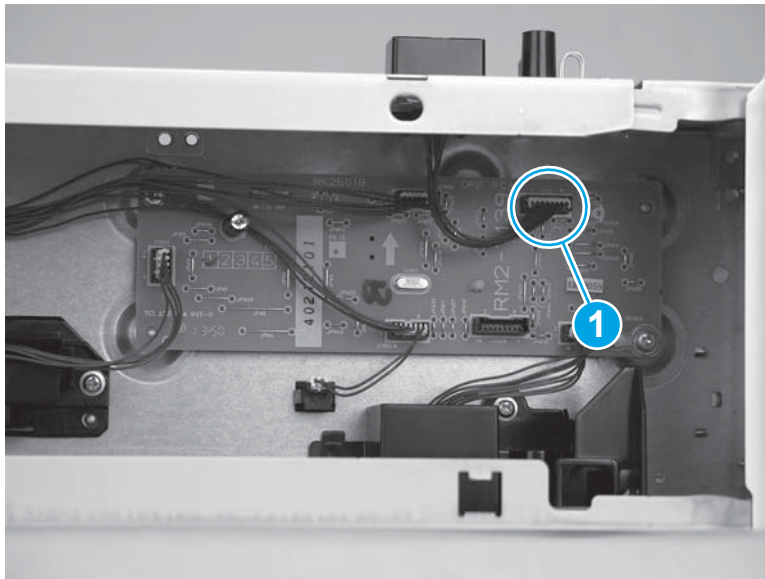

2. Release one tab (callout 1), and then slide the drawer connector holder as shown (callout 2) to release it.

Figure 1-5288 Release one tab

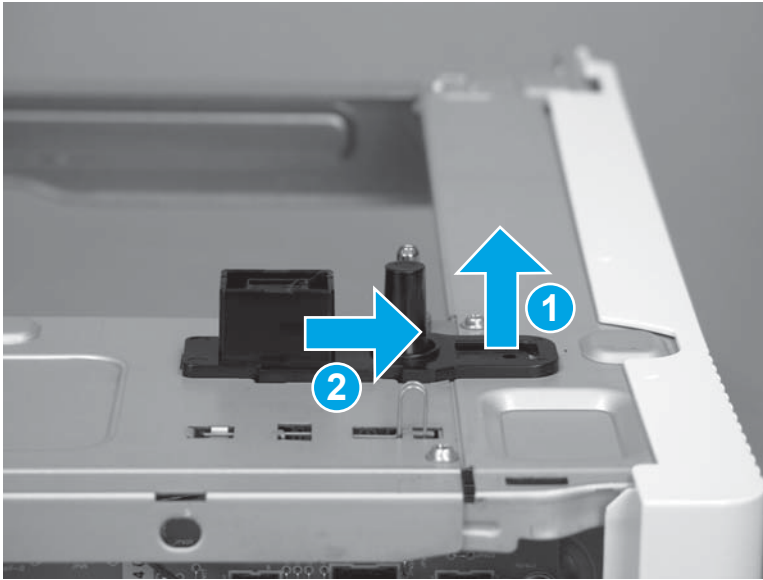

3. Remove the drawer connector holder.

Figure 1-5289 Remove the tray connector

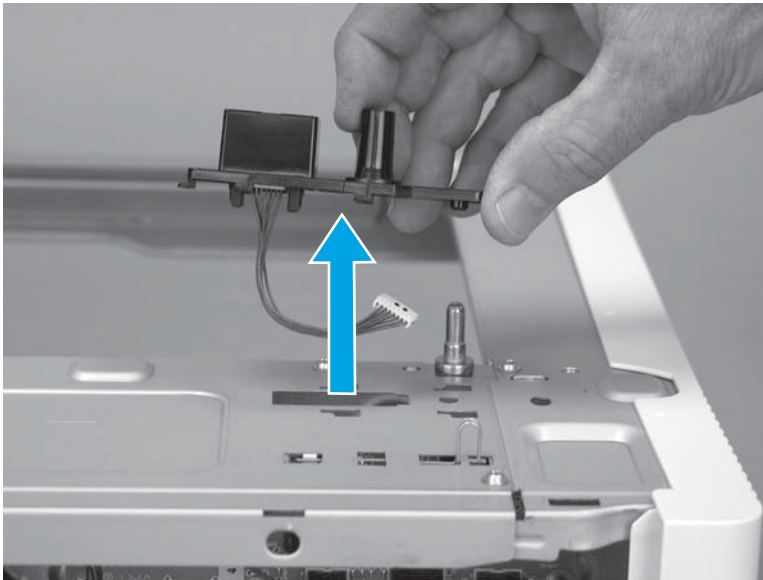

Step 6: Remove the feeder drive assembly

1. Remove six screws (callout 1).

Figure 1-5290 Remove six screws

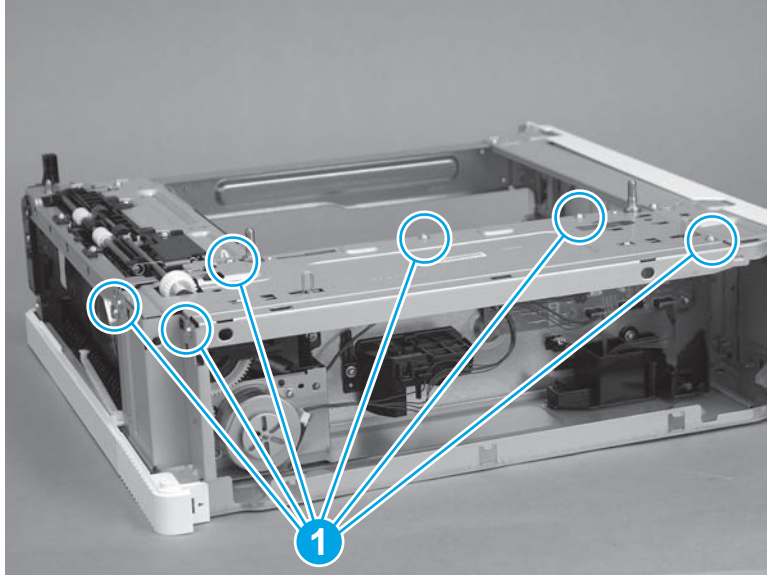

2. Remove the sheet-metal plate.

Figure 1-5291 Remove the sheet-metal plate

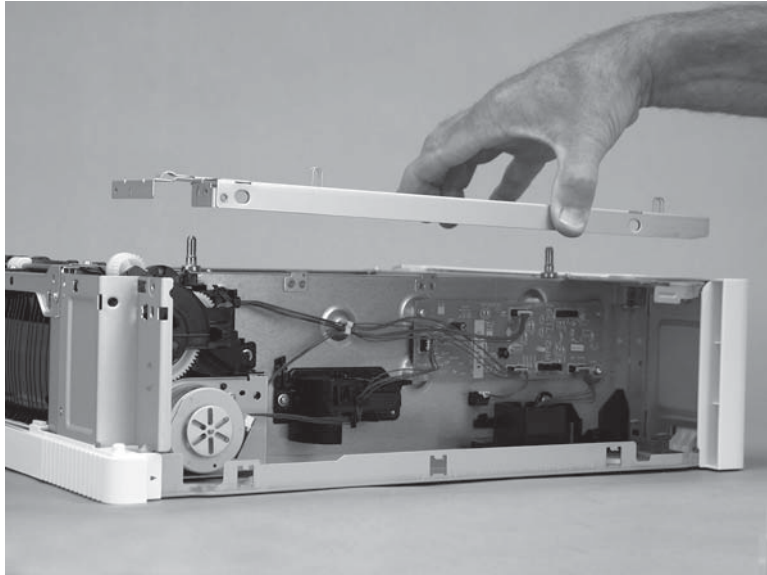

3. Remove two screws (callout 1).

Figure 1-5292 Remove two screws

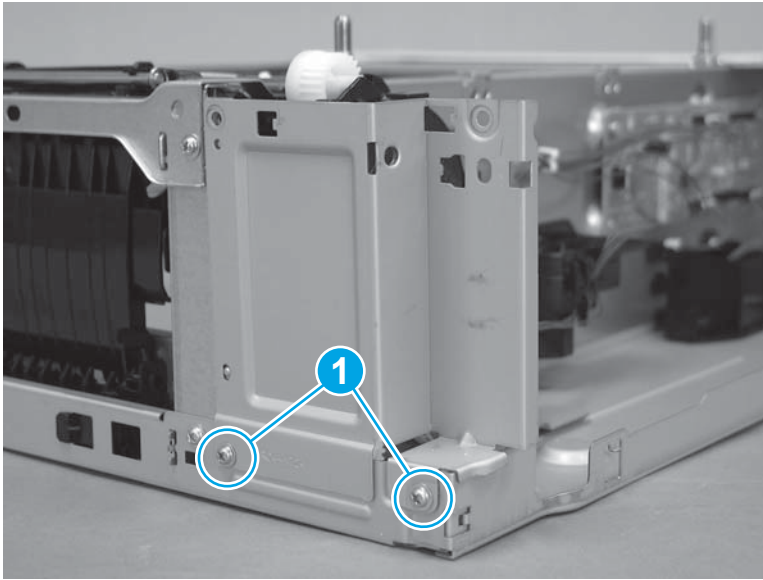

4. Remove the sheet-metal plate.

Figure 1-5293 Remove the sheet-metal plate

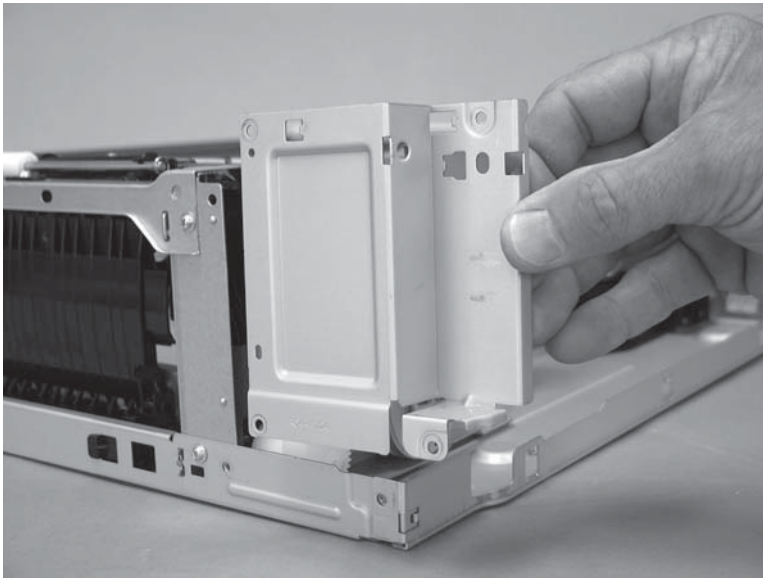

5. Disconnect one connector (callout 1).

Figure 1-5294 Disconnect one connector

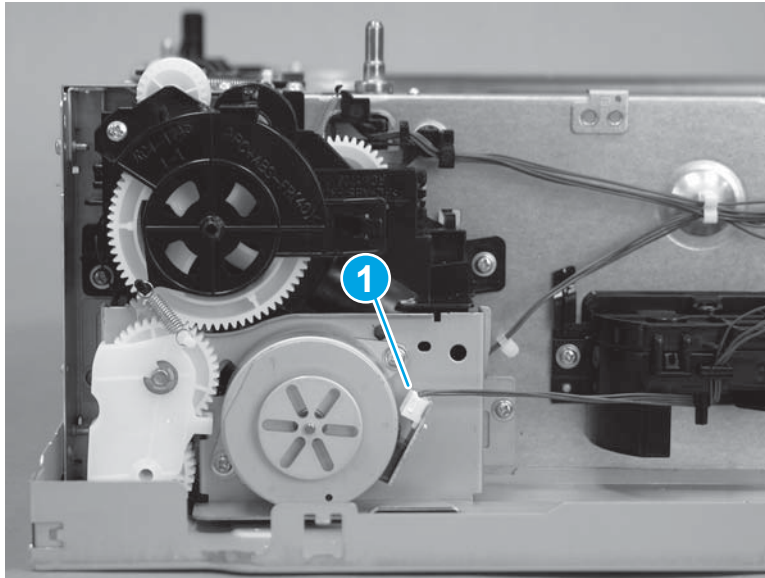

6. Remove one spring (callout 1).

Figure 1-5295 Remove one spring

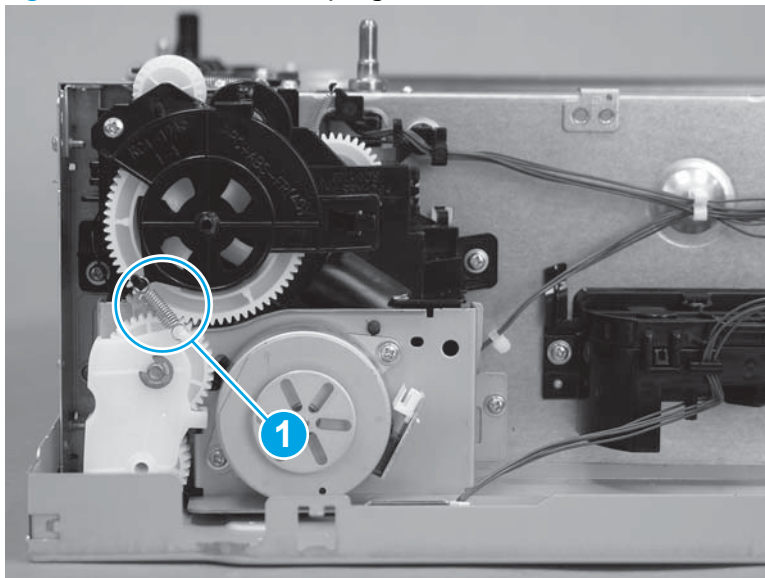

7. Remove two screws (callout 1).

Figure 1-5296 Remove two screws

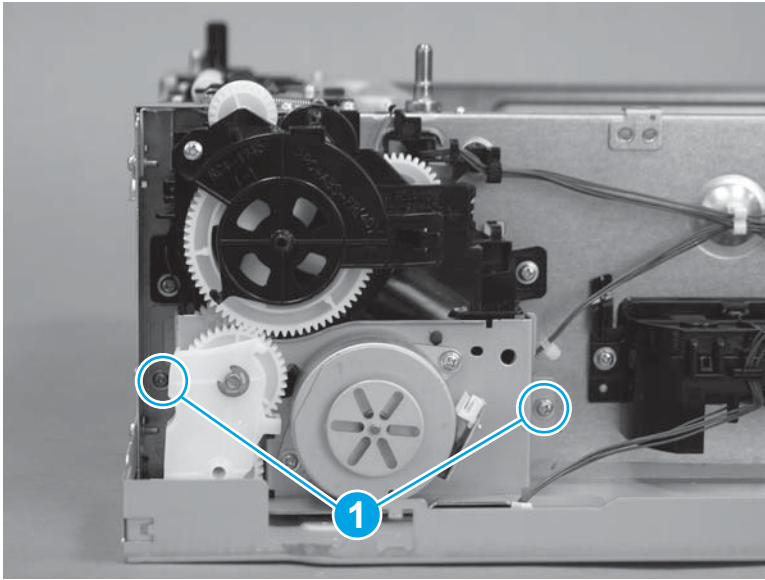

8. Remove the feeder drive assembly.

CAUTION: If the assembly is being removed to access another part, take care not to wipe any of the grease off of the gears.

Figure 1-5297 Remove the assembly

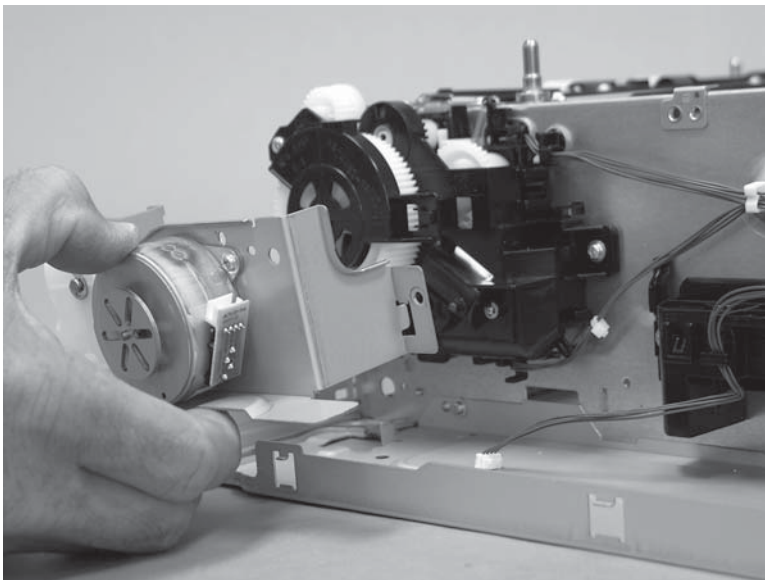

Step 7: Remove the lifter drive assembly

1. Disconnect one connector (callout 1; J904), and then release the wire harness from the retainer (callout 2) and the guide (callout 3).

Figure 1-5298 Disconnect one connector

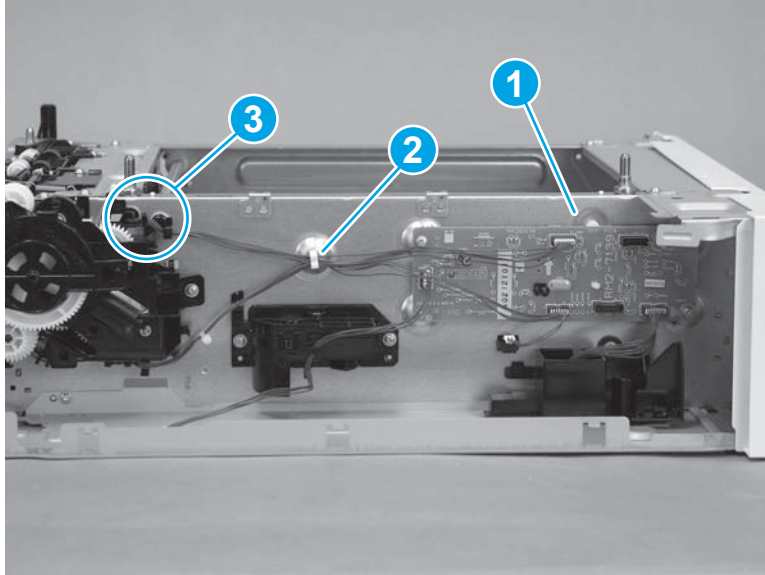

2. Disconnect two connectors (callout 1; J902 and the switch button), and then release the wire harness from the retainer (callout 2).

Figure 1-5299 Disconnect two connectors

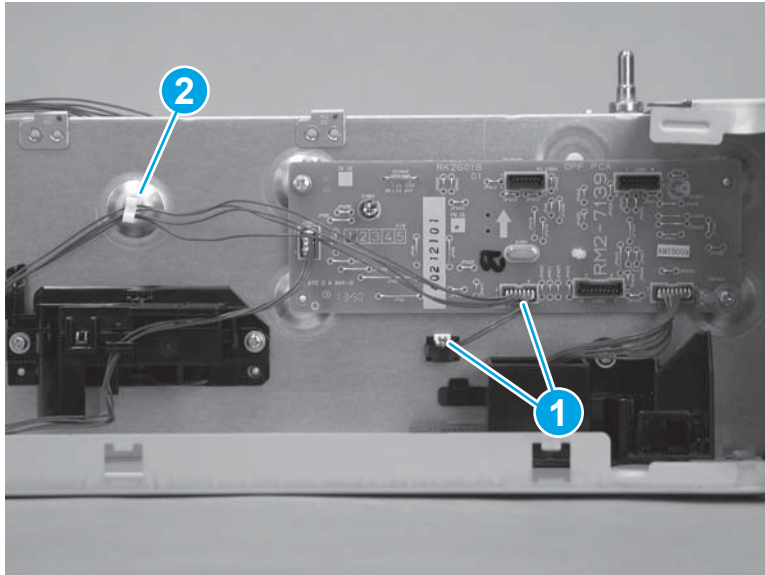

3. Remove two screws (callout 1).

Figure 1-5300 Remove two screws

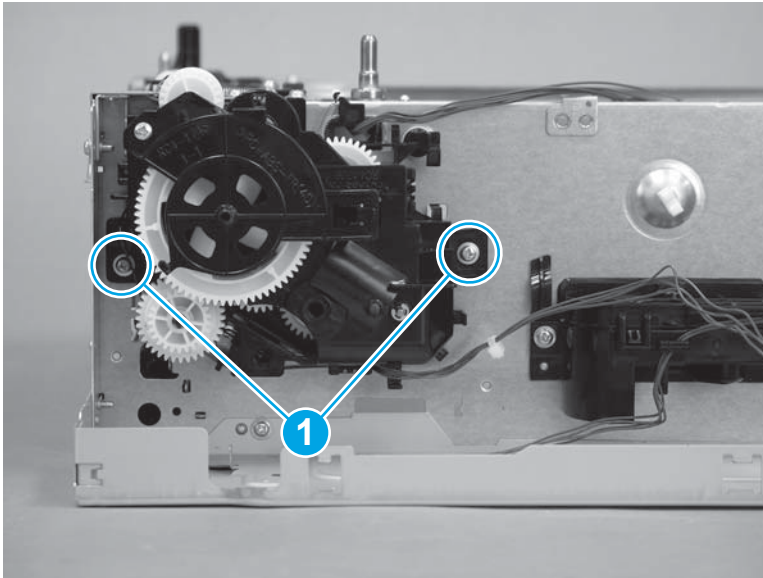

4. Release one tab (callout 1), and then slightly pull the lifter drive assembly away from the chassis to release one gear (callout 2).

Figure 1-5301 Release one tab

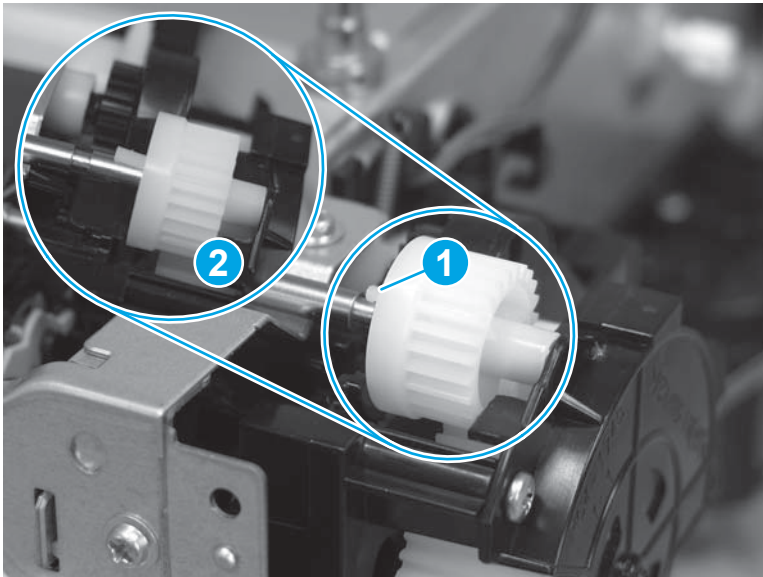

5. Release two tabs (callout 1), and then rotate the assembly—as shown—away from the chassis (callout 2) to release it.

Figure 1-5302 Release two tabs

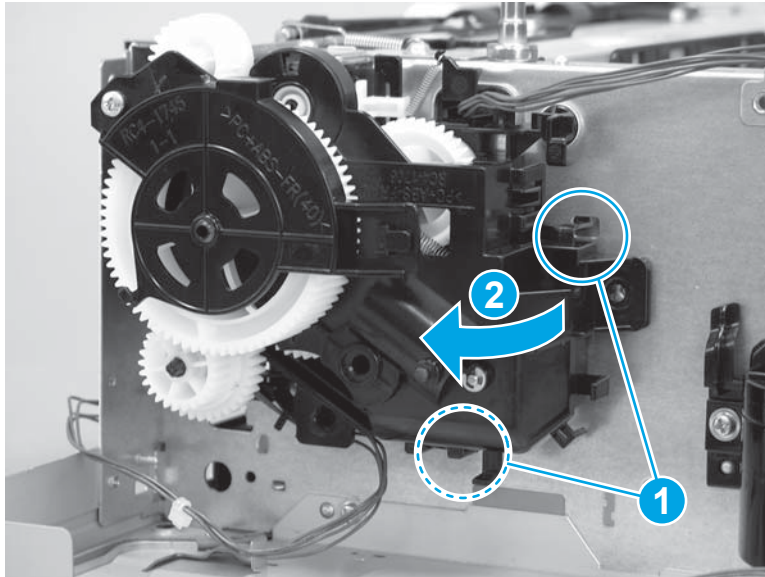

6. To remove the lifter drive assembly, feed the wire harness through the opening (callout 1) in the assembly.

 **Reinstallation tip:** If a replacement assembly is installed, transfer the gear (callout 2) to the replacement assembly.

Figure 1-5303 Remove the assembly



Step 8: Unpack the replacement assembly

Unpack the replacement assembly from the packaging.

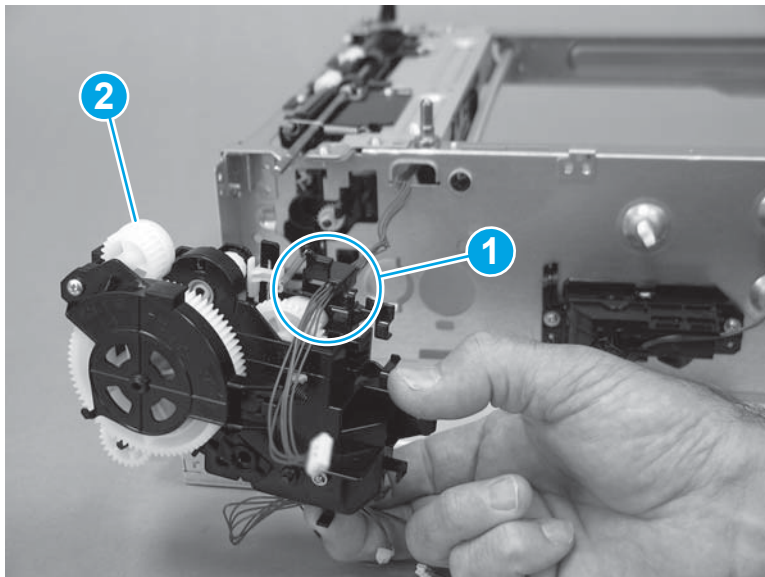
For complete information on HP's recycling programs, go to [Product return and recycling](#).

CAUTION: When handling the replacement assembly, take care not to wipe any of the grease off of the gears.

NOTE: HP recommends responsible disposal of the defective assembly.

Figure 1-5304 Recycle and unpack

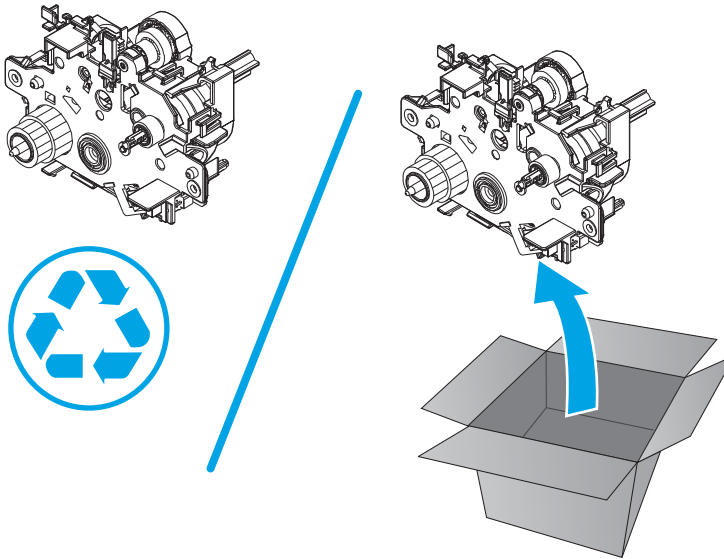

Step 9: Install the lifter drive assembly

1. Feed the wire harness through the opening in the assembly (callout 1), and then position the lifter drive assembly near the chassis to install it.

TIP: Make sure that the gear (callout 2) was transferred from the discarded assembly to the replacement assembly.

Figure 1-5305 Install the assembly

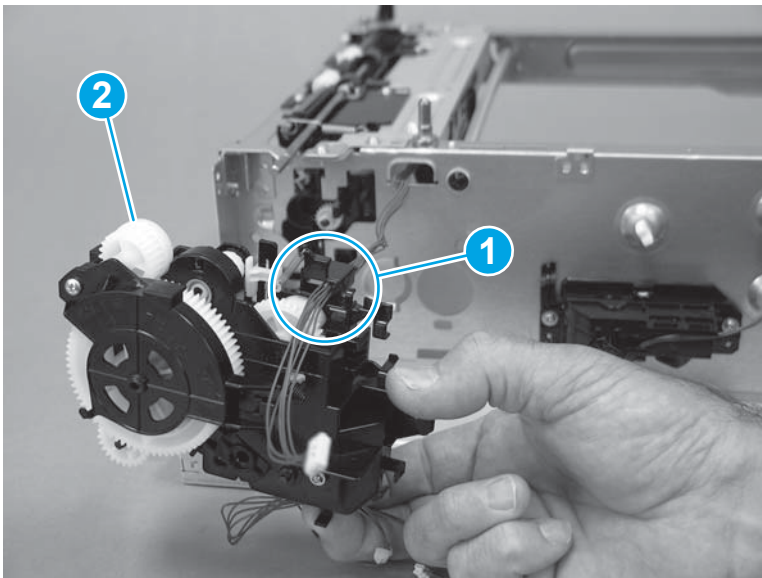

2. Insert the keyed end of the shaft into the gear (callout 1) on the lifter drive assembly—turn the shaft on the paper feed assembly or the gear on the lifter drive assembly to align the keyed shaft with the gear.

 **IMPORTANT:** When the assembly is fully installed, the tab on the gear snaps into place.

Figure 1-5306 Install the gear on the shaft



3. Install the assembly on the chassis, and then make sure that the two tabs (callout 1) snap into place.

Figure 1-5307 Install the assembly

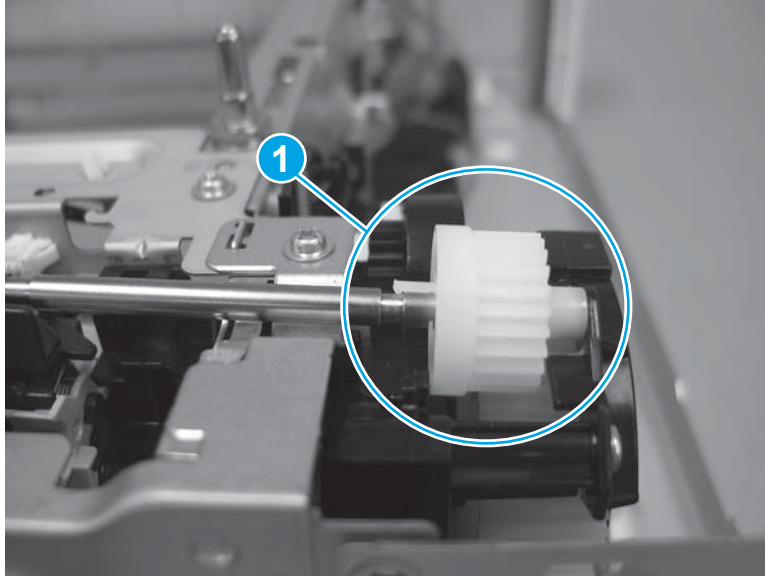
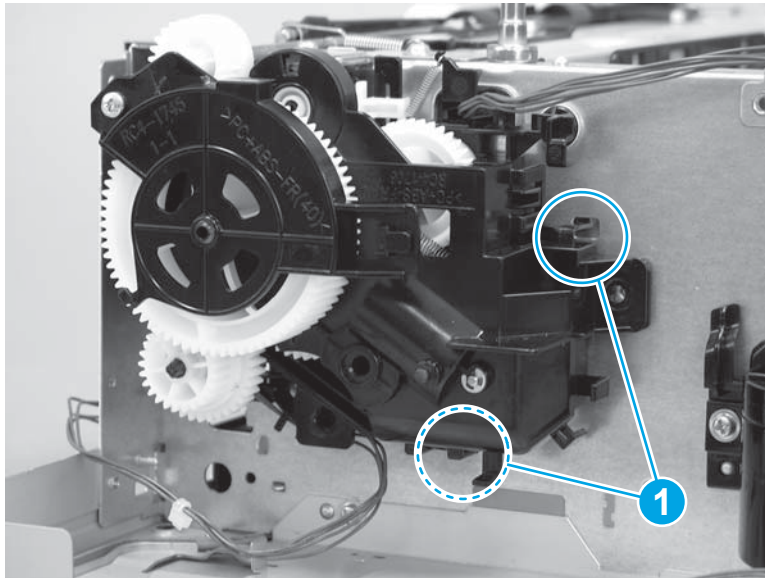

4. Install two screws (callout 1).

Figure 1-5308 Install two screws

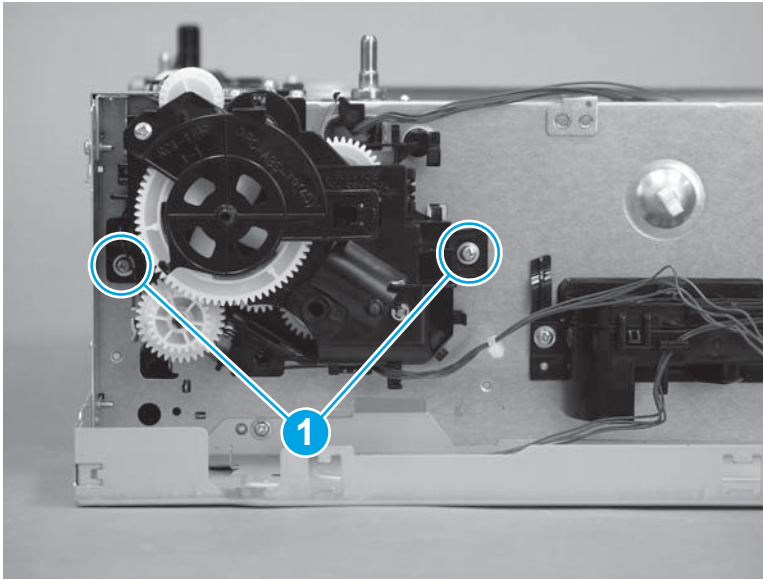

5. Install the wire harness in the retainer (callout 1), and then connect two connectors (callout 2; J902 and the switch button).

Figure 1-5309 Connect two connectors

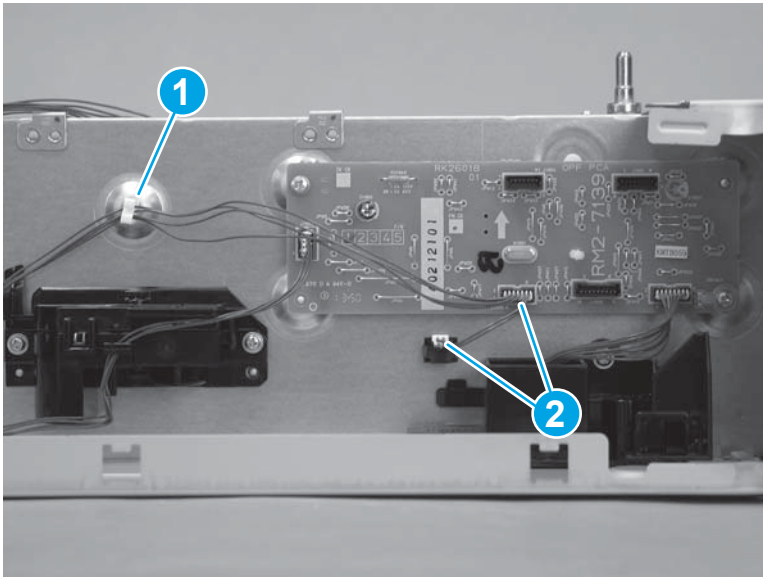

6. Install the wire harness in the guide (callout 1) and retainer (callout 2), and then connect one connector (callout 3; J904).

Figure 1-5310 Connect one connector

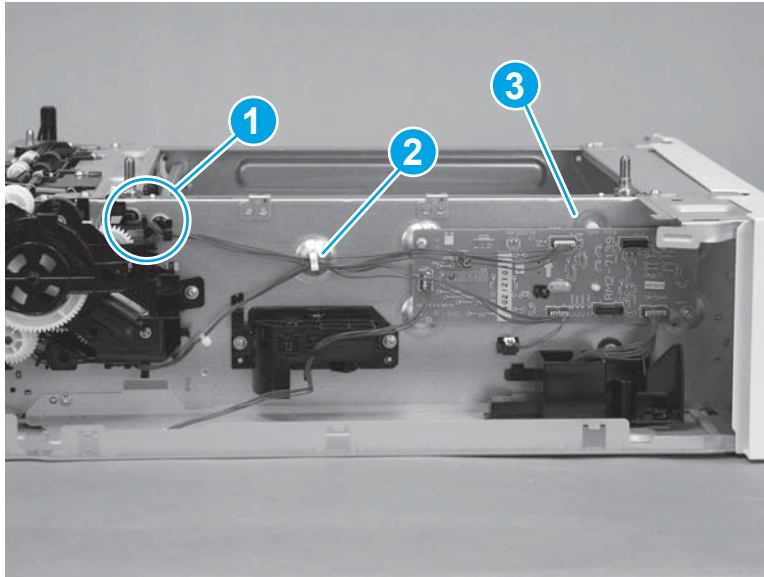

Step 10: Install the feeder drive assembly

1. Position the feeder drive assembly in the chassis.

⚠ CAUTION: When handling the assembly, take care not to wipe any of the grease off of the gears.

Figure 1-5311 Install the assembly

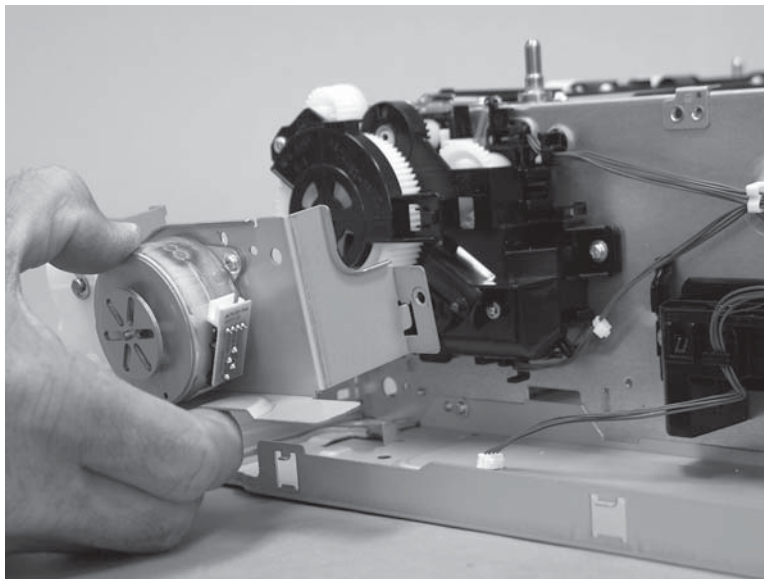

2. Install two screws (callout 1).

Figure 1-5312 Install two screws

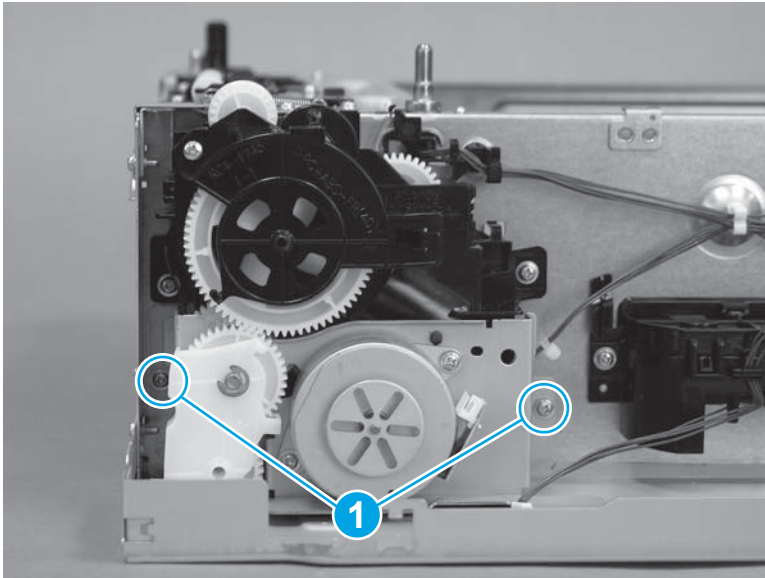

3. Install one spring (callout 1).

Figure 1-5313 Install one spring

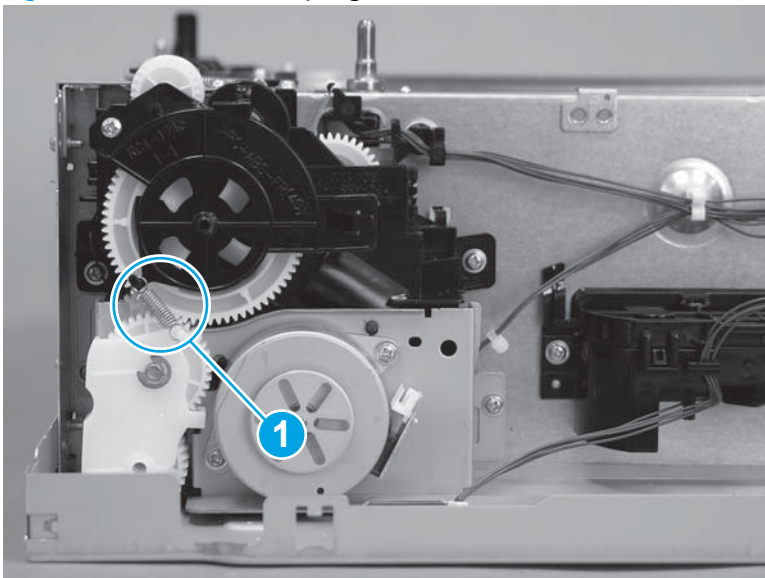

4. Connect one connector (callout 1).

Figure 1-5314 Connect one connector

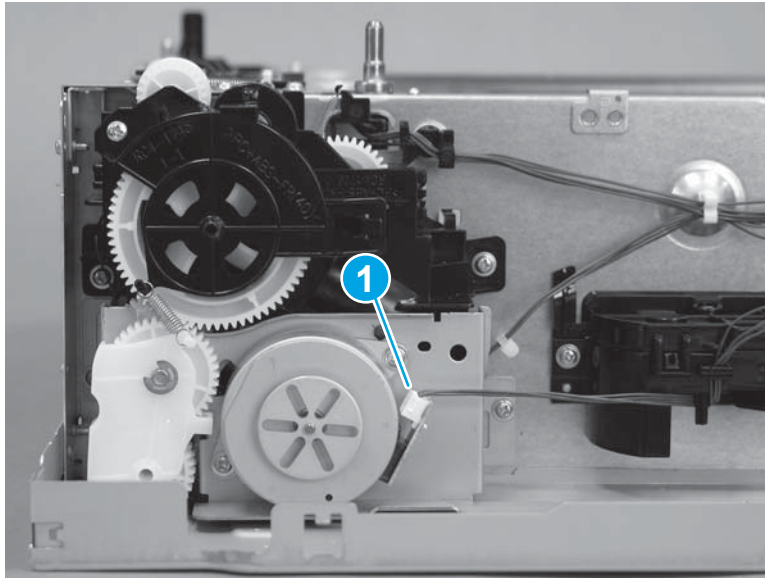

5. Position the sheet-metal plate on the chassis.

Figure 1-5315 Install the sheet-metal plate

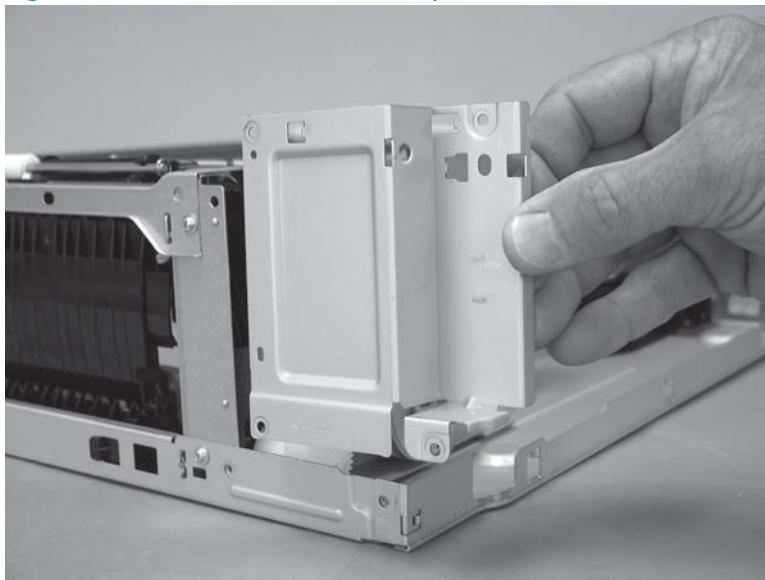

6. Install two screws (callout 1).

Figure 1-5316 Install two screws

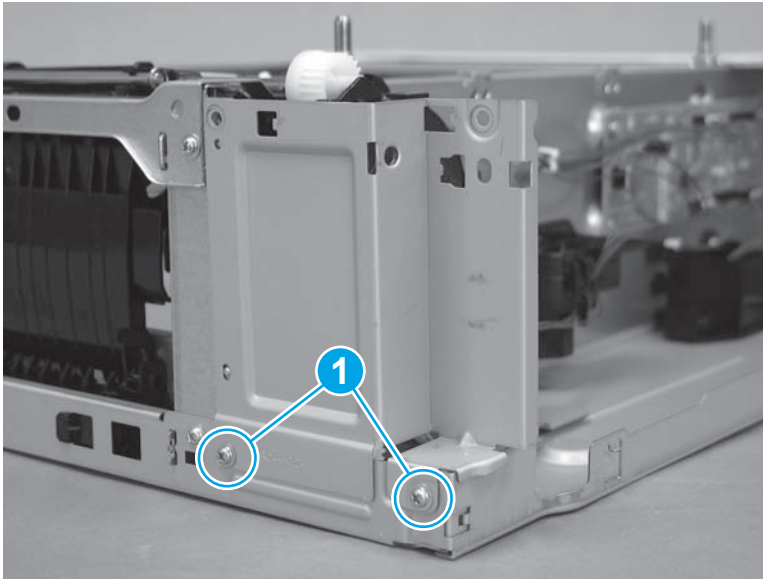

7. Position the sheet-metal plate on the chassis.

Figure 1-5317 Install the sheet-metal plate

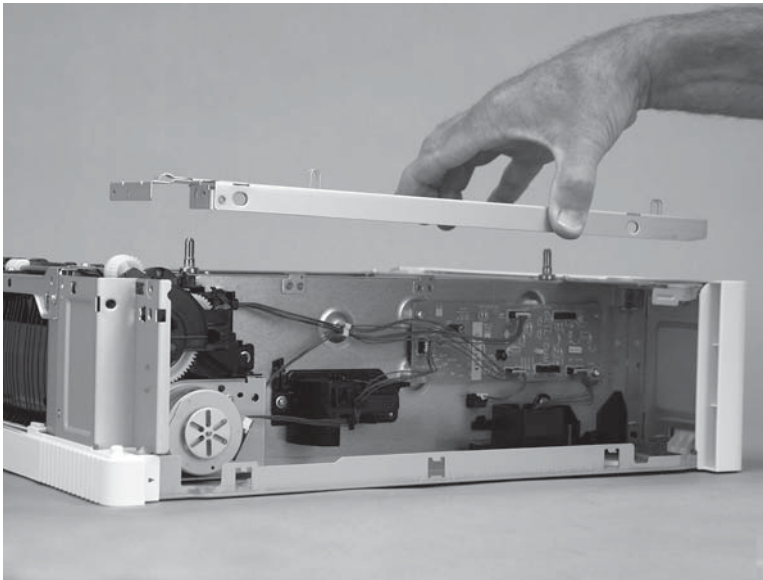

8. Install six screws (callout 1).

Figure 1-5318 Install six screws

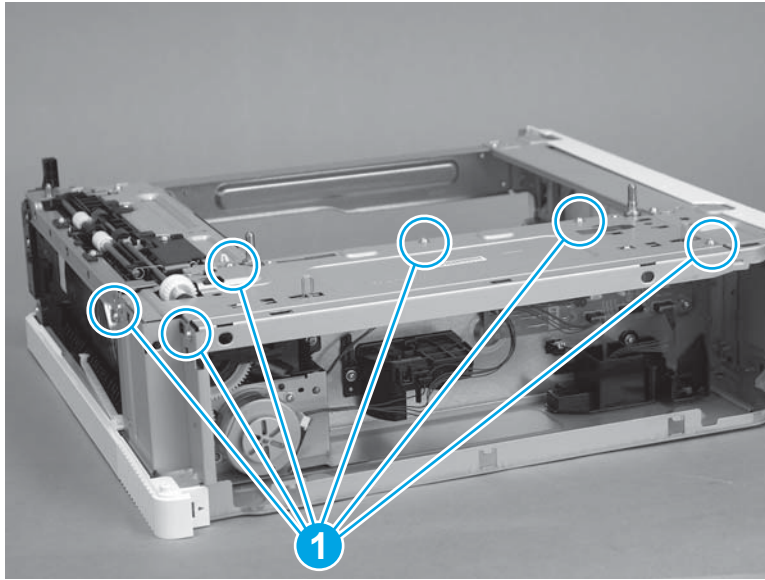

Step 11: Install the drawer connector holder

1. Position the drawer connector holder on the chassis.

 **NOTE:** Make sure that the wire harness (callout 1) was transferred from the discarded assembly to the replacement assembly.

Figure 1-5319 Place the tray connector on the accessory



2. Slide the drawer connector holder as shown (callout 1) to install it, and then make sure that one tab (callout 2) snaps into place .

Figure 1-5320 Install the tray connector

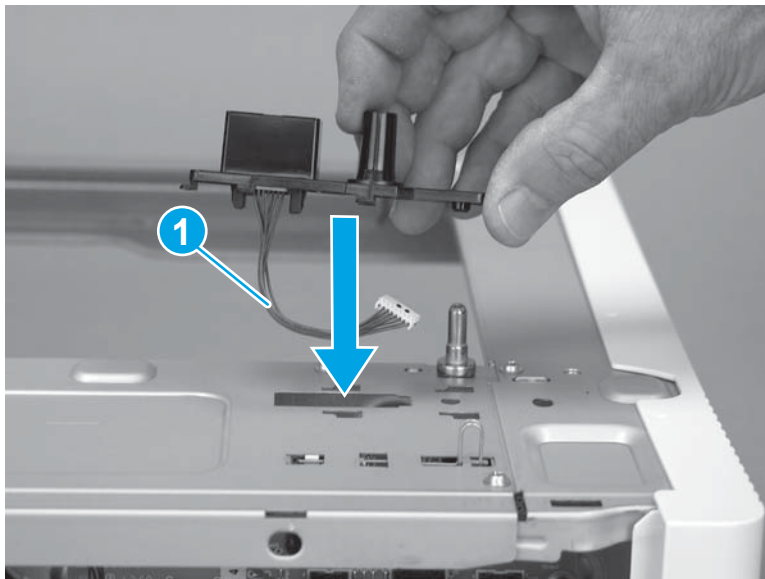
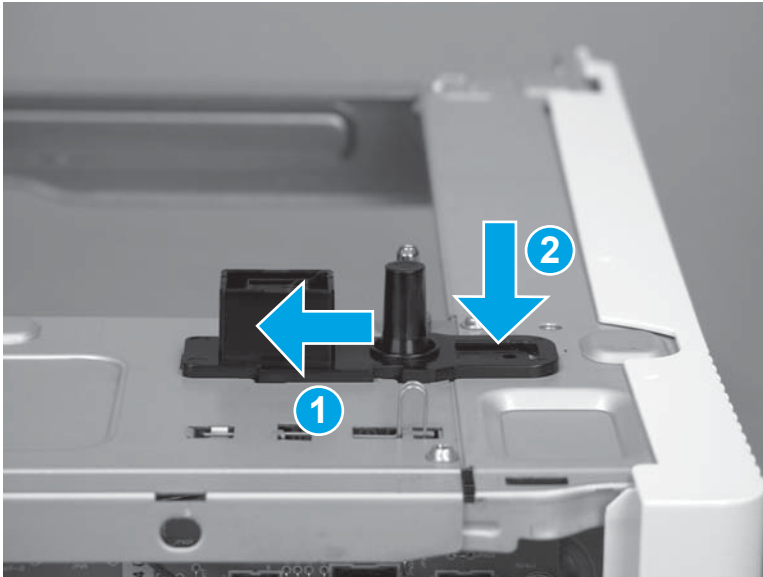

3. Connect one connector (callout 1; J901).

Figure 1-5321 Connect one connector

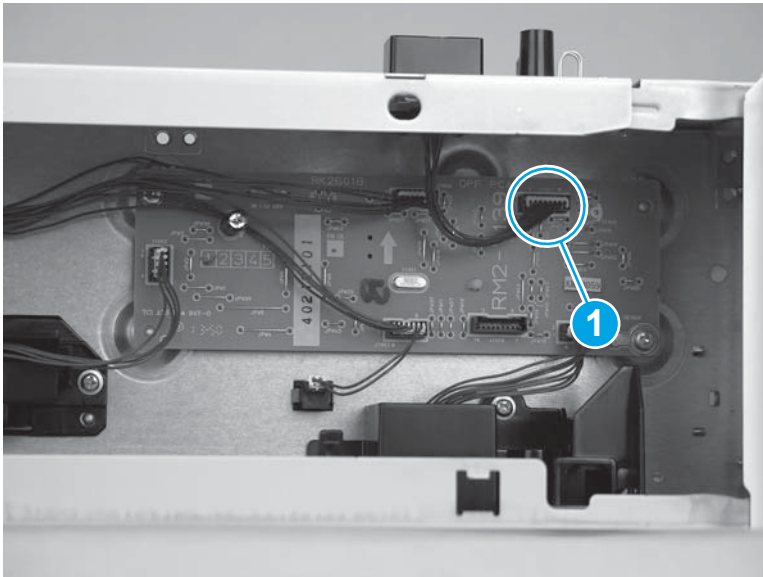

Step 12: Install the lower-right cover

1. Before proceeding, take note of the location of the three mounting tabs on the back side of the cover.

Figure 1-5322 Cover mounting tabs

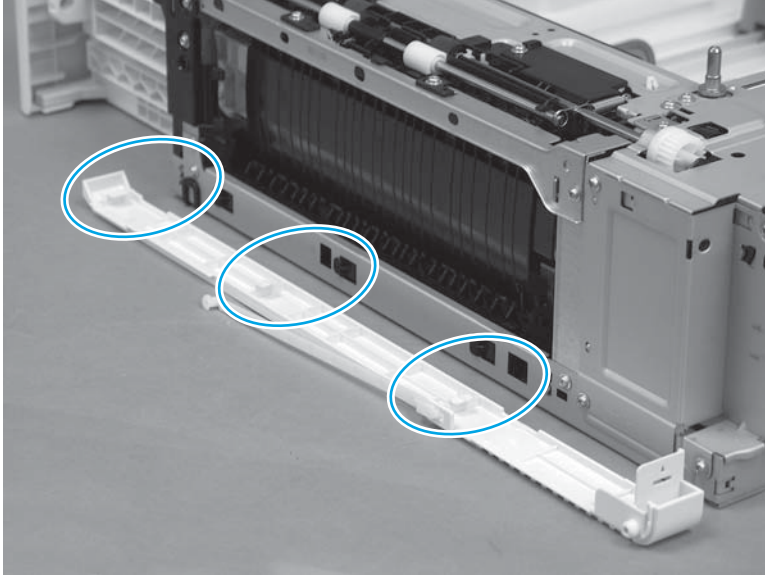

2. Align the three mounting tabs on the back side of the cover with the slots in the chassis.

Figure 1-5323 Install the right-lower cover

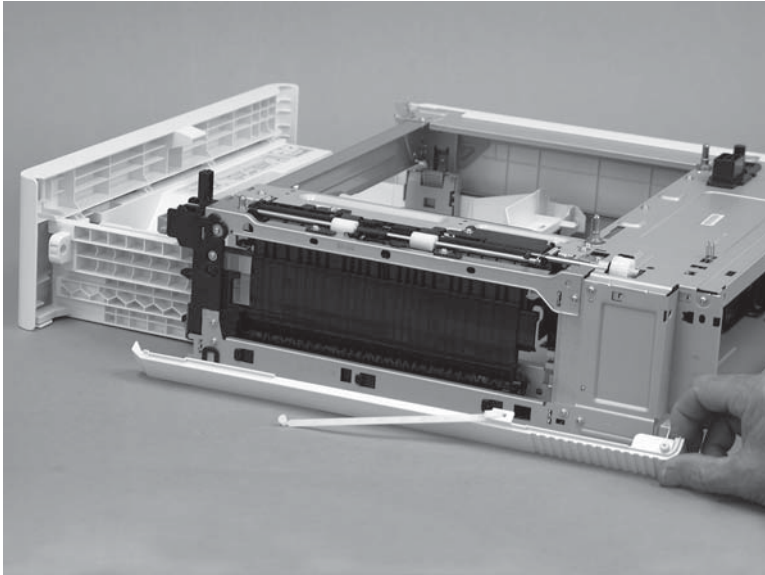

3. Press in on the middle tab (callout 1), slightly flex the end of the cover away from the accessory, and then slide it towards the rear of the accessory (callout 2) to engage the tabs with the slots.

⚠ CAUTION: The three mounting tabs on the back side of the cover are easily damaged. Do not over flex the end of the cover when it is installed.

Figure 1-5324 Engage the cover

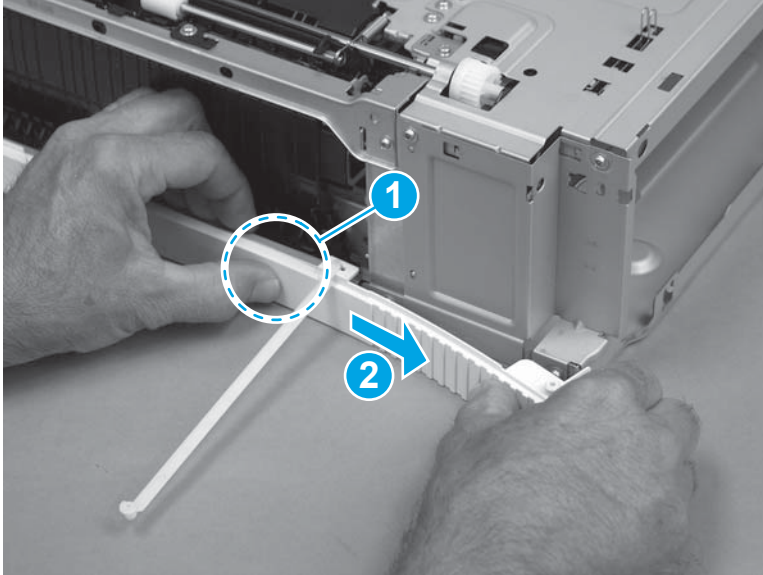

4. Verify that the end of the cover near the tray is correctly engaged with the chassis after installing the cover.

Figure 1-5325 Check the cover

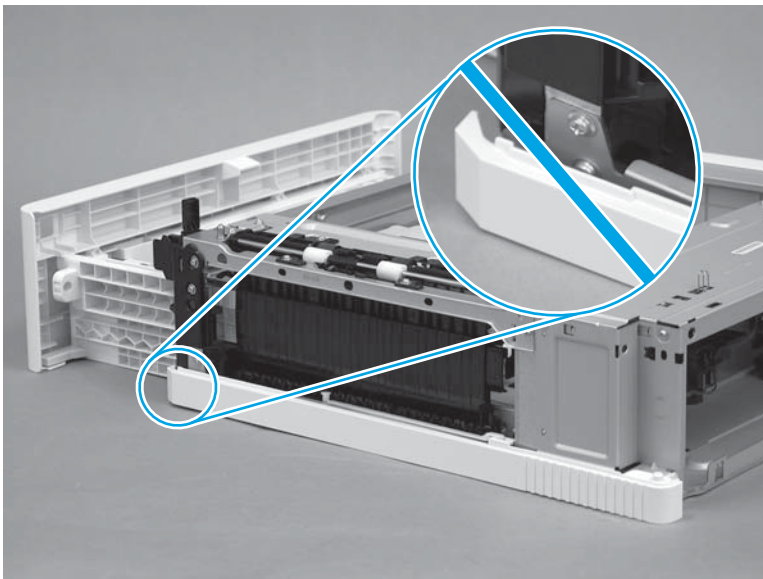

Step 13: Install the right door

1. Install the door link in the slot in the door to attach the door.

Figure 1-5326 Install the door link

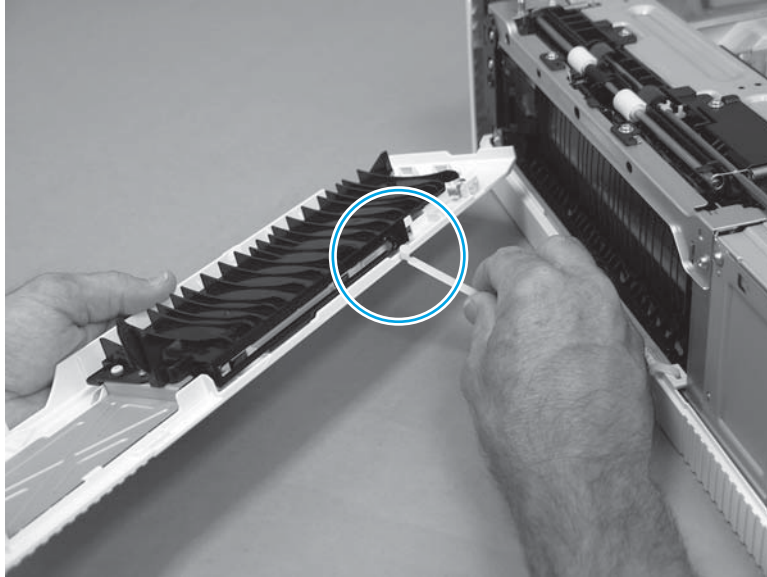

2. Position the lower hinge hole on the door (callout 2) on the lower hinge pin (callout 2) on the right-lower cover.

Figure 1-5327 Position the door on the lower hinge

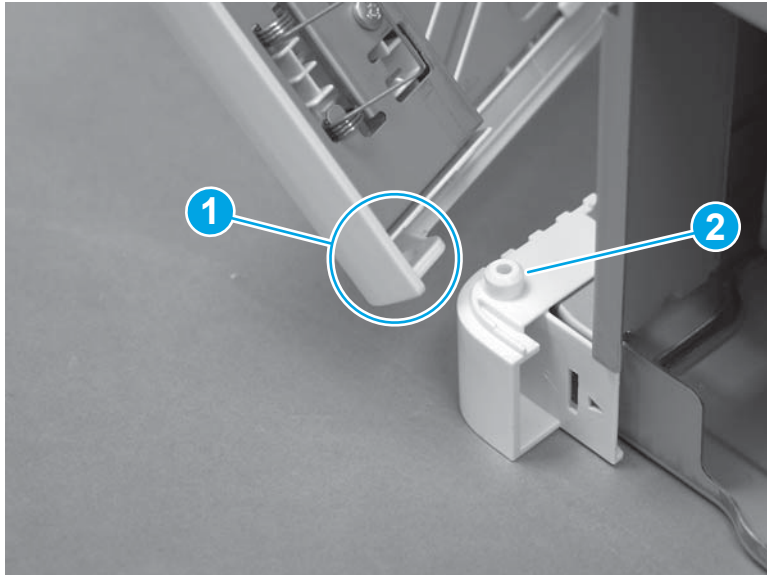

3. Align the pin of the door-hinge bracket (callout 1) with the hole in the chassis, and then align the mounting tabs (callout 2 and callout 3) with the slots in the chassis.

Figure 1-5328 Engage the hinge bracket

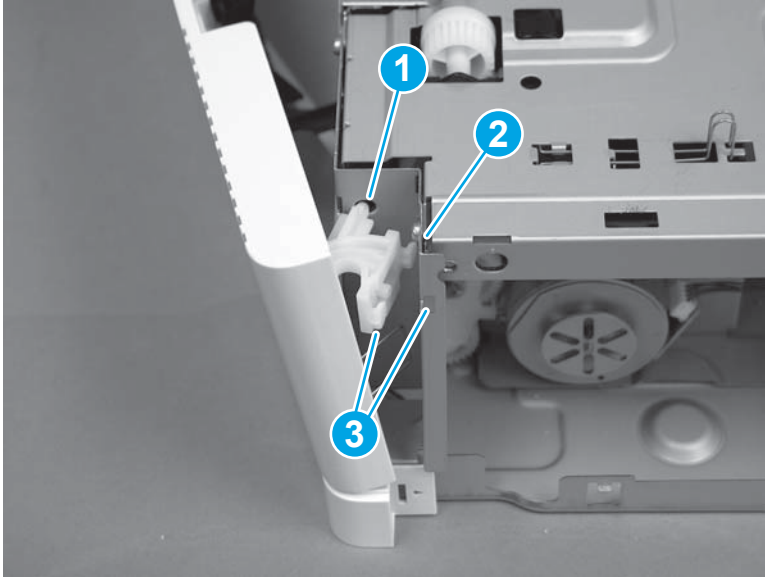

4. Push in on the door-hinge bracket (callout 1), and then slide it toward the chassis (callout 2) to install it.

Figure 1-5329 Install the hinge bracket

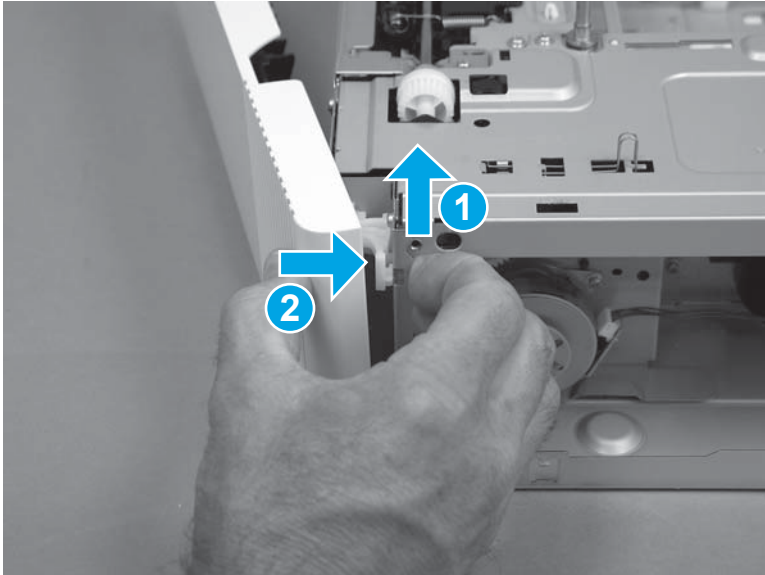

5. Close the door.

Figure 1-5330 Close the door

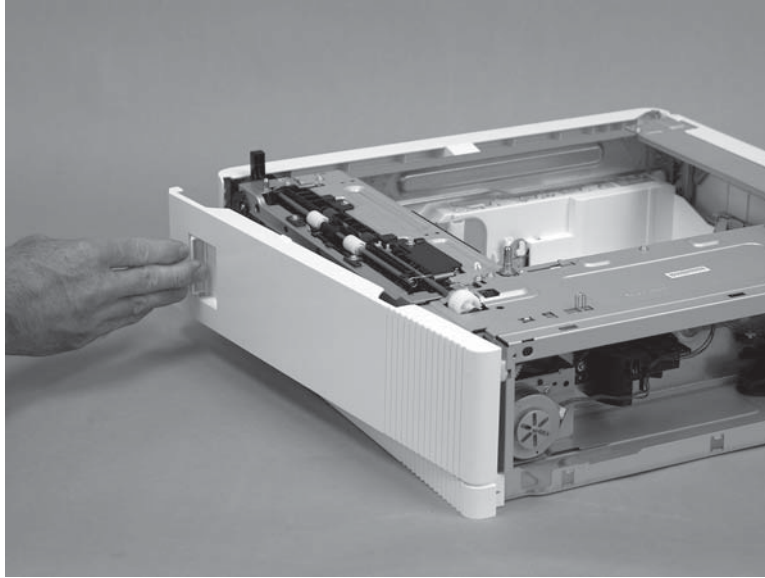

Step 14: Install the rear cover

1. Align the three mounting tabs (callout 1) on the cover with the slots in the chassis.

Figure 1-5331 Position the cover on the chassis

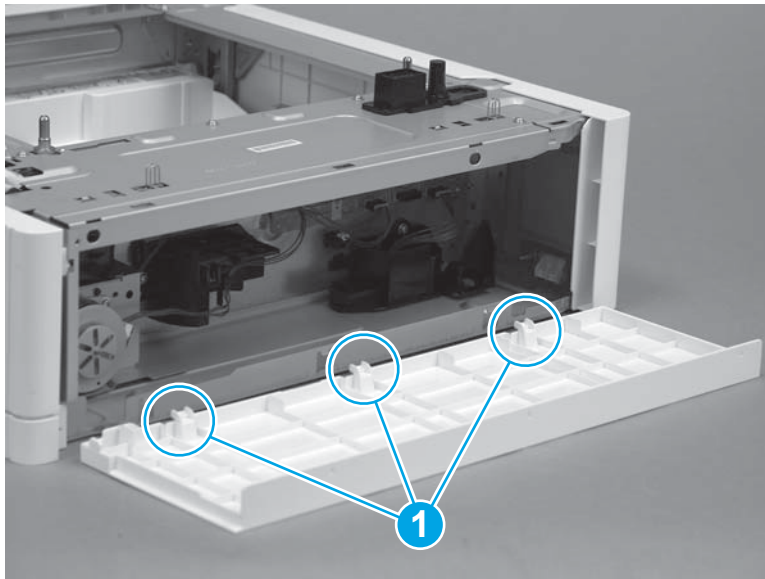

2. Position the cover on the accessory (callout 1), and then rotate the top of the cover up and onto the chassis (callout 2) to install it.

Figure 1-5332 Install the cover

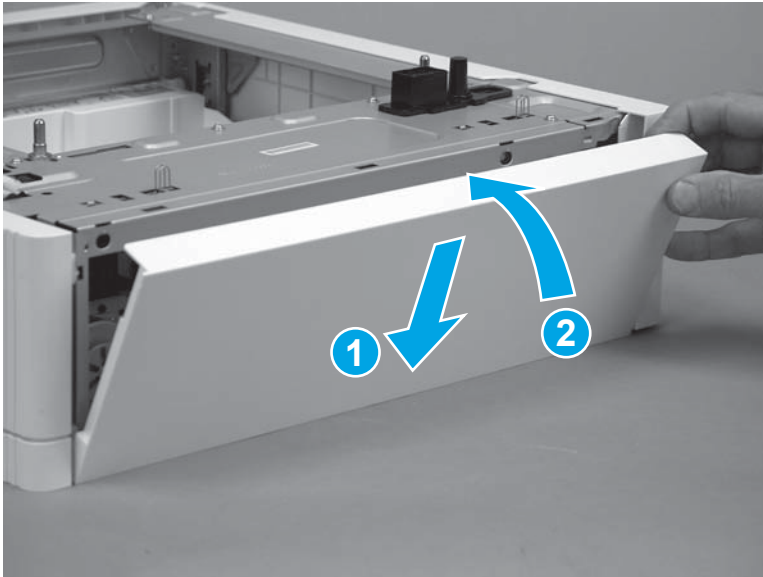

3. Make sure that the three tabs (callout 1) snap into place.

Figure 1-5333 Check the three tabs

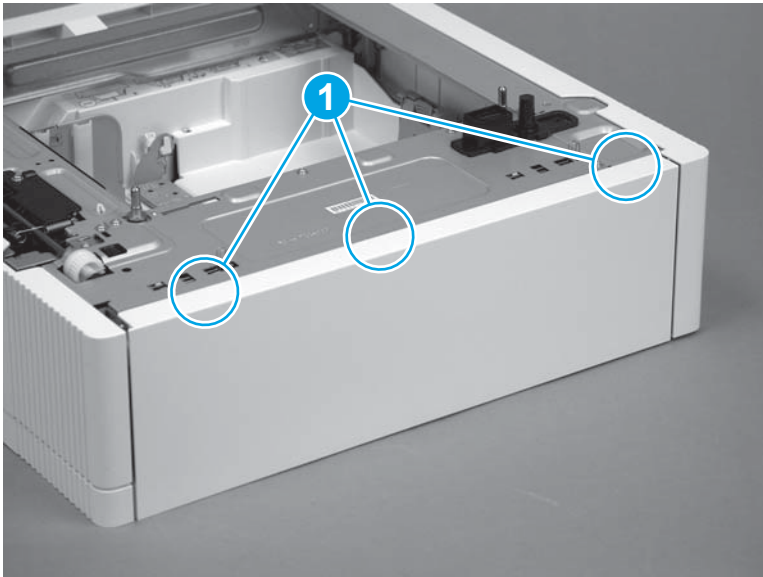

Step 15: Install the tray

1. With the front of the tray slightly lifted, align the sides of the tray with the rails in the printer, and then carefully slide the tray into the printer.

 **TIP:** As the tray slides into the accessory, lower the front of it.

Figure 1-5334 Install the tray



2. Close the tray.

Figure 1-5335 Close the tray

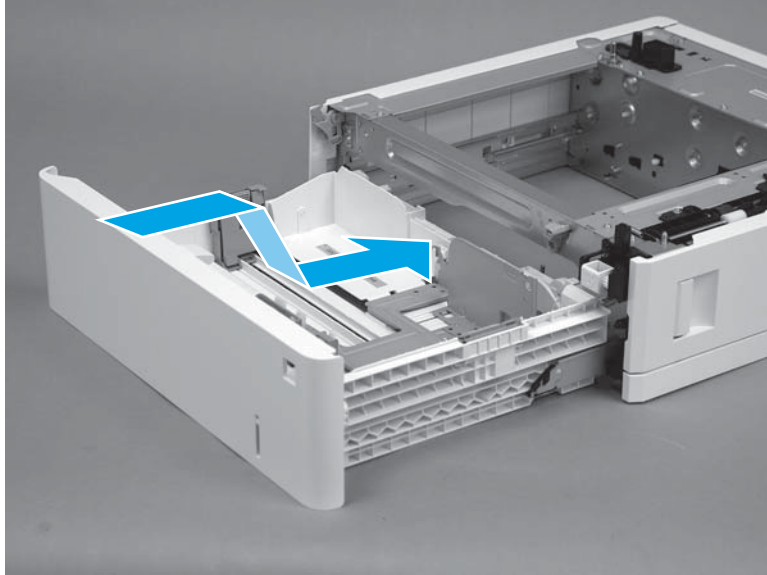
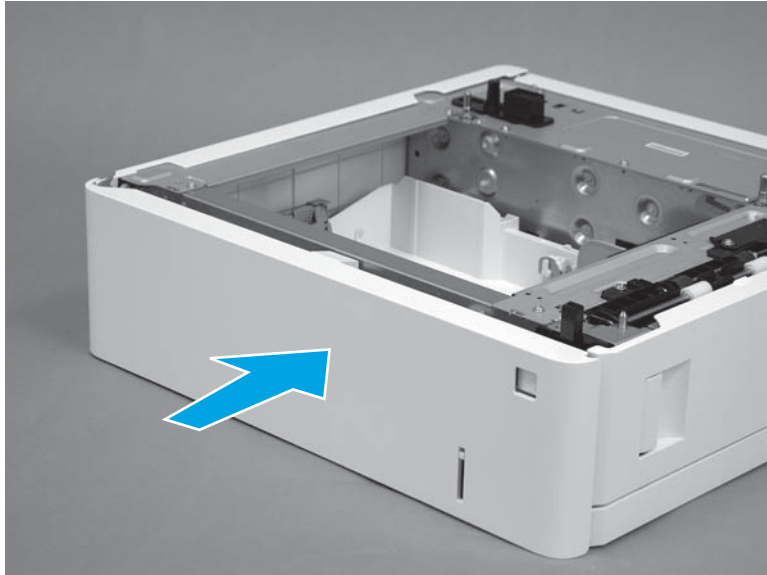

Removal and replacement: Trusted platform module (M552 and M553)

- [Introduction](#)
- [Step 1: Remove the formatter cover](#)
- [Step 2: Remove the hard-disk drive \(HDD\)](#)
- [Step 3: Remove the trusted platform module \(TPM\)](#)
- [Step 4: Unpack the replacement assembly](#)
- [Step 5: Install the TPM](#)
- [Step 6: Install the hard-disk drive \(HDD\)](#)
- [Step 7: Install the formatter cover](#)

Introduction



This document provides the procedures to remove and replace the trusted platform module (TPM).

Before performing service

Turn the printer power off

- Disconnect the power cable.

 **WARNING!** To avoid damage to the printer, turn the printer off, wait 30 seconds, and then remove the power cord before attempting to service the printer.

 **CAUTION:**  This part contains components that are electrostatic discharge (ESD) sensitive. To reduce the possibility of ESD damage, always touch the sheet-metal chassis to ground yourself before touching an ESD sensitive part.

Use the table below to identify the correct part number for your printer, and then go to <http://h20141.www2.hp.com/hpparts> to order the part.

TPM kit number

F5562-61001

Trusted platform module (TPM) with instruction guide
--

Required tools

- No special tools are required to install this kit.

After performing service

Make sure that the formatter cover is fully seated, and that the thumbscrews are finger tight after replacing it.

Turn the printer power on

- Connect the power cable.
- Use the power switch to turn the power on.

Post service test

Print a configuration page to make sure that the printer is functioning correctly.

Step 1: Remove the formatter cover

1. Locate the formatter cover.

Figure 1-5336 Locate the formatter cover

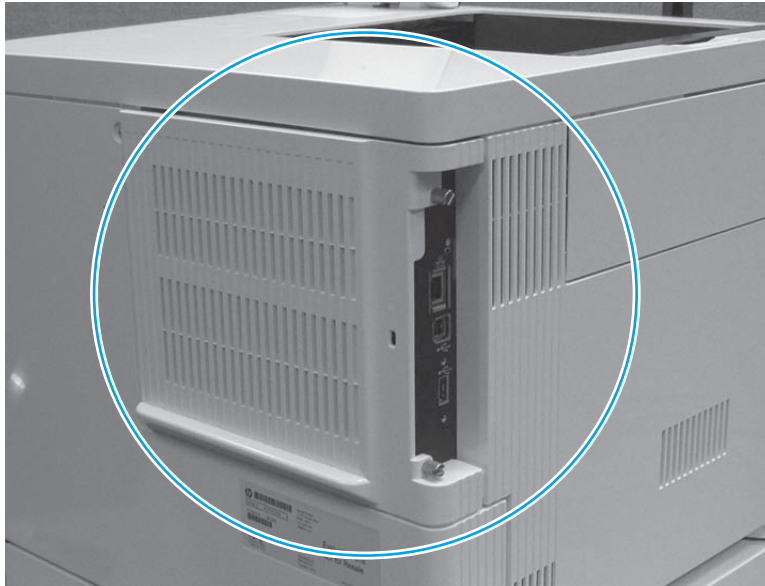

2. Loosen the two thumbscrews (callout 1). Grasp the two thumbscrews, and then slide the cover away from the printer (callout 2) to remove it.



 **TIP:** If needed, use the edge of a coin to turn the thumbscrews.

Figure 1-5337 Loosen the thumbscrews

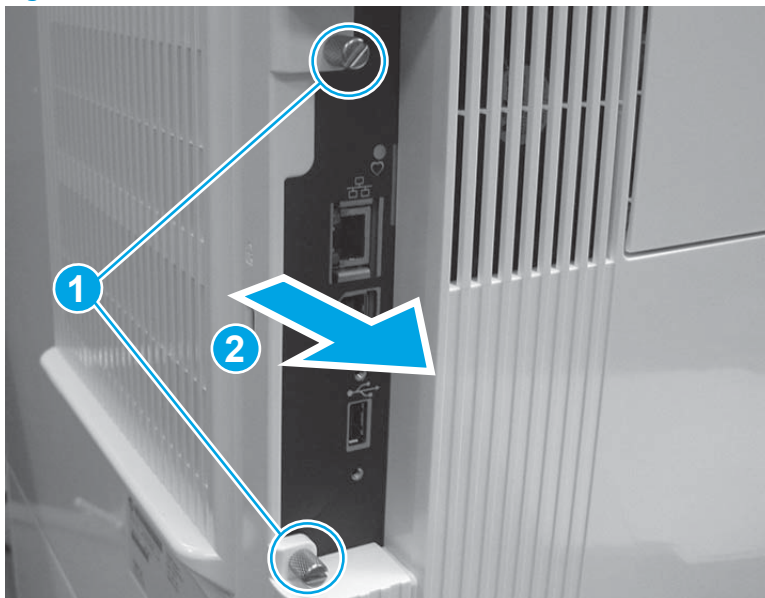

Step 2: Remove the hard-disk drive (HDD)

 **NOTE:** If the optional HDD is not installed, do one of the following:

- If this is a first-time installation of the optional TPM, skip this step and go to [Step 4: Unpack the replacement assembly on page 2960](#).
- If this is a replacement TPM installation, skip this step and go to [Step 3: Remove the trusted platform module \(TPM\) on page 2959](#).

 **CAUTION:**  ESD-sensitive part.

1. Release one tab (callout 1), grasp the HDD mounting bracket, and then rotate the connector end of the bracket up (callout 2) and away from the formatter to release it.

Figure 1-5338 Release the HDD

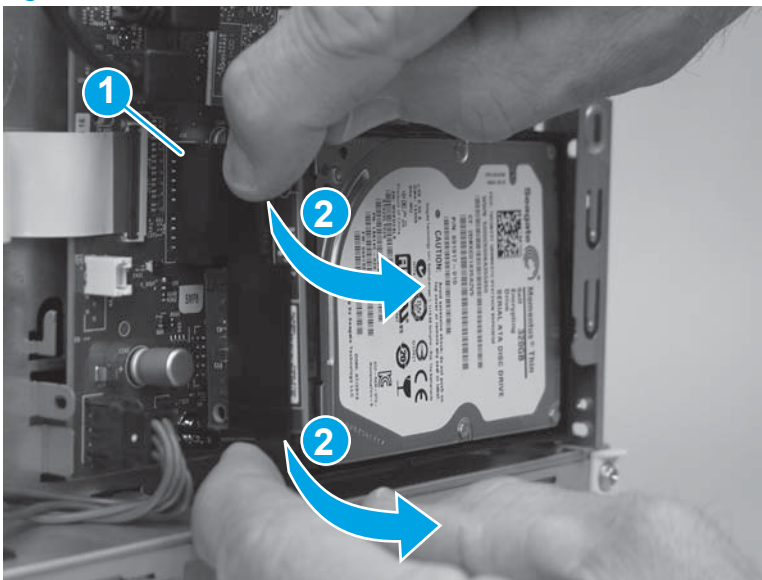

2. Slide the HDD away from the printer to remove it.

Figure 1-5339 Remove the HDD

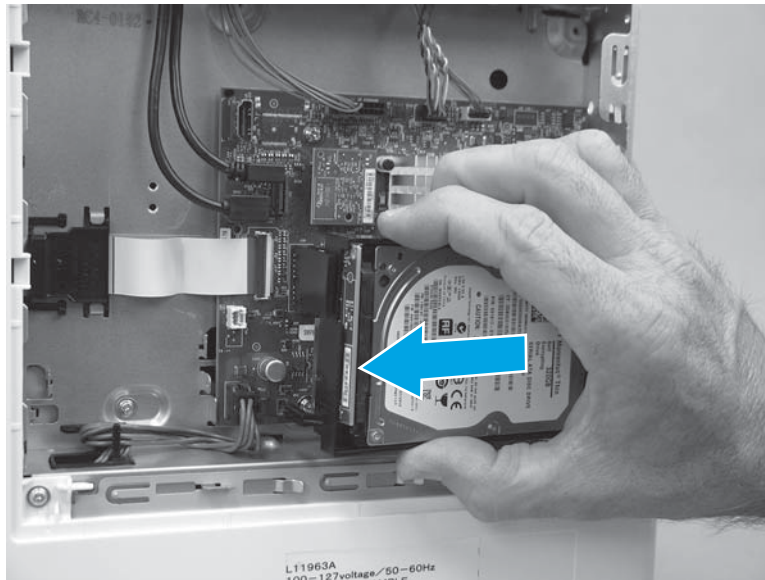

Step 3: Remove the trusted platform module (TPM)

 **NOTE:** If this is a first-time installation of the optional TPM, skip this step and go to [Step 4: Unpack the replacement assembly on page 2960](#).

 **CAUTION:**  ESD-sensitive part.

1. Locate the TPM component on the formatter.

Figure 1-5340 Locate the TPM

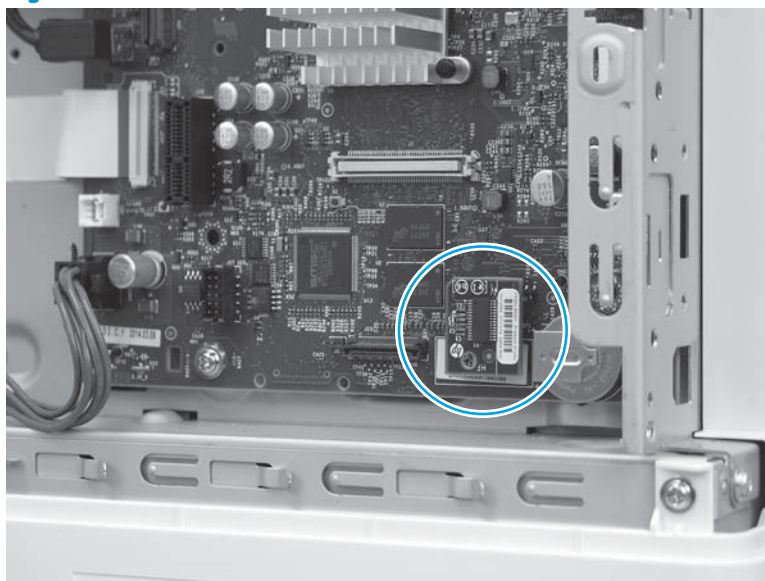

2. Pull the TPM straight off of the formatter to remove it.

Figure 1-5341 Remove the TPM

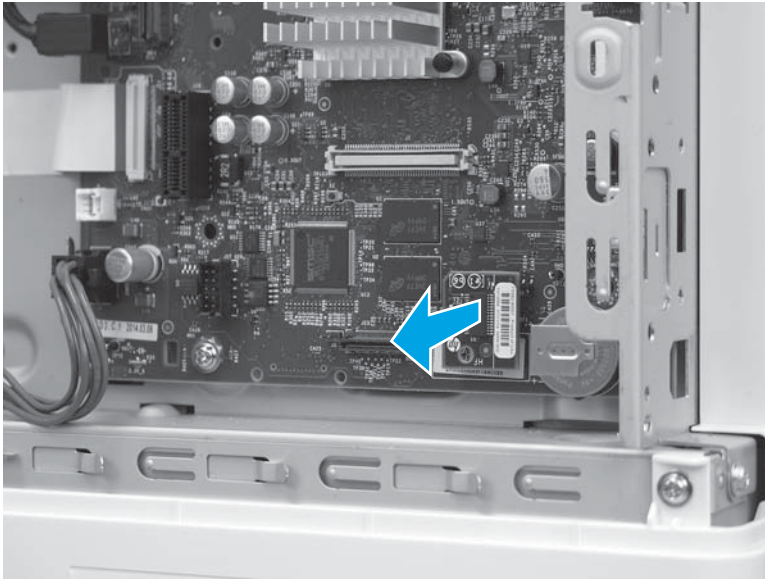

Step 4: Unpack the replacement assembly

Unpack the replacement assembly from the packaging.

CAUTION:  ESD-sensitive part.

For complete information on HP's recycling programs, go to [Product return and recycling](#).

NOTE: HP recommends responsible disposal of the defective assembly.

Figure 1-5342 Recycle and unpack

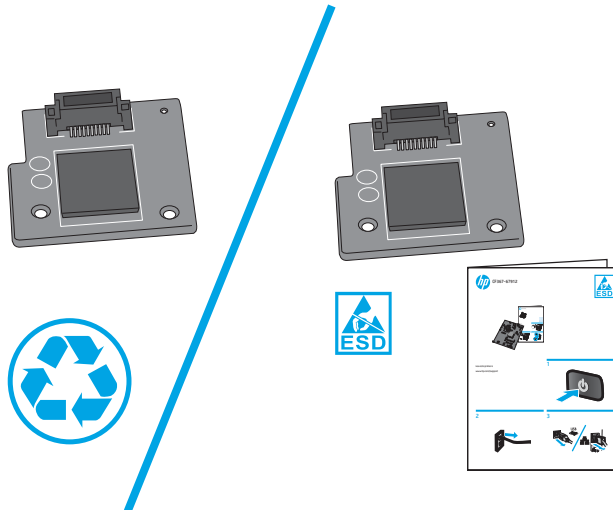

Step 5: Install the TPM

 **CAUTION:**  ESD-sensitive part.

1. Align the connector on the TPM (callout 1) with the connector on the formatter (callout 2), and then push the TPM onto the formatter to install it.

 **NOTE:** The TPM can only be install in one direction on the formatter.

Figure 1-5343 Install the TPM

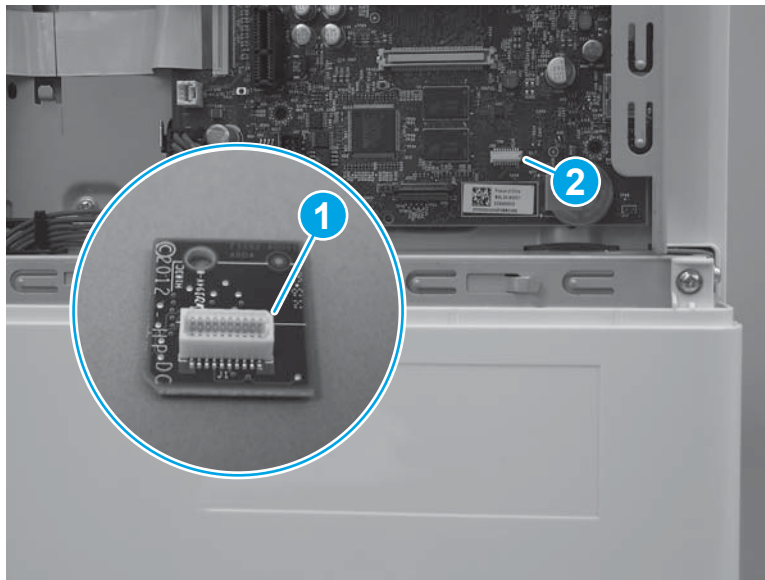

2. Verify that the TPM is fully seated in the connector.

Figure 1-5344 Verify that the TPM is fully seated

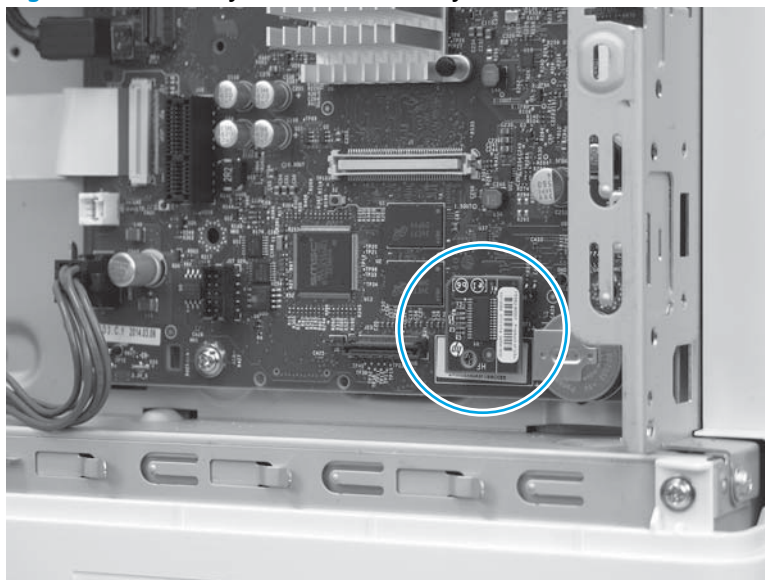

Step 6: Install the hard-disk drive (HDD)

 **NOTE:** If the optional HDD is not installed, skip this step and go to [Step 7: Install the formatter cover](#) on page 2963.

 **CAUTION:**  ESD-sensitive part.

1. Align the end of the holder (callout 1) with the slot in the chassis (callout 2), and then slide the HDD into the printer (callout 3) to engage the holder with the chassis.

Figure 1-5345 Install the holder

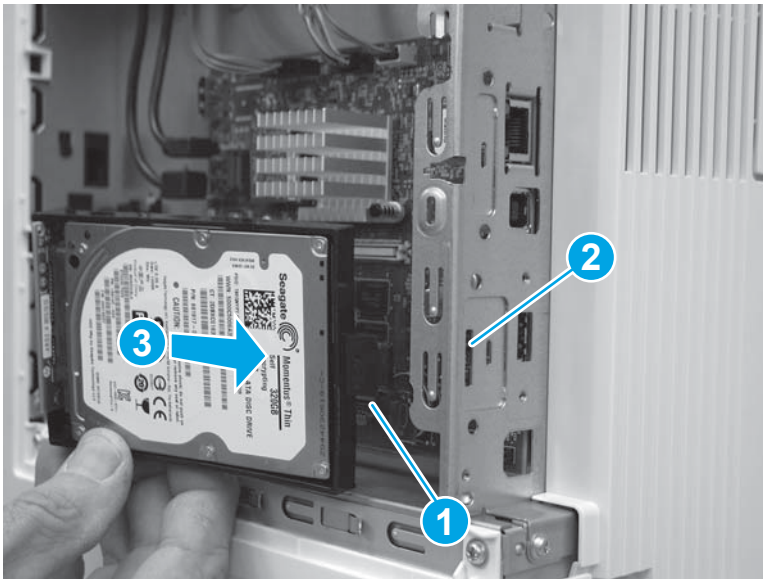

2. Rotate the HDD connector (callout 1) down and into the connector on the formatter to install it.

 **NOTE:** Make sure that the tabs (callout 2) snap into place, and that the HDD is securely installed.

Figure 1-5346 Release the HDD

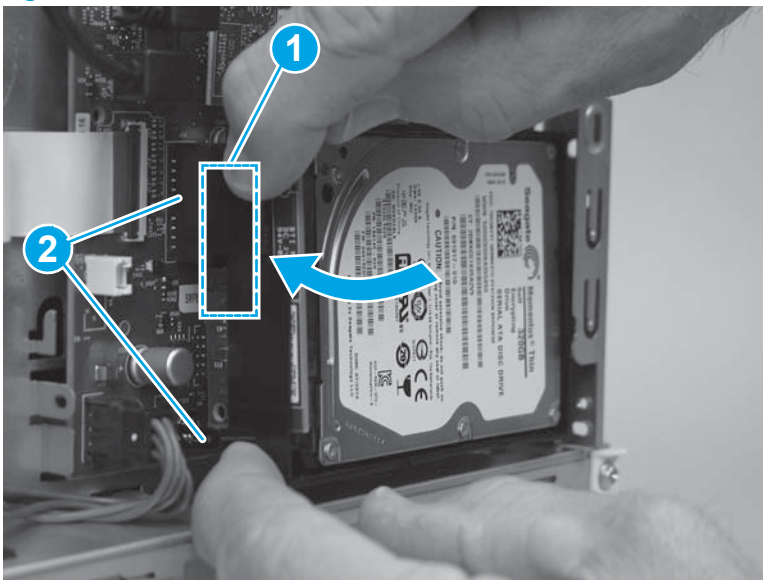

Step 7: Install the formatter cover

- ▲ Slide the cover onto the printer (callout 1) to install it.

 **NOTE:** Make sure that the tabs on the formatter cover align with the slots provided in the printer (callout 2). Tighten the two thumbscrews (callout 3).

 **TIP:** If needed, use the edge of a coin to turn the thumbscrews.

Figure 1-5347 Install the cover



Removal and replacement: Trusted platform module (M577)

- [Introduction](#)
- [Step 1: Remove the formatter cover](#)
- [Step 2: Remove the hard-disk drive \(HDD; M577\)](#)
- [Step 3: Remove the trusted platform module \(TPM\)](#)
- [Step 4: Unpack the replacement assembly](#)
- [Step 5: Install the TPM](#)
- [Step 6: Install the hard-disk drive \(HDD; M577\)](#)
- [Step 7: Install the formatter cover](#)

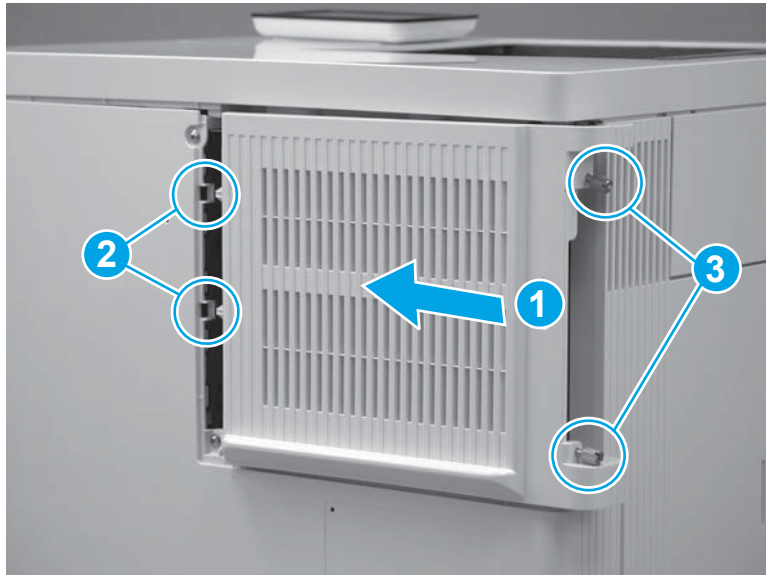
Introduction



This document provides the procedures to remove and replace the trusted platform module (TPM).

Before performing service

Turn the printer power off

- Disconnect the power cable.

 **WARNING!** To avoid damage to the printer, turn the printer off, wait 30 seconds, and then remove the power cord before attempting to service the printer.

 **CAUTION:**  This part contains components that are electrostatic discharge (ESD) sensitive. To reduce the possibility of ESD damage, always touch the sheet-metal chassis to ground yourself before touching an ESD sensitive part.

Use the table below to identify the correct part number for your printer, and then go to <http://h20141.www2.hp.com/hpparts> to order the part.

TPM kit number

F5S62-61001

Trusted platform module (TPM) with instruction guide
--

Required tools

- No special tools are required to install this kit.

After performing service

Make sure that the formatter cover is fully seated, and that the thumbscrews are finger tight after replacing it.

Turn the printer power on

- Connect the power cable.
- Use the power switch to turn the power on.

Post service test

Print a configuration page to make sure that the printer is functioning correctly.

Step 1: Remove the formatter cover

1. Locate the formatter cover.

Figure 1-5348 Locate the formatter cover

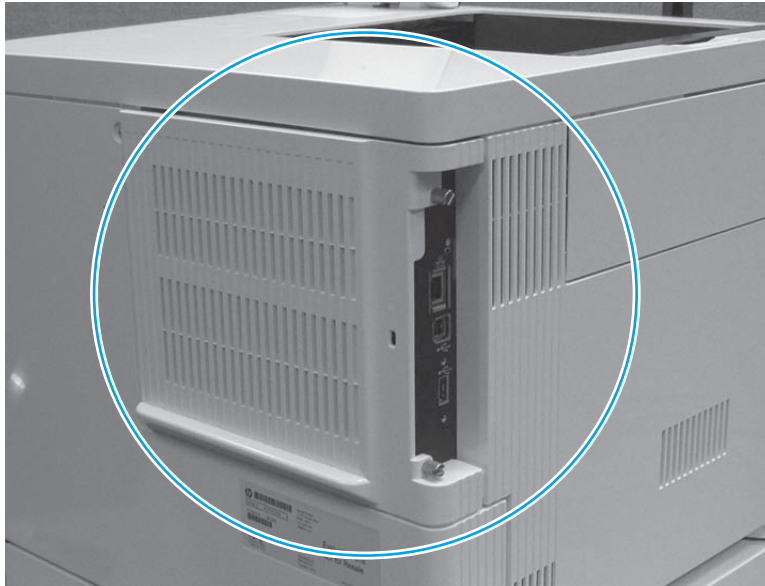

2. Loosen the two thumbscrews (callout 1). Grasp the two thumbscrews, and then slide the cover away from the printer (callout 2) to remove it.

 **TIP:** If needed, use the edge of a coin to turn the thumbscrews.

Figure 1-5349 Loosen the thumbscrews



Step 2: Remove the hard-disk drive (HDD; M577)

 **CAUTION:**  ESD-sensitive part.

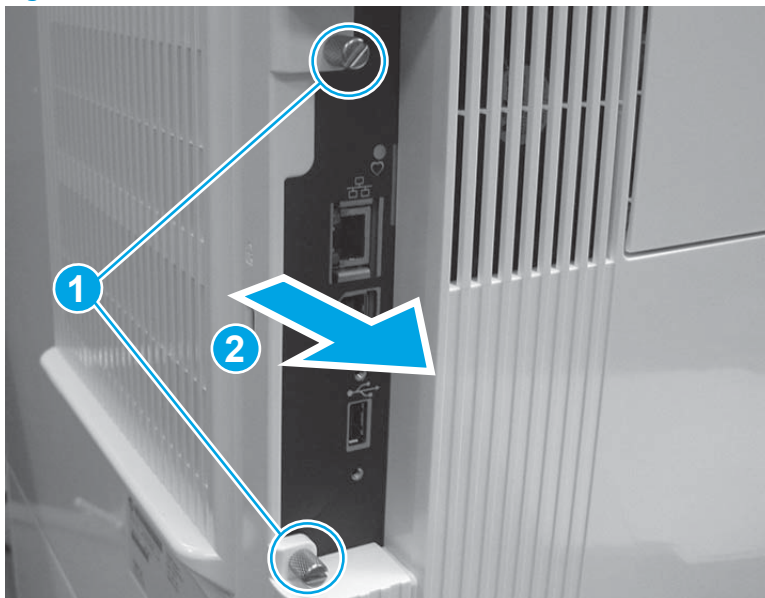
1. Release two tabs (callout 1). Hold the tabs in the released position, and then rotate the hard disk drive (HDD) up (callout 2) to release the connector from the formatter.

Figure 1-5350 Release the HDD

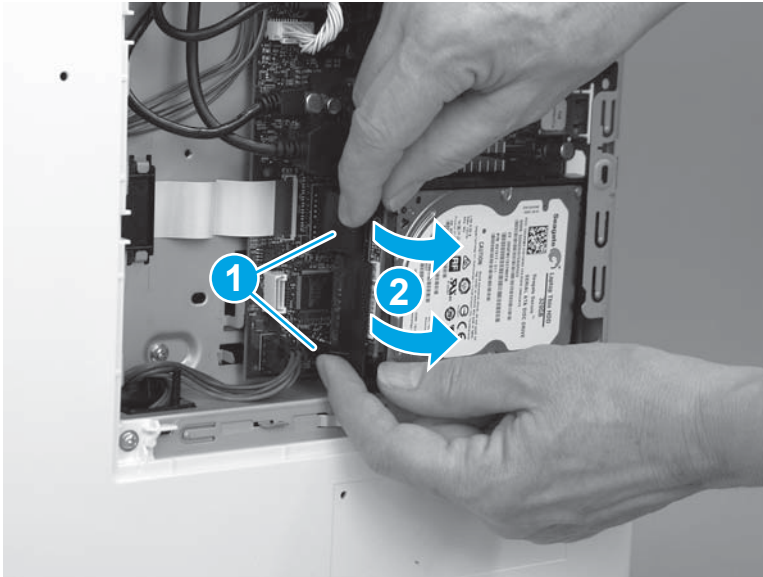

2. Slide the HDD away from the printer to remove it.

Figure 1-5351 Remove the HDD

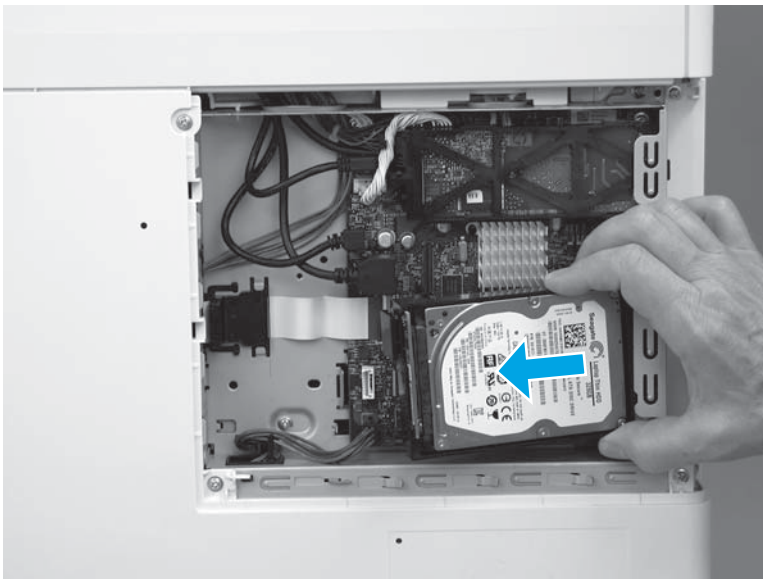

Step 3: Remove the trusted platform module (TPM)

 **NOTE:** If this is a first-time installation of the optional TPM, skip this step and go to [Step 4: Unpack the replacement assembly on page 2967](#).

 **CAUTION:**  ESD-sensitive part.

1. Locate the TPM component on the formatter.

Figure 1-5352 Locate the TPM

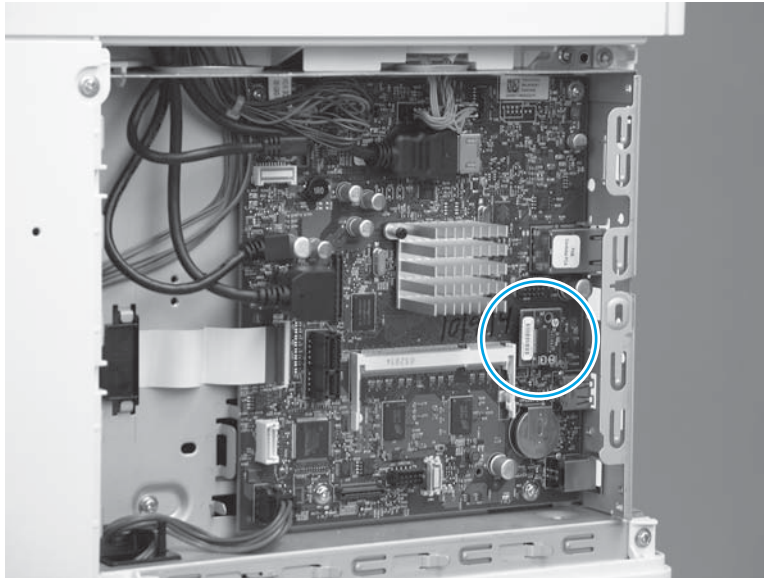

2. Pull the TPM straight off of the formatter to remove it.

Figure 1-5353 Remove the TPM

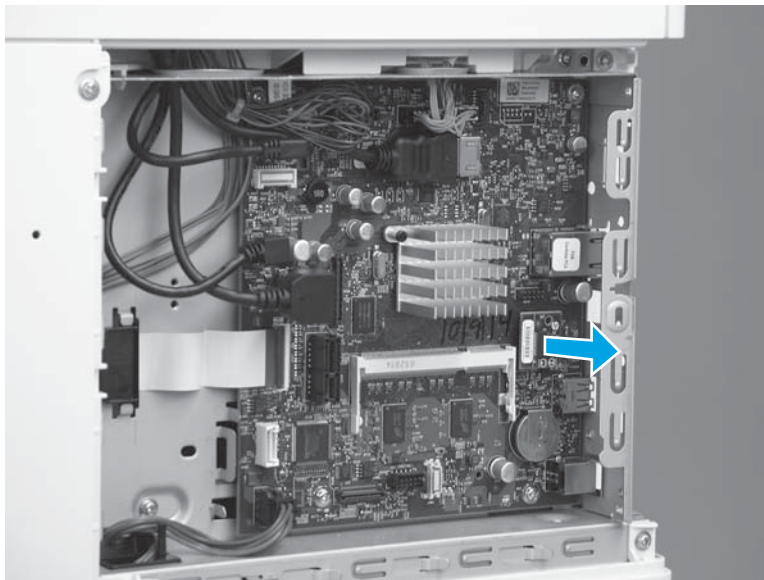

Step 4: Unpack the replacement assembly

Unpack the replacement assembly from the packaging.

 **CAUTION:**  ESD-sensitive part.

For complete information on HP's recycling programs, go to [Product return and recycling](#).

 **NOTE:** HP recommends responsible disposal of the defective assembly.

Figure 1-5354 Recycle and unpack

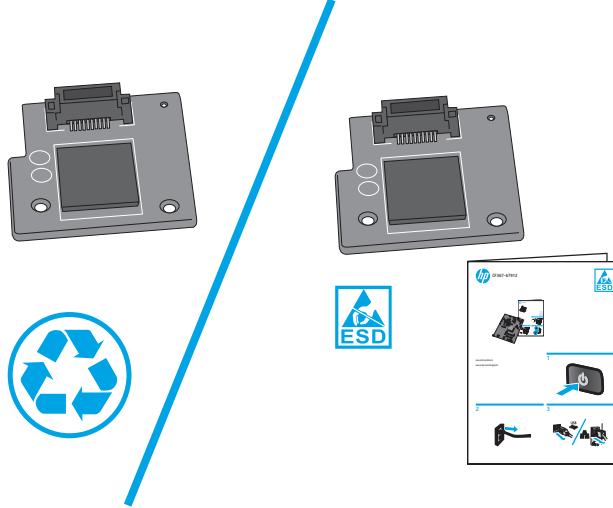

Step 5: Install the TPM

 **CAUTION:**  ESD-sensitive part.

1. Align the connector on the TPM (callout 1) with the connector on the formatter (callout 2), and then push the TPM onto the formatter to install it.

 **NOTE:** The TPM can only be install in one direction on the formatter.

Figure 1-5355 Install the TPM

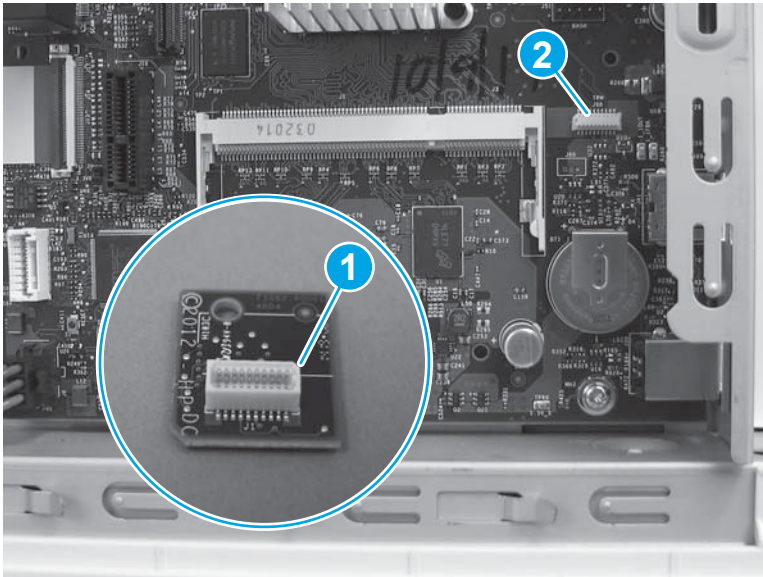

2. Verify that the TPM is fully seated in the connector.

Figure 1-5356 Verify that the TPM is fully seated

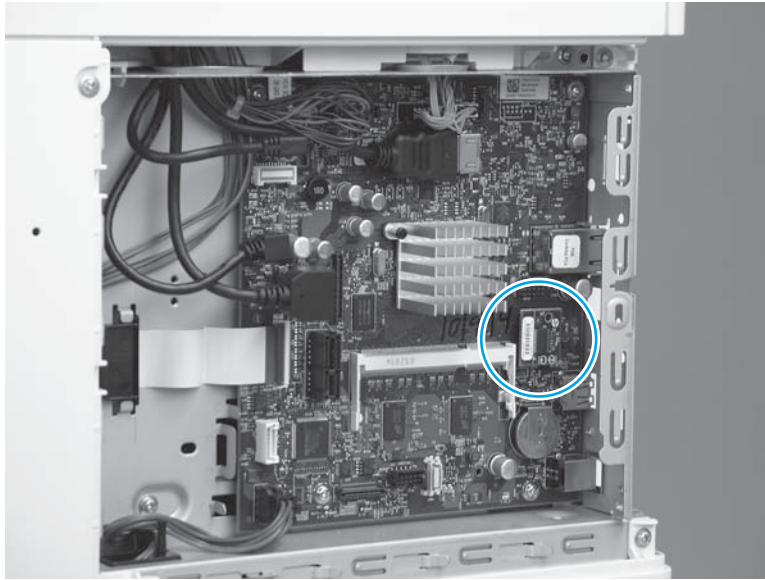

Step 6: Install the hard-disk drive (HDD; M577)

 **NOTE:** If the optional HDD is not installed, skip this step and go to [Step 7: Install the formatter cover on page 2963](#).

 **CAUTION:**  ESD-sensitive part.

1. Align the end of the bracket (callout 1) with the slot in the chassis (callout 2), and then slide the HDD into the printer (callout 3) to engage the bracket with the chassis.

Figure 1-5357 Install the holder

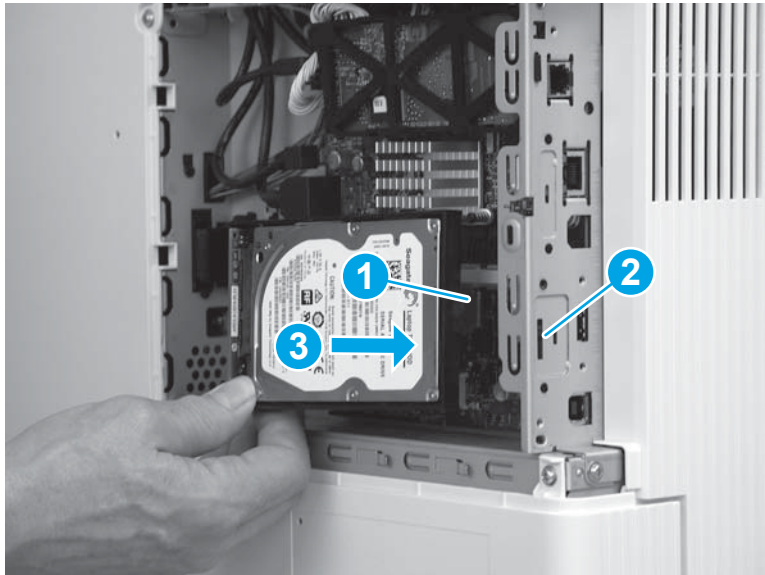

2. Hold the HDD connector latch (callout 1) in the released position, and then rotate the HDD down and into the connector on the formatter to install it.



 **NOTE:** Make sure that the tab (callout 2) snaps into place, and that the HDD is securely installed.

Figure 1-5358 Release the HDD

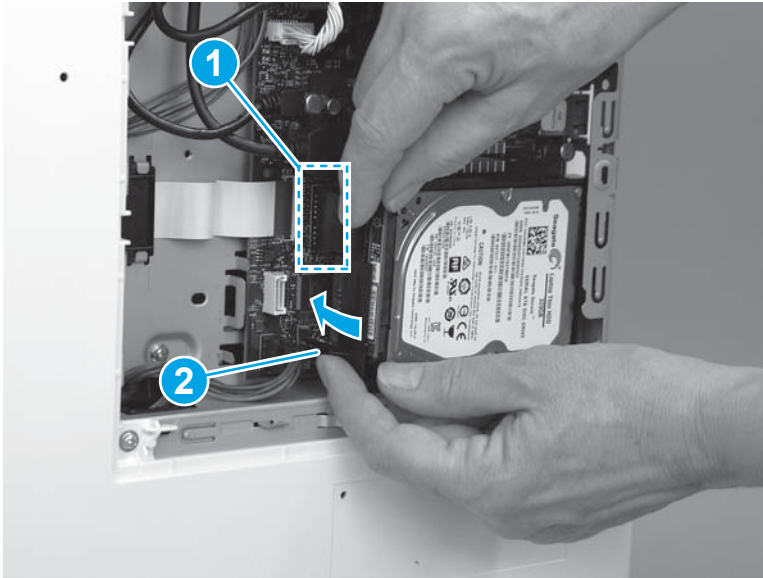

Step 7: Install the formatter cover

- ▲ Slide the cover onto the printer (callout 1) to install it.

 **NOTE:** Make sure that the tabs on the formatter cover align with the slots provided in the printer (callout 2). Tighten the two thumbscrews (callout 3).

 **TIP:** If needed, use the edge of a coin to turn the thumbscrews.

Figure 1-5359 Install the cover



Removal and replacement: Internal USB ports (M552 and M553)

- [Introduction](#)
- [Step 1: Remove the formatter cover](#)
- [Step 2: Remove the internal USB ports module \(M552 and M553\)](#)
- [Step 3: Unpack the replacement assembly](#)
- [Step 4: Install the internal USB ports module \(M552 and M553\)](#)
- [Step 5: Install the formatter cover](#)

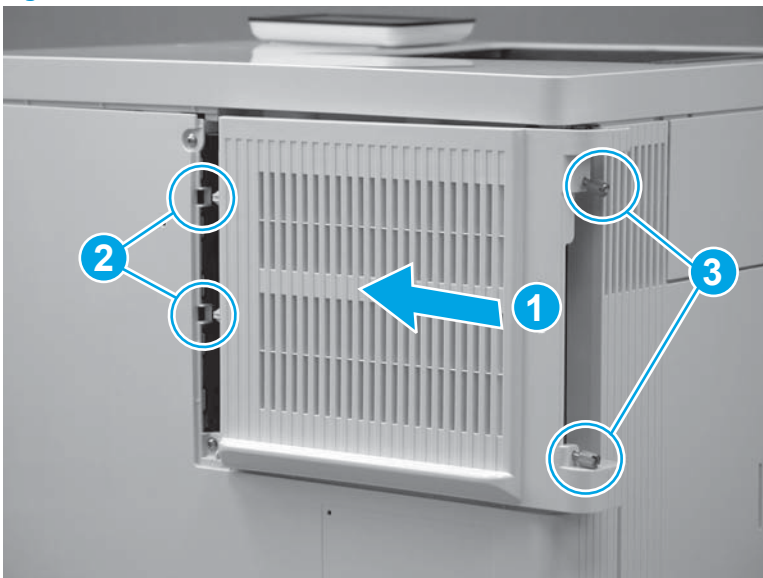
Introduction



This document provides the procedures to remove and replace the internal USB ports.

Before performing service

Turn the printer power off

- Disconnect the power cable.

 **WARNING!** To avoid damage to the printer, turn the printer off, wait 30 seconds, and then remove the power cord before attempting to service the printer.

 **CAUTION:**  This part contains components that are electrostatic discharge (ESD) sensitive. To reduce the possibility of ESD damage, always touch the sheet-metal chassis to ground yourself before touching an ESD sensitive part.

Use the table below to identify the correct part number for your printer. To order the part, go to www.hp.com/buy/parts.

Internal USB ports part number	
B5L28-67902	Internal USB ports

Required tools

No special tools are required to install this part.

After performing service

Turn the printer power on

- Connect the power cable.
- Use the power switch to turn the power on.

Post service test

Print a configuration page to make sure that the printer is functioning correctly.

Step 1: Remove the formatter cover

1. Locate the formatter cover.

Figure 1-5360 Locate the formatter cover

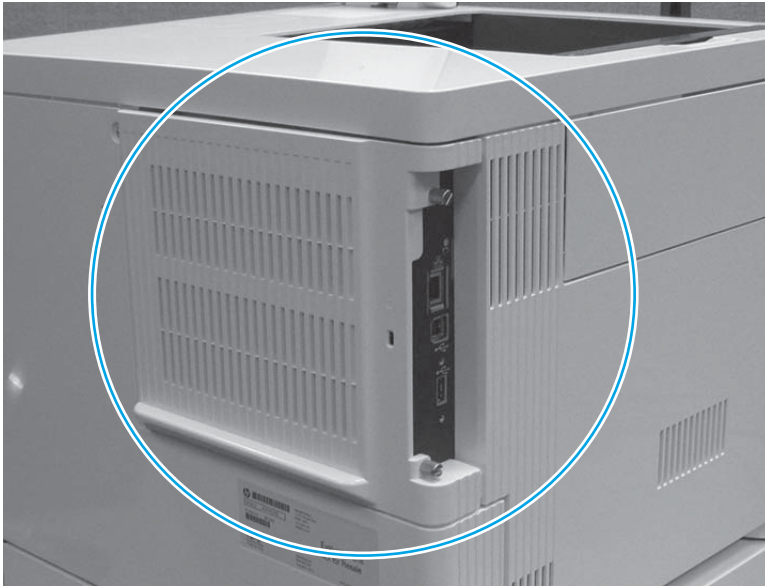

2. Loosen the two thumbscrews (callout 1). Grasp the two thumbscrews, and then slide the cover away from the printer (callout 2) to remove it.

 **TIP:** If needed, use the edge of a coin to turn the thumbscrews.

Figure 1-5361 Loosen the thumbscrews



Step 2: Remove the internal USB ports module (M552 and M553)

 **CAUTION:**  ESD-sensitive part.

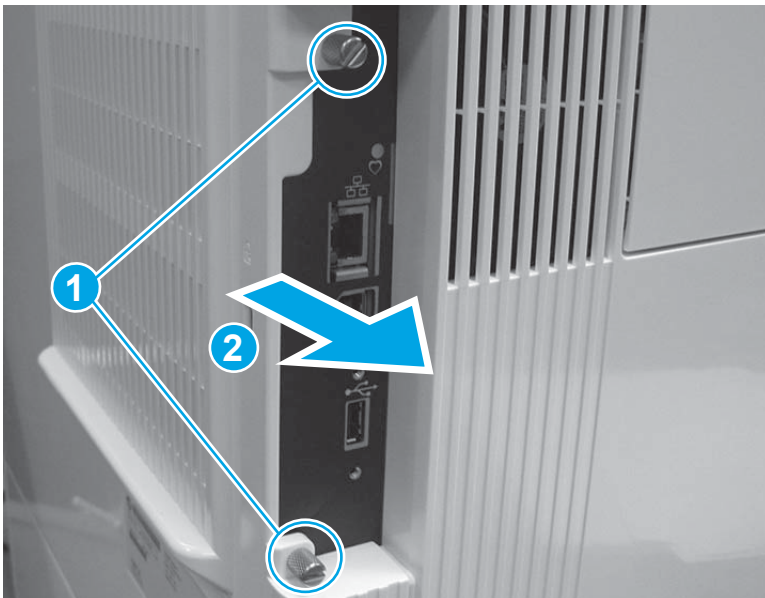
1. Locate the internal USB ports module on the formatter.

Figure 1-5362 Locate the USB ports module

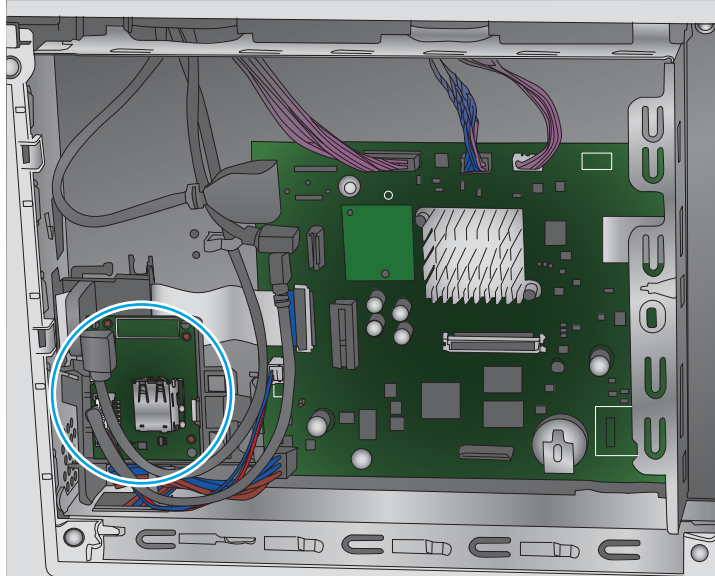

2. Disconnect one connector (callout 1).

Figure 1-5363 Disconnect one connector

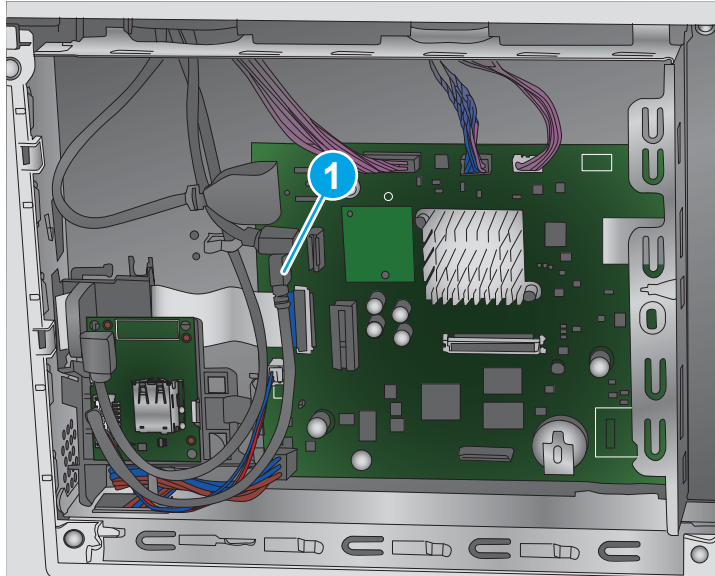

3. Disconnect one connector (callout 1).

Figure 1-5364 Disconnect one connector

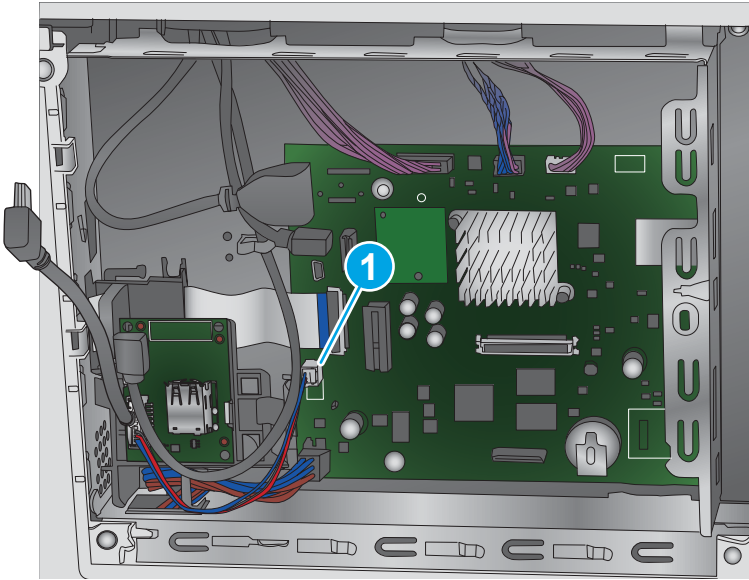

4. Disconnect one connector (callout 1).

Figure 1-5365 Disconnect one connector

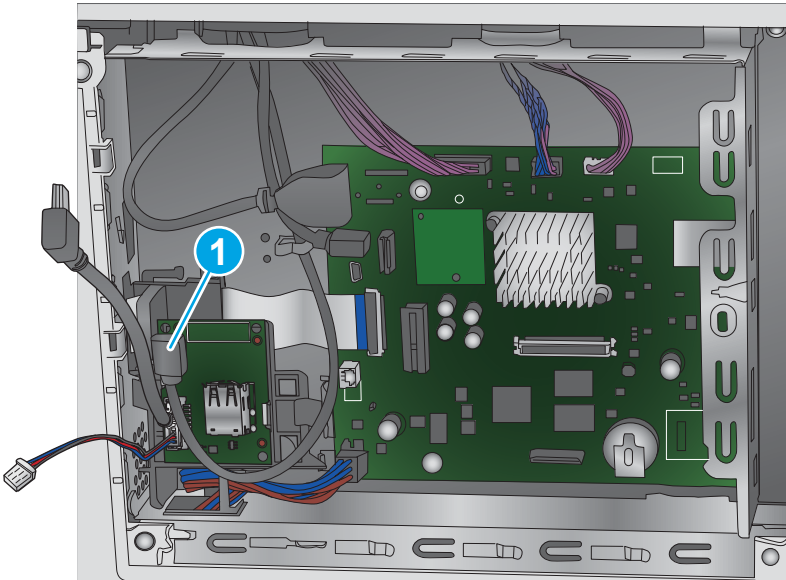

5. Release two tabs (callout 1), and then remove the internal USB ports module (callout 2).

Figure 1-5366 Remove the module

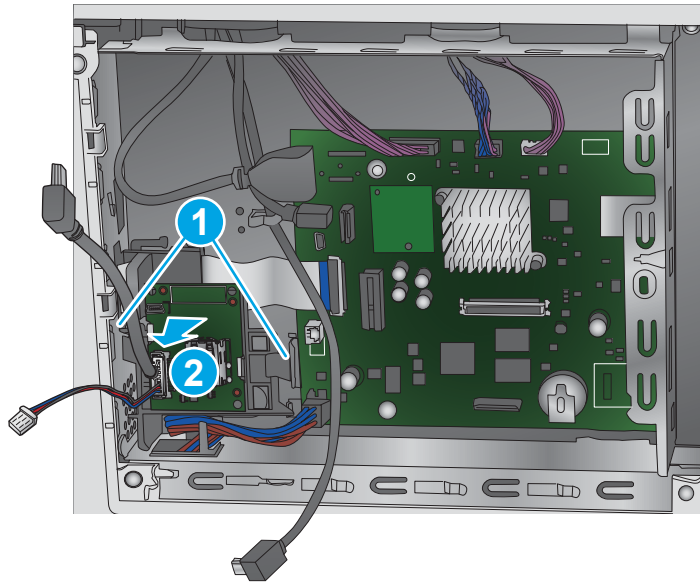

Step 3: Unpack the replacement assembly

Unpack the replacement assembly from the packaging.

CAUTION:  ESD-sensitive part.

For complete information on HP's recycling programs, go to [Product return and recycling](#).

NOTE:  HP recommends responsible disposal of the defective part.

Figure 1-5367 Recycle and unpack

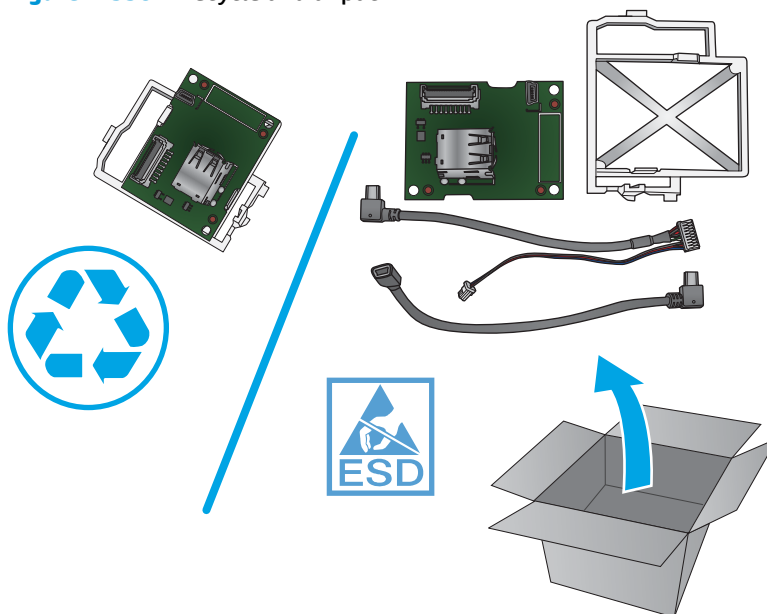

Step 4: Install the internal USB ports module (M552 and M553)

 **CAUTION:**  ESD-sensitive part.

1. Position the notches on the internal USB ports PCA over the clips on the PCA holder and press down to attach the PCA to the holder. Make sure that the clips snap into place.

Figure 1-5368 Install the PCA in the holder

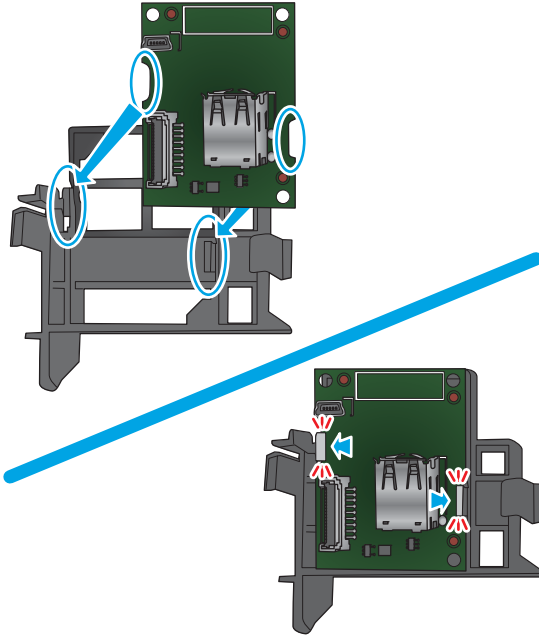

2. Connect the cable harness to the PCA.

Figure 1-5369 Connect the cable harness

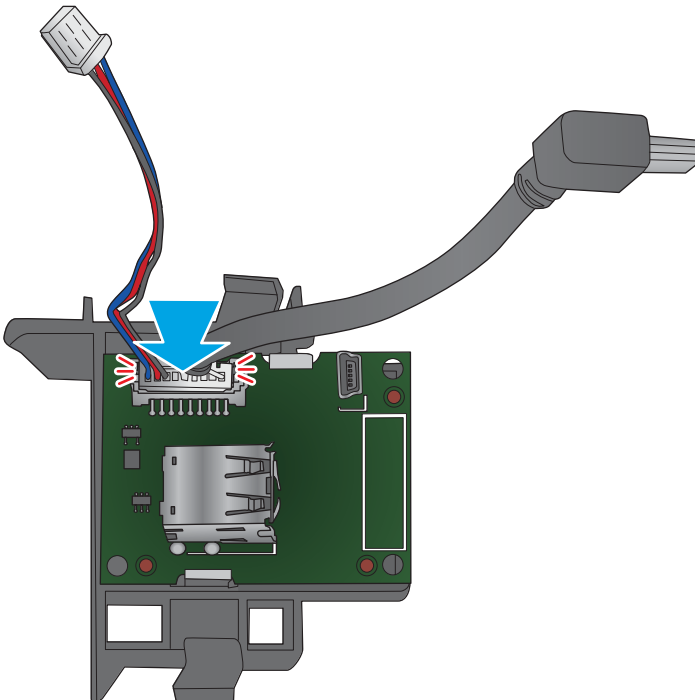

3. Press the internal USB ports module toward the formatter case until the clips snap into place.

Figure 1-5370 Install the internal USB ports module

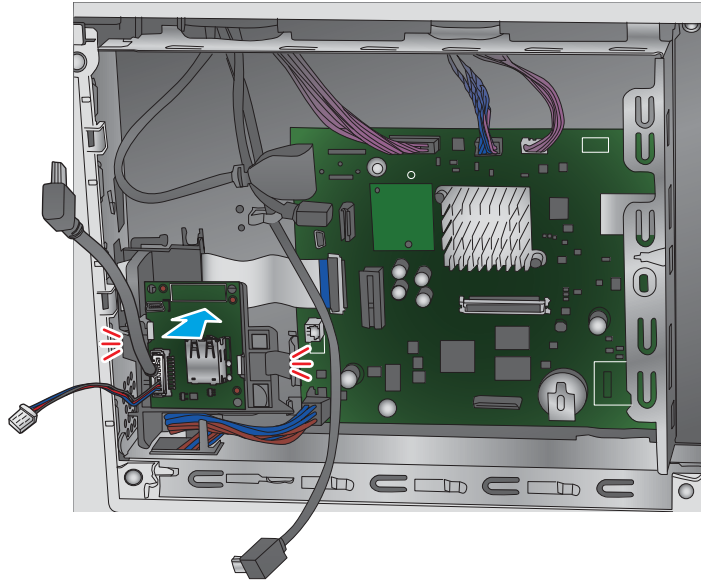

4. Connect one connector (callout 1).

Figure 1-5371 Connect one connector

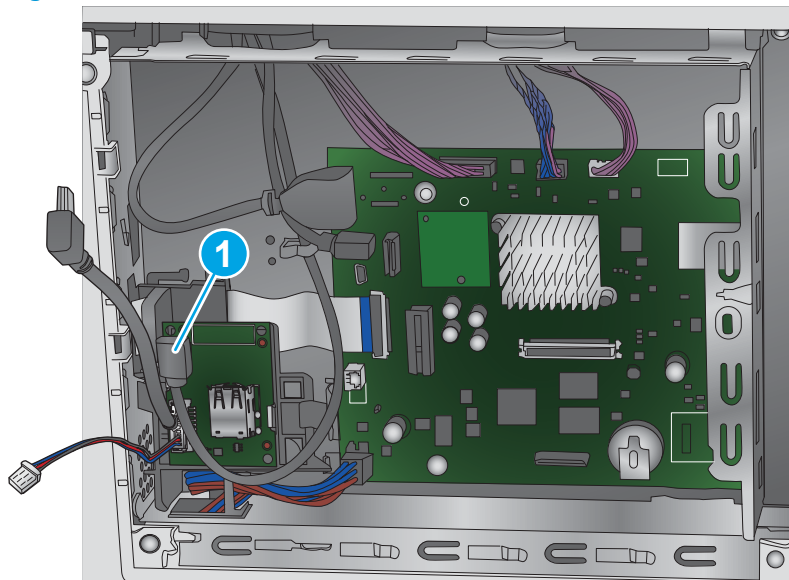

5. Connect one connector (callout 1).

Figure 1-5372 Connect one connector

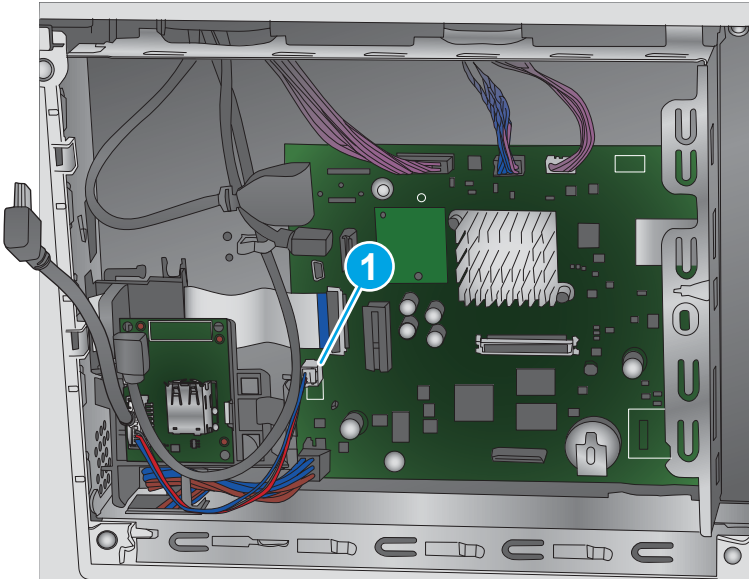

6. Connect one connector (callout 1).

Figure 1-5373 Connect one connector

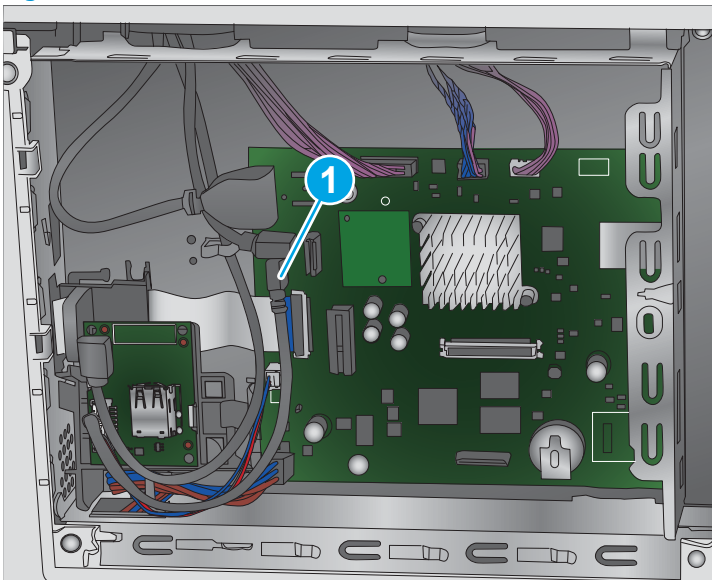

Step 5: Install the formatter cover

- ▲ Slide the cover onto the printer (callout 1) to install it.

 **NOTE:** Make sure that the tabs on the formatter cover align with the slots provided in the printer (callout 2). Tighten the two thumbscrews (callout 3).

 **TIP:** If needed, use the edge of a coin to turn the thumbscrews.

Figure 1-5374 Install the cover



Removal and replacement: Internal USB ports (M577)

- [Introduction](#)
- [Step 1: Remove the formatter cover](#)
- [Step 2: Remove the internal USB ports module \(M577\)](#)
- [Step 3: Unpack the replacement assembly](#)
- [Step 4: Install the internal USB ports module \(M577\)](#)
- [Step 5: Install the formatter cover](#)

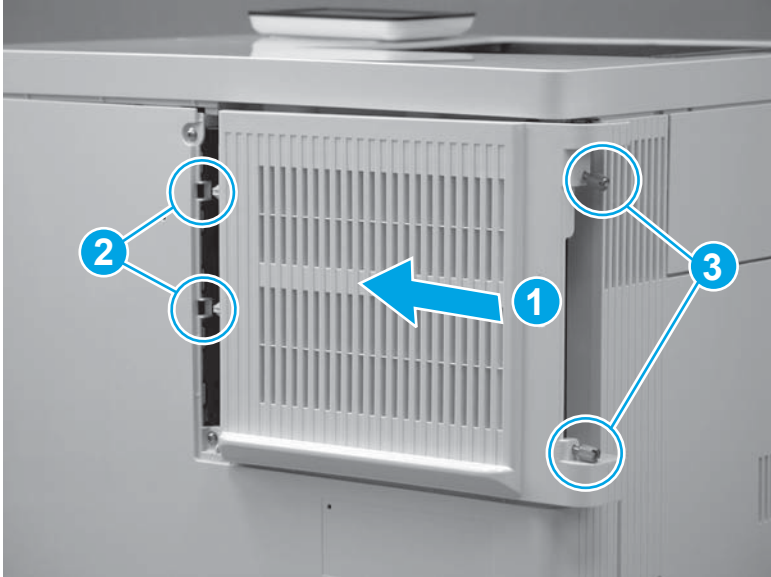
Introduction



This document provides the procedures to remove and replace the internal USB ports.

Before performing service

Turn the printer power off

- Disconnect the power cable.

 **WARNING!** To avoid damage to the printer, turn the printer off, wait 30 seconds, and then remove the power cord before attempting to service the printer.

 **CAUTION:**  This part contains components that are electrostatic discharge (ESD) sensitive. To reduce the possibility of ESD damage, always touch the sheet-metal chassis to ground yourself before touching an ESD sensitive part.

Use the table below to identify the correct part number for your printer. To order the part, go to www.hp.com/buy/parts.

Internal USB ports part number	
--------------------------------	--

B5L28-67902

Internal USB ports

Required tools

No special tools are required to install this part.

After performing service

Turn the printer power on

- Connect the power cable.
- Use the power switch to turn the power on.

Post service test

Print a configuration page to make sure that the printer is functioning correctly.

Step 1: Remove the formatter cover

1. Locate the formatter cover.

Figure 1-5375 Locate the formatter cover

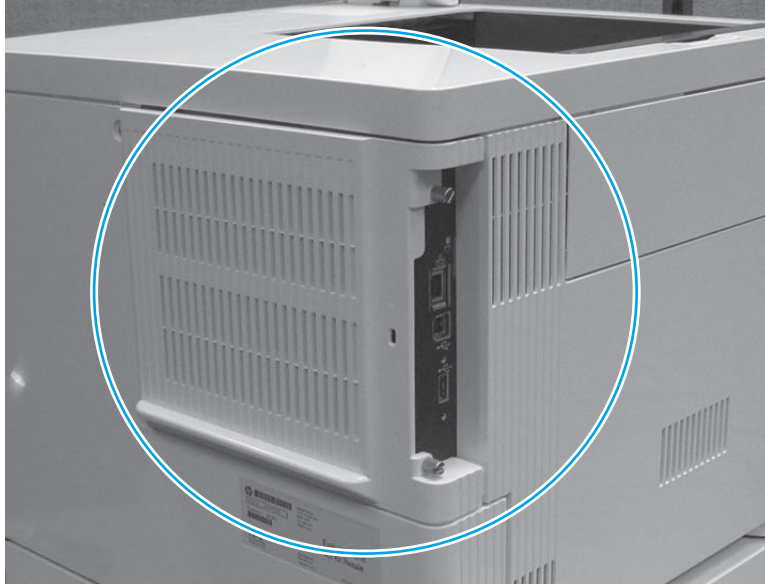

2. Loosen the two thumbscrews (callout 1). Grasp the two thumbscrews, and then slide the cover away from the printer (callout 2) to remove it.

 **TIP:** If needed, use the edge of a coin to turn the thumbscrews.

Figure 1-5376 Loosen the thumbscrews



Step 2: Remove the internal USB ports module (M577)

 **CAUTION:**  ESD-sensitive part.

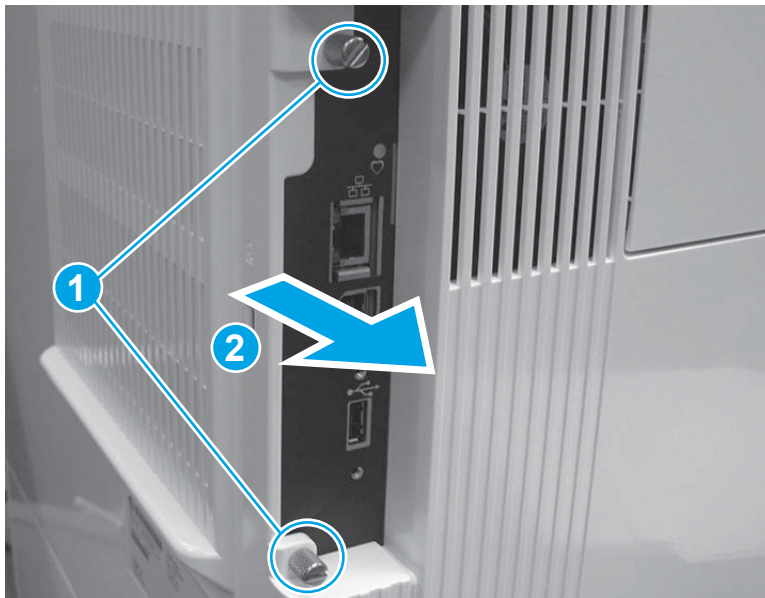
1. Locate the internal USB ports module on the formatter.

Figure 1-5377 Locate the USB ports module

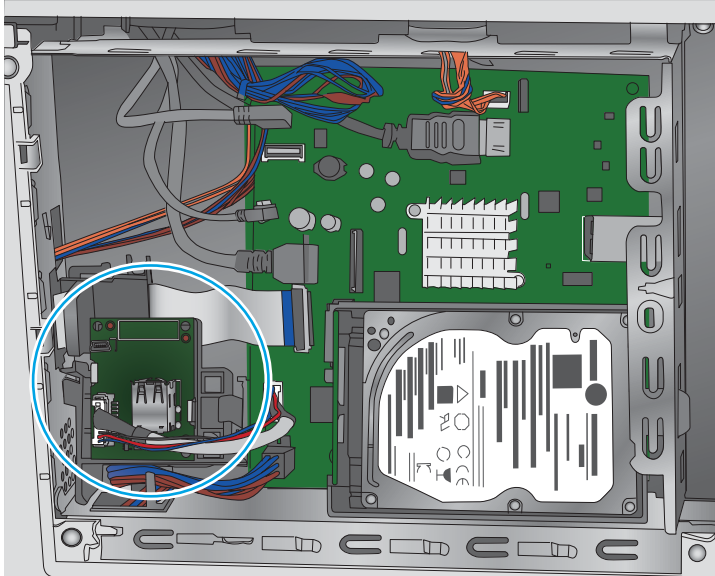

2. Disconnect one connector (callout 1).

Figure 1-5378 Disconnect one connector

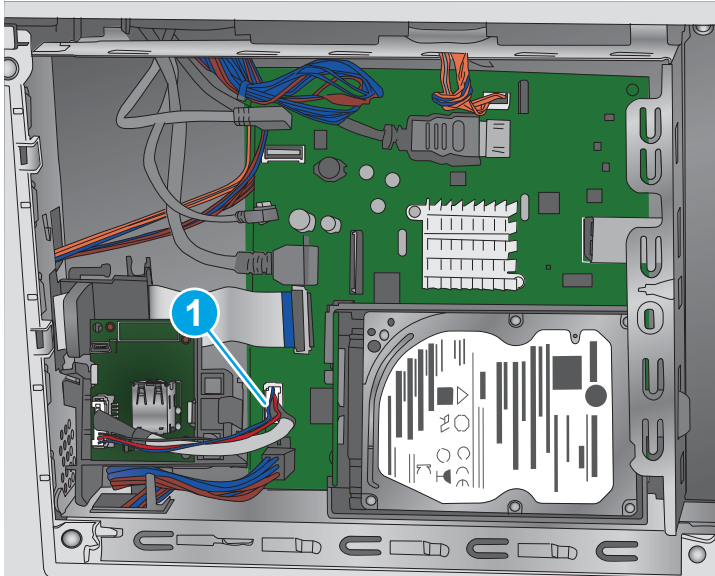

3. Release two tabs (callout 1), and then remove the internal USB ports module (callout 2).

Figure 1-5379 Remove the module

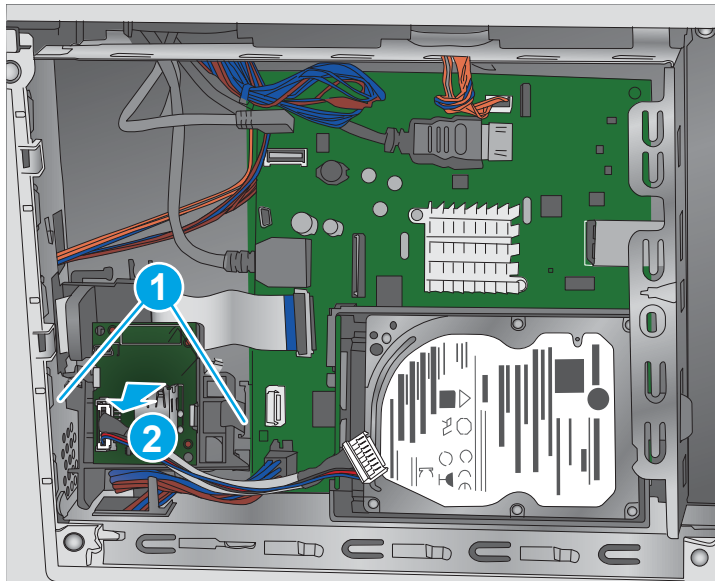

Step 3: Unpack the replacement assembly

Unpack the replacement assembly from the packaging.

CAUTION:  ESD-sensitive part.

For complete information on HP's recycling programs, go to [Product return and recycling](#).

NOTE:  HP recommends responsible disposal of the defective part.

Figure 1-5380 Recycle and unpack

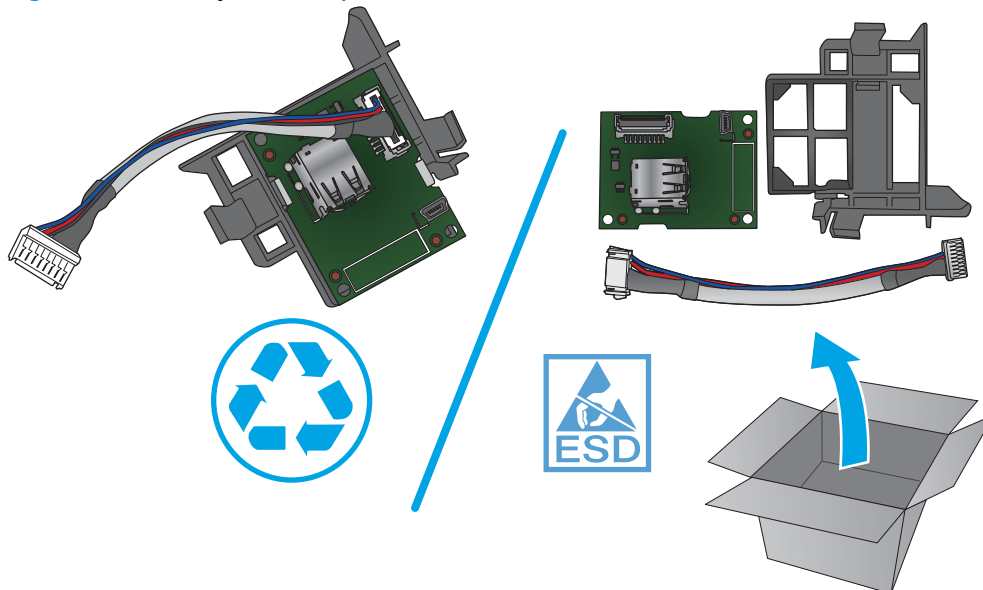

Step 4: Install the internal USB ports module (M577)

 **CAUTION:**  ESD-sensitive part.

1. Position the notches on the internal USB ports PCA over the clips on the PCA holder and press down to attach the PCA to the holder. Make sure that the clips snap into place.

Figure 1-5381 Install the PCA in the holder

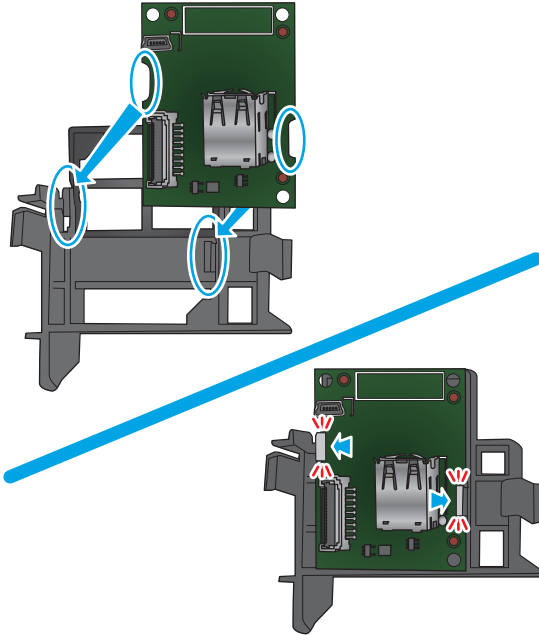

2. Connect one cable to the PCA.

Figure 1-5382 Connect one cable

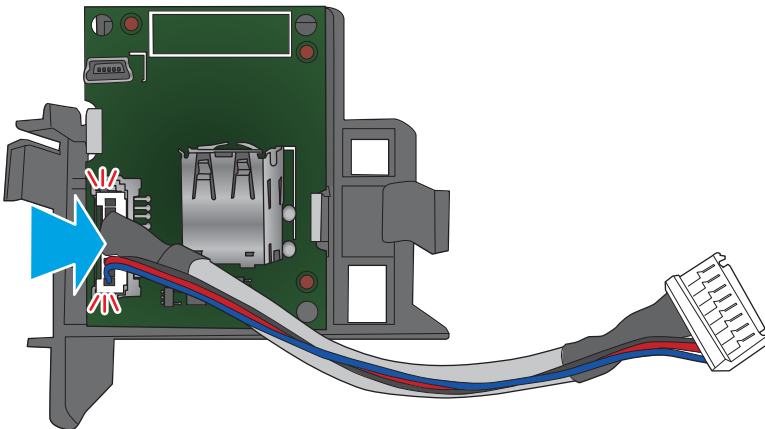

3. Position the clips and locator pins on the internal USB ports module holder (callout 1) in the holes (callout 2) in the formatter case.

Figure 1-5383 Position the internal USB ports module

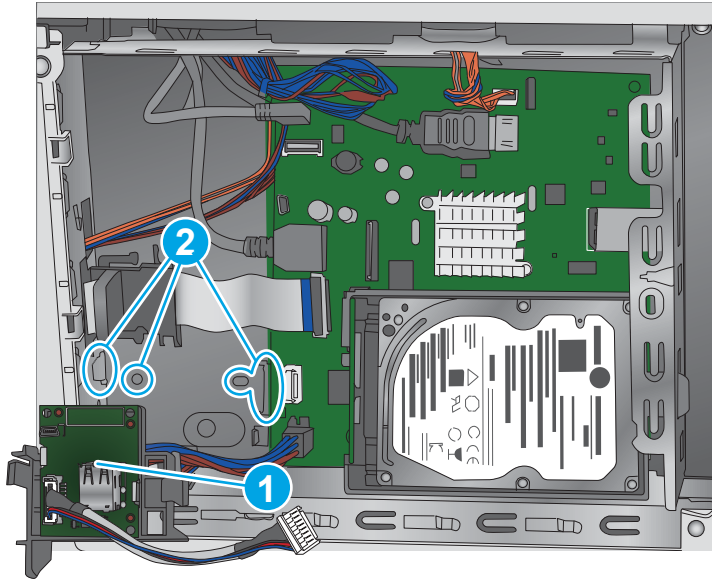

4. Press the internal USB ports module toward the formatter case until the clips snap into place.

Figure 1-5384 Install the internal USB ports module

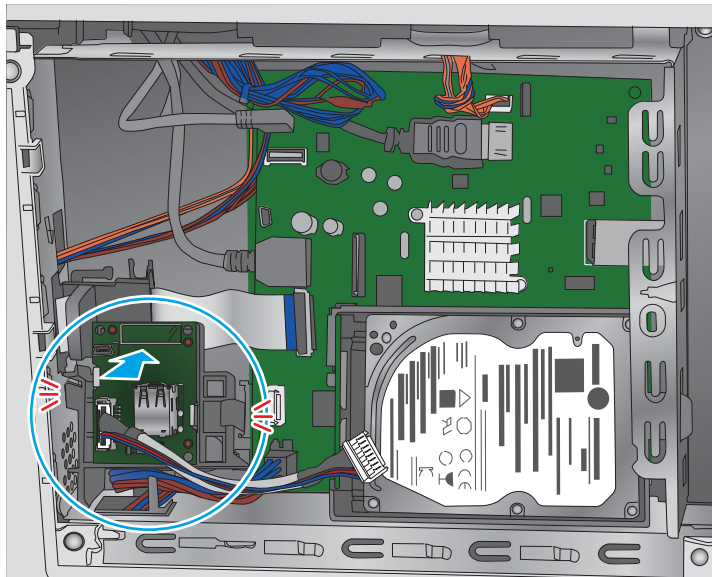

5. Connect one connector (callout 1).

Figure 1-5385 Connect one connector

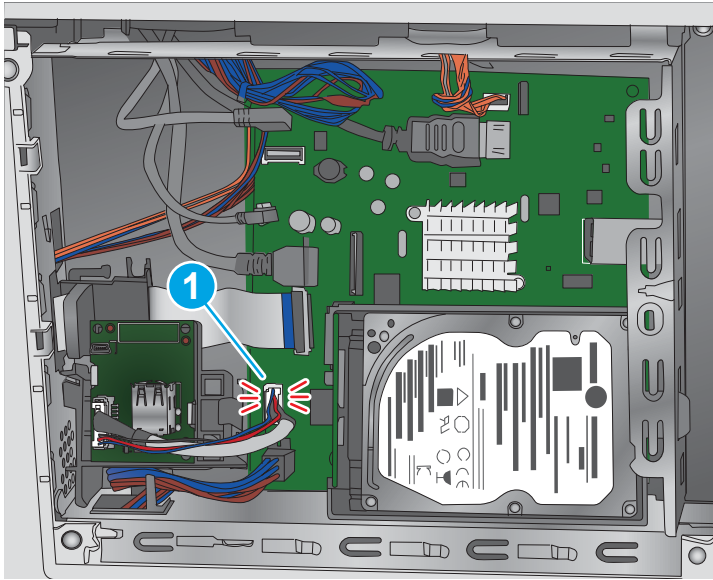

Step 5: Install the formatter cover

- ▲ Slide the cover onto the printer (callout 1) to install it.

 **NOTE:** Make sure that the tabs on the formatter cover align with the slots provided in the printer (callout 2). Tighten the two thumbscrews (callout 3).

 **TIP:** If needed, use the edge of a coin to turn the thumbscrews.

Figure 1-5386 Install the cover



Removal and replacement: Fax PCA (M577c/f/z)

- [Introduction](#)
- [Step 1: Remove the formatter cover](#)
- [Step 2: Remove the fax PCA](#)
- [Step 3: Unpack the replacement assembly](#)
- [Step 4: Install the fax PCA](#)
- [Step 5: Install the formatter cover](#)

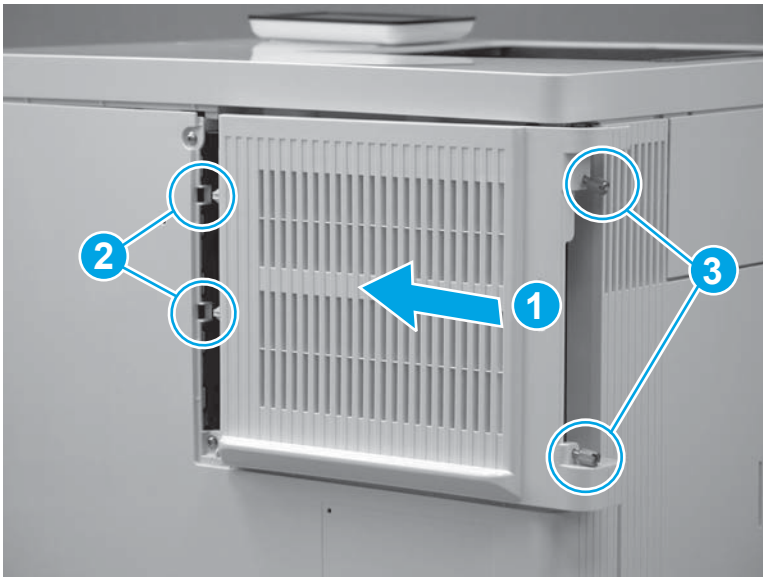
Introduction



This document provides the procedures to remove and replace the fax PCA.

Before performing service

Turn the printer power off

- Disconnect the power cable.

 **WARNING!** To avoid damage to the printer, turn the printer off, wait 30 seconds, and then remove the power cord before attempting to service the printer.

 **CAUTION:**  This part contains components that are electrostatic discharge (ESD) sensitive. To reduce the possibility of ESD damage, always touch the sheet-metal chassis to ground yourself before touching an ESD sensitive part.

Use the table below to identify the correct part number for your printer. To order the part, go to www.hp.com/buy/parts.

Fax PCA part number	
B5L53-67901	Analog FAX 600 kit

Required tools

No special tools are required to install this part.

After performing service

Turn the printer power on

- Connect the power cable.
- Use the power switch to turn the power on.

Post service test

Print a configuration page to make sure that the printer is functioning correctly.

Step 1: Remove the formatter cover

1. Locate the formatter cover.

Figure 1-5387 Locate the formatter cover

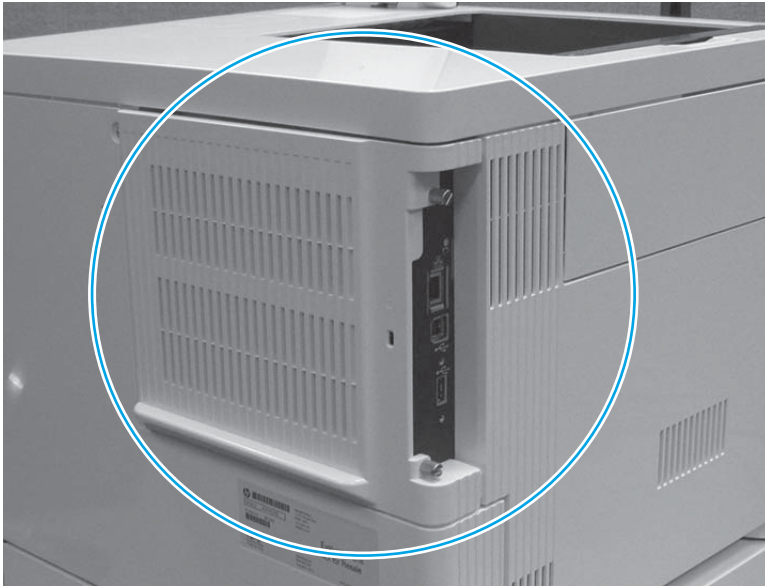

2. Loosen the two thumbscrews (callout 1). Grasp the two thumbscrews, and then slide the cover away from the printer (callout 2) to remove it.

 **TIP:** If needed, use the edge of a coin to turn the thumbscrews.

Figure 1-5388 Loosen the thumbscrews



Step 2: Remove the fax PCA

 **CAUTION:**  ESD-sensitive part.

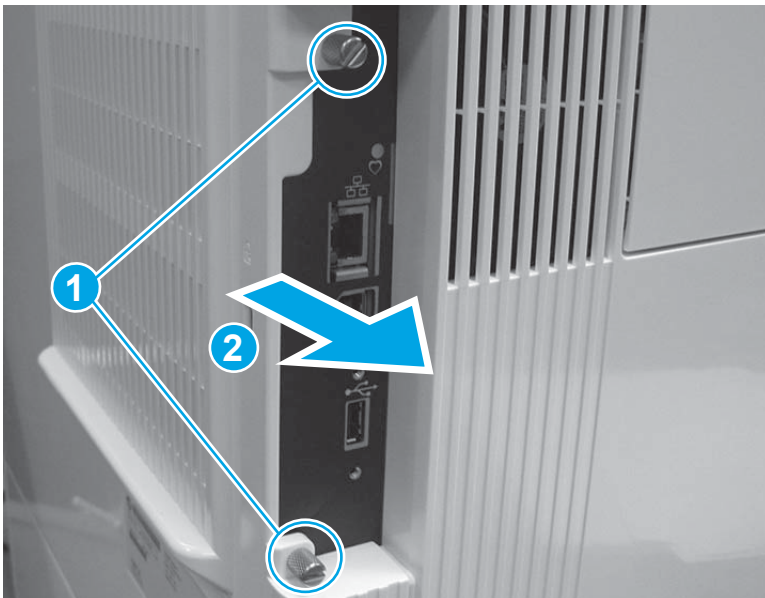
1. Locate the fax PCA component on the formatter.

Figure 1-5389 Locate the fax PCA

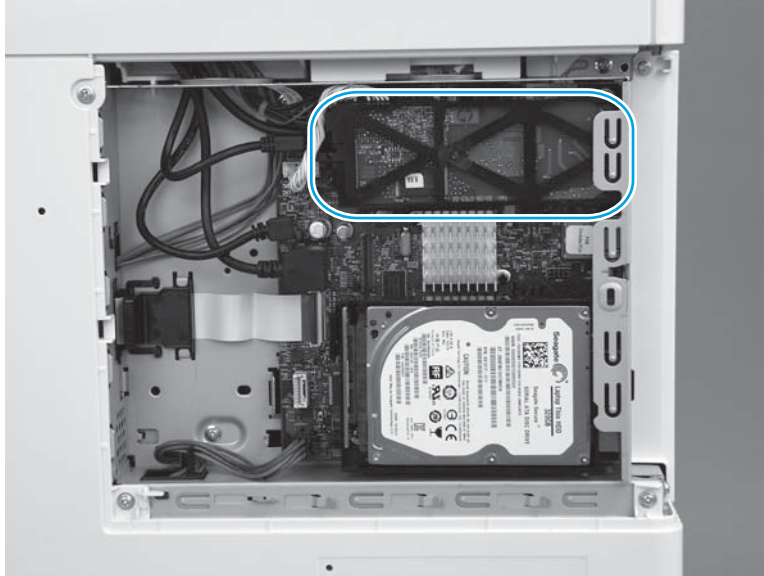

2. Release the connector latch (callout 1), and then pull the connector away from the formatter (callout 2) to disconnect it.

Figure 1-5390 Disconnect one connector

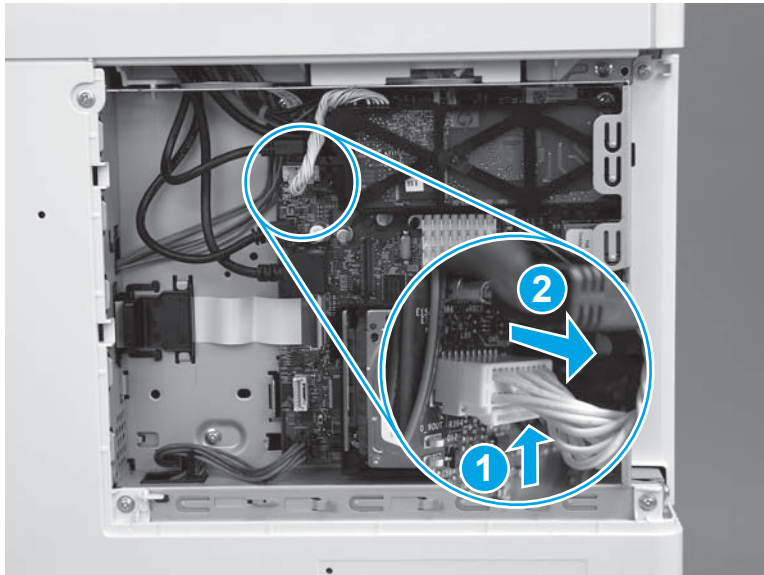

3. Release one retainer (callout 1) by pressing the bracket arms together.

Figure 1-5391 Release one latch

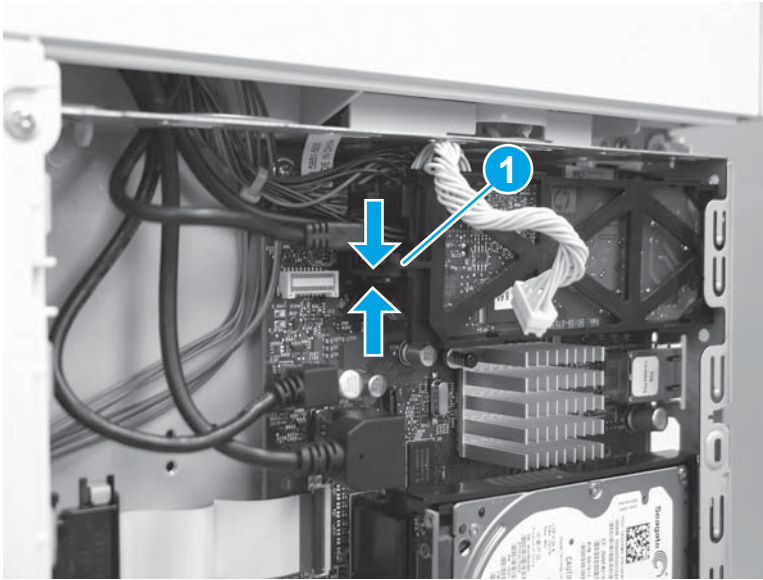

4. Rotate the end of the fax PCA (callout 1) away from the formatter, and then slide the PCA left (callout 2) to remove it.

Figure 1-5392 Remove the fax PCA

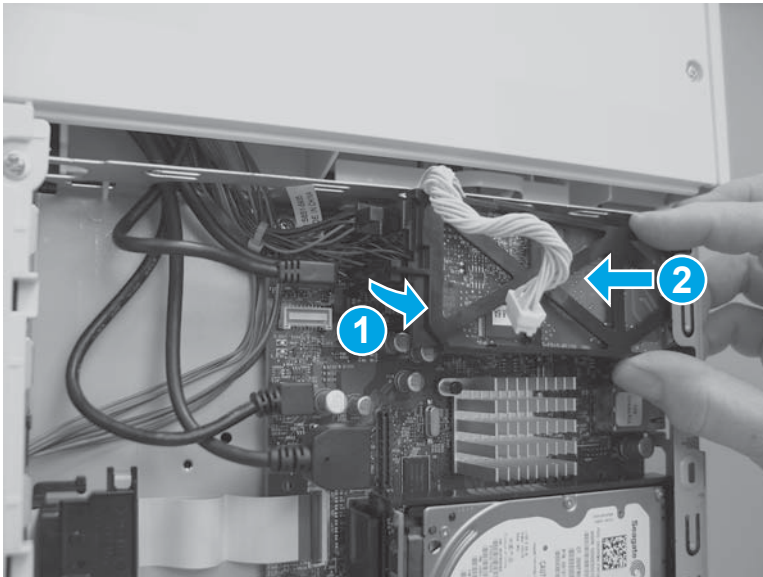

Step 3: Unpack the replacement assembly

Unpack the replacement assembly from the packaging.

 **CAUTION:**  ESD-sensitive part.

For complete information on HP's recycling programs, go to [Product return and recycling](#).

 **NOTE:** HP recommends responsible disposal of the defective part.

Figure 1-5393 Recycle and unpack

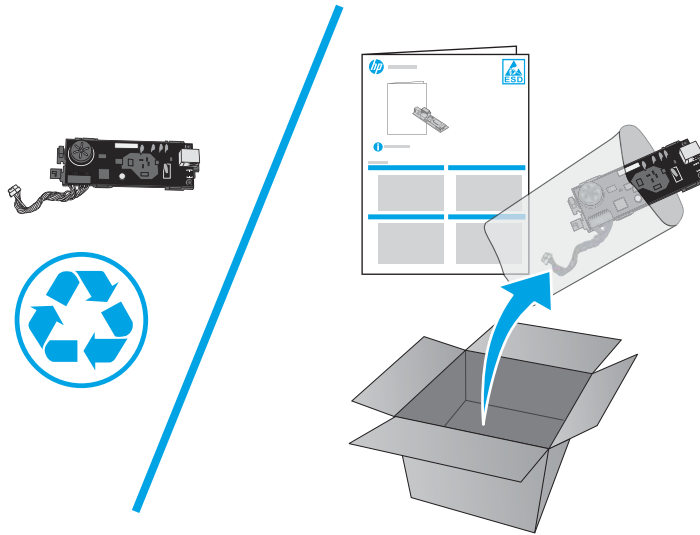

Step 4: Install the fax PCA

CAUTION:  ESD-sensitive part.

1. Position the tab and telephone port (callout 1) on the fax PCA in the slots (callout 2) in the formatter case.

Figure 1-5394 Position the fax PCA

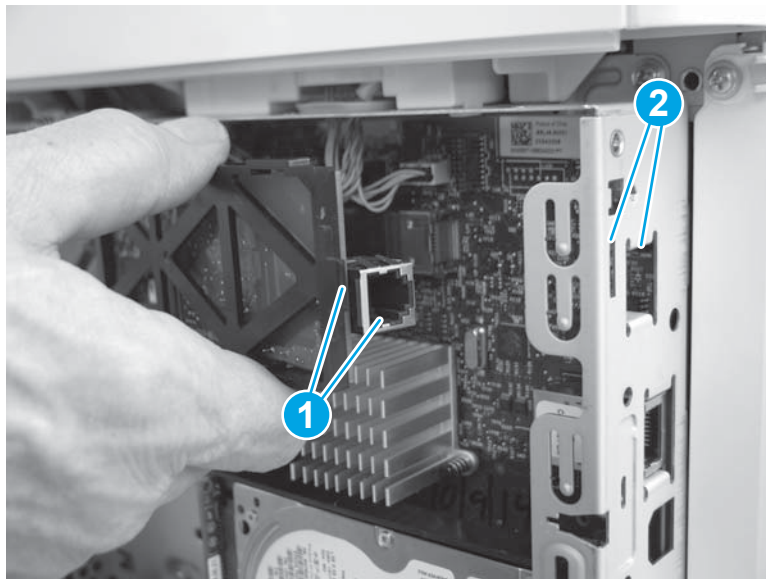

2. Slide the fax PCA to the right (callout 1) until the tab and telephone port described in the previous step and seated in the formatter case. Position the retainer (callout 2) in the slot (callout 3) in the formatter. Rotate the end of the fax PCA toward the formatter (callout 4) until the retainer snaps into place.

Figure 1-5395 Install the fax PCA

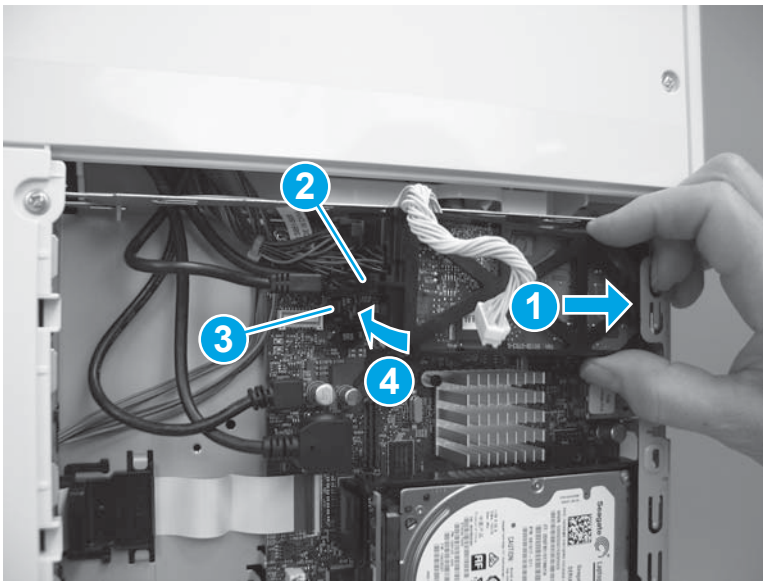

3. Position the cable (callout 1) in the guide (callout 2), and then connect one connector (callout 3).

Figure 1-5396 Connect the connector

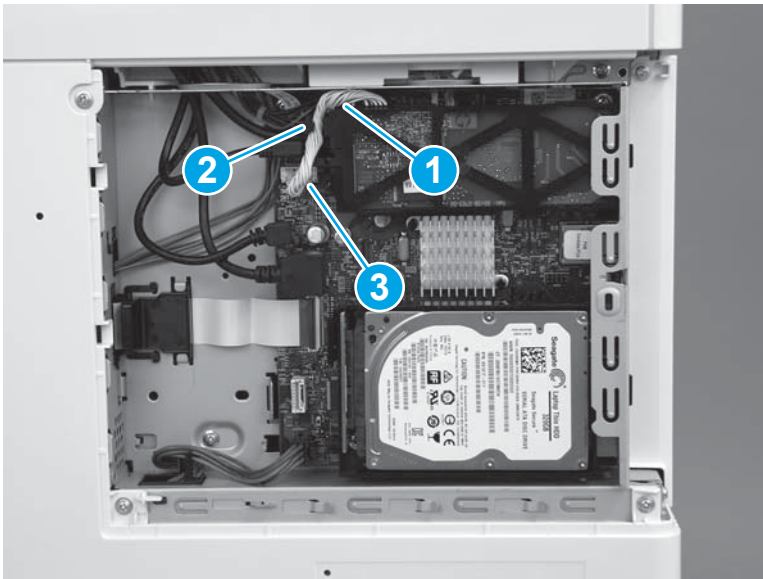

Step 5: Install the formatter cover

- ▲ Slide the cover onto the printer (callout 1) to install it.

 **NOTE:** Make sure that the tabs on the formatter cover align with the slots provided in the printer (callout 2). Tighten the two thumbscrews (callout 3).

 **TIP:** If needed, use the edge of a coin to turn the thumbscrews.

Figure 1-5397 Install the cover



2 Parts and diagrams

- [For additional service and support](#)
- [Assembly locations](#)
- [Order parts, accessories, and supplies](#)
- [How to use the parts lists and diagrams](#)
- [Parts and diagrams: Document feeder and scanner whole units](#)
- [Parts and diagrams: Covers](#)
- [Parts and diagrams: Internal components](#)
- [Parts and diagrams: 550-sheet paper feeder](#)
- [Alphabetical parts list](#)
- [Numerical parts list](#)

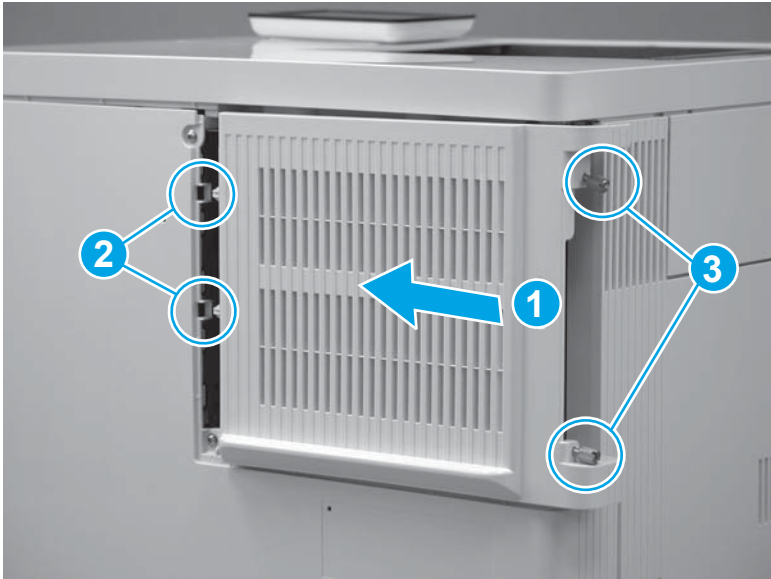
For additional service and support

HP service personnel, go to the Service Access Work Bench (SAW) at <http://h41302.www4.hp.com/km/saw/home.do>.

Channel partners, go to HP Channel Services Network (CSN) at <https://h30125.www3.hp.com/hpcsn>.

At these locations, find information on the following topics:

- Install and configure
- Printer specifications
- Up-to-date control panel message (CPMD) troubleshooting
- Solutions for printer issues and emerging issues
- Remove and replace part instructions and videos
- Service advisories
- Warranty and regulatory information

To access HP PartSurfer information from any mobile device, go to <http://partsurfermobile.hp.com/> or scan the Quick Response (QR) code below.



Assembly locations

Product front view (M552 and M553 models)

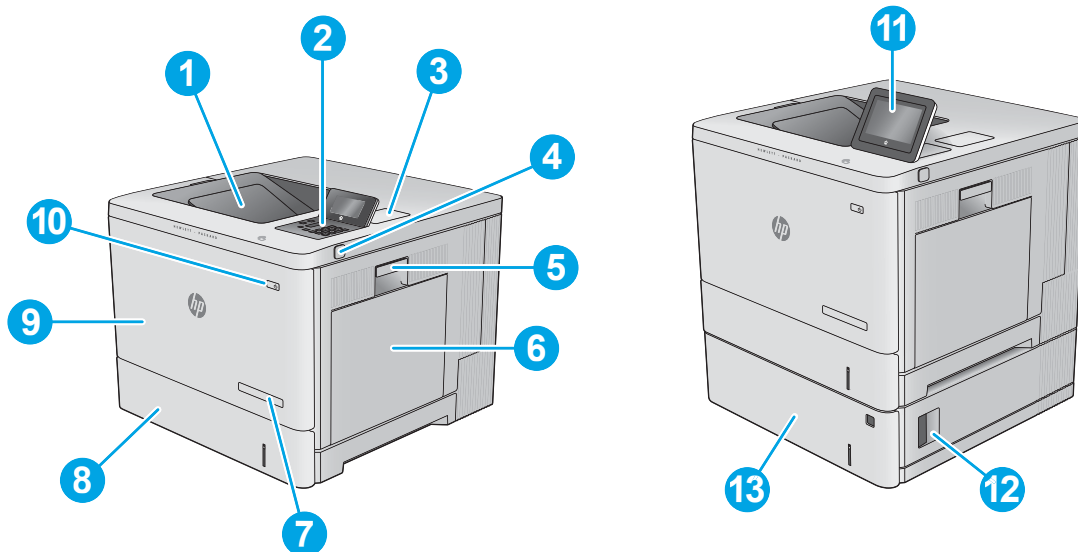

1	Standard output bin
2	4-line LCD control panel with keypad (n and dn models only)
3	Hardware integration pocket for connecting accessory and third-party devices (dn and x models only)
4	Easy-access USB port
5	Right door (access to the fuser and for clearing jams)
6	Tray 1
7	Model name
8	Tray 2
9	Front door (access to the toner cartridges)
10	On/off button
11	Control panel with color touchscreen display (x model only)
12	Lower-right door for the 550-sheet paper feeder (access for clearing jams)
13	550-sheet paper feeder, Tray 3 (included with the x model, optional for the other models)

NOTE: The M552 model accepts one 550-sheet paper feeder. The M553 models accept up to three 550-sheet paper feeders.

Product back view (M552 and M553 models)

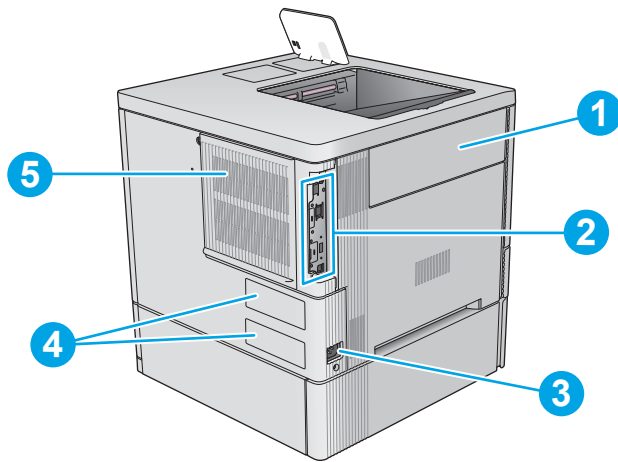

1	Toner-collection-unit door
2	Formatter (contains the interface ports)
3	Power connection
4	Serial number and product number label
5	Formatter cover

Product front view (M577 models)

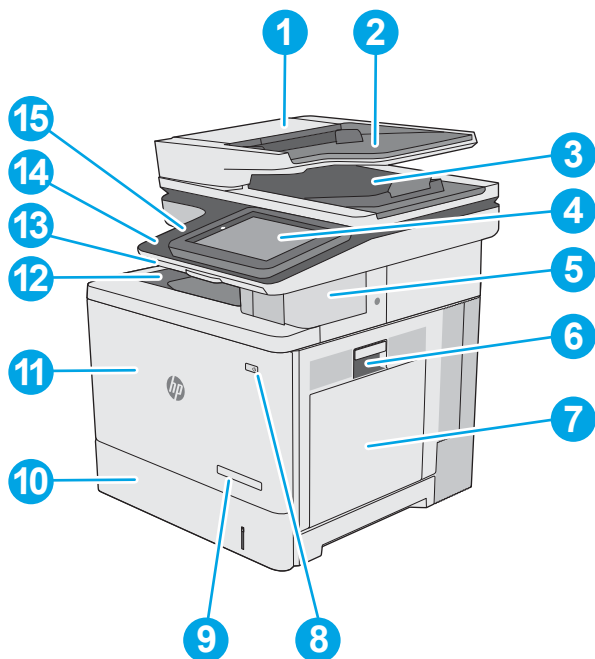

1	Document-feeder cover (access for clearing jams)
2	Document-feeder input tray
3	Document-feeder output bin
4	Control panel with color touchscreen display
5	Convenience stapler (M577c/f/z models only)
6	Right door (access to the fuser and for clearing jams)
7	Tray 1
8	On/off button
9	Model name
10	Tray 2
11	Front door (access to the toner cartridges)
12	Standard output bin
13	Physical keyboard (M577c/z models only)
14	Easy-access USB port (on the side of the control panel)
15	Hardware integration pocket (for connecting accessory and third-party devices)

Product back view (M577 models)

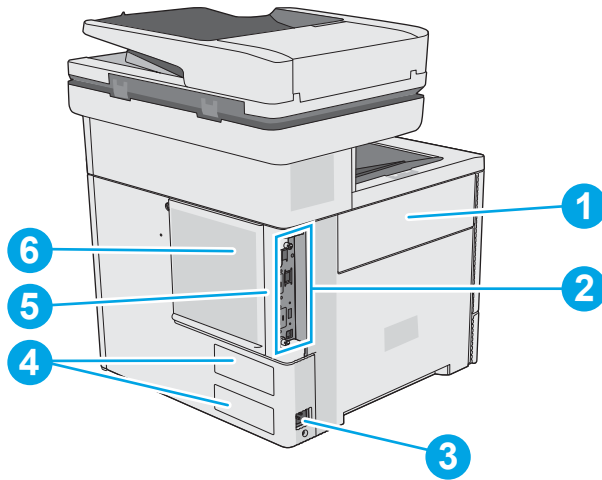

1	Toner-collection-unit door
2	Formatter (contains the interface ports)
3	Power connection
4	Serial number and product number label
5	Slot for a cable-type security lock (on the rear cover of the printer)
6	Formatter cover

Order parts, accessories, and supplies

Ordering

Order supplies and paper	www.hp.com/go/suresupply
Order genuine HP parts or accessories	www.hp.com/buy/parts or partsurfer.hp.com
Order through service or support providers	Contact an HP-authorized service or support provider.
Order using the HP Embedded Web Server (EWS)	To access, in a supported Web browser on your computer, enter the product IP address or host name in the address/URL field. The EWS contains a link to the HP SureSupply Web site, which provides options for purchasing Original HP supplies.

Orderable parts

Not all of the parts shown in the diagrams in this chapter can be ordered. Refer to the table following the diagram or the parts lists at the end of this chapter to determine if a part is orderable.

Supplies

Following are the part numbers for the supplies available for the product.

Table 2-1 Supplies

Item	Description	Part number
HP 508A Black Original LaserJet Toner Cartridge	Standard-capacity replacement black toner cartridge	CF360A (new)
		CF360-67901 (service)
HP 508X High Yield Black Original LaserJet Toner Cartridge	High-capacity replacement black toner cartridge	CF360X (new)
		CF360-67902 (service)
HP 508A Cyan Original LaserJet Toner Cartridge	Standard-capacity replacement cyan cartridge	CF361A (new)
		CF361-67901 (service)
HP 508X High Yield Cyan Original LaserJet Toner Cartridge	High-capacity replacement cyan toner cartridge	CF361X (new)
		CF361-67902 (service)
HP 508A Yellow Original LaserJet Toner Cartridge	Standard-capacity replacement yellow toner cartridge	CF362A (new)
		CF362-67901 (service)
HP 508X High Yield Yellow Original LaserJet Toner Cartridge	High-capacity replacement yellow toner cartridge	CF362X (new)
		CF362-67902 (service)
HP 508A Magenta Original LaserJet Toner Cartridge	Standard-capacity replacement magenta toner cartridge	CF363A (new)
		CF363-67901 (service)

Table 2-1 Supplies (continued)

Item	Description	Part number
HP 508X High Yield Magenta Original LaserJet Toner Cartridge	High-capacity replacement magenta toner cartridge	CF363X (new)
		CF363-67902 (service)
HP toner-collection unit	Replacement toner-collection unit with attached door	B5L37A (new)
		B5L37-67901 (service)
HP Staple Cartridge Pack (M577f and M577z)	Replacement staple cartridges. Contains two staple cartridges of 1500 staples each.	Q7432A
HP LaserJet 200 ADF Roller Replacement Kit (M577)	Replacement feed rollers for the document feeder	B5L52A (new)
		B5L52-67903 (service)
Fuser kit (110V)	Fuser (110V)	B5L35A (new)
		B5L35-67902 (service)
Fuser kit (220V)	Fuser (220V)	B5L36A (new)
		B5L36-67902 (service)

Accessories

Following are the part numbers for the accessories available for the printers.

Table 2-2 Accessories (M552 and M553)

Item	Description	Part number
550-sheet paper feeder	Optional 550-sheet paper feeder (included with the x model) NOTE: The M552 model accepts one 550-sheet paper feeder. The M553 models accept up to three 550-sheet paper feeders.	B5L34A (new)
		B5L34-67901 (service)
Printer stand and cabinet	Optional stand with storage cabinet to support the printer Recommended when using multiple optional paper feeders.	B5L51A (new)
		B5L51-67901 (service)
HP secure 500 GB high-performance hard disk drive	Optional hard drive NOTE: Not supported for the M552dn.	B5L29A (new)
		B5L29-67903 (service)
1GB DDR3 slim memory DIMM	Optional DIMM for expanding the memory NOTE: M553 only	G6W84A (new)
		5851-6422 (service)
HP internal USB ports	Two optional USB ports for connecting third-party devices	B5L28A (new)
		B5L28-67902 (service)
HP Trusted Platform Module (TPM)	Automatically encrypts all data that passes through the product	F5S62A (new)
		F5S62-61001 (service)

Table 2-3 Accessories (M577)

Item	Description	Part number
550-sheet paper feeder	Optional 550-sheet paper feeder	B5L34A (new)
	NOTE: The printer supports up to three 550-sheet paper feeders.	B5L34-67901 (service)
Printer stand and cabinet	Optional stand with storage cabinet to support the printer	B5L51A (new)
	Recommended when using multiple optional paper feeders.	B5L51-67901 (service)
HP LaserJet Keyboard Overlay Kit for Simplified Chinese & Traditional Chinese	Language-specific, adhesive overlay for the physical keyboard	A7W12A
HP LaserJet Keyboard Overlay Kit for Swedish	Language-specific, adhesive overlay for the physical keyboard	A7W14A
HP secure 500 GB high-performance hard disk drive	Optional 500 GB hard drive	B5L29A (new)
		B5L29-67903 (service)
1GB DDR3 x32 144-Pin 800MHz SODIMM (M577)	Optional DIMM for expanding the memory	E5K48A (new)
		E5K48-67902 (service)
HP internal USB ports	Two optional USB ports for connecting third-party devices	B5L28A (new)
		B5L28-67902 (service)
HP Smartcard NIPRNet Solution for US Government	Nonsecure Internet Protocol (IP) Router Network for transmitting non-classified information	CC543B
NOTE: Requires installing the HP Internal USB ports accessory (B5L28A).		
HP Smartcard NIPRNet Solution for US Government	Secret Internet Protocol (IP) Router Network for transmitting classified information	F8B30A
NOTE: Requires installing the HP Internal USB ports accessory (B5L28A).		
HP Trusted Platform Module (TPM)	Automatically encrypts all data that passes through the product	F5S62A (new)
		F5S62-61001 (service)
HP Foreign Interface Harness	Optional port for connecting third-party devices	B5L31A (new)
		B5L31-67902 (service)
HP LaserJet MFP Analog Fax Accessory 600	Optional fax accessory for the dn model	B5L53A (new)
		B5L53-67901 (service)
HP Jetdirect 2900nw Print Server	USB wireless print server accessory	J8031A
HP Jetdirect 3000w NFC/Wireless Accessory	Wi-Fi direct accessory for “touch” printing from mobile devices	J8030A

Customer self-repair kits

Following are the customer-replaceable kits available for the product. Each kit includes parts and installation instructions.

The customer self-repair (CSR) level indicates the expected difficulty the customer will experience when replacing this part:

- **A:** Easy
- **B:** Difficult

Item	Description	CSR level	Part number
Control panel kit (M553x only)	<ul style="list-style-type: none"> • Control panel 	A	B5L24-67903
Control panel kit (M577 only)	<ul style="list-style-type: none"> • Control panel 	A	B5L47-67018
Secondary transfer roller kit	<ul style="list-style-type: none"> • Secondary transfer roller 	A	B5L24-67902
Intermediate transfer belt (ITB) and secondary transfer roller kit	<ul style="list-style-type: none"> • ITB • Secondary transfer roller 	B	B5L24-67901
Tray 2-5 roller kit	<ul style="list-style-type: none"> • Rollers for Tray 2 and the optional 550-sheet paper feeders 	A	B5L24-67904
ADF roller replacement Kit (M577)	Replacement feed rollers for the document feeder	A	B5L52-67903
Fuser kit (110V)	<ul style="list-style-type: none"> • Fuser (110V) 	A	B5L35-67902
Fuser kit (220V)	<ul style="list-style-type: none"> • Fuser (220V) 	A	B5L36-67902
embedded MultiMedia Card (eMMC) kit (M552 and M553 only)	<ul style="list-style-type: none"> • eMMC module 	A	5851-6436
320GB encrypted hard disk drive kit (M577 only)	<ul style="list-style-type: none"> • Replacement hard disk drive 	A	5851-6712
White backing kit (M577 only)	<ul style="list-style-type: none"> • White backing for the document feeder • Retention clips for the document feeder white backing 	A	5851-6570
Retention clip kit (M577 only)	<ul style="list-style-type: none"> • Retention clips for the document feeder white backing 	A	5851-6573
Keyboard kit (M577c/z only)	<ul style="list-style-type: none"> • Keyboard 	A	B5L47-67019 (US) B5L47-67020 (UK)
Keyboard overlay kit (FR, IT, RU, DE, ES: UK Kybd) (M577c/z only)	<ul style="list-style-type: none"> • Keyboard overlay 	A	5851-6019
Keyboard overlay kit (FR-CN, ES-LA, ES: US Kybd)(M577c/z only)	<ul style="list-style-type: none"> • Keyboard overlay 	A	5851-6020
Keyboard overlay kit (FR-SW, DE-SW, DA: UK Kybd) (M577c/z only)	<ul style="list-style-type: none"> • Keyboard overlay 	A	5851-6021
Keyboard overlay kit (ZHTW, ZHCN) (M577c/z only)	<ul style="list-style-type: none"> • Keyboard overlay 	A	5851-6022

Item	Description	CSR level	Part number
Keyboard overlay kit (ES, PT) (M577c/z only)	<ul style="list-style-type: none">Keyboard overlay	A	5851-6023
Keyboard overlay kit (JA-KG, JA-KT) (M577c/z only)	<ul style="list-style-type: none">Keyboard overlay	A	5851-6024

Related documentation and software

HP service personnel, go to the Service Access Work Bench (SAW) at <http://h41302.www4.hp.com/km/saw/home.do>.

Channel partners, go to HP Channel Services Network (CSN) at <https://h30125.www3.hp.com/hpcsn>.

How to use the parts lists and diagrams

The figures in this chapter show the major subassemblies in the product and their component parts. A parts list table follows each exploded view assembly diagram. Each table lists the item number, the associated part number, and the description of each part. If a part is not listed in the table, then it is not a field replacement unit (FRU).

 **CAUTION:** Be sure to order the correct part. When looking for part numbers for electrical components, pay careful attention to the voltage that is listed in the description column. Doing so will ensure that the part number selected is for the correct model.

 **NOTE:** In this manual, the abbreviation “PCA” stands for “printed circuit-board assembly.” Components described as a PCA might consist of a single circuit board or a circuit board plus other parts, such as cables and sensors.

Parts and diagrams: Document feeder and scanner whole units

Figure 2-1 Document feeder and scanner whole units (M577 only)

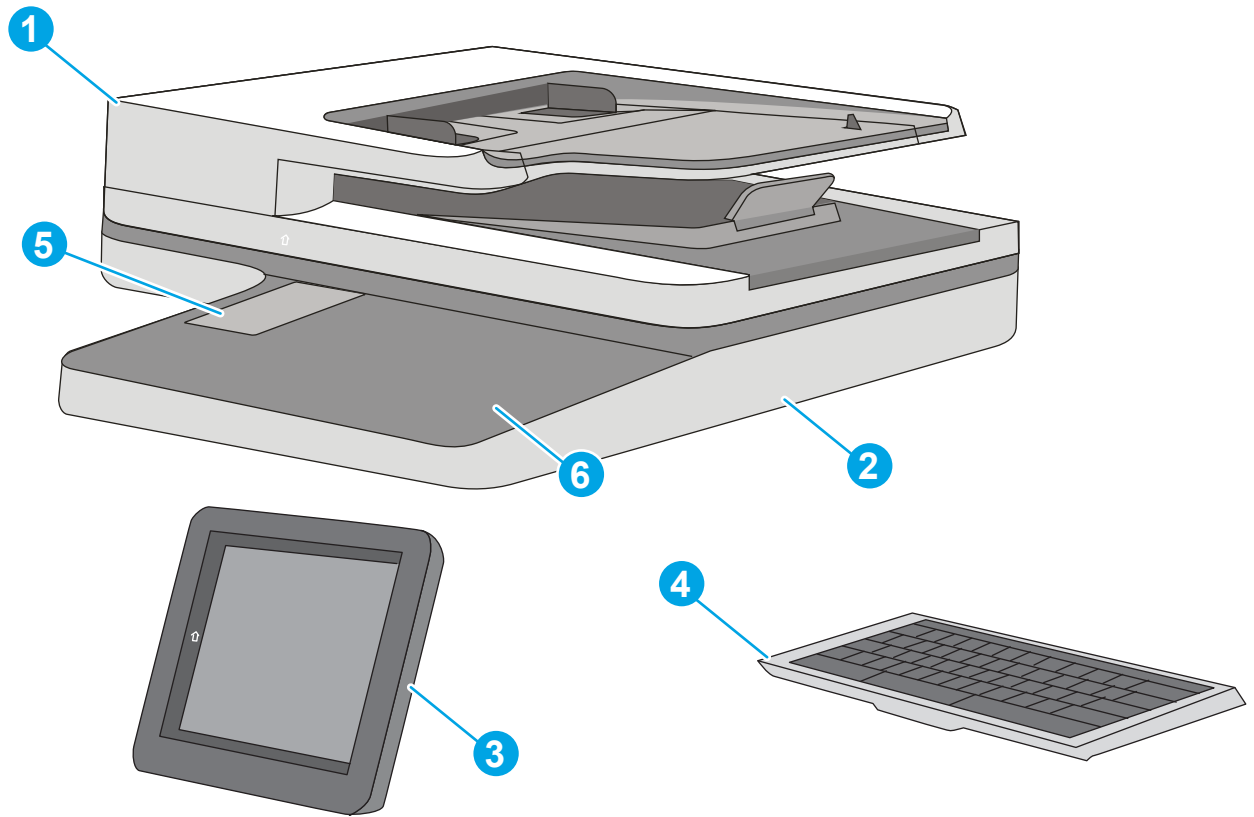

Table 2-4 Document feeder and scanner whole units (M577 only)

Ref	Description	Part number	Qty
1	Document feeder (M577dn/f) kit; includes white backing and retention clips	B5L47-67901	1
1	Document feeder (M577c/z) kit; includes white backing and retention clips	B5L47-67902	1
2	Image scanner (M577) kit; includes white backing and retention clips	B5L46-67904	1
3	Control panel (M577) kit	B5L47-67018	1
4	Keyboard US (M577c/z)	B5L47-67019	1
4	Keyboard UK (M577c/z)	B5L47-67020	1
5	Cover, HIP (M577)	B5L46-40021	1
6	Bezel, control panel with NFC icon (M577)	B5L46-40026	1
6	Bezel, control panel without NFC icon (M577)	B5L46-40020	1
Not shown	Scan control board	B5L47-67903	1
Not shown	Cover, keyboard (M577dn/f)	B5L46-40002	1
Not shown	Cover, rear (image scanner; M577)	B5L46-40011	1
Not shown	Cover, USB (M577)	B5L46-40028	1
Not shown	Cover, right front upper (M577dn)	B5L46-40024	1
Not shown	Cover assembly, stapler (M577c/f/z)	B5L46-60121	1
Not shown	Stapler (M577c/f/z)	B5L46-60102	1
Not shown	Hinge, left document feeder (M577)	COM39-60064	1
Not shown	Hinge, right document feeder (M577)	COM39-60065	1
Not shown	Cable, stapler (M577)	B5L46-60121	1
Not shown	Cable, WU USB control panel (M577)	5851-5939	1
Not shown	Cable, HIP USB control panel (M577)	5851-5938	1
Not shown	Cable, HDMI control panel (M577)	5851-5936	1
Not shown	Cable, 18-pin control panel (M577)	5851-5935	1
Not shown	Cable, HDMI PAB to SCAM (M577)	B5L46-60114	1
Not shown	Keyboard overlay kit (FR, IT, RU, DE, ES: UK Kybd)	5851-6019	1
Not shown	Keyboard overlay kit (FR-CN, ES-LA, ES: US Kybd)	5851-6020	1
Not shown	Keyboard overlay kit (FR-SW, DE-SW, DA: UK Kybd)	5851-6021	1
Not shown	Keyboard overlay kit (ZHTW, ZHCN)	5851-6022	1
Not shown	Keyboard overlay kit (ES, PT)	5851-6023	1
Not shown	Keyboard overlay kit (JA-KG, JA-KT)	5851-6024	1

Parts and diagrams: Covers

Covers (M552 and M553)

Figure 2-2 Covers (M552, M553)

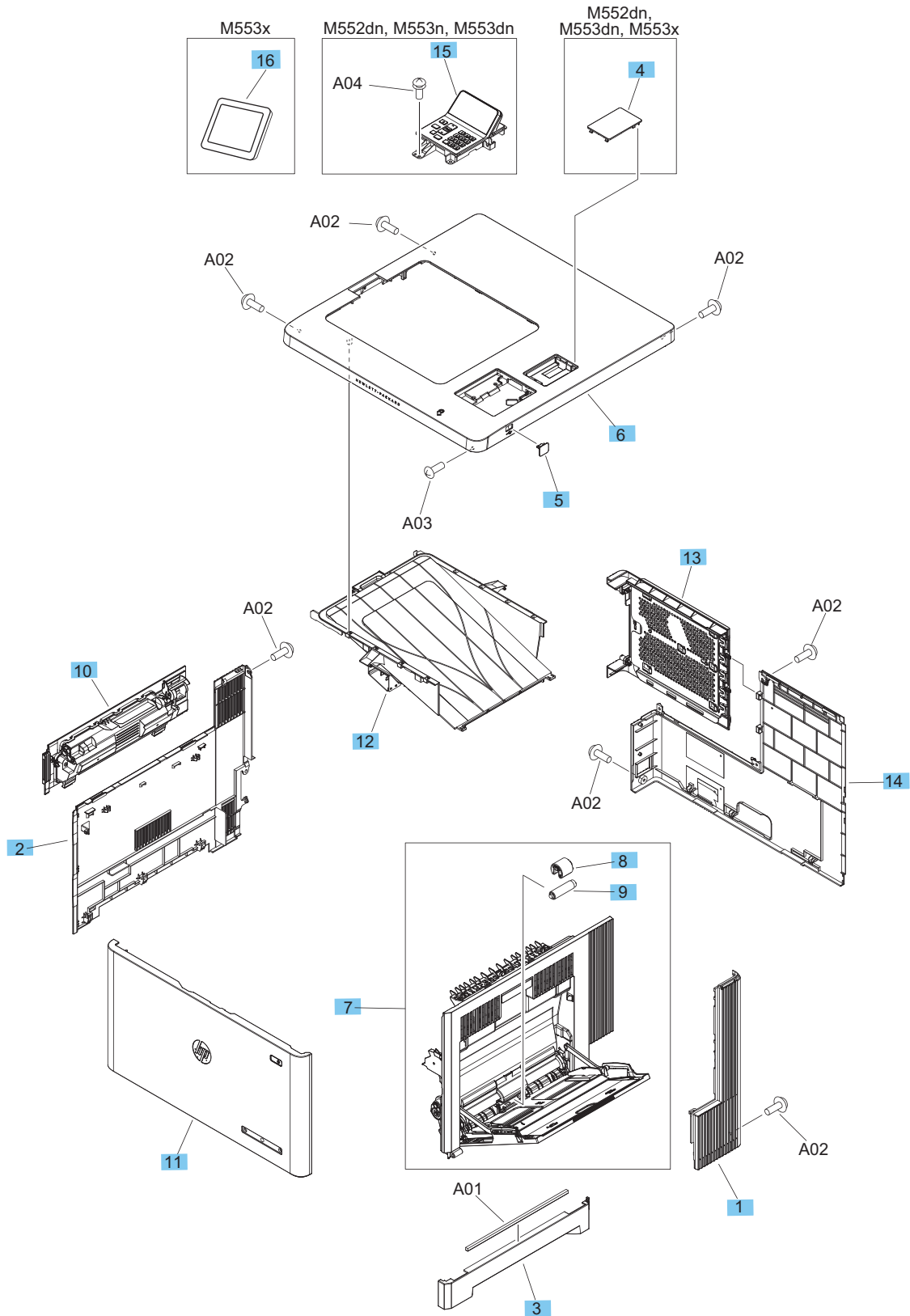

Table 2-5 Covers (M552, M553)

Ref	Description	Part number	Qty
1	Cover, right rear	RC4-0178-000CN	1
2	Cover, left	RC4-0179-000CN	1
3	Handle, right	RC4-0183-000CN	1
4	Cover, HIP (M552dn, M553dn, M553x)	RC4-0213-000CN	1
5	Cover, USB	RC4-0214-000CN	1
6	Cover, upper (M553n)	RL2-0096-000CN	1
6	Cover, upper (M553x)	RL2-0097-000CN	1
6	Cover, upper (M552dn, M553dn)	RL2-0098-000CN	1
7	Door assembly, right	RM2-0019-000CN	1
8	Roller, pickup, Tray 1 (part of Tray 1 roller kit)	B5L24-67905	1
9	Roller, separation, Tray 1 (part of Tray 1 roller kit)	B5L24-67905	1
10	Toner collection unit	B5L37-67901	1
11	Cover, front (M552, M553)	B5L25-67901	1
12	Output bin	RM2-0044-000CN	1
13	Cover, formatter	RM2-0084-000CN	1
14	Cover, rear	RM2-0085-000CN	1
15	Control panel (M552dn, M553n, M553dn)	RM2-7180-000CN	1
16	Control panel (M553x)	B5L24-67903	1

Covers (M577)

Figure 2-3 Covers (M577)

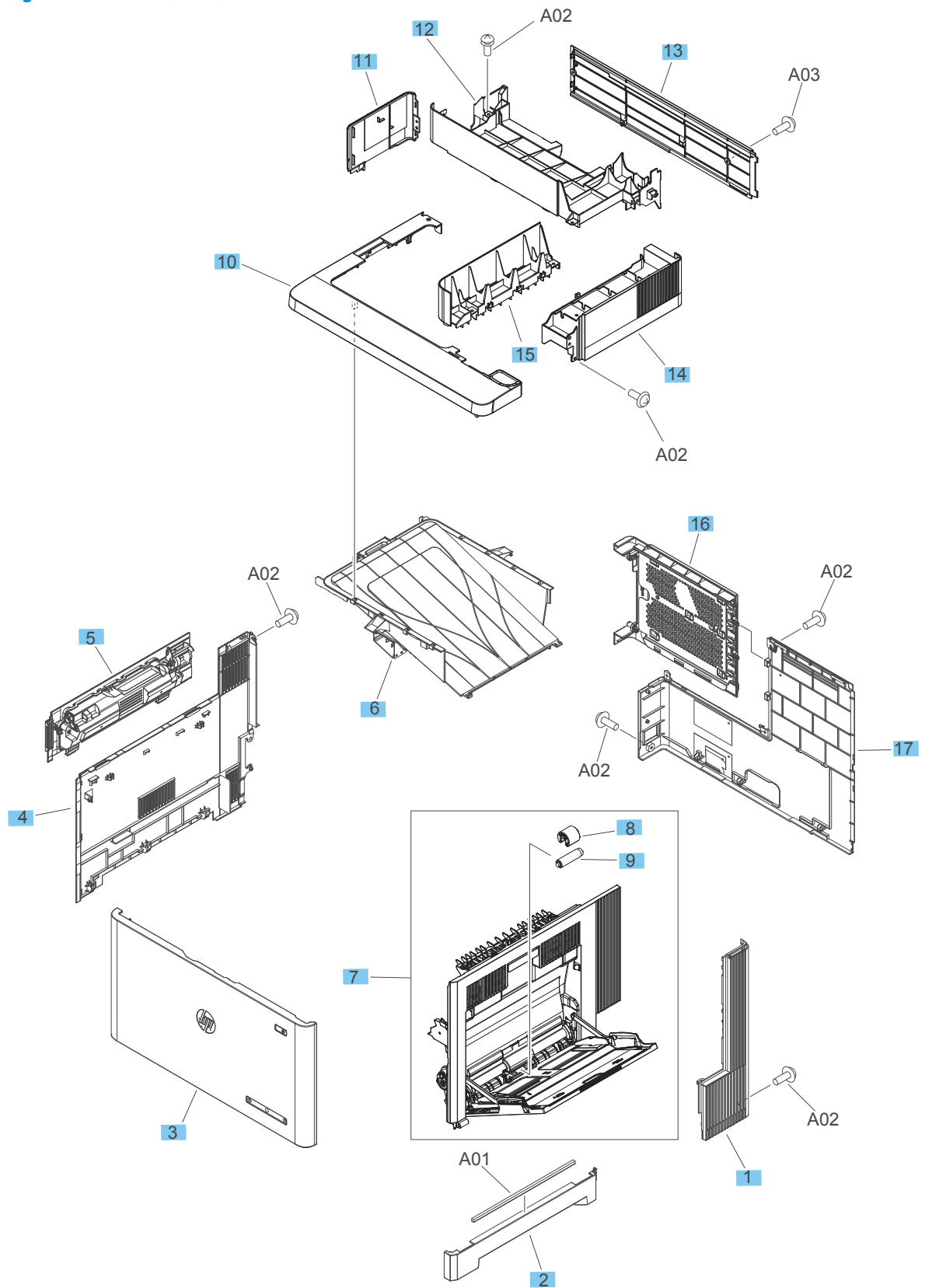

Table 2-6 Covers (M577)

Ref	Description	Part number	Qty
1	Cover, right rear	RC4-0178-000CN	1
2	Handle, right	RC4-0183-000CN	1
3	Cover, front (M577)	B5L46-67906	1
4	Cover, left	RC4-0179-000CN	1
5	Toner collection unit	B5L37-67901	1
6	Output bin	RM2-0044-000CN	1
7	Right door assembly	RM2-0019-000CN	1
8	Roller, pickup, Tray 1 (part of Tray 1 roller kit)	B5L24-67905	1
9	Roller, separation, Tray 1 (part of Tray 1 roller kit)	B5L24-67905	1
10	Cover, top (M577)	RL2-0769-000CN	1
11	Cover, left upper (M577)	RL2-0770-000CN	1
12	Cover, top rear (M577)	RC4-3383-000CN	1
13	Cover, rear upper (M577)	RL2-0771-000CN	1
14	Cover, right upper (M577)	RL2-0772-000CN	1
15	Cover, paper feed (M577)	RC4-3382-000CN	1
16	Cover, formatter	RM2-0084-000CN	1
17	Cover, rear	RM2-0085-000CN	1

Table 2-7 Internal components (1 of 5)

Ref	Description	Part number	Qty
1	Fan, fuser (FM4)	RK2-2418-000CN	1
2	Fan, cartridge (FM2)	RK2-6124-000CN	1
3	Glass cleaner assembly, dust-proof	RM2-0086-000CN	4
4	Waste toner detect PCA assembly	RM2-7130-000CN	1
5	Connecting PCA assembly	RM2-7156-000CN	1
6	Inner door	RL2-0013-010CN	1
Not shown	Wireless PCA, embedded	1150-7968	1
Not shown	Near field communication (NFC) PCA, embedded (M553x)	B5L24-60002	1
Not shown	Near field communication (NFC) PCA, embedded (M577z)	B5L24-60001	1

Internal components (2 of 5)

Figure 2-5 Internal components (2 of 5)

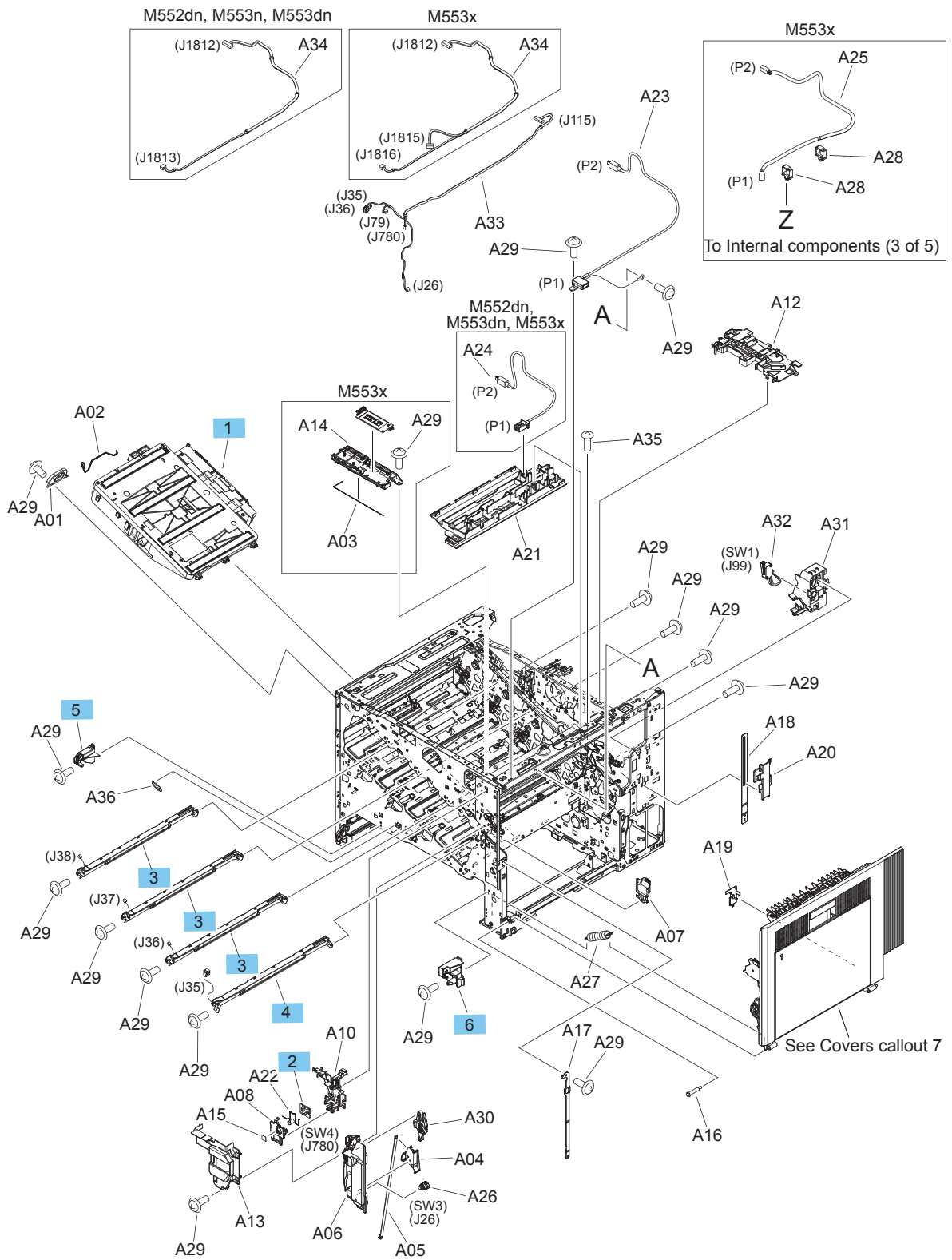

Table 2-8 Internal components (2 of 5)

Ref	Description	Part number	Qty
1	Laser/scanner assembly	RM2-6545-000CN	1
2	Switch PCA assembly (SW4)	RM2-7133-000CN	1
3	Pre-exposure PCA assembly	RM2-7168-000CN	3
4	Pre-exposure PCA assembly	RM2-7169-000CN	1
5	Hinge, cover, front	RC4-0132-000CN	1
6	Hinge, cover, front	RC4-0159-000CN	1

Internal components (3 of 5)

Figure 2-6 Internal components (3 of 5)

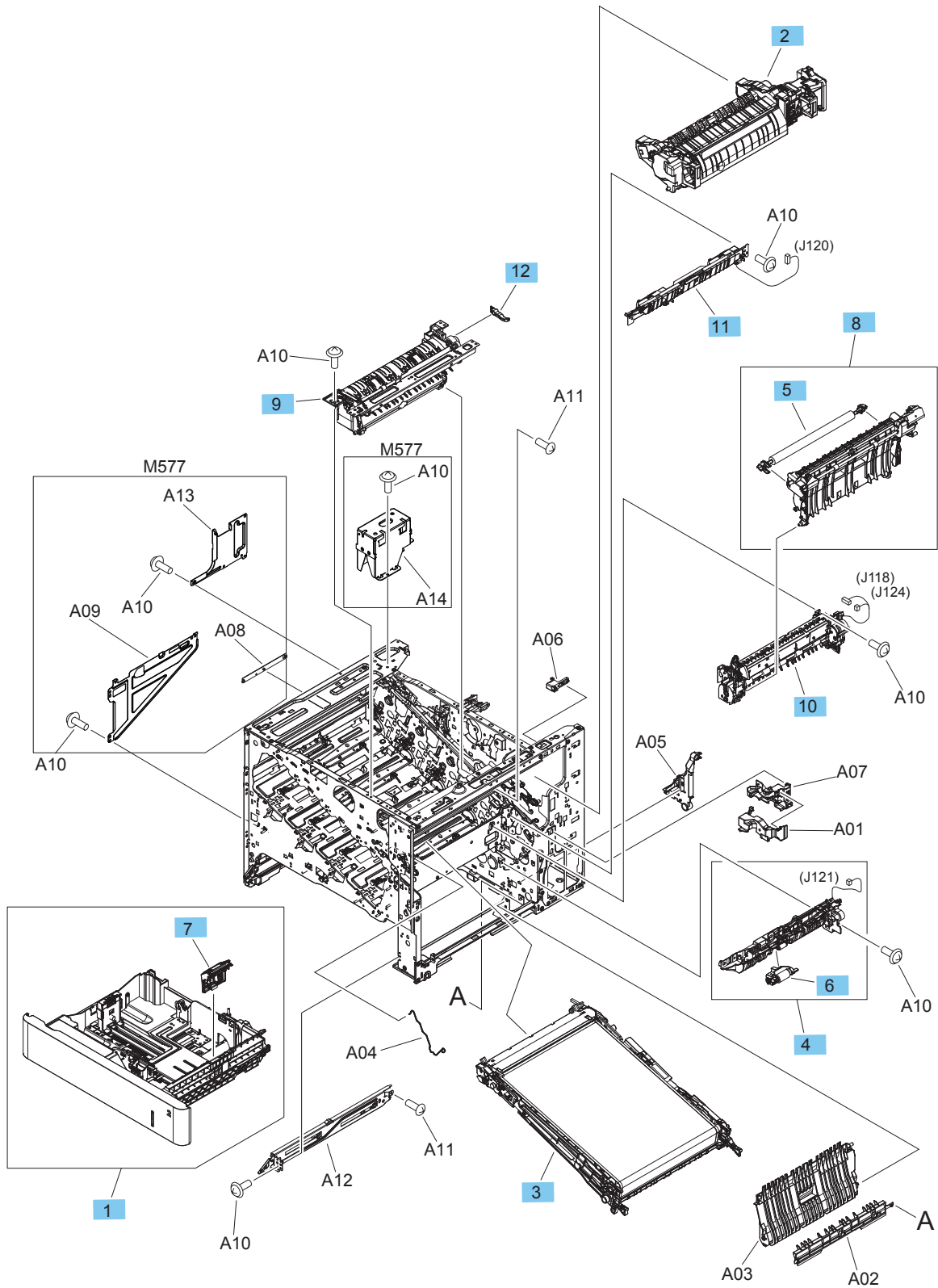

Table 2-9 Internal components (3 of 5)

Ref	Description	Part number	Qty
1	Cassette (Tray 2)	RM2-0007-000CN	1
2	Fuser kit (110V)	B5L35-67902	1
2	Fuser kit (220V)	B5L36-67902	1
2	Fuser service kit (110V)	B5L35-67902	1
2	Fuser service kit (220V)	B5L36-67902	1
3	ITB (part of ITB and secondary transfer roller kit)	B5L24-67901	1
4	Paper pickup assembly	RM2-0017-000CN	1
5	Roller, secondary transfer	B5L24-67902	1
6	Roller, paper pickup (part of Tray 2-5 roller kit)	B5L24-67904	1
7	Roller, separation (part of Tray 2-5 roller kit)	B5L24-67904	1
8	Secondary transfer assembly (M553n)	RM2-0090-000CN	1
8	Secondary transfer assembly (M552dn, M553dn, M553x, M577)	RM2-0022-000CN	1
9	Paper delivery assembly (M553n)	RM2-0092-000CN	1
9	Paper delivery assembly (M552dn, M553dn, M553x, M577)	RM2-0016-000CN	1
10	Registration assembly (M553n)	RM2-0093-000CN	1
10	Registration assembly (M552dn, M553dn, M553x, M577)	RM2-0018-000CN	1
11	Density detect assembly	RM2-7160-000CN	1
12	Arm, solenoid	RC4-0830-000CN	1

Table 2-10 Internal components (4 of 5)

Ref	Description	Part number	Qty
1	Fan, power-supply (FM1)	RK2-2416-000CN	1
2	Fan, delivery (FM3)	RK2-2728-000CN	1
3	Cable, flexible flat	RK2-6101-000CN	1
4	Cable, flexible flat	RK2-6103-000CN	1
5	HVPS (D) PCA assembly	RM2-7122-000CN	1
6	HVPS (T) PCA assembly (M553n)	RM2-7134-000CN	1
6	HVPS (T) PCA assembly (M552dn, M553dn, M553x, M577)	RM2-7123-000CN	1
7	LVPS PCA assembly	RM2-7164-000CN	1
8	DC controller PCA assembly (M552, M553))	RM2-7186-000CN	1
8	DC controller PCA assembly (M577)	RM2-7187-000CN	1
9	Memory PCA assembly	RM2-7138-000CN	1
10	Fuser power supply PCA assembly	RM2-7125-000CN	1
11	Cable, flexible flat	RK2-6111-000CN	1
12	Environmental sensor PCA assembly	RM2-7154-000CN	1
13	Formatter (M552)	B5L23-67903	1
13	Formatter (M552 India and China only)	B5L23-67904	1
13	Formatter (M553n, M553dn, M553dh)	B5L24-67909	1
13	Formatter (M553n, M553dn, M553dh India and China only)	B5L24-67908	1
13	Formatter (M553x)	B5L26-67901	1
13	Formatter (M553x India and China only)	B5L26-67902	1
13	Formatter (M577)	B5L46-67909	1
13	Formatter (M577 India and China only)	B5L46-67911	1
14	Formatter case	RC4-0152-000CN	1
Not shown	Fax PCA (M577f, M577z)	B5L53-67901	1

Internal components (5 of 5)

Figure 2-8 Internal components (5 of 5)

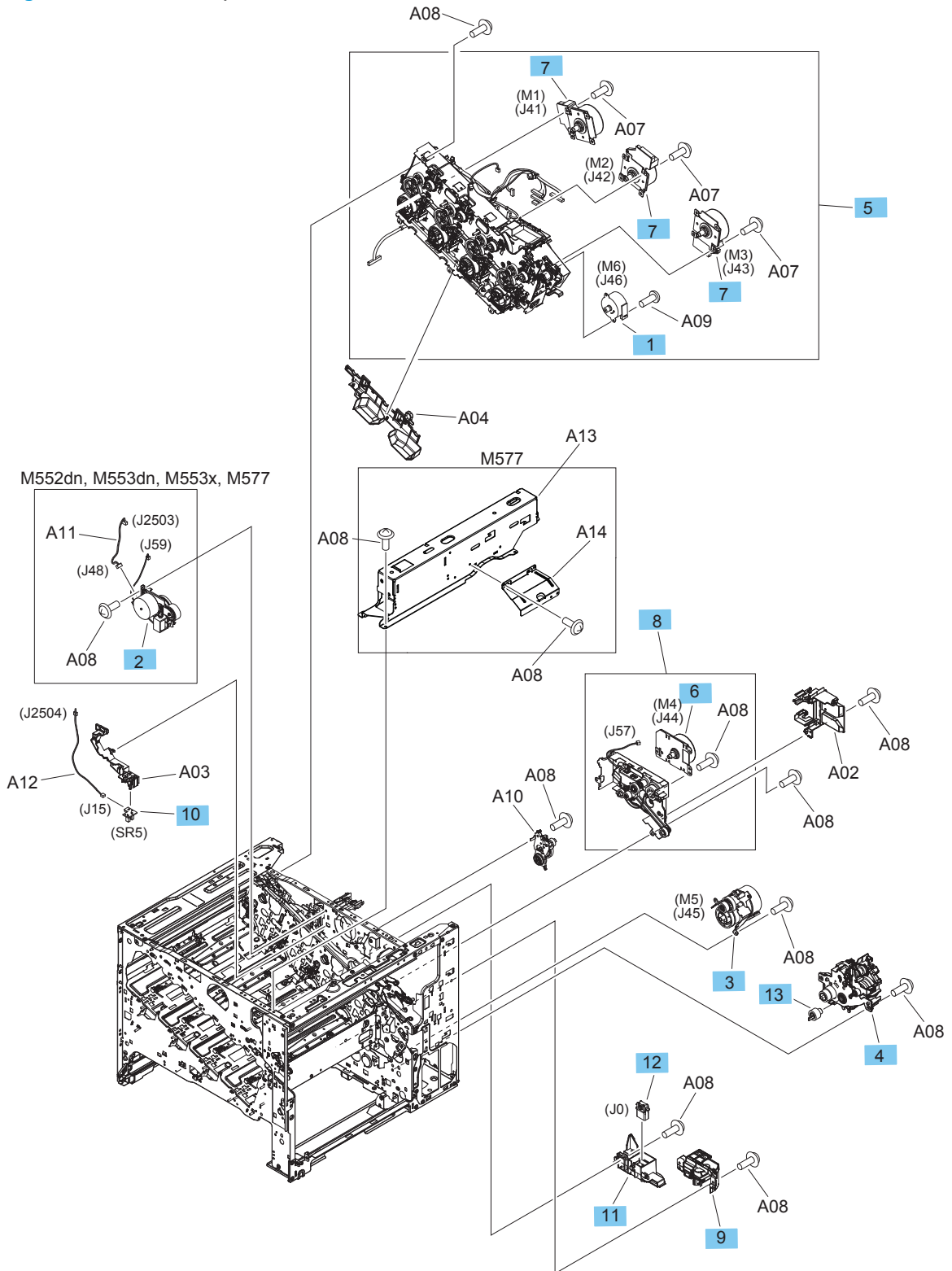

Table 2-11 Internal components (5 of 5)

Ref	Description	Part number	Qty
1	Motor, stepping (M6)	RK2-6027-000CN	1
2	Duplexing drive assembly (M7, CL2; M552dn, M553dn, M553x)	RM2-0006-000CN	1
3	Paper pickup drive assembly (M5)	RM2-0008-000CN	1
4	Lifter drive assembly (CL1)	RM2-0010-000CN	1
5	Main motor drive assembly	B5L25-67902	1
6	Motor assembly, fuser (M4)	RM2-0077-000CN	1
7	Motor assembly, drum (M1, M2, M3)	RM2-0078-000CN	3
8	Fuser drive assembly (M553n)	RM2-0091-000CN	1
8	Fuser drive assembly (M552dn, M553dn, M553x, M577)	RM2-0009-000CN	1
9	Auto close assembly	RM2-5147-000CN	1
10	Estrangement detect PCA assembly (SR5)	RM2-7157-000CN	1
11	Holder, OP Drawer	RC4-0445-000CN	1
12	Connector, drawer	VS1-7258-000CN	1
13	Gear 18T	RU8-0577-000CN	1

Parts and diagrams: 550-sheet paper feeder

550-sheet paper feeder covers

Figure 2-9 550-sheet paper feeder covers

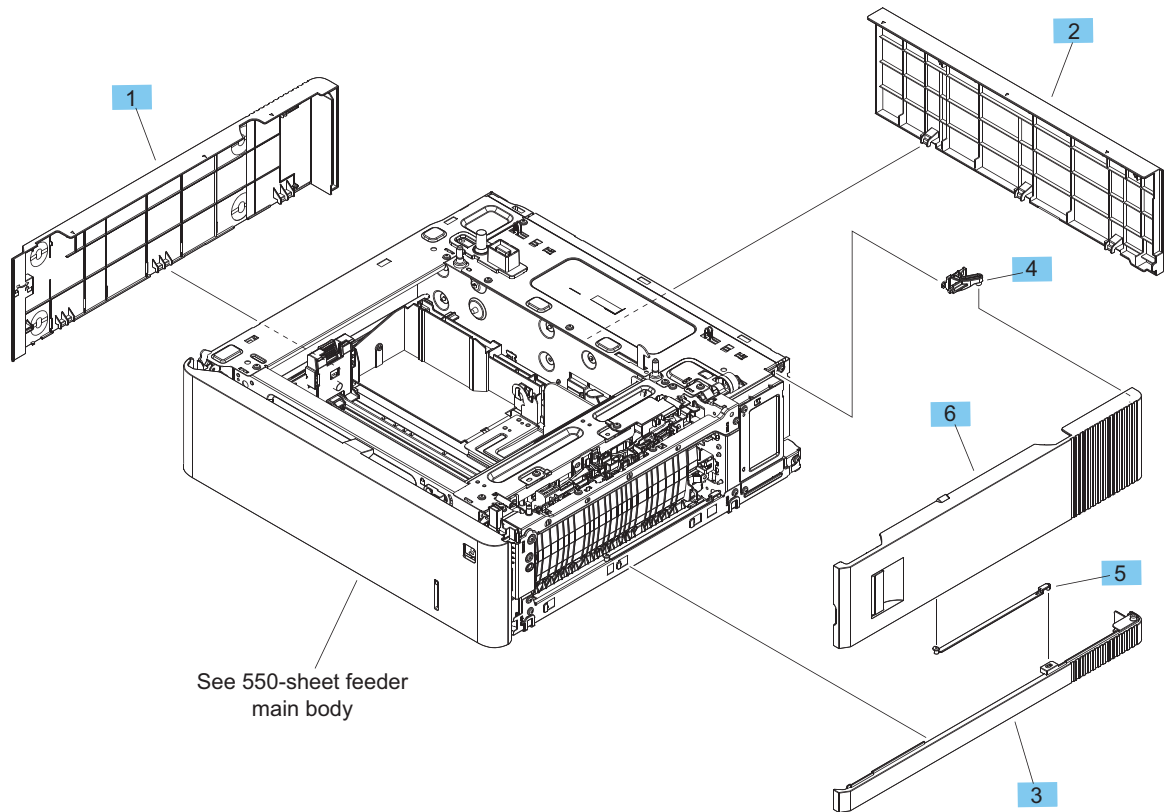

Table 2-12 550-sheet paper feeder covers

Ref	Description	Part number	Qty
1	Cover, left (550-sheet feeder)	RC4-1791-000CN	1
2	Cover, rear (550-sheet feeder)	RC4-1792-000CN	1
3	Cover, right lower (550-sheet feeder)	RC4-1793-000CN	1
4	Hinge, door, right (550-sheet feeder)	RC4-1781-000CN	1
5	Link, door, right (550-sheet feeder)	RC4-1778-000CN	1
6	Door assembly, right (550-sheet feeder)	RM2-5146-000CN	1

550-sheet paper feeder main body

Figure 2-10 550-sheet paper feeder main body

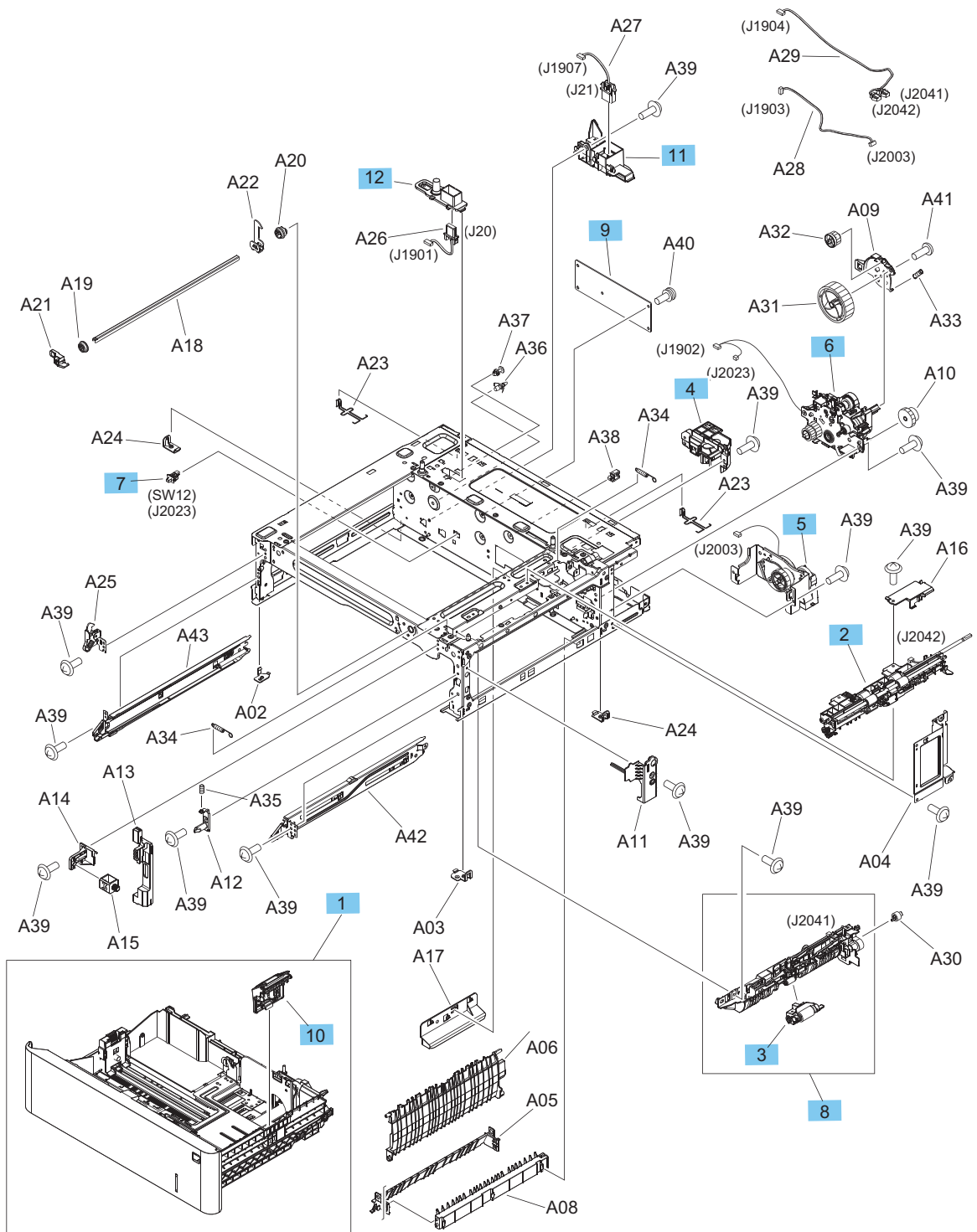

Table 2-13 550-sheet paper feeder covers

Ref	Description	Part number	Qty
1	Cassette (tray; 550-sheet feeder)	RM2-5150-000CN	1
2	Paper feed assembly (550-sheet feeder)	RM2-5145-000CN	1
3	Roller, pickup (550-sheet feeder; part of Tray 2-5 roller kit)	B5L24-67904	1
4	Auto close assembly (550-sheet feeder)	RM2-5147-000CN	1
5	Feed drive assembly (550-sheet feeder)	RM2-5148-000CN	1
6	Lifter drive assembly (550-sheet feeder)	RM2-5149-000CN	1
7	Switch button (SW21; 550-sheet feeder)	WC2-5806-000CN	1
8	Paper pickup assembly (550-sheet feeder)	RM2-5154-000CN	1
9	Paper feed drive PCA assembly (550-sheet feeder)	RM2-7139-000CN	1
10	Roller, separation (550-sheet feeder; part of Tray 2-5 roller kit)	B5L24-67904	1
11	Holder, OP drawer (550-sheet feeder)	RC4-0445-000CN	1
12	Holder, drawer connector (550-sheet feeder)	RC4-1741-000CN	1

Alphabetical parts list

Table 2-14 Alphabetical parts list

Description	Part number	Table and page
Arm, solenoid	RC4-0830-000CN	Internal components (3 of 5) on page 3019
Auto close assembly	RM2-5147-000CN	Internal components (5 of 5) on page 3023
Auto close assembly (550-sheet feeder)	RM2-5147-000CN	550-sheet paper feeder covers on page 3027
Bezel, control panel with NFC icon (M577)	B5L46-40026	Document feeder and scanner whole units (M577 only) on page 3009
Bezel, control panel without NFC icon (M577)	B5L46-40020	Document feeder and scanner whole units (M577 only) on page 3009
Cable, 18-pin control panel (M577)	5851-5935	Document feeder and scanner whole units (M577 only) on page 3009
Cable, flexible flat	RK2-6101-000CN	Internal components (4 of 5) on page 3021
Cable, flexible flat	RK2-6103-000CN	Internal components (4 of 5) on page 3021
Cable, flexible flat	RK2-6111-000CN	Internal components (4 of 5) on page 3021
Cable, HDMI control panel (M577)	5851-5936	Document feeder and scanner whole units (M577 only) on page 3009
Cable, HDMI PAB to SCAM (M577)	B5L46-60114	Document feeder and scanner whole units (M577 only) on page 3009
Cable, HIP USB control panel (M577)	5851-5938	Document feeder and scanner whole units (M577 only) on page 3009
Cable, stapler (M577)	B5L46-60121	Document feeder and scanner whole units (M577 only) on page 3009
Cable, WU USB control panel (M577)	5851-5939	Document feeder and scanner whole units (M577 only) on page 3009
Cassette (Tray 2)	RM2-0007-000CN	Internal components (3 of 5) on page 3019
Cassette (tray; 550-sheet feeder)	RM2-5150-000CN	550-sheet paper feeder covers on page 3027
Connecting PCA assembly	RM2-7156-000CN	Internal components (1 of 5) on page 3015
Connector, drawer	V51-7258-000CN	Internal components (5 of 5) on page 3023

Table 2-14 Alphabetical parts list (continued)

Description	Part number	Table and page
Control panel (M552dn, M553n, M553dn)	RM2-7180-000CN	Covers (M552, M553) on page 3011
Control panel (M553x)	B5L24-67903	Covers (M552, M553) on page 3011
Control panel (M577) kit	B5L47-67018	Document feeder and scanner whole units (M577 only) on page 3009
Cover assembly, stapler (M577c/f/z)	B5L46-60121	Document feeder and scanner whole units (M577 only) on page 3009
Cover, formatter	RM2-0084-000CN	Covers (M552, M553) on page 3011
Cover, formatter	RM2-0084-000CN	Covers (M577) on page 3013
Cover, front (M552, M553)	B5L25-67901	Covers (M552, M553) on page 3011
Cover, front (M577)	B5L46-67906	Covers (M577) on page 3013
Cover, HIP (M552dn, M553dn, M553x)	RC4-0213-000CN	Covers (M552, M553) on page 3011
Cover, HIP (M577)	B5L46-40021	Document feeder and scanner whole units (M577 only) on page 3009
Cover, keyboard (M577dn/f)	B5L46-40002	Document feeder and scanner whole units (M577 only) on page 3009
Cover, left	RC4-0179-000CN	Covers (M552, M553) on page 3011
Cover, left	RC4-0179-000CN	Covers (M577) on page 3013
Cover, left (550-sheet feeder)	RC4-1791-000CN	550-sheet paper feeder covers on page 3025
Cover, left upper (M577)	RL2-0770-000CN	Covers (M577) on page 3013
Cover, paper feed (M577)	RC4-3382-000CN	Covers (M577) on page 3013
Cover, rear	RM2-0085-000CN	Covers (M552, M553) on page 3011
Cover, rear	RM2-0085-000CN	Covers (M577) on page 3013
Cover, rear (550-sheet feeder)	RC4-1792-000CN	550-sheet paper feeder covers on page 3025
Cover, rear (image scanner; M577)	B5L46-40011	Document feeder and scanner whole units (M577 only) on page 3009
Cover, rear upper (M577)	RL2-0771-000CN	Covers (M577) on page 3013
Cover, right front upper (M577dn)	B5L46-40024	Document feeder and scanner whole units (M577 only) on page 3009

Table 2-14 Alphabetical parts list (continued)

Description	Part number	Table and page
Cover, right lower (550-sheet feeder)	RC4-1793-000CN	550-sheet paper feeder covers on page 3025
Cover, right rear	RC4-0178-000CN	Covers (M552, M553) on page 3011
Cover, right rear	RC4-0178-000CN	Covers (M577) on page 3013
Cover, right upper (M577)	RL2-0772-000CN	Covers (M577) on page 3013
Cover, top (M577)	RL2-0769-000CN	Covers (M577) on page 3013
Cover, top rear (M577)	RC4-3383-000CN	Covers (M577) on page 3013
Cover, upper (M552dn, M553dn)	RL2-0098-000CN	Covers (M552, M553) on page 3011
Cover, upper (M553n)	RL2-0096-000CN	Covers (M552, M553) on page 3011
Cover, upper (M553x)	RL2-0097-000CN	Covers (M552, M553) on page 3011
Cover, USB	RC4-0214-000CN	Covers (M552, M553) on page 3011
Cover, USB (M577)	B5L46-40028	Document feeder and scanner whole units (M577 only) on page 3009
DC controller PCA assembly (M552, M553)	RM2-7186-000CN	Internal components (4 of 5) on page 3021
DC controller PCA assembly (M577)	RM2-7187-000CN	Internal components (4 of 5) on page 3021
Density detect assembly	RM2-7160-000CN	Internal components (3 of 5) on page 3019
Document feeder (M577c/z) kit; includes white backing and retention clips	B5L47-67902	Document feeder and scanner whole units (M577 only) on page 3009
Document feeder (M577dn/f) kit; includes white backing and retention clips	B5L47-67901	Document feeder and scanner whole units (M577 only) on page 3009
Door assembly, right	RM2-0019-000CN	Covers (M552, M553) on page 3011
Door assembly, right (550-sheet feeder)	RM2-5146-000CN	550-sheet paper feeder covers on page 3025
Duplexing drive assembly (M7, CL2; M552dn, M553dn, M553x)	RM2-0006-000CN	Internal components (5 of 5) on page 3023
Environmental sensor PCA assembly	RM2-7154-000CN	Internal components (4 of 5) on page 3021
Estrangement detect PCA assembly (SR5)	RM2-7157-000CN	Internal components (5 of 5) on page 3023
Fan, cartridge (FM2)	RK2-6124-000CN	Internal components (1 of 5) on page 3015

Table 2-14 Alphabetical parts list (continued)

Description	Part number	Table and page
Fan, delivery (FM3)	RK2-2728-000CN	Internal components (4 of 5) on page 3021
Fan, fuser (FM4)	RK2-2418-000CN	Internal components (1 of 5) on page 3015
Fan, power-supply (FM1)	RK2-2416-000CN	Internal components (4 of 5) on page 3021
Fax PCA (M577f, M577z)	B5L53-67901	Internal components (4 of 5) on page 3021
Feed drive assembly (550-sheet feeder)	RM2-5148-000CN	550-sheet paper feeder covers on page 3027
Formatter (M552 India and China only)	B5L23-67904	Internal components (4 of 5) on page 3021
Formatter (M552)	B5L23-67903	Internal components (4 of 5) on page 3021
Formatter (M553n, M553dn, M553dh India and China only)	B5L24-67908	Internal components (4 of 5) on page 3021
Formatter (M553n, M553dn, M553dh)	B5L24-67909	Internal components (4 of 5) on page 3021
Formatter (M553x India and China only)	B5L26-67902	Internal components (4 of 5) on page 3021
Formatter (M553x)	B5L26-67901	Internal components (4 of 5) on page 3021
Formatter (M577 India and China only)	B5L46-67911	Internal components (4 of 5) on page 3021
Formatter (M577)	B5L46-67909	Internal components (4 of 5) on page 3021
Formatter case	RC4-0152-000CN	Internal components (4 of 5) on page 3021
Fuser drive assembly (M552dn, M553dn, M553x, M577)	RM2-0009-000CN	Internal components (5 of 5) on page 3023
Fuser drive assembly (M553n)	RM2-0091-000CN	Internal components (5 of 5) on page 3023
Fuser kit (110V)	B5L35-67902	Internal components (3 of 5) on page 3019
Fuser kit (220V)	B5L36-67902	Internal components (3 of 5) on page 3019
Fuser power supply PCA assembly	RM2-7125-000CN	Internal components (4 of 5) on page 3021
Fuser service kit (110V)	B5L35-67902	Internal components (3 of 5) on page 3019
Fuser service kit (220V)	B5L36-67902	Internal components (3 of 5) on page 3019

Table 2-14 Alphabetical parts list (continued)

Description	Part number	Table and page
Gear 18T	RU8-0577-000CN	Internal components (5 of 5) on page 3023
Glass cleaner assembly, dust-proof	RM2-0086-000CN	Internal components (1 of 5) on page 3015
Handle, right	RC4-0183-000CN	Covers (M552, M553) on page 3011
Handle, right	RC4-0183-000CN	Covers (M577) on page 3013
Hinge, cover, front	RC4-0132-000CN	Internal components (2 of 5) on page 3017
Hinge, cover, front	RC4-0159-000CN	Internal components (2 of 5) on page 3017
Hinge, door, right (550-sheet feeder)	RC4-1781-000CN	550-sheet paper feeder covers on page 3025
Hinge, left document feeder (M577)	COM39-60064	Document feeder and scanner whole units (M577 only) on page 3009
Hinge, right document feeder (M577)	COM39-60065	Document feeder and scanner whole units (M577 only) on page 3009
Holder, drawer connector (550-sheet feeder)	RC4-1741-000CN	550-sheet paper feeder covers on page 3027
Holder, OP Drawer	RC4-0445-000CN	Internal components (5 of 5) on page 3023
Holder, OP drawer (550-sheet feeder)	RC4-0445-000CN	550-sheet paper feeder covers on page 3027
HVPS (D) PCA assembly	RM2-7122-000CN	Internal components (4 of 5) on page 3021
HVPS (T) PCA assembly (M552dn, M553dn, M553x, M577)	RM2-7123-000CN	Internal components (4 of 5) on page 3021
HVPS (T) PCA assembly (M553n)	RM2-7134-000CN	Internal components (4 of 5) on page 3021
Image scanner (M577) kit; includes white backing and retention clips	B5L46-67904	Document feeder and scanner whole units (M577 only) on page 3009
Inner door	RL2-0013-010CN	Internal components (1 of 5) on page 3015
ITB (part of ITB and secondary transfer roller kit)	B5L24-67901	Internal components (3 of 5) on page 3019
Keyboard overlay kit (ES, PT)	5851-6023	Document feeder and scanner whole units (M577 only) on page 3009
Keyboard overlay kit (FR, IT, RU, DE, ES: UK Kybd)	5851-6019	Document feeder and scanner whole units (M577 only) on page 3009

Table 2-14 Alphabetical parts list (continued)

Description	Part number	Table and page
Keyboard overlay kit (FR-CN, ES-LA, ES: US Kybd)	5851-6020	Document feeder and scanner whole units (M577 only) on page 3009
Keyboard overlay kit (FR-SW, DE-SW, DA: UK Kybd)	5851-6021	Document feeder and scanner whole units (M577 only) on page 3009
Keyboard overlay kit (JA-KG, JA-KT)	5851-6024	Document feeder and scanner whole units (M577 only) on page 3009
Keyboard overlay kit (ZHTW, ZHCN)	5851-6022	Document feeder and scanner whole units (M577 only) on page 3009
Keyboard UK (M577c/z)	B5L47-67020	Document feeder and scanner whole units (M577 only) on page 3009
Keyboard US (M577c/z)	B5L47-67019	Document feeder and scanner whole units (M577 only) on page 3009
Laser/scanner assembly	RM2-6545-000CN	Internal components (2 of 5) on page 3017
Lifter drive assembly (550-sheet feeder)	RM2-5149-000CN	550-sheet paper feeder covers on page 3027
Lifter drive assembly (CL1)	RM2-0010-000CN	Internal components (5 of 5) on page 3023
Link, door, right (550-sheet feeder)	RC4-1778-000CN	550-sheet paper feeder covers on page 3025
LVPS PCA assembly	RM2-7164-000CN	Internal components (4 of 5) on page 3021
Main motor drive assembly	B5L25-67902	Internal components (5 of 5) on page 3023
Memory PCA assembly	RM2-7138-000CN	Internal components (4 of 5) on page 3021
Motor assembly, drum (M1, M2, M3)	RM2-0078-000CN	Internal components (5 of 5) on page 3023
Motor assembly, fuser (M4)	RM2-0077-000CN	Internal components (5 of 5) on page 3023
Motor, stepping (M6)	RK2-6027-000CN	Internal components (5 of 5) on page 3023
Near field communication (NFC) PCA, embedded (M553x)	B5L24-60002	Internal components (1 of 5) on page 3015
Near field communication (NFC) PCA, embedded (M577z)	B5L24-60001	Internal components (1 of 5) on page 3015
Output bin	RM2-0044-000CN	Covers (M552, M553) on page 3011
Output bin	RM2-0044-000CN	Covers (M577) on page 3013

Table 2-14 Alphabetical parts list (continued)

Description	Part number	Table and page
Paper delivery assembly (M552dn, M553dn, M553x, M577)	RM2-0016-000CN	Internal components (3 of 5) on page 3019
Paper delivery assembly (M553n)	RM2-0092-000CN	Internal components (3 of 5) on page 3019
Paper feed assembly (550-sheet feeder)	RM2-5145-000CN	550-sheet paper feeder covers on page 3027
Paper feed drive PCA assembly (550-sheet feeder)	RM2-7139-000CN	550-sheet paper feeder covers on page 3027
Paper pickup assembly	RM2-0017-000CN	Internal components (3 of 5) on page 3019
Paper pickup assembly (550-sheet feeder)	RM2-5154-000CN	550-sheet paper feeder covers on page 3027
Paper pickup drive assembly (M5)	RM2-0008-000CN	Internal components (5 of 5) on page 3023
Pre-exposure PCA assembly	RM2-7168-000CN	Internal components (2 of 5) on page 3017
Pre-exposure PCA assembly	RM2-7169-000CN	Internal components (2 of 5) on page 3017
Registration assembly (M552dn, M553dn, M553x, M577)	RM2-0018-000CN	Internal components (3 of 5) on page 3019
Registration assembly (M553n)	RM2-0093-000CN	Internal components (3 of 5) on page 3019
Right door assembly	RM2-0019-000CN	Covers (M577) on page 3013
Roller, paper pickup (part of Tray 2-5 roller kit)	B5L24-67904	Internal components (3 of 5) on page 3019
Roller, pickup (550-sheet feeder; part of Tray 2-5 roller kit)	B5L24-67904	550-sheet paper feeder covers on page 3027
Roller, pickup, Tray 1 (part of Tray 1 roller kit)	B5L24-67905	Covers (M552, M553) on page 3011
Roller, pickup, Tray 1 (part of Tray 1 roller kit)	B5L24-67905	Covers (M577) on page 3013
Roller, secondary transfer	B5L24-67902	Internal components (3 of 5) on page 3019
Roller, separation (550-sheet feeder; part of Tray 2-5 roller kit)	B5L24-67904	550-sheet paper feeder covers on page 3027
Roller, separation (part of Tray 2-5 roller kit)	B5L24-67904	Internal components (3 of 5) on page 3019
Roller, separation, Tray 1 (part of Tray 1 roller kit)	B5L24-67905	Covers (M552, M553) on page 3011
Roller, separation, Tray 1 (part of Tray 1 roller kit)	B5L24-67905	Covers (M577) on page 3013
Scan control board	B5L47-67903	Document feeder and scanner whole units (M577 only) on page 3009

Table 2-14 Alphabetical parts list (continued)

Description	Part number	Table and page
Secondary transfer assembly (M552dn, M553dn, M553x, M577)	RM2-0022-000CN	Internal components (3 of 5) on page 3019
Secondary transfer assembly (M553n)	RM2-0090-000CN	Internal components (3 of 5) on page 3019
Stapler (M577c/f/z)	B5L46-60102	Document feeder and scanner whole units (M577 only) on page 3009
Switch button (SW21; 550-sheet feeder)	WC2-5806-000CN	550-sheet paper feeder covers on page 3027
Switch PCA assembly (SW4)	RM2-7133-000CN	Internal components (2 of 5) on page 3017
Toner collection unit	B5L37-67901	Covers (M552, M553) on page 3011
Toner collection unit	B5L37-67901	Covers (M577) on page 3013
Waste toner detect PCA assembly	RM2-7130-000CN	Internal components (1 of 5) on page 3015
Wireless PCA, embedded	1150-7968	Internal components (1 of 5) on page 3015

Numerical parts list

Table 2-15 Numerical parts list

Part number	Description	Table and page
1150-7968	Wireless PCA, embedded	Internal components (1 of 5) on page 3015
5851-5935	Cable, 18-pin control panel (M577)	Document feeder and scanner whole units (M577 only) on page 3009
5851-5936	Cable, HDMI control panel (M577)	Document feeder and scanner whole units (M577 only) on page 3009
5851-5938	Cable, HIP USB control panel (M577)	Document feeder and scanner whole units (M577 only) on page 3009
5851-5939	Cable, WU USB control panel (M577)	Document feeder and scanner whole units (M577 only) on page 3009
5851-6019	Keyboard overlay kit (FR, IT, RU, DE, ES: UK Kybd)	Document feeder and scanner whole units (M577 only) on page 3009
5851-6020	Keyboard overlay kit (FR-CN, ES-LA, ES: US Kybd)	Document feeder and scanner whole units (M577 only) on page 3009
5851-6021	Keyboard overlay kit (FR-SW, DE-SW, DA: UK Kybd)	Document feeder and scanner whole units (M577 only) on page 3009
5851-6022	Keyboard overlay kit (ZHTW, ZHCN)	Document feeder and scanner whole units (M577 only) on page 3009
5851-6023	Keyboard overlay kit (ES, PT)	Document feeder and scanner whole units (M577 only) on page 3009
5851-6024	Keyboard overlay kit (JA-KG, JA-KT)	Document feeder and scanner whole units (M577 only) on page 3009
B5L23-67903	Formatter (M552)	Internal components (4 of 5) on page 3021
B5L23-67904	Formatter (M552 India and China only)	Internal components (4 of 5) on page 3021
B5L24-60001	Near field communication (NFC) PCA, embedded (M577z)	Internal components (1 of 5) on page 3015
B5L24-60002	Near field communication (NFC) PCA, embedded (M553x)	Internal components (1 of 5) on page 3015
B5L24-67901	ITB (part of ITB and secondary transfer roller kit)	Internal components (3 of 5) on page 3019
B5L24-67902	Roller, secondary transfer	Internal components (3 of 5) on page 3019

Table 2-15 Numerical parts list (continued)

Part number	Description	Table and page
B5L24-67903	Control panel (M553x)	Covers (M552, M553) on page 3011
B5L24-67904	Roller, paper pickup (part of Tray 2-5 roller kit)	Internal components (3 of 5) on page 3019
B5L24-67904	Roller, separation (part of Tray 2-5 roller kit)	Internal components (3 of 5) on page 3019
B5L24-67904	Roller, pickup (550-sheet feeder; part of Tray 2-5 roller kit)	550-sheet paper feeder covers on page 3027
B5L24-67904	Roller, separation (550-sheet feeder; part of Tray 2-5 roller kit)	550-sheet paper feeder covers on page 3027
B5L24-67905	Roller, pickup, Tray 1 (part of Tray 1 roller kit)	Covers (M552, M553) on page 3011
B5L24-67905	Roller, separation, Tray 1 (part of Tray 1 roller kit)	Covers (M552, M553) on page 3011
B5L24-67905	Roller, pickup, Tray 1 (part of Tray 1 roller kit)	Covers (M577) on page 3013
B5L24-67905	Roller, separation, Tray 1 (part of Tray 1 roller kit)	Covers (M577) on page 3013
B5L24-67908	Formatter (M553n, M553dn, M553dh India and China only)	Internal components (4 of 5) on page 3021
B5L24-67909	Formatter (M553n, M553dn, M553dh)	Internal components (4 of 5) on page 3021
B5L25-67901	Cover, front (M552, M553)	Covers (M552, M553) on page 3011
B5L25-67902	Main motor drive assembly	Internal components (5 of 5) on page 3023
B5L26-67901	Formatter (M553x)	Internal components (4 of 5) on page 3021
B5L26-67902	Formatter (M553x India and China only)	Internal components (4 of 5) on page 3021
B5L35-67902	Fuser kit (110V)	Internal components (3 of 5) on page 3019
B5L35-67902	Fuser service kit (110V)	Internal components (3 of 5) on page 3019
B5L36-67902	Fuser kit (220V)	Internal components (3 of 5) on page 3019
B5L36-67902	Fuser service kit (220V)	Internal components (3 of 5) on page 3019
B5L37-67901	Toner collection unit	Covers (M552, M553) on page 3011
B5L37-67901	Toner collection unit	Covers (M577) on page 3013
B5L46-40002	Cover, keyboard (M577dn/f)	Document feeder and scanner whole units (M577 only) on page 3009

Table 2-15 Numerical parts list (continued)

Part number	Description	Table and page
B5L46-40011	Cover, rear (image scanner; M577)	Document feeder and scanner whole units (M577 only) on page 3009
B5L46-40020	Bezel, control panel without NFC icon (M577)	Document feeder and scanner whole units (M577 only) on page 3009
B5L46-40021	Cover, HIP (M577)	Document feeder and scanner whole units (M577 only) on page 3009
B5L46-40024	Cover, right front upper (M577dn)	Document feeder and scanner whole units (M577 only) on page 3009
B5L46-40026	Bezel, control panel with NFC icon (M577)	Document feeder and scanner whole units (M577 only) on page 3009
B5L46-40028	Cover, USB (M577)	Document feeder and scanner whole units (M577 only) on page 3009
B5L46-60102	Stapler (M577c/f/z)	Document feeder and scanner whole units (M577 only) on page 3009
B5L46-60114	Cable, HDMI PAB to SCAM (M577)	Document feeder and scanner whole units (M577 only) on page 3009
B5L46-60121	Cover assembly, stapler (M577c/f/z)	Document feeder and scanner whole units (M577 only) on page 3009
B5L46-60121	Cable, stapler (M577)	Document feeder and scanner whole units (M577 only) on page 3009
B5L46-67904	Image scanner (M577) kit; includes white backing and retention clips	Document feeder and scanner whole units (M577 only) on page 3009
B5L46-67906	Cover, front (M577)	Covers (M577) on page 3013
B5L46-67909	Formatter (M577)	Internal components (4 of 5) on page 3021
B5L46-67911	Formatter (M577 India and China only)	Internal components (4 of 5) on page 3021
B5L47-67018	Control panel (M577) kit	Document feeder and scanner whole units (M577 only) on page 3009
B5L47-67019	Keyboard US (M577c/z)	Document feeder and scanner whole units (M577 only) on page 3009
B5L47-67020	Keyboard UK (M577c/z)	Document feeder and scanner whole units (M577 only) on page 3009

Table 2-15 Numerical parts list (continued)

Part number	Description	Table and page
B5L47-67901	Document feeder (M577dn/f) kit; includes white backing and retention clips	Document feeder and scanner whole units (M577 only) on page 3009
B5L47-67902	Document feeder (M577c/z) kit; includes white backing and retention clips	Document feeder and scanner whole units (M577 only) on page 3009
B5L47-67903	Scan control board	Document feeder and scanner whole units (M577 only) on page 3009
B5L53-67901	Fax PCA (M577f, M577z)	Internal components (4 of 5) on page 3021
COM39-60064	Hinge, left document feeder (M577)	Document feeder and scanner whole units (M577 only) on page 3009
COM39-60065	Hinge, right document feeder (M577)	Document feeder and scanner whole units (M577 only) on page 3009
RC4-0132-000CN	Hinge, cover, front	Internal components (2 of 5) on page 3017
RC4-0152-000CN	Formatter case	Internal components (4 of 5) on page 3021
RC4-0159-000CN	Hinge, cover, front	Internal components (2 of 5) on page 3017
RC4-0178-000CN	Cover, right rear	Covers (M552, M553) on page 3011
RC4-0178-000CN	Cover, right rear	Covers (M577) on page 3013
RC4-0179-000CN	Cover, left	Covers (M552, M553) on page 3011
RC4-0179-000CN	Cover, left	Covers (M577) on page 3013
RC4-0183-000CN	Handle, right	Covers (M552, M553) on page 3011
RC4-0183-000CN	Handle, right	Covers (M577) on page 3013
RC4-0213-000CN	Cover, HIP (M552dn, M553dn, M553x)	Covers (M552, M553) on page 3011
RC4-0214-000CN	Cover, USB	Covers (M552, M553) on page 3011
RC4-0445-000CN	Holder, OP Drawer	Internal components (5 of 5) on page 3023
RC4-0445-000CN	Holder, OP drawer (550-sheet feeder)	550-sheet paper feeder covers on page 3027
RC4-0830-000CN	Arm, solenoid	Internal components (3 of 5) on page 3019
RC4-1741-000CN	Holder, drawer connector (550-sheet feeder)	550-sheet paper feeder covers on page 3027

Table 2-15 Numerical parts list (continued)

Part number	Description	Table and page
RC4-1778-000CN	Link, door, right (550-sheet feeder)	550-sheet paper feeder covers on page 3025
RC4-1781-000CN	Hinge, door, right (550-sheet feeder)	550-sheet paper feeder covers on page 3025
RC4-1791-000CN	Cover, left (550-sheet feeder)	550-sheet paper feeder covers on page 3025
RC4-1792-000CN	Cover, rear (550-sheet feeder)	550-sheet paper feeder covers on page 3025
RC4-1793-000CN	Cover, right lower (550-sheet feeder)	550-sheet paper feeder covers on page 3025
RC4-3382-000CN	Cover, paper feed (M577)	Covers (M577) on page 3013
RC4-3383-000CN	Cover, top rear (M577)	Covers (M577) on page 3013
RK2-2416-000CN	Fan, power-supply (FM1)	Internal components (4 of 5) on page 3021
RK2-2418-000CN	Fan, fuser (FM4)	Internal components (1 of 5) on page 3015
RK2-2728-000CN	Fan, delivery (FM3)	Internal components (4 of 5) on page 3021
RK2-6027-000CN	Motor, stepping (M6)	Internal components (5 of 5) on page 3023
RK2-6101-000CN	Cable, flexible flat	Internal components (4 of 5) on page 3021
RK2-6103-000CN	Cable, flexible flat	Internal components (4 of 5) on page 3021
RK2-6111-000CN	Cable, flexible flat	Internal components (4 of 5) on page 3021
RK2-6124-000CN	Fan, cartridge (FM2)	Internal components (1 of 5) on page 3015
RL2-0013-010CN	Inner door	Internal components (1 of 5) on page 3015
RL2-0096-000CN	Cover, upper (M553n)	Covers (M552, M553) on page 3011
RL2-0097-000CN	Cover, upper (M553x)	Covers (M552, M553) on page 3011
RL2-0098-000CN	Cover, upper (M552dn, M553dn)	Covers (M552, M553) on page 3011
RL2-0769-000CN	Cover, top (M577)	Covers (M577) on page 3013
RL2-0770-000CN	Cover, left upper (M577)	Covers (M577) on page 3013
RL2-0771-000CN	Cover, rear upper (M577)	Covers (M577) on page 3013
RL2-0772-000CN	Cover, right upper (M577)	Covers (M577) on page 3013
RM2-0006-000CN	Duplexing drive assembly (M7, CL2; M552dn, M553dn, M553x)	Internal components (5 of 5) on page 3023

Table 2-15 Numerical parts list (continued)

Part number	Description	Table and page
RM2-0007-000CN	Cassette (Tray 2)	Internal components (3 of 5) on page 3019
RM2-0008-000CN	Paper pickup drive assembly (M5)	Internal components (5 of 5) on page 3023
RM2-0009-000CN	Fuser drive assembly (M552dn, M553dn, M553x, M577)	Internal components (5 of 5) on page 3023
RM2-0010-000CN	Lifter drive assembly (CL1)	Internal components (5 of 5) on page 3023
RM2-0016-000CN	Paper delivery assembly (M552dn, M553dn, M553x, M577)	Internal components (3 of 5) on page 3019
RM2-0017-000CN	Paper pickup assembly	Internal components (3 of 5) on page 3019
RM2-0018-000CN	Registration assembly (M552dn, M553dn, M553x, M577)	Internal components (3 of 5) on page 3019
RM2-0019-000CN	Door assembly, right	Covers (M552, M553) on page 3011
RM2-0019-000CN	Right door assembly	Covers (M577) on page 3013
RM2-0022-000CN	Secondary transfer assembly (M552dn, M553dn, M553x, M577)	Internal components (3 of 5) on page 3019
RM2-0044-000CN	Output bin	Covers (M552, M553) on page 3011
RM2-0044-000CN	Output bin	Covers (M577) on page 3013
RM2-0077-000CN	Motor assembly, fuser (M4)	Internal components (5 of 5) on page 3023
RM2-0078-000CN	Motor assembly, drum (M1, M2, M3)	Internal components (5 of 5) on page 3023
RM2-0084-000CN	Cover, formatter	Covers (M552, M553) on page 3011
RM2-0084-000CN	Cover, formatter	Covers (M577) on page 3013
RM2-0085-000CN	Cover, rear	Covers (M552, M553) on page 3011
RM2-0085-000CN	Cover, rear	Covers (M577) on page 3013
RM2-0086-000CN	Glass cleaner assembly, dust-proof	Internal components (1 of 5) on page 3015
RM2-0090-000CN	Secondary transfer assembly (M553n)	Internal components (3 of 5) on page 3019
RM2-0091-000CN	Fuser drive assembly (M553n)	Internal components (5 of 5) on page 3023
RM2-0092-000CN	Paper delivery assembly (M553n)	Internal components (3 of 5) on page 3019
RM2-0093-000CN	Registration assembly (M553n)	Internal components (3 of 5) on page 3019

Table 2-15 Numerical parts list (continued)

Part number	Description	Table and page
RM2-5145-000CN	Paper feed assembly (550-sheet feeder)	550-sheet paper feeder covers on page 3027
RM2-5146-000CN	Door assembly, right (550-sheet feeder)	550-sheet paper feeder covers on page 3025
RM2-5147-000CN	Auto close assembly	Internal components (5 of 5) on page 3023
RM2-5147-000CN	Auto close assembly (550-sheet feeder)	550-sheet paper feeder covers on page 3027
RM2-5148-000CN	Feed drive assembly (550-sheet feeder)	550-sheet paper feeder covers on page 3027
RM2-5149-000CN	Lifter drive assembly (550-sheet feeder)	550-sheet paper feeder covers on page 3027
RM2-5150-000CN	Cassette (tray; 550-sheet feeder)	550-sheet paper feeder covers on page 3027
RM2-5154-000CN	Paper pickup assembly (550-sheet feeder)	550-sheet paper feeder covers on page 3027
RM2-6545-000CN	Laser/scanner assembly	Internal components (2 of 5) on page 3017
RM2-7122-000CN	HVPS (D) PCA assembly	Internal components (4 of 5) on page 3021
RM2-7123-000CN	HVPS (T) PCA assembly (M552dn, M553dn, M553x, M577)	Internal components (4 of 5) on page 3021
RM2-7125-000CN	Fuser power supply PCA assembly	Internal components (4 of 5) on page 3021
RM2-7130-000CN	Waste toner detect PCA assembly	Internal components (1 of 5) on page 3015
RM2-7133-000CN	Switch PCA assembly (SW4)	Internal components (2 of 5) on page 3017
RM2-7134-000CN	HVPS (T) PCA assembly (M553n)	Internal components (4 of 5) on page 3021
RM2-7138-000CN	Memory PCA assembly	Internal components (4 of 5) on page 3021
RM2-7139-000CN	Paper feed drive PCA assembly (550-sheet feeder)	550-sheet paper feeder covers on page 3027
RM2-7154-000CN	Environmental sensor PCA assembly	Internal components (4 of 5) on page 3021
RM2-7156-000CN	Connecting PCA assembly	Internal components (1 of 5) on page 3015
RM2-7157-000CN	Estrangement detect PCA assembly (SR5)	Internal components (5 of 5) on page 3023
RM2-7160-000CN	Density detect assembly	Internal components (3 of 5) on page 3019

Table 2-15 Numerical parts list (continued)

Part number	Description	Table and page
RM2-7164-000CN	LVPS PCA assembly	Internal components (4 of 5) on page 3021
RM2-7168-000CN	Pre-exposure PCA assembly	Internal components (2 of 5) on page 3017
RM2-7169-000CN	Pre-exposure PCA assembly	Internal components (2 of 5) on page 3017
RM2-7180-000CN	Control panel (M552dn, M553n, M553dn)	Covers (M552, M553) on page 3011
RM2-7186-000CN	DC controller PCA assembly (M552, M553))	Internal components (4 of 5) on page 3021
RM2-7187-000CN	DC controller PCA assembly (M577)	Internal components (4 of 5) on page 3021
RU8-0577-000CN	Gear 18T	Internal components (5 of 5) on page 3023
VS1-7258-000CN	Connector, drawer	Internal components (5 of 5) on page 3023
WC2-5806-000CN	Switch button (SW21; 550-sheet feeder)	550-sheet paper feeder covers on page 3027

Index

Symbols/Numerics

500-sheet feeder
parts lists and diagrams 3024

A

after-service checklist 6
auto close assembly
removing and replacing 1161
auto close assembly (1x550-sheet
paper feeder)
removing and replacing 2817
auto close assembly, removing and
replacing 1161

B

before-service checklist 6

C

cartridge
ordering 3001
part numbers 3001
cartridges
removing and replacing 9
cautions iii
connectors
OP drawer holder (1x550-sheet
paper feeder), removing 2811
Control panel (M553n/dn and M552dn
only)
removing and replacing 542
Control panel (M553n/dn and M552dn
only), removing and replacing 542
control panel (M577)
removing and replacing 92
control panel (M577), removing and
replacing 92
conventions, document iii

covers

left cover (1x550-sheet paper
feeder), removing 2807
parts lists and diagrams 3010
rear cover (1x550-sheet paper
feeder), removing 2758
right-door link (1x550-sheet
paper feeder), removing 2794
right-lower cover (1x550-sheet
paper feeder), removing 2781
covers (M506)
part numbers 3010
covers (M577)
part numbers 3012

D

DC controller
removing and replacing 698
DC controller, removing and
replacing 698
delivery fan (FM3), removing and
replacing 1322
delivery fan (FM3)
removing and replacing 1322
density-detect assembly
removing and replacing 2379
density-detect assembly, removing
and replacing 2379
developing disengagement motor
(M6)
removing and replacing 1111
developing disengagement motor
(M6), removing and replacing
1111
DIMM
removing and replacing 44, 53
document conventions iii

document feeder

removing and replacing rollers
(M577) 128
document feeder (M577)
removing and replacing 2656
document feeder (M577), removing
and replacing 2656
document feeder and scanner whole
units
parts lists and diagrams 3008
document feeder rollers (M577)
removing and replacing 128
document feeder rollers (M577),
removing and replacing 128
door link (1x550-sheet paper feeder)
removing and replacing 2794
doors
door link (1x550-sheet paper
feeder), removing 2794
right door (1x550-sheet paper
feeder), removing 2762
drawer connector holder (1x550-
sheet paper feeder)
removing and replacing 2836
drum motor 1 (M1)
removing and replacing 996
drum motor 1 (M1), removing and
replacing 996
drum motor 2 (M2)
removing and replacing 1495
drum motor 2 (M2), removing and
replacing 1495
drum motor 3 (M3)
removing and replacing 1584
drum motor 3 (M3), removing and
replacing 1584
dual in-line memory module (DIMM)
removing and replacing 53

duplex drive assembly, removing and replacing 1887

E

electrostatic discharge (ESD) 4
embedded MultiMedia Card (eMMC)
removing and replacing 61
environmental sensor PCA
removing and replacing 1762
environmental sensor PCA, removing
and replacing 1762
ESD electrostatic discharge (ESD) 4

F

fax PCA
removing and replacing 2987
feeder drive assembly (1x550-sheet
paper feeder)
removing and replacing 2900
field-replaceable units (FRUs)
replacing 3
formatter
removing and replacing 807,
822
formatter case assembly
removing and replacing 838
formatter case assembly, removing
and replacing 838
Formatter cover
removing and replacing 358
Formatter cover, removing and
replacing 358
formatter, removing and replacing
807, 822
front door
removing and replacing 348
FRUs (field-replaceable units)
replacing 3
fuser
removing and replacing 23
fuser drive assembly, removing and
replacing 1777
fuser motor (M4)
removing and replacing 1673
fuser motor (M4), removing and
replacing 1673
fuser power supply
removing and replacing 878
fuser power supply, removing and
replacing 878

H

hard disk drive (HDD)
removing and replacing 28, 34
high-voltage power supply D (HVPSD)
removing and replacing 947
high-voltage power supply D
(HVPSD), removing and replacing
947
High-voltage power supply T (HVPST)
removing and replacing 1407
High-voltage power supply T
(HVPST), removing and replacing
1407
hinge bracket
right door hinge bracket (1x550-
sheet paper feeder), removing
2771
HIP cover
removing and replacing 75, 79
HIP cover, removing and replacing
75, 79

I

image scanner (M577)
removing and replacing 2690
installation 4
screws 4
See also replacing parts
intermediate transfer belt (ITB)
removing 153
internal components, product
parts lists and diagrams 3014
internal USB ports (M552 and M553)
removing and replacing 2971
internal USB ports (M577)
removing and replacing 2980
ITB
removing 153

K

kit
instructions, embedded
MultiMedia Card (eMMC) 61
instructions, front door 348
instructions, fuser 23
instructions, hard disk drive
(HDD) 28, 34
instructions, memory DIMM 44
instructions, secondary transfer
roller and ITB 166

instructions, secondary transfer
roller assembly 580
instructions, toner cartridges 9
instructions, tray 1 pickup and
separation rollers 568
instructions, tray 2-X pickup and
separation rollers 138

L

laser scanner
warnings for servicing 3
laser/scanner assembly
removing and replacing 1263
laser/scanner assembly, removing
and replacing 1263
left cover
removing and replacing 376
left cover (1x550-sheet paper feeder)
removing and replacing 2807
left cover, removing and replacing
376
lifter drive assembly
removing and replacing 1211
lifter drive assembly (1x550-sheet
paper feeder)
removing and replacing 2925
lifter drive assembly, removing and
replacing 1211
low-voltage power supply (LVPS)
removing and replacing 902
low-voltage power supply (LVPS),
removing and replacing 902

M

main drive assembly)
removing and replacing 2506
main drive assembly, removing and
replacing 2506
memory DIMM
removing and replacing 44

N

near field communication PCA (NFC)
(M553x)
removing and replacing 586
near field communication PCA (NFC)
(M553x), removing and replacing
586
near field communication PCA (NFC)
(M577z)
removing and replacing 613

near field communication PCA (NFC) (M577z), removing and replacing 613

notes iii

O

OP drawer holder (1x550-sheet paper feeder)

removing and replacing 2811

ordering

toner cartridge 3001

output bin

removing and replacing 424

output bin, removing and replacing 424

P

paper feed assembly (1x550-sheet paper feeder)

removing and replacing 2849

paper feeder

auto close assembly (1x550-sheet paper feeder), removing 2817

auto close assembly, removing 2817

door link, removing 2794

drawer connector holder (1x550-sheet paper feeder), removing 2836

drawer connector holder, removing 2836

feeder drive assembly (1x550-sheet paper feeder), removing 2900

feeder drive assembly, removing 2900

lifter drive assembly (1x550-sheet paper feeder), removing 2925

lifter drive assembly, removing 2925

OP drawer holder, removing 2811

paper feed assembly (1x550-sheet paper feeder), removing 2849

paper feed assembly, removing 2849

paper pickup assembly, removing 2872

paper-feeder drive PCA (1x550-sheet paper feeder), removing 2843

paper-feeder drive PCA, removing 2843

rear cover, removing 2758, 2807

right door hinge bracket, removing 2771

right door, removing 2762

right-door link, removing 2794

right-lower cover, removing 2781

switch button (SW12) (1x550-sheet paper feeder), removing 2827

switch button (SW12), removing 2827

paper pickup

paper pickup assembly (1x550-sheet paper feeder), removing 2872

paper pickup assembly

removing and replacing 2241

paper pickup assembly (1x550-sheet paper feeder)

removing and replacing 2872

paper pickup assembly, removing and replacing 2241

paper-feeder drive PCA (1x550-sheet paper feeder)

removing and replacing 2843

part numbers

covers (M506) 3010

covers (M577) 3012

toner cartridge 3001

parts lists and diagrams 2995

500-sheet feeder 3024

covers 3010

document feeder and scanner whole units 3008

internal components, product 3014

using 3006

pickup and separation rollers,

replacing tray 1 568

pickup and separation rollers,

replacing tray 2-X 138

pickup drive assembly and motor (M5)

removing and replacing 2022

pickup drive assembly and motor (M5), removing and replacing 2022

power-supply fan (FM1)

removing and replacing 1037

power-supply fan (FM1), removing and replacing 1037

R

Rear cover

removing and replacing 361, 366

rear cover (1x550-sheet paper feeder)

removing and replacing 2758

Rear cover, removing and replacing 361, 366

rear right cover

removing and replacing 491, 519

rear right cover, removing and replacing 491, 519

registration assembly

removing and replacing 2119

registration assembly, removing and replacing 2119

removal orientation

removing orientation 7

removal strategy

removing and replacing 2

removing and replacing

auto close assembly (1x550-sheet paper feeder) 2817

control panel (M577) 92

document feeder (M577) 2656

document feeder rollers (M577) 128

door link (1x550-sheet paper feeder) 2794

drawer connector holder (1x550-sheet paper feeder) 2836

dual in-line memory module (DIMM) 53

duplex drive assembly 1887

embedded MultiMedia Card (eMMC) 61

fax PCA 2987

feeder drive assembly (1x550-sheet paper feeder) 2900

front door 348

- fuser 23
- fuser drive assembly 1777
- hard disk drive (HDD) 28, 34
- image scanner (M577) 2690
- internal USB ports (M552 and M553) 2971
- internal USB ports (M577) 2980
- left cover (1x550-sheet paper feeder) 2807
- lifter drive assembly (1x550-sheet paper feeder) 2925
- memory DIMM 44
- OP drawer holder (1x550-sheet paper feeder) 2811
- paper feed assembly (1x550-sheet paper feeder) 2849
- paper pickup assembly (1x550-sheet paper feeder) 2872
- paper-feeder drive PCA (1x550-sheet paper feeder) 2843
- rear cover (1x550-sheet paper feeder) 2758
- right door 339
- right door (1x550-sheet paper feeder) 2762
- right door hinge (1x550-sheet paper feeder) 2771
- right-door link (1x550-sheet paper feeder) 2794
- right-lower cover (1x550-sheet paper feeder) 2781
- rollers, document feeder (M577) 128
- scanner control board (M577) 2677
- SCB (M577) 2677
- secondary transfer assembly 580
- secondary transfer roller and ITB 166
- staple cartridge (M577c/f/z) 19
- switch button (SW12) (1x550-sheet paper feeder) 2827
- toner cartridges 9
- tray 1 pickup and separation rollers 568
- tray 2-X pickup and separation rollers 138
- white backing (M527) 120
- white backing (M577) 113
- removing parts
 - after-service checklist 6
 - before-service checklist 6
 - tools, required 4
- replacing parts
 - about 3
 - after-service checklist 6
 - before-service checklist 6
 - screws 4
 - tools, required 4
- right door
 - removing and replacing 339
- right door (1x550-sheet paper feeder)
 - removing and replacing 2762
- right door hinge bracket (1x550-sheet paper feeder)
 - removing and replacing 2771
- right-door link (1x550-sheet paper feeder)
 - removing and replacing 2794
- right-lower cover (1x550-sheet paper feeder)
 - removing and replacing 2781
- rollers
 - assembly, secondary transfer removing and replacing 580
 - secondary transfer, removing and replacing 166
 - tray 1 pickup and separation rollers, replacing 568
 - tray 2-X pickup and separation rollers, replacing 138
- rollers, document feeder (M527), removing and replacing 128
- rollers, document feeder (M577) removing and replacing 128
- S**
 - scan control board (M577), removing and replacing 2677
 - scanner control board (M577) removing and replacing 2677
 - SCB (M577) removing and replacing 2677
 - SCB (M577), removing and replacing 2677
 - SCB (M577), removing and replacing 2677
 - screwdrivers, required 4
- screws
 - installing 4
 - types of 4
- secondary transfer assembly, removing and replacing 580
- secondary transfer roller and ITB removing and replacing 166
- secondary transfer roller and ITB, removing and replacing 166
- service and support information v, 2, 2996, 3005
- service approach
 - removing and replacing 6
- staple cartridge (M577c/f/z) removing and replacing 19
- staple cartridge (M577c/f/z), removing and replacing 19
- static, precautions for 4
- switch button (SW12) (1x550-sheet paper feeder) removing and replacing 2827
- T**
 - tips iii
 - toner cartridge
 - ordering 3001
 - part numbers 3001
 - toner cartridges removing and replacing 9
 - toner collection unit (TCU) removing and replacing 14
 - toner collection unit (TCU), removing and replacing 14
 - tools, required 4
 - transfer removing and replacing 580
 - tray 1
 - pickup and separation rollers, removing and replacing 568
 - tray 1 pickup and separation rollers removing and replacing 568
 - tray 2-X
 - pickup and separation rollers, removing and replacing 138
 - tray 2-X pickup and separation rollers removing and replacing 138
 - trusted platform module (M552 and M553) removing and replacing 2956

trusted platform module (M577)
removing and replacing 2964
trusted platform module, removing
and replacing 2956, 2964

U

USB cover
removing and replacing 72
USB cover, removing and replacing
72

W

warnings iii
white backing (M527)
removing and replacing 120
white backing (M527), removing and
replacing 120
white backing (M577)
removing and replacing 113
white backing (M577), removing and
replacing 113
wireless PCA
removing and replacing 621
wireless PCA, removing and
replacing 621

