

# HP LaserJet P3010 Series Printers Service Manual



**Additional product information:**

**[www.hp.com/support/ljp3010series](http://www.hp.com/support/ljp3010series)**





# HP LaserJet P3010 Series Printers

## Service Manual



**Copyright and License**

© 2009 Copyright Hewlett-Packard  
Development Company, L.P.

Reproduction, adaptation, or translation  
without prior written permission is prohibited,  
except as allowed under the copyright laws.

The information contained herein is subject  
to change without notice.

The only warranties for HP products and  
services are set forth in the express warranty  
statements accompanying such products  
and services. Nothing herein should be  
construed as constituting an additional  
warranty. HP shall not be liable for technical  
or editorial errors or omissions contained  
herein.

Part number: CE524-90909

Edition 1, 7/2009

**Trademark Credits**

Adobe® is a trademark of Adobe Systems  
Incorporated.


Microsoft®, Windows®, Windows® XP, and  
Windows Vista® are U.S. registered  
trademarks of Microsoft Corporation.


ENERGY STAR and the ENERGY STAR  
mark are registered U.S. marks.





## Conventions used in this guide

---

 **TIP:** Tips provide helpful hints or shortcuts.

 **NOTE:** Notes provide important information to explain a concept or to complete a task.

 **CAUTION:** Cautions indicate procedures that you should follow to avoid losing data or damaging the product.

 **WARNING!** Warnings alert you to specific procedures that you should follow to avoid personal injury, catastrophic loss of data, or extensive damage to the product.

---



---

# Table of contents

## 1 Theory of operation

Basic operation .....	2
Major printer systems .....	2
Printer block diagram .....	2
Sequence of operation .....	3
Normal sequence of operation .....	3
Formatter-control system .....	4
Sleep mode .....	4
Input/output .....	4
CPU .....	4
Memory .....	5
Optional hard disk .....	5
Firmware .....	5
Nonvolatile memory .....	5
PJM overview .....	5
PML .....	5
Control panel .....	5
Engine-control system .....	6
Motors, fans, clutches, solenoids, switches, and sensors .....	7
DC controller operations .....	14
Fuser-control circuit .....	16
Fuser failure detection .....	17
Fuser temperature control .....	18
Fuser protective function .....	19
Low-voltage power supply .....	20
Overcurrent/overvoltage protection .....	21
High-voltage power supply .....	22
Formatter .....	23
Formatter heartbeat LED .....	23
DIMM slots .....	23
Laser/scanner system .....	24
Laser failure detection .....	25
Image-formation system .....	26
Electrophotographic process .....	26

Image formation process .....	27
Latent-image formation stage .....	28
Primary charging .....	28
Laser beam exposure .....	28
Developing stage .....	29
Print cartridge .....	29
Transfer stage .....	30
Fusing stage .....	30
Cleaning stage .....	31
Toner detection .....	32
Pickup, feed, and delivery system .....	33
Paper trays .....	33
Photo sensors and switches .....	34
Solenoids and clutches .....	36
Tray 1 or Tray 2 .....	38
Pickup and feed unit .....	38
Cassette paper size detection/cassette paper detection .....	38
Cassette pickup .....	38
Tray 1 paper pickup .....	38
Paper pickup and feed .....	39
Jam detection .....	40
Additional tray .....	41
Tray driver PCA .....	41
Paper pickup and feed .....	42
Media level and size detection .....	43
Jam detection .....	43

## 2 Removal and replacement

Removal and replacement strategy .....	46
General cautions during removal and replacement .....	46
Electrostatic discharge .....	46
Required tools .....	46
Types of screws .....	47
Service approach .....	48
Before performing service .....	48
After performing service .....	48
Post-service test .....	48
Print-quality test .....	48
Parts removal order .....	50
Removal and replacement procedures .....	52
Print cartridge, cassettes, and sub cover .....	52
Print cartridge .....	52
Tray cassette (Tray 2, Tray 3, or Tray 4) .....	54

Sub cover .....	55
External panels, covers, doors, formatter PCA, DIMM, and EIO disk .....	56
EIO disk .....	56
DIMM cover and DIMM .....	57
Reinstall the DIMM .....	58
Formatter cover and formatter PCA .....	60
Rear-door assembly .....	62
Left cover .....	66
Right-rear cover .....	68
Tray 1 (multipurpose tray) cover .....	69
Cartridge-door assembly .....	71
Top-right cover .....	73
Control panel .....	74
Front-right and right-side cover assembly .....	76
Lower-right cover and bracket .....	80
Reinstall the lower-right cover .....	82
Top cover .....	84
Main assemblies .....	86
Tray 1 (multipurpose tray) pickup roller .....	86
Tray 1 (multipurpose tray) separation pad .....	87
Tray 2, Tray 3, or Tray 4 pickup roller .....	88
Tray 2, Tray 3, or Tray 4 separation pad .....	90
Tray 2, Tray 3, or Tray 4 base-plate roller assembly .....	91
Transfer roller .....	92
USB port PCA .....	94
Power-switch assembly .....	96
Main fan, fan duct, and environmental sensor .....	98
Fuser .....	100
Registration assembly .....	102
Duplex media-feed assembly .....	104
Laser/scanner .....	107
Engine control unit (ECU) .....	110
Cassette pickup (Tray 2) solenoid or Tray 1 (multipurpose tray) pickup solenoid .....	115
Fuser motor .....	117
Sub fan and fan duct .....	118
High-voltage power supply (HVPS) .....	121

### 3 Solve problems

Solve problems checklist .....	128
Menu map .....	130
Troubleshooting process .....	131
Determine the problem source .....	131
Power subsystem .....	132

Power-on checks .....	132
Tools for troubleshooting .....	133
Individual component diagnostics .....	133
LED diagnostics .....	133
LED indicators .....	133
Formatter heartbeat LED .....	133
HP Jetdirect LEDs .....	134
Engine diagnostics .....	134
Engine-test button .....	134
Fuser test page .....	135
Paper-path test (and automatic sensors test) .....	136
Sensor test (interactive) .....	137
A TOP (Top-of-Page) sensor .....	140
B Fuser output sensor .....	141
C Duplex sensor .....	142
D Paper width sensor 1 .....	143
E Tray 3 feed sensor .....	144
F Tray 4 feed sensor .....	145
G FD tray full sensor .....	146
H Face up detect sensor .....	147
I Cartridge-door open switch .....	148
J Rear cover open sensor .....	149
K Tray 1 paper sensor .....	150
L Tray 2 paper sensor .....	151
M Tray 2 detect switch .....	152
N Tray 3 paper sensor .....	153
O Tray 3 detect switch .....	154
P Tray 4 paper sensor .....	155
Q Tray 4 detect switch .....	156
Print/stop test .....	157
Component tests .....	158
Half self-test .....	158
Drum rotation test check .....	158
Diagnostics menu components test .....	158
Diagrams .....	160
Block diagrams .....	160
Plug/jack locations .....	162
Location of connectors .....	163
ECU controller connections .....	163
Locations of major components .....	165
General timing charts .....	169
General circuit diagram .....	170
Internal print quality test pages .....	171
Cleaning page .....	172

Configuration page .....	172
Print quality troubleshooting tools .....	173
Repetitive image-defect ruler .....	173
Control-panel menus .....	174
Use the menus .....	174
Show Me How menu .....	174
Retrieve job menu .....	175
Information menu .....	176
Paper handling menu .....	177
Manage supplies menu .....	177
Configure device menu .....	178
Printing menu .....	178
Print Quality menu .....	180
System setup menu .....	183
I/O menu .....	187
Resets menu .....	194
Diagnostics menu .....	194
Service menu .....	196
Interpret control-panel messages .....	197
Control-panel message types .....	197
Control-panel messages .....	197
Event-log messages .....	215
Print an event log .....	215
Show an event log .....	215
Sample event-log page .....	216
Clear an event log .....	216
Event-log messages .....	217
Clear jams .....	219
Common causes of jams .....	219
Jam locations .....	220
Clear jams from the input trays .....	222
Clear jams from the duplexer .....	226
Clear jams from the output areas .....	231
Clear jams from inside the product .....	234
Registration and transfer area .....	234
Jam causes and solutions .....	236
Avoid repeated jams .....	240
Change jam recovery .....	241
Solve paper-handling problems .....	242
Product feeds multiple sheets .....	242
Product feeds incorrect page size .....	242
Product pulls from incorrect tray .....	243
Paper does not feed automatically .....	243
Paper does not feed from Tray 2, 3, or 4 .....	244

Transparencies or glossy paper will not feed .....	244
Envelopes jam or will not feed in the product .....	245
Output is curled or wrinkled .....	245
Product does not duplex or duplexes incorrectly (duplex models) .....	246
Solve image-quality problems .....	247
Image defect examples .....	247
Clean the product .....	254
Solve performance problems .....	257
Solve connectivity problems .....	258
Solve direct-connect problems .....	258
Solve network problems .....	258
Service mode functions .....	259
Service menu .....	259
Product resets .....	260
Restore factory settings .....	260
Hard disk initialization .....	260
Skip disk-load .....	260
NVRAM initialization .....	260
Service ID .....	261
Restore service ID .....	261
Convert the service ID to an actual date .....	261
Reset serial number .....	262
Reset page counts .....	262
Product cold reset .....	262
Product updates .....	263
Determine the current firmware version .....	263
Download new firmware from the HP Web site .....	263
Transfer the new firmware to the product .....	263
Use the flash executable file to update the firmware .....	263
Use FTP to upload the firmware through a browser .....	264
Use FTP to upgrade the firmware on a network connection .....	264
Use HP Web Jetadmin to upgrade the firmware .....	265
Use Microsoft Windows commands to upgrade the firmware .....	265
Upgrade the HP Jetdirect firmware .....	265
<b>4 Parts and diagrams</b>	
Order parts by authorized service providers .....	268
Order parts, accessories, and supplies .....	268
Related documentation and software .....	268
Supplies part numbers .....	268
Accessories part numbers .....	269
Whole-unit replacement part numbers .....	270
How to use the parts lists and diagrams .....	271



Assembly locations .....	272
Base product (no optional trays or accessories) .....	272
Base product (optional trays or accessories) .....	273
Covers .....	274
Internal assemblies (1 of 6) .....	276
Internal assemblies (2 of 6) .....	278
Internal assemblies (3 of 6) .....	280
Internal assemblies (4 of 6) .....	282
Internal assemblies (5 of 6) .....	284
Internal assemblies (6 of 6) .....	286
Input devices .....	288
500-sheet input tray (Tray 3 and Tray 4) .....	288
Alphabetical parts list .....	290
Numerical parts list .....	293

## Appendix A Service and support

Hewlett-Packard limited warranty statement .....	298
HP's Premium Protection Warranty: LaserJet print cartridge limited warranty statement .....	299
End User License Agreement .....	300
Customer self-repair warranty service .....	302
Customer support .....	303
Repack the product .....	304
Service information form .....	305

## Appendix B Specifications

Physical specifications .....	308
Electrical specifications .....	308
Acoustic specifications .....	308
Environmental specifications .....	309

## Appendix C Regulatory information

FCC regulations .....	312
Environmental product stewardship program .....	313
Protecting the environment .....	313
Ozone production .....	313
Power consumption .....	313
Toner consumption .....	313
Paper use .....	313
Plastics .....	313
HP LaserJet print supplies .....	313
Return and recycling instructions .....	314
United States and Puerto Rico .....	314
Multiple returns (more than one cartridge) .....	314

Single returns .....	314
Shipping .....	314
Non-U.S. returns .....	314
Paper .....	314
Material restrictions .....	315
Disposal of waste equipment by users in private households in the European Union ....	315
Chemical substances .....	315
Material Safety Data Sheet (MSDS) .....	316
For more information .....	316
Declaration of conformity .....	317
Safety statements .....	318
Laser safety .....	318
Canadian DOC regulations .....	318
VCCI statement (Japan) .....	318
Power cord statement (Japan) .....	318
EMC statement (Korea) .....	318
Laser statement for Finland .....	319
Substances Table (China) .....	320
<b>Index .....</b>	<b>321</b>

---

# 1 Theory of operation

- [Basic operation](#)
- [Formatter-control system](#)
- [Engine-control system](#)
- [Image-formation system](#)
- [Pickup, feed, and delivery system](#)
- [Tray 1 or Tray 2](#)
- [Additional tray](#)

# Basic operation

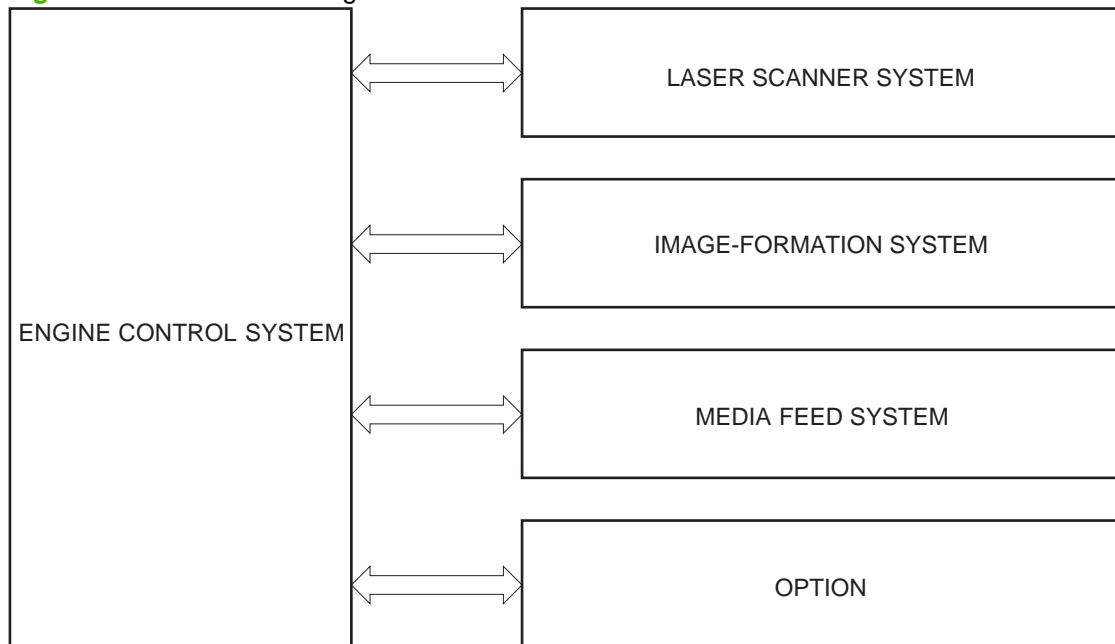
## Major printer systems

The product contains the following five systems:

- Engine-control system
- Laser/scanner system
- Image-formation system
- Media feed system
- Option

## Printer block diagram

Figure 1-1 Printer block diagram



## Sequence of operation

The DC controller in the engine-control system controls the operational sequences of the printer. The table below describes durations and operations for each period of a print operation from when the printer is turned on until the motor stops rotating

### Normal sequence of operation

**Table 1-1 Sequence of operation**

Name	Timing	Purpose
WAIT	From the time the power switch is turned on or the door is closed until the printer is ready for a print operation.	Brings the product to printable condition. The product performs the following during the operation: <ul style="list-style-type: none"><li>• Detects the print cartridge</li></ul>
STBY (standby)	From the end of the WAIT or LSTR period until either a print command is sent or the power switch is turned off.	Maintains the product in printable condition.
INTR (initial rotation)	From the time the print command is received until the temperature of the fuser unit reaches its targeted temperature.	Starts up the high-voltage biases, the laser/scanner and the fuser unit for printing.
PRINT	From the end of the INTR period until the last sheet completes the fuser operation.	Forms the image on the photosensitive drum based on the VIDEO signals from the formatter. Transfers and fuses the toner image to the paper.
LSTR (last rotation)	From the end of the PRINT period until the main motor stops rotating.	Moves the last printed sheet out of the product.  The product enters the INTR period as the LSTR period is completed, if the formatter sends another print command.

## Formatter-control system

The formatter is responsible for the following procedures:

- Controlling sleep mode
- Receiving and processing print data from the various product interfaces
- Monitoring control-panel functions and relaying product-status information (through the control panel and the network or bidirectional interface)
- Developing and coordinating data placement and timing with the DC controller PCA
- Storing font information
- Communicating with the host computer through the network or the bidirectional interface

The formatter receives a print job from the network or bidirectional interface and separates it into image information and instructions that control the printing process. The DC controller PCA synchronizes the image-formation system with the paper-input and -output systems, and then signals the formatter to send the print-image data.

The formatter also provides the electrical interface and mounting locations for one EIO card and an additional DIMM.

## Sleep mode

---

 **NOTE:** In the **SYSTEM SETUP** menu, this item is termed **SLEEP DELAY**.


---

This feature conserves power after the product has been idle for an adjustable period of time. When the product is in **SLEEP DELAY**, the control-panel backlight is turned off, but the product retains all settings, downloaded fonts, and macros. The default setting is for **SLEEP DELAY** to be enabled, and the product enters **SLEEP DELAY** after a 30-minute idle time.

The product exits **SLEEP DELAY** and enters the warm-up cycle when any of the following events occur:

- A print job, valid data, or a PML or PJJL command is received
- A control-panel button is pressed
- A cover is opened
- A paper tray is opened
- The engine-test switch is pressed

---

 **NOTE:** Product error messages override the Sleep message. The product enters **SLEEP DELAY** at the appropriate time, but the error message continues to appear.

---

## Input/output


The product receives print data primarily from the embedded HP Jetdirect print server. The product also has a USB 2.0 port for connecting directly to a computer.

## CPU

The formatter incorporates a 540 MHz Coldfire processor.

## Memory

The random access memory (RAM) on the formatter PCA contains the page, I/O buffers, and the font storage area. It stores printing and font information received from the host system, and can also serve to temporarily store a full page of print-image data before the data is sent to the print engine. Memory capacity can be increased by adding a DIMM to the formatter. Note that adding memory might also increase the print speed for complex graphics.

 **NOTE:** If the product encounters a problem when managing available memory, a clearable warning message appears on the control-panel display.

---

## Optional hard disk

This product supports an optional EIO hard disk or an optional secure hard disk as an accessory.

## Firmware

The firmware is contained on NAND flash memory soldered on the formatter board. A remote firmware upgrade process is available, which overwrites the firmware in the NAND flash.

## Nonvolatile memory

The product uses nonvolatile memory (NVRAM) to store device and user configuration settings. The contents of NVRAM are retained when the product is turned off or disconnected.

## PJL overview

The printer job language (PJL) is an integral part of configuration, in addition to the standard printer command language (PCL). With standard cabling, the product can use PJL to perform a variety of functions such as these:

- Two-way communication with the host computer through a network connection or a USB connection. The product can inform the host about such things as the control-panel settings, and the control-panel settings can be changed from the host.
- Dynamic I/O switching. The product uses this switching to be configured with a host on each I/O. The product can receive data from more than one I/O simultaneously, until the I/O buffer is full. This can occur even when the product is offline.
- Context-sensitive switching. The product can automatically recognize the personality (PS or PCL) of each job and configure itself to serve that personality.
- Isolation of print environment settings from one print job to the next. For example, if a print job is sent to the product in landscape mode, the subsequent print jobs print in landscape mode only if they are formatted for landscape printing.

## PML

The printer management language (PML) allows remote configuration and status read-back through the I/O ports.

## Control panel

The formatter sends and receives product status and command data to and from the control-panel PCA.

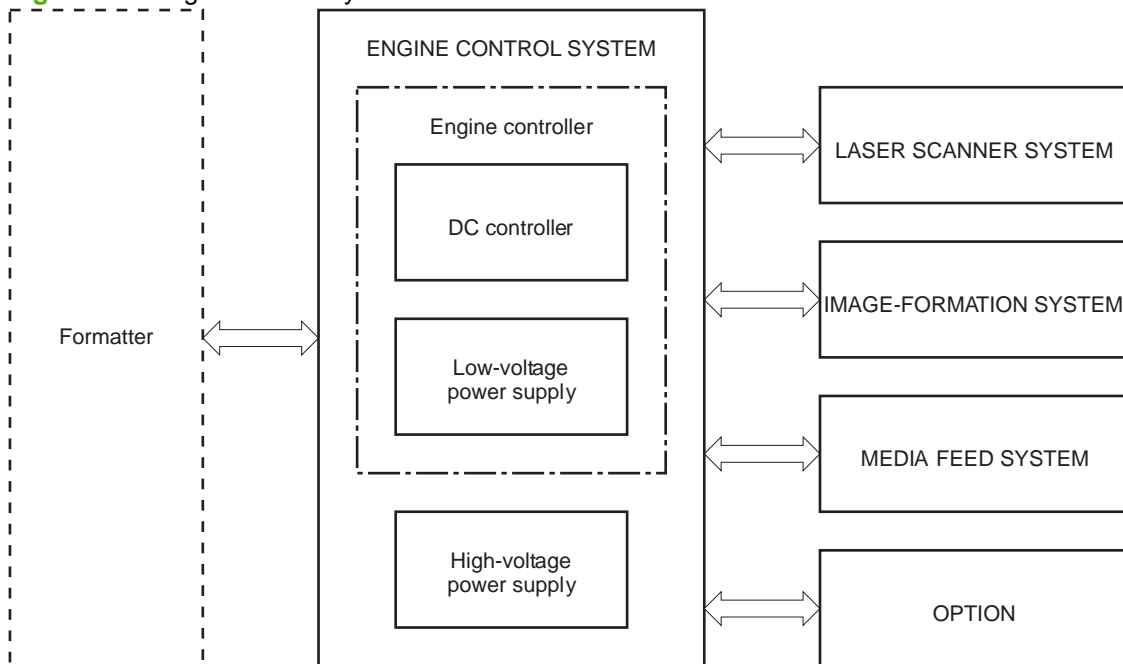
# Engine-control system

The engine-control system coordinates all product functions, according to commands that the formatter sends. The engine-control system drives the laser/scanner system, the image formation system, and the pickup/feed/delivery system.

The engine control system contains the following major components:

- Engine-control unit (ECU)
  - DC controller
  - Low-voltage power supply
- High-voltage power supply

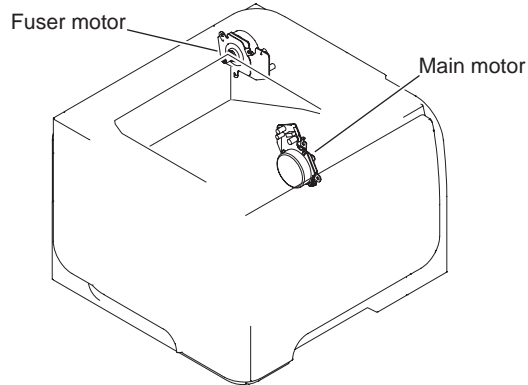
**Figure 1-2** Engine-control system





## Motors, fans, clutches, solenoids, switches, and sensors

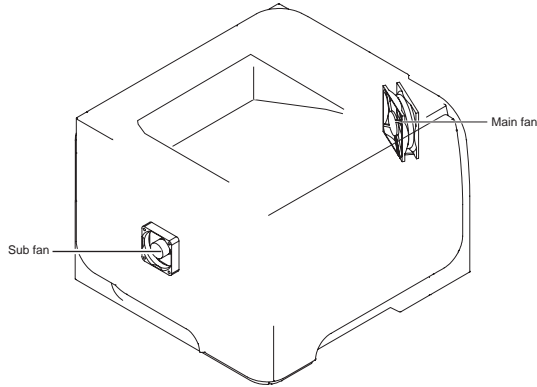
**Figure 1-3 Motors**



**Table 1-2 Motors**

Description	Components driven	Fault detection
Main motor (M8001)	<ul style="list-style-type: none"> <li>● Pickup roller</li> <li>● Feed roller</li> <li>● Transfer roller</li> <li>● Photosensitive drum</li> <li>● Developing roller</li> <li>● Duplex repickup roller (duplex models only)</li> </ul>	Yes
Fuser motor (M8002)	<ul style="list-style-type: none"> <li>● Pressure roller</li> <li>● Delivery roller</li> <li>● Fuser-delivery roller</li> <li>● Duplex-feed roller (duplex models only)</li> </ul>	Yes

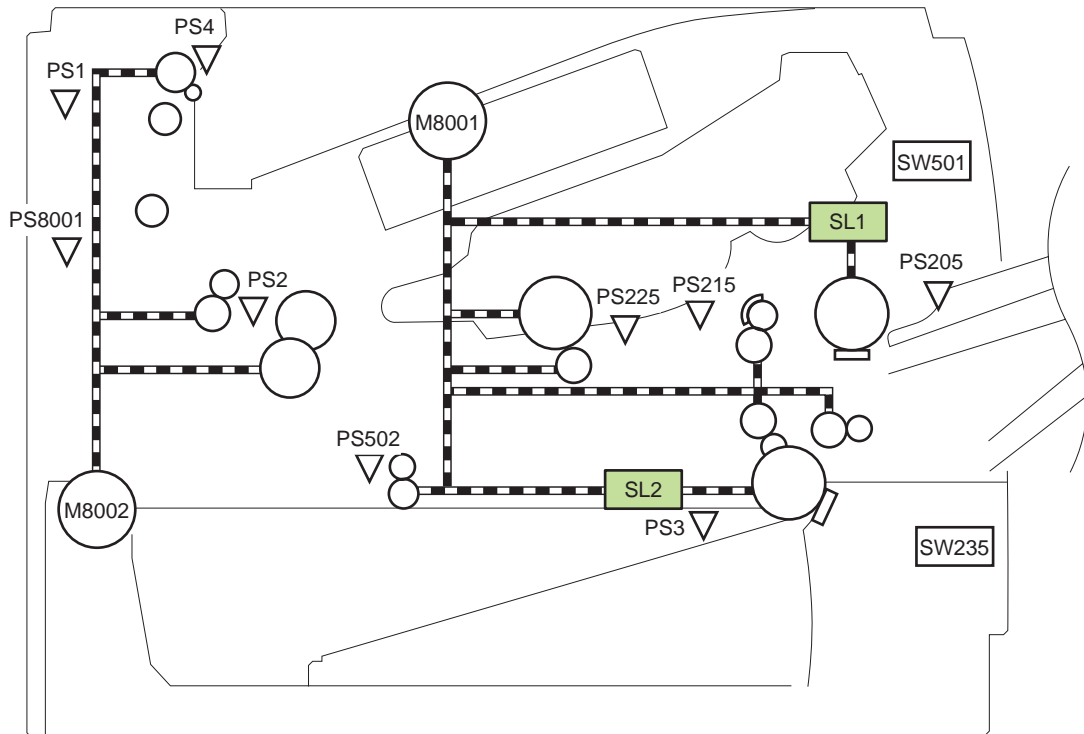
**Figure 1-4 Fans**



**Table 1-3 Fans**

Description	Area cooled	Type	Speed
Main fan (FM1)	Inside the product	Intake	Full
Sub fan (FM2)	Inside the product	Intake	Full

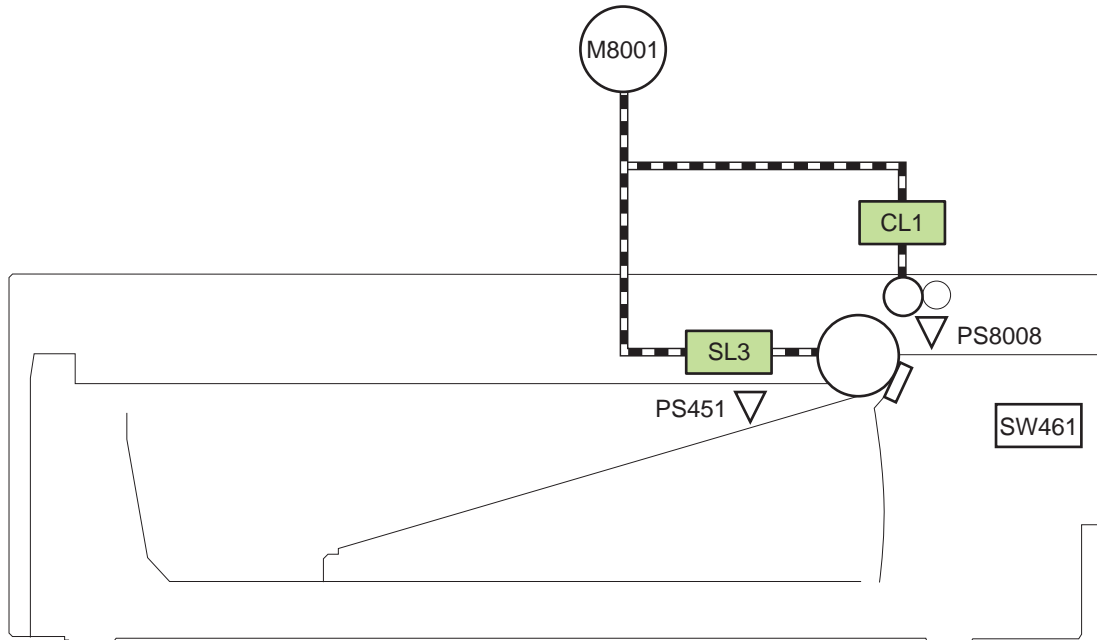
**Figure 1-5 Solenoids and clutches (product)**



**Table 1-4 Solenoids and clutches (product)**

Item	Description
SL1	Tray 1 (multipurpose tray) pickup solenoid
SL2	Cassette (Tray 2) pickup solenoid

**Figure 1-6** Solenoids and clutches (Tray 3 and Tray 4)

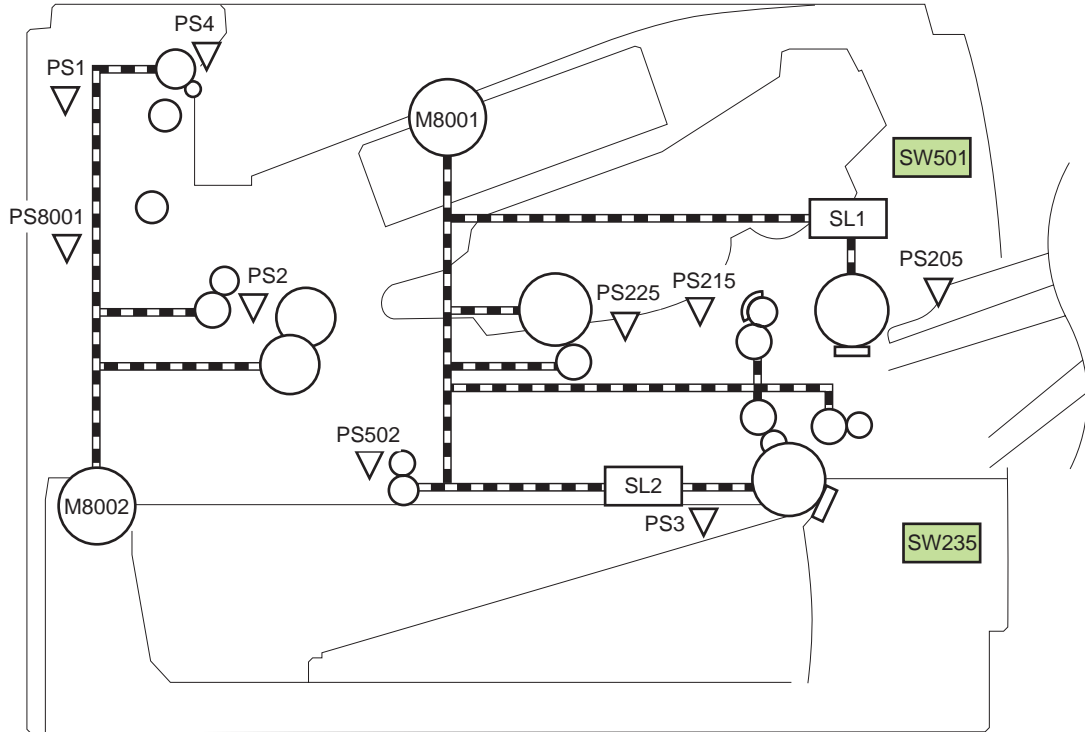


**Table 1-5** Solenoids and clutches (Tray 3 and Tray 4)

Item	Description
SL3	Paper feeder pickup solenoid
CL1	Paper feeder pickup clutch

<sup>1</sup> Tray 3 and Tray 4 are identical 500-sheet input trays.

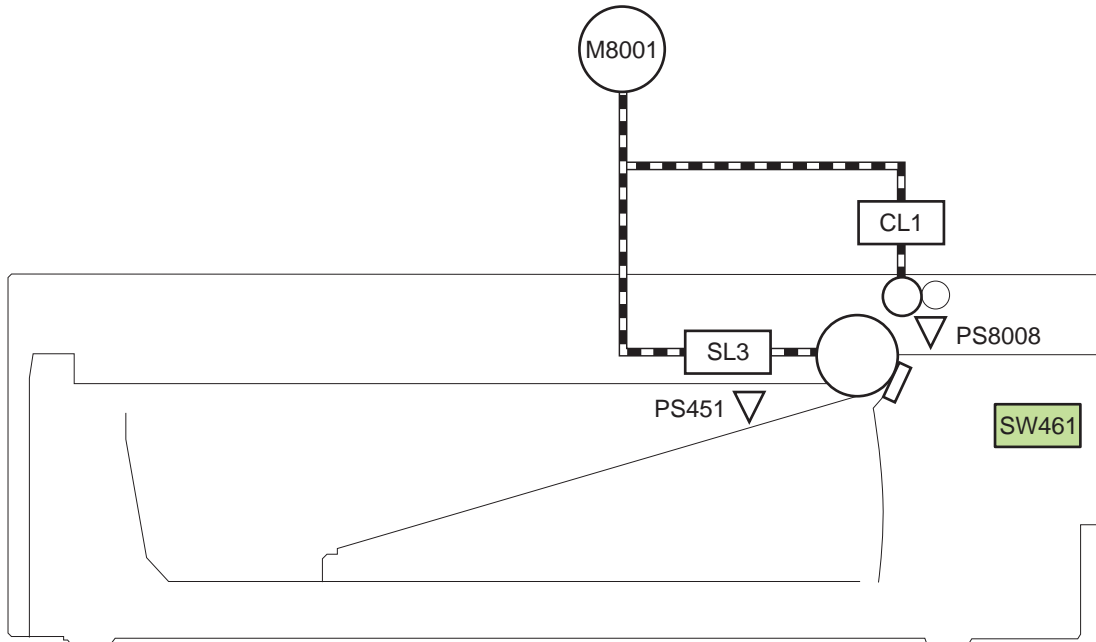
**Figure 1-7** Switches (product)



**Table 1-6** Switches (product)

Item	Description
SW235	Cassette presence switch
SW501	Cartridge-door switch

**Figure 1-8** Switches (Tray 3 and Tray 4)

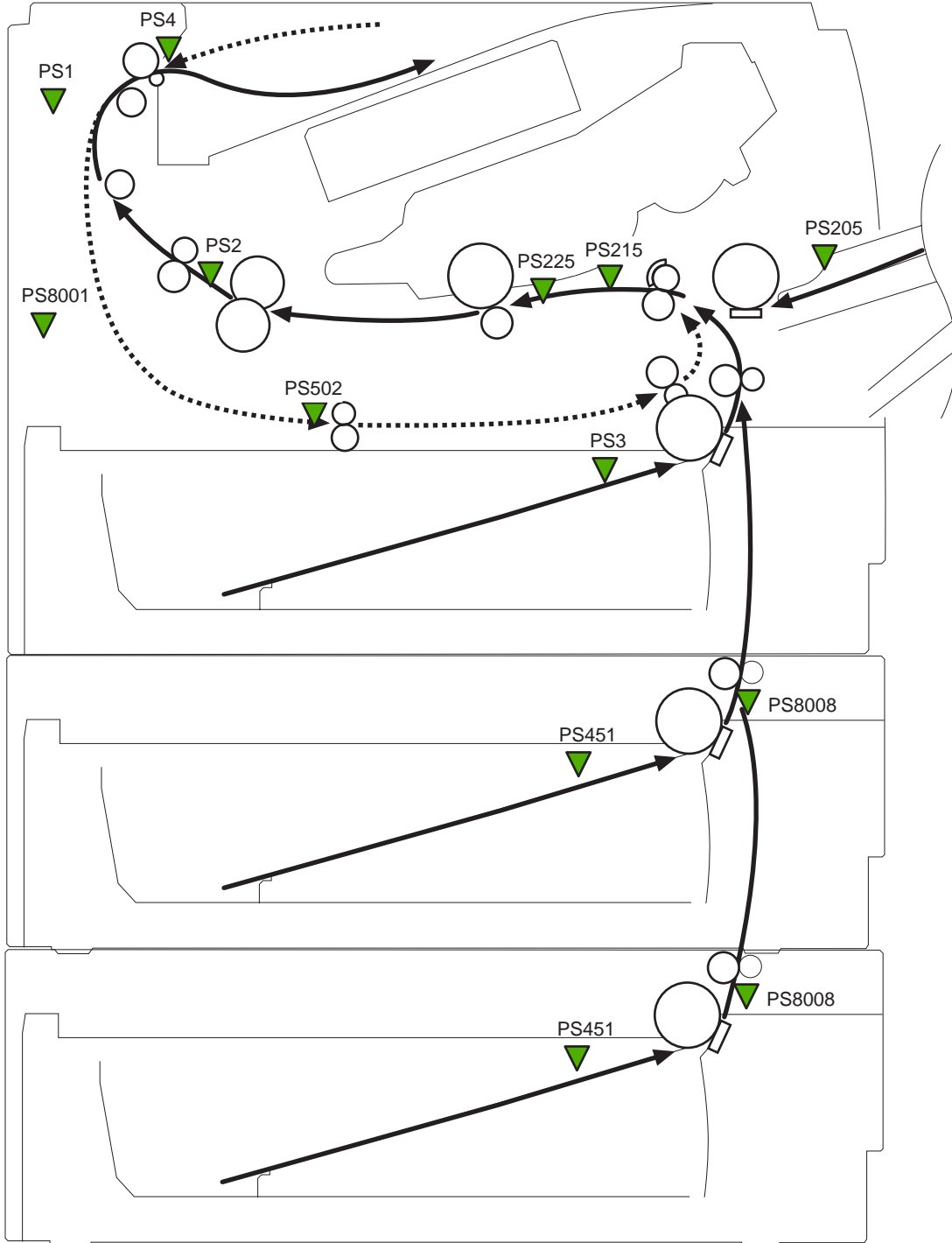


**Table 1-7** Switches (Tray 3 and Tray 4)

Item	Description
SW461	Paper feeder cassette presence switch

<sup>1</sup> Tray 3 and Tray 4 are identical 500-sheet input trays.

**Figure 1-9** Sensors



**Table 1-8** Sensors

Item	Description	Item	Description
PS1	Face-up sensor	PS225	Media width sensor
PS2	Fuser delivery sensor	PS502	Duplex media-feed sensor (duplex models only)
PS3	Cassette media-presence sensor	PS451	Paper feeder cassette media-presence sensor
			<b>NOTE:</b> PS451 is used in Tray 3, and Tray 4

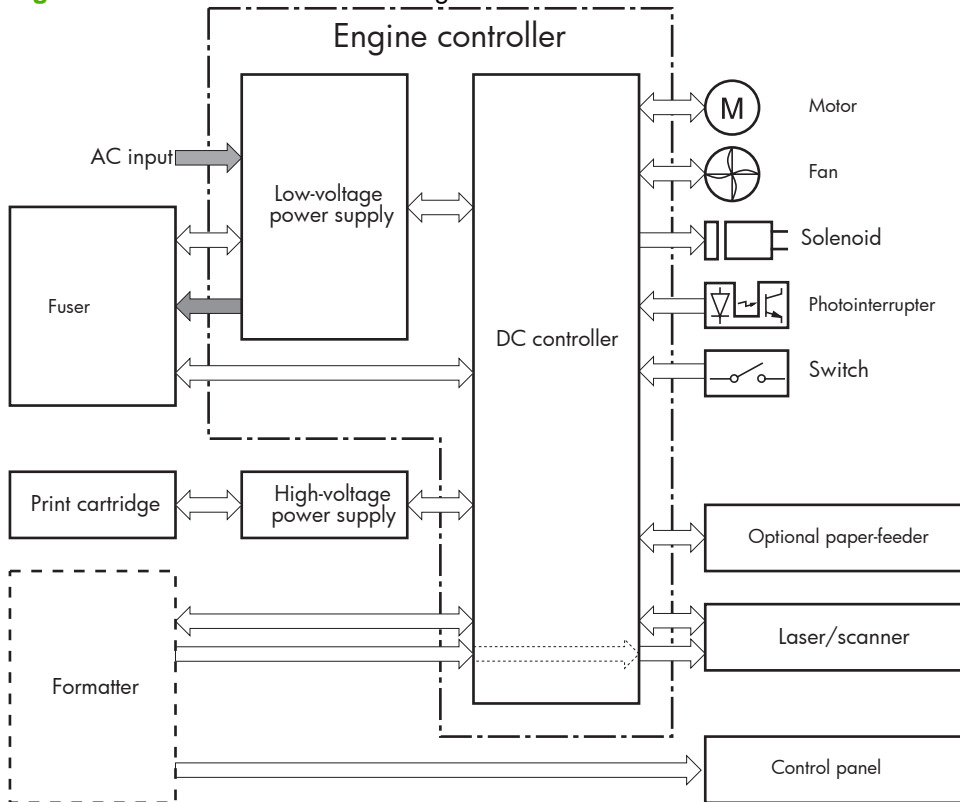
**Table 1-8 Sensors (continued)**

Item	Description	Item	Description
PS4	Face-down tray media-full sensor	PS8001	Rear door sensor
PS205	Tray 1 (multipurpose tray) media-presence sensor	PS8008	Paper feeder media-feed sensor <b>NOTE:</b> PS8008 is used in Tray 3, and Tray 4
PS215	Top-of-Page (TOP) sensor		

## DC controller operations

The DC controller controls the operational sequences of the product systems.

**Figure 1-10** DC controller block diagram



**Table 1-9** DC controller controlled components

Component	Designator	Description
Motor	M8001	Main motor
	M8002	Fuser motor
Fan	FM1	Main fan
	FM2	Sub fan
Solenoid	SL1	Tray 1 (multipurpose tray) pickup solenoid
	SL2	Cassette (Tray 2) pickup solenoid



**Table 1-9 DC controller controlled components (continued)**

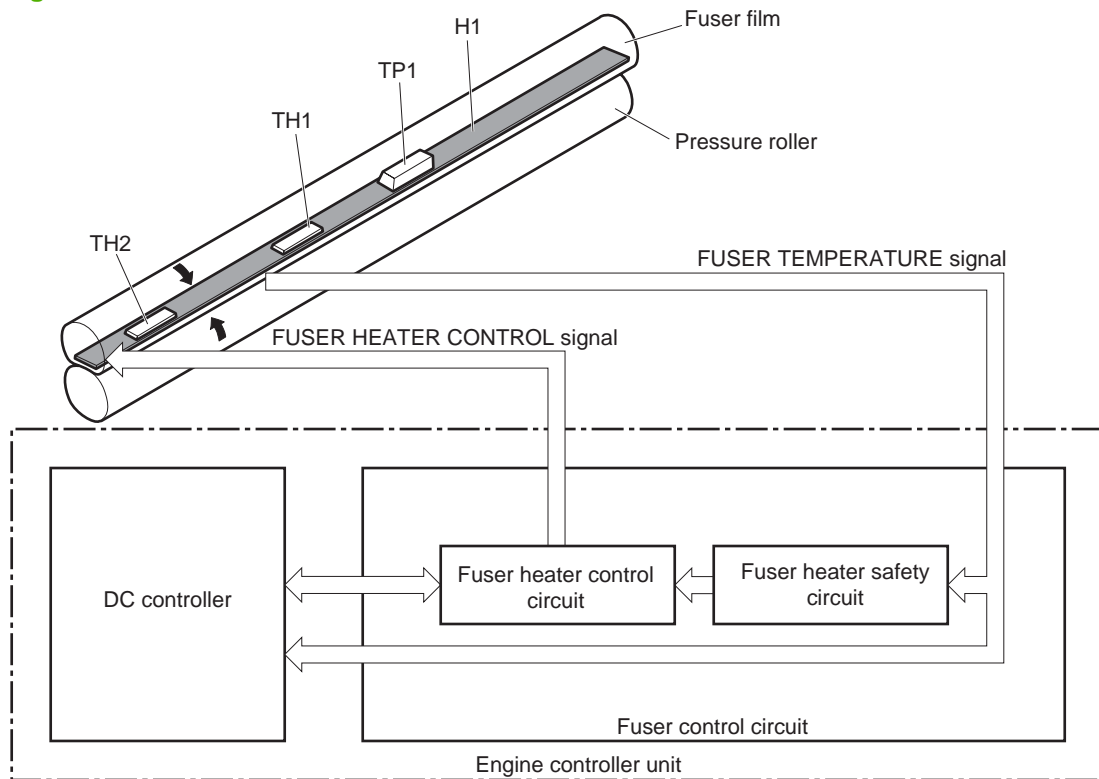
Component	Designator	Description
Photointerrupter	PS1	Face-up sensor
	PS2	Fuser delivery sensor
	PS3	Cassette media presence sensor
	PS4	Face-down tray (output bin) media-full sensor
	PS205	Tray 1 (multipurpose tray) presence sensor
	PS215	Top-Of-Page (TOP) sensor
	PS225	Media width sensor
	PS451	Paper feeder cassette media-presence sensor <b>NOTE:</b> PS451 is used in Tray 3, and Tray 4
	PS502	Duplex media-feed sensor (duplex models only)
	PS8001	Rear door sensor
Switch	PS8008	Paper feeder media-feed sensor
	SW235	Cassette-presence switch <b>NOTE:</b> PS8008 is used in Tray 3, and Tray 4
	SW240	Power switch
	SW250	Test Print switch
	SW501	Cartridge-door switch

## Fuser-control circuit

The fuser-control circuit monitors and controls the temperature in the fuser. The product uses on-demand fusing. The fuser-control circuit consists of the following major components:

- Fuser heater (H1); heats the fusing film
- Thermistor (TH1 and TH2); detects the fuser temperature (contact type)
  - Main thermistor (TH1); controls the temperature in the fuser (contact type)
  - Sub thermistor (TH2); detects a one-sided temperature rise in the fuser and controls the temperature in the fuser (contact type)
- Thermostwitch (TP1); prevents abnormal temperature rise in the fuser (contact type)

**Figure 1-11** Fuser control circuit



## Fuser failure detection

The DC controller determines a fuser unit failure, deactivates the FUSER HEATER CONTROL signal, releases the relay to interrupt power supply to the fuser heater and notifies the formatter of a failure state when it encounters the following conditions:

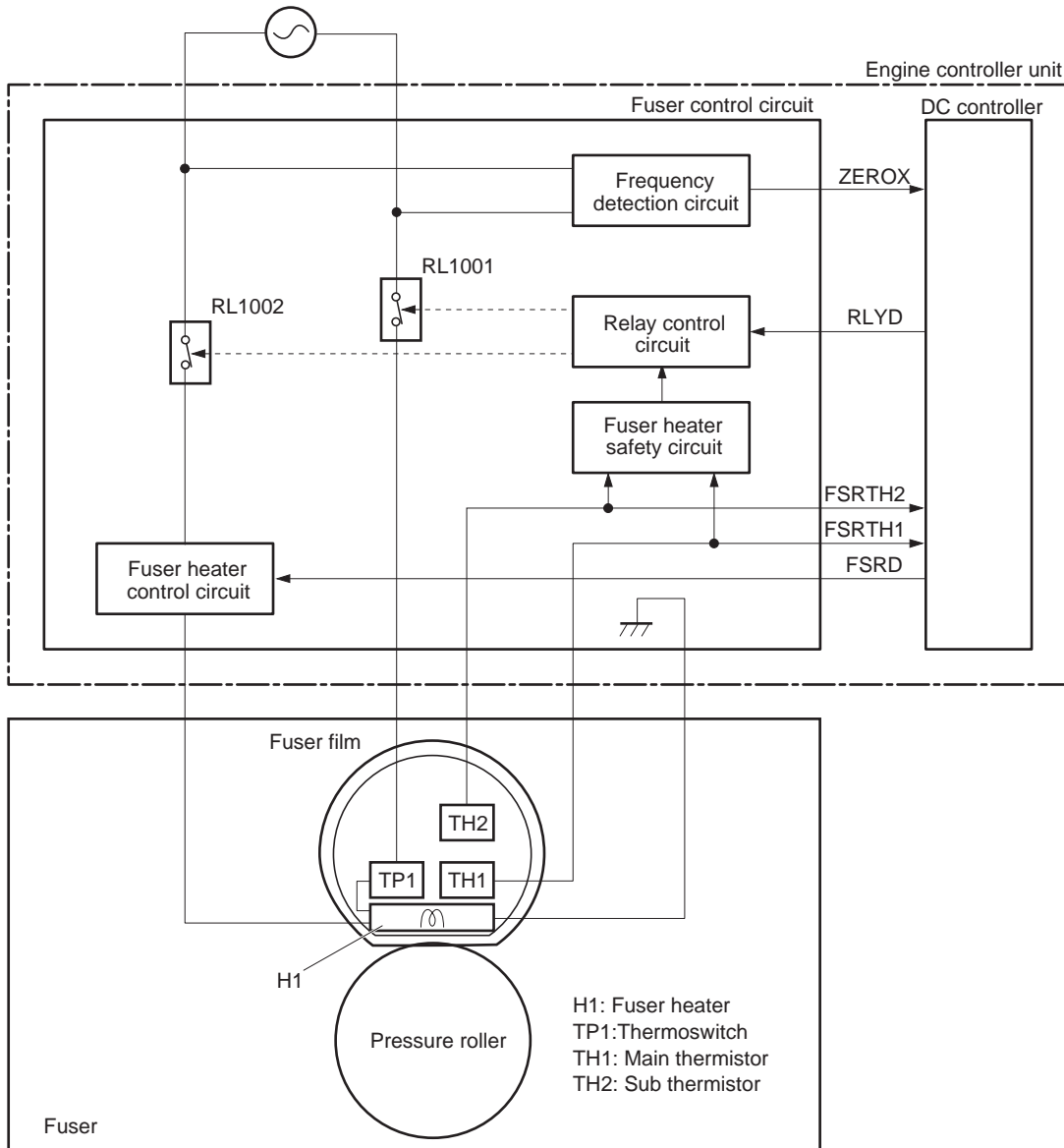
- Start-up failure
  - If the main thermistor does not detect a specified temperature during the start-up process of the heater in the wait period.
  - If the main thermistor does not detect a specified temperature during the heater temperature control in the initial rotation period.
- Abnormal low temperature
  - If the main thermistor detects an abnormal low temperature of the fuser unit during the printing operation.
  - If the sub thermistor detects an abnormal low temperature of the fuser unit during the printing operation.
- Abnormal high temperature
  - If the main thermistor detects an abnormal high temperature of the fuser unit.
  - If the sub thermistor detects an abnormal high temperature of the fuser unit.
- Frequency detection circuit failure
  - If a specified frequency of the ZERO CROSSING signal is not detected within a specified period after the product is turned on.

## Fuser temperature control

The fuser temperature control maintains the temperature of the fuser heater at its targeted temperature.

The DC controller monitors the FUSER TEMPERATURE (FSRTH1, FSRTH2) signals and sends the FUSER HEATER CONTROL (FSRD) signal according to the detected temperature. The fuser heater control circuit controls the fuser heater depending on the signal so that the heater remains at the targeted temperature.

**Figure 1-12** Fuser-heater control circuit



## Fuser protective function

The protective function detects an abnormal temperature rise of the fuser unit and interrupts power supply to the fuser heater.

The following three protective components prevent an abnormal temperature rise of the fuser heater:

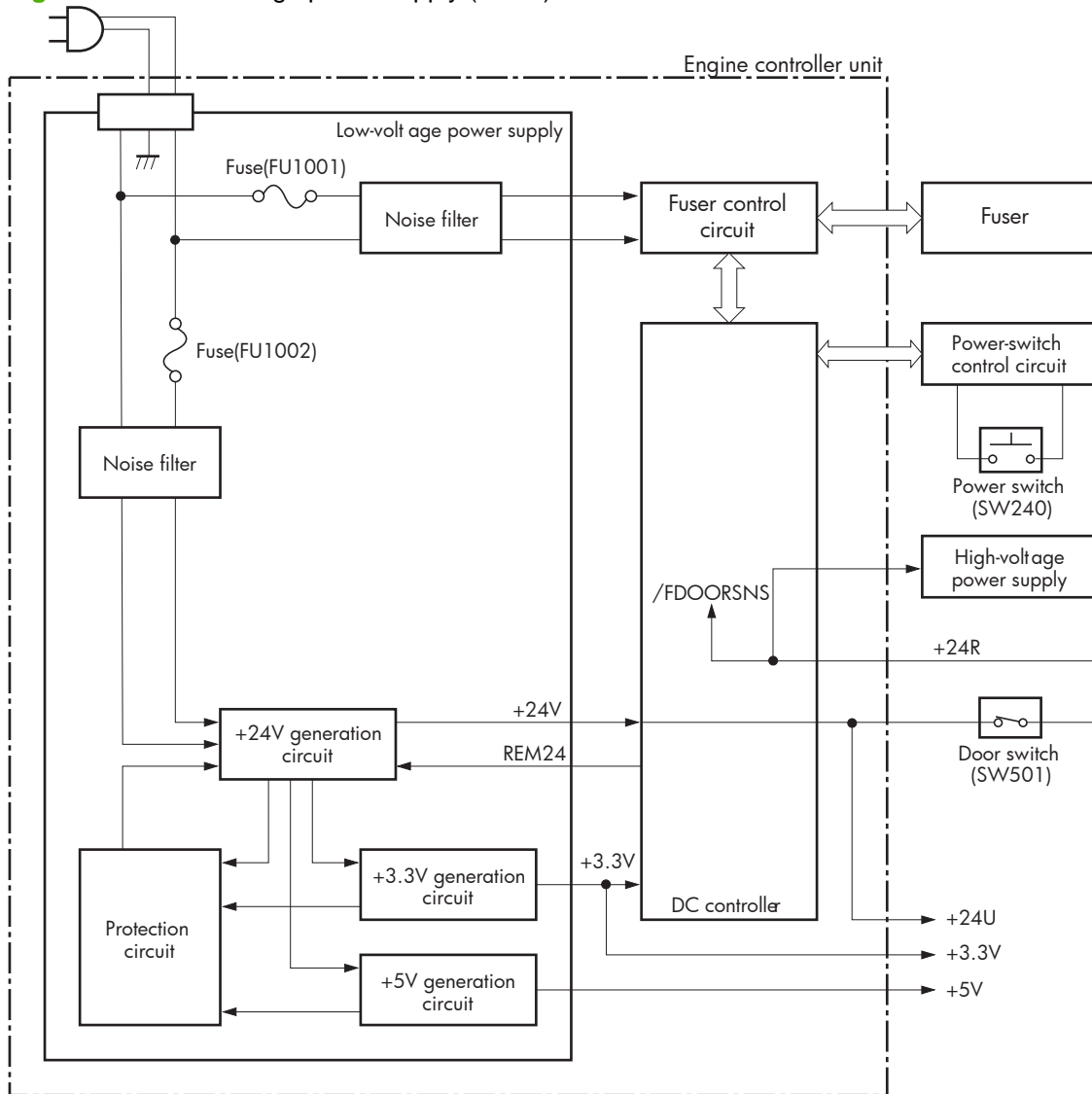
- DC controller
  - The DC controller interrupts power supply to the fuser heater when it detects an abnormal temperature of the fuser heater.
- Fuser heater safety circuit
  - The fuser heater safety circuit interrupts power supply to the fuser heater when the detected temperature of the main and sub thermistors is abnormal.
- Thermoswitch
  - The contact of the thermosthwitch is broken to interrupt power supply to the fuser heater when the thermosthwitch detects an abnormal temperature of the fuser heater.

## Low-voltage power supply

The low-voltage power supply (LVPS) converts ac input voltage to dc voltage. The LVPS has two fuses on the PCA. The LVPS 24 V output is interrupted to the fuser and the high-voltage power supply if the cartridge-door interlock switch (SW501) is in the off position (cover open).

**⚠ WARNING!** The product power switch only interrupts dc voltage from the LVPS. The ac voltage is present in the product when the power cord is plugged into a power receptacle and the power switch is in the off position. You must unplug the product power cord before servicing the product.

**Figure 1-13** Low-voltage power supply (LVPS)



## Overcurrent/overvoltage protection

The low-voltage power supply has a protective function against overcurrent and overvoltage to prevent failures in the power supply circuit. If an overcurrent or overvoltage condition occurs, the system automatically cuts off the output voltage.

If the DC power is not being supplied from the low-voltage power supply, the protective function might be running. In such case, turn off the power switch and unplug the power cord. Do not plug in the power cord or turn on the power switch again until the cause is found.

---

⚠ **WARNING!** If you believe the overcurrent or overvoltage protection circuits have been activated, do not plug in the product power cord or turn on the product power until the cause of the failure is found and corrected.

---

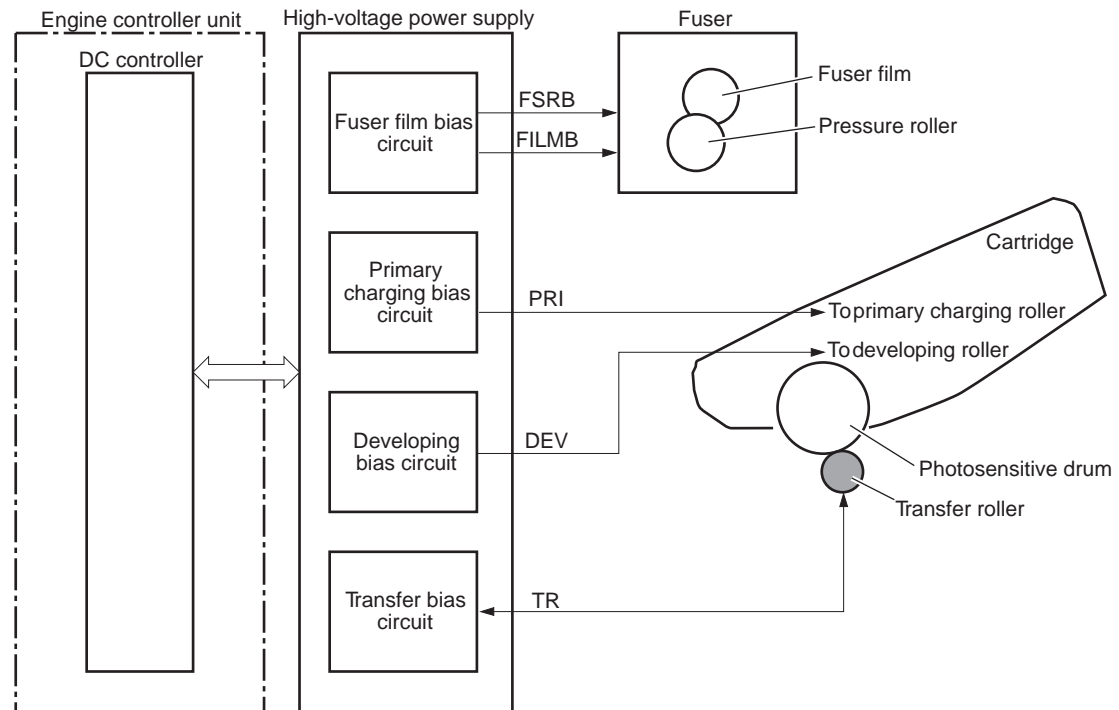
In addition, two fuses in the low-voltage power supply protect against overcurrent. If overcurrent flows into the AC line, the fuses melt and cut off the power distribution.

## High-voltage power supply

The high-voltage power supply (HVPS) applies biases to the following components:

- Primary charging roller
- Developing roller
- Transfer roller
- Fusing film

**Figure 1-14** High-voltage power supply





## Formatter

### Formatter heartbeat LED

The heartbeat LED indicates that the formatter is functioning correctly. While the product is initializing after you turn the product on, the LED blinks rapidly, and then turns off. When the product has finished the initialization sequence, the heartbeat LED pulses on and off. For more information about the heartbeat LED see [Formatter heartbeat LED on page 133](#).

### DIMM slots

- 
- △ **CAUTION:** Single inline memory modules (SIMMs) used in previous HP LaserJet products are not compatible with the product.
- 

The formatter has one dual inline memory module (DIMM) slot for upgrading the product with more memory.

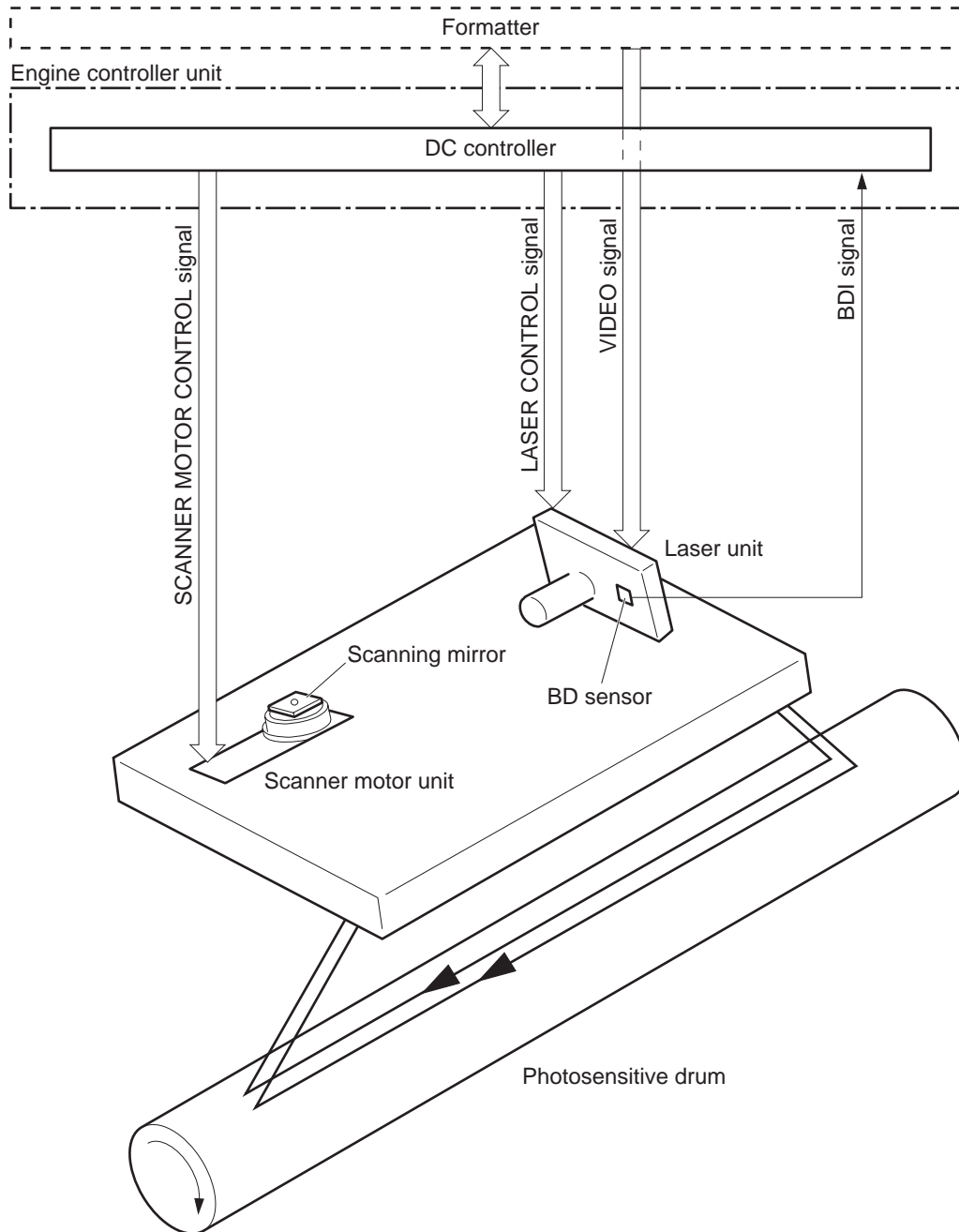
To find out how much memory is installed in the product, print a configuration page. For more information about memory, see [DIMM cover and DIMM on page 57](#).

## Laser/scanner system

The laser/scanner system receives VIDEO signals from the ECU and the formatter and converts the signals into latent images on the photosensitive drum.

The main components of the laser/scanner are the laser unit and the scanner motor unit. The DC controller sends signals to the laser/scanner to control the functions of these components.

**Figure 1-15** Laser/scanner system



## Laser failure detection

The DC controller determines an optical unit failure and notifies the formatter, if the laser/scanner encounters the following conditions:

- The scanner motor does not reach a specified rotation within a specified period of the scanner motor start up.
- The rotation of the scanner motor is out of specified range for a specified period during the scanner motor drive.
- The BD interval is out of a specified value during a print operation.

# Image-formation system

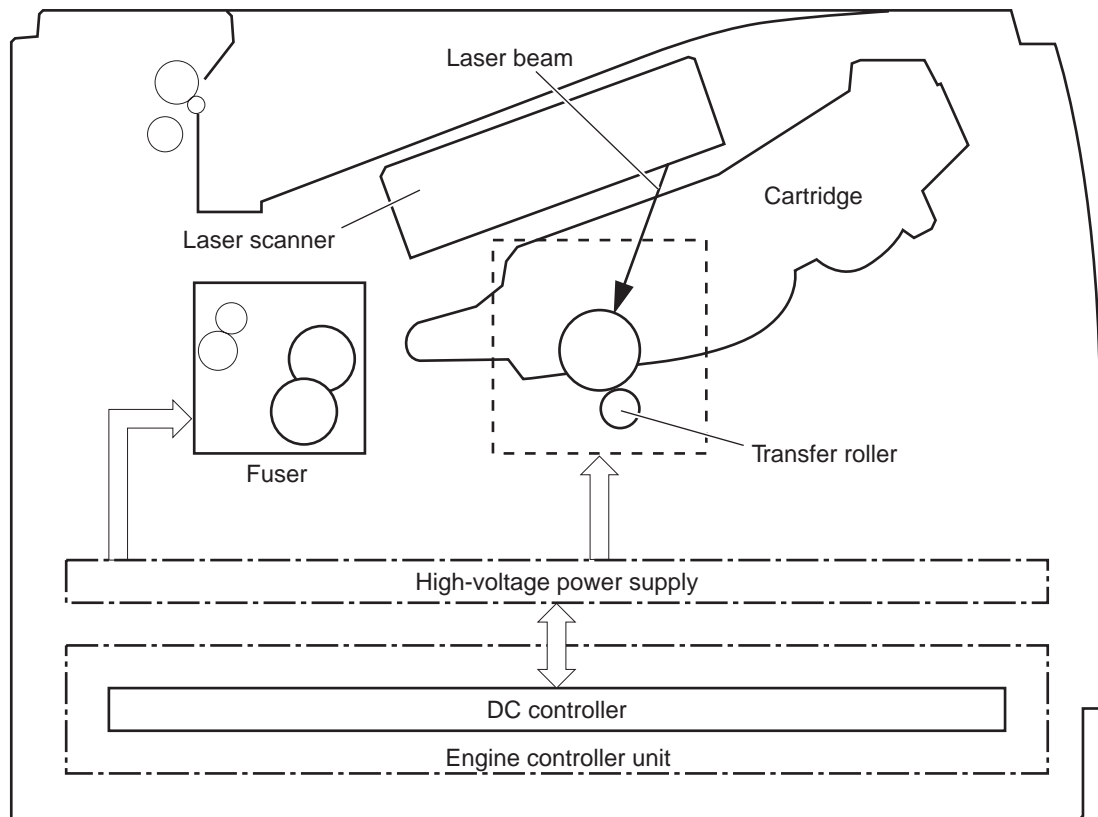
## Electrophotographic process

The electrophotographic process forms an image on the paper. Following are the major components used in the process:

- Print cartridge
- Transfer roller
- Fuser
- Laser/scanner

The DC controller uses the laser/scanner and HVPS to form the toner image on the photosensitive drum. The image is transferred to the print media and then fused onto the paper.

**Figure 1-16** Electrophotographic process block diagram

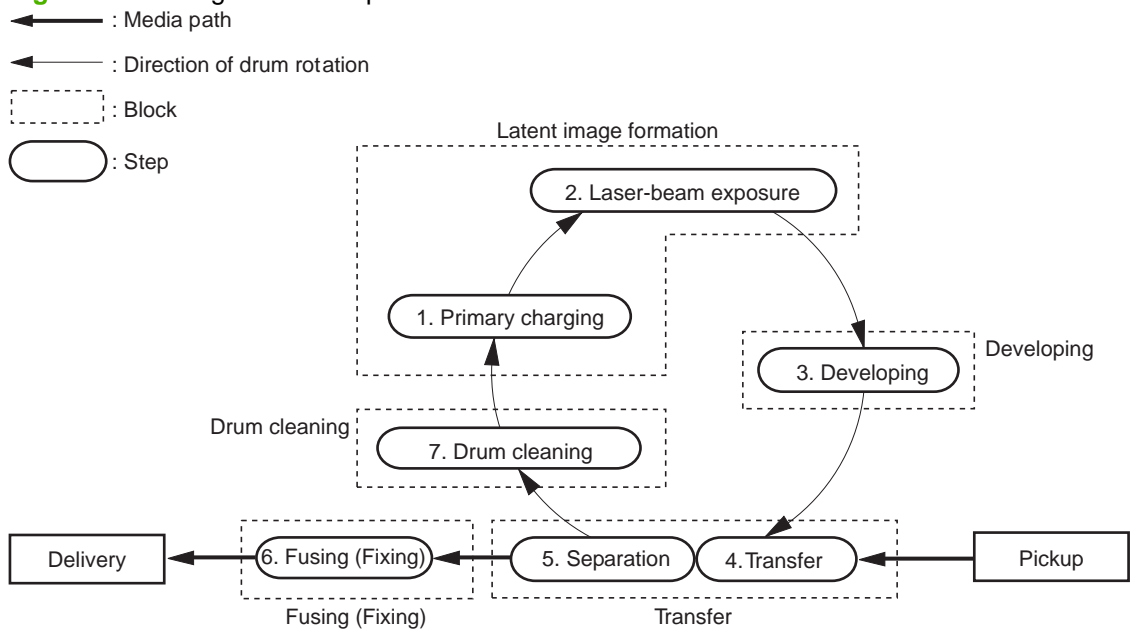


## Image formation process

Each of the following process function independently and must be coordinated with the other product processes. Image formation consists of the following processes:

- Latent-image formation block
  - Step 1: primary charging
  - Step 2: laser-beam exposure
- Developing block
  - Step 3: developing
- Transfer block
  - Step 4: transfer
  - Step 5: separation
- Fusing block
  - Step 6: fusing
- Drum cleaning block
  - Step 7: drum cleaning

**Figure 1-17** Image formation process



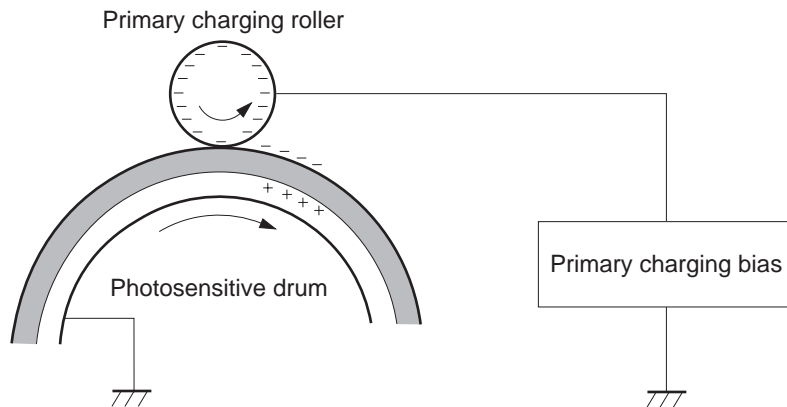
## Latent-image formation stage

During the latent-image formation stage, the laser/scanner forms an invisible image on the photosensitive drum in the print cartridge.

### Primary charging

**Step 1:** DC and AC biases are applied to the primary charging roller, which transfers a uniform negative potential to the photosensitive drum.

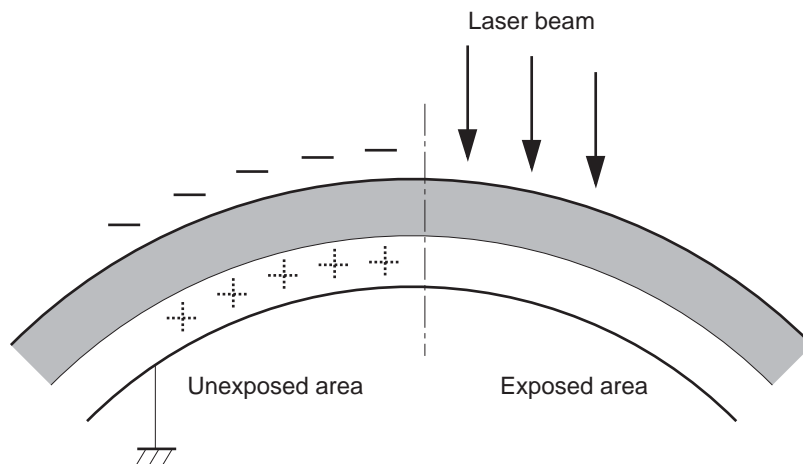
**Figure 1-18** Primary charging



### Laser beam exposure

**Step 2:** The laser beam scans the photosensitive drum to neutralize negative charges on parts of the drum surface. An electrostatic latent image is formed on the drum where negative charges were neutralized.

**Figure 1-19** Laser beam exposure

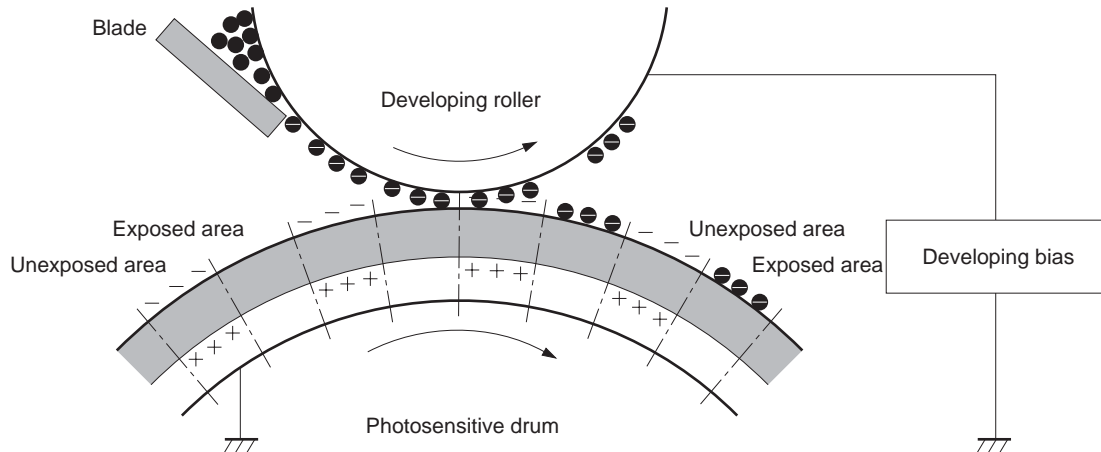


## Developing stage

### Print cartridge

**Step 3:** In the print cartridge, the developing cylinder comes in contact with the photosensitive drum to deposit toner onto the electrostatic latent image.

**Figure 1-20** Print cartridge

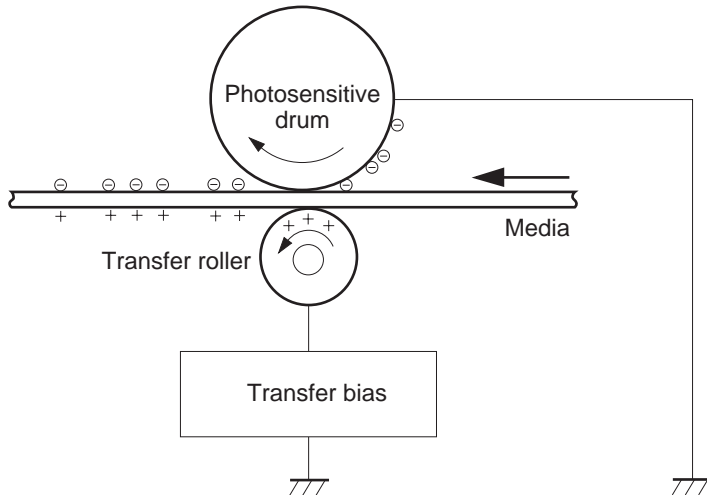


Toner acquires a negative charge from the friction that occurs when the developing roller rotates against the developing blade. The developing bias is applied to the developing roller to make a potential difference between the developing roller and the photosensitive drum. The negatively charged toner is attracted to the latent image on the photosensitive drum because the drum surface has a higher potential.

## Transfer stage

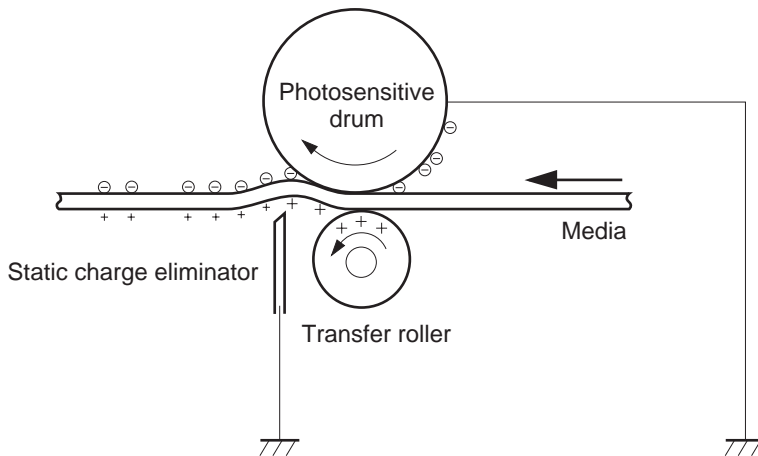
**Step 4:** The transfer charging roller, to which a DC positive bias is applied, imparts a positive charge on the print media. When the print media comes in contact with the photosensitive drum, the toner is transferred to the print media.

**Figure 1-21** Transfer



**Step 5:** The elasticity of the print media causes its separation from the photosensitive drum. A static charge eliminator aids separation by weakening any electrostatic adhesion.

**Figure 1-22** Separation



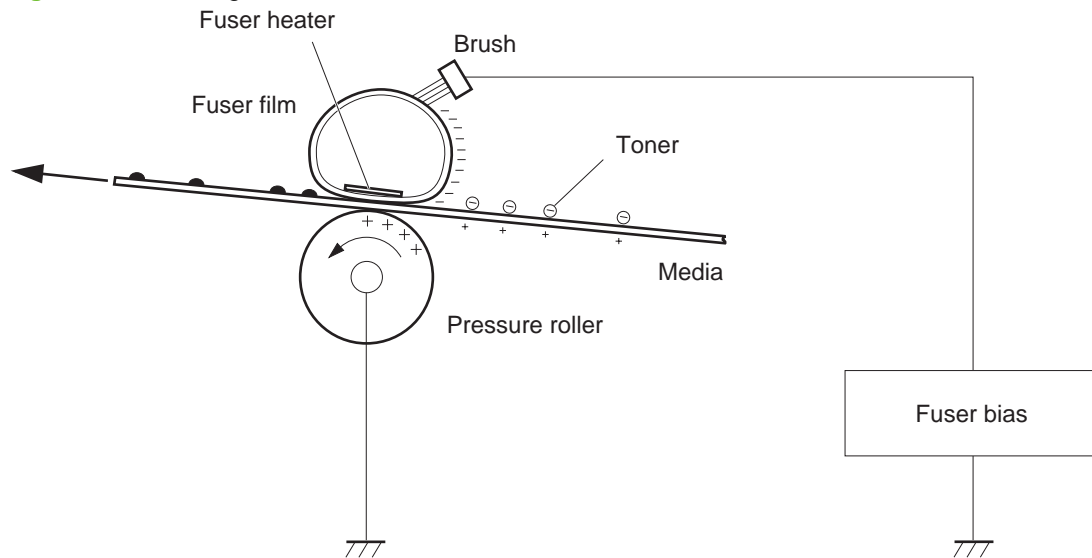
## Fusing stage

**Step 6:** The DC negative bias applied to the fusing film strengthens the holding force of the toner on the print media and prevents the toner from scattering.



The product uses an on-demand fuser method. The toner image is permanently affixed to the printing paper by heat and pressure.

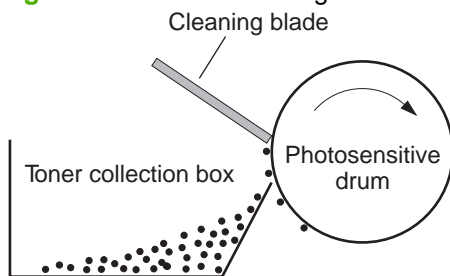
**Figure 1-23** Fusing



### Cleaning stage

**Step 7:** The cleaning blade scrapes the residual toner off of the photosensitive drum and deposits it into the waste toner case.

**Figure 1-24** Drum cleaning



## Toner detection

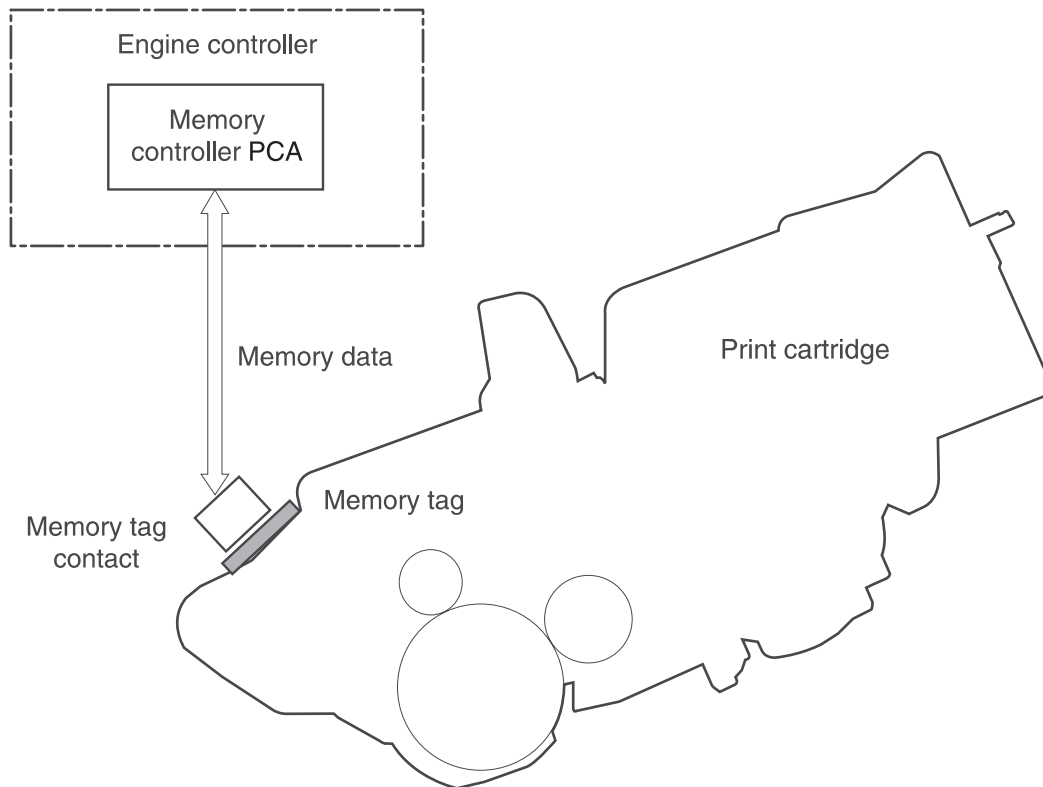
The product uses a nonvolatile memory tag built into the print cartridge. Print-cartridge detection happens when the engine controller detects the presence of a genuine HP print-cartridge that contains a memory tag. Toner detection happens as the engine controller reads or writes the data that is stored on the memory tag. The engine controller renews the information in the prescribed timing and reads or writes it from or to the memory tag.

The engine controller commands the memory tag to read or write with the following conditions:

- **Read**
  - Power is on
  - The cartridge door is closed
  - A command is received from the formatter
- **Write**
  - A page of media is printed
  - A command is received from the formatter

When the engine controller fails to read or write three times in a row, it determines that the memory tag is abnormal and sends a cartridge memory abnormality warning to the formatter.

**Figure 1-25** Print cartridge memory tag



## Pickup, feed, and delivery system

The pickup/feed/delivery system consists of several types of feed rollers and sensors. The ECU uses a motor and two solenoids to drive the rollers. Three media-detection sensors detect paper as it passes through the product. If media does not reach or pass each sensor within a specified time, the ECU determines that a jam has occurred and alerts the formatter.

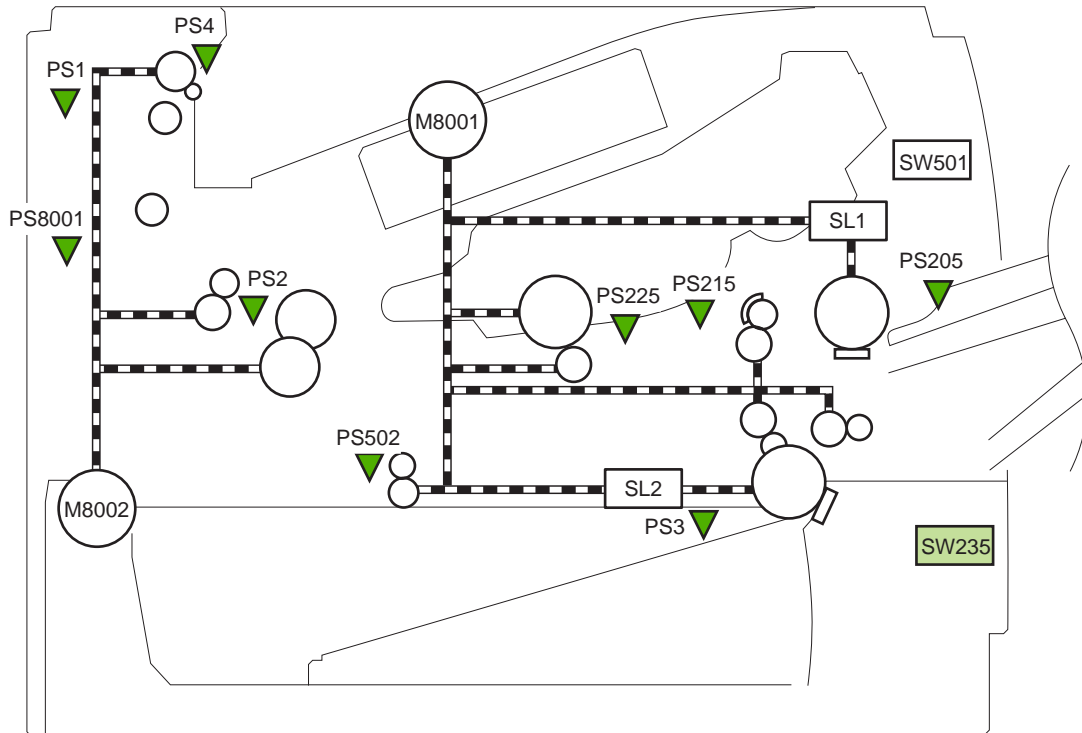
### Paper trays

The product has the following paper trays:

- Tray 1 (multipurpose tray; all models)
- Tray 2 (500-sheet tray; all models)
- Tray 3 (optional 500-sheet input tray; HP LaserJet P3015x)
- Tray 4 (optional 500-sheet input tray)

## Photo sensors and switches

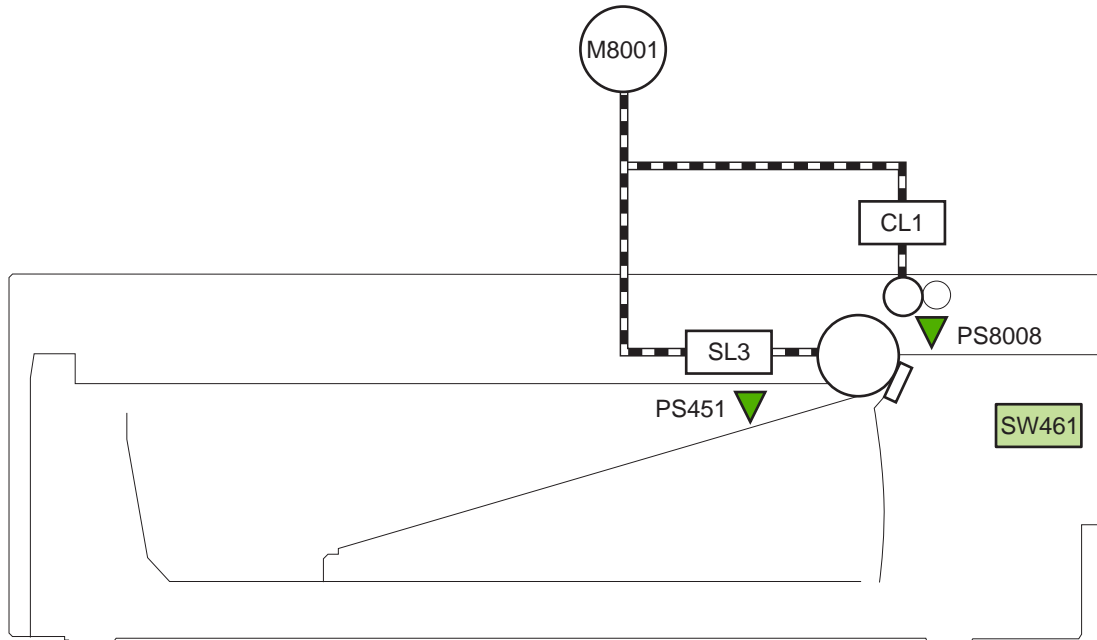
**Figure 1-26** Photo sensors and switches (product)



**Table 1-10** Photo sensors and switches (product)

Item	Description	Item	Description
PS1	Face-up sensor	PS215	Top-of-Page (TOP) sensor
PS2	Fuser delivery sensor	PS225	Media width sensor
PS3	Cassette media-presence sensor	PS502	Duplex media-feed sensor (duplex models only)
PS4	Face-down tray media-full sensor	PS8001	Rear door sensor
PS205	Tray 1 (MP tray) media-presence sensor	SW235	Cassette presence sensor

**Figure 1-27** Photo sensors and switches (Tray 3 and Tray 4)



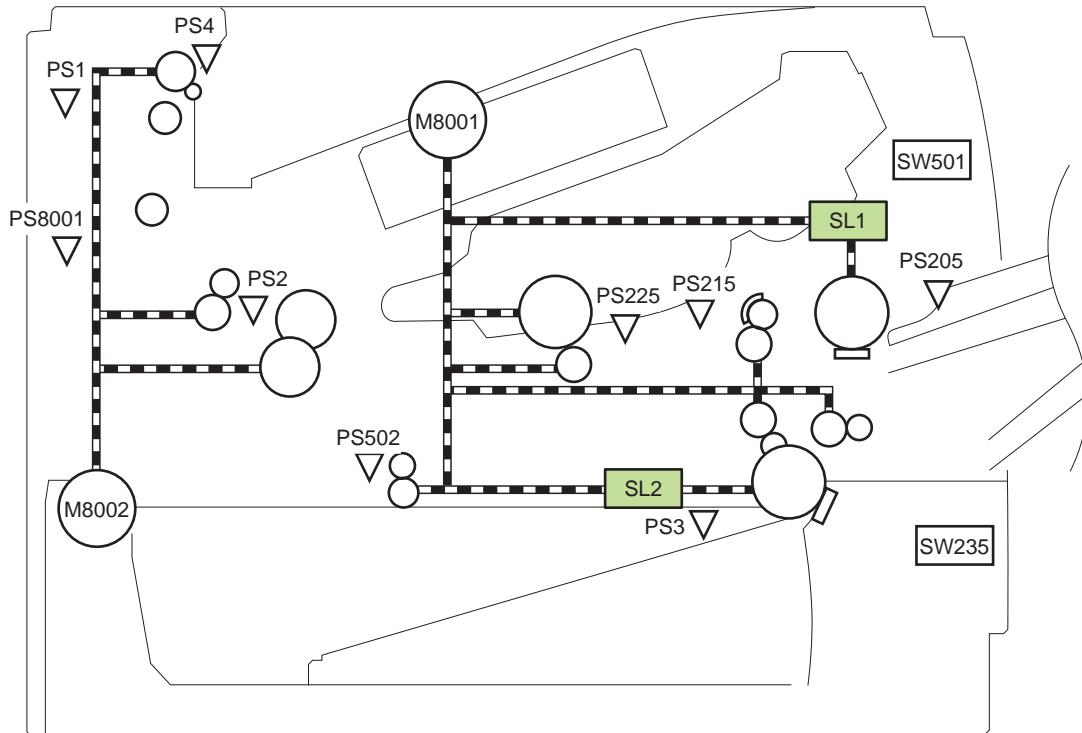
**Table 1-11** Photo sensors and switches (Tray 3 and Tray 4)

Item	Description
PS451	Paper feeder cassette-media presence sensor
PS8008	Paper feeder media-feed sensor
SW461	Paper feeder cassette presence switch

<sup>1</sup> Tray 3 and Tray 4 are identical 500-sheet input trays.

## Solenoids and clutches

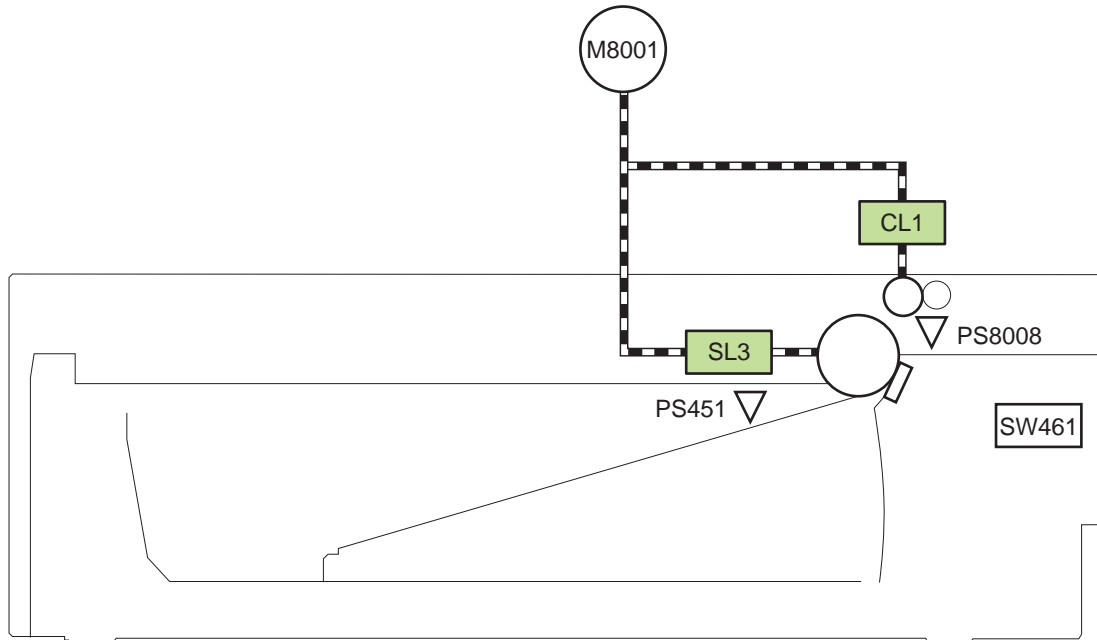
**Figure 1-28** Solenoids and clutches (product)



**Table 1-12** Solenoids and clutches (product)

Item	Description
SL1	Tray 1 (multipurpose tray) pickup solenoid
SL2	Cassette (Tray 2) pickup solenoid

**Figure 1-29** Solenoids and clutches (Tray 3 and Tray 4)



**Table 1-13** Solenoids and clutches (Tray 3 and Tray 4)

Item	Description
SL3	Paper feeder pickup solenoid
CL1	Paper feeder pickup clutch

<sup>1</sup> Tray 3 and Tray 4 are identical 500-sheet input trays.


# Tray 1 or Tray 2

## Pickup and feed unit

The pickup and feed unit uses the following components and processes.

### Cassette paper size detection/cassette paper detection

---


 **NOTE:** To find the following components, see [Photo sensors and switches on page 34](#).

---

- PS3; cassette media-presence sensor
- PS225; media width sensor (detects media width *after* the media enters the paper path)

### Cassette pickup

---

 **NOTE:** To find the following components, see [Solenoids and clutches on page 36](#).

---

- SL2; cassette (Tray 2) pickup solenoid

### Tray 1 paper pickup

---

 **NOTE:** To find the following components, see [Photo sensors and switches on page 34](#) and [Solenoids and clutches on page 36](#).

---

- PS205; Tray 1 (multipurpose tray) media-presence sensor
- SL1; Tray 1 (multipurpose tray) pickup solenoid

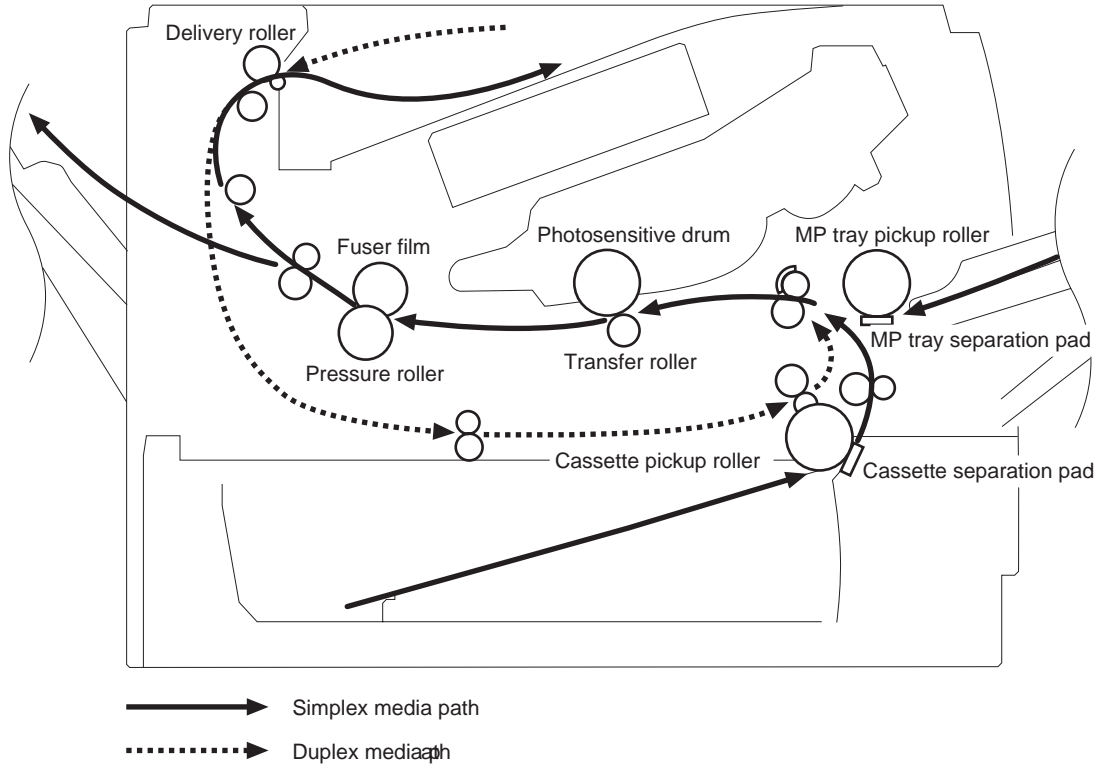


## Paper pickup and feed

The following figure shows the pickup and feed paper path.

 **NOTE:** Duplex models include a duplex media-feed path for automatic two-sided printing.


**Figure 1-30** Pickup, feed, and delivery block diagram



## Jam detection

The product uses the following sensors to detect the presence of media and to check for jams. If media does not reach or pass each sensor within a specified time, the ECU determines that a jam has occurred and alerts the formatter.

---

 **NOTE:** To find the following components, see [Photo sensors and switches on page 34](#).

---

- PS2; fuser delivery sensor
- PS4; face-down tray media-full sensor
- PS215; Top-of-Page (TOP) sensor
- PS225; media width sensor
- PS502; duplex media-feed sensor (duplex models only)
- PS8008; paper feeder media-feed sensor

---

 **NOTE:** PS8008 is used in Tray 3 and Tray 4.

---

The product detects the following jams:

- Pickup delay jam
- Pickup stationary jam
- Delivery delay jam
- Delivery stationary jam
- Fuser wrapping jam
- Door open jam
- Residual media jam
- Duplex repickup jam (duplex models only)

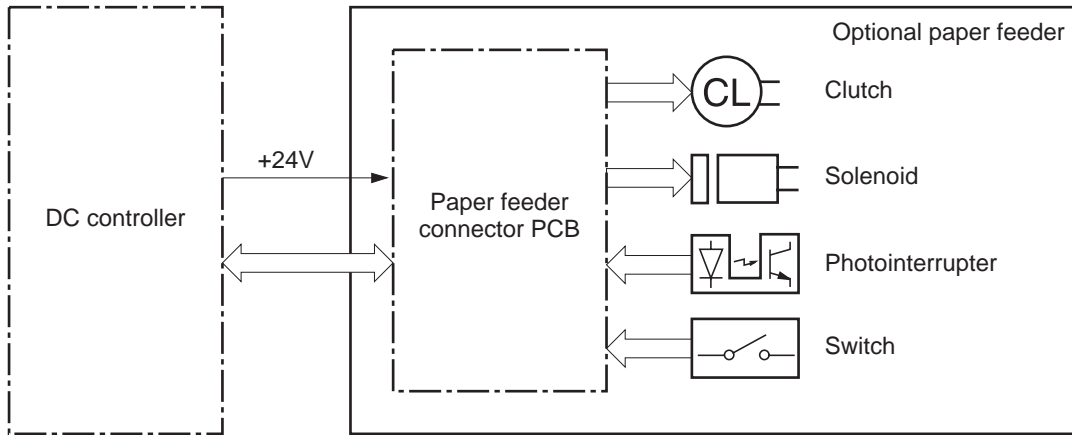
# Additional tray

**NOTE:** This product supports identical 500-sheet input trays (Tray 3 and Tray 4).

## Tray driver PCA

The following figure shows the signals between the DC controller and the tray driver PCA.

**Figure 1-31** Tray 3 and Tray 4 driver PCA block diagram

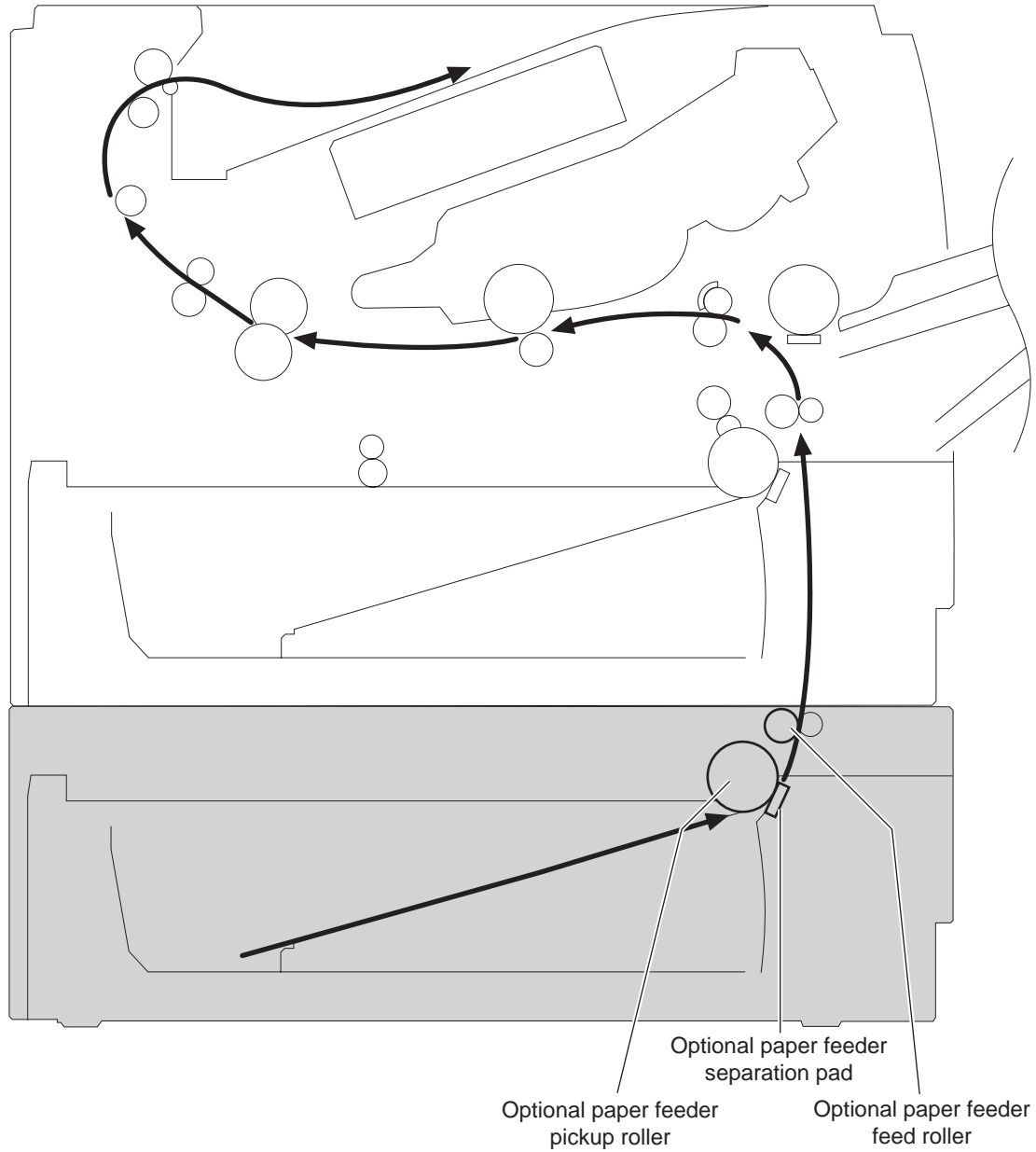


## Paper pickup and feed

**NOTE:** Tray 3 and Tray 4 are identical 500-sheet input trays.

The following figure shows the pickup and feed paper path (Tray 3 shown).


**Figure 1-32** Tray 3 and Tray 4 pickup, feed, and delivery block diagram



## Media level and size detection

- PS451; paper feeder media-presence sensor detects if media is present in the tray.

---

 **NOTE:** PS451 is used in Tray 3 and Tray 4.

---

- Media size is detected after the page enters the product. See [Cassette paper size detection/cassette paper detection on page 38](#).

## Jam detection

- PS8008; paper feeder media-feed sensor detects jams in the paper feeder.



---

## 2 Removal and replacement

- [Removal and replacement strategy](#)
- [Service approach](#)
- [Removal and replacement procedures](#)

# Removal and replacement strategy

## General cautions during removal and replacement

This chapter describes the removal and replacement of field-replaceable units (FRUs) only.

Replacing FRUs is generally the reverse of removal. Occasionally, notes and tips are included to provide directions for difficult or critical replacement procedures.

HP does *not* support repairing individual subassemblies or troubleshooting to the component level.

- ⚠ **WARNING!** Turn the product off, wait 5 seconds, and then remove the power cord before attempting to service the product. If this warning is not followed, severe injury can result, in addition to damage to the product. The power must be on for certain functional checks during troubleshooting. However, disconnect the power supply during parts removal.

Never operate or service the product with the protective cover removed from the laser/scanner assembly. The reflected beam, although invisible, can damage your eyes.

The sheet-metal parts can have sharp edges. Be careful when handling sheet-metal parts.

- ⚠ **CAUTION:** Do not bend or fold the flat flexible cables (FFCs) during removal or installation. Also, do not straighten prefolds in the FFCs. You *must* fully seat all FFCs in their connectors. Failure to fully seat an FFC into a connector can cause a short circuit in a PCA.


Incorrectly routed or loose wire harnesses can interfere with other internal components and can become damaged or broken. Frayed or pinched harness wires can be difficult to find. When replacing wire harnesses, always use the provided wire loops, lance points, or wire-harness guides and retainers.

- 📝 **NOTE:** To install a self-tapping screw, first turn it counterclockwise to align it with the thread pattern, and then carefully turn it clockwise to tighten. Do not overtighten. If a self-tapping screw-hole becomes stripped, repair the screw-hole or replace the affected assembly.

Note the length, diameter, color, type, and location of each screw. Be sure to return each screw to its original location during reassembly.

- 💡 **TIP:** For clarity, some photos in this chapter might show components removed that would not be removed to service the product. If necessary, remove the components listed at the beginning of a procedure before proceeding to service the product.

## Electrostatic discharge

- ⚠ **CAUTION:**  Some parts are sensitive to electrostatic discharge (ESD). Look for the ESD reminder when removing product parts. Always perform service work at an ESD-protected workstation or mat, or use an ESD strap. If an ESD workstation, mat, or strap is not available, ground yourself by touching the sheet-metal chassis *before* touching an ESD-sensitive part.

Protect the ESD-sensitive parts by placing them in ESD pouches when they are out of the product.

## Required tools

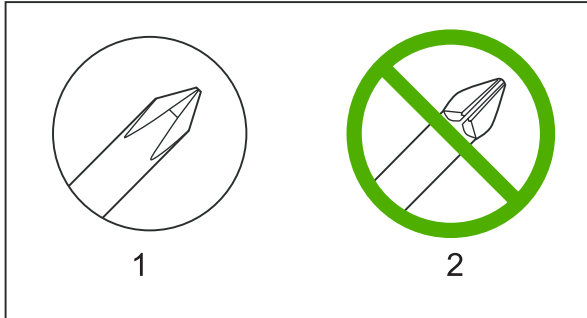
- #2 Phillips 152 mm (6 in) screwdriver with magnetic tip
- #2 Phillips 76 mm (3 in) screwdriver with magnetic tip
- Small flat blade screwdriver



- Small needle-nose pliers
- ESD mat
- Penlight

△ **CAUTION:** Always use a Phillips screwdriver (callout 1). Do not use a pozidrive screwdriver (callout 2) or any motorized screwdriver. These can damage screws or screw threads.

**Figure 2-1** Phillips and pozidrive screwdriver comparison



## Types of screws




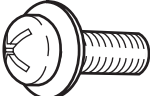
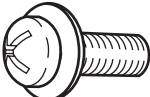
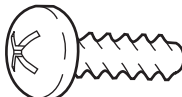
 **NOTE:** The illustration in this section are for reference only. The screws in your product might look slightly different.

Illustration	Description	Size	Part number	Use
	Screw with washer	M3X6	XB2-7300-000CN	Used to secure metal components to metal components (for example, a ground wire to the frame)
	Screw, tapping	M3X6	XA9-1503-000CN	
	Screw	D-M3X6	XA9-1671-000CN	
	Screw	P-M3X8	XB4-5300-807CN	
	Screw, tapping, truss head	M4X10	XB4-7401-005CN	Used to secure anything to plastic

6 mm    8 mm    10 mm    M 3    M 4  
    

## Service approach

Product repair normally begins by using the product internal diagnostics and the following two-step process:

1. Isolate the problem to the major system (for example, the network or server, or the product).
2. Troubleshoot the problem by using the procedures in chapter 6.

After you find a faulty part, the product can usually be repaired at the assembly level by replacing field-replaceable units (FRUs). Some mechanical assemblies might need to be repaired at the subassembly level.

## Before performing service

- Remove all media from the product.
- Turn off the power using the power switch.
- Unplug the power cable and interface cable or cables.
- Place the product on an ESD workstation or mat, or use an ESD strap (if one is available). If an ESD workstation, mat, or strap is not available, ground yourself by touching the sheet-metal chassis *before* touching an ESD-sensitive part.
- Remove the print cartridges. See [Print cartridge on page 52](#).
- Remove the tray cassette or cassettes. See [Tray cassette \(Tray 2, Tray 3, or Tray 4\) on page 54](#).

## After performing service

- Plug in the power cable.
- Reinstall the print cartridges.
- Reinstall the tray cassette or cassettes.
- If an optional paper feeder was installed, place the product on the feeder.

## Post-service test

Perform the following test to verify that the repair or replacement was successful.

### Print-quality test

1. Verify that you have completed the necessary reassembly steps.
2. Make sure that the tray contains clean, unmarked paper.
3. Attach the power cord and interface cable or interface cables, and then turn on the product.
4. Verify that the expected start-up sounds occur.
5. Print a configuration page, and then verify that the expected printing sounds occur.
6. Print a demo page, and then verify that the print quality is as expected.

7. Send a print job from the host computer, and then verify that the output meets expectations.
8. If necessary, restore any customer-specified settings.
9. Clean the outside of the product with a damp cloth.

# Parts removal order

Figure 2-2 Parts removal order (1 of 2)

Component	Remove	Remove	Remove	Remove	Remove	Remove
Print cartridges						
Tray cassette (Tray 2, Tray 3, or Tray 4)						
Sub cover						
DIMM cover and DIMM						
Formatter cover and formatter PCA	DIMM cover					
Rear-door assembly						
Left Cover	Rear-door assembly					
Right-rear cover						
Tray 1 (multipurpose tray) cover	Rear-door assembly	Left Cover				
Cartridge door assembly	Rear-door assembly	Left Cover	Tray 1 cover			
Top-right cover	DIMM cover	Formatter cover				
Control panel	DIMM cover	Formatter cover				
Front-right and right-side cover assembly	DIMM cover	Formatter cover	Top-cover assembly			
Lower-right cover and bracket	DIMM cover	Formatter cover	Control panel	Front-right and right-side cover assembly		
Top cover	DIMM cover	Formatter cover	Rear-door assembly	Left Cover	Top-right cover	Control panel
Tray 1 (multipurpose tray) pickup roller						
Tray 1 (multipurpose tray) separation pad						
Tray 2, Tray 3, or Tray 4 pickup roller						
Tray 2, Tray 3, or Tray 4 separation pad						
Tray 2, Tray 3, or Tray 4 base-plate roller assembly						
Transfer roller						
USB port PCA	DIMM cover	Formatter cover	Top-right cover	Control panel	Front-right and right-side cover assembly	
Power-switch assembly	DIMM cover	Formatter cover	Top-right cover	Control panel	Front-right and right-side cover assembly	
Main Fan, fan duct, and environmental sensor	DIMM cover	Formatter cover	Top-right cover	Control panel	Front-right and right-side cover assembly	
Fuser	Rear-door assembly	Right-rear cover				
Registration assembly	Rear-door assembly	Left Cover				
Duplex media-feed guide	Rear-door assembly	Right-rear cover				
Laser/scanner assembly	DIMM cover	Formatter cover	Rear-door assembly	Left Cover	Top-right cover	Control panel
Engine control unit (ECU)	DIMM cover	Formatter cover	Rear-door assembly	Left Cover	Top-right cover	Control panel
Cassette pickup (Tray 2) solenoid or Tray 1 (multipurpose tray) pickup solenoid	DIMM cover	Formatter cover	Rear-door assembly	Left Cover	Top-right cover	Control panel
Pickup assembly	DIMM cover	Formatter cover	Rear-door assembly	Left Cover	Top-right cover	Control panel
Fuser motor	DIMM cover	Formatter cover	Rear-door assembly	Left Cover	Top-right cover	Control panel
Sub fan and fan duct	DIMM cover	Formatter cover	Rear-door assembly	Left Cover	Top-right cover	Control panel
High-voltage power supply	DIMM cover	Formatter cover	Rear-door assembly	Left Cover	Top-right cover	Control panel

**Figure 2-3** Parts removal order (2 of 2)

<u>Remove</u>	<u>Remove</u>	<u>Remove</u>	<u>Remove</u>	<u>Remove</u>	<u>Remove</u>	<u>Remove</u>
Top cover						
Front-right and right-side cover assembly	Lower-right cover and bracket	Top cover	Power-switch assembly			
Front-right and right-side cover assembly	Lower-right cover and bracket	Top cover	Power-switch assembly	Engine control unit (ECU)		
Front-right and right-side cover assembly	Lower-right cover and bracket	Top cover	Power-switch assembly	Engine control unit (ECU)		
Front-right and right-side cover assembly	Lower-right cover and bracket	Top cover	Power-switch assembly	Engine control unit (ECU)		
Front-right and right-side cover assembly	Lower-right cover and bracket	Top cover	Power-switch assembly	Engine control unit (ECU)		
Front-right and right-side cover assembly	Lower-right cover and bracket	Top cover	Power-switch assembly	Duplex media-feed guide (duplex models only)	Engine control unit (ECU)	Sub fan and fan duct

# Removal and replacement procedures

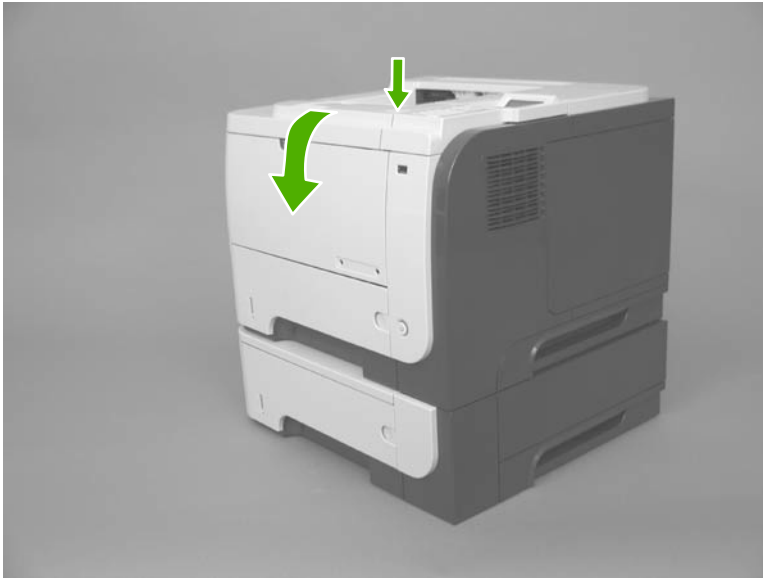
## Print cartridge, cassettes, and sub cover

### Print cartridge

△ **CAUTION:** If toner gets on your clothing, wipe it off with a dry cloth and wash clothing in cold water. *Hot water sets toner into fabric.*

1. Press the cartridge-door release button, and then open the cartridge door. Make sure that the door is completely open.

**Figure 2-4** Remove the print cartridge (1 of 2)

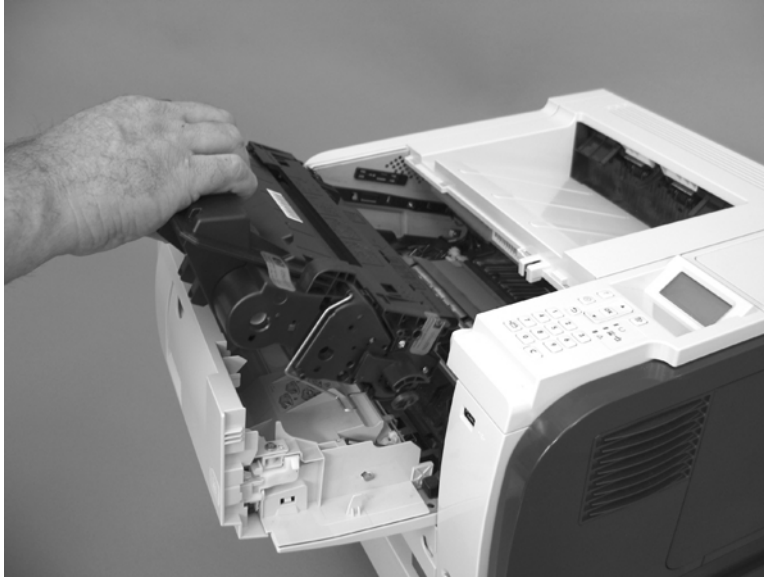


2. Grasp the print-cartridge handle and pull it out of the product.


△ **CAUTION:** Do not touch the green roller. Doing so can damage the cartridge. Do not expose the cartridge to strong light. Cover the cartridge with a sheet of paper to protect it from light.

💡 **Reinstallation tip** Align the print cartridge with its slot and insert the print cartridge until it clicks into place.

**Figure 2-5** Remove the print cartridge (2 of 2)



## Tray cassette (Tray 2, Tray 3, or Tray 4)

 **NOTE:** Use this procedure to remove the Tray 2 or optional Tray 3 or Tray 4 cassette.

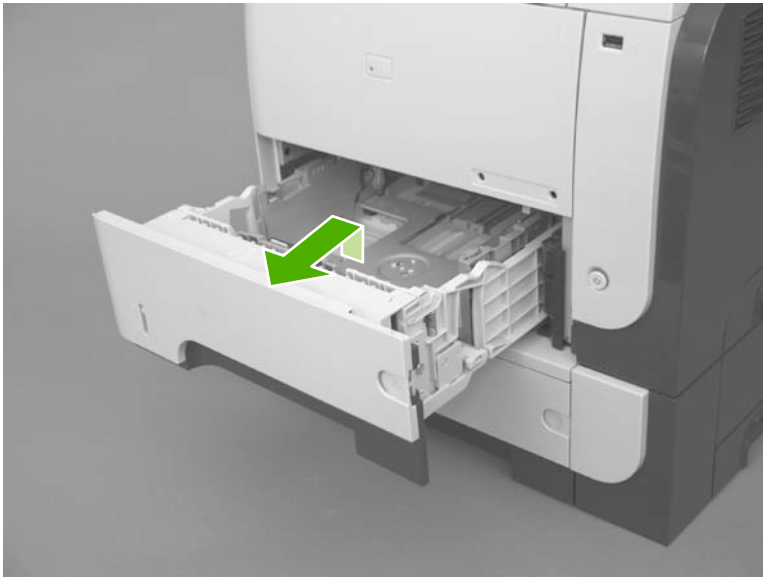
1. Pull the tray straight out of the product until it stops.

**Figure 2-6** Remove the tray cassette (1 of 2)




2. Carefully lift up on the tray to release it, and then remove the tray.

**Figure 2-7** Remove the tray cassette (2 of 2)






## Sub cover

 **NOTE:** Duplex models only. The space under the sub cover is used by third-party manufacturers to install optional devices for this product (for example, a security card reader).

Use a small flat blade screwdriver to carefully separate the sub cover from the product.

 **CAUTION:** There are two tabs along the each of the long edges of the cover that fasten the cover to the product. Do not break the tabs when the cover is removed.

**Figure 2-8** Remove the sub cover



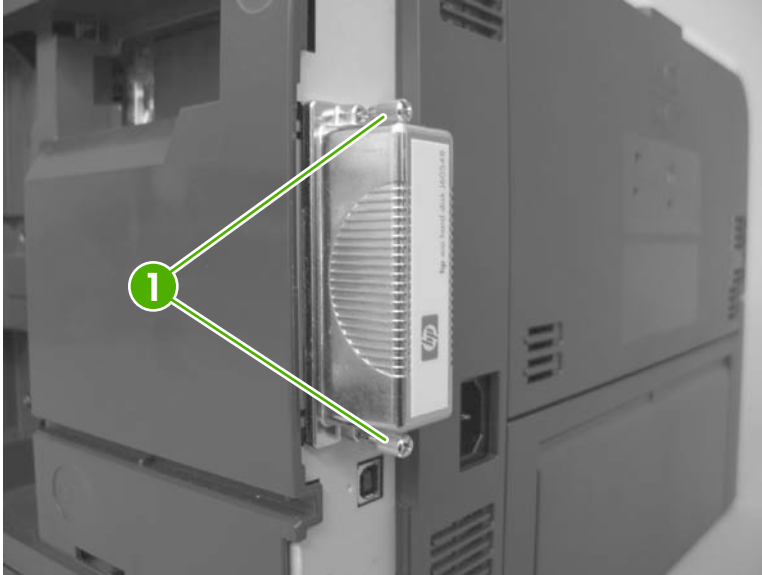
## External panels, covers, doors, formatter PCA, DIMM, and EIO disk

### EIO disk

⚠ **WARNING!**  ESD sensitive component.

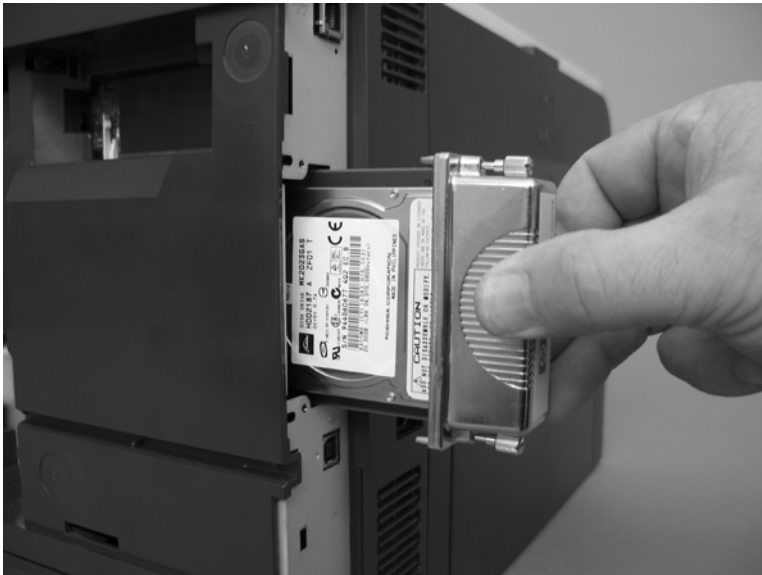
1. Loosen two thumb screws (callout 1).

**Figure 2-9** Remove the EIO disk (1 of 2)



2. Pull the EIO disk straight out of the product to remove it.

**Figure 2-10** Remove the EIO disk (2 of 2)

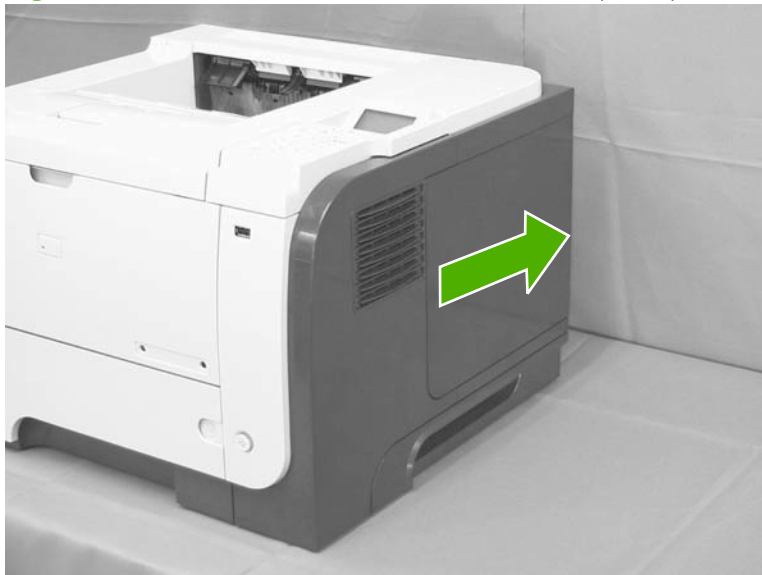


## DIMM cover and DIMM

 **WARNING!**  ESD sensitive component.

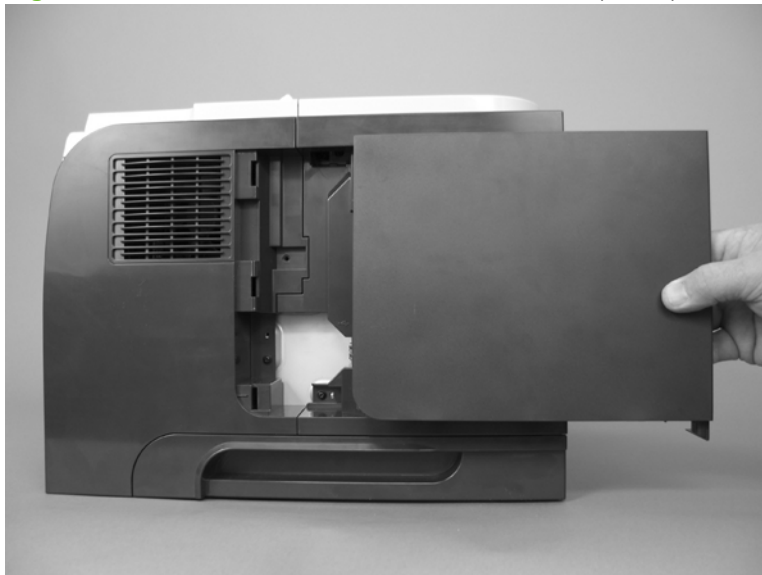
1. Slide the DIMM cover toward the back of the product to release it.

**Figure 2-11** Remove the DIMM cover and DIMM (1 of 3)



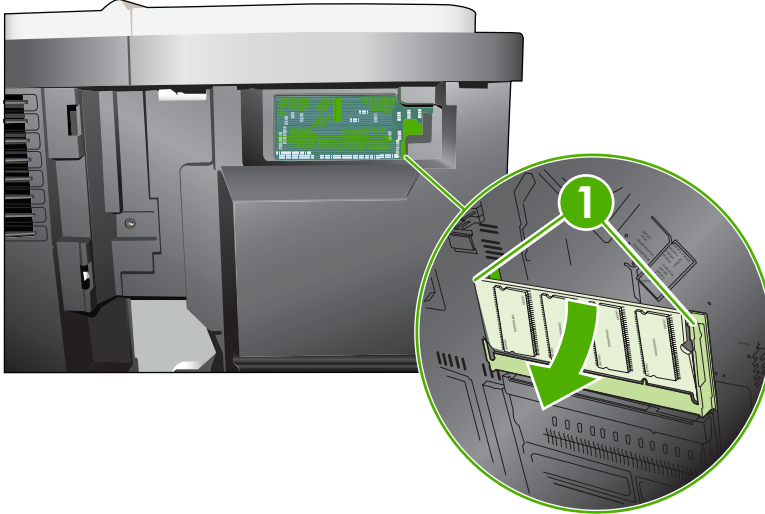
2. Lift the cover away from the product.

**Figure 2-12** Remove the DIMM cover and DIMM (2 of 3)



3. Release two tabs (callout 1) and rotate the top of the DIMM away from the formatter. Lift up on the DIMM to remove it.

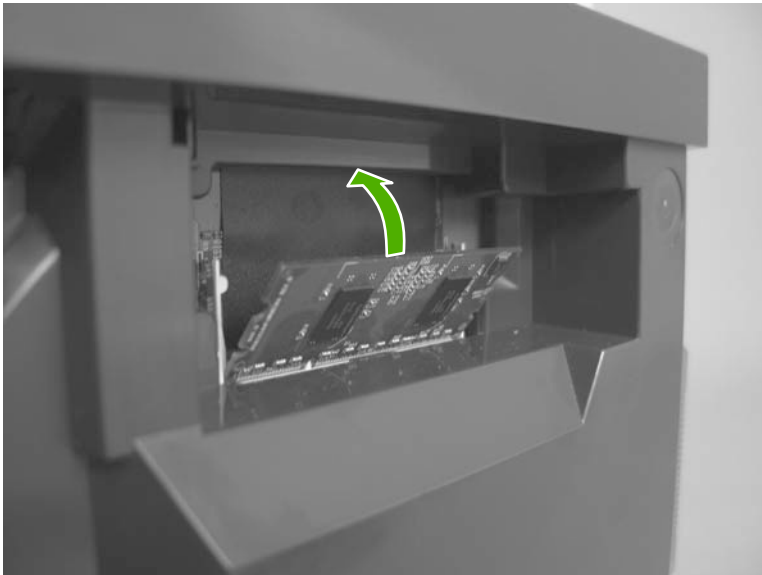
**Figure 2-13** Remove the DIMM cover and DIMM (3 of 3)



### Reinstall the DIMM

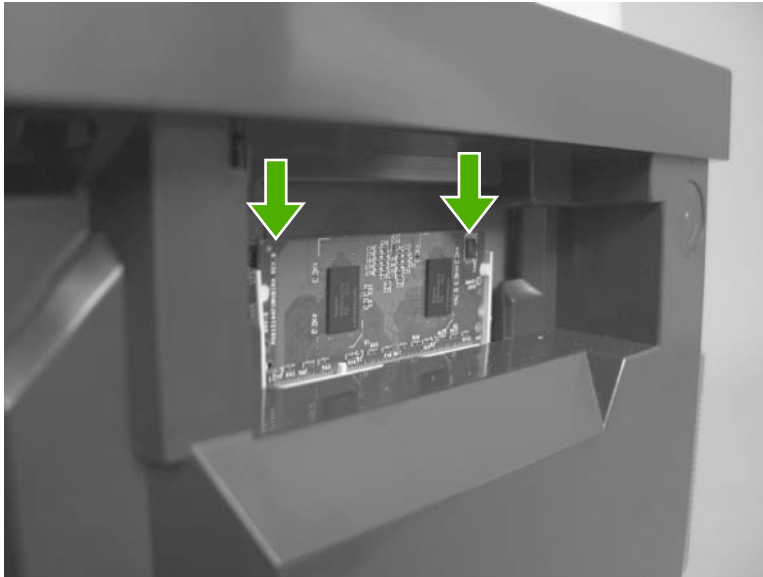
1. Position the DIMM at an angle to the DIMM slot, and rotate the top of the DIMM toward the formatter.

**Figure 2-14** Reinstall the DIMM (1 of 2)



2. Push down to seat it in the DIMM slot. The DIMM must snap into the locking tabs on the DIMM slot.

**Figure 2-15** Reinstall the DIMM (2 of 2)

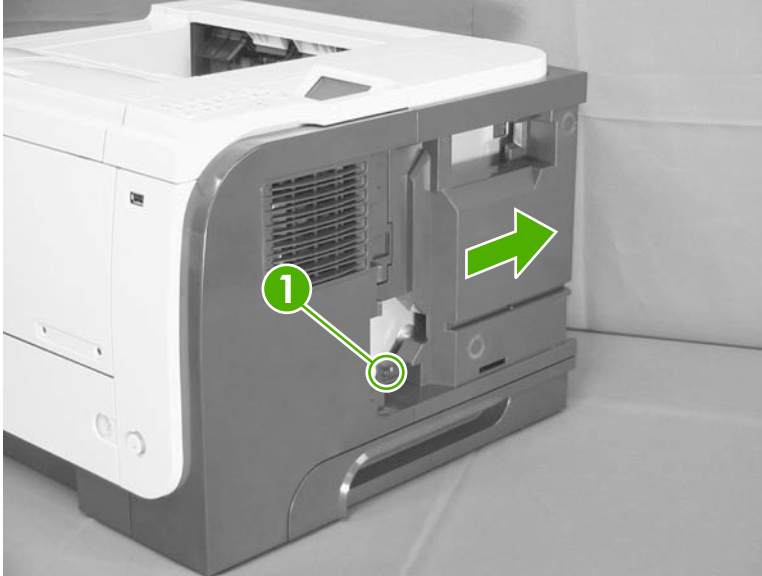


## Formatter cover and formatter PCA

 **WARNING!**  ESD sensitive component.

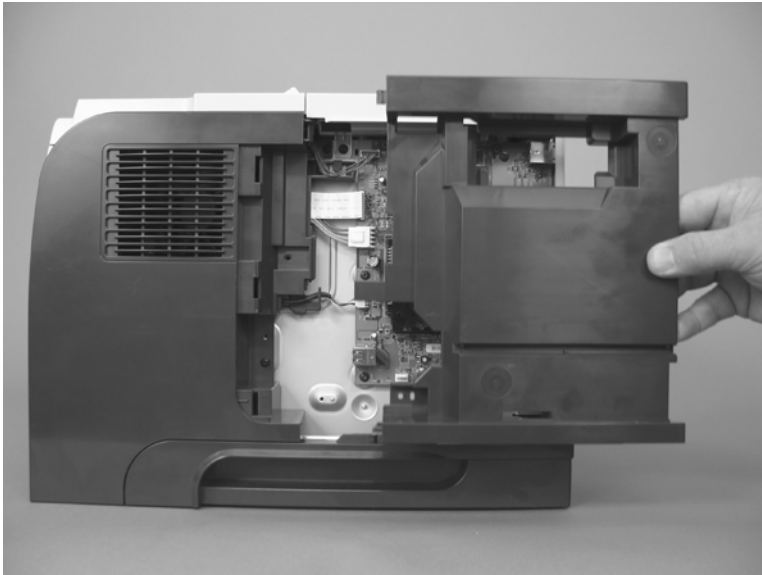
1. Remove the DIMM cover. See [DIMM cover and DIMM on page 57](#).
2. Remove one screw (callout 1), and then slide the formatter cover toward the back of the product to release it.

**Figure 2-16** Remove the formatter cover and formatter PCA (1 of 4)



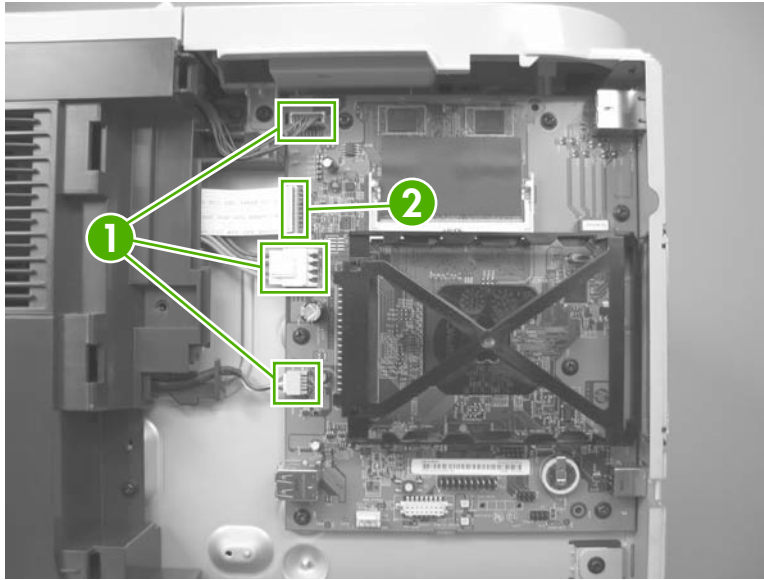
3. Lift the cover away from the product.

**Figure 2-17** Remove the formatter cover and formatter PCA (2 of 4)



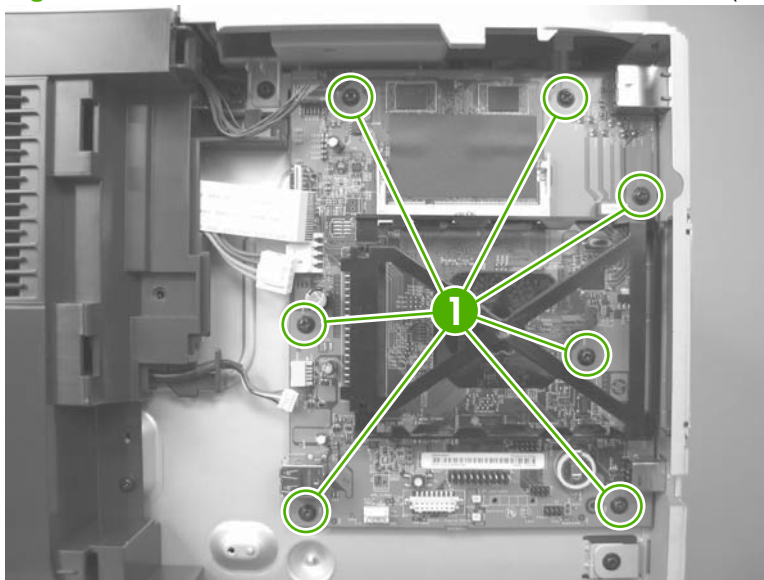
4. Disconnect three connectors (callout 1; J14, J17, and J16) and one FFC (callout 2; J18).

**Figure 2-18** Remove the formatter cover and formatter PCA (3 of 4)



5. Remove seven screws (callout 1), and then carefully remove the formatter PCA.

**Figure 2-19** Remove the formatter cover and formatter PCA (4 of 4)



## Rear-door assembly

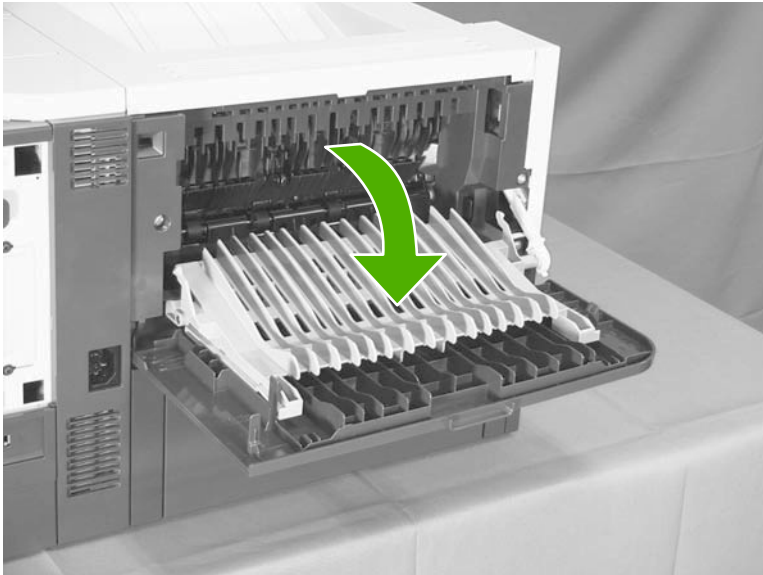
1. Open the rear door.

**Figure 2-20** Remove the rear-door assembly (1 of 8)



2. Gently pull down on the door and lower the door until it is fully open.

**Figure 2-21** Remove the rear-door assembly (2 of 8)

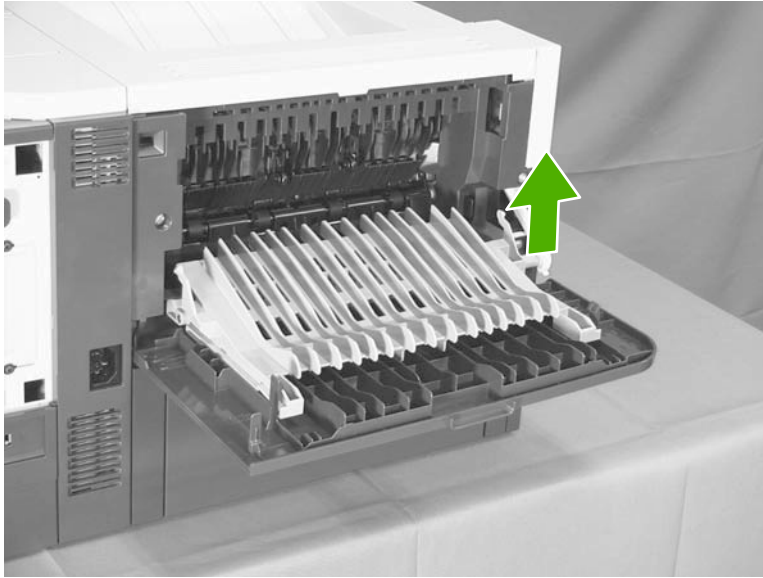




3. Push up on the link arm to release it.

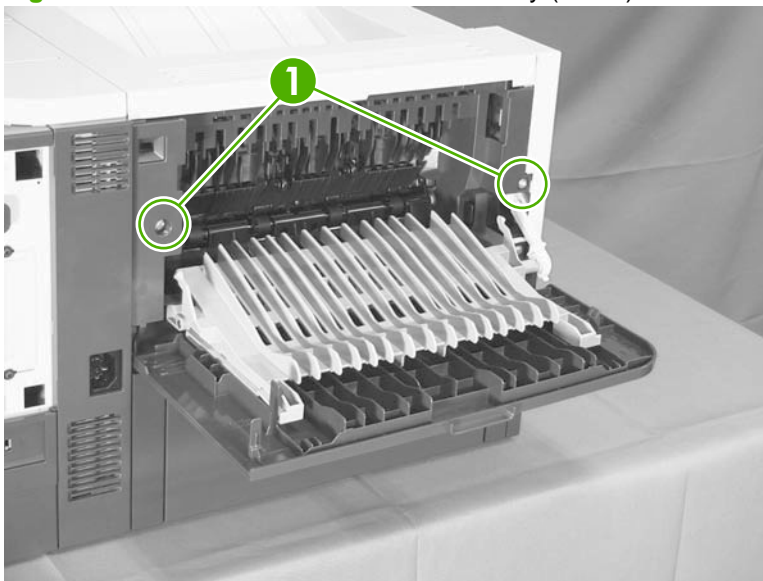
△ **CAUTION:** The link arm is under spring tension. Do not let the link arm snap back toward the product when you release it.

**Figure 2-22** Remove the rear-door assembly (3 of 8)



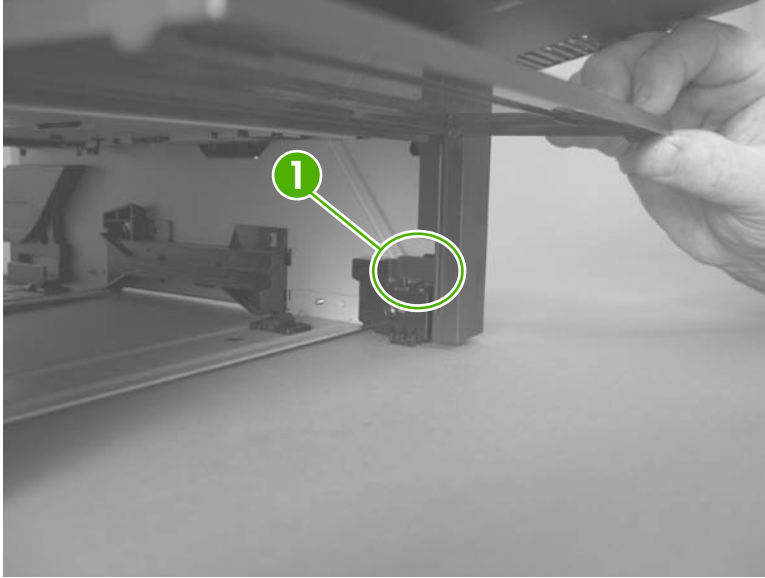
4. Remove two screws (callout 1).

**Figure 2-23** Remove the rear-door assembly (4 of 8)



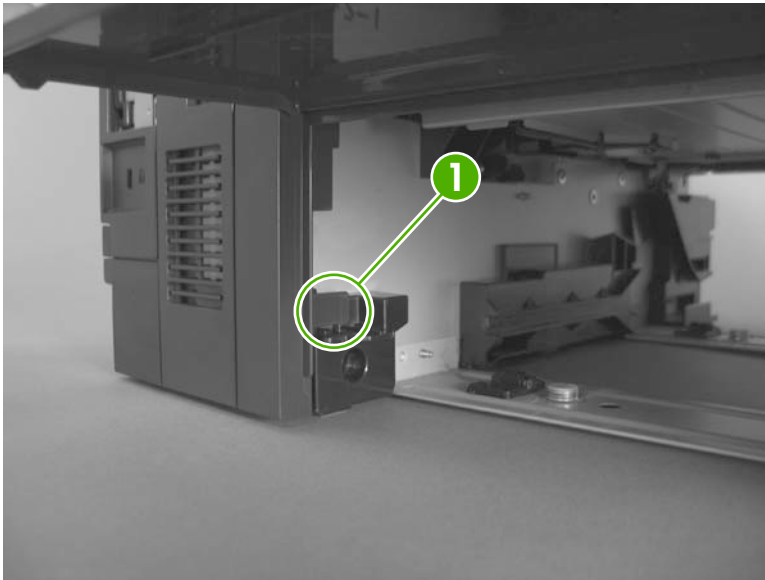
5. Open the lower-rear door, and then release one tab (callout 1).

**Figure 2-24** Remove the rear-door assembly (5 of 8)



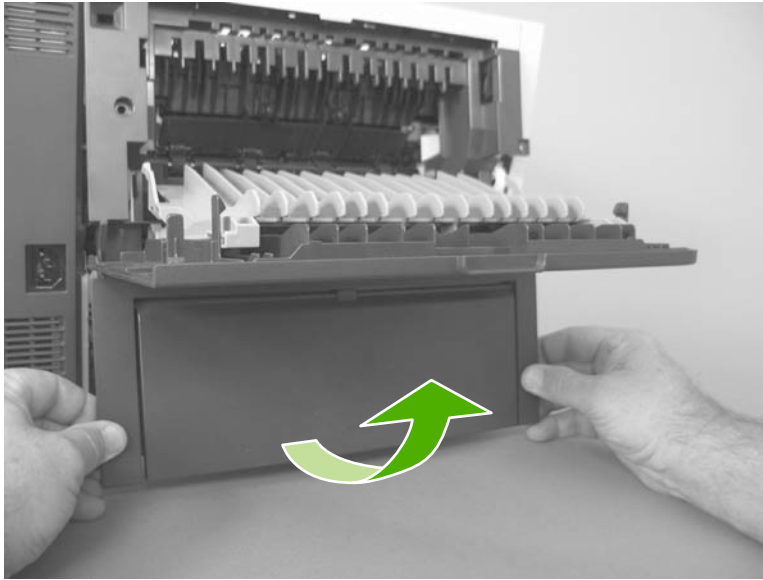
6. Release one tab (callout 1).

**Figure 2-25** Remove the rear-door assembly (6 of 8)



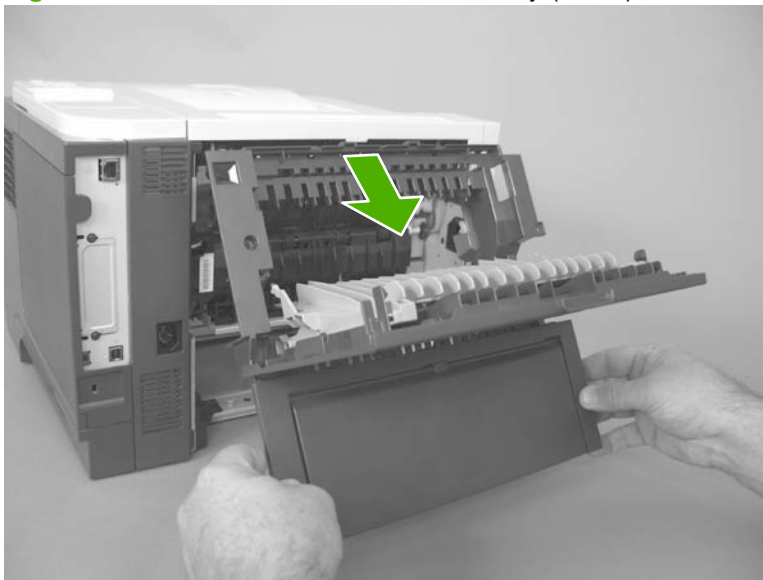
7. Rotate the bottom of the rear-door assembly away from the product.

**Figure 2-26** Remove the rear-door assembly (7 of 8)



8. Pull down on the rear-door assembly to remove it.

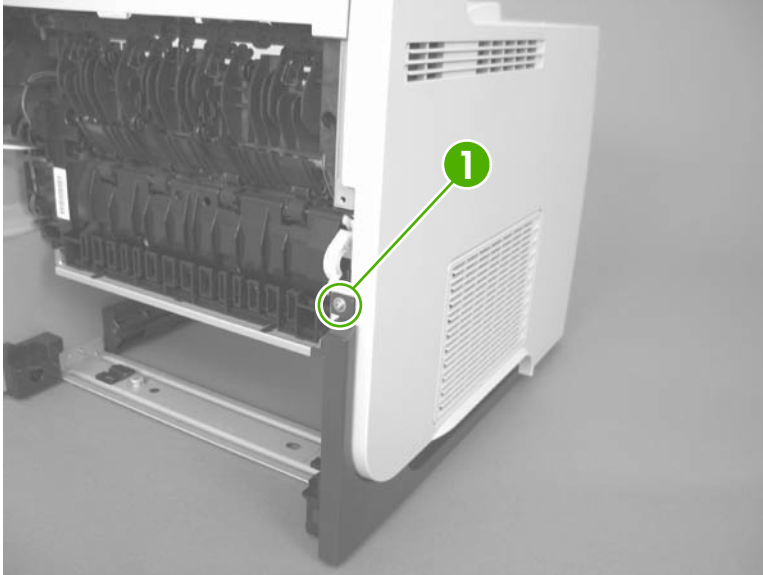
**Figure 2-27** Remove the rear-door assembly (8 of 8)




## Left cover

1. Remove the rear-door assembly. See [Rear-door assembly on page 62](#).
2. Remove one screw (callout 1).

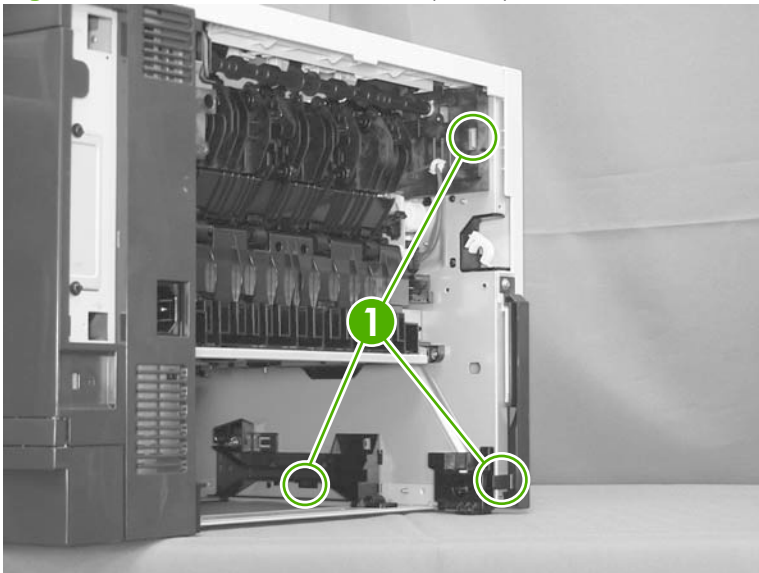
**Figure 2-28** Remove the left cover (1 of 4)



3. Release three tabs (callout 1).

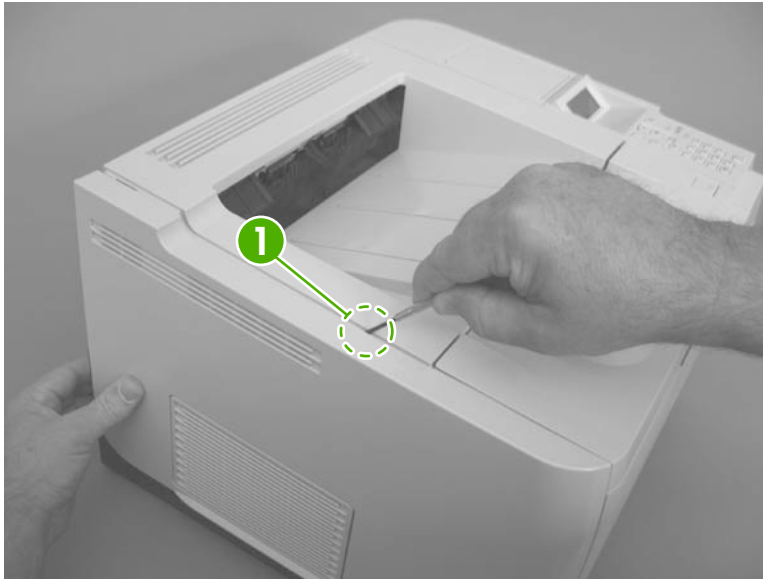
 **TIP:** The tab inside the cassette cavity is located below the plastic cassette rail. It might be easier if slightly lift up the left side of the product, and use a small flat blade screwdriver to release this tab.

**Figure 2-29** Remove the left cover (2 of 4)



4. Release one tab (callout 1).

**Figure 2-30** Remove the left cover (3 of 4)



5. Rotate the rear of the cover slightly away from the product, and then slide the cover toward the front of the product to remove it.

**Figure 2-31** Remove the left cover (4 of 4)



## Right-rear cover

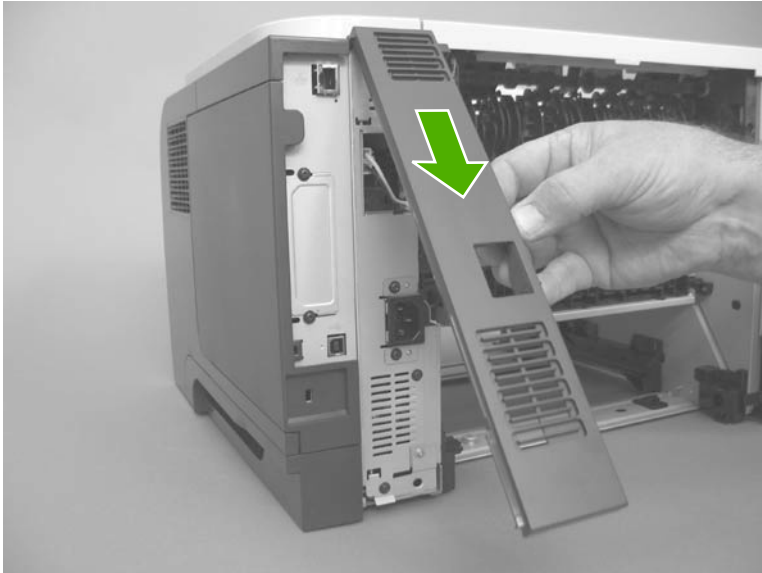
1. Remove the rear-door assembly. See [Rear-door assembly on page 62](#).
2. Slide the right-rear cover toward the inside of the product to release it.

**Figure 2-32** Remove the right-rear cover (1 of 2)



3. Rotate the bottom of the cover away from the product, and then pull down on the cover to remove it.

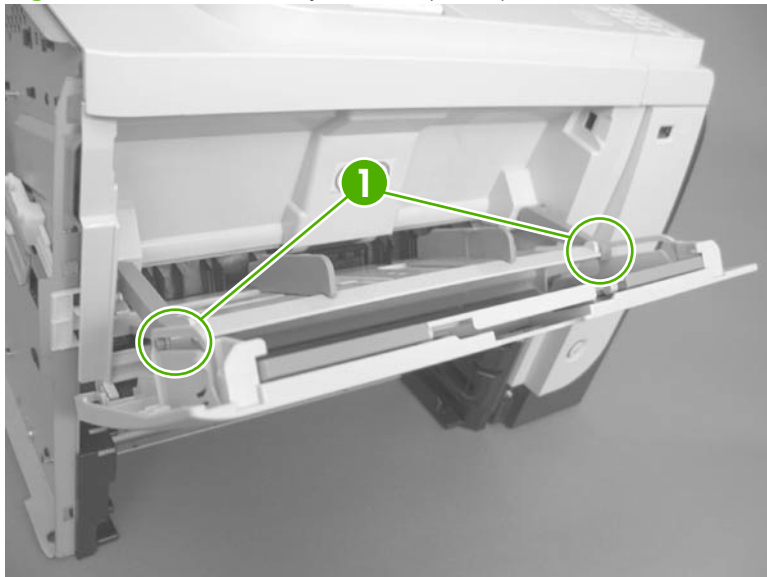
**Figure 2-33** Remove the right-rear cover (2 of 2)



## Tray 1 (multipurpose tray) cover


1. Before proceeding, remove the following components:
  - Rear-door assembly. See [Rear-door assembly on page 62](#).
  - Left cover. See [Left cover on page 66](#).
2. Carefully release two retaining arms (callout 1).

**Figure 2-34** Remove Tray 1 cover (1 of 3)



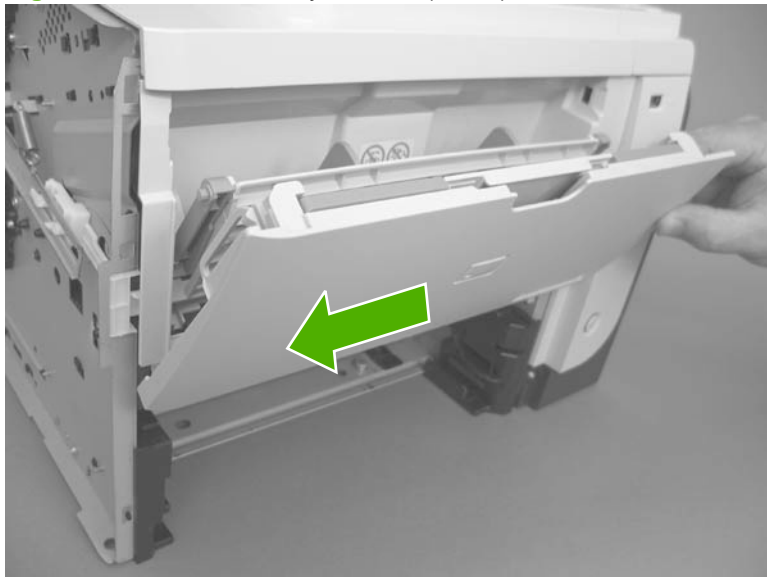
3. Slightly lower the cover, and then slide it toward the left side of the product.

---

 **TIP:** If you lower the tray too far, it will not slide off of the hinge pins.

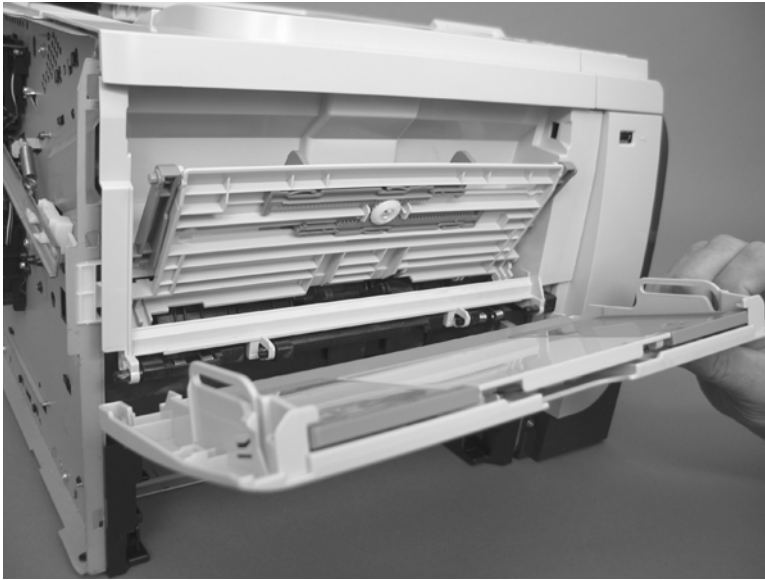
---

**Figure 2-35** Remove Tray 1 cover (2 of 3)



4. Remove the Tray 1 cover.

**Figure 2-36** Remove Tray 1 cover (3 of 3)





## Cartridge-door assembly

1. Before proceeding, remove the following components:

- Rear-door assembly. See [Rear-door assembly on page 62](#).
- Left cover. See [Left cover on page 66](#).
- Tray 1 (multipurpose tray) cover. See [Tray 1 \(multipurpose tray\) cover on page 69](#).

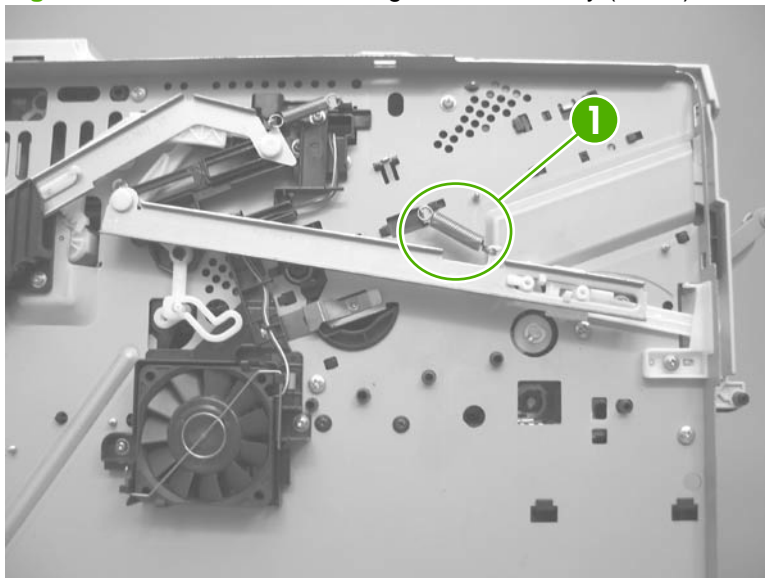
---

💡 **TIP:** The cartridge-door assembly can be removed without removing the Tray 1 cover. However, it is easier to remove and reinstall the door assembly when the Tray 1 cover is not installed.

---

2. Remove one spring (callout 1).

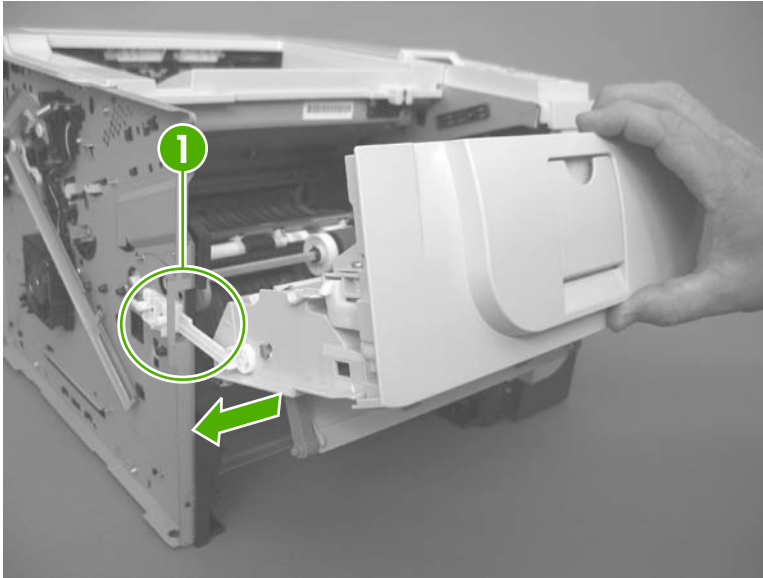
**Figure 2-37** Remove the cartridge-door assembly (1 of 3)



3. Slightly slide the assembly toward the left side of the product to release it from the hinge pins.

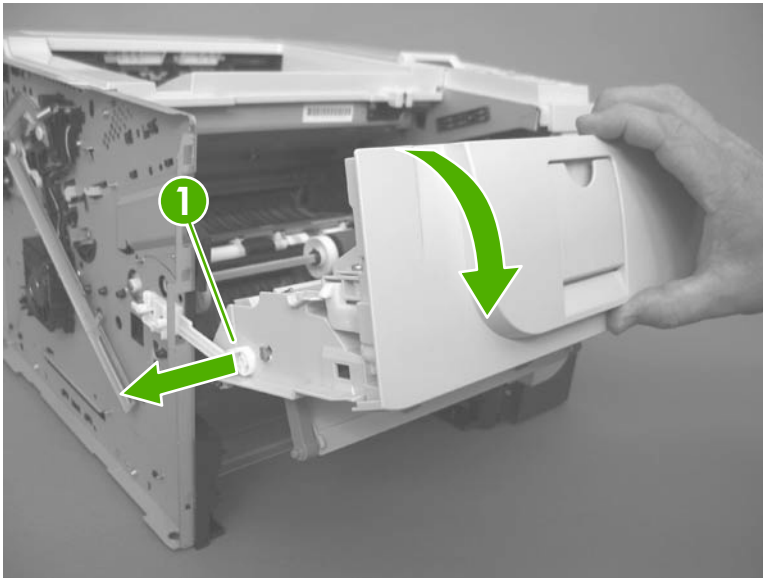
△ **CAUTION:** Do not damage the plastic link arm (callout 1).

**Figure 2-38** Remove the cartridge-door assembly (2 of 3)



4. Rotate the assembly down, and then separate the plastic link arm (callout 1) from the assembly. Remove the cartridge-door assembly.

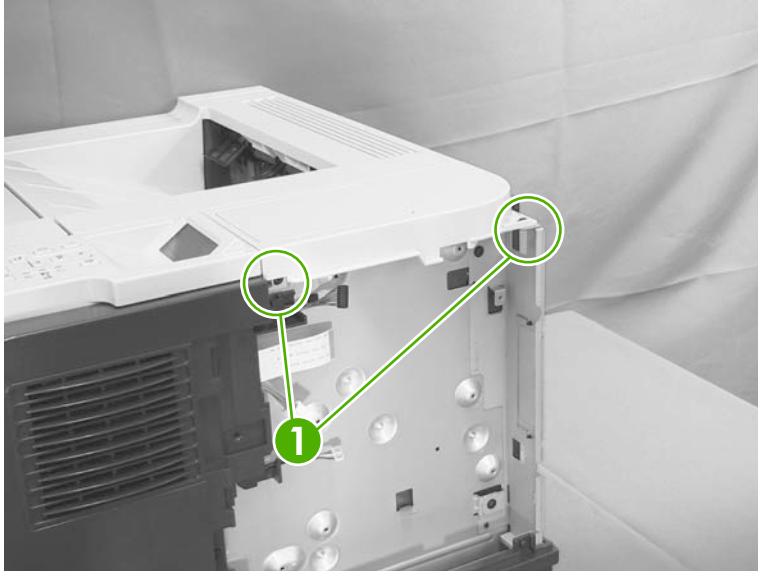
**Figure 2-39** Remove the cartridge-door assembly (3 of 3)



## Top-right cover

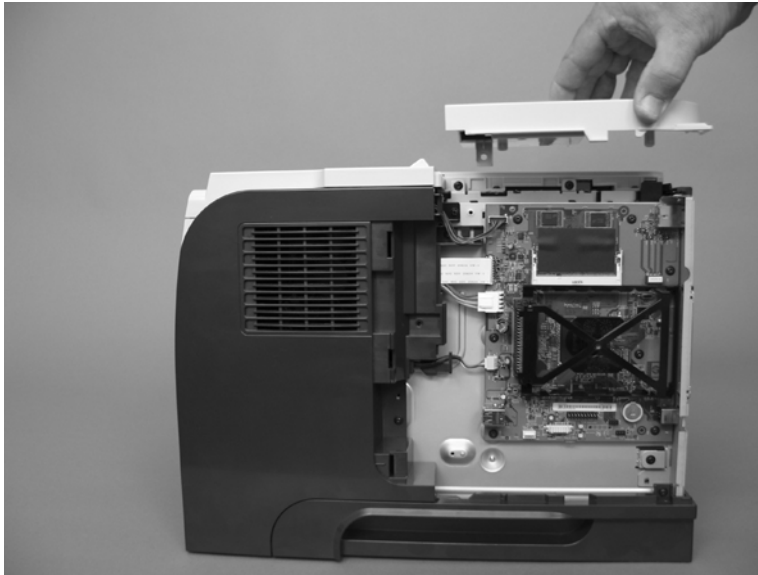
1. Before proceeding, remove the following components:
  - DIMM cover. See [DIMM cover and DIMM on page 57](#).
  - Formatter cover. See [Formatter cover and formatter PCA on page 60](#).
2. Remove two screws (callout 1).

**Figure 2-40** Remove the top-right cover (1 of 2)



3. Lift the cover off of the product to remove it.

**Figure 2-41** Remove the top-right cover (2 of 2)



## Control panel

 **WARNING!**  ESD sensitive component.

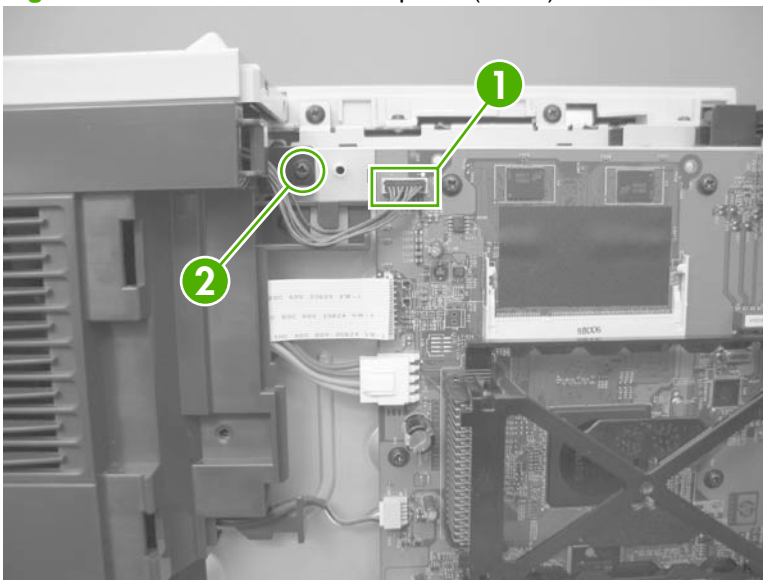
1. Before proceeding, remove the following components:
  - DIMM cover. See [DIMM cover and DIMM on page 57](#).
  - Formatter cover. See [Formatter cover and formatter PCA on page 60](#).
2. Press the cartridge-door release button, and then open the cartridge door. Make sure that the door is completely open.

**Figure 2-42** Remove the control panel (1 of 4)



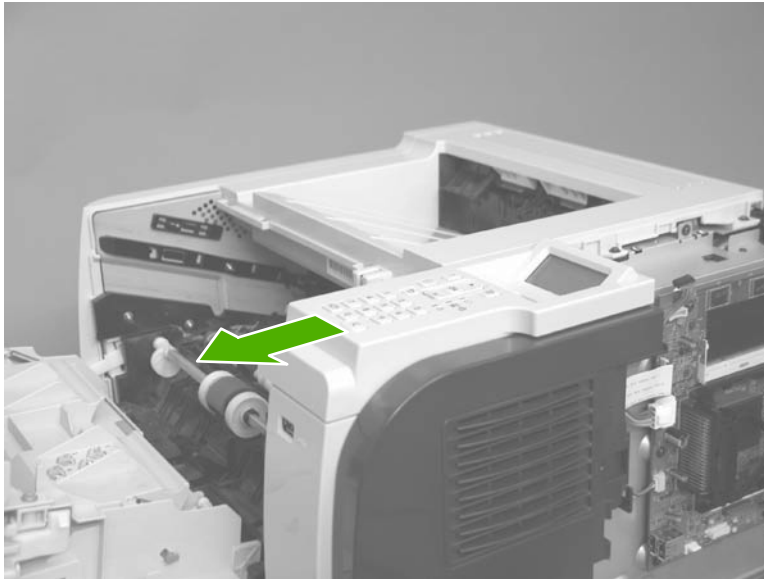
3. Disconnect one connector (callout 1), and then remove one screw (callout 2).

**Figure 2-43** Remove the control panel (2 of 4)



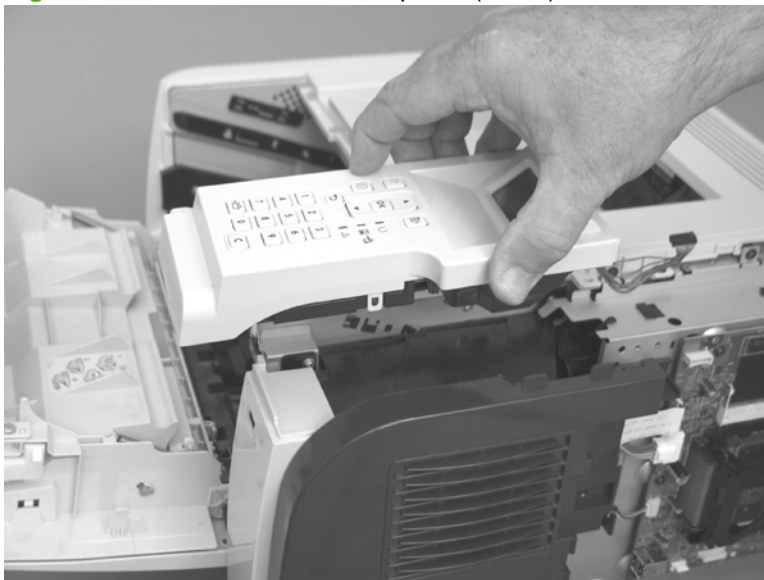
4. Slide the control panel toward the front of the product to release it.

**Figure 2-44** Remove the control panel (3 of 4)




5. Lift the control panel off of the product.

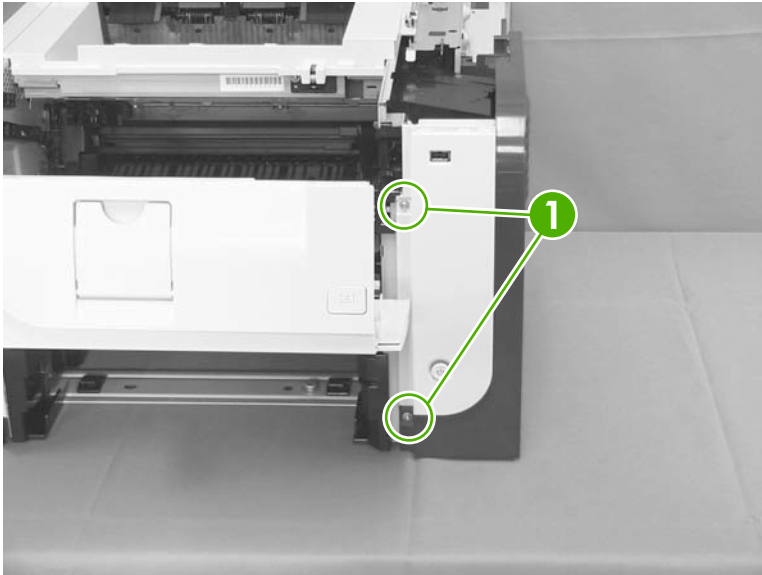
**Figure 2-45** Remove the control panel (4 of 4)



## Front-right and right-side cover assembly

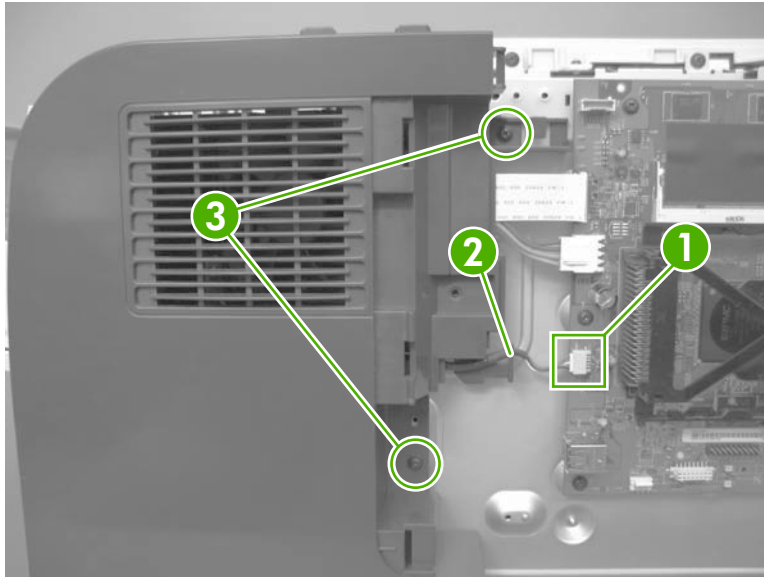
1. Before proceeding, remove the following components:
    - DIMM cover. See [DIMM cover and DIMM on page 57](#).
    - Formatter cover. See [Formatter cover and formatter PCA on page 60](#).
    - Cartridge-door assembly. See [Cartridge-door assembly on page 71](#).
- 
-  **NOTE:** The figures in this section show the cartridge-door assembly installed. However, it might be easier to reinstall the front-right and right-side cover assembly if the cartridge-door assembly is removed.
- 
- Control panel. See [Control panel on page 74](#).
2. Remove two screws (callout 1).

**Figure 2-46** Remove the front-right and right-side cover assembly (1 of 6)



3. Disconnect one connector (callout 1; J14), release the wire harness from the guide (callout 2), and then remove two screws (callout 3).

**Figure 2-47** Remove the front-right and right-side cover assembly (2 of 6)

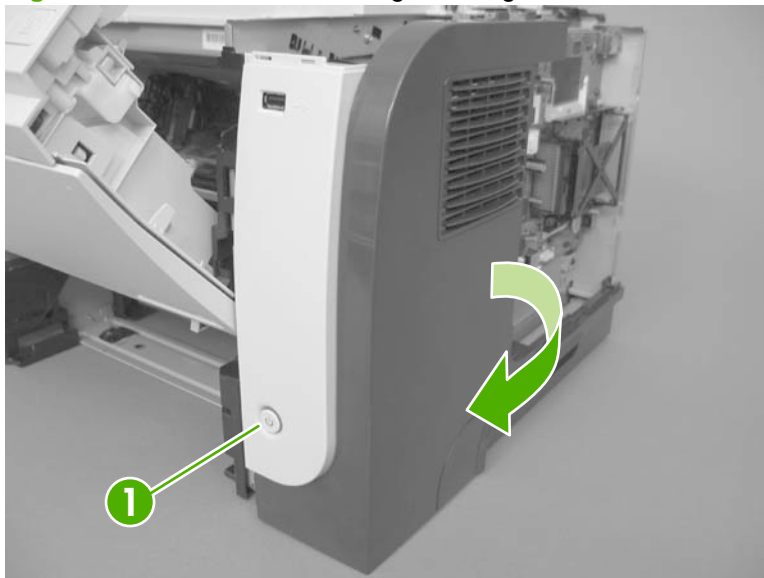


4. Slightly push the cover assembly toward the front of the product to release it, and then carefully rotate the cover away from the product.


△ **CAUTION:** Do not damage the covers or the cartridge-door assembly (if you did not remove it) when you rotate the cover assembly away from the product.

Do not dislodge the power-switch assembly (callout 1) when you rotate the cover assembly away from the product.

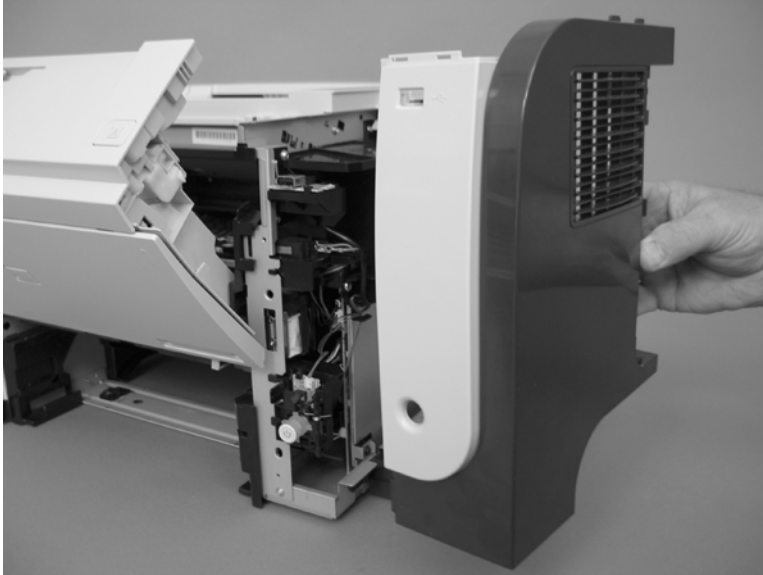
**Figure 2-48** Remove the front-right and right-side cover assembly (3 of 6)



5. Remove the cover assembly.

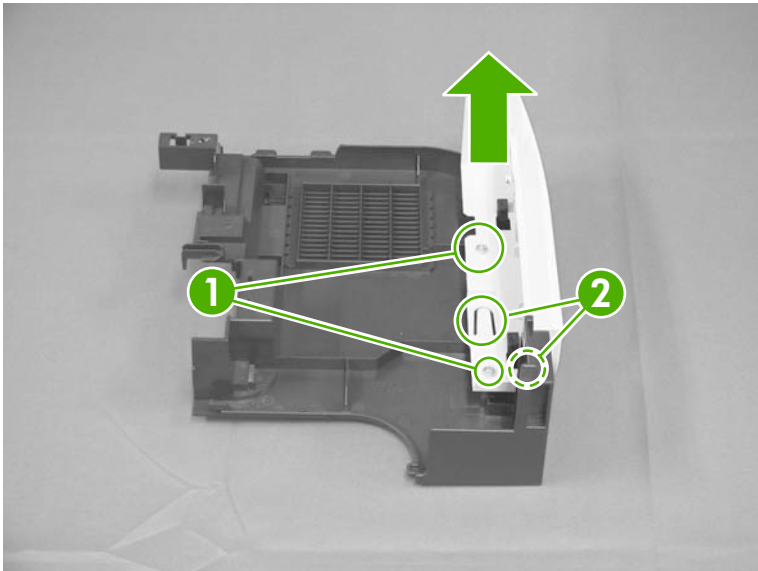
 **Reinstallation tip** The figures in this section show the cartridge-door assembly installed. However, it might be easier to reinstall the front-right and right-side cover assembly if the cartridge-door assembly is removed. See [Cartridge-door assembly on page 71](#).

**Figure 2-49** Remove the front-right and right-side cover assembly (4 of 6)



6. If necessary, remove two screws (callout 1), release two tabs (callout 2), and then slide the front-right cover toward the top of the right-side cover to release it.

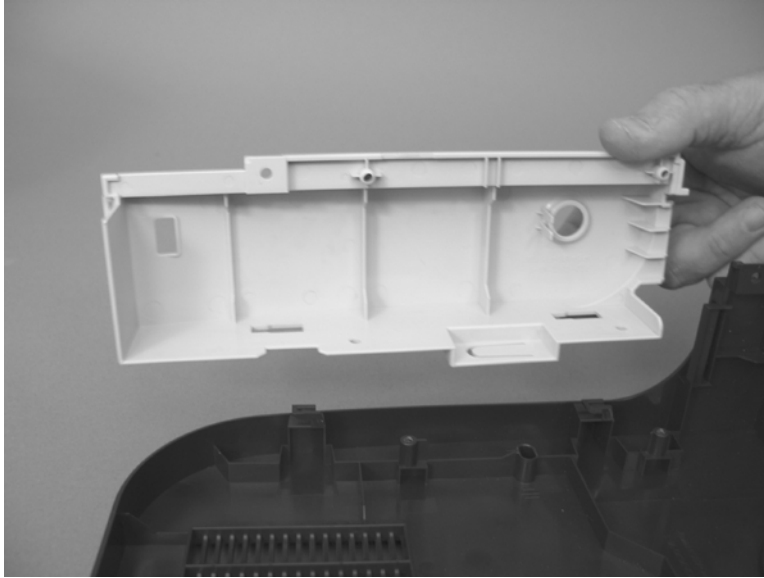
**Figure 2-50** Remove the front-right and right-side cover assembly (5 of 6)






7. If necessary, separate the front-right cover from the right-side cover.

**Figure 2-51** Remove the front-right and right-side cover assembly (6 of 6)



## Lower-right cover and bracket

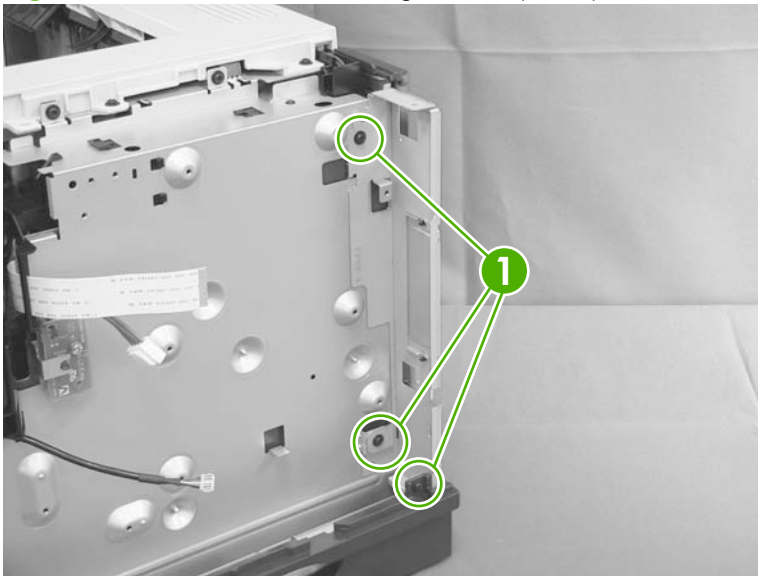
 **NOTE:** You do not need to remove the sheet-metal bracket to remove the lower-right cover. However, you must remove the bracket and the cover when removing some of the other product components in this chapter. Use this procedure to remove the cover only, or the cover and the bracket.

1. Before proceeding, remove the following components:
  - DIMM cover. See [DIMM cover and DIMM on page 57](#).
  - Formatter cover and Formatter PCA. See [Formatter cover and formatter PCA on page 60](#).
  - Top-right cover. See [Top-right cover on page 73](#).
  - Control panel. See [Control panel on page 74](#).
  - Front-right and right-side cover assembly. See [Front-right and right-side cover assembly on page 76](#).


2. **To remove the cover and the bracket:** Remove three screws (callout 1).


**To remove the bracket only:** Remove one screw (the bottom most screw in callout 1).

**Figure 2-52** Remove the lower-right cover (1 of 4)

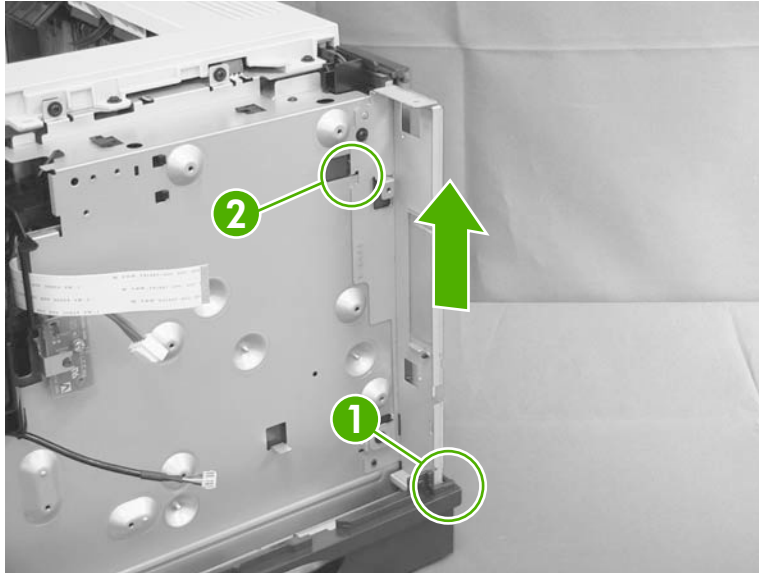


- To remove the bracket only::** Slide the sheet-metal bracket up to release it, and then remove the bracket.

 **NOTE:** You might need to slightly pull outward on the lower-right cover (callout 1) to release the sheet-metal bracket.

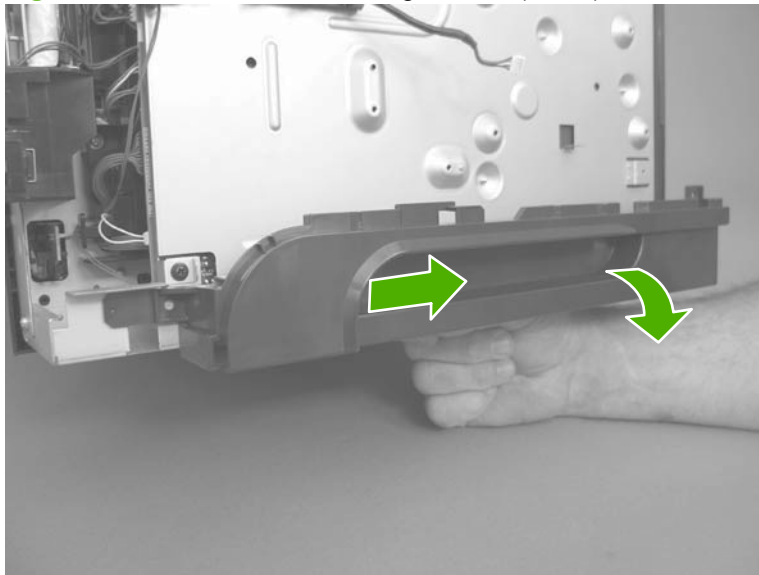
 **Reinstallation tip** When you reinstall the bracket, make sure that the tab (callout 2) is engaged in the slot in the chassis.

**Figure 2-53** Remove the lower-right cover (2 of 4)



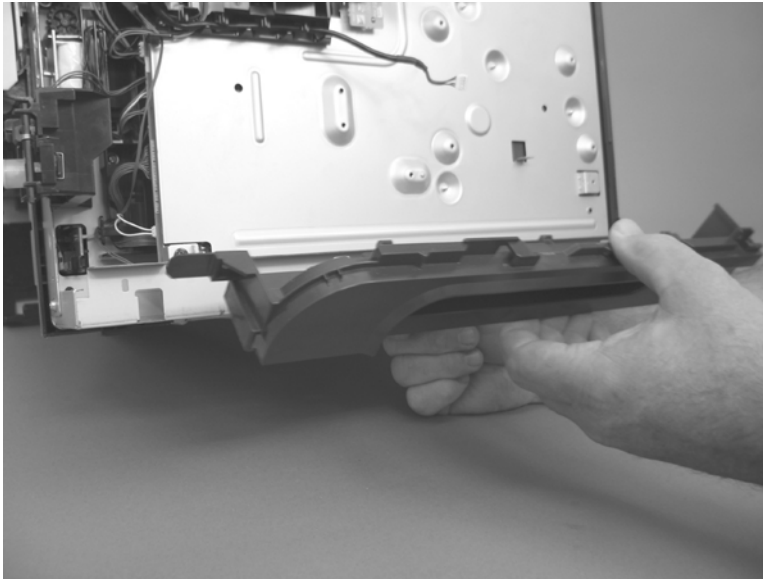
- Raise the right side of the product, slide the lower-right cover toward the back of the product, and then rotate the cover away from the product.

**Figure 2-54** Remove the lower-right cover (3 of 4)



5. Remove the lower-right cover.

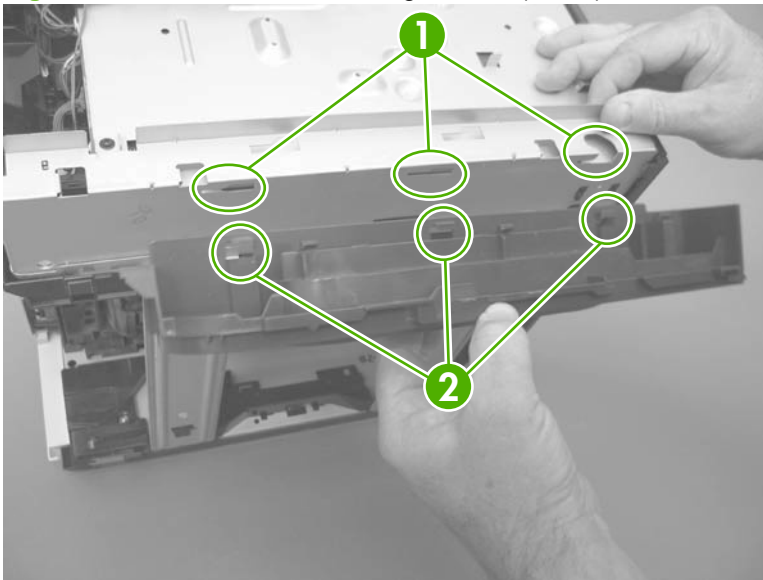
**Figure 2-55** Remove the lower-right cover (4 of 4)



### Reinstall the lower-right cover

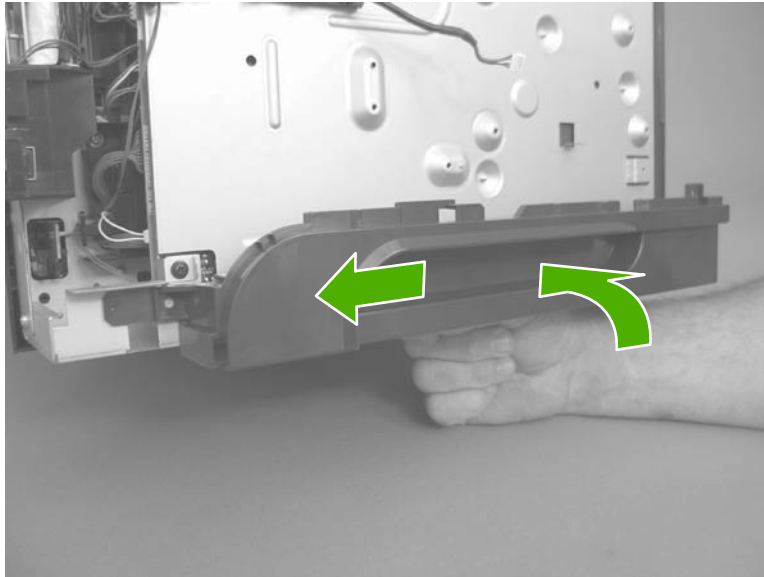
1. Carefully raise the right side of the product, find the three slots in the chassis (callout 1), and the three tabs (callout 2) along the bottom of the cover.

**Figure 2-56** Reinstall the lower-right cover (1 of 2)



2. Rotate the cover up to engage the tabs with the slots, and then slide the cover toward the front of the product to install it.

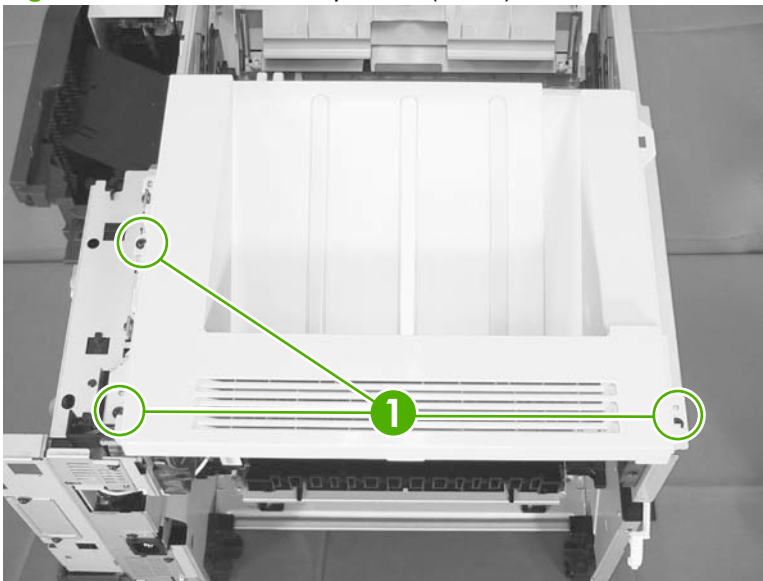
**Figure 2-57** Remove the lower-right cover (2 of 2)



## Top cover

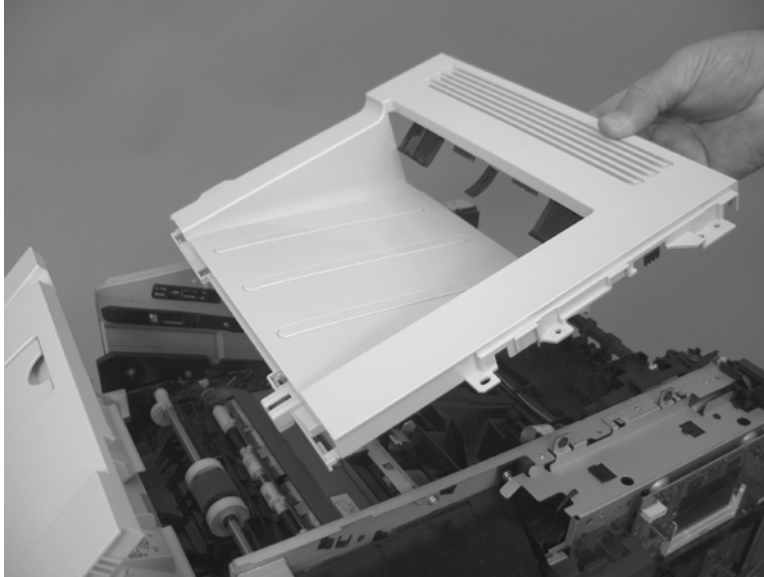
1. Before proceeding, remove the following components:
  - DIMM cover. See [DIMM cover and DIMM on page 57](#).
  - Formatter cover. See [Formatter cover and formatter PCA on page 60](#).
  - Rear-door assembly. See [Rear-door assembly on page 62](#).
  - Left cover. See [Left cover on page 66](#).
  - Top-right cover. See [Top-right cover on page 73](#).
  - Control panel. See [Control panel on page 74](#).
2. Remove three screws (callout 1).

**Figure 2-58** Remove the top cover (1 of 2)



3. Slightly raise the rear of the cover, slide the cover toward the front of the product, and then remove it.

**Figure 2-59** Remove the top cover (2 of 2)



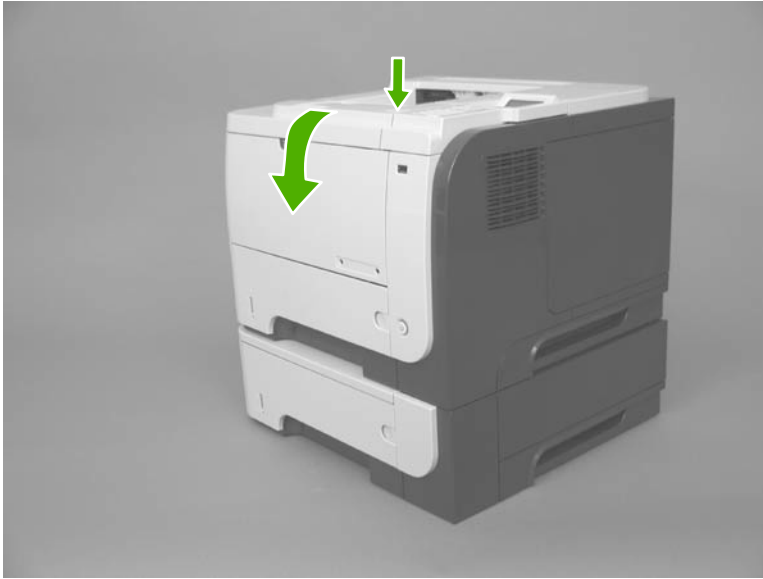
## Main assemblies

### Tray 1 (multipurpose tray) pickup roller

△ **CAUTION:** Do not touch the surface of the roller. Skin oils deposited on the roller might cause print-quality problems.

1. Press the cartridge-door release button, and then open the cartridge door. Make sure that the door is completely open.

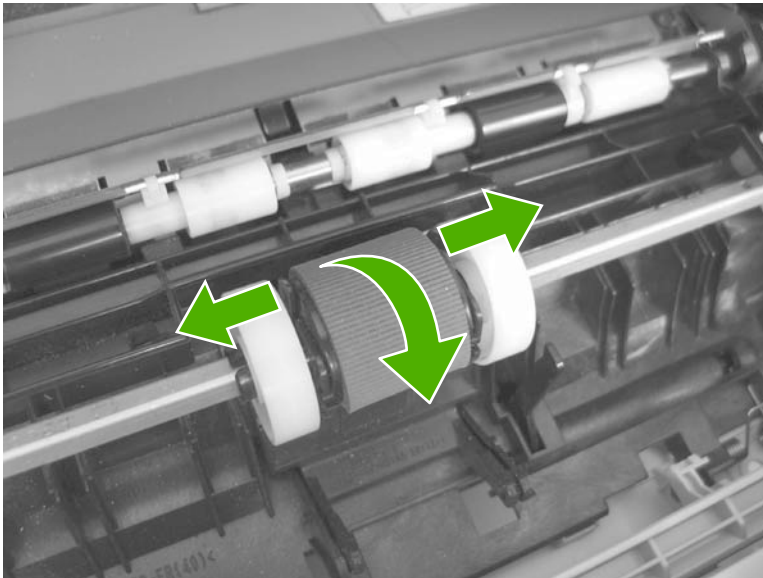
**Figure 2-60** Remove the Tray 1 (MP tray) pickup roller (1 of 2)



2. Release two tabs, and then rotate the roller out and away from the product to remove it.

💡 **TIP:** It might be easier to release the tabs by using a small flat blade screwdriver.

**Figure 2-61** Remove the Tray 1 (MP tray) pickup roller (2 of 2)





## Tray 1 (multipurpose tray) separation pad

△ **CAUTION:** Do not touch the surface of the pad. Skin oils deposited on the roller might cause paper-handling problems.

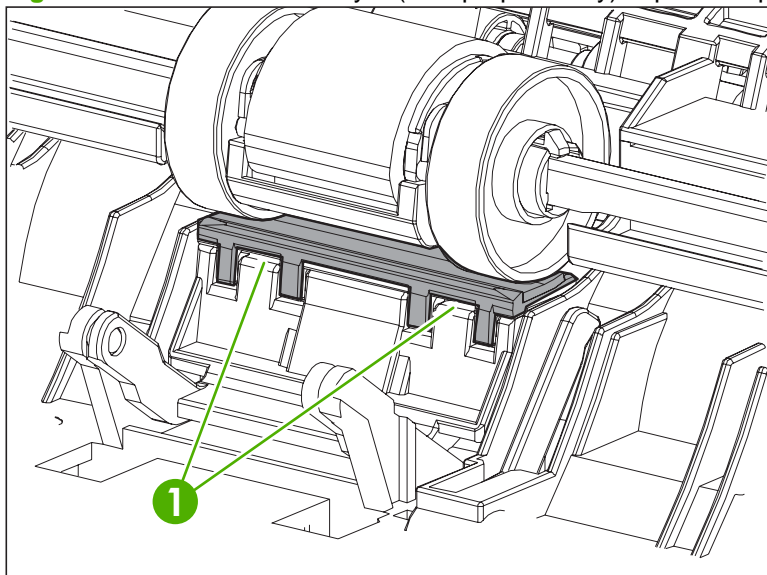
1. Press the cartridge-door release button, and then open the cartridge door. Make sure that the door is completely open.

**Figure 2-62** Remove the Tray 1 (multipurpose tray) separation pad (1 of 2)



2. Release two tabs (callout 1), and then remove the separation pad.

**Figure 2-63** Remove the Tray 1 (multipurpose tray) separation pad (2 of 2)



## Tray 2, Tray 3, or Tray 4 pickup roller

△ **CAUTION:** Do not touch the surface of the roller. Skin oils deposited on the roller might cause print-quality problems.

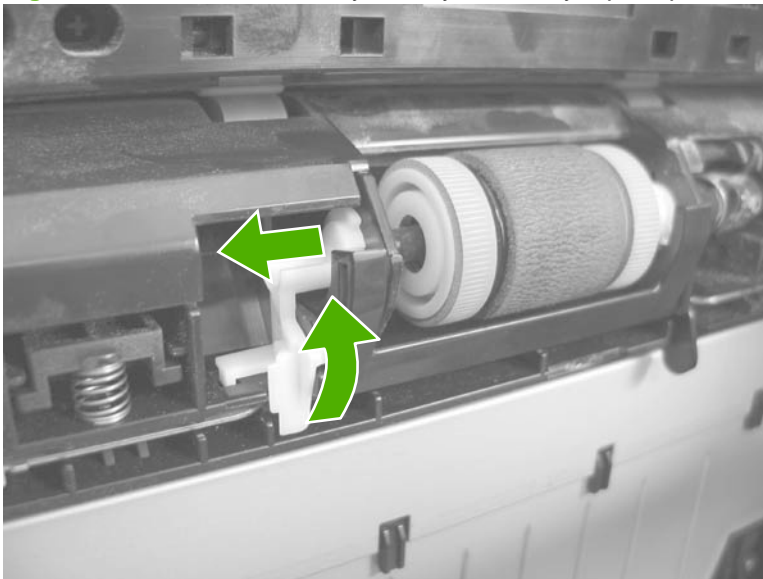
📝 **NOTE:** If you did not remove the Tray 2, Tray 3, or Tray 4 cassette before servicing the product, remove it now.

1. Carefully place the product front-side up, so that you can see into the opening where the cassette would be installed.

📝 **NOTE:** Debris can scratch or damage the back of the product. Before you place the product front-side up, remove any debris from the work surface. If possible, set the product on a clean, dry cloth to prevent scratching and damage.

2. Release the roller bushing, rotate the bushing up, and then slide the bushing off of the roller shaft.

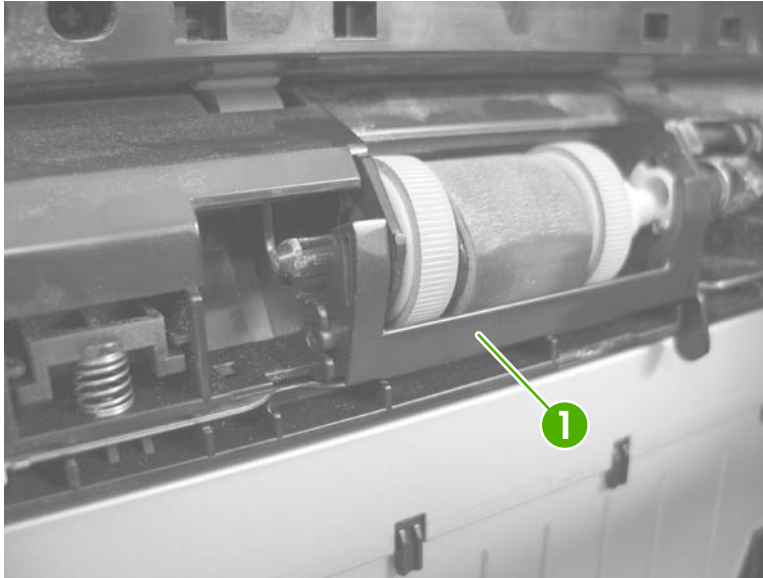
**Figure 2-64** Remove the Tray 2, Tray 3, or Tray 4 pickup roller (1 of 3)



- Carefully remove the black-plastic guard (callout 1).

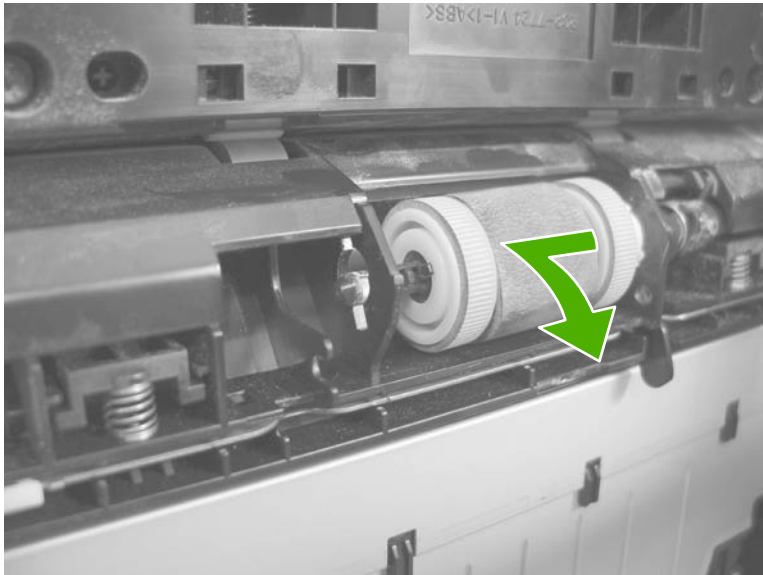
△ **CAUTION:** The guard is partially retained by the bushing removed in the previous step. Do not lose the guard when the bushing is removed.

**Figure 2-65** Remove the Tray 2, Tray 3, or Tray 4 pickup roller (2 of 3)



- Slide the roller toward the left side of the product, rotate the right end of the roller away from the product, and then remove the roller assembly.

**Figure 2-66** Remove the Tray 2, Tray 3, or Tray 4 pickup roller (3 of 3)

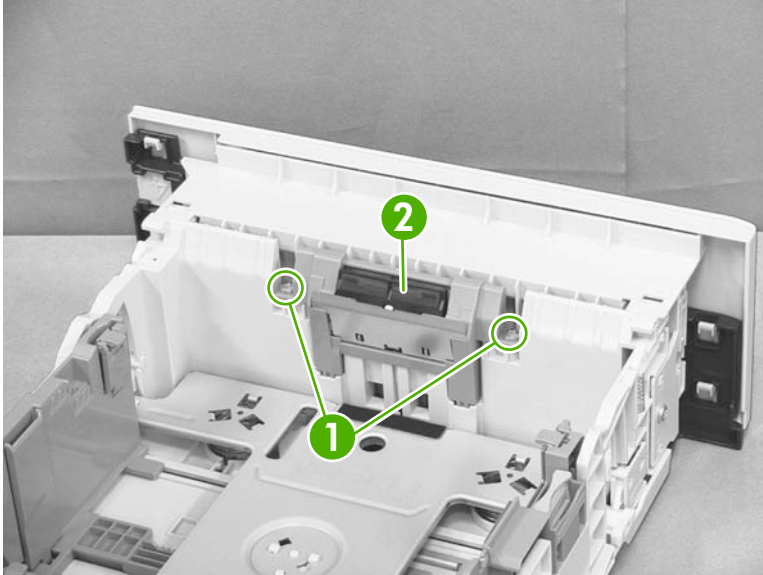


## Tray 2, Tray 3, or Tray 4 separation pad

△ **CAUTION:** Do not touch the surface of the pad. Skin oils deposited on the roller might cause paper-handling problems.

1. Remove the tray cassette. See [Tray cassette \(Tray 2, Tray 3, or Tray 4\) on page 54](#).
2. Remove two screws (callout 1), and then remove the separation pad (callout 2).

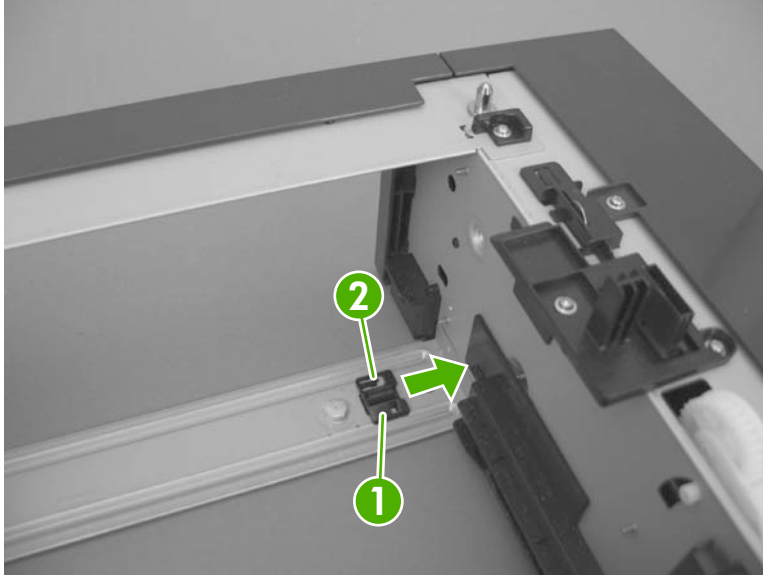
**Figure 2-67** Remove the Tray 2, Tray 3, or Tray 4 separation pad



## Tray 2, Tray 3, or Tray 4 base-plate roller assembly

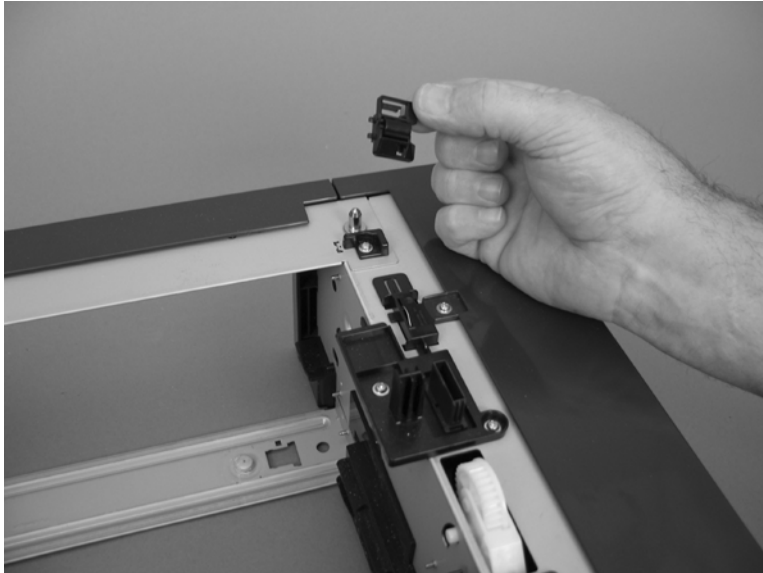
1. Remove the tray cassette. See [Tray cassette \(Tray 2, Tray 3, or Tray 4\)](#) on page 54.
2. Locate the base roller assembly (callout 1), release one tab (callout 2), and then slide the assembly toward the outside of the product to release it.

**Figure 2-68** Tray 2, Tray 3, or Tray 4 base plate roller assembly (1 of 2)



3. Remove the base roller assembly.

**Figure 2-69** Tray 2, Tray 3, or Tray 4 base plate roller assembly (2 of 2)



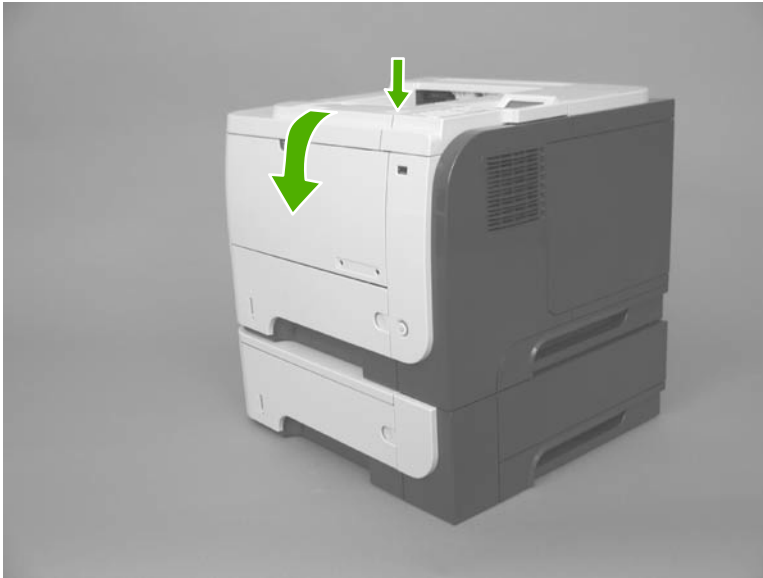
## Transfer roller

△ **CAUTION:** Do not touch the black-sponge portion of the transfer roller. Skin oils deposited on the transfer roller might cause print-quality problems.

1. Press the cartridge-door release button, and then open the cartridge door. Make sure that the door is completely open.

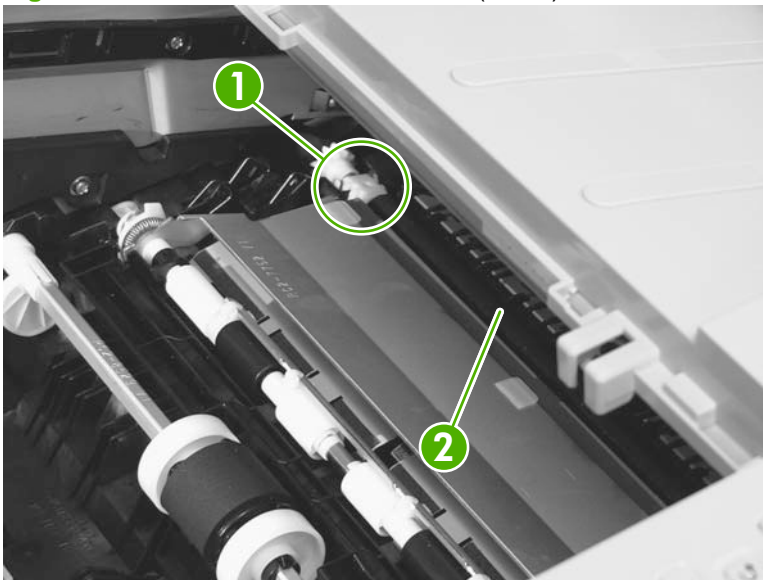
📝 **NOTE:** If you did not remove the print cartridge before servicing the product, remove it now.

**Figure 2-70** Remove the transfer roller (1 of 3)



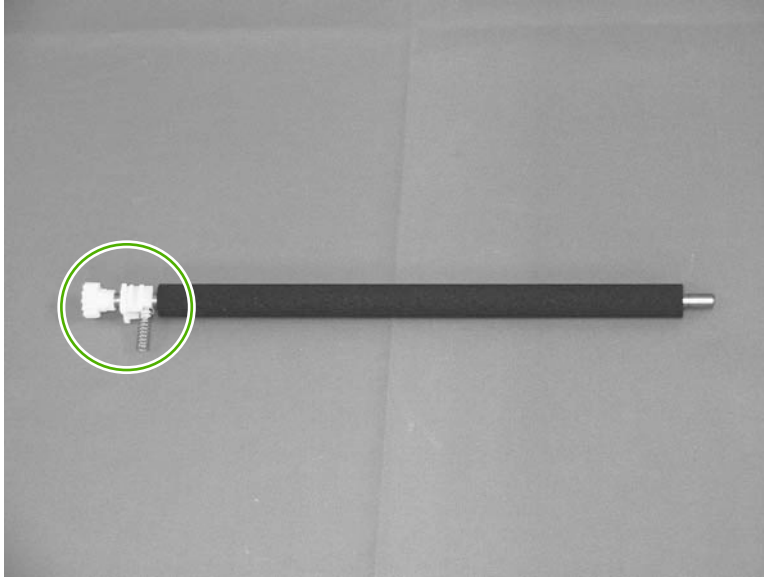
2. Release two tabs (callout 1) at the left end of the roller, slightly lift the end of the roller up, and then slide the roller (callout 2) toward the left to release it. Remove the roller.

**Figure 2-71** Remove the transfer roller (2 of 3)



3. If necessary, remove the gear, the bushing, and the spring, and then install them on a replacement roller.

**Figure 2-72** Remove the transfer roller (3 of 3)

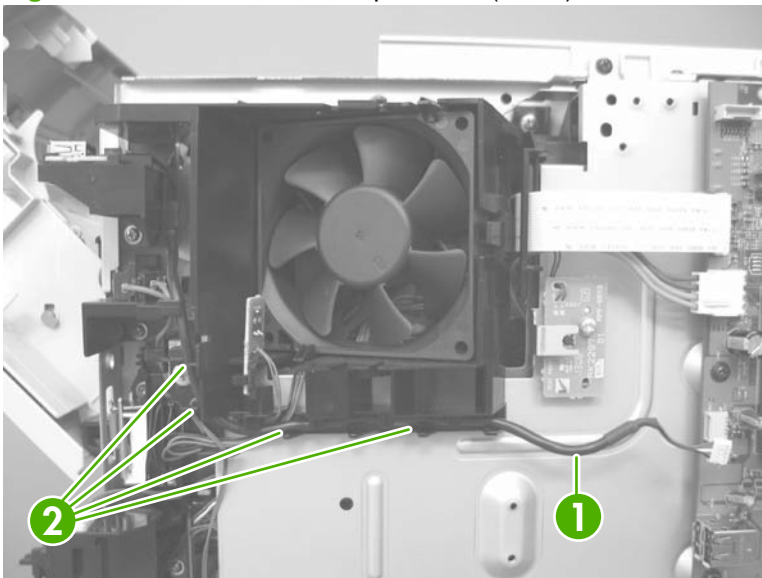


## USB port PCA

 **WARNING!**  ESD sensitive component.

1. Before proceeding, remove the following components:
  - DIMM cover. See [DIMM cover and DIMM on page 57](#).
  - Formatter cover. See [Formatter cover and formatter PCA on page 60](#).
  - Top-right cover. See [Top-right cover on page 73](#).
  - Control panel. See [Control panel on page 74](#).
  - Front-right and right-side cover assembly. See [Front-right and right-side cover assembly on page 76](#).
2. Release the wire harness (callout 1) from the retainers (callout 2).

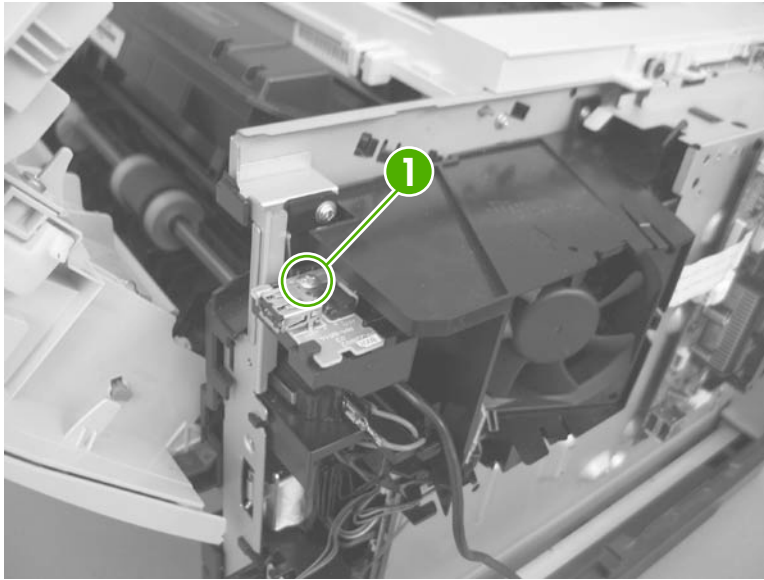
**Figure 2-73** Remove the USB port PCA (1 of 3)





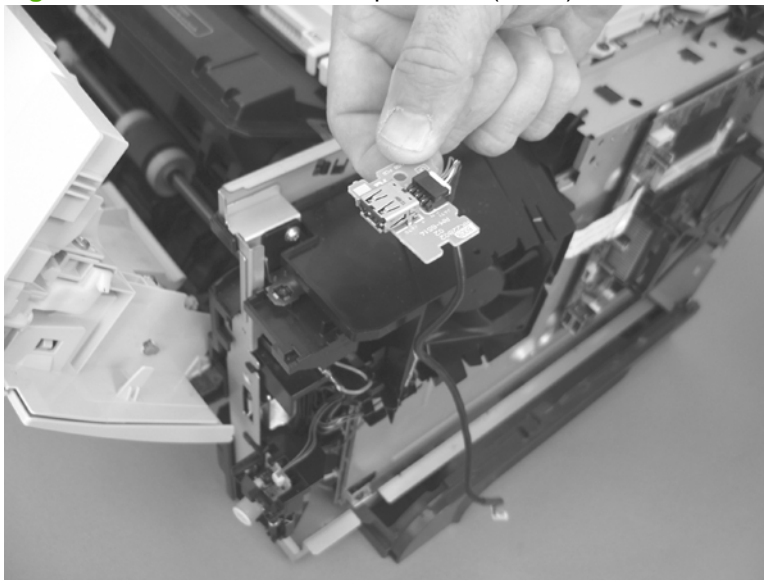
3. Remove on screw (callout 1).

**Figure 2-74** Remove the USB port PCA (2 of 3)



4. Carefully remove the USB port PCA.

**Figure 2-75** Remove the USB port PCA (3 of 3)

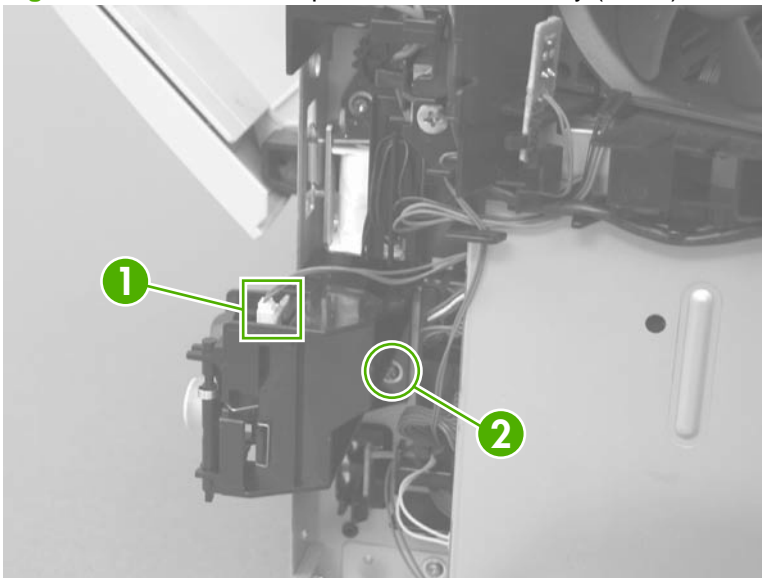


## Power-switch assembly

 **WARNING!**  ESD sensitive component.

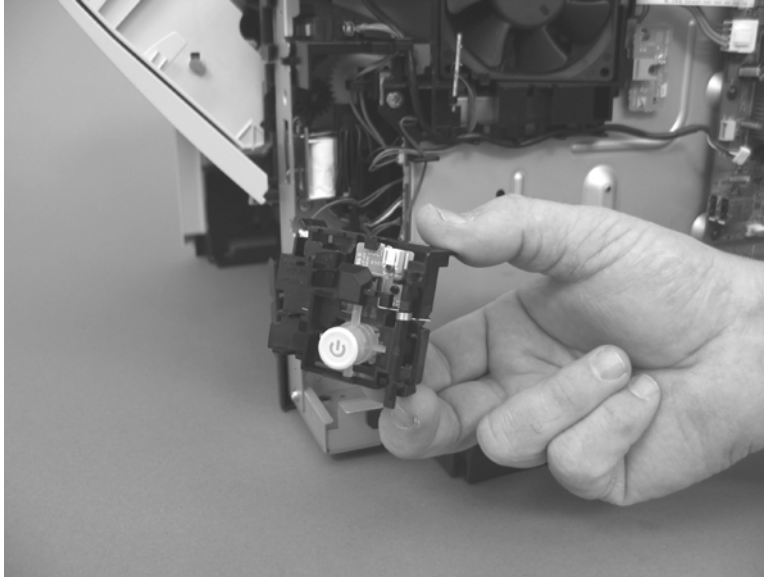
1. Before proceeding, remove the following components:
  - DIMM cover. See [DIMM cover and DIMM on page 57](#).
  - Formatter cover. See [Formatter cover and formatter PCA on page 60](#).
  - Top-right cover. See [Top-right cover on page 73](#).
  - Control panel. See [Control panel on page 74](#).
  - Front-right and right-side cover assembly. See [Front-right and right-side cover assembly on page 76](#).
2. Disconnect one connector (callout 1), and then remove one screw (callout 2).

**Figure 2-76** Remove the power-switch assembly (1 of 2)



3. Remove the power-switch assembly.

**Figure 2-77** Remove the power-switch assembly (2 of 2)



## Main fan, fan duct, and environmental sensor

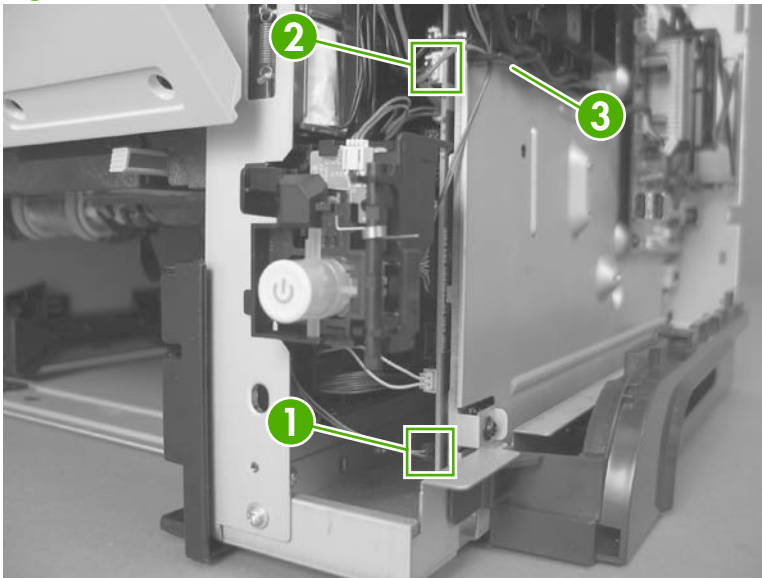
 **WARNING!**  ESD sensitive component.

Use the steps in this procedure to remove only the environmental sensor, or the sensor and the main fan.

1. Before proceeding, remove the following components:
  - DIMM cover. See [DIMM cover and DIMM on page 57](#).
  - Formatter cover. See [Formatter cover and formatter PCA on page 60](#).
  - Top-right cover. See [Top-right cover on page 73](#).
  - Control panel. See [Control panel on page 74](#).
  - Front-right and right-side cover assembly. See [Front-right and right-side cover assembly on page 76](#).
2. **To remove the main fan, fan duct, and the environmental sensor:** Disconnect two connectors (callout 1 and callout 2), and then release the wire harnesses from the retainers (callout 3).

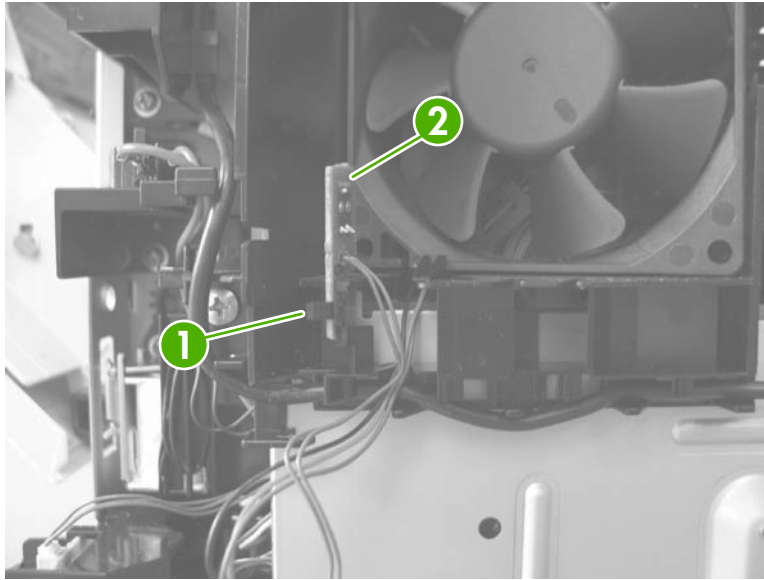
**To remove the environmental sensor only:** Disconnect one connector (callout 1) and release the wire harness from the retainers (callout 3).

**Figure 2-78** Remove the main fan, fan duct, and the environmental sensor PCA (1 of 3)



3. Release one tab (callout 1), and then remove the environmental sensor (callout 2).

**Figure 2-79** Remove the main fan, fan duct, and the environmental sensor PCA (2 of 3)

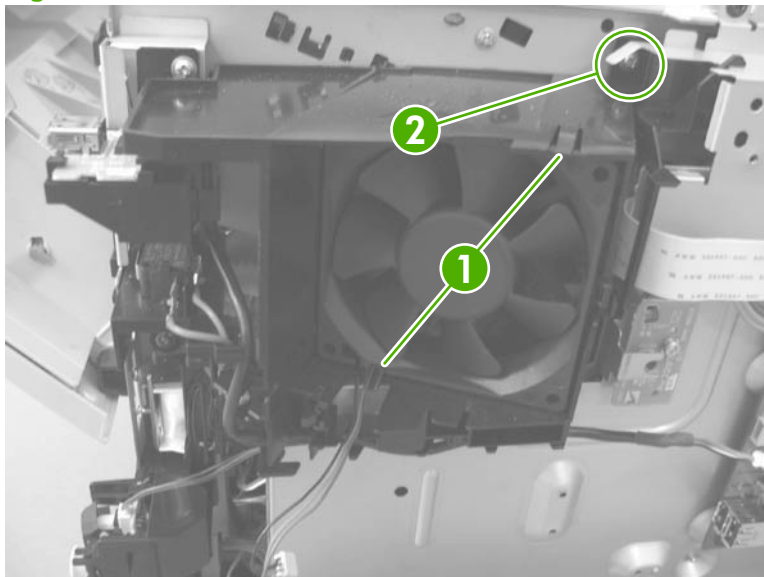


4. **To remove the main fan only:** Release two tabs (callout 1), and then remove the main fan.

**To remove the main fan and fan duct:** Remove one screw (callout 2), and then remove the main fan and fan duct together.

**Reinstallation tip** **If only the main fan was removed:** When the fan is reinstalled, the air must flow into the product. Make sure that the label side of the fan is toward the inside of the product when the fan is reinstalled.

**Figure 2-80** Remove the main fan, fan duct, and the environmental sensor PCA (3 of 3)

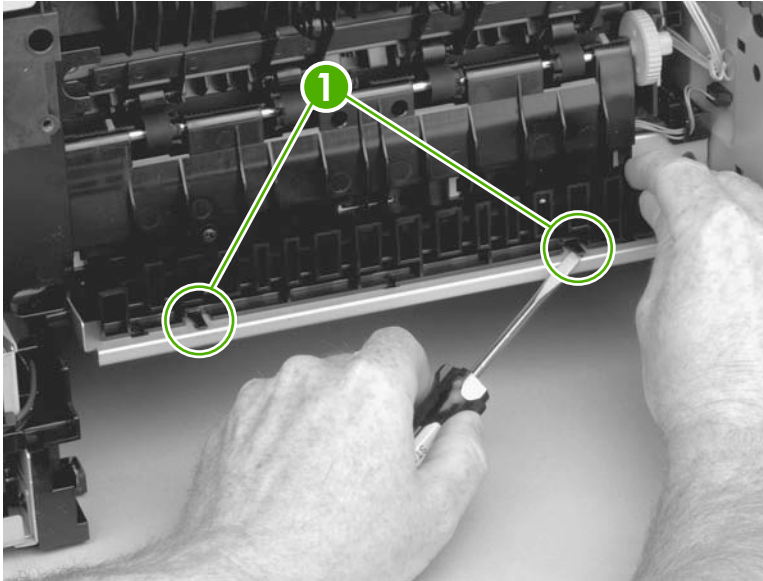


## Fuser

1. Before proceeding, remove the following components:
  - Rear-door assembly. See [Rear-door assembly on page 62](#).
  - Right-rear cover. See [Right-rear cover on page 68](#).
2. **Duplex models only:** Release two tabs (callout 1) on the duplex media-feed guide, and then slide the guide toward the back of the product to remove it.

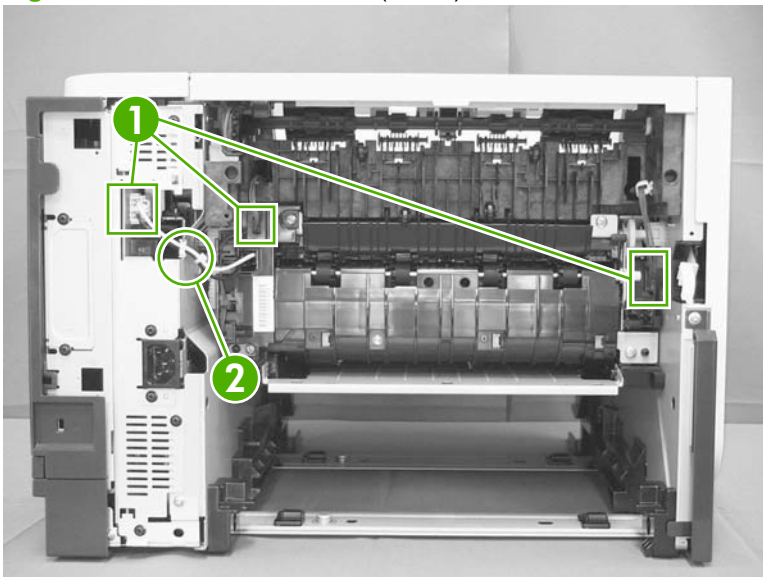
💡 **Reinstallation tip** Make sure that both tabs snap back into place when reinstalling the duplex media-feed guide.

**Figure 2-81** Remove the fuser (1 of 4)



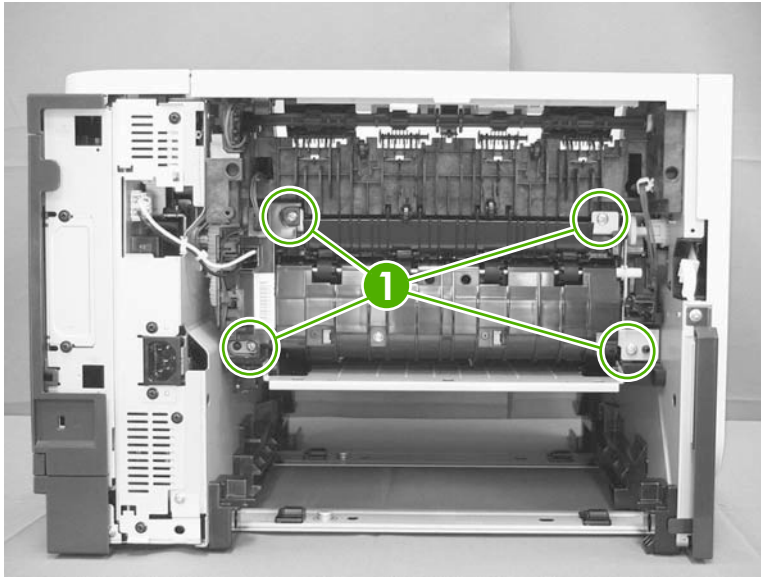
3. Disconnect three connectors (callout 1), and release one wire harness from the retainer (callout 2).

**Figure 2-82** Remove the fuser (2 of 4)



4. Remove four screws (callout 1).

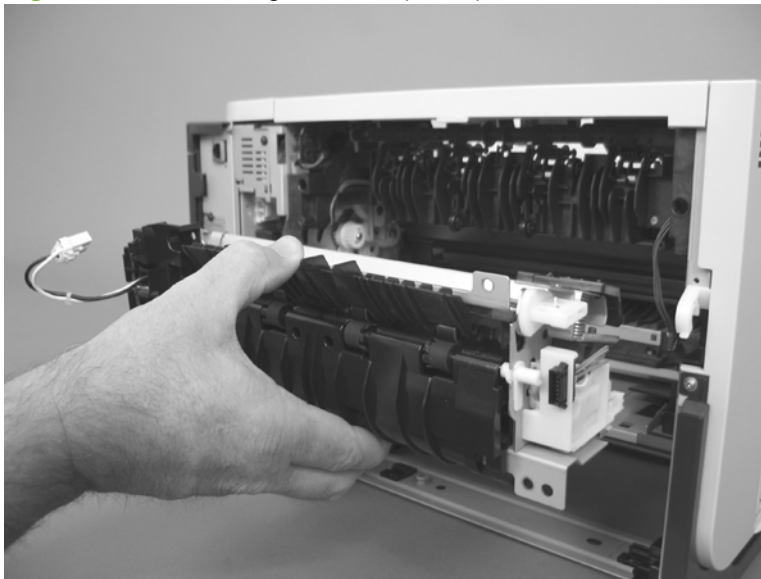
**Figure 2-83** Removing the fuser (3 of 4)



5. Pull the fuser out of the back of the product.

△ **CAUTION:** To avoid damaging the fuser, the cartridge-door assembly must be closed before you remove the fuser.

**Figure 2-84** Removing the fuser (4 of 4)

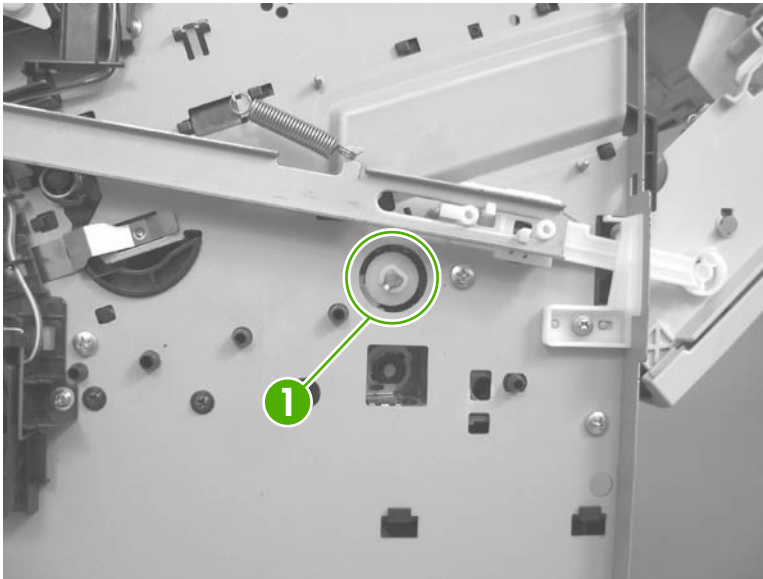




## Registration assembly

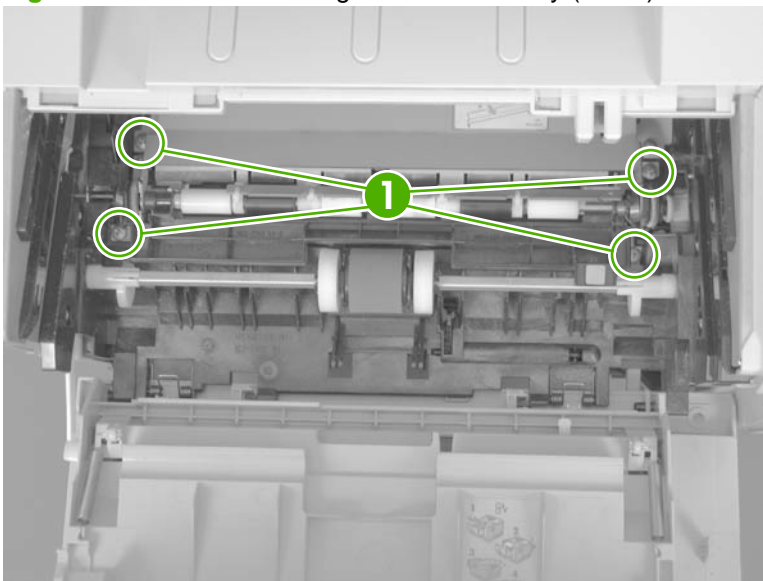
1. Before proceeding, remove the following components:
  - Rear-door assembly. See [Rear-door assembly on page 62](#).
  - Left cover. See [Left cover on page 66](#).
2. Unhook the clasp on the registration assembly gear (callout 1), and then slide the gear off of the shaft.

**Figure 2-85** Remove the registration assembly (1 of 3)



3. Open the cartridge door, and then remove four screws (callout 1).

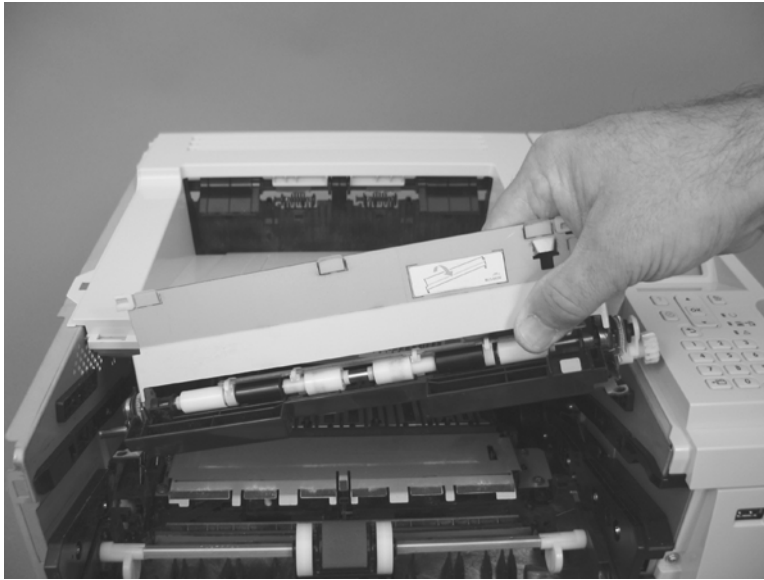
**Figure 2-86** Remove the registration assembly (2 of 3)





4. Lift the registration assembly out of the product, gear-end first.

**Figure 2-87** Removing the registration assembly (3 of 3)




## Duplex media-feed assembly

Duplex models only.

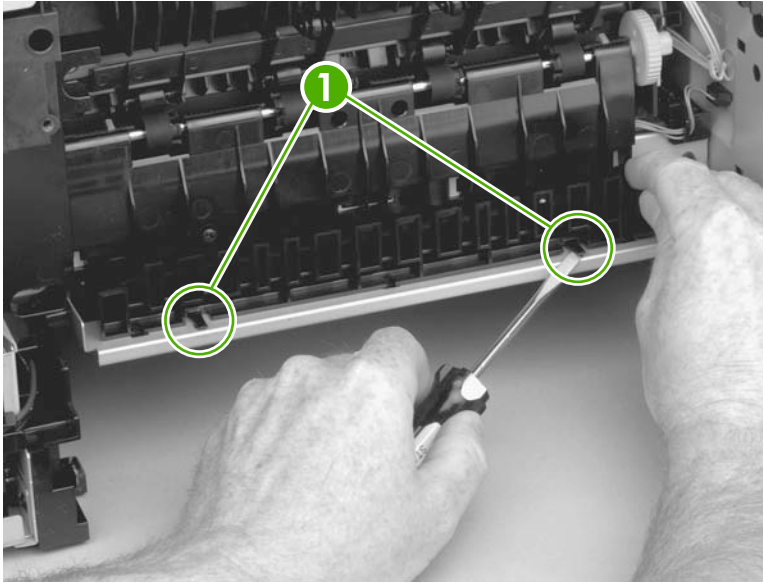
1. Before proceeding, remove the following components:
  - Rear-door assembly. See [Rear-door assembly on page 62](#).
  - Right-rear cover. See [Right-rear cover on page 68](#).
2. Release two tabs (callout 1) on the duplex media-feed guide, and then slide the guide toward the back of the product to remove it.

---

 **Reinstallation tip** Make sure that both tabs snap back into place when reinstalling the duplex media-feed guide.

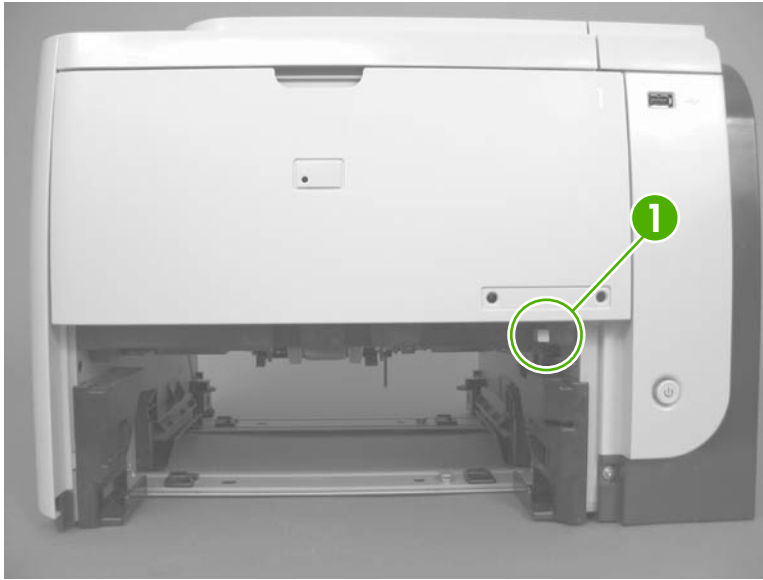
---

**Figure 2-88** Remove the duplex media-feed assembly (1 of 5)



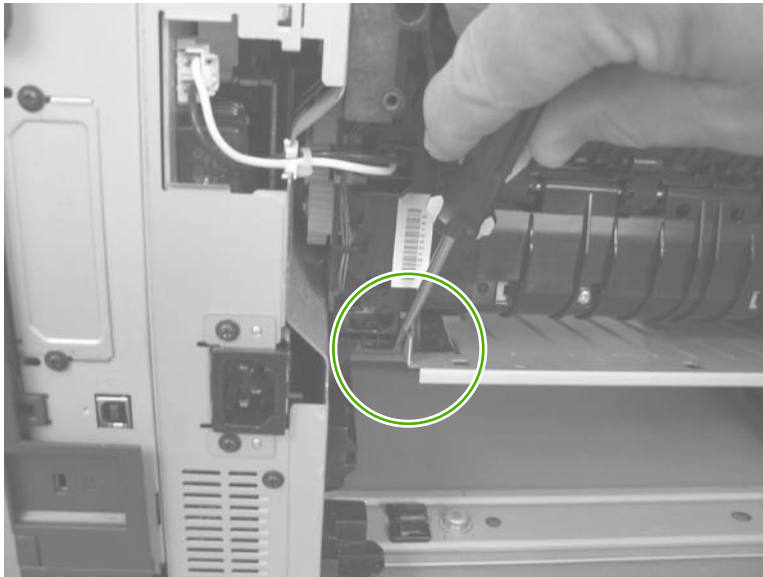
3. Press the green lever (callout 1) to release the duplex media-feed assembly.

**Figure 2-89** Remove the duplex media-feed assembly (2 of 5)



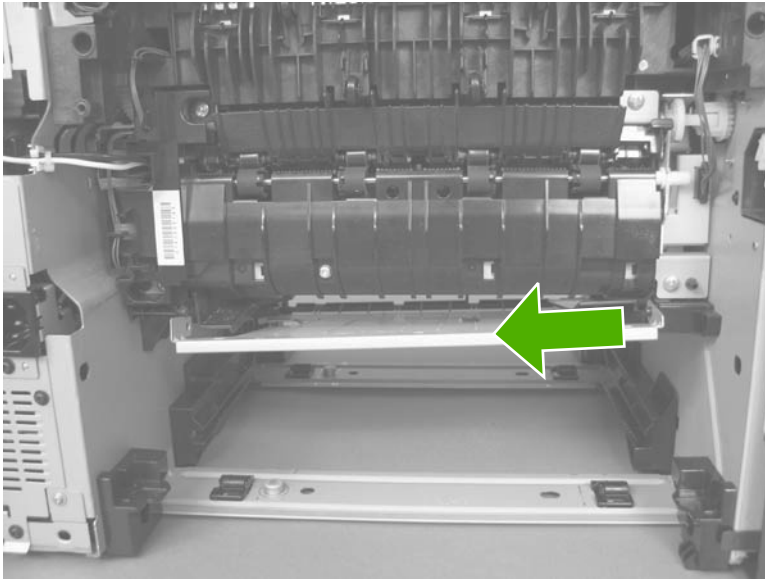
4. Use a small flat blade screwdriver to carefully pry the sheet-metal tab on the assembly away from the hinge pin to release it.

**Figure 2-90** Remove the duplex media-feed assembly (3 of 5)



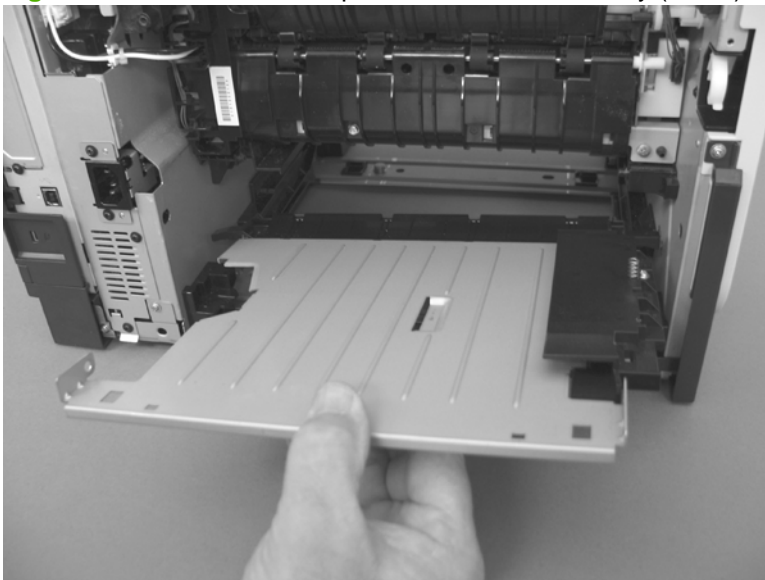
5. Slide the assembly away from the other hinge pin to release it.

**Figure 2-91** Remove the duplex media-feed assembly (4 of 5)



6. Pull the duplex media-feed assembly out of the back of the product.

**Figure 2-92** Remove the duplex media-feed assembly (5 of 5)

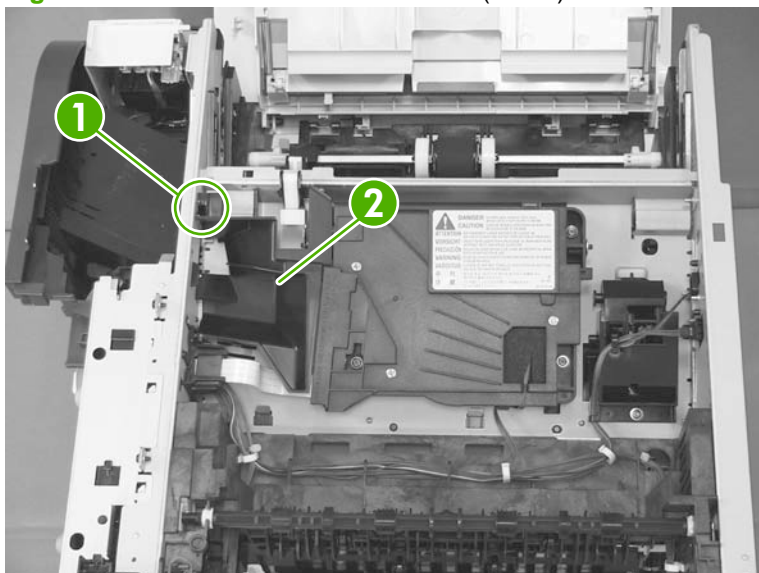


## Laser/scanner

 **WARNING!**  ESD sensitive component.

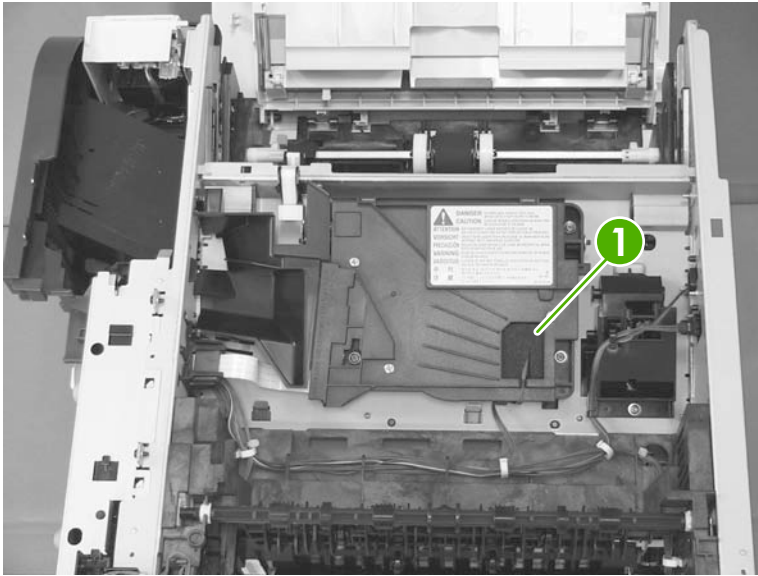
1. Before proceeding, remove the following components:
  - DIMM cover. See [DIMM cover and DIMM on page 57](#).
  - Formatter cover. See [Formatter cover and formatter PCA on page 60](#).
  - Rear-door assembly. See [Rear-door assembly on page 62](#).
  - Left cover. See [Left cover on page 66](#).
  - Top-right cover. See [Top-right cover on page 73](#).
  - Control panel. See [Control panel on page 74](#).
  - Top cover. See [Top cover on page 84](#).
2. Release one tab (callout 1) on the air duct, and then lift the air duct (callout 2) out of the product.

**Figure 2-93** Remove the laser/scanner (1 of 5)




3. Remove the antistatic sponge (callout 1).

**Figure 2-94** Remove the laser/scanner (2 of 5)



4. Disconnect one connector (callout 1) and one FFC (callout 2).

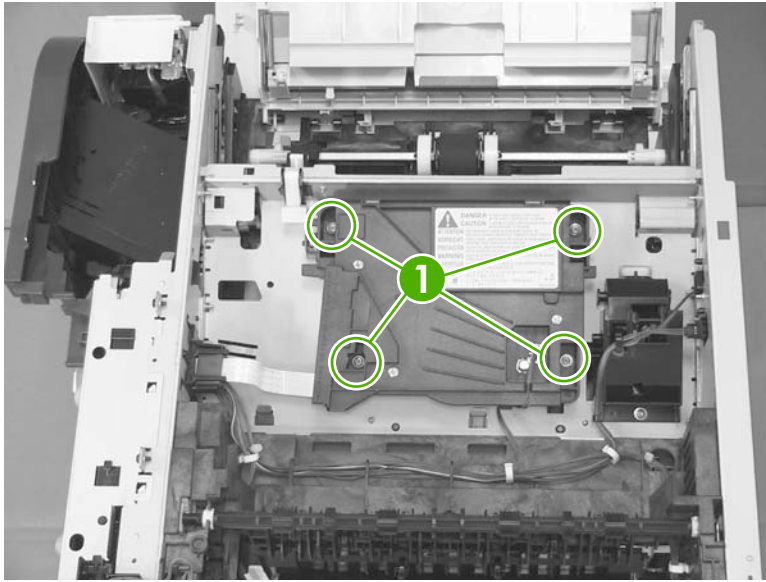
 **Reinstallation tip** Make sure that you correctly reconnect the FFC when the laser/scanner is installed. If the FFC is not correctly reconnected, a **51.1 ERROR** will appear on the control-panel display.

**Figure 2-95** Remove the laser/scanner (3 of 5)



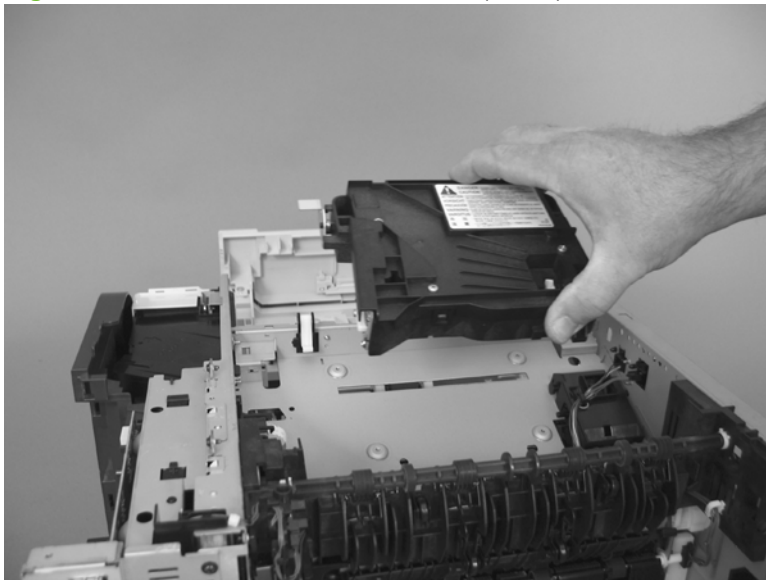
5. Remove four screws (callout 1).

**Figure 2-96** Remove the laser/scanner (4 of 5)




6. Lift the laser/scanner up and out of the product.

**Figure 2-97** Remove the laser/scanner (5 of 5)






## Engine control unit (ECU)

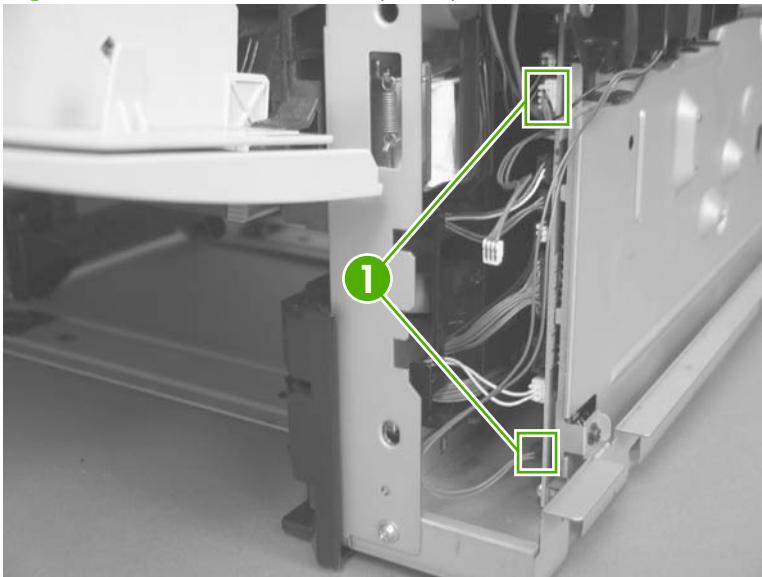
 **WARNING!**  ESD sensitive component.

1. Before proceeding, remove the following components:
  - DIMM cover. See [DIMM cover and DIMM on page 57](#).
  - Formatter cover and formatter PCA. See [Formatter cover and formatter PCA on page 60](#).
  - Rear-door assembly. See [Rear-door assembly on page 62](#).
  - Left cover. See [Left cover on page 66](#).
  - Top-right cover. See [Top-right cover on page 73](#).
  - Control panel. See [Control panel on page 74](#).
  - Front-right and right-side cover assembly. See [Front-right and right-side cover assembly on page 76](#).
  - Lower-right cover and bracket. See [Lower-right cover and bracket on page 80](#).
  - Top cover. See [Top cover on page 84](#).
  - Power switch assembly. See [Power-switch assembly on page 96](#).

 **TIP:** Removing the power-switch assembly makes it easier to disconnect the connectors at the front of the ECU.


2. Disconnect two connectors (callout 1).

**Figure 2-98** Remove the ECU (1 of 9)

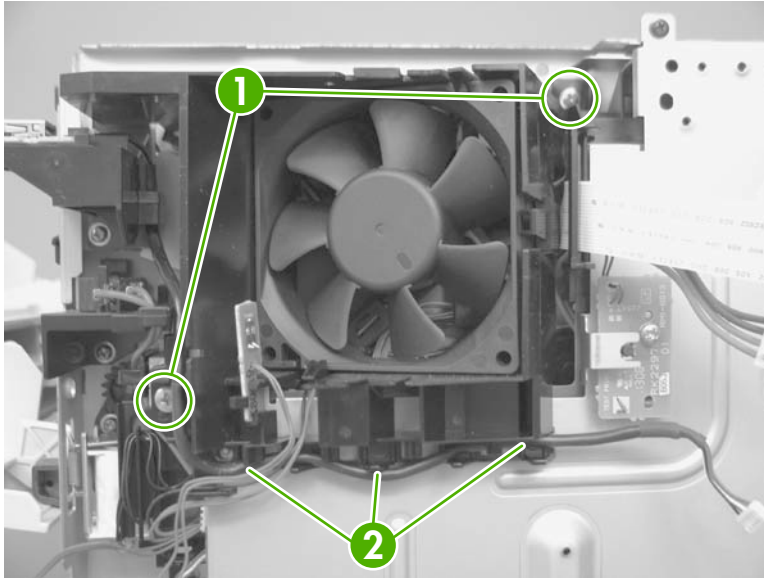




3. Remove two screws (callout 1), and then remove the fan assembly.

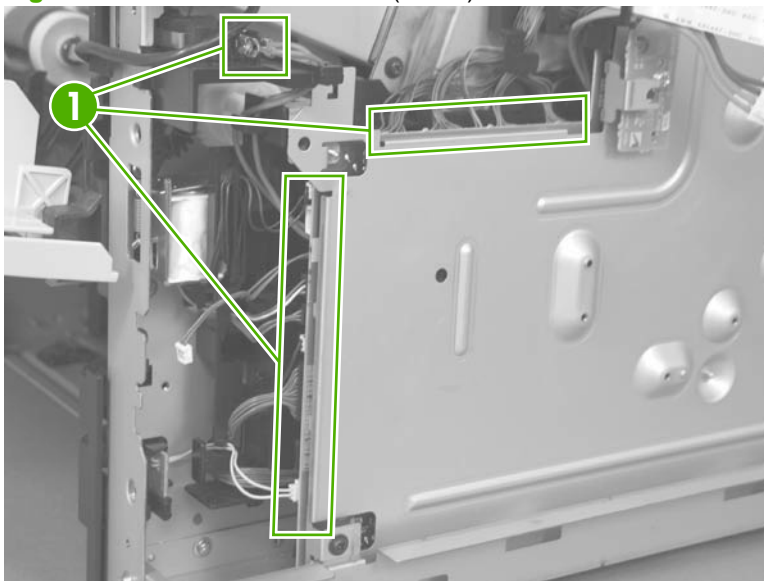
 **NOTE:** As you remove the fan assembly, release the USB wire harness from the retainers along the bottom of the assembly (callout 2).

**Figure 2-99** Removing the ECU (2 of 9)



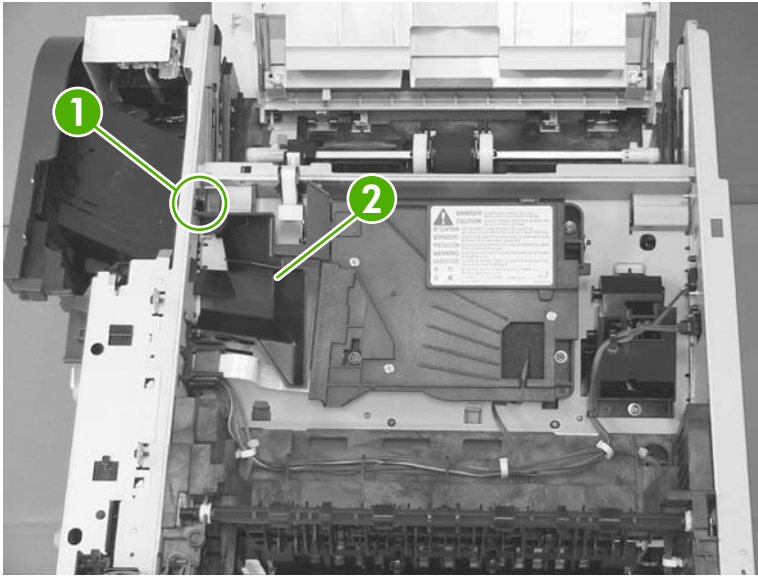
4. Disconnect 12 connectors (callout 1).

**Figure 2-100** Remove the ECU (3 of 9)



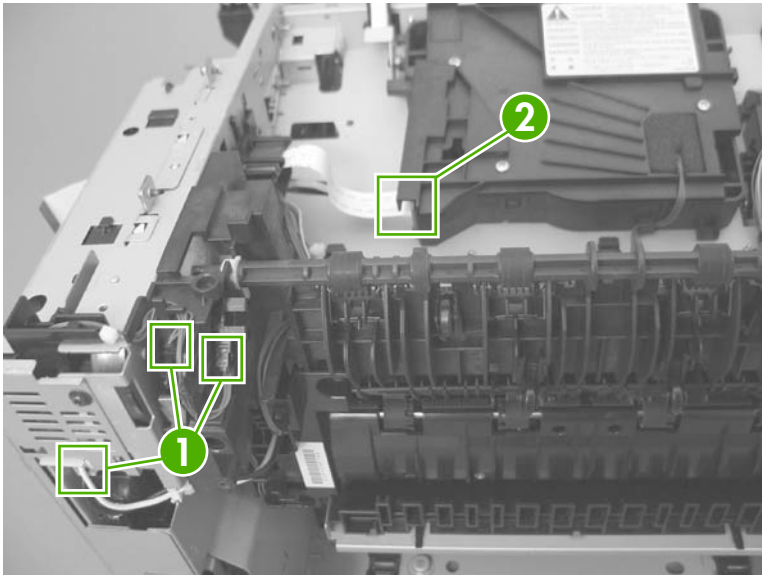
5. Release one tab (callout 1) on the air duct, and then lift the air duct out of the product.

**Figure 2-101** Remove the ECU (4 of 9)



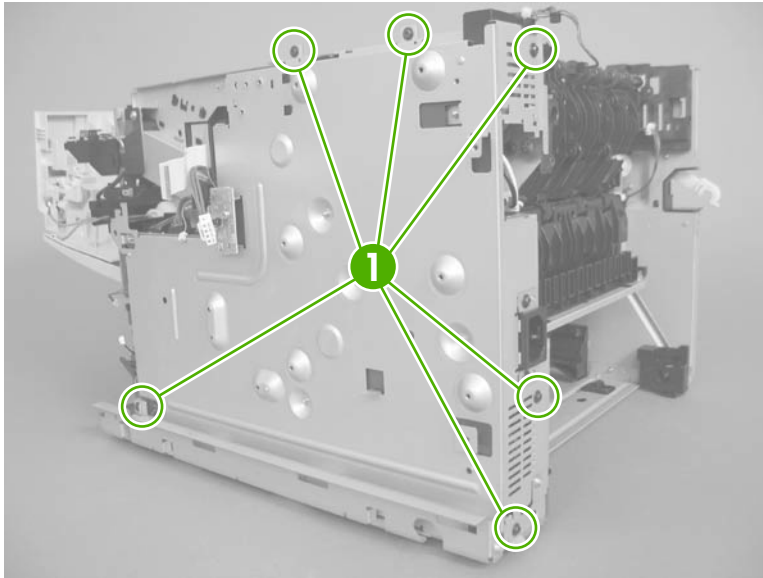
6. Disconnect three connectors (callout 1), one FFC (callout 2), and then release the wire harnesses from the retainers.

**Figure 2-102** Remove the ECU (5 of 9)



7. Remove six screws (callout 1).

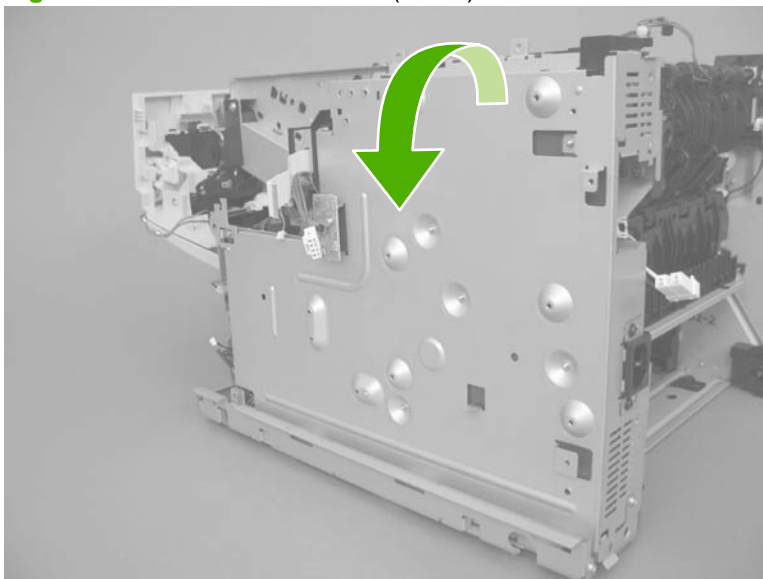
**Figure 2-103** Remove the ECU (6 of 9)



8. Slight lift the ECU up, and then rotate the top of the ECU pan away from the product.

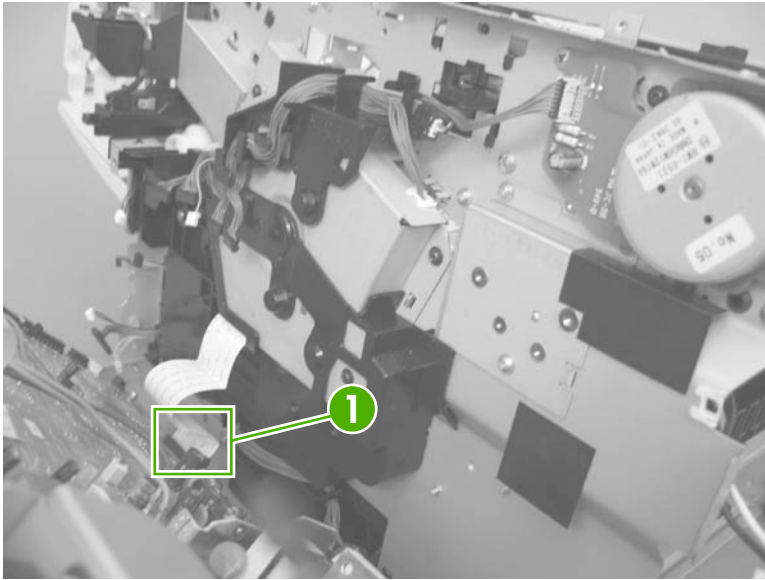
△ **CAUTION:** The ECU is still attached to the product by a FFC. Do not try to completely remove the ECU.

**Figure 2-104** Remove the ECU (7 of 9)




9. Disconnect one FFC (callout 1).

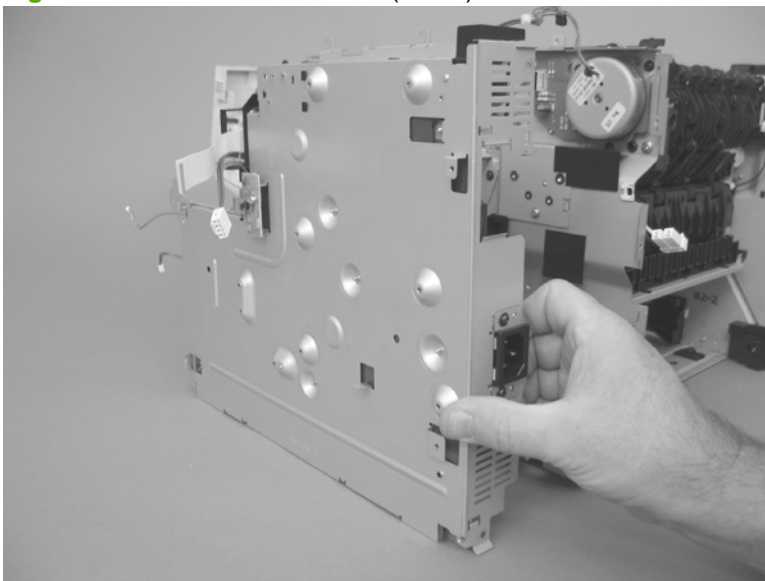
**Figure 2-105** Remove the ECU (8 of 9)



10. Remove the ECU.


 **NOTE:** The ECU and the ECU pan together are a single field-replaceable unit (FRU). You do not have to separate the ECU and the ECU pan.

**Figure 2-106** Remove the ECU (9 of 9)




## Cassette pickup (Tray 2) solenoid or Tray 1 (multipurpose tray) pickup solenoid

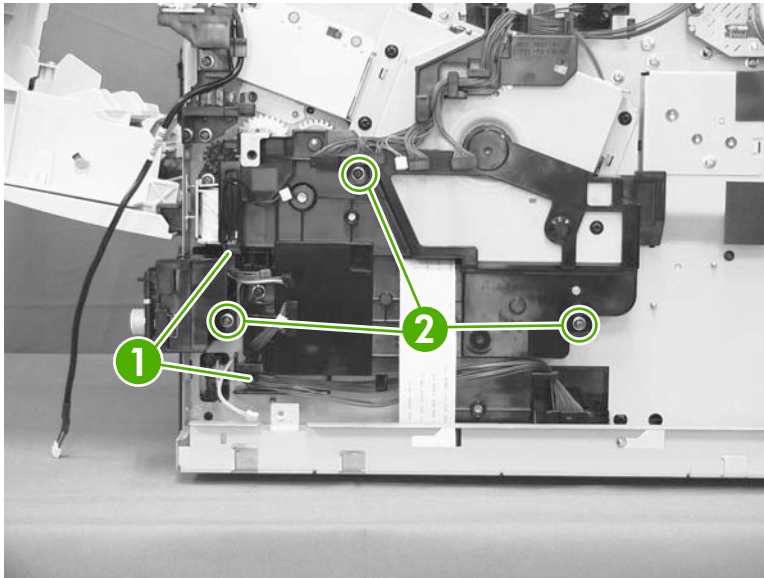
1. Before proceeding, remove the following components:
  - DIMM cover. See [DIMM cover and DIMM on page 57](#).
  - Formatter cover and formatter PCA. See [Formatter cover and formatter PCA on page 60](#).
  - Rear-door assembly. See [Rear-door assembly on page 62](#).
  - Left cover. See [Left cover on page 66](#).
  - Top-right cover. See [Top-right cover on page 73](#).
  - Control panel. See [Control panel on page 74](#).
  - Front-right and right-side cover assembly. See [Front-right and right-side cover assembly on page 76](#).
  - Lower-right cover. See [Lower-right cover and bracket on page 80](#).
  - Top cover. See [Top cover on page 84](#).
  - Power switch assembly. See [Power-switch assembly on page 96](#).

 **TIP:** Removing the power-switch assembly makes it easier to disconnect the connectors at the front of the ECU.


- Engine control unit (ECU). See [Engine control unit \(ECU\) on page 110](#).
2. Release the wire harness from the guides (callout 1), and then remove three screws (callout 2).

 **CAUTION:** Do not try to remove the gear cover after the screws are removed (it is still attached to the solenoid-wire harness).

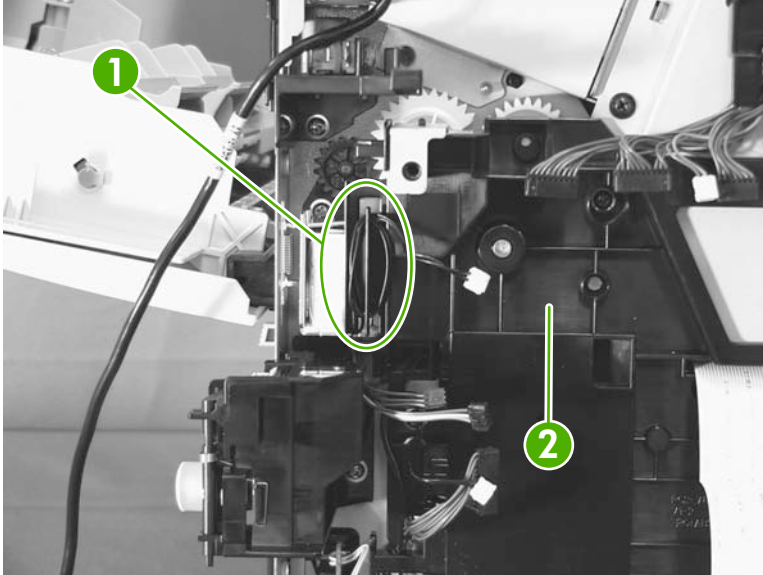
**Figure 2-107** Cassette pickup (Tray 2) or Tray 1 (multipurpose tray) solenoid (1 of 3)



- Carefully unwind the wire harness (callout 1) from the retainer on the gear cover (callout 2), and then remove the cover.

 **Reinstallation tip** When you reinstall the gear cover, make sure that you wrap the solenoid-wire harness around the retainer on and on-half times in a clockwise direction.

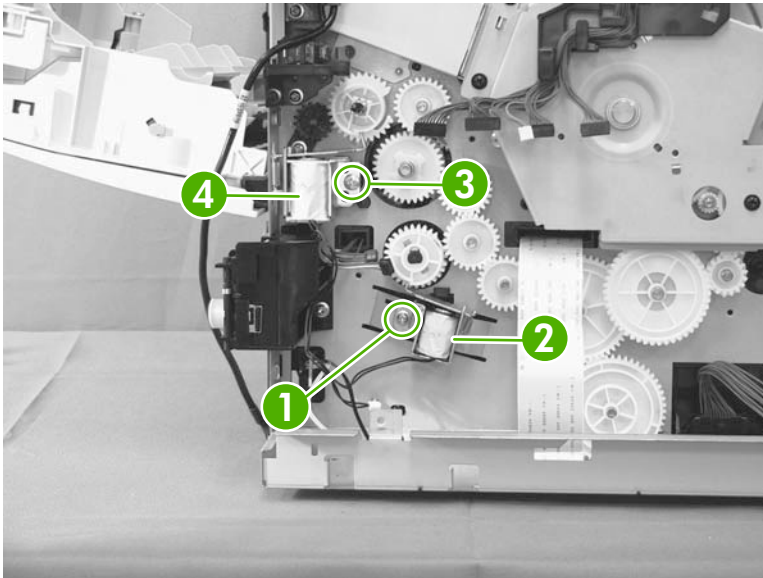
**Figure 2-108** Cassette pickup (Tray 2) or Tray 1 (multipurpose tray) solenoid (2 of 3)



- For the cassette (Tray 2) pickup solenoid:** Remove one screw (callout 1), and then remove the solenoid (callout 2).

**For the Tray 1 (multipurpose tray) pickup solenoid:** Remove one screw (callout 3), and then remove the solenoid (callout 4).

**Figure 2-109** Cassette pickup (Tray 2) or Tray 1 (multipurpose tray) solenoid (3 of 3)






## Fuser motor

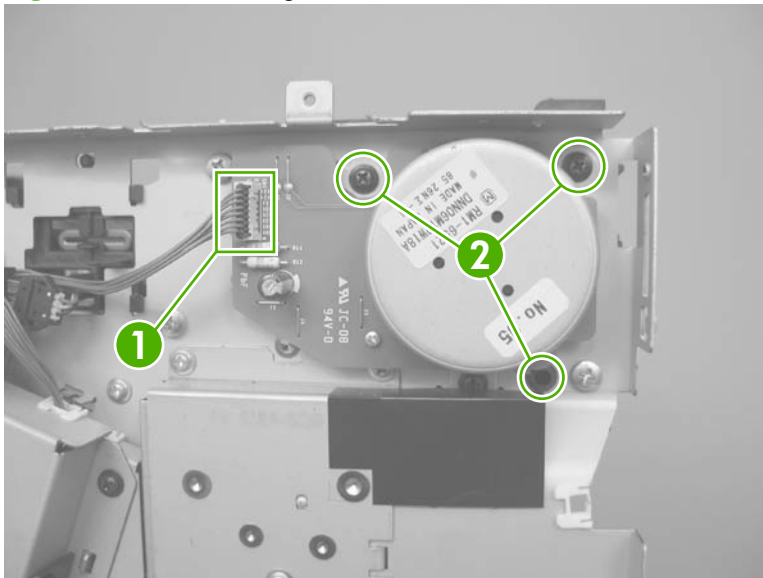
 **WARNING!**  ESD sensitive component.

1. Before proceeding, remove the following components:
  - DIMM cover. See [DIMM cover and DIMM on page 57](#).
  - Formatter cover and formatter PCA. See [Formatter cover and formatter PCA on page 60](#).
  - Rear-door assembly. See [Rear-door assembly on page 62](#).
  - Left cover. See [Left cover on page 66](#).
  - Top-right cover. See [Top-right cover on page 73](#).
  - Control panel. See [Control panel on page 74](#).
  - Front-right and right-side cover assembly. See [Front-right and right-side cover assembly on page 76](#).
  - Lower-right cover. See [Lower-right cover and bracket on page 80](#).
  - Top cover. See [Top cover on page 84](#).
  - Power switch assembly. See [Power-switch assembly on page 96](#).

 **TIP:** Removing the power-switch assembly makes it easier to disconnect the connectors at the front of the ECU.

- Engine controller unit (ECU). See [Engine control unit \(ECU\) on page 110](#).
2. Disconnect one connector (callout 1), remove three screws (callout 2), and then remove the fuser motor.

**Figure 2-110** Removing the fuser motor



## Sub fan and fan duct

1. Before proceeding, remove the following components:

- DIMM cover. See [DIMM cover and DIMM on page 57](#).
- Formatter cover and formatter PCA. See [Formatter cover and formatter PCA on page 60](#).
- Rear-door assembly. See [Rear-door assembly on page 62](#).
- Left cover. See [Left cover on page 66](#).
- Top-right cover. See [Top-right cover on page 73](#).
- Control panel. See [Control panel on page 74](#).
- Front-right and right-side cover assembly. See [Front-right and right-side cover assembly on page 76](#).
- Lower-right cover. See [Lower-right cover and bracket on page 80](#).
- Top cover. See [Top cover on page 84](#).
- Power switch assembly. See [Power-switch assembly on page 96](#).

---

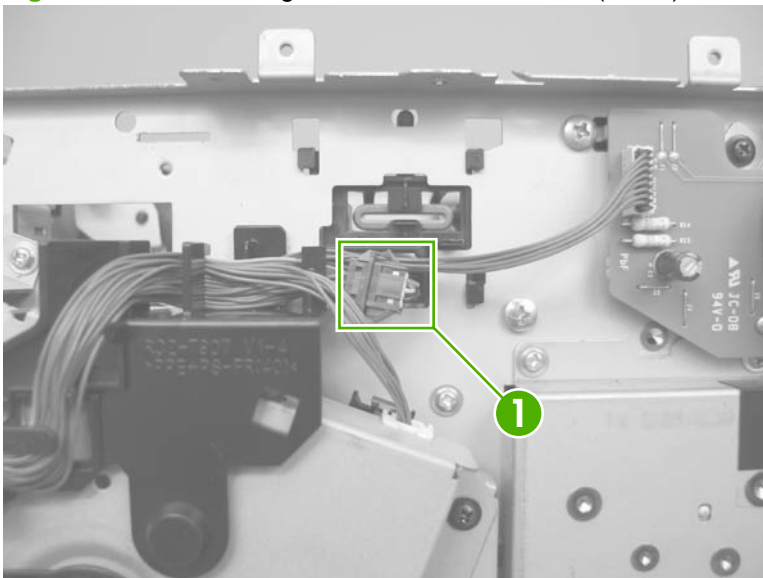
💡 **TIP:** Removing the power-switch assembly makes it easier to disconnect the connectors at the front of the ECU.

---

- Engine controller unit (ECU). See [Engine control unit \(ECU\) on page 110](#).

2. Disconnect one connector (callout 1).

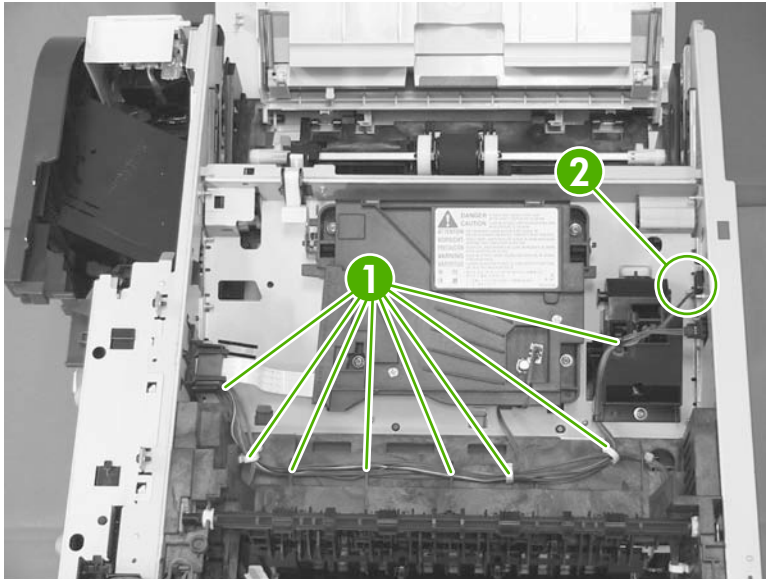
**Figure 2-111** Removing the sub fan and fan duct (1 of 5)





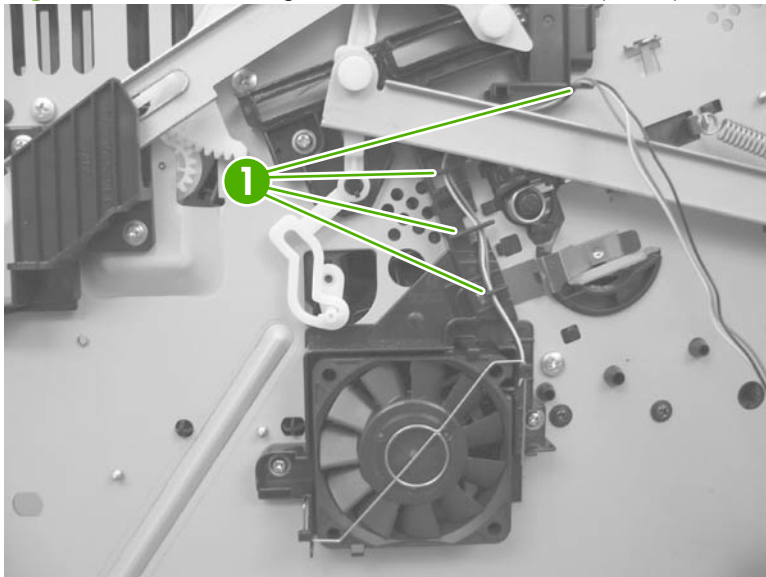
3. Release the wire harness from the retainers (callout 1), and then feed the wire harness through the opening in the chassis (callout 2).

**Figure 2-112** Removing the sub fan and fan duct (2 of 5)




4. Release the wire harness from the retainers (callout 1).

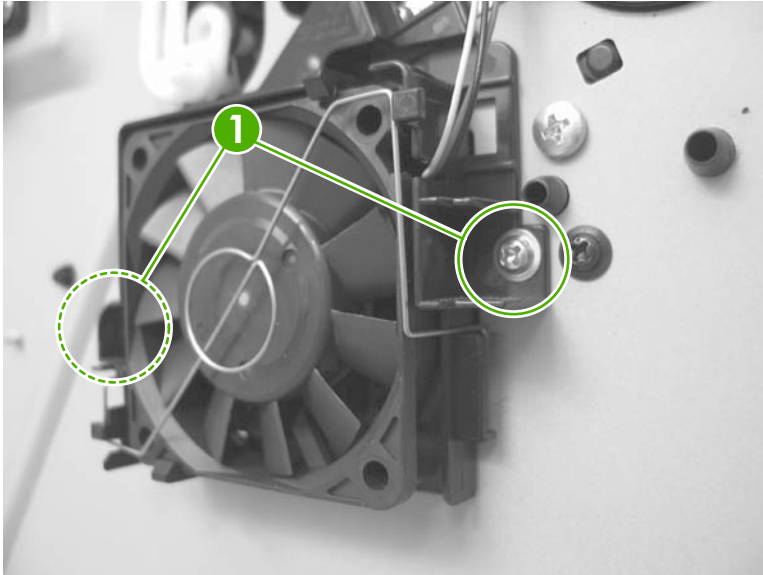
**Figure 2-113** Removing the sub fan and fan duct (3 of 5)




- To remove the fan and duct:** Remove two screws (callout 1), and then carefully remove the fan and duct.

 **NOTE:** If necessary, release the metal static clip, release two tabs and separate the fan from the duct.

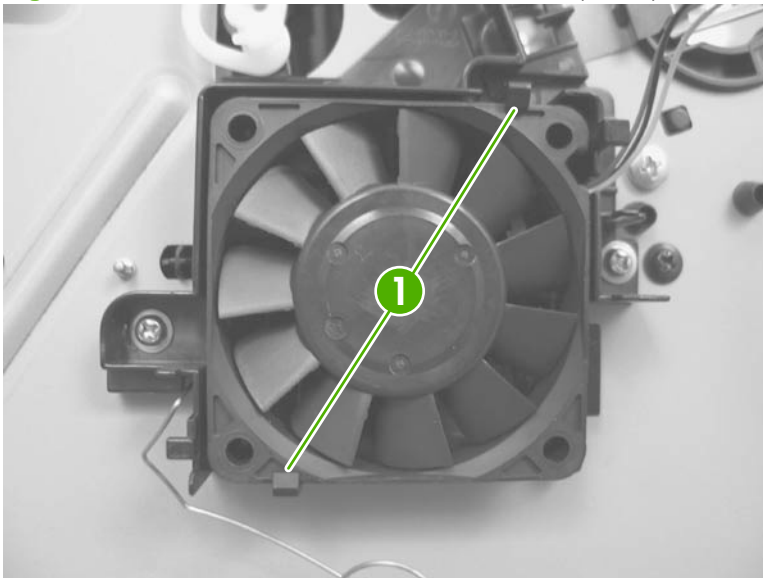
**Figure 2-114** Remove the sub fan and fan duct (4 of 5)



- To remove the fan only:** Release the metal static clip, release two tabs (callout 1), and then remove the sub fan.

 **Reinstallation tip** If you install a replacement sub fan, the air must flow into the product. Arrows embossed on the fan frame indicate air flow direction.

**Figure 2-115** Remove the sub fan and fan duct (5 of 5)




## High-voltage power supply (HVPS)

1. Before proceeding, remove the following components:

- DIMM cover. See [DIMM cover and DIMM on page 57](#).
- Formatter cover and formatter PCA. See [Formatter cover and formatter PCA on page 60](#).
- Rear-door assembly. See [Rear-door assembly on page 62](#).
- Left cover. See [Left cover on page 66](#).
- Top-right cover. See [Top-right cover on page 73](#).
- Control panel. See [Control panel on page 74](#).
- Front-right and right-side cover assembly. See [Front-right and right-side cover assembly on page 76](#).
- Lower-right cover. See [Lower-right cover and bracket on page 80](#).
- Top cover. See [Top cover on page 84](#).
- Power switch assembly. See [Power-switch assembly on page 96](#).


---

 **TIP:** Removing the power-switch assembly makes it easier to disconnect the connectors at the front of the ECU.

---

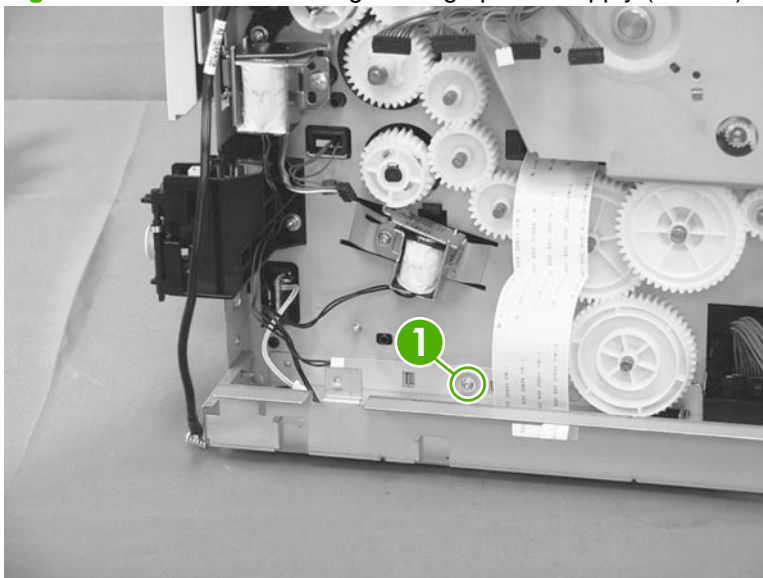
- **Duplex models only:** Duplex media-feed assembly. See [Duplex media-feed assembly on page 104](#).
- Engine control unit (ECU). See [Engine control unit \(ECU\) on page 110](#).
- Sub fan and duct. See [Sub fan and fan duct on page 118](#).

2. Remove one screw (callout 3).

 **NOTE:** In this figure the gear cover is shown removed for clarity. Do not remove the gear cover. The gears behind the cover are not captive and can easily be dislodged if the cover is removed.

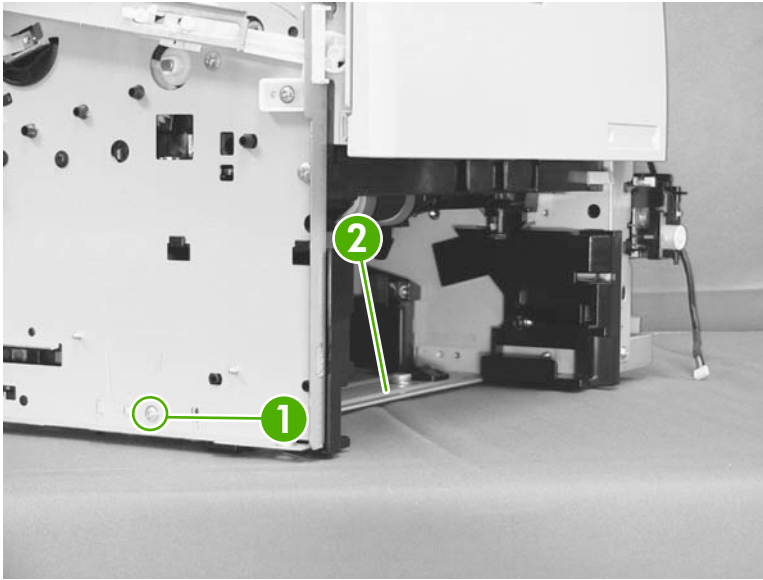
---

**Figure 2-116** Remove the high-voltage power supply (1 of 11)



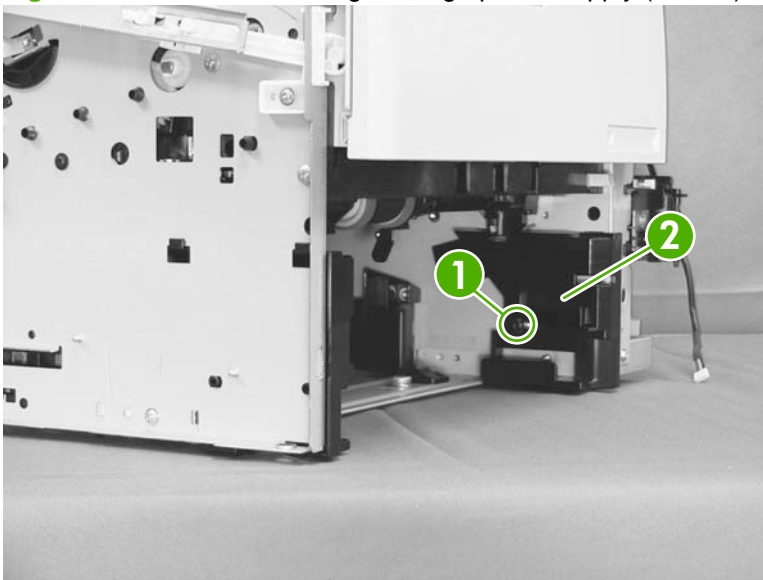
3. Remove one screw (callout 1), and then remove the base plate (callout 2).

**Figure 2-117** Remove the high-voltage power supply (2 of 11)



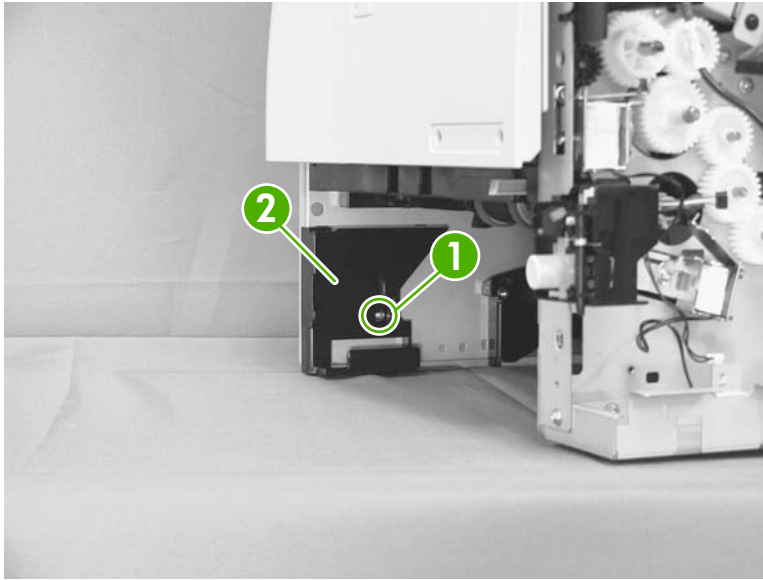
4. Remove one screw (callout 1), and then remove the right-side guide (callout 2).

**Figure 2-118** Remove the high-voltage power supply (3 of 11)



5. Remove one screw (callout 1), and then remove the left-side guide (callout 2).

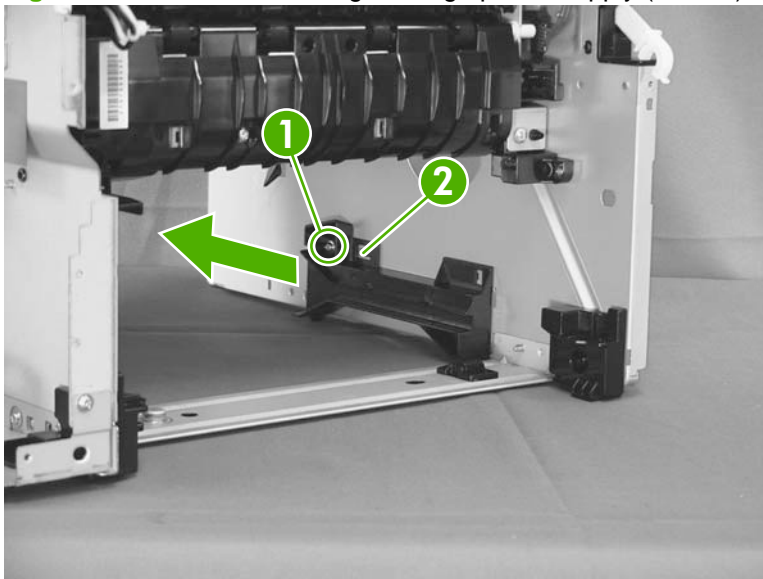
**Figure 2-119** Remove the high-voltage power supply (4 of 11)



6. Remove one screw (callout 1), release one tab (callout 2) and then slide the guide toward the front of the product to release it.

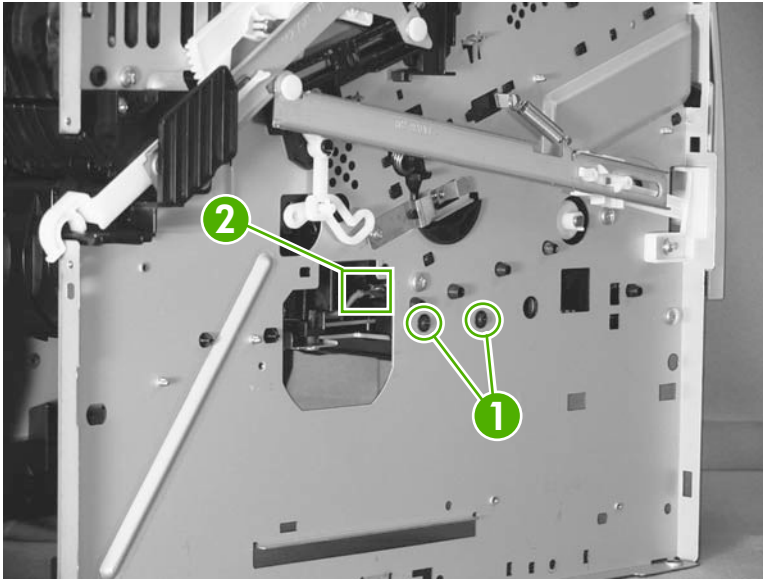
Remove the guide.

**Figure 2-120** Remove the high-voltage power supply (5 of 11)



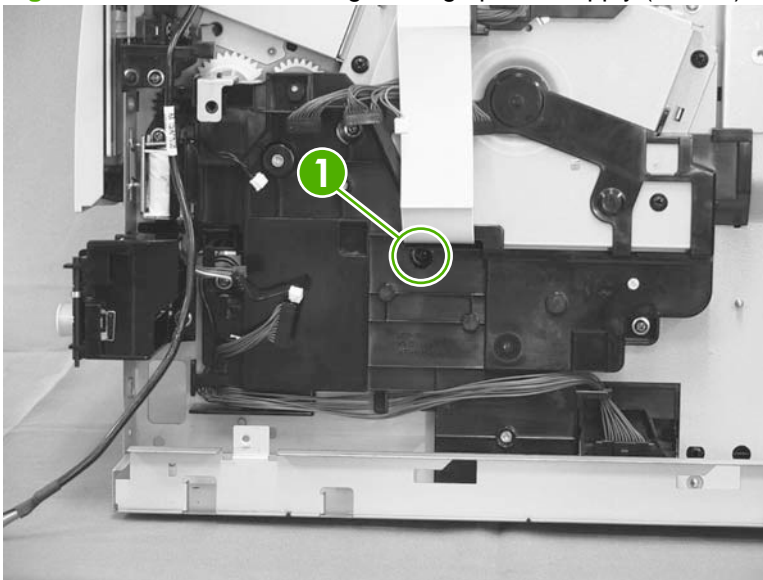
7. Disconnect one connector (callout 1), and then remove two screws (callout 2).

**Figure 2-121** Remove the high-voltage power supply (6 of 11)



8. Remove one screw (callout 1).

**Figure 2-122** Remove the high-voltage power supply (7 of 11)



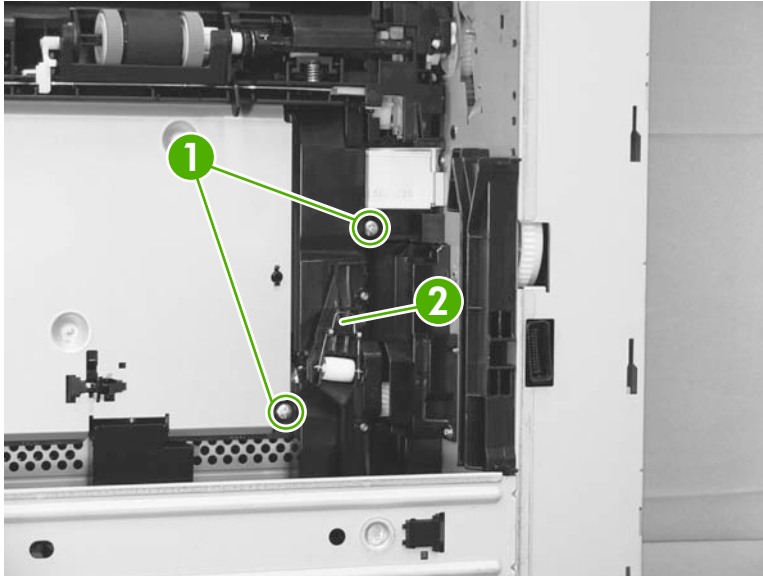


- Place the product face-side up. Remove two screws (callout 1), and then remove the positioning guide (callout 2).

△ **CAUTION:** When you place the product face-side up, do not damage the rear-door link arm on the left side of the product.

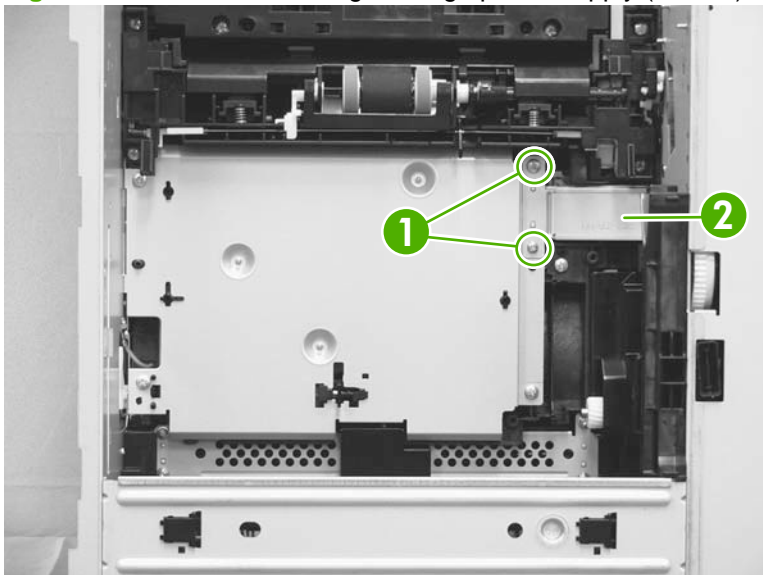
📄 **NOTE:** The positioning guide might appear to still be fastened to the product. You might have to use slight force to separate it from the product.

**Figure 2-123** Remove the high-voltage power supply (8 of 11)



- Remove two screws (callout 1), and then remove the plate (callout 2).

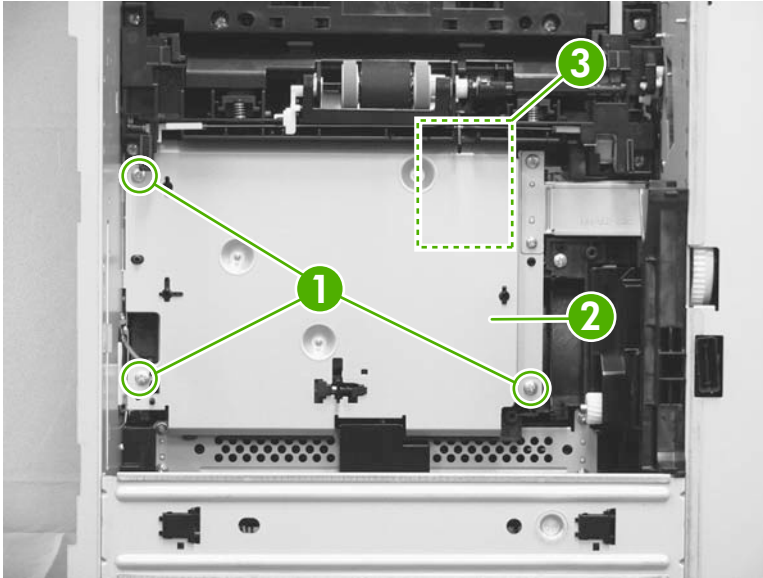
**Figure 2-124** Remove the high-voltage power supply (9 of 11)




11. Remove three screws (callout 1), and then remove the high-voltage power supply (callout 2).

 **NOTE:** Disconnect two connectors and one FFC (callout 3) on the HPVS as you separate the it from the product.

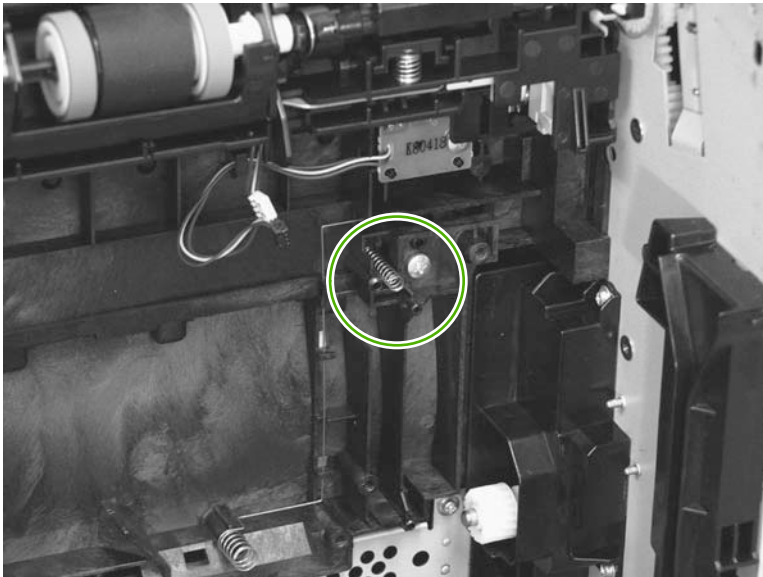
**Figure 2-125** Remove the high-voltage power supply (10 of 11)



12. After the high-voltage power supply is removed, make sure that the spring on the chassis is in place.

 **CAUTION:** This spring is not captive and can easily be lost.

**Figure 2-126** Remove the high-voltage power supply (11 of 11)





---

# 3 Solve problems

- [Solve problems checklist](#)
- [Menu map](#)
- [Troubleshooting process](#)
- [Tools for troubleshooting](#)
- [Clear jams](#)
- [Solve paper-handling problems](#)
- [Solve image-quality problems](#)
- [Clean the product](#)
- [Solve performance problems](#)
- [Solve connectivity problems](#)
- [Service mode functions](#)
- [Product updates](#)

# Solve problems checklist

The following checklist contains basic questions that you can ask the customer to help define problems quickly.

**Table 3-1 Initial troubleshooting checklist**

Environment	<ul style="list-style-type: none"><li>• Is the product installed in a suitable environment? See <a href="#">Environmental specifications on page 309</a>.</li><li>• Is the product installed on a solid, level surface?</li><li>• Is the supply voltage (from the wall receptacle) within the product's rated voltage (see <a href="#">Electrical specifications on page 308</a>)?</li><li>• Is the power cord fully seated into both the product and the electrical receptacle in the wall?</li><li>• Is the product exposed to direct sunlight?</li></ul>
Media	<ul style="list-style-type: none"><li>• Does the customer use only supported print media?</li><li>• Is the media in good condition (no curl, folds, or other flaws)?</li><li>• Is the media stored correctly and within environmental limits?</li><li>• Is the correct side of the page printed on first?</li><li>• Is long-grain paper being used?</li></ul>
Input trays	<ul style="list-style-type: none"><li>• Is the correct amount of media loaded in the tray (not stacked above the arrows embossed in the tray)?</li><li>• Is the media placed in the tray correctly?</li><li>• The sliding media guides in the tray might be too tight to too loose.</li></ul>
	<p><b>Correctly adjust the sliding media guides</b></p> <ol style="list-style-type: none"><li>1. Remove the tray from the product.</li><li>2. Remove the stack of paper.</li><li>3. Slide the media guides until the guide indicators align with the size of paper that you are using. <b>NOTE:</b> The supported paper sizes for the tray are embossed in the tray.</li><li>4. Replace the stack of paper.</li><li>5. Install the tray in the product, and resend the print job.</li></ol> <ul style="list-style-type: none"><li>• Is the tray cassette installed correctly in the product?</li></ul>
Print cartridge	<ul style="list-style-type: none"><li>• Is the print cartridge installed correctly?</li></ul>
Fuser	<ul style="list-style-type: none"><li>• Is the fuser installed correctly?</li></ul>
Covers and doors	<ul style="list-style-type: none"><li>• Is the cartridge door fully closed?</li><li>• Is the rear door (face-up delivery) fully closed?</li></ul>

**Table 3-1 Initial troubleshooting checklist (continued)**


---

Condensation	<ul style="list-style-type: none"><li>• Does condensation occur following a temperature change (particularly in winter following cold storage)? If so, wipe off the affected parts or leave the product on for 10 to 20 minutes and then try to resume printing.</li><li>• Was a print cartridge opened soon after it was moved from a cold room to a warm one? If so, allow the print cartridge and the product to acclimate to room temperature for one to two hours.</li></ul>
Miscellaneous	<ul style="list-style-type: none"><li>• Are any non-HP components installed? Check for any non-HP components (print cartridge, memory modules, and EIO cards) installed in the product and remove them. Hewlett-Packard recommends the use of HP components in its products.</li><li>• Network models only: Remove the product from the network, and make sure that the failure is with the product before beginning troubleshooting.</li></ul>

---

## Menu map

The menu map can be an important troubleshooting tool. The menu map shows each control-panel menu and submenu to aid navigation through the menu system. Print the menu map from the control panel by completing the following steps.

1. Press the **Menu** button .
2. Press the down arrow ▼ button or the up arrow ▲ button to navigate to the **INFORMATION** menu, and then press the **OK** button.
3. Press the down arrow ▼ button or the up arrow ▲ button to navigate to the **PRINT MENU MAP** sub menu, and then press the **OK** button to print the pages.

# Troubleshooting process

## Determine the problem source

When the product malfunctions or encounters an unexpected situation, the product control panel alerts you to the situation. This chapter provides steps for correcting problems.

1	Is the product on and does a readable message appear?	Follow the power-on troubleshooting checks following this table.
Power on	Yes ▼ No ▲	After the control-panel display is functional, go to step 2.
2	Does <b>Ready</b> appear on the control-panel display?	If an error message appears, see <a href="#">Interpret control-panel messages on page 197</a> .
Control-panel messages	Yes ▼ No ▲	After the errors have been corrected, go to step 3.
3	Open the <b>INFORMATION</b> menu and print the configuration pages. Are all the accessories installed?	If accessories that are installed are not listed on the configuration pages, remove the accessory and reinstall it.
Information pages	Yes ▼ No ▲	After evaluating the configuration pages, go to step 4.
4	Does the print quality meet customer requirements?	Compare images with the sample defects in <a href="#">Solve image-quality problems on page 247</a> .
Image quality	Yes ▼ No ▲	When the print quality is acceptable, go to step 5.
5	Can the customer print successfully from the host computer?	Verify that all I/O cables are connected correctly and that a valid IP address is listed on the Jetdirect configuration page.
Interface	Yes. This is the end of the basic troubleshooting process. No ▲	If error messages appear on the control-panel display, see <a href="#">Interpret control-panel messages on page 197</a> .
		When the customer can print from the host computer, this is the end of the basic troubleshooting process.

## Power subsystem

### Power-on checks

Turn on the power. If the control-panel display remains blank or if it displays random patterns or asterisks, perform the power-on checks to find the cause of the problem.

1. Verify that the product is plugged into an active electrical outlet that delivers the correct voltage.
2. Verify that the power switch is in the ON position.
3. Make sure that the main fan on the right side runs for a short time.
  - If the control-panel display is blank, but the main fan runs after the power is turned on, print an engine test page to determine whether the problem is with the control-panel display, the formatter, or other components. See [Engine diagnostics on page 134](#).
  - The overcurrent/overvoltage protection circuit in the low-voltage power supply unit might be running. Turn the printer off, unplug the power cord, and turn the printer on. If the printer does not function, the fuse melts, or the power supply is malfunctioning, replace the engine controller unit. See [Engine control unit \(ECU\) on page 110](#).
  - Verify that the LEDs at the back of the product on the formatter, are functioning correctly. See [LED diagnostics on page 133](#).
4. Remove any HP Jetdirect or other EIO cards, and then turn off and turn on the product.

# Tools for troubleshooting

## Individual component diagnostics

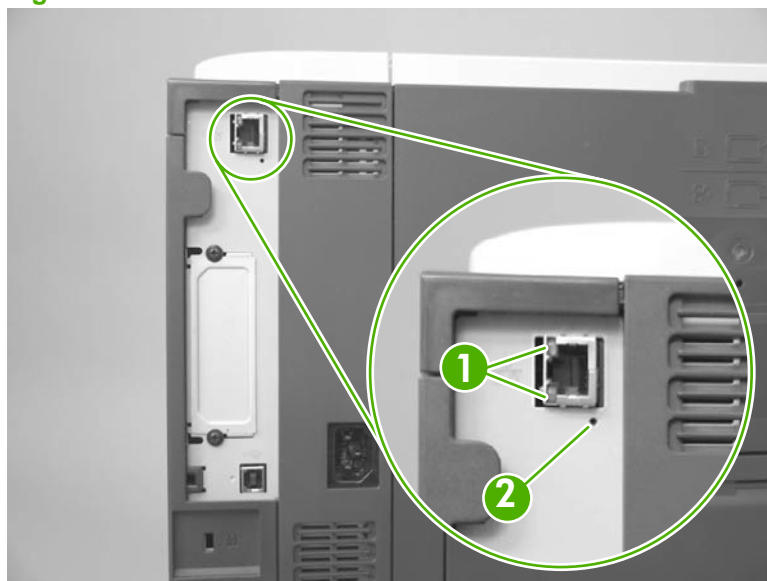
### LED diagnostics

LEDs on the formatter can help identify and troubleshoot product problems.

#### LED indicators

Three LEDs on the formatter indicate that the product is functioning correctly.

**Figure 3-1** Formatter LEDs



1	HP Jetdirect LEDs
2	Heartbeat LED

#### Formatter heartbeat LED

The heartbeat LED indicates that the formatter is functioning correctly. While the product is initializing after you turn it on, the LED blinks rapidly, and then turns off. When the product has finished the initialization sequence, the heartbeat LED pulses on and off.

The heartbeat LED performs the following sequences:

1. The LED blinks when the product power is on.
2. If the light is not blinking, check the following:
  - Reseat the formatter connectors.
  - Replace the memory.
  - Replace the formatter.
3. If the control panel display does not illuminate, perform an engine test to check the engine (see [Engine-test button on page 134](#)). You must have paper loaded in Tray 2 for the engine test.

## HP Jetdirect LEDs


The embedded HP Jetdirect print server has two LEDs. The yellow LED indicates network activity, and the green LED indicates the link status. A blinking yellow LED indicates network traffic. If the green LED is off, a link has failed.

For link failures, check the network cable connections.

For nonlink errors, print a configuration page. The second page is the HP Jetdirect configuration page. Examine this page for any inconsistencies among the network settings.

## Engine diagnostics


Printing test pages helps you determine whether or not the product engine and the formatter are functioning.

 **NOTE:** Information pages also can be used to solve product issues. For information about printing information pages, see the product user guide.

## Engine-test button

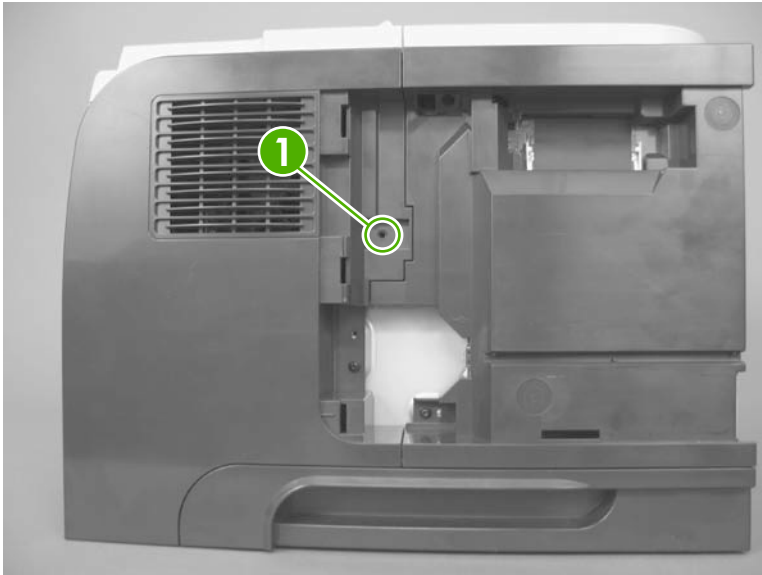
To verify that the product engine is functioning, print an engine-test page.

## Print the engine test pages

 **NOTE:** A damaged formatter might interfere with the engine test. If the engine test page does not print, try removing the formatter and performing the engine test again. If the engine test is then successful, the problem is in the formatter, the control panel, or the cable that connects them together.

1. Remove the DIMM cover. See [DIMM cover and DIMM on page 57](#).
2. Press the engine test-page button (callout 1).

**Figure 3-2** Locating the engine-test-page switch




The test page should have a series of horizontal lines. The test page prints from the last tray that the product used to print, unless the product has been turned off and then turned on again since the most recent print job. If the product has been turned off and then on again since the most recent print job,



then the page will print from Tray 2. The product continuously prints test pages as long as the test-page switch is depressed. The product will not print a test page if it is in Sleep mode.

### Print formatter test pages

If the engine test was successful with the formatter removed, reinstall the formatter and then print a configuration page to test the functionality of the formatter.


1. Press the **Menu** button .
2. Press the down arrow ▼ button or the up arrow ▲ button to navigate to the **INFORMATION** menu.
3. Press the **OK** button to select the menu.
4. Press the down arrow ▼ button or the up arrow ▲ button to navigate to the **PRINT CONFIGURATION** option.
5. Press the **OK** button to select the option and print the page.

### Fuser test page

This test helps to determine if the fuser needs to be replaced, or if it has exceeded its expected life.


A customer can complete the steps below and describe the results to the HP Customer Care representative. If the page shows no problems, the fuser does not need replacing.


Replace the fuser (see [Fuser on page 100](#)) if the page shows the following problems:

- Fuser offset repeats in the boxes on the page
  - Lines or streaks on the page (usually down the edges of the page) indicate fuser contamination
1. Press the **Menu** button .
  2. Press the down arrow ▼ button or the up arrow ▲ button to navigate to the **DIAGNOSTICS** menu, and then press the **OK** button.
  3. Press the down arrow ▼ button or the up arrow ▲ button to navigate to the **PRINT FUSER TEST PAGE** menu, and then press the **OK** button.

## Paper-path test (and automatic sensors test)


### Paper-path test

1. Press the **Menu** button .
2. Press the down arrow ▼ button or the up arrow ▲ button to navigate to the **DIAGNOSTICS** menu, and then press the **OK** button.
3. Press the down arrow ▼ button or the up arrow ▲ button to navigate to the **PAPER PATH TEST** sub menu, and then press the **OK** button.
4. Select the paper path test options for the test you want to run

 **NOTE:** Values that have an asterisk (\*) are the factory-default values. Some menu items have no default.

Item	Sub-item	Values	Description
<b>PAPER PATH TEST</b>			Tests the paper-handling features of the product, such as the configuration of the trays.
	<b>PRINT TEST PAGE</b>		Generates a page for testing the paper-handling features. You must define the path for the test to test specific paper paths.
	<b>SOURCE</b>	<b>ALL TRAYS</b> <b>TRAY 1</b> <b>TRAY 2*</b> <b>TRAY 3</b> <b>TRAY 4</b>	Specifies whether the test page is printed from all trays or from a specific tray.
	<b>DUPLEX</b>	<b>OFF</b> <b>ON</b>	Determines whether the duplexer is used in the test.
	<b>COPIES</b>	<b>1*</b> <b>10</b> <b>50</b> <b>100</b> <b>500</b>	Determines how many pages to send from the specified source as part of the test.

### Paper-path sensors test

1. Press the **Menu** button .
2. Press the down arrow ▼ button or the up arrow ▲ button to navigate to the **DIAGNOSTICS** menu, and then press the **OK** button.
3. Press the down arrow ▼ button or the up arrow ▲ button to navigate to the **PAPER PATH SENSORS** sub menu, and then press the **OK** button.

4. Select the paper path test options for the test you want to run
5. Press the **OK** button to begin the test, and then observe the control-panel designators (see the table below). The sensors should display a 1 status as paper passes by the sensors.

**Table 3-2 Paper-path sensors**

Sensor name	Sensor number	Replacement part number	Description	Paper-path sensor test name
TOP sensor	PS215	RM1-6511-000CN	Photointerrupter	A TOP sensor
Fuser delivery sensor	PS2	110 Volt: RM1-6274-000CN  220 Volt: RM1-6319-000CN	Photointerrupter	B Fuser output sensor
Duplex media-feed sensor	PS502	RM1-6280-000CN	Photointerrupter	C Duplex sensor
Media width sensor	PS225	RM1-6512-000CN	Photointerrupter	D Paper width sensor 1
Paper feeder media-feed sensor - Tray 3 <sup>1</sup>	PS8008	CE530-69001	Photointerrupter	E Tray 3 feed sensor
Paper feeder media-feed sensor - Tray 4 <sup>1</sup>	PS8008	CE530-69001	Photointerrupter	F Tray 4 feed sensor

<sup>1</sup> Tray 3 and Tray 4 use a PS8008 sensor.

## Sensor test (interactive)

Performs tests to determine whether the paper-path sensors are operating correctly.

**Table 3-3 MANUAL SENSOR TEST (special mode test)**

Sensor or switch name	Sensor number	Replacement part number	Description	Paper-path sensor test name	Testing of sensor
TOP sensor	PS215	RM1-6511-000CN	Photointerrupter	A TOP sensor	Open the cartridge door, remove the print cartridge, raise the registration shutter, and then use a screwdriver to activate the sensor.
Fuser delivery sensor	PS2	110 Volt: RM1-6274-000CN  220 Volt: RM1-6319-000CN	Photointerrupter	B Fuser output sensor	Open the rear door, and then use a screwdriver to activate the sensor.
Duplex media-feed sensor	PS502	RM1-6280-000CN (power supply)	Photointerrupter	C Duplex sensor	Remove the Tray 2 cassette, push the green button to drop the duplex tray, and then raise the tray.
Media width sensor	PS225	RM1-6512-000CN	PCA	D Paper width sensor 1	Open the cartridge door, remove the print cartridge, and then lift the registration flap to activate the sensor.

**Table 3-3 MANUAL SENSOR TEST (special mode test) (continued)**

Sensor or switch name	Sensor number	Replacement part number	Description	Paper-path sensor test name	Testing of sensor test name
Paper feeder media-feed sensor - Tray 3 <sup>1</sup>	PS8008	(Replace feeder unit)	Photointerrupter	E Tray 3 feed sensor	Remove the Tray 2 cassette, use a small screwdriver to activate the sensor through the small slot toward the front of the product.
Paper feeder media-feed sensor - Tray 4 <sup>1</sup>	PS8008	(Replace feeder unit)	Photointerrupter	F Tray 4 feed sensor	Remove the Tray 3 cassette, use a small screwdriver to activate the sensor through the small slot toward the front of the product.
Face-down media tray media-full sensor	PS4	Photo interruptor: WG8-5696-000CN  Top-cover flag: RM1-6289-000CN	Photointerrupter	G FD tray full sensor	Lift the face-down tray output levers to activate the sensor.
Rear cover open sensor	PS1	WG8-5696-000CN	Photointerrupter	H Face-up detect sensor	Open the rear door to about 15 degrees.
Cartridge-door switch	SW501	WC4-5171-000CN	Switch	I Cartridge-door open switch	Open the cartridge door.
Face-up detect sensor	PS8001	WG8-5696-000CN	Photointerrupter	J Rear cover open sensor	Open the rear door to about 90 degrees.
MP tray media-presence sensor	PS205	RM1-6510-000CN	Photointerrupter	K Tray 1 paper sensor	Push the sensor lever to the right of the center of the tray, and hold it there for 3 seconds.
Cassette media-presence sensor	PS3	Currently not replaceable	Photointerrupter	L Tray 2 paper sensor	Remove the Tray 2 cassette, and then push the sensor lever.
Tray 2 cassette presence switch	SW235	RM1-6487-000CN (tray sensor PCA)	Switch	M Tray 2 detect sensor	Remove the Tray 2 cassette, and then reinstall it.

<sup>1</sup> Tray 3 and Tray 4 use a PS8008 sensor.

**Table 3-4 MANUAL SENSOR TEST 2 (special mode test)**



Sensor or switch name	Sensor number	Replacement part number	Description	Paper-path sensor test name	Testing of sensor test name
Paper feeder Tray 3 cassette media-presence sensor <sup>1</sup>	PS451	CE530-69001	Photointerrupter	N Tray 3 paper sensor	Remove the Tray 3 cassette, and then push the sensor lever.
Paper feeder Tray 3 cassette presence sensor <sup>1</sup>	PS461	CE530-69001	Photointerrupter	O Tray 3 detect sensor	Remove the Tray 3 cassette, and then reinstall it.



**Table 3-4 MANUAL SENSOR TEST 2 (special mode test) (continued)**

Sensor or switch name	Sensor number	Replacement part number	Description	Paper-path sensor test name	Testing of sensor
Paper feeder Tray 4 cassette media-presence sensor <sup>1</sup>	PS451	CE530-69001	Photointerrupter	P Tray 4 paper sensor	Remove the Tray 4 cassette, and then push the sensor lever.
Paper feeder Tray 4 cassette presence sensor <sup>1</sup>	PS461	CE530-69001	Photointerrupter	Q Tray 3 detect sensor	Remove the Tray 4 cassette, and then reinstall it.

<sup>1</sup> Tray 3 and Tray 4 use PS451 and PS461 sensors.

### Access the MANUAL SENSOR TEST or the MANUAL SENSOR TEST 2 in the DIAGNOSTICS menu.

1. Press the **Menu** button .
2. Press the down arrow ▼ button or the up arrow ▲ button to navigate to the **DIAGNOSTICS** menu, and then press the **OK** button.
3. Press the down arrow ▼ button or the up arrow ▲ button to navigate to the **MANUAL SENSOR TEST** or **MANUAL SENSOR TEST 2** menu, and then press the **OK** button.
4. Press the down arrow ▼ button or the up arrow ▲ button to highlight a test, and then press the **OK** button to select the test.
5. To exit the diagnostic test, press the stop button , and then select **EXIT DIAGNOSTICS**.

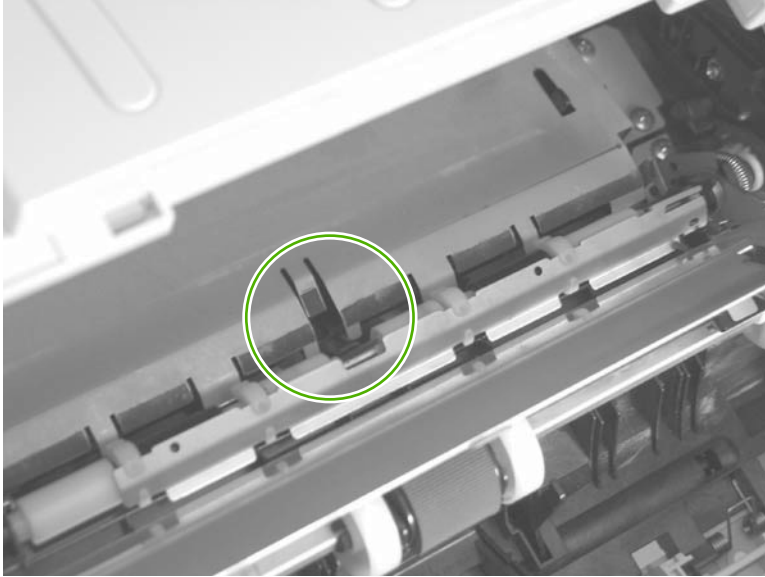
 **NOTE:** Menus are not available during a test. During a test, the **OK** button functions like the stop button .

### A TOP (Top-of-Page) sensor

Test the TOP sensor (PS215)

1. Open the cartridge door, and then remove the print cartridge.
2. Raise the registration shutter.
3. Use a small screwdriver to activate the TOP sensor.

**Figure 3-3** Test the TOP sensor



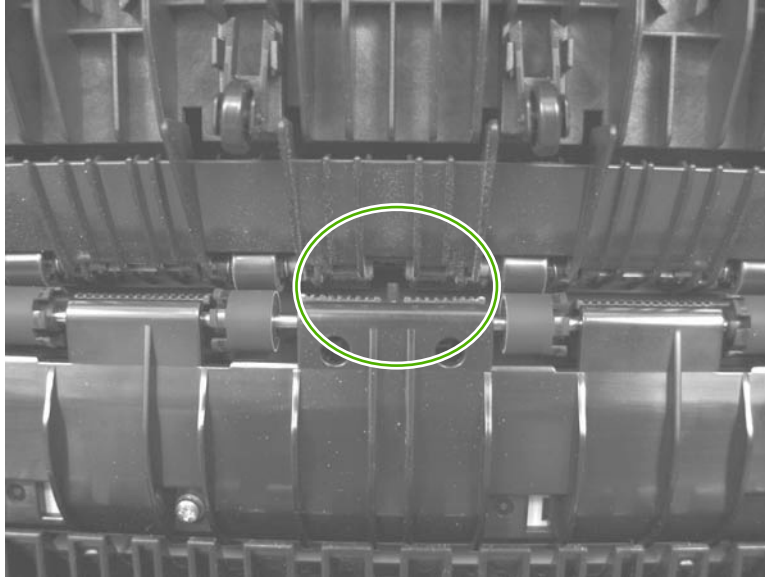
4. Check the control-panel display for sensor response.
5. If there is no response, replace the TOP sensor.

## B Fuser output sensor

Test the fuser delivery sensor (PS2)

1. Open the rear door.
2. Slowly insert a piece of paper to activate the fuser delivery sensor.

**Figure 3-4** Test the fuser delivery sensor



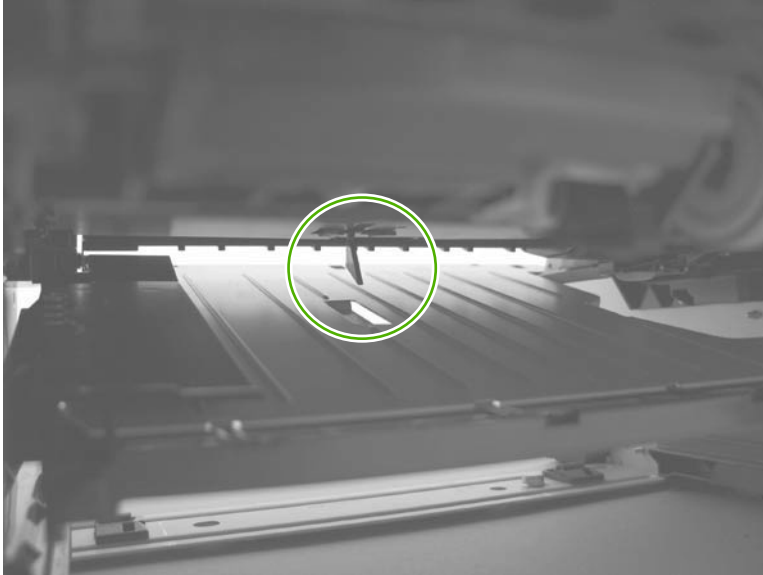
3. Check the control-panel display for a sensor response.
4. If there is no response, replace the fuser.

## C Duplex sensor

Test the duplex media-feed sensor (PS502)

1. Remove the Tray 2 cassette.
2. Press the green lever to release the duplex media-feed assembly (metal tray).
3. Raise the duplex media-feed assembly until it snaps into place.

**Figure 3-5** Test the duplex media-feed sensor



4. Check the control-panel display for sensor response.
5. If there is no response, replace the high-voltage power supply (duplex model).

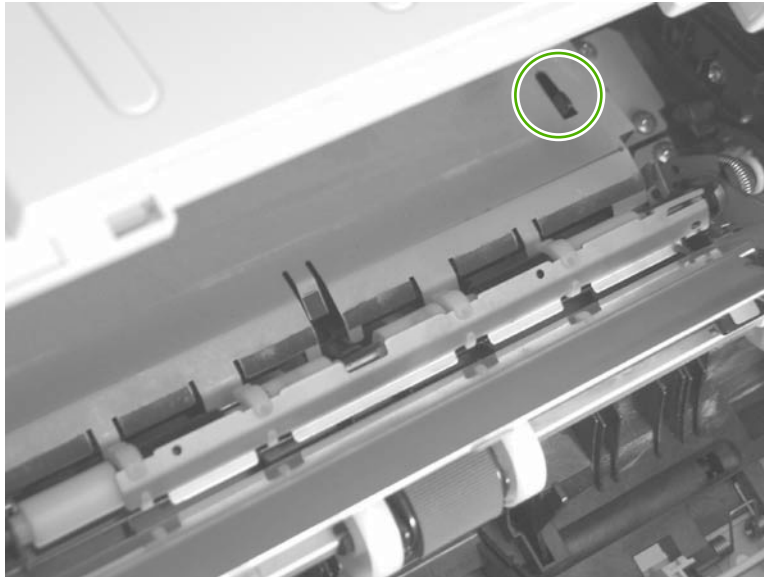


## D Paper width sensor 1

Test the media width sensor (PS225)

1. Open the cartridge door, and then remove the print cartridge.
2. Raise and then lower the registration flap to activate the sensor.

**Figure 3-6** Test the media width sensor



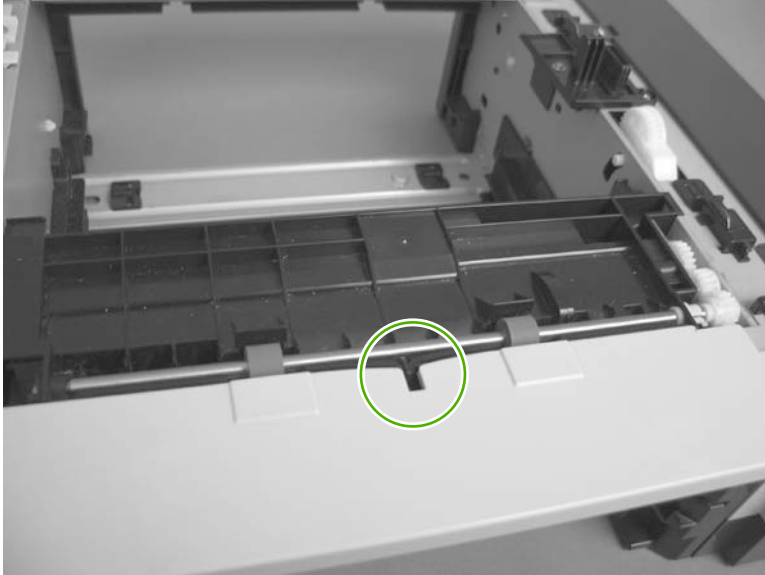
3. Check the control-panel display for a sensor response.
4. If there is no response, replace the media width sensor PCA.

## E Tray 3 feed sensor

Test the Tray 3 media-feed sensor (PS8008)

1. Remove the Tray 3 cassette.
2. Use a small screwdriver to activate the sensor.

**Figure 3-7** Test the Tray 3 media-feed sensor



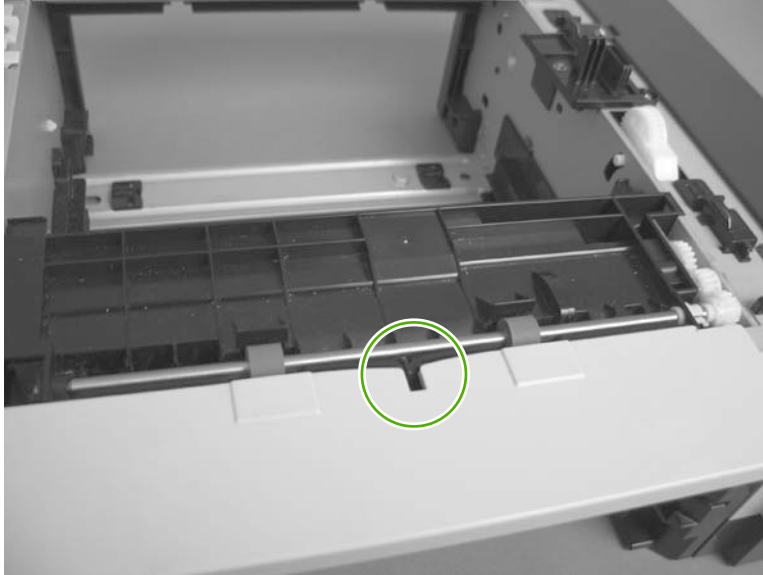
3. Check the control-panel display for sensor response.
4. If there is no response, replace the optional Tray 3 assembly.

## F Tray 4 feed sensor

Test the Tray 4 media-feed sensor (PS8008)

1. Remove the Tray 4 cassette.
2. Use a small screwdriver to activate the sensor.

**Figure 3-8** Test the Tray 4 media-feed sensor



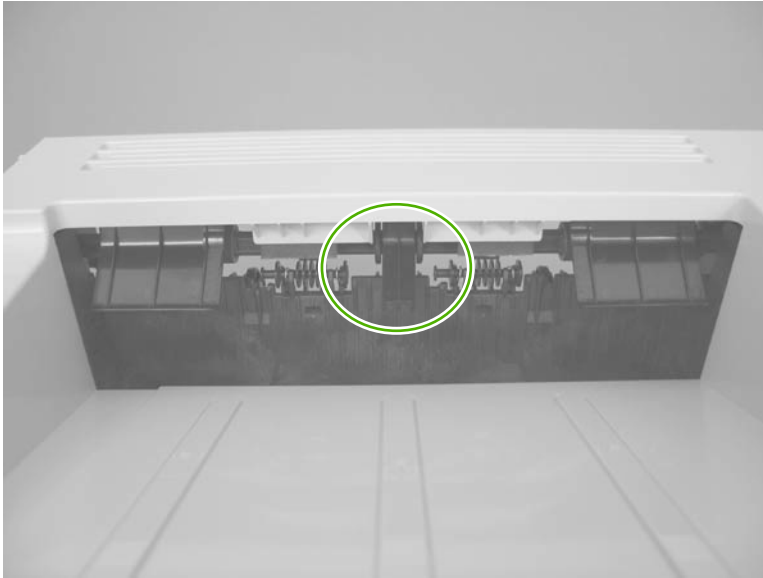
3. Check the control-panel display for sensor response.
4. If there is no response, replace the optional Tray 4 assembly.

### G FD tray full sensor

Test the face-down media tray media-full (PS1)

1. Raise and then lower the output-bin levers to activate the sensor.

**Figure 3-9** Test the face-down media tray media-full sensor



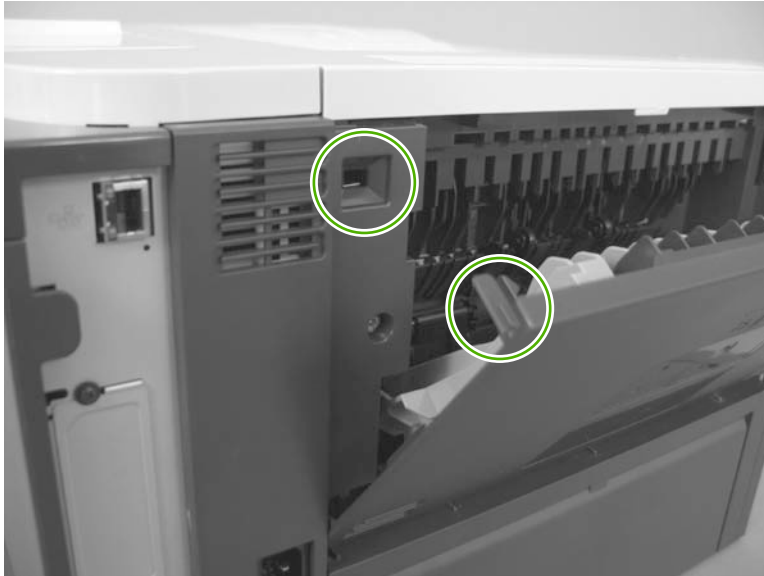
2. Check the control-panel display for sensor response.
3. If there is no response, replace the top-cover flag or the photo interrupter.

## H Face up detect sensor

Test the rear cover open sensor (PS1)

1. Open the rear door until it stops to activate the sensor.

**Figure 3-10** Test the rear cover open sensor



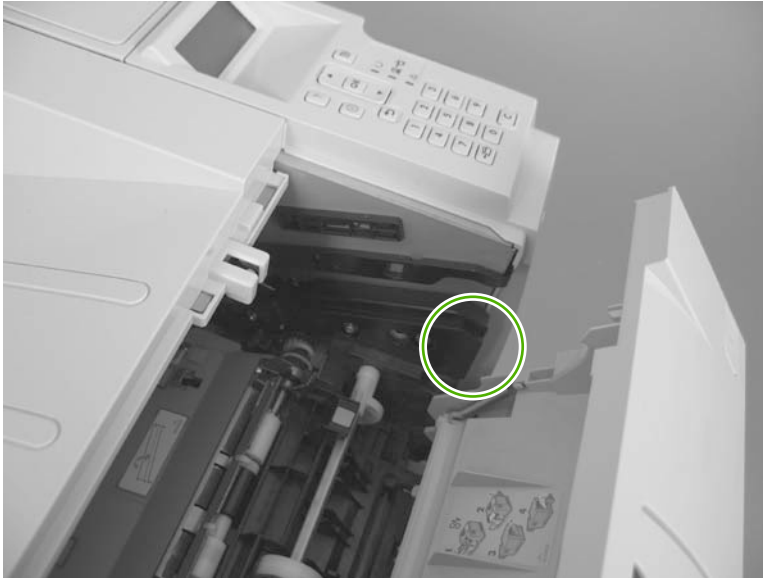
2. Check the control-panel display for sensor response.
3. If there is no response, replace the rear cover open sensor.

## I Cartridge-door open switch

Test the cartridge-door open switch (SW501)

1. Open the cartridge door to activate the sensor.

**Figure 3-11** Test the cartridge-door open switch




2. Check the control-panel display for sensor response.
3. If there is no response, make sure that the sensor-actuator tab on the door is not damaged or missing.

If necessary, replace the cartridge-door switch.

## J Rear cover open sensor

Test the face-up detect sensor (PS8001)

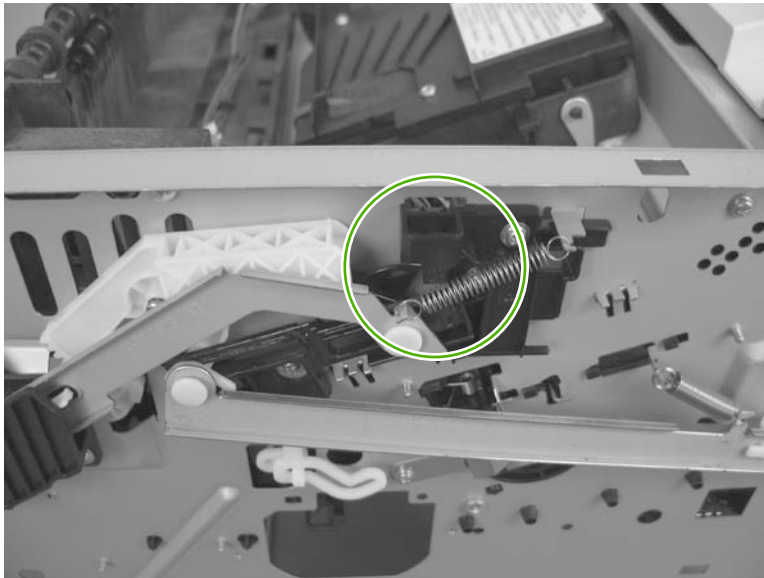
1. Open the rear door, and then gently pull down on the door and lower the door until it is fully open to activate the sensor.

 **NOTE:** [Figure 3-13 Test the face-up detect sensor \(2 of 2\) on page 149](#) shows the location of the face-up detect sensor (PS8001) behind the left cover.

**Figure 3-12** Test the face-up detect sensor (1 of 2)



**Figure 3-13** Test the face-up detect sensor (2 of 2)



2. Check the control-panel display for sensor response.
3. If there is no response, make sure that the sensor-actuator tab on the door is not damaged or missing.

If necessary, replace the face-up detect sensor.

## K Tray 1 paper sensor

Tray 1 (multipurpose tray) media-presence sensor (PS205)

1. Push the sensor lever toward the right side of the product and hold it there for 3 seconds to activate the sensor.

**Figure 3-14** Test the Tray 1 (multipurpose tray) media-presence sensor



2. Check the control-panel display for sensor response.
3. If there is no response, replace the multipurpose sensor PCA.

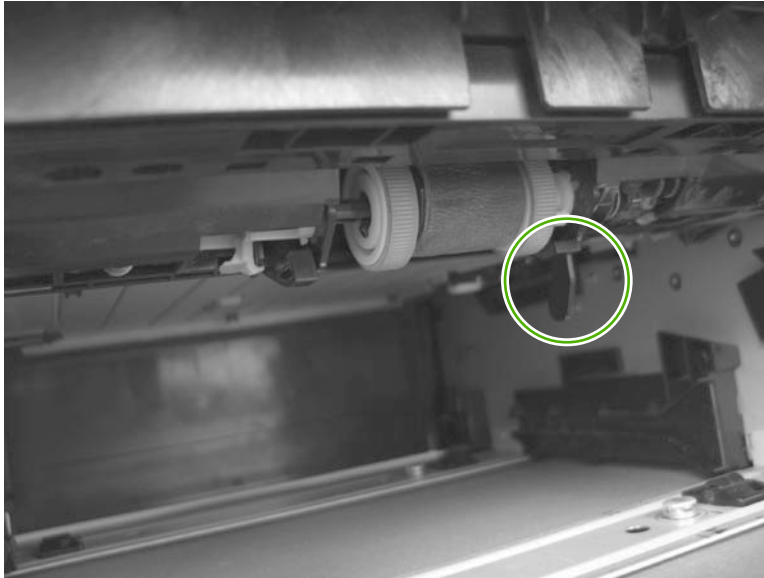


## L Tray 2 paper sensor

Tray 2 cassette media-presence sensor (PS3)

1. Remove the Tray 2 cassette, and then push on the sensor levers to activate the sensor.

**Figure 3-15** Test the Tray 2 cassette media-presence sensor



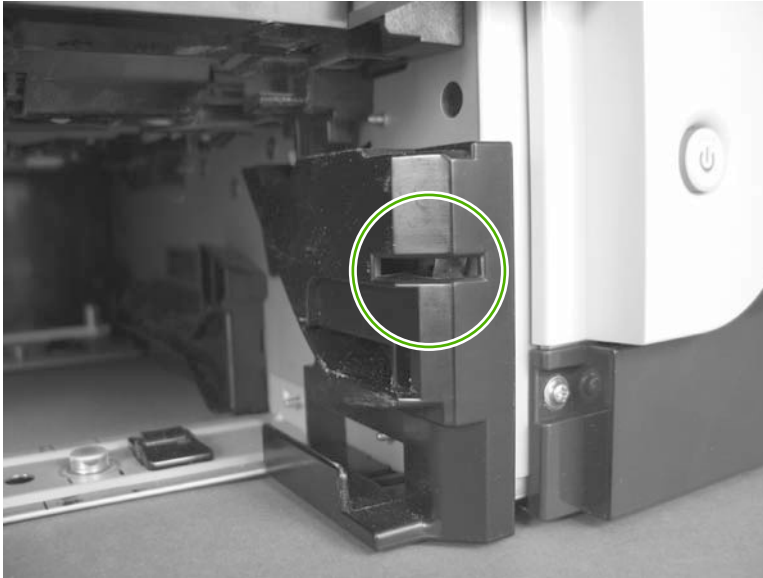
2. Check the control-panel display for sensor response.
3. If there is no response, replace the unit.

## M Tray 2 detect switch

Tray 2 cassette presence switch (SW235)

1. Remove the Tray 2 cassette, and then install it to activate the sensor.

**Figure 3-16** Test the Tray 2 cassette presence switch



2. Check the control-panel display for sensor response.
3. If there is no response, make sure that the sensor-actuator tab on the cassette is not damaged or missing.

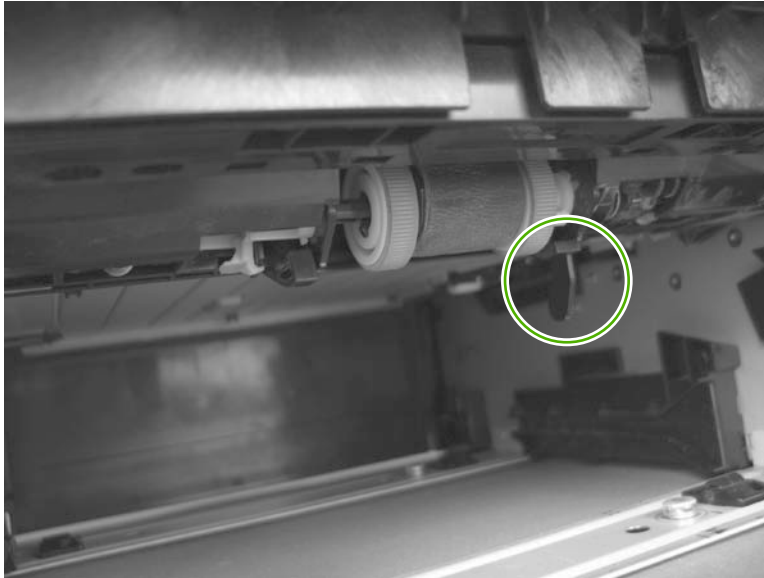
If necessary, replace the switch.

## N Tray 3 paper sensor

Tray 3 media-presence sensor (PS451)

1. Remove the Tray 3 cassette, and then push on the sensor levers to activate the sensor.

**Figure 3-17** Test the Tray 3 cassette media-presence sensor



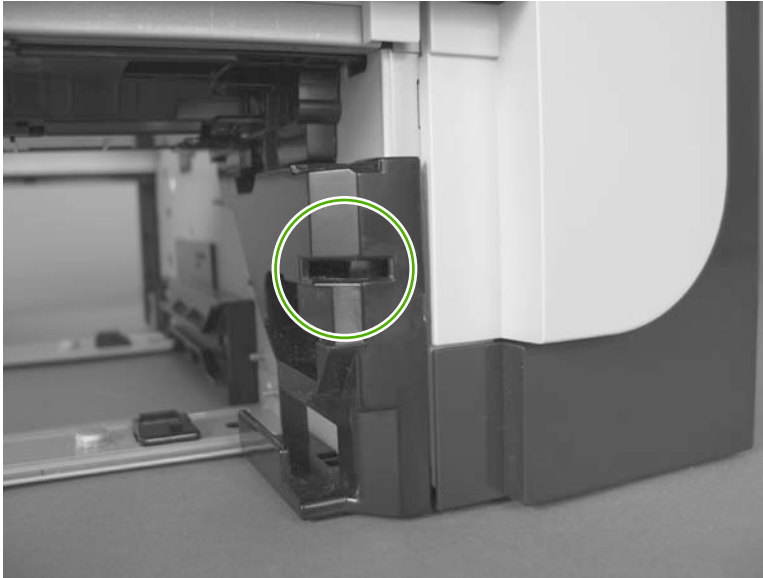
2. Check the control-panel display for sensor response.
3. If there is no response, replace the optional 500-sheet feeder.

## O Tray 3 detect switch

Tray 3 cassette presence switch (SW461)

1. Remove the Tray 3 cassette, and then install it to activate the sensor.

**Figure 3-18** Test the Tray 3 cassette presence switch



2. Check the control-panel display for sensor response.
3. If there is no response, make sure that the sensor-actuator tab on the cassette is not damaged or missing.

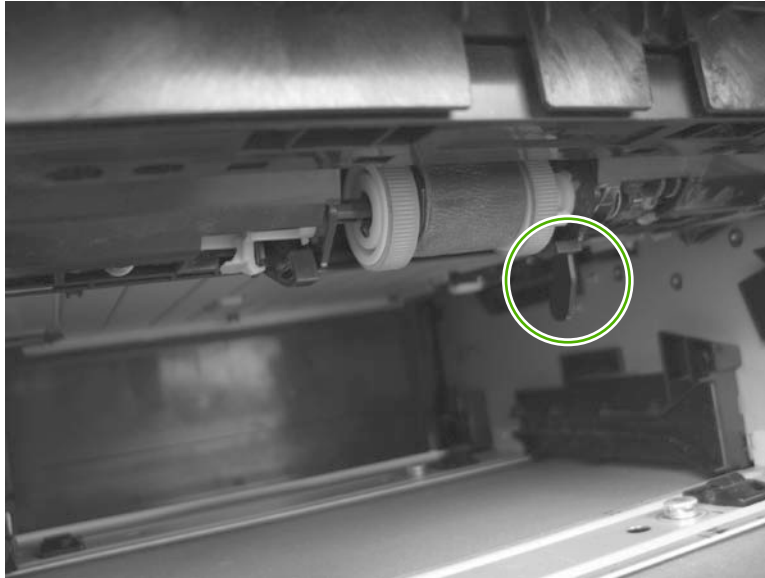
If necessary, replace the optional 500-sheet feeder.

## P Tray 4 paper sensor

Tray 4 media-presence sensor (PS451)

1. Remove the Tray 4 cassette, and then push on the sensor levers to activate the sensor.

**Figure 3-19** Test the Tray 4 cassette media-presence sensor



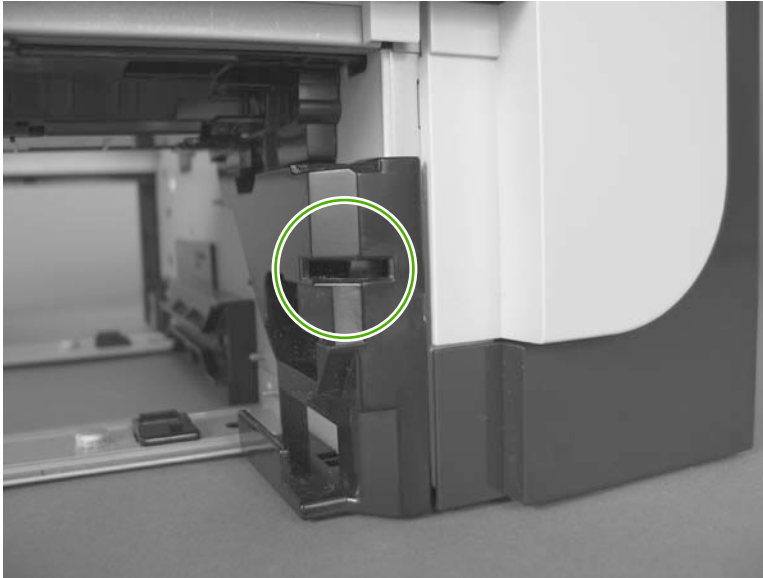
2. Check the control-panel display for sensor response.
3. If there is no response, replace the optional 500-sheet feeder.

## Q Tray 4 detect switch

Tray 4 cassette presence switch (SW461)

1. Remove the Tray 4 cassette, and then install it to activate the sensor.

**Figure 3-20** Test the Tray 4 cassette presence switch




2. Check the control-panel display for sensor response.
3. If there is no response, make sure that the sensor-actuator tab on the cassette is not damaged or missing.


If necessary, replace the optional 500-sheet feeder.

## Print/stop test

Use this diagnostic test to isolate the cause of problems such as image formation defects and jams within the engine. The test can be programmed to stop from 0 to 60,000 ms.

### Perform the print/stop test in the **DIAGNOSTICS** menu

1. Press the **Menu** button .
2. Press the down arrow ▼ button or the up arrow ▲ button to navigate to the **DIAGNOSTICS** menu.
3. Press the **OK** button to select the menu.
4. Press the down arrow ▼ button or the up arrow ▲ button to navigate to the **PRINT/STOP TEST** sub menu.
5. Press the **OK** button to select the sub menu.
6. Press the down arrow ▼ button or the up arrow ▲ button to set a stop time.

 **NOTE:** Range is 0 - 60,000 milliseconds. The default is 0.

**Table 3-5 Print/stop settings**


Duration	Description
0 msec	The leading edge of the paper stops about 10 mm (0.36 in) beyond the silver paper guide of the registration assembly.
100 msec	The leading edge of the paper stops about 24 mm (0.94 in) beyond the silver paper guide of the registration assembly.
500 msec	The leading edge of the paper stops prior to the paper entering the “nip” of the fuser assembly; the nip is the gap between the pressure roller and the hot fusing roller.
1000 msec	The leading edge of the paper stops about 55 mm (2.17 in) beyond the fuser assembly output rollers.
1200 msec	Simplex print operation: The leading edge of the paper stops 100 mm (3.94 in) past the face-down delivery stacker rollers.
1,500 msec	Simplex print operation: The leading edge of the paper stops 5 mm (0.20 in) beyond the output-bin-full sensor flags.
2,500 msec	Duplex print operation: The leading edge of the paper has passed through the fuser assembly and into the output stacker rollers. The paper has now reversed direction and stopped 90 mm (3.55 in) before the leading edge reaches the output-bin-full sensor flags.
3,000 msec	Duplex print operation: The leading edge of the paper has passed through the fuser assembly and into the output stacker rollers. The paper has now reversed direction and entered the duplex accessory. The leading edge of the paper stops about 15 mm (0.59 in) after encountering the duplex media-feed sensor (PS502).

7. Press the **OK** button to start the test.
8. Send a print job to the product. The product will stop printing at the selected time.

## Component tests

### Half self-test

Perform a half self-test to determine which image-formation process might be malfunctioning.

 **NOTE:** It might be easier to perform the print/stop test to stop the product during the printing process. See [Print/stop test on page 157](#).

1. Print a configuration page from the control panel.
2. Open the cartridge door after the paper advances half-way through the product, which is about 3 to 5 seconds after the main motor begins to rotate. The leading edge of the paper should have advanced past the print cartridge.
3. Remove the print cartridge.
4. Open the print cartridge drum shield to view the drum surface.

If a dark and distinct toner image is present on the drum surface, assume that the cleaning, conditioning, writing, and developing functions of the electrophotographic process are functioning correctly. Troubleshoot the failure as a transfer or fusing problem. If no image is present on the drum, perform the drum rotation test check. See [Drum rotation test check on page 158](#).

### Drum rotation test check

 **NOTE:** This test is especially important if refilled print cartridges are in use.


The photosensitive drum, which is located in the print cartridge, must rotate in order for the print process to work. The photosensitive drum receives its drive from the main gear assembly. Use this procedure to determine whether the drum is rotating.

1. Open the cartridge door.
2. Remove the print cartridge.
3. Mark the cartridge drive gear with a felt-tipped marker. Note the position of the mark.
4. Install the print cartridge, and then close the cartridge door. The start-up sequence should rotate the drum enough to move the mark on the gear.
5. Open the product and inspect the mark on the cartridge drive gear.

Verify that the mark moved. If there was no movement, inspect the main gear assembly to make sure that it connects with the print-cartridge gears. If the drive gears function but the drum does not move, replace the print cartridge.

### Diagnostics menu components test

Use this diagnostic test to isolate and test individual product components.

1. Press the **Menu** button .
2. Press the down arrow ▼ button or the up arrow ▲ button to navigate to the **DIAGNOSTICS** menu, and then press the **OK** button.
3. Press the down arrow ▼ button or the up arrow ▲ button to navigate to the **COMPONENT TEST** sub menu, and then press the **OK** button.



4. Press the down arrow ▼ button or the up arrow ▲ button to select a component to test.

**Table 3-6 Components test**

Component test	Item	Control-panel display message	Description
Main motor test	M8001	<b>DRUM MOTOR</b>	Activates the main motor for 10 seconds.
Scanner motor test	Not applicable	<b>LASER SCANNER MOTOR</b>	Activates the laser/scanner motor for 10 seconds.
Fuser motor test	M8002	<b>FUSER MOTOR</b>	Activates the fuser motor for 10 seconds.
Clutch drive test	CL1	<b>INT FEED ROLLER CLUTCH</b>	Activates the main motor to activate the paper feeder pickup clutch for 10 seconds.
Tray 1 (multipurpose tray) pickup solenoid test	SL1	<b>MP TRAY SOLENOID DRIVE</b>	Activates the Tray 1 pickup solenoid for 10 seconds.
Tray 2 pickup solenoid test	SL2	<b>TRAY 2 PICKUP SOLENOID</b>	Activates the Tray 3 cassette pickup solenoid for 10 seconds.
Tray 3 pickup solenoid test	SL3 <sup>1</sup>	<b>TRAY 3 PICKUP SOLENOID</b>	Activates the Tray 4 cassette pickup solenoid for 10 seconds.
Tray 4 pickup solenoid test	SL3 <sup>1</sup>	<b>TRAY 4 PICKUP SOLENOID</b>	Activates the Tray 2 cassette pickup solenoid for 10 seconds.

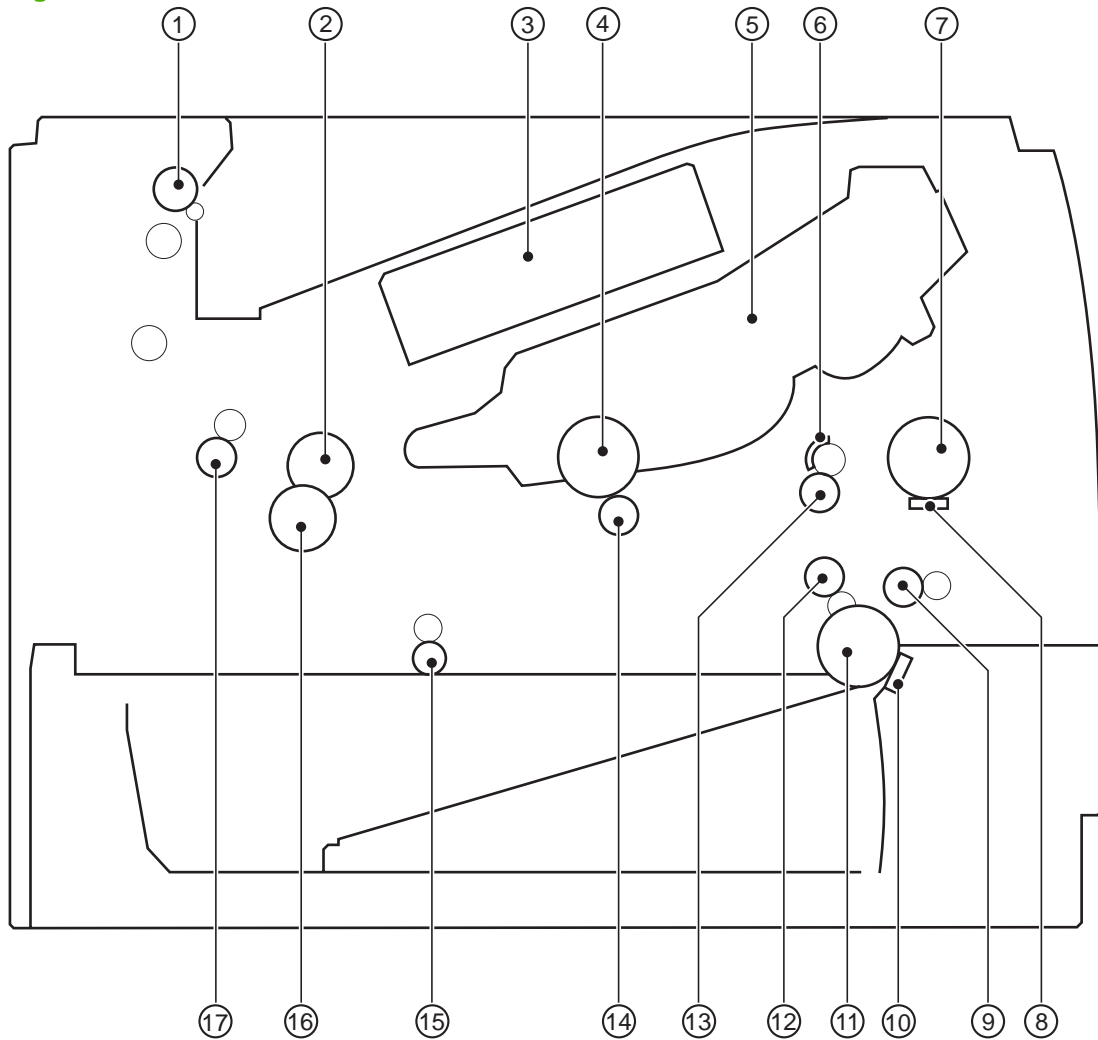
<sup>1</sup> Tray 3 and Tray 4 both use a SL3.

5. Press the **OK** button to start the test.

## Diagrams

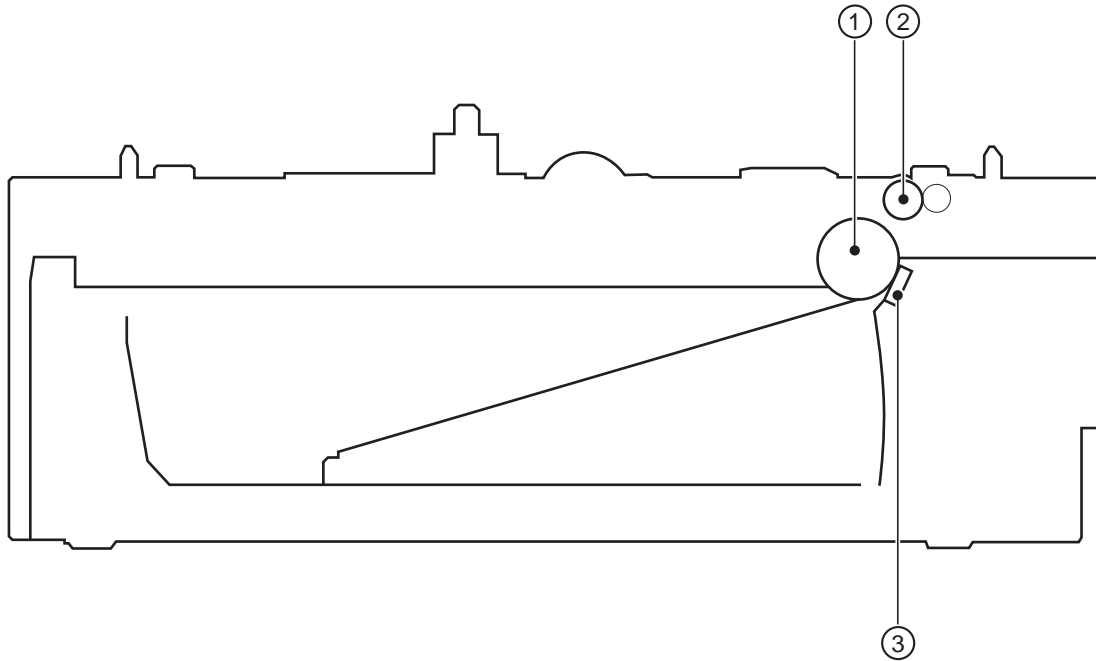
### Block diagrams

**Figure 3-21** Product cross section



Item	Description	Item	Description
1	Face-down delivery roller	10	Cassette (Tray 2) separation pad
2	Fuser film	11	Cassette (Tray 2) pickup roller
3	Laser/scanner	12	Duplex repickup roller (duplex models)
4	Photosensitive drum	13	Registration roller
5	Print cartridge	14	Transfer roller
6	Registration shutter	15	Duplex-feed roller (duplex models)
7	Tray 1 (multipurpose tray) pickup roller	16	Pressure roller
8	Tray 1 (multipurpose tray) separation pad	17	Fuser delivery roller
9	Feed roller		

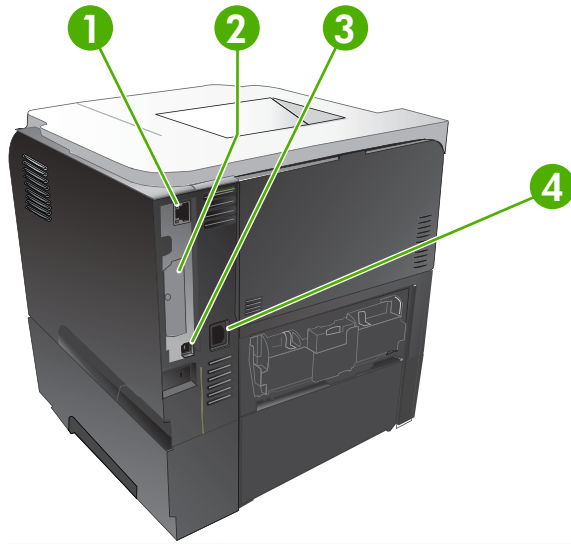
**Figure 3-22** Optional paper feeder (Tray 3 and Tray 4) cross section



Item	Description
1	Pickup roller
2	Feed roller
3	Separation pad

## Plug/jack locations

Figure 3-23 Plug/jack locations

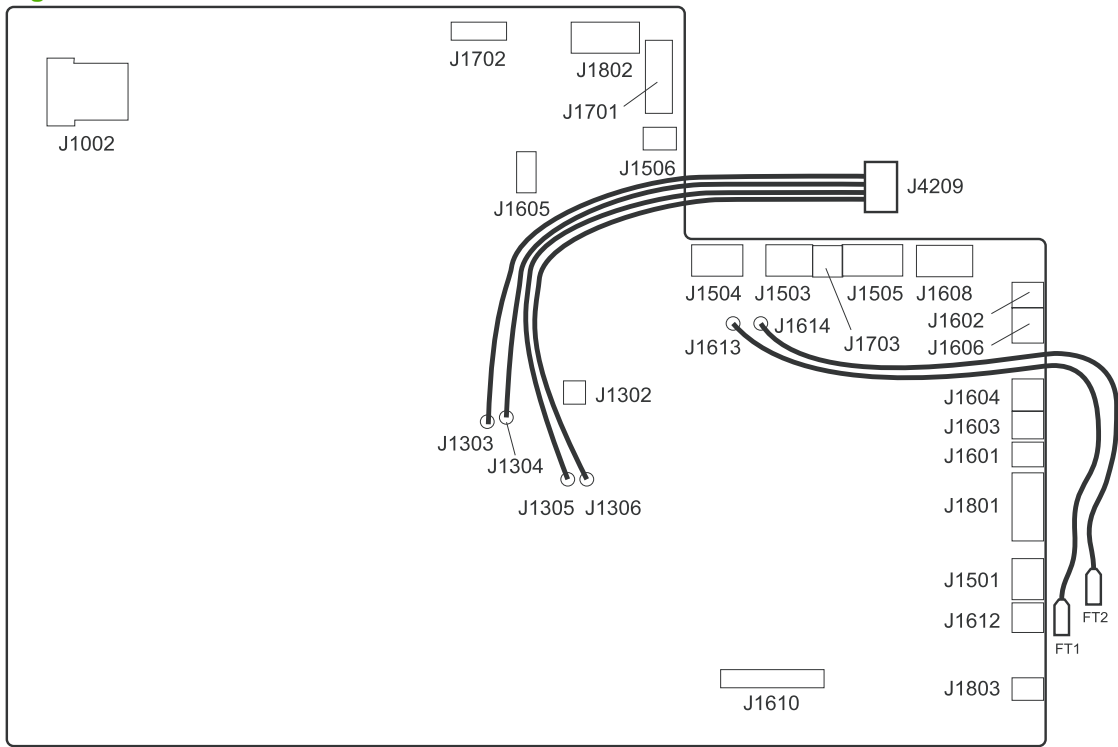


Item	Description
1	RJ.45 network connection (network models only)
2	EIO slot (covered)
3	Hi-Speed Host USB 2.0 connection
4	Power connection

## Location of connectors

### ECU controller connections

**Figure 3-24** ECU controller connections

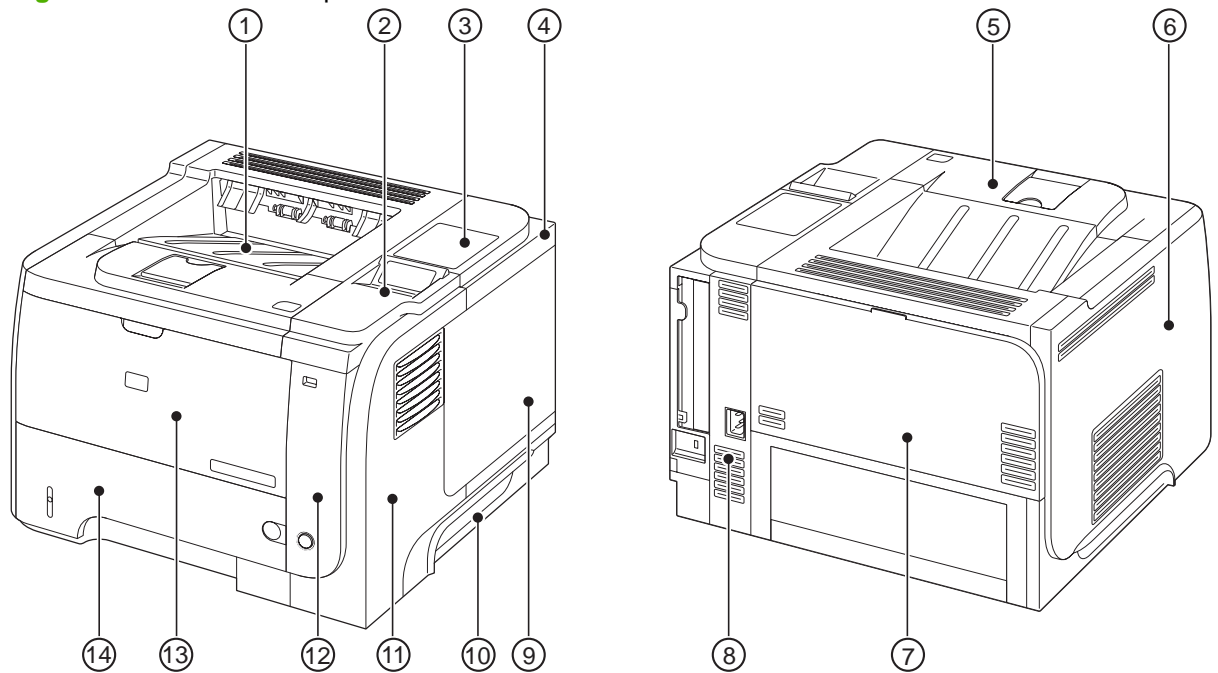


Item	Description	Item	Description	Item	Description
J1002	Fuser	J1601	SL2 Cassette (Tray 2) pickup solenoid	J1701	Formatter
J1302	SW240 Power switch	J1602	SL1 Tray 1 pickup solenoid	J1702	Laser drive PCA
J1303	+3.3 A Formatter	J1603	PS 3 Cassette media-presence sensor	J1703	Memory tag
J1304	+3.3 A Formatter	J1604	PS205 Tray 1 media-presence sensor	J1801	Paper feeder
J1305	GND Formatter	J1605	PS1 Face-up sensor and PS4 Face-down sensor	J1802	RLTEST; RLDRV2; SJIG_CLK; SJIG_RXD; SJIG_TXD; GND; NC; +24 v
J1306	GND Formatter	J1606	FM1 Main fan	J1803	TH3 Environmental sensor
J1501	+3.3 V; OTRX0; OTTX0; MD0; MD2; GND	J1608	PS2, TH1, TH2 Fuser	J4209	Formatter

Item	Description	Item	Description	Item	Description
J1503	Main motor	J1610	High-voltage power supply circuit; includes PS225 Media width sensor and PS215 TOP sensor	FT1	SW501 Cartridge-door switch (print-cartridge door)
J1504	Fuser motor	J1612	SW235 Cassette (Tray 2) presence switch	FT2	SW501 Cartridge-door switch (print-cartridge door)
J1505	FM2 Sub fan, PS8001 Rear door sensor, and M3 Scanner motor	J1613	+24 V to FT1		
1506	SW250 Test-print switch	J1614	+24 V to FT2		

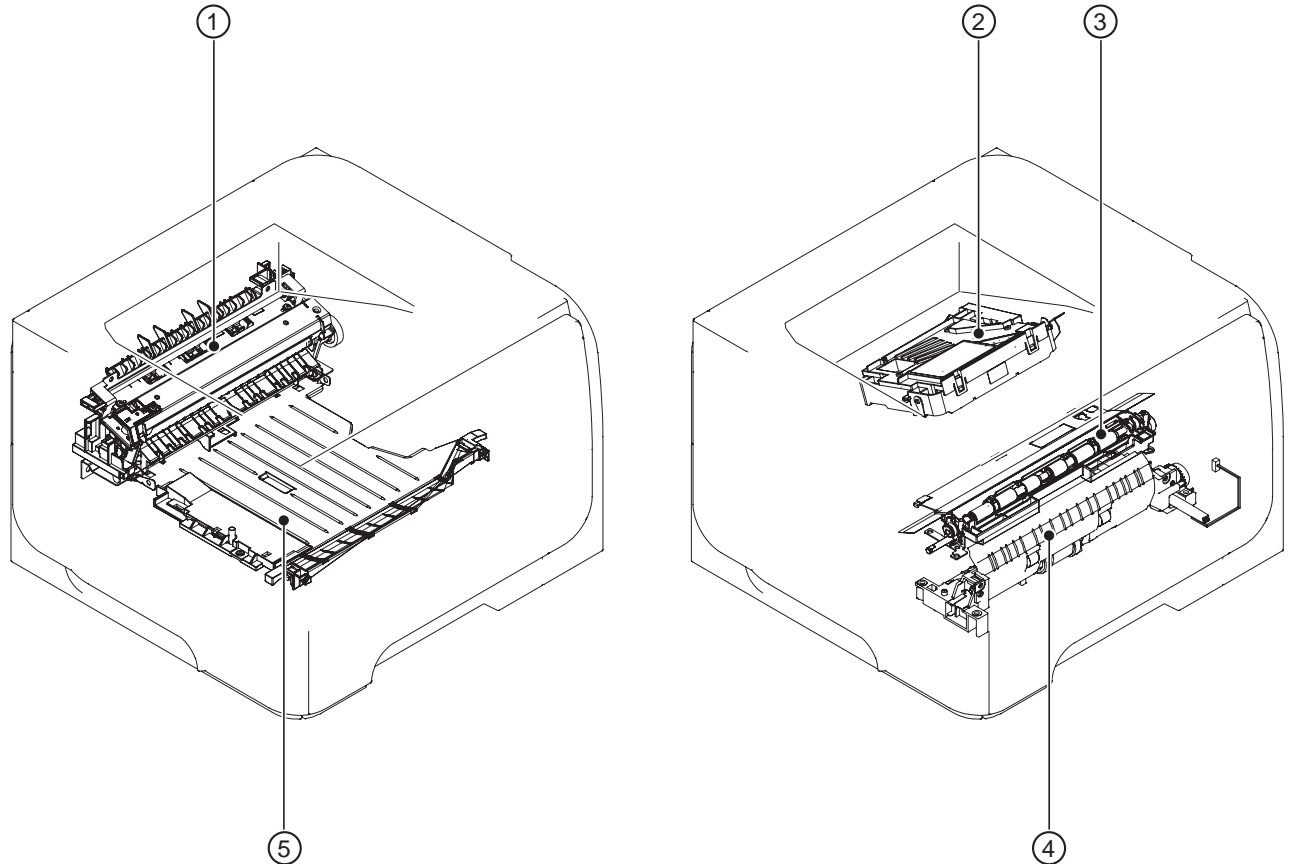
## Locations of major components

Figure 3-25 External component locations



Item	Description	Item	Description
1	Top cover	8	Right-rear cover
2	Control panel	9	DIMM cover
3	Top-right cover	10	Lower-right cover
4	Formatter cover	11	Right cover
5	Cartridge-door assembly	12	Front-right and right-side cover assembly
6	Left cover	13	Tray 1 (multipurpose tray)
7	Rear-door assembly	14	Cassette (Tray 2)

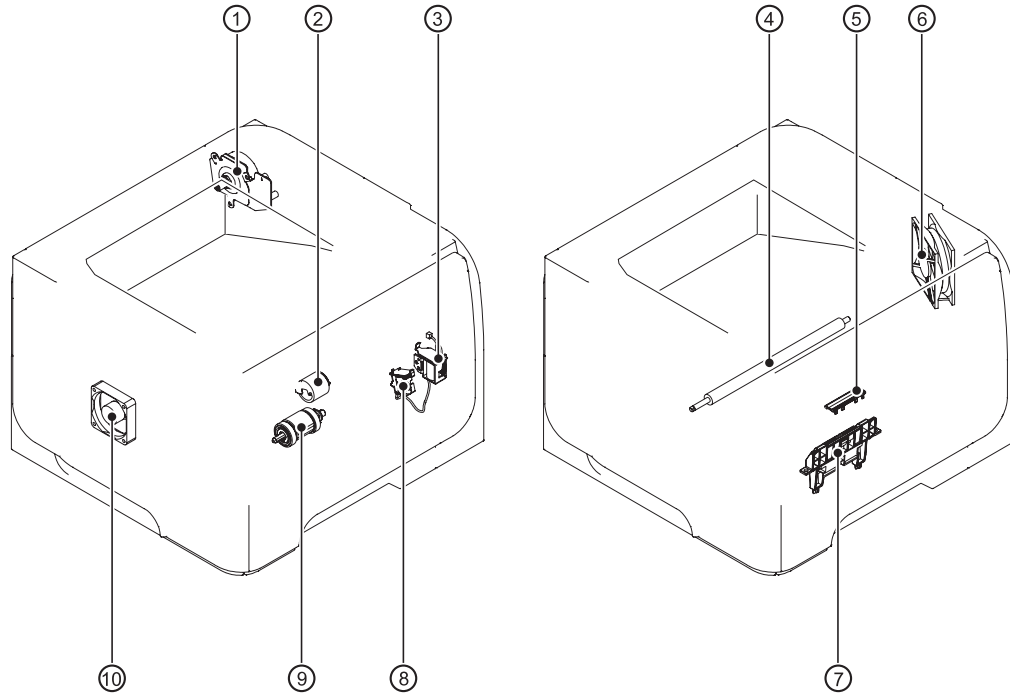
**Figure 3-26** Major component locations



Item	Description
1	Fuser
2	Laser/scanner
3	Registration assembly
4	Pickup assembly
5	Duplex media-feed assembly (duplex models only)

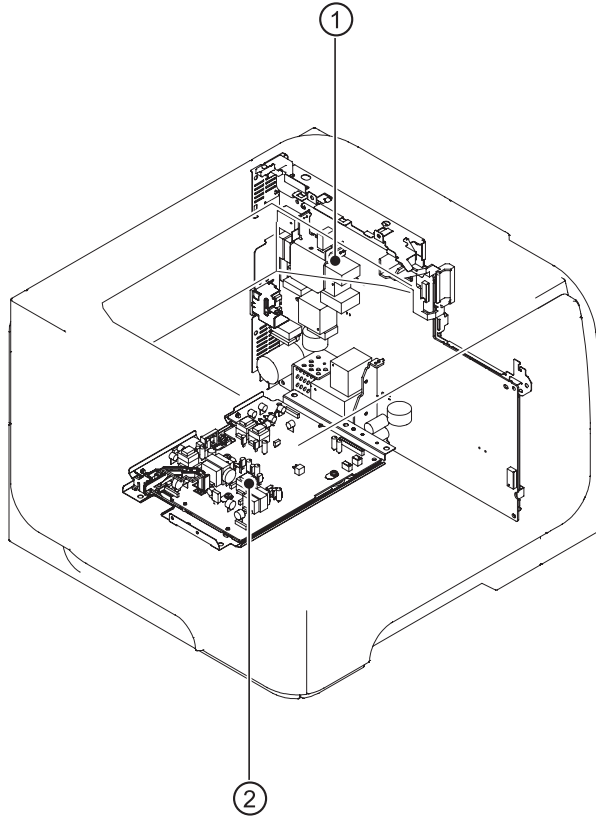


**Figure 3-27** Motors, fans, solenoids, and rollers component locations



Item	Description	Item	Description
1	Fuser motor	6	Main fan
2	Tray 1 (multipurpose tray) pickup roller	7	Cassette (Tray 2) separation pad
3	Tray 1 (multipurpose tray) pickup solenoid	8	Cassette (Tray 2) pickup solenoid
4	Transfer roller	9	Cassette (Tray 2) pickup roller
5	Tray 1 (multipurpose tray) separation pad	10	Sub fan

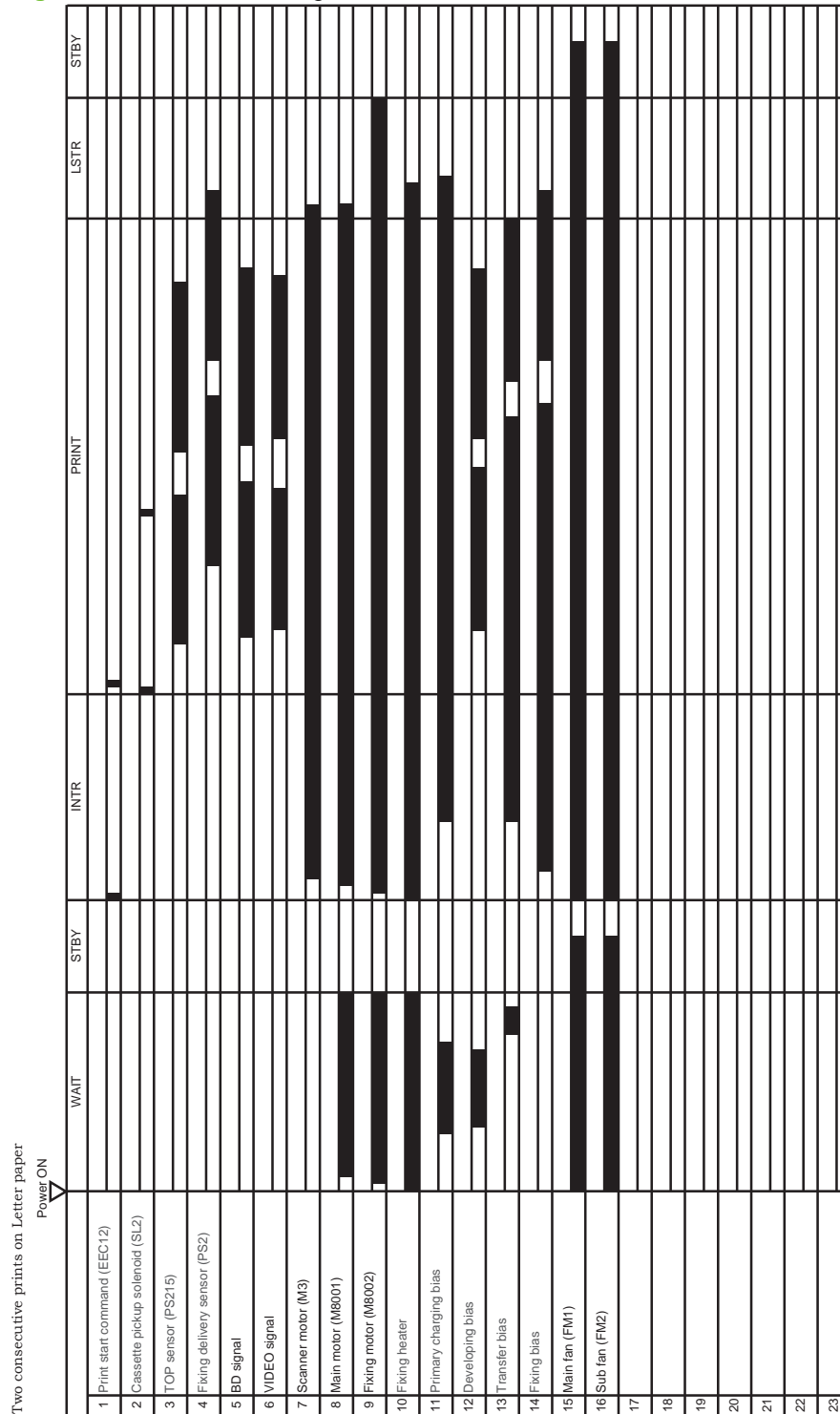
**Figure 3-28** PCA component locations



Item	Description
1	Engine controller unit (ECU)
2	High-voltage power supply

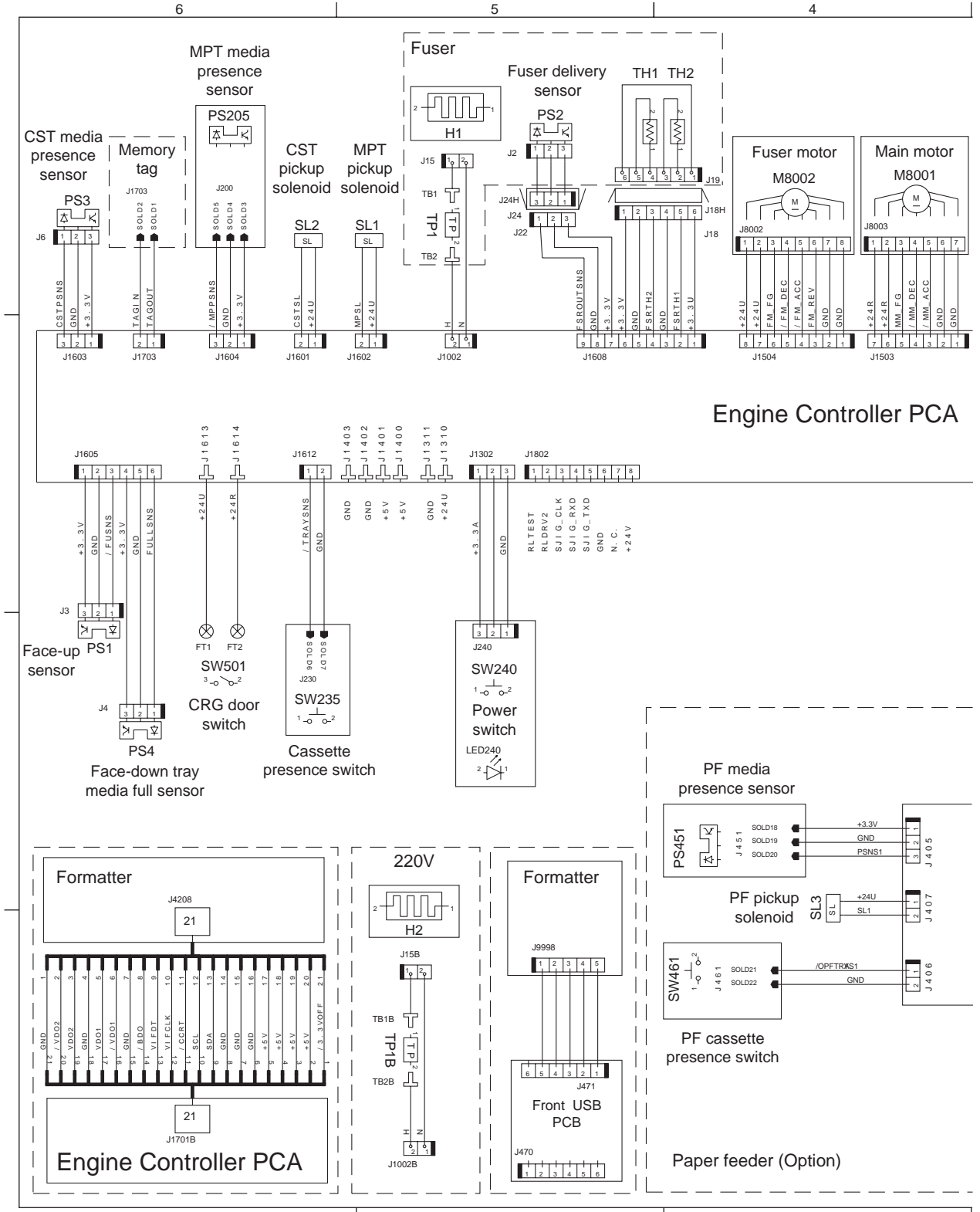
# General timing charts

Figure 3-29 General timing chart

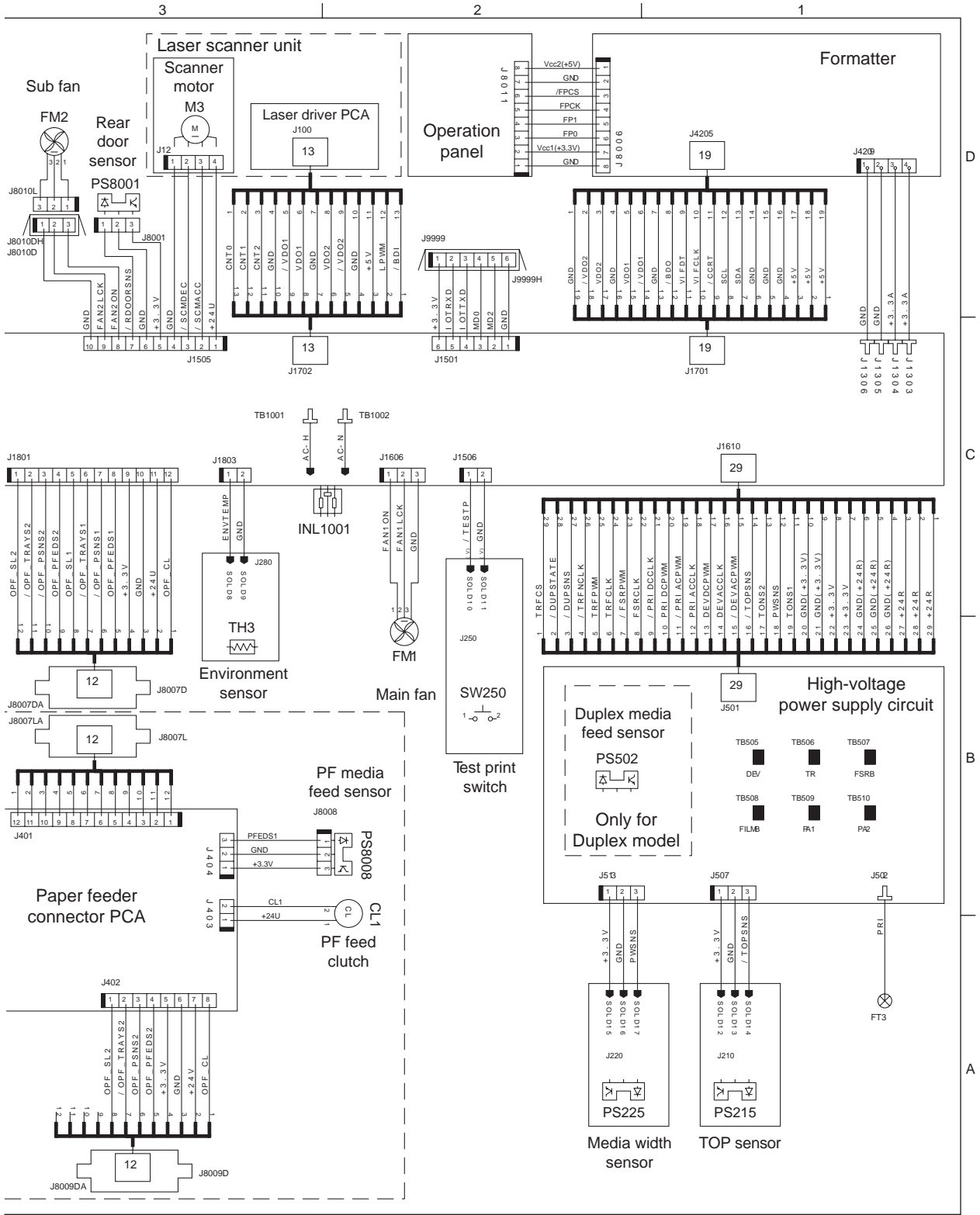


# General circuit diagram

Figure 3-30 General circuit diagram (1 of 2)




**Figure 3-31** General circuit diagram (2 of 2)



## Internal print quality test pages


### Cleaning page

#### Create and use the cleaning page

1. Press the **Menu** button .
2. Press the down arrow ▼ button or the up arrow ▲ button to navigate to the **CONFIGURE DEVICE** menu, and then press the **OK** button.
3. Press the down arrow ▼ button or the up arrow ▲ button to navigate to the **PRINT QUALITY** menu, and then press the **OK** button.
4. If the product does not have automatic two-sided printing, press the down arrow ▼ button or the up arrow ▲ button to navigate to the **CREATE CLEANING PAGE** option, and then press the **OK** button. If the product has automatic two-sided printing, go to step 5.
5. Press the up arrow or down arrow ▲/▼ buttons to highlight the **PROCESS CLEANING PAGE** option, and then press the **OK** button. The cleaning process takes several minutes.
6. Discard the printed page. The task is complete.

### Configuration page


#### Print the configuration page

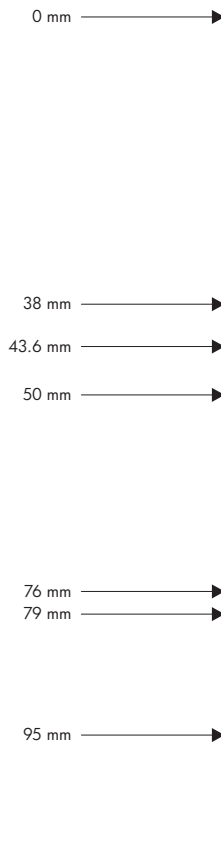
1. Press the **Menu** button .
2. Press the down arrow ▼ button or the up arrow ▲ button to navigate to the **INFORMATION** menu, and then press the **OK** button.
3. Press the down arrow ▼ button or the up arrow ▲ button to highlight the **PRINT CONFIGURATION** option, and then press the **OK** button to print the page.

## Print quality troubleshooting tools

### Repetitive image-defect ruler

Use a ruler to measure occurrences of repetitive image defects to help solve image quality problems. Place the ruler next to the first occurrence of the defect on the page. Find the distance between identical defects and use the figure below to identify the component that is causing the defect.

 **NOTE:** When printing this defect ruler, verify that any scaling options in the printer driver are disabled.





Distance between defects	Product components that cause the defect
38 mm	Print cartridge (primary charging roller)
43.6 mm	Print engine (transfer roller)
50 mm	Print cartridge (developer roller)
76 mm	Fuser (fuser film)
79 mm	Fuser (pressure roller)
95 mm	Print cartridge (OPC)

## Control-panel menus

You can perform most routine printing tasks from the computer through the printer driver or software program. This is the most convenient way to control the product, and it overrides the product control-panel settings. See the help files for the software program, or for more information about opening the printer driver, see the product user guide.

You can also control the product by changing settings in the product's control panel. Use the control panel to access features not supported by the printer driver or software program, and to configure trays for paper size and type.

### Use the menus

1. Press the **Menu** button .
2. Press the down arrow ▼ button or the up arrow ▲ button to navigate the listings.
3. Press the **OK** button to select the option.
4. Press the back arrow ↶ button to return to the previous level.
5. Press the **Menu** button  to exit the menu.
6. Press the help button ? to see more information about an item.

The following are the main menus.

---

Main menus	<b>SHOW ME HOW</b>
	<b>RETRIEVE JOB</b>
	<b>INFORMATION</b>
	<b>PAPER HANDLING</b>
	<b>MANAGE SUPPLIES</b>
	<b>CONFIGURE DEVICE</b>
	<b>DIAGNOSTICS</b>
	<b>SERVICE</b>

---

### Show Me How menu

Use the **SHOW ME HOW** menu to print instructions for using the product.

**To display:** Press the **Menu** button , and then select the **SHOW ME HOW** menu.

---

Item	Explanation
<b>CLEAR JAMS</b>	Provides instructions for clearing jams on the product.
<b>LOAD TRAYS</b>	Provides instructions for loading and configuring trays.
<b>LOAD SPECIAL MEDIA</b>	Provides instructions for loading special print media such as envelopes, transparencies, and labels.
<b>PRINT BOTH SIDES</b>	Provides instructions for printing on both sides of the paper (duplex printing).


---



Item	Explanation
<b>SUPPORTED PAPER</b>	Provides a list of the supported paper and print media.
<b>PRINT HELP GUIDE</b>	Prints a page that shows links to additional help on the Web.
<b>PRODUCT VIEWS</b>	Prints a page that explains the product components.

## Retrieve job menu

Use the **RETRIEVE JOB** menu to view listings of all stored jobs.


**To display:** Press the **Menu** button , and then select the **RETRIEVE JOB** menu.

Item	Sub-item	Options	Description
<USER NAME>			Each user who has stored jobs is listed by name. Select the appropriate user name to see a list of stored jobs.
	<b>ALL JOBS (WITH PIN)</b>	<b>PRINT</b> <b>PRINT AND DELETE</b> <b>DELETE</b>	This message appears if a user has two or more stored jobs that require a PIN.  Either the <b>PRINT</b> option or the <b>PRINT AND DELETE</b> option displays, depending on the type of jobs listed.  Use the <b>COPIES</b> option to specify the number of copies of the job to print.
	<b>ALL JOBS (NO PIN)</b>	<b>PRINT</b> <b>PRINT AND DELETE</b> <b>DELETE</b>	This message appears if a user has two or more stored jobs that do not require a PIN.  Either the <b>PRINT</b> option or the <b>PRINT AND DELETE</b> option displays, depending on the type of jobs listed.  Use the <b>COPIES</b> option to specify the number of copies of the job to print.
	<JOB NAME X>	<b>PRINT</b> <b>PRINT AND DELETE</b> <b>DELETE</b>	Each job is listed by name.  Either the <b>PRINT</b> option or the <b>PRINT AND DELETE</b> option displays, depending on the type of jobs listed.  Use the <b>COPIES</b> option to specify the number of copies of the job to print.

Item	Sub-item	Options	Description
		<b>COPIES</b>	<p>Specifies the number of copies of the job to print. The default is 1.</p> <p>For the <b>ALL JOBS (NO PIN)</b> and <b>ALL JOBS (WITH PIN)</b> menus, two more options are available:</p> <ul style="list-style-type: none"> <li>If you select the <b>JOB</b> option, the number of copies specified in the driver are printed.</li> <li>If you select the <b>CUSTOM VALUE</b> menu, another setting displays where you can specify the number of copies of the job to be printed. The number of copies that were specified in the driver are multiplied by the number of copies specified on the control panel. For example, if you specified two copies in the driver and specify two copies on the control panel, a total of four copies of the job are printed.</li> </ul>
<b>USB STORAGE</b>	<FOLDER NAME> <JOB NAME>	<b>COPIES</b>	This menu displays if you have connected a USB storage accessory to the front of the product. Select the folder and the name of the file, and then select the number of copies to print.

## Information menu

Use the **INFORMATION** menu to access and print specific product information.


**To display:** Press the **Menu** button , and then select the **INFORMATION** menu.


Item	Description
<b>PRINT MENU MAP</b>	Prints the control-panel menu map, which shows the layout and current settings of the control-panel menu items.
<b>PRINT CONFIGURATION</b>	Prints the product configuration pages, which show the printer settings and installed accessories.
<b>PRINT SUPPLIES STATUS PAGE</b>	<p>Prints the approximate remaining life for the supplies; reports statistics on total number of pages and jobs processed, serial number, page counts, and maintenance information.</p> <p>HP provides approximations of the remaining life for the supplies as a customer convenience. The actual remaining supply levels might be different than the approximations provided.</p>
<b>PRINT USAGE PAGE</b>	Prints a count of all paper sizes that have passed through the product, lists whether they were one-sided or two-sided, and reports the page count.
<b>PRINT DEMO PAGE</b>	Prints a demonstration page.
<b>PRINT FILE DIRECTORY</b>	Prints the name and directory of files stored in the product.

Item	Description
PRINT PCL FONT LIST	Prints the available PCL fonts.
PRINT PS FONT LIST	Prints the available PS fonts.

## Paper handling menu

Use this menu to configure input trays by size and type. It is important to correctly configure the trays with this menu before you print for the first time.


**To display:** Press the **Menu** button , and then select the **PAPER HANDLING** menu.


 **NOTE:** If you have used other HP LaserJet products, you might be accustomed to configuring Tray 1 to **First** mode or **Cassette** mode. On HP LaserJet P3010 Series printers, setting Tray 1 to **ANY SIZE** and **ANY TYPE** is equivalent to **First** mode. Setting Tray 1 to a setting other than **ANY SIZE** or **ANY TYPE** is equivalent to **Cassette** mode.

Menu item	Value	Description
TRAY 1 SIZE	Select a paper size from the list.	Configure the paper size for Tray 1. The default is <b>ANY SIZE</b> . See the product user guide for a complete list of available sizes.
TRAY 1 TYPE	Select a paper type from the list.	Configure the paper type for Tray 1. The default is <b>ANY TYPE</b> . See the product user guide for a complete list of available types.
TRAY <X> SIZE X = 2 or optional 3 or 4	Select a paper size from the list.	Configure the paper size for the indicated tray. The default size is <b>LETTER</b> or <b>A4</b> , depending on your country/region. See the product user guide for a complete list of available sizes.
TRAY <X> TYPE X = 2 or optional 3 or 4	Select a paper type from the list.	Configure the paper type for the indicated tray. The default is <b>PLAIN</b> . See the product user guide for a complete list of available types.

## Manage supplies menu

Use this menu to configure how the product alerts you when supplies are approaching the estimated end of life.

**To display:** Press the **Menu** button , and then select the **MANAGE SUPPLIES** menu.

 **NOTE:** Values that have an asterisk (\*) are the factory-default values. Some menu items have no default.

Menu item	Sub-menu item	Values	Description
AT VERY LOW	BLACK CARTRIDGE	STOP	Select what the product should do when the print cartridge is very near the end of its estimated life.  <b>STOP:</b> The product stops until you replace the cartridge.  <b>PROMPT TO CONTINUE:</b> The product stops until you clear the prompt message.  <b>CONTINUE:</b> The product provides an alert message, but it continues printing.
		PROMPT TO CONTINUE	
		CONTINUE*	
USER DEFINED LOW	BLACK CARTRIDGE		Use the arrow buttons or the numeric keypad to enter the percentage of estimated cartridge life at which you want the product to alert you.


## Configure device menu


Use the **CONFIGURE DEVICE** menu for the following tasks:

- Change the default printing settings.
- Adjust the print quality.
- Change the system configuration and I/O options.
- Reset the default settings.

## Printing menu

These settings affect only jobs without identified properties. Most jobs identify all of the properties and override the values set from this menu.

**To display:** Press the **Menu** button , select the **CONFIGURE DEVICE** menu, and then select the **PRINTING** menu.

 **NOTE:** Values that have an asterisk (\*) are the factory-default values. Some menu items have no default.


Menu item	Values	Description
COPIES	Range: 1 - 32000	Set the default number of copies for print jobs. The default number is 1.
DEFAULT PAPER SIZE	A list of available sizes appears.	Set the default paper size.
DEFAULT CUSTOM PAPER SIZE	<ul style="list-style-type: none"> <li>• UNIT OF MEASURE</li> <li>• X DIMENSION</li> <li>• Y DIMENSION</li> </ul>	Set the default size for any custom print job.

Menu item	Values	Description
DUPLEX	OFF*	Enable or disable two-sided printing.
	ON	<b>NOTE:</b> This menu is available only on the d, dn, and x models.
DUPLEX BINDING	LONG EDGE*	Change the binding edge for two-sided printing.
	SHORT EDGE	<b>NOTE:</b> This menu is available only on the d, dn, and x models.
OVERRIDE A4/LETTER	NO	Set the product to print an A4 job on letter-size paper when no A4 paper is loaded.
	YES*	
MANUAL FEED	OFF*	Makes the <b>MANUAL FEED</b> setting the default for jobs that do not select a tray.
	ON	
EDGE TO EDGE OVERRIDE	NO*	Change the printable area of Letter and A4-size paper to 2 mm from the left and right edges for single-sided printing. The standard printable area is 4 mm from the left and right edges.
	YES	
COURIER FONT	REGULAR*	Select a version of the Courier font.
	DARK	The <b>DARK</b> setting is an internal Courier font available on HP LaserJet Series III printers and older.
WIDE A4	NO *	Change the printable area of A4 paper.
	YES	<b>NO:</b> The printable area is seventy-eight 10-pitch characters on a single line. <b>YES:</b> The printable area is eighty 10-pitch characters on a single line.
PRINT PS ERRORS	OFF*	Print PS error pages.
	ON	
PRINT PDF ERRORS	OFF*	Print PDF error pages.
	ON	

## PCL sub-menu

This menu configures settings for the printer control language.


**To display:** Press the **Menu** button , select the **CONFIGURE DEVICE** menu, select the **PRINTING** menu, and then select the **PCL** menu.


 **NOTE:** Values that have an asterisk (\*) are the factory-default values. Some menu items have no default.

Item	Values	Description
FORM LENGTH		Sets vertical spacing from 5 to 128 lines for default paper size. The default is 60.

Item	Values	Description
<b>ORIENTATION</b>	<b>PORTRAIT*</b>	Set the default page orientation.
	<b>LANDSCAPE</b>	
<b>FONT SOURCE</b>	A list of available font sources displays.	Selects the font source. The default is <b>INTERNAL</b> .
<b>FONT NUMBER</b>		The product assigns a number to each font and lists the numbers on the PCL font list. The range is 0 to 102. The default is 0.
<b>FONT PITCH</b>		Selects the font pitch. This item might not appear, depending on the font selected. The range is 0.44 to 99.99. The default is 10.00.
<b>SYMBOL SET</b>	A list of available symbol sets displays.	Selects any one of several available symbol sets at the product control panel. A symbol set is a unique grouping of all the characters in a font. <b>PC-8</b> or <b>PC-850</b> is recommended for line-draw characters. The default is <b>PC-8</b> .
<b>APPEND CR TO LF</b>	<b>NO*</b>	Append a carriage return to each line-feed that is encountered in backward-compatible PCL jobs (pure text, no job control). Some environments indicate a new line by only the line-feed control code.
	<b>YES</b>	
<b>SUPPRESS BLANK PAGES</b>	<b>NO*</b>	When generating your own PCL, extra form feeds are included that would cause a blank page to be printed. Select <b>YES</b> for form feeds to be ignored if the page is blank.
	<b>YES</b>	
<b>MEDIA SOURCE MAPPING</b>		The PCL5 <b>MEDIA SOURCE MAPPING</b> command selects an input tray by a number that maps to the various available trays and feeders.
	<b>STANDARD*</b>	The numbering is based on newer HP LaserJet printers with updated changes to the numbering of trays and feeders.
	<b>CLASSIC</b>	The numbering is based on HP LaserJet 4 printers and earlier models.

## Print Quality menu

**To display:** Press the **Menu** button , select the **CONFIGURE DEVICE** menu, and then select the **PRINT QUALITY** menu.

 **NOTE:** Values that have an asterisk (\*) are the factory-default values. Some menu items have no default.

Item	Sub-item	Sub-item	Values	Description
<b>SET REGISTRATION</b>				For each tray, setting the registration shifts the margin alignment to center the image on the page from top to bottom and from left to right. You can also align the image on the front with the image printed on the back.


Item	Sub-item	Sub-item	Values	Description
	<b>ADJUST TRAY &lt;X&gt;</b>	<b>PRINT TEST PAGE</b>	Shift from -20 to 20 along the X or Y axes. 0 is the default.	Print a test page and perform the alignment procedure for each tray.
		<b>X1 SHIFT</b>		When it creates an image, the product scans across the page from side to side as the sheet feeds from top to bottom into the product.
		<b>Y1 SHIFT</b>		
		<b>X2 SHIFT</b>		
		<b>Y2 SHIFT</b>		The scan direction is referred to as X. X1 is the scan direction for a single-sided page or for the first side of a two-sided page. X2 is the scan direction for the second side of a two-sided page.
				The feed direction is referred to as Y. Y1 is the feed direction for a single-sided page or for the first side of a two-sided page. Y2 is the feed direction for the second side of a two-sided page.
<b>FUSER MODES</b>	A list of paper types displays.		<b>NORMAL</b> <b>HIGH2</b> <b>HIGH1</b> <b>LOW</b> <b>LOW1</b>	Each paper type has a default fuser mode. Change the fuser mode only if you are experiencing problems printing on certain paper types. After you select a type of paper, you can select a fuser mode that is available for that type.
	<b>RESTORE MODES</b>			Return all fuser-mode settings to the factory-default settings.
<b>OPTIMIZE</b>				Optimize various print modes to solve print-quality issues.
	<b>RESTORE OPTIMIZE</b>			Return all the settings in the <b>OPTIMIZE</b> menu to the factory-default values.
<b>RESOLUTION</b>			<b>300</b> <b>600</b> <b>FASTRES 1200*</b> <b>PRORES 1200</b>	Sets the resolution at which the product prints. <b>300:</b> Produces draft print quality. <b>600:</b> Produces high print quality for text. <b>FASTRES 1200:</b> Produces 1200-dpi print quality for fast, high-quality printing of business text and graphics. <b>PRORES 1200:</b> Produces 1200-dpi print quality for fast, high-quality printing of line art and graphic images.
<b>RET</b>			<b>OFF</b> <b>LIGHT</b> <b>MEDIUM*</b> <b>DARK</b>	Use the Resolution Enhancement technology (REt) setting to produce print with smooth angles, curves, and edges.  REt does not affect print quality if the resolution is set to the <b>FASTRES 1200</b> or <b>PRORES 1200</b> settings. All other print resolutions benefit from REt.


Item	Sub-item	Sub-item	Values	Description
<b>ECONOMODE</b>			<b>OFF*</b> <b>ON</b>	EconoMode is a feature that allows the product to use less toner per page. Selecting this option extends the life of the toner supply and might reduce the cost per page. However, it also reduces print quality. The printed page is adequate for printing drafts.  HP does not recommend full-time use of EconoMode. If EconoMode is used full-time, the toner supply might outlast the mechanical parts in the print cartridge. If print quality begins to degrade under these circumstances, you will need to install a new print cartridge, even if there is toner supply remaining in the cartridge.
<b>TONER DENSITY</b>			1 to 5	Lighten or darken the print on the page. The lightest setting is 1, and the darkest setting is 5. The default setting of 3 usually produces the best results.
<b>AUTO CLEANING</b>			<b>OFF*</b> <b>ON</b>	When auto-cleaning is on, the product prints a cleaning page when the page count reaches the <b>CLEANING INTERVAL</b> setting.
<b>CLEANING INTERVAL</b>			<b>500*</b> <b>1000</b> <b>2000</b> <b>5000</b> <b>10000</b> <b>20000</b>	When <b>AUTO CLEANING</b> is on, this option specifies the number of pages that are printed before a cleaning page is automatically printed.
<b>AUTO CLEANING SIZE</b>			<b>LETTER*</b> <b>A4</b>	When <b>AUTO CLEANING</b> is on, this option specifies the paper size that is used to print the cleaning page.
<b>CREATE CLEANING PAGE</b>				Prints a page of instructions for cleaning excess toner off the pressure roller in the fuser.  <b>NOTE:</b> Only available for non-duplex products.
<b>PROCESS CLEANING PAGE</b>				Create and process a cleaning page for cleaning the pressure roller in the fuser. When the cleaning process runs, a cleaning page is printed. This page can be discarded.



## System setup menu

Use the **SYSTEM SETUP** menu to change product-configuration defaults such as sleep mode, product personality (language), and jam recovery.

**To display:** Press the **Menu** button , select the **CONFIGURE DEVICE** menu, and then select the **SYSTEM SETUP** menu.

 **NOTE:** Values that have an asterisk (\*) are the factory-default values. Some menu items have no default.

Item	Sub-item	Values	Description
DATE/TIME	DATE	- - - - /[MMM]/[DD] YEAR = [YYYY]/- - /[DD] MONTH= [YYYY]/[MMM]/- - DAY=	Set the correct date. The range for the year is 2009 to 2037.
	DATE FORMAT	YYYY/MMM/DD* MMM/DD/YYYY DD/MMM/YYYY	Choose the order in which the year, month, and day appear in the date.
	TIME	- - :[MM] [PM] HOUR = [HH]: - - [PM] MINUTE= [HH]:[MM] - - AM/PM=	Select a configuration for displaying the time.
	TIME FORMAT	12 HOUR* 24 HOUR	Select whether to use the <b>12 HOUR</b> or the <b>24 HOUR</b> format.
JOB STORAGE LIMIT		Continuous value Range: 1–100 Default = 32	Specify the number of Quick Copy jobs that can be stored on the product.
JOB HELD TIMEOUT		OFF* 1 HOUR 4 HOURS 1 DAY 1 WEEK	Set the amount of time that Quick Copy jobs are kept before being automatically deleted from the queue. This menu item only appears when a hard disk is installed.
SHOW ADDRESS		AUTO OFF*	Specify whether the product's IP address is shown on the display with the <b>Ready</b> message.
QUIET MODE		OFF* ON	Reduce noise during printing. When this setting is turned on, the product prints at a slower speed.
TRAY BEHAVIOR			Control how the product handles paper trays and related prompts at the control panel.

Item	Sub-item	Values	Description
	<b>USE REQUESTED TRAY</b>	<b>EXCLUSIVELY*</b> <b>FIRST</b>	<p>Set how to handle jobs that have specified an input tray.</p> <ul style="list-style-type: none"> <li>● <b>EXCLUSIVELY:</b> The product never selects a different tray when the user has indicated that a specific tray should be used, even if that tray is empty.</li> <li>● <b>FIRST:</b> The product can pull from another tray if the specified tray is empty, even though the user specifically indicated a tray for the job.</li> </ul>
	<b>MANUALLY FEED PROMPT</b>	<b>ALWAYS*</b> <b>UNLESS LOADED</b>	<p>Specify when a manual feed message should appear when the type or size for a job does not match the size or type configured for Tray 1.</p> <ul style="list-style-type: none"> <li>● <b>ALWAYS:</b> A prompt always appears before printing a manual-feed job.</li> <li>● <b>UNLESS LOADED:</b> A message appears only if the multipurpose tray is empty or does not match the size or type of the job.</li> </ul>
	<b>PS DEFER MEDIA</b>	<b>ENABLED*</b> <b>DISABLED</b>	<p>Specify how paper is handled when printing from an Adobe PS print driver.</p> <ul style="list-style-type: none"> <li>● <b>ENABLED:</b> Use HP's paper-handling model.</li> <li>● <b>DISABLED:</b> Use the Adobe PS paper-handling model.</li> </ul>
	<b>SIZE/TYPE PROMPT</b>	<b>DISPLAY*</b> <b>DO NOT DISPLAY</b>	<p>Specify whether the tray configuration message appears whenever a tray is closed.</p> <ul style="list-style-type: none"> <li>● <b>DISPLAY:</b> The tray configuration message displays when a tray is closed. You can configure the tray size or type directly from this message.</li> <li>● <b>DO NOT DISPLAY:</b> The tray configuration message does not display.</li> </ul>

Item	Sub-item	Values	Description
	USE ANOTHER TRAY	ENABLED* DISABLED	<p>Turn on or off the control-panel prompt to select another tray when the specified tray is empty.</p> <ul style="list-style-type: none"> <li>● <b>ENABLED:</b> The product prompts either to add paper to the selected tray or to choose a different tray.</li> <li>● <b>DISABLED:</b> The product prompts the user to add paper to the tray that was initially selected.</li> </ul>
	DUPLEX BLANK PAGES	AUTO* YES	<p>Control how the product handles two-sided jobs (duplexing).</p> <ul style="list-style-type: none"> <li>● <b>AUTO:</b> Enables Smart Duplexing, which instructs the product not to process both sides if the second side is blank. This can improve print speed.</li> <li>● <b>YES:</b> Disables Smart Duplexing and forces the duplexer to flip the sheet of paper even if it is printed on only one side.</li> </ul>
	IMAGE ROTATION	STANDARD* ALTERNATE	<p>Select the <b>ALTERNATE</b> setting if you are having trouble aligning images on preprinted forms.</p>
SLEEP DELAY		1 MINUTE 15 MINUTES 30 MINUTES* 45 MINUTES 60 MINUTES 90 MINUTES 2 HOURS	<p>Reduces power consumption when the product has been inactive for the selected period.</p>
WAKE TIME	<DAY OF THE WEEK>	OFF* CUSTOM	<p>Configure the daily wake time for the product.</p>
DISPLAY BRIGHTNESS		Range is 1 through 10.	<p>Set the brightness of the control panel display. The default is <b>5</b>.</p>
PERSONALITY		AUTO* PCL PDF PS	<p>Set the default personality.</p>


Item	Sub-item	Values	Description
CLEARABLE WARNINGS		<b>JOB*</b>	Sets whether a warning is cleared on the control panel or when another job is sent.
		<b>ON</b>	
AUTO CONTINUE		<b>OFF</b>	Determines product behavior when the system generates an Auto Continuable error.
		<b>ON*</b>	
JAM RECOVERY		<b>AUTO*</b>	Set whether the product tries to reprint pages after a jam.  <b>AUTO:</b> The product reprints pages if enough memory is available for full-speed two-sided printing.
		<b>OFF</b>	
		<b>ON</b>	
RAM DISK		<b>AUTO*</b>	Sets how the RAM disk feature is configured. This is only available if there is no hard disk installed and the printer has at least 8 MB of memory.  <b>AUTO:</b> The product determines the optimal RAM disk size based on the amount of available memory.  <b>OFF:</b> The RAM disk is disabled, but a minimal RAM disk is still active.
		<b>OFF</b>	
LANGUAGE		A listing of available languages appears.	Set the language for the product. The default language is <b>ENGLISH</b> .

## I/O menu

Items on the I/O (input/output) menu affect the communication between the product and the computer. If the product contains an HP Jetdirect print server, you can configure basic networking parameters by using this submenu. You can also configure these and other parameters through HP Web Jetadmin or the embedded Web server.

For more information on these options, see the product user guide.

**To display:** Press the **Menu** button , select the **CONFIGURE DEVICE** menu, and then select the **I/O** menu.

 **NOTE:** Values that have an asterisk (\*) are the factory-default values. Some menu items have no default.

Item	Sub-item	Values	Description
I/O TIMEOUT		Range: 5 - 300	Set the product <b>I/O TIMEOUT</b> in seconds. The default is 15 seconds.  Adjust timeout for the best performance. If data from other ports appears in the middle of your print job, increase the timeout value.

**EMBEDDED JETDIRECT MENU** See the next table for a list of options.

**EIO <X> JETDIRECT MENU**

## Embedded Jetdirect and EIO <X> Jetdirect menus

Item	Sub-item	Sub-item	Values	Description
INFORMATION	PRINT SEC PAGE		<b>YES*</b>	<b>YES:</b> Prints a page that contains the current security settings on the HP Jetdirect print server.
			<b>NO</b>	<b>NO:</b> A security settings page is not printed.
TCP/IP	ENABLE		<b>ON*</b>	<b>ON:</b> Enable the TCP/IP protocol.
			<b>OFF</b>	<b>OFF:</b> Disable the TCP/IP protocol.
	HOST NAME			An alphanumeric string, up to 32 characters, used to identify the product. This name is listed on the HP Jetdirect configuration page. The default host name is NP1xxxxxx, where xxxxxx is the last six digits of the LAN hardware (MAC) address.

Item	Sub-item	Sub-item	Values	Description
	<b>IPV4 SETTINGS</b>	<b>CONFIG METHOD</b>	<b>BOOTP</b>	Specify the method that TCP/IPv4 parameters are configured on the HP Jetdirect print server.  <b>BOOTP:</b> Automatic configuration from a BootP (Bootstrap Protocol) server.  <b>DHCP:</b> Automatic configuration from a DHCPv4 (Dynamic Host Configuration Protocol) server. If selected and a DHCP lease exists, the <b>DHCP RELEASE</b> and <b>DHCP RENEW</b> menus are available to set DHCP lease options.  <b>AUTO IP:</b> Automatic link-local IPv4 addressing. An address in the form 169.254.x.x is assigned automatically.  <b>MANUAL:</b> Use the <b>MANUAL SETTINGS</b> menu to configure TCP/IPv4 parameters.
<b>DHCP*</b>				
<b>AUTO IP</b>				
<b>MANUAL</b>				
		<b>MANUAL SETTINGS</b>	<b>IP ADDRESS</b> <b>SUBNET MASK</b> <b>DEFAULT GATEWAY</b>	(Available only if the <b>CONFIG METHOD</b> menu is set to the <b>MANUAL</b> option) Configure parameters directly from the product control panel:  <b>IP ADDRESS:</b> The unique IP address (n.n.n.n) of the product, where n is a value from 0 to 255.  <b>SUBNET MASK:</b> The subnet mask (n.n.n.n) for the product, where n is a value from 0 to 255.  <b>DEFAULT GATEWAY:</b> The IP address of the gateway or router used for communications with other networks.
	<b>DEFAULT IP</b>		<b>AUTO IP*</b> <b>LEGACY</b>	Specify the IP address to default to when the print server is unable to obtain an IP address from the network during a forced TCP/IP reconfiguration (for example, when manually configured to use BootP or DHCP).  <b>NOTE:</b> This feature assigns a static IP address that might interfere with a managed network.  <b>AUTO IP:</b> A link-local IP address 169.254.x.x is set.  <b>LEGACY:</b> The address 192.0.0.192 is set, consistent with older HP Jetdirect products.
		<b>DHCP RELEASE</b>	<b>YES</b> <b>NO*</b>	Specify whether to release the current DHCP lease and the leased IP address.  <b>NOTE:</b> This menu displays if the <b>CONFIG METHOD</b> is set to the <b>DHCP</b> option and a DHCP lease for the print server exists.

Item	Sub-item	Sub-item	Values	Description
		<b>DHCP RENEW</b>	<b>YES</b> <b>NO*</b>	Specify whether the print server requests to renew the DHCP lease.  <b>NOTE:</b> This menu appears if the <b>CONFIG METHOD</b> menu is set to the <b>DHCP</b> option and a DHCP lease for the print server exists.
		<b>PRIMARY DNS</b>		Specify the IP address (n.n.n.n) of a Primary DNS Server.
		<b>SECONDARY DNS</b>		Specify the IP address (n.n.n.n) of a Secondary Domain Name System (DNS) Server.
	<b>IPV6 SETTINGS</b>	<b>ENABLE</b>	<b>ON*</b> <b>OFF</b>	Enable or disable IPv6 operation on the print server.
		<b>ADDRESS</b>	<b>MANUAL SETTINGS</b>  <ul style="list-style-type: none"> <li>● <b>ENABLE</b></li> <li>● <b>ADDRESS</b></li> </ul>	Enable and manually configure a TCP/IPv6 address.  <b>ENABLE:</b> Choose <b>ON</b> to enable manual configuration, or <b>OFF</b> to disable manual configuration. The default is <b>OFF</b> .  <b>ADDRESS:</b> Type a 32 hexadecimal digit IPv6 node address that uses the colon hexadecimal syntax.
		<b>DHCPV6 POLICY</b>	<b>ROUTER SPECIFIED*</b>  <b>ROUTER UNAVAILABLE</b>  <b>ALWAYS</b>	<b>ROUTER SPECIFIED:</b> The stateful auto-configuration method to be used by the print server is determined by a router. The router specifies whether the print server obtains its address, its configuration information, or both from a DHCPv6 server.  <b>ROUTER UNAVAILABLE:</b> If a router is not available, the print server should attempt to obtain its stateful configuration from a DHCPv6 server.  <b>ALWAYS:</b> Whether or not a router is available, the print server always attempts to obtain its stateful configuration from a DHCPv6 server.
		<b>PRIMARY DNS</b>		Specify an IPv6 address for a primary DNS server that the print server should use.
		<b>SECONDARY DNS</b>		Specify an IPv6 address for a secondary DNS server that the print server should use.

Item	Sub-item	Sub-item	Values	Description
	<b>PROXY SERVER</b>			<p>Specifies the proxy server to be used by embedded applications in the product. A proxy server is typically used by network clients for Internet access. It caches Web pages, and provides a degree of Internet security, for those clients.</p> <p>To specify a proxy server, enter its IPv4 address or fully-qualified domain name. The name can be up to 255 octets.</p> <p>For some networks, you might need to contact your Internet Service Provider (ISP) for the proxy server address.</p>
	<b>PROXY PORT</b>			Type the port number used by the proxy server for client support. The port number identifies the port reserved for proxy activity on your network, and can be a value from 0 to 65535.
	<b>IDLE TIMEOUT</b>			Configure the time period, in seconds, after which an idle TCP print data connection is closed (default is 270 seconds, 0 disables the timeout).
<b>IPX/SPX</b>	<b>ENABLE</b>		<b>ON*</b>	Enable or disable the IPX/SPX protocol.
			<b>OFF</b>	
	<b>FRAME TYPE</b>		<b>AUTO*</b>	Select the frame-type setting for your network.
		<b>EN_8023</b>	<b>AUTO:</b> Automatically sets and limits the frame type to the first one detected.	
		<b>EN_II</b>		
		<b>EN_8022</b>		
	<b>EN_SNAP</b>	<b>EN_8023, EN_II, EN_8022, and EN_SNAP</b> are frame-type selections for Ethernet networks		
<b>APPLETALK</b>	<b>ENABLE</b>		<b>ON*</b>	Configures an AppleTalk network.
			<b>OFF</b>	
<b>DLC/LLC</b>	<b>ENABLE</b>		<b>ON*</b>	Enable or disable the DLC/LLC protocol.
			<b>OFF</b>	
<b>SECURITY</b>	<b>SECURE WEB</b>		<b>HTTPS REQUIRED*</b>	For configuration management, specify whether the embedded Web server will accept communications using HTTPS (Secure HTTP) only, or both HTTP and HTTPS.
			<b>HTTPS OPTIONAL</b>	
	<b>IPSEC</b>		<b>KEEP</b>	Specify the IPsec status on the print server.
		<b>DISABLE*</b>	<b>KEEP:</b> IPsec status remains the same as currently configured.	
		<b>DISABLE:</b> IPsec operation on the print server is disabled.		
	<b>802.1X</b>		<b>RESET</b>	Specify whether to keep the 802.1X settings on the print server or to reset them to the factory defaults.
		<b>KEEP*</b>		



Item	Sub-item	Sub-item	Values	Description
	<b>RESET SECURITY</b>		<b>YES</b> <b>NO*</b>	Specify whether the current security settings on the print server will be saved or reset to factory defaults.
<b>DIAGNOSTICS</b>	<b>EMBEDDED TESTS</b>			<p>This menu provides tests to help diagnose network hardware or TCP/IP network connection problems.</p> <p>Embedded tests help to identify whether a network fault is internal or external to the product. Use an embedded test to check hardware and communication paths on the print server. After you select and enable a test and set the execution time, you must select the <b>EXECUTE</b> option to initiate the test.</p> <p>Depending on the execution time, a selected test runs continuously until either the product is turned off, or an error occurs and a diagnostic page is printed.</p>
		<b>LAN HW TEST</b>	<b>YES</b> <b>NO*</b>	<p><b>CAUTION:</b> Running this embedded test will erase your TCP/IP configuration.</p> <p>Perform an internal loopback test, which sends and receives packets only on the internal network hardware. There are no external transmissions on your network.</p>
		<b>HTTP TEST</b>	<b>YES</b> <b>NO*</b>	Check operation of HTTP by retrieving predefined pages from the product, and test the embedded Web server.
		<b>SNMP TEST</b>	<b>YES</b> <b>NO*</b>	Check operation of SNMP communications by accessing predefined SNMP objects on the product.
		<b>DATA PATH TEST</b>	<b>YES</b> <b>NO*</b>	Identify data path and corruption problems on an HP postscript level 3 emulation product. This test sends a predefined PS file to the product. However, the test is paperless; the file does not print.
		<b>SELECT ALL TESTS</b>	<b>YES</b> <b>NO*</b>	Select all available embedded tests.
		<b>EXECUTION TIME [M]</b>		<p>Specify the length of time (in minutes) that an embedded test will run. You can select a value from 0 to 24 minutes. If you select zero (0), the test runs indefinitely until an error occurs or the product is turned off.</p> <p>Data gathered from the HTTP, SNMP, and Data Path tests is printed after the tests have completed.</p>
		<b>EXECUTE</b>	<b>YES</b> <b>NO*</b>	Select whether to initiate the selected tests.


Item	Sub-item	Sub-item	Values	Description
	<b>PING TEST</b>			Check network communications. This test sends link-level packets to a remote network host, then waits for an appropriate response. To run a ping test, set the following items:
		<b>DEST TYPE</b>	<b>IPv4</b> <b>IPv6</b>	Specify whether the target product is an IPv4 or IPv6 node.
		<b>DEST IPv4</b>		Type the IPv4 address.
		<b>DEST IPv6</b>		Type the IPv6 address.
		<b>PACKET SIZE</b>		Specify the size of each packet, in bytes, to be sent to the remote host. The minimum is 64 (default) and the maximum is 2048.
		<b>TIMEOUT</b>		Specify the length of time, in seconds, to wait for a response from the remote host. The default is 1 and the maximum is 100.
		<b>COUNT</b>		Specify the number of ping test packets to send for this test. Select a value from 0 to 100. The default is 4. To configure the test to run continuously, select 0.
		<b>PRINT RESULTS</b>	<b>YES</b> <b>NO*</b>	If the ping test was not set for continuous operation, you can print the test results.
		<b>EXECUTE</b>	<b>YES</b> <b>NO*</b>	Specify whether to initiate the ping test.
	<b>PING RESULTS</b>			View the ping test status and results on the control panel display. You can select the following items:
		<b>PACKETS SENT</b>		Shows the number of packets (0 - 65535) sent to the remote host since the most recent test was initiated or completed. The default is 0.
		<b>PACKETS RECEIVED</b>		Shows the number of packets (0 - 65535) received from the remote host since the most recent test was initiated or completed. The default is 0.
		<b>PERCENT LOST</b>		Shows the percent (0 to 100) of ping test packets that were sent with no response from the remote host since the most recent test was initiated or completed. The default is 0.
		<b>RTT MIN</b>		Shows the minimum detected round-trip-time (RTT), from 0 to 4096 milliseconds, for packet transmission and response. The default is 0.
		<b>RTT MAX</b>		Shows the maximum detected round-trip-time (RTT), from 0 to 4096 milliseconds, for packet transmission and response. The default is 0.

Item	Sub-item	Sub-item	Values	Description
		<b>RTT AVERAGE</b>		Shows the average round-trip-time (RTT), from 0 to 4096 milliseconds, for packet transmission and response. The default is 0.
		<b>PING IN PROGRESS</b>	<b>YES</b> <b>NO*</b>	Select whether the control panel indicates when a ping test is in progress.
		<b>REFRESH</b>	<b>YES</b> <b>NO*</b>	When viewing the ping test results, this item updates the ping test data with current results. A refresh automatically occurs when the menu times out or you manually return to the main menu.
<b>LINK SPEED</b>			<b>AUTO*</b> <b>10T HALF</b> <b>10T FULL</b> <b>100TX HALF</b> <b>100TX FULL</b> <b>100TX AUTO</b> <b>1000TX FULL</b>	<p>The link speed and communication mode of the print server must match the network. The available settings depend on the product and installed print server.</p> <p><b>CAUTION:</b> If you change the link setting, network communications with the print server and network product might be lost.</p> <p><b>AUTO:</b> The print server uses auto-negotiation to configure itself with the highest link speed and communication mode allowed. If auto-negotiation fails, either <b>100TX HALF</b> or <b>10T HALF</b> is set depending on the detected link speed of the hub/switch port. (A 1000T half-duplex selection is not supported.)</p> <p><b>10T HALF:</b> 10 Mbps, half-duplex operation.</p> <p><b>10T FULL:</b> 10 Mbps, full-duplex operation.</p> <p><b>100TX HALF:</b> 100 Mbps, half-duplex operation.</p> <p><b>100TX FULL:</b> 100 Mbps, full-duplex operation.</p> <p><b>100TX AUTO:</b> Limits auto-negotiation to a maximum link speed of 100 Mbps.</p> <p><b>1000TX FULL:</b> 1000 Mbps, full-duplex operation.</p>

## Resets menu

Use the **RESETS** menu to reset factory settings, disable and enable sleep mode, and update the product after new supplies are installed.


**To display:** Press the **Menu** button , select the **CONFIGURE DEVICE** menu, and then select the **RESETS** menu.


 **NOTE:** Values that have an asterisk (\*) are the factory-default values. Some menu items have no default.

Item	Sub-item	Values	Description
<b>RESTORE FACTORY SETTINGS</b>			Clear the page buffer, remove all perishable personality data, reset the printing environment, and return all default settings to factory defaults.
<b>SLEEP MODE</b>		<b>OFF</b> <b>ON*</b>	Select whether the product can enter sleep mode. If you turn this setting off, you cannot change any settings in the <b>SLEEP DELAY</b> menu.

## Diagnostics menu

Use the **DIAGNOSTICS** menu to run tests that can help you identify and solve problems with the product.

**To display:** Press the **Menu** button , and then select the **DIAGNOSTICS** menu.


 **NOTE:** Values that have an asterisk (\*) are the factory-default values. Some menu items have no default.

Item	Sub-item	Values	Description
<b>PRINT EVENT LOG</b>			Prints a report containing the last 50 entries in the product's event log, starting with the most recent.
<b>SHOW EVENT LOG</b>			Displays the last 50 events; the most recent event is listed first.
<b>PAPER PATH SENSORS</b>			Performs a test on each of the product's sensors to determine if they are working correctly and displays the status of each sensor.
<b>PAPER PATH TEST</b>			Tests the paper-handling features of the product, such as the configuration of the trays.
	<b>PRINT TEST PAGE</b>		Generates a page for testing the paper-handling features. You must define the path for the test to test specific paper paths.

Item	Sub-item	Values	Description
	<b>SOURCE</b>	<b>ALL TRAYS</b> <b>TRAY 1</b> <b>TRAY 2*</b> <b>TRAY 3</b> <b>TRAY 4</b>	Specifies whether the test page is printed from all trays or from a specific tray.
	<b>DUPLEX</b>	<b>OFF</b> <b>ON</b>	Determines whether the duplexer is used in the test.
	<b>COPIES</b>	<b>1*</b> <b>10</b> <b>50</b> <b>100</b> <b>500</b>	Determines how many pages should be sent from the specified source as part of the test.
<b>MANUAL SENSOR TEST</b>			Performs tests to determine whether the paper-path sensors are operating correctly.
<b>MANUAL SENSOR TEST 2</b>			Performs additional tests to determine whether the paper-path sensors are operating correctly.
<b>COMPONENT TEST</b>	A list of available components appears.		Activate individual parts independently to isolate noise and other hardware issues.
<b>PRINT/STOP TEST</b>		Range is 0 - 60,000 milliseconds. The default is 0.	Isolates print quality faults more accurately by stopping the product in midprint cycle, which allows you to see where the image begins to degrade. This causes a jam message that might need to be manually cleared. A service representative should perform this test.
<b>PRINT FUSER TEST PAGE</b>			Tests the fuser for offset problems or contamination.

## Service menu

The **SERVICE** menu is PIN-protected for added security. Only authorized service people have access to the **SERVICE** menu. When you select **SERVICE** from the list of menus, the product prompts you to type an eight-digit PIN number.

- The PIN for the HP LaserJet P3015 models is 07301509.
- 1. Press the **Menu** button .
- 2. Press the down arrow ▼ button or the up arrow ▲ button to navigate to the **SERVICE** menu, and then press the **OK** button.
- 3. Type the PIN using the alphanumeric keypad (for the base model, use the arrow keys).
- 4. Press the **OK** button to accept the PIN and open the **SERVICE** menu.

The following menu items appear in the **SERVICE** menu:

- **CLEAR EVENT LOG:** Use this item to clear the product event log.
- **CLEAR BOOTLOADER PASSWORD:** Use this item to clear the password that was set to prevent someone from performing an unauthorized cold reset, resetting factory defaults, or changing sleep mode settings from the **RESETS** menu.
- **TOTAL PAGE COUNT:** After replacing the formatter, use this item to reset the page count so that the figure continues to represent the page count for the product engine.
- **REFURBISH CYCLE COUNT:** Use this item to record the page count when the product was refurbished.
- **SERIAL NUMBER:** After replacing the formatter, use this item to reset the product serial number.
- **SERVICE ID:** See [Service ID on page 261](#), [Restore service ID on page 261](#), and [Convert the service ID to an actual date on page 261](#).
- **COLD RESET PAPER:** Select this item to reset the default paper size when the formatter is replaced or factory settings are restored (see [Resets menu on page 194](#)).

When a formatter is replaced or factory settings are restored in a country/region that uses A4 as the standard paper size, use this item to reset the default paper size.

# Interpret control-panel messages

## Control-panel message types

Four types of control-panel messages can indicate the status of or problems with the product.

Message type	Description
Status messages	Status messages reflect the current state of the product. They inform you of normal product operation and require no interaction to clear them. They change as the state of the product changes. Whenever the product is ready, not busy, and has no pending warning messages, the status message <b>Ready</b> appears if the product is online.
Warning messages	Warning messages inform you of data and scan errors. These messages typically alternate with the <b>Ready</b> or status messages and remain until you touch the <b>OK</b> button. Some warning messages are clearable. If <b>CLEARABLE WARNINGS</b> is set to <b>JOB</b> on the product <b>SYSTEM SETUP</b> menu, the next job clears these messages.
Error messages	Error messages communicate that some action must be performed, such as clearing a jam.  Some error messages are auto-continuable. If <b>AUTO CONTINUE</b> is set on the menus, the device will continue normal operation after an auto-continuable error message appears for 10 seconds.  <b>NOTE:</b> Pressing any button during the 10-second auto-continuable error message overrides the auto-continue feature, and the button function takes precedence. For example, pressing the stop button pauses scanning and offers the option to cancel the job.
Critical-error messages	Critical error messages inform you of a product failure. Some of these messages can be cleared by turning the product off and then on. These messages are not affected by the <b>AUTO CONTINUE</b> setting. If a critical error persists, service is required.

## Control-panel messages

Table 3-7 Control-panel messages

Control panel message	Description	Recommended action
<b>10.10.00 ERROR</b>	The product cannot read or write to the print cartridge e-label, or the e-label is missing from the print cartridge.	<ol style="list-style-type: none"><li>1. Verify that a genuine HP print cartridge is installed in the product.</li><li>2. Install another print cartridge.</li><li>3. Verify that the memory tag PCA is installed in the product.</li><li>4. Verify that the memory tag connector is firmly seated in connector J1703 on the ECU. You might have to remove the main cooling fan to see this connection.</li></ol>

**Table 3-7 Control-panel messages (continued)**

Control panel message	Description	Recommended action
<b>10.91.00 CARTRIDGE ERROR</b> <b>REPLACE BLACK CARTRIDGE</b>	An error has occurred in the cartridge	<ol style="list-style-type: none"> <li>1. Open the cartridge door.</li> <li>2. Remove the print cartridge, and then reinstall it.</li> <li>3. Close the cartridge door.</li> <li>4. Turn the product off and then on.</li> <li>5. Verify that a genuine HP print cartridge is installed in the product.</li> <li>6. Install another print cartridge.</li> <li>7. Verify that the memory tag PCA is installed in the product.</li> <li>8. Verify that the memory tag connector is firmly seated in connector J1703 on the ECU. You might have to remove the main cooling fan to see this connection.</li> </ol>
<b>10.XX.YY SUPPLY MEMORY ERROR</b>	<p>The product cannot read or write to the print cartridge memory tag, or the memory tag is missing.</p> <p>10.00.0Y = memory is defective</p> <p>10.10.0Y = memory is missing</p>	<ol style="list-style-type: none"> <li>1. Open the cartridge door.</li> <li>2. Remove the print cartridge, and then reinstall it.</li> <li>3. Close the cartridge door.</li> <li>4. Turn the product off and then on.</li> <li>5. Verify that a genuine HP print cartridge is installed in the product.</li> <li>6. Verify that the memory tag PCA is installed in the product.</li> <li>7. Verify that the memory tag connector is firmly seated in connector J1703 on the ECU. You might have to remove the main cooling fan to see this connection.</li> <li>8. Install another print cartridge.</li> </ol>
<b>11.XX INTERNAL CLOCK ERROR</b> <b>To continue press OK</b>	<p>The real time clock has experienced an error.</p> <p>XX = 01: Dead clock battery</p> <p>XX = 02: Dead real time clock</p>	<p>Printing can continue, but a prompt appears every time you turn on the product. To resolve the issue:</p> <ol style="list-style-type: none"> <li>1. Power cycle the product to see if the prompt clears.</li> <li>2. If possible, print a configuration page to record product information, and then perform an NVRAM initialization routine. If the initialization routine is successful, you must re-enter several configuration parameters (such as the page count and the serial number).</li> <li>3. If the error persists, replace the formatter PCA.</li> </ol>




**Table 3-7 Control-panel messages (continued)**

Control panel message	Description	Recommended action
13.JJ.NT JAM IN <LOCATION>	A jam has occurred in the specified location.	Remove the jammed paper. See <a href="#">Jam locations on page 220</a> .
13.JJ.NT JAM INSIDE <LOCATION>	<ul style="list-style-type: none"> <li>● 13.JJ.NT JAM INSIDE REAR DOOR</li> <li>● 13.JJ.NT JAM IN FUSER</li> <li>● 13.JJ.NT JAM INSIDE TOP COVER</li> <li>● 13.JJ.NT JAM IN TRAY 1</li> <li>● 13.JJ.NT JAM IN TRAY &lt;X&gt;</li> <li>● 13.JJ.NT JAM IN TRAY 2</li> <li>● 13.JJ.NT JAM INSIDE DUPLEXER</li> </ul>	If the message persists after you have cleared all jams, a sensor might be stuck or broken. See <a href="#">Paper-path test (and automatic sensors test) on page 136</a> or <a href="#">Sensor test (interactive) on page 137</a> .
13.JJ.NT PAPER JAM OPEN INPUT TRAYS	A jam has occurred in a tray.	<ol style="list-style-type: none"> <li>1. Open each tray and check for jammed paper.</li> <li>2. Open the cartridge door.</li> <li>3. Remove the print cartridge and any paper.</li> <li>4. Reinstall the print cartridge and close the cartridge door.</li> <li>5. Close all trays.</li> <li>6. Remove the jammed paper. See <a href="#">Jam locations on page 220</a>.</li> <li>7. If the message persists after you have cleared all jams, a sensor might be stuck or broken. See <a href="#">Paper-path test (and automatic sensors test) on page 136</a> or <a href="#">Sensor test (interactive) on page 137</a>.</li> </ol>
alternates with		
<b>Open all trays</b>		
21 PAGE TOO COMPLEX	The data in the print job is too complex.	<ol style="list-style-type: none"> <li>1. Press the <b>OK</b> button to print the transferred data (some data might be lost).</li> <li>2. If this message displays often, simplify the print job or install more memory.</li> </ol>
<b>For help press ?</b>		
alternates with		
21 PAGE TOO COMPLEX		
<b>To continue press OK</b>		
22 EIO X BUFFER OVERFLOW	Too much data was sent to the EIO card in the specified slot [X]. An improper communications protocol might be in use.	<ol style="list-style-type: none"> <li>1. Press the <b>OK</b> button to clear the message. (The job does not print.)</li> <li>2. Check the host configuration. If the message persists, contact an HP-authorized service or support provider.</li> </ol>
<b>To continue press OK</b>	Note: EIO 0 is reserved for the HP Jetdirect embedded print server.	
22 EMBEDDED I/O BUFFER OVERFLOW	Too much data was sent to the product's internal HP Jetdirect.	Press the <b>OK</b> button to continue printing. Some data might be lost.
<b>To continue press OK</b>		
22 USB I/O BUFFER OVERFLOW	Too much data was sent to the USB port.	Press the <b>OK</b> button to clear the error message. (The job does not print.)
<b>To continue press OK</b>		

**Table 3-7 Control-panel messages (continued)**

Control panel message	Description	Recommended action
<p><b>40 EIO X BAD TRANSMISSION</b></p> <p>To continue press OK</p>	<p>The connection has been broken between the product and the EIO card in the specified slot [X].</p> <p>Note: EIO 0 is reserved for the HP Jetdirect embedded print server.</p>	<p>Press the <b>OK</b> button to clear the error message and continue printing.</p>
<p><b>40 EMBEDDED I/O BAD TRANSMISSION</b></p> <p>To continue press OK</p>	<p>The connection has been broken between the product and HP Jetdirect print server.</p>	<ol style="list-style-type: none"> <li>1. Print the configuration and Embedded JetDirect pages to verify that the card status is "Ready," and that the protocol reads "Ready."</li> <li>2. Verify that all the configuration parameters (IP address, configuration method, and domain) are correct.</li> <li>3. Verify that you are using a working network cable.</li> <li>4. Verify you can "ping" a network address from the product.</li> <li>5. Verify that the HP JetDirect print server has the latest firmware. HP JetDirect firmware is part of the product firmware. Find the latest product firmware at <a href="http://www.hp.com">www.hp.com</a>.</li> </ol>
<p><b>41.3 UNEXPECTED SIZE IN TRAY 1 MANUALLY FEED &lt;TYPE&gt; &lt;SIZE&gt;</b></p>	<p>You have configured Tray 1 for a different size of paper than the print job requires.</p> <p><b>NOTE:</b> This error can be caused by a multi feed problem. Open, and then close, the cartridge door to clear the error message. If the error persists, and the tray is correctly configured, try cleaning the Tray 1 pickup roller (or you might have to replace the roller).</p>	<p>Reload the tray with the correct paper size.</p> <p>If another tray contains the correct size, the product prompts you to press the <b>OK</b> button to use another tray.</p>
<p><b>41.3 UNEXPECTED SIZE IN TRAY &lt;X&gt;</b></p> <p>For help press ?</p> <p>alternates with</p> <p><b>LOAD TRAY &lt;X&gt; [TYPE] [SIZE]</b></p> <p>To use another tray press OK</p>	<p>You have configured the tray for a different size of paper than the print job requires.</p> <p><b>NOTE:</b> This error can be caused by a multi feed problem. Open, and then close, the cartridge door to clear the error message. If the error persists, and the tray is correctly configured, try cleaning the Tray 1 pickup roller (or you might have to replace the roller).</p>	<ol style="list-style-type: none"> <li>1. Reload the tray with the correct paper size.</li> <li>2. Make sure the paper size that is specified in the software program, the printer driver, and the control panel are all the same.</li> <li>3. Press the <b>OK</b> button and scroll to the <b>TRAY &lt;X&gt; SIZE = &lt;Size&gt;</b> option. Reconfigure the size in a tray to match the size required for the print job.</li> <li>4. If the error does not clear, turn the product off and then on.</li> <li>5. If the message persists, contact an HP-authorized service or support provider.</li> </ol>

**Table 3-7 Control-panel messages (continued)**

Control panel message	Description	Recommended action
<b>41.X ERROR</b>  For help press ?  alternates with  <b>41.X ERROR</b>  To continue press OK	A temporary printing error occurred.	<ol style="list-style-type: none"><li>1. Press the <b>OK</b> button to see if the page will print. If necessary, turn the product off and then on.</li><li>2. Verify that the correct size paper is loaded in the input tray.</li><li>3. Verify that the loaded paper meets HP specifications. If the paper sticks together, the paper defect sensors will detect a sheet of paper longer than what is expected in the product.</li><li>4. Verify that all paper size settings on the control panel, in the print driver settings, and in the software program match.</li></ol>
<b>49.XXXX ERROR</b>  To continue turn off then on	A critical firmware error has occurred that caused the processor on the formatter to cease operation. This error can be caused by invalid print commands, corrupt data, or invalid operations. Sometimes electrical “noise” in the cable can corrupt data during transmission to the product. Other causes can be poor-quality cables, poor connections, or home-grown programs. On rare occasions, the formatter is at fault.	<ol style="list-style-type: none"><li>1. Turn off the product, and then turn it on.</li><li>2. Press the stop button  to clear the print job from the product memory.</li><li>3. Turn off the product, and then turn it on.</li><li>4. Print a document from a different software program. If the job prints, return to the first program and try to print a different file. If the message displays only with a certain program or print job, contact the software vendor for assistance.</li><li>5. If the message persists with different software programs and print jobs, disconnect the cables to the product that connect it to the network or computer.</li><li>6. Turn off the product.</li><li>7. Remove all EIO devices from the product.</li><li>8. Turn on the product.</li><li>9. If the error no longer exists, replace each EIO device one at a time, making sure to turn the product off and on again as you install each device.</li><li>10. Replace an EIO device if you determine that it causes the error.</li></ol>

**Table 3-7 Control-panel messages (continued)**

Control panel message	Description	Recommended action
<p><b>50.X FUSER ERROR</b></p> <p><b>For help press ?</b></p>	<p>A fuser error has occurred. The values for X are listed below.</p> <ul style="list-style-type: none"> <li>● <b>50.1:</b> Low fuser temperature of thermistor (TH1)</li> <li>● <b>50.2:</b> Fuser warm-up service</li> <li>● <b>50.3:</b> High fuser temperature of thermistor (TH1)</li> <li>● <b>50.4:</b> Faulty fuser (drive circuit failure)</li> <li>● <b>50.8:</b> Lower fuser temperature of thermistor (TH2)</li> <li>● <b>50.9:</b> High fuser temperature of thermistor (TH2)</li> </ul>	<ol style="list-style-type: none"> <li>1. Power cycle the product to determine if the error is persistent.</li> <li>2. Verify that the correct fuser model is installed in the product.</li> <li>3. Verify that the correct voltage fuser is installed in the product.</li> <li>4. <b>50.2 errors:</b> Make sure that the connectors J8002 and J1505 are fully seated on the ECU, and connector J18 is fully seated on the fuser.</li> <li>5. <b>50.1, 50.3, 50.8, and 50.9 errors:</b> Make sure that the connectors J18 and J1608 are fully seated on the ECU.</li> <li>6. <b>50.8 errors:</b> Remove the fuser and make sure that there is no residual media or toner has built up on the fuser.</li> <li>7. <b>50.4 errors:</b> Make sure that the power to the product meets the specifications for the product.</li> </ol> <p><b>NOTE:</b> If the power supplied to the product is outside the specifications, the fuser temperature control circuit will not properly work, causing a fuser malfunction.</p> <p>Make sure that the connector J1002 and J1505 are fully seated on the ECU.</p> <p>If the error persists, replace the ECU.</p> <ol style="list-style-type: none"> <li>8. If the error persists, replace the fuser.</li> </ol>
<p><b>51.XY ERROR</b></p> <p><b>To continue turn off then on</b></p>	<p>A laser/scanner error has occurred.</p>	<ol style="list-style-type: none"> <li>1. From the <b>DIAGNOSTICS</b> menu, run the laser/scanner motor component test. Verify that you can hear the motor rotate.</li> <li>2. If you cannot hear the motor rotate, verify that connector J1702 and connector J1505 are fully seated on the DC controller PCA (ECU).</li> <li>3. Verify that the connector J100 on the laser/scanner assembly is securely attached.</li> <li>4. If the error persists, replace the laser/scanner assembly.</li> </ol>


**Table 3-7 Control-panel messages (continued)**

Control panel message	Description	Recommended action
<p><b>52.XY ERROR</b></p> <p><b>For help press ?</b></p> <p>alternates with</p> <p><b>52.XY ERROR</b></p> <p><b>To continue turn off then on</b></p>	<p>A laser/scanner error has occurred.</p> <p>X = 0, Y = 0: scanner error</p> <p>X = 2, Y = 0: scanner rotation error</p>	<ol style="list-style-type: none"> <li>From the <b>DIAGNOSTICS</b> menu, run the laser/scanner motor component test. Verify that you can hear the motor rotate.</li> <li>If you cannot hear the motor rotate, verify that connector J1702 and J1505 are fully seated on the DC controller PCA (ECU).</li> <li>Verify that the connector J12 on the laser/scanner assembly is securely attached.</li> <li>If the error persists, replace the laser/scanner assembly.</li> </ol>
<p><b>53.X0.01 ERROR</b></p> <p><b>UNSUPPORTED DIMM</b></p>	<p>The product does not support the DIMM.</p>	<p>Replace the DIMM with one that the product supports.</p>
<p><b>55.XX.YY DC CONTROLLER ERROR</b></p> <p><b>For help press ?</b></p> <p>alternates with</p> <p><b>55.XX.YY DC CONTROLLER ERROR</b></p> <p><b>To continue turn off then on</b></p>	<p>A temporary printing error occurred.</p>	<ol style="list-style-type: none"> <li>Turn the product off and then on.</li> <li>Remove any third-party memory or USB device, and then turn the product off and then on.</li> <li>Remove and then reinstall the formatter.</li> <li>If the error persists, remove the formatter and perform an engine test (see <a href="#">Engine-test button on page 134</a>). If the engine test page fails to print, replace the DC controller (part of the ECU). If the engine test page prints, replace the formatter.</li> </ol>
<p><b>56.X ERROR</b></p> <p><b>For help press ?</b></p> <p>alternates with</p> <p><b>56.X ERROR</b></p> <p><b>To continue turn off then on</b></p>	<p>The input device is unknown.</p> <p>56.1 = unknown input device</p>	<ol style="list-style-type: none"> <li>Turn the product off and then on.</li> <li>Reinstall all the input devices.</li> <li>Remove all non-HP paper handling devices.</li> </ol>
<p><b>57.XX ERROR</b></p> <p><b>For help press ?</b></p> <p>alternates with</p> <p><b>57.XX ERROR</b></p> <p><b>To continue turn off then on</b></p>	<p>A temporary printing error occurred in one of the two product fans (main fan FM1 or sub fan FM2).</p> <p>57.03: sub fan FM2 error</p> <p>57.04: main fan FM1 error</p>	<ol style="list-style-type: none"> <li>Turn the product off and then on.</li> <li>Verify that the main fan connection at connector J1606 on the DC controller PCA (ECU) is firmly seated.</li> <li>Verify that the sub fan connection at connector J1505 on the DC controller PCA (ECU) is firmly seated.</li> <li>Turn the printer on and verify each fan is spinning.</li> <li>Replace the main fan or the sub fan if they are not operational.</li> </ol>


**Table 3-7 Control-panel messages (continued)**

Control panel message	Description	Recommended action
<p><b>58.XX ERROR</b></p> <p><b>For help press ?</b></p> <p>alternates with</p> <p><b>58.XX ERROR</b></p> <p><b>To continue turn off then on</b></p>	<p>A product error has occurred where a memory tag CPU error was detected, or there is a problem with the air sensor or power supply.</p> <ul style="list-style-type: none"> <li>• 58.02 = check environmental sensor TH3</li> <li>• 58.04 = check low-voltage power supply (ECU)</li> </ul>	<p>Make sure the line voltage and current source meet the electrical specifications for the product.</p> <p>To resolve problems with the power supply:</p> <ol style="list-style-type: none"> <li>1. Remove the product from any UPS supplies, additional power supplies, or power strips. Plug the product into a wall outlet and see if this resolves the problem.</li> <li>2. If the product is already plugged into a wall outlet, try another power source in the building that is independent of the one being used.</li> <li>3. Replace the ECU.</li> </ol>
<p><b>59.XY ERROR</b></p> <p><b>For help press ?</b></p> <p>alternates with</p> <p><b>59.XY ERROR</b></p> <p><b>To continue turn off then on</b></p>	<p>A temporary printing error occurred.</p> <ul style="list-style-type: none"> <li>• 59.30 = fuser motor start up error (M8002)</li> <li>• 59.40 = fuser motor rotation error (M8002)</li> <li>• 59.50 = main motor start up error (M8001)</li> <li>• 59.60 = main motor rotation error (M8001)</li> </ul>	<p><b>59.30 and 59.40 errors</b></p> <ol style="list-style-type: none"> <li>1. Turn the product off and then on.</li> <li>2. Make sure that connectors J8002 and J1504 are fully seated on the ECU.</li> <li>3. Use the <b>COMPONENT TEST</b> (in the <b>DIAGNOSTICS</b> menu) to test the fuser motor functionality. If necessary, replace the motor (M8002).</li> </ol> <p><b>59.50 and 59.60 errors</b></p> <ol style="list-style-type: none"> <li>1. Make sure that connector J1503 is fully seated on the ECU.</li> <li>2. Use the <b>COMPONENT TEST</b> (in the <b>DIAGNOSTICS</b> menu) to test the main motor functionality. If necessary, replace the motor (M8001).</li> </ol>
<p><b>68.X PERMANENT STORAGE FULL</b></p> <p><b>For help press ?</b></p> <p>alternates with</p> <p><b>68.X PERMANENT STORAGE FULL</b></p> <p><b>To continue press OK</b></p>	<p>The permanent storage is full. Some settings might have been reset to the factory defaults.</p>	<ol style="list-style-type: none"> <li>1. If the error does not clear, turn the product off and then on.</li> <li>2. Print a configuration page and check the product settings to determine which values have changed.</li> <li>3. To clean up permanent storage, turn the product off, and then press and hold the <b>Menu</b> button  while turning the product on.</li> <li>4. If the message persists, contact an HP-authorized service or support provider.</li> </ol>
<p><b>68.X PERMANENT STORAGE WRITE FAIL</b></p> <p><b>To continue press OK</b></p>	<p>The storage device is failing to write. Printing can continue, but there might be some unexpected behaviors because an error occurred in permanent storage.</p>	<p>Press the <b>OK</b> button to continue.</p> <p>If the error does not clear, turn the product off and then on.</p>

**Table 3-7 Control-panel messages (continued)**

Control panel message	Description	Recommended action
<p><b>68.X STORAGE ERROR SETTINGS CHANGED</b></p> <p>For help press ?</p> <p>alternates with</p> <p><b>68.X STORAGE ERROR SETTINGS CHANGED</b></p> <p>To continue press OK</p>	<p>An error occurred in the product permanent storage and one or more product settings has been reset to its factory default.</p>	<p>Press the <b>OK</b> button to resume printing.</p> <p>Print a configuration page, a menu map, and check the product settings to determine which values have changed.</p> <p>If the error does not clear, turn the product off and then on.</p>
<p><b>69.X ERROR</b></p>	<p>Duplexer mechanism has failed.</p>	<p>Turn the product off and then on.</p>
<p><b>79.XXXX ERROR</b></p> <p>To continue turn off then on</p>	<p>The product detected a critical hardware error.</p>	<ol style="list-style-type: none"> <li>1. Press the stop button  to clear the print job from the product memory. Turn the product off and then on.</li> <li>2. Try printing a job from a different program. If the job prints, go back to the first program and try printing a different file. If the message displays only with a certain program or print job, contact the software vendor for assistance.</li> </ol> <p>If the message persists with different programs and print jobs, try these steps.</p> <ol style="list-style-type: none"> <li>1. Turn the product off.</li> <li>2. Disconnect all cables to the product that connect it to the network or computer.</li> <li>3. Remove all the memory DIMMs or third-party DIMMs from the product. Then reinstall the memory DIMM.</li> <li>4. Remove the EIO device from the product.</li> <li>5. Turn the product on.</li> </ol> <p>If the error no longer exists, follow these steps.</p> <ol style="list-style-type: none"> <li>1. Install the DIMM and EIO device one at a time, making sure to turn the product off and then on as you install each device.</li> <li>2. Replace the DIMM or EIO device that you determine caused the error.</li> <li>3. Reconnect all cables that connect the product to the network or computer.</li> </ol>

**Table 3-7 Control-panel messages (continued)**

Control panel message	Description	Recommended action
<b>8X.YYYY EIO ERROR</b>	The EIO accessory card in slot [X] has encountered a critical error.	<ol style="list-style-type: none"> <li>1. Turn the product off and then on.</li> <li>2. Turn the product off, reseal the EIO accessory in slot [X], and then turn the product on.</li> <li>3. Turn the product off, remove the EIO accessory from slot [X], install it in a different EIO slot, and then turn the product on.</li> <li>4. Replace the EIO accessory in slot [X].</li> </ol>
<b>8X.YYYY EMBEDDED JETDIRECT ERROR</b>	The embedded HP Jetdirect print server has encountered a critical error.	Turn the product off and then on.
<b>&lt;BINNAME&gt; FULL</b>	This message appears on the control-panel display, but the bin is not full.	<ol style="list-style-type: none"> <li>1. Make sure that the media full sensor flag is not damaged and can freely move. If the sensor flag is damaged, replace the top-cover assembly.</li> <li>2. Make sure that the connector J4 on is fully seated on the sensor and connector J1605 is fully seated on the ECU.</li> <li>3. Use the G FD tray full sensor test in the <b>MANUAL SENSOR TEST</b> menu (in the <b>DIAGNOSTICS</b> menu) to test the sensor functionality. If necessary, replace the sensor (PS1).</li> </ol>
<p><b>ACCEPT BAD SIGNATURE?</b></p> <p>Yes press OK</p> <p>alternates with</p> <p><b>ACCEPT BAD SIGNATURE?</b></p> <p>No press ⊗</p>	The product is performing a remote firmware upgrade, the first-time code signing does not match the signature, and the <b>SIGNATURE CHECK</b> menu is set to the <b>PROMPT IF BAD</b> option.	Download the correct firmware upgrade file for this product, and then reinstall the upgrade.
<b>Access denied MENUS LOCKED</b>	The product control-panel function you are trying to use has been locked to prevent unauthorized access.	See your system administrator.
<p><b>Action not currently available for tray x</b></p> <p>Tray size cannot be ANY SIZE/ANY CUSTOM</p>	Duplexing is not available when the tray size is set to the <b>ANY SIZE</b> setting or the <b>ANY CUSTOM</b> setting.	<p>Change tray settings.</p> <ol style="list-style-type: none"> <li>1. Press the <b>Menu</b> button .</li> <li>2. Press the down arrow ▼ button or the up arrow ▲ button to navigate to the <b>PAPER HANDLING</b> menu, and then press the <b>OK</b> button.</li> <li>3. Press the down arrow ▼ button to highlight the specified tray, and then press the <b>OK</b> button.</li> <li>4. Change the selected tray's size and type settings.</li> </ol>
<b>BAD OPTIONAL TRAY CONNECTION</b>	An optional tray is not connected correctly.	Remove the product from the tray, and reinstall it. Turn the product off and then on.



**Table 3-7 Control-panel messages (continued)**

Control panel message	Description	Recommended action
<b>Bad signature</b> <b>Upgrade cancelled</b>	The firmware upgrade code does not match the product signature.	Download the correct firmware upgrade file for this product, and then reinstall the upgrade.
<b>BLACK CARTRIDGE VERY LOW</b>	The product indicates when a supply level is very low. Actual print cartridge life might vary. Consider having a replacement print cartridge available to install when print quality is no longer acceptable. You do not need to replace the print cartridge at this time unless print quality is no longer acceptable. After an HP supply has reached the very low threshold, the HP premium protection warranty for that supply has ended.	If print quality is no longer acceptable, replace the print cartridge.
<b>Canceling...</b>	The product is canceling a job. The message continues while the product clears the paper path and clears any remaining incoming data.	No action is necessary.
<b>CANNOT DUPLEX</b> <b>CLOSE REAR DOOR</b> <b>For help press ?</b>	The rear door must be closed to duplex.	Close the rear door.
<b>Checking paper path</b>	The product is checking for possible jams or paper that was not cleared from the product.	No action is necessary.
<b>Checking printer</b>	The product is checking for possible jams or paper that was not cleared from the product.	No action is necessary.
<b>CHOSEN PERSONALITY NOT AVAILABLE</b> <b>To continue press OK</b>	The product received a request for a personality (product language) that does not exist. The print job is canceled.	Print the job using a printer driver for a different product language, or add the requested language to the product (if available).  To see a list of available personalities, print a configuration page.
<b>CLEANING DISK &lt;X&gt;% COMPLETE</b> <b>Do not power off</b> alternates with <b>CLEANING DISK &lt;X&gt;% COMPLETE</b> <b>For help press ?</b>	The storage device is being sanitized or cleaned. Do not turn off. Product functions are unavailable. The product automatically turns off and then on when finished.	No action is necessary.
<b>CLEANING PAGE ERROR</b> <b>Open rear door</b>	You are processing a cleaning page with the rear door closed.	Open the rear output bin to begin creating or processing the cleaning page.
<b>CLEANING...</b> <b>DO NOT GRAB PAPER</b>	The product is performing an automatic cleaning.	No action is necessary.
<b>Clearing event log</b>	The product is clearing the event log.	No action is necessary.
<b>Clearing paper path</b>	The product jammed or was turned on and paper was detected in a wrong location. The product is automatically attempting to eject the pages.	Wait for the product to finish trying to clear the pages. If it cannot, a jam message displays on the control panel.

**Table 3-7 Control-panel messages (continued)**

Control panel message	Description	Recommended action
<b>CLOSE REAR DOOR</b>	This message appears on the control-panel display, but the rear door is closed.	<ol style="list-style-type: none"> <li>1. Make sure that the connectors J8001 and J1505 are fully seated on the ECU.</li> <li>2. Use the J Rear cover open sensor test in the <b>MANUAL SENSOR TEST</b> menu (in the <b>DIAGNOSTICS</b> menu), to check the rear door sensor functionality. If necessary, replace the sensor (PS8001).</li> </ol>
<b>CLOSE TOP COVER</b>	This message appears on the control-panel display, but the cartridge door is closed.	<ol style="list-style-type: none"> <li>1. Make sure that connectors FT1 and FT2 are fully seated on the cartridge door switch SW501.</li> <li>2. Make sure that the tab on the cartridge door that activates the switch is not missing or damaged. Replace the cartridge-door assembly if necessary.</li> <li>3. Replace the door switch (SW501).</li> </ol>
<b>CODE CRC ERROR</b>	An error occurred during a firmware upgrade.	Resend the firmware upgrade.
<b>SEND RFU UPGRADE ON USB DEV PORT</b>		
<b>DATA RECEIVED</b>	The product is waiting for the print command.	Press the <b>OK</b> button to continue.
<b>To print last page press OK</b>		
alternates with		
<Current status message>		
<b>DATE/TIME = YYYY/MMM/DD HH:MM</b>	The current date and time.	Set the date and time or press the stop button  to skip.
<b>To change press OK</b>		
<b>To skip press </b>		
<b>Deleting...</b>	Product is deleting a stored job.	No action is necessary.
<b>DUPLEX OPERATION FAILED</b>	A timing error has occurred during a duplex printing job.	Press the <b>OK</b> button to continue printing. If the error occurs again, cancel the job and print it as a single-sided job.
<b>To continue press OK</b>		
alternates with		
<b>DUPLEX OPERATION FAILED</b>		
<b>For help press ?</b>		
<b>EIO &lt;X&gt; DISK NOT FUNCTIONAL</b>	The EIO disk in slot X is not working correctly.	<ol style="list-style-type: none"> <li>1. Turn the product off.</li> <li>2. Make sure the EIO disk is inserted correctly and securely fastened.</li> <li>3. If the control panel message continues to appear, replace the disk.</li> </ol>
<b>For help press ?</b>		
<b>EIO &lt;X&gt; DISK SPINNING UP</b>	The disk accessory in EIO slot [X] is initializing.	No action is necessary.
alternates with		
<Current status message>		

**Table 3-7 Control-panel messages (continued)**

Control panel message	Description	Recommended action
<b>EIO DEVICE FAILURE</b> To clear press OK	The specified device has failed.	Press the <b>OK</b> button to continue.
<b>EIO FILE OPERATION FAILED</b> To clear press OK	A command attempted an illogical operation.	Press the <b>OK</b> button to continue.
<b>EIO FILE SYSTEM IS FULL</b> To clear press OK	The specified file system is full and cannot be written to.	Press the <b>OK</b> button to continue.
<b>EIO IS WRITE PROTECTED</b> To clear press OK	The file system cannot be written to.	Press the <b>OK</b> button to continue.
<b>Event log empty</b>	You are attempting to view an empty event log by selecting the <b>SHOW EVENT LOG</b> option from the control panel.	No action is necessary.
<b>INCOMPATIBLE BLACK CARTRIDGE</b>	The print cartridge is for another product.	Replace the print cartridge with a print cartridge for this product.
<b>Incorrect</b>	The wrong PIN number was entered.	Reenter PIN number.
<b>INFLATE FAILURE</b> <b>SEND RFU UPGRADE ON USB DEV PORT</b>	An error occurred during a firmware upgrade.	Resend the firmware upgrade.
<b>Initializing</b>	Individual tasks are being initialized.	No action is necessary.
<b>INSERT OR CLOSE TRAY &lt;X&gt;</b> For help press ?	The specified tray is open or missing.	Insert or close the tray for printing to continue.
<b>INSTALL BLACK CARTRIDGE</b> For help press ?	The print cartridge is missing.	<ol style="list-style-type: none"> <li>1. Open the cartridge door.</li> <li>2. Install the cartridge.</li> <li>3. Close the cartridge door.</li> </ol>
<b>INSUFFICIENT MEMORY TO LOAD FONTS/DATA</b> For help press ? alternates with <DEVICE> To continue press OK	The product received more data than can fit in its available memory. You might have tried to transfer too many macros, soft fonts, or complex graphics.	<p>Press the <b>OK</b> button to print the transferred data (some data might be lost).</p> <p>Simplify the print job or install additional memory.</p>
<b>LOAD TRAY 1 [TYPE] [SIZE]</b> To continue press OK alternates with <b>LOAD TRAY 1 [TYPE] [SIZE]</b> For help press ?	Tray 1 is empty.	<p>Load Tray 1 with the requested paper.</p> <p>If the paper is already in the Tray 1, press the help button <b>?</b>, and then press the <b>OK</b> button to print.</p> <p>To use another tray, remove paper from Tray 1, and then press the <b>OK</b> button to continue.</p>

**Table 3-7 Control-panel messages (continued)**

Control panel message	Description	Recommended action
<p><b>LOAD TRAY 1 [TYPE] [SIZE]</b></p> <p><b>To use another tray press OK</b></p> <p>alternates with</p> <p><b>LOAD TRAY 1 [TYPE] [SIZE]</b></p> <p><b>For help press ?</b></p>	<p>Tray 1 is empty and other trays are available.</p>	<p>Press the <b>OK</b> button to use another tray.</p> <p>To use Tray 1, load it with the requested paper.</p> <p>If the paper is already in the Tray 1, press the help button <b>?</b>, and then press the <b>OK</b> button to print.</p> <p>To use another tray, remove paper from Tray 1, and then press the <b>OK</b> button to use another tray.</p>
<p><b>LOAD TRAY &lt;X&gt; [TYPE] [SIZE]</b></p> <p><b>For help press ?</b></p>	<p>The indicated tray is configured for a specific type and size of paper required by a print job, but the tray is empty. All other trays are also empty.</p>	<p>Load the requested paper in the tray.</p>
<p><b>LOAD TRAY &lt;X&gt; [TYPE] [SIZE]</b></p> <p><b>To use another tray press OK</b></p> <p>alternates with</p> <p><b>LOAD TRAY &lt;X&gt; [TYPE] [SIZE]</b></p> <p><b>For help press ?</b></p>	<p>A job is sent that requires a specific type and size that is not available in the tray that is indicated.</p>	<p>Press the <b>OK</b> button to use a type and size that are available in another tray.</p>
<p><b>MANUALLY FEED &lt;TYPE&gt; &lt;SIZE&gt;</b></p>	<p>The product is waiting for you to load paper in Tray 1.</p>	<p>If paper is already in the Tray 1, press the help button <b>?</b>, and then press the <b>OK</b> button to print.</p> <p>To use another tray, remove paper from Tray 1, and then press the <b>OK</b> button.</p>
<p><b>MANUALLY FEED &lt;TYPE&gt; &lt;SIZE&gt;</b></p> <p><b>To continue press OK</b></p> <p>alternates with</p> <p><b>MANUALLY FEED &lt;TYPE&gt; &lt;SIZE&gt;</b></p> <p><b>For help press ?</b></p>	<p>The product is waiting for you to load paper in Tray 1.</p>	<p>Load the requested paper into Tray 1 and press the <b>OK</b> button.</p>
<p><b>MANUALLY FEED &lt;TYPE&gt; &lt;SIZE&gt;</b></p> <p><b>To use another tray press OK</b></p> <p>alternates with</p> <p><b>MANUALLY FEED &lt;TYPE&gt; &lt;SIZE&gt;</b></p> <p><b>For help press ?</b></p>	<p>The product is waiting for you to load paper in Tray 1.</p>	<p>Press the <b>OK</b> button to use a type and size that are available in another tray.</p>
<p><b>MANUALLY FEED OUTPUT STACK</b></p> <p><b>Then press OK to print second sides</b></p>	<p>The first side of a manual duplex job has been printed and the product is waiting for you to insert the output stack to complete the second side.</p>	<ol style="list-style-type: none"> <li>1. Load the output stack into Tray 1, maintaining the same orientation with printed side down.</li> <li>2. To continue printing, press the <b>OK</b> button.</li> </ol>
<p><b>MEM TEST FAILURE REPLACE DIMM &lt;X&gt;</b></p>	<p>The product has detected an error with the DIMM.</p>	<p>Replace the DIMM.</p>

**Table 3-7 Control-panel messages (continued)**

Control panel message	Description	Recommended action
<b>No job to cancel</b>	The stop button (⊗) was pressed, but there is no active job or buffered data to cancel.  The message is displayed for about 2 seconds before the product returns to the ready state.	No action is necessary.
<b>Non-HP supply installed</b>	You have installed a print cartridge that Hewlett-Packard did not make.	If you believe you purchased a genuine HP supply, go to <a href="http://www.hp.com/go/anticounterfeit">www.hp.com/go/anticounterfeit</a> .
<b>OUTPUT BIN FULL</b> <b>Remove all paper from bin</b>	This message appears on the control-panel display, but the bin is not full.	<ol style="list-style-type: none"> <li>1. Make sure that the media full sensor flag is not damaged and can freely move. If the sensor flag is damaged, replace the top-cover assembly.</li> <li>2. Make sure that the connector J4 on is fully seated on the sensor and connector J1605 is fully seated on the ECU.</li> <li>3. Use the G FD tray full sensor test in the <b>MANUAL SENSOR TEST</b> menu (in the <b>DIAGNOSTICS</b> menu) to test the sensor functionality. If necessary, replace the sensor (PS1).</li> </ol>
<b>OUTPUT BIN FULL</b> <b>Remove all paper from bin</b>  alternates with <b>&lt;Current status message&gt;</b>	The output bin is full, but it is not needed for the current print job.	Empty the bin before sending a job to that bin.
<b>Paper Wrapped Around Fuser</b> <b>For help press ?</b>	Paper is wrapped around the fuser, and the product has jammed.	Remove the jam.  If the message persists after you have cleared all jams, replace the fuser.
<b>Please wait</b>	The product is going offline.	No action is necessary.
<b>Processing Upgrade &lt;component&gt;</b> <b>&lt;XXX&gt; %</b>  <b>Do not power off</b>	Firmware is being upgraded in several stages.	No action is necessary.
<b>RAM DISK DEVICE FAILURE</b>  <b>To clear press OK</b>	The specified device has failed.	Press the <b>OK</b> button to continue.
<b>RAM DISK FILE OPERATION FAILED</b>  <b>To clear press OK</b>	A command attempted an illogical operation.	Press the <b>OK</b> button to continue.
<b>RAM DISK FILE SYSTEM IS FULL</b>  <b>To clear press OK</b>	The specified file system is full and cannot be written to.	Press the <b>OK</b> button to continue.
<b>RAM DISK IS WRITE PROTECTED</b>  <b>To clear press OK</b>	The device cannot be written to.	Press the <b>OK</b> button to continue.
<b>READING &lt;DIRECTORY&gt; XXXX files</b> <b>found XXXX supported</b>	The product is reading the files in the USB folder.	No action is necessary.

**Table 3-7 Control-panel messages (continued)**

Control panel message	Description	Recommended action
<b>Request accepted please wait</b>	The request to print an internal page is waiting to print.	Wait for the current job to finish printing.
<b>Restoring factory settings</b>	Factory settings are being restored.	No action is necessary.
<b>Restoring...</b>	The specific settings are being restored.	No action is necessary.
<b>RFU LOAD ERROR</b>	An error occurred during a firmware upgrade.	Resend the firmware upgrade.
<b>SEND RFU UPGRADE ON USB DEV PORT</b>		
<b>ROM DISK DEVICE FAILURE</b>	The specified device has failed.	Press the <b>OK</b> button to continue.
<b>To clear press OK</b>		
<b>ROM DISK FILE OPERATION FAILED</b>	A command attempted an illogical operation.	Press the <b>OK</b> button to continue.
<b>To clear press OK</b>		
<b>ROM DISK FILE SYSTEM IS FULL</b>	The specified file system is full and cannot be written to.	Press the <b>OK</b> button to continue.
<b>To clear press OK</b>		
<b>ROM DISK IS WRITE PROTECTED</b>	The device cannot be written to.	Press the <b>OK</b> button to continue.
<b>To clear press OK</b>		
<b>SANITIZING DISK &lt;X&gt;% COMPLETE</b>	A hard disk is being sanitized.	No action is necessary.
<b>Do not power off</b>		
alternates with		
<b>SANITIZING DISK &lt;X&gt;% COMPLETE</b>		
<b>For help press ?</b>		
<b>SIZE MISMATCH IN TRAY X</b>	The tray indicated is loaded with a different size of paper than the size configured for the tray.	Load the tray with the size configured for the tray.
<b>For help press ?</b>		
alternates with		
<b>&lt;Current status message&gt;</b>		
		Make sure that the guides are positioned correctly in the specified tray. Printing can continue from other trays.
		<ol style="list-style-type: none"> <li>1. Make sure that connectors J513, J507, and J501 are fully seated on the high-voltage power supply.</li> <li>2. Make sure that connector J601 is fully seated on the ECU.</li> <li>3. If the error persists, replace the high-voltage power supply.</li> <li>4. If the error persists, replace the ECU.</li> </ol>
<b>Sleep mode on</b>	The product is in Sleep mode.	No action is necessary.
<b>SUPPLY MEMORY WARNING</b>	The product cannot read the memory in the print cartridge.	If you believe you purchased a genuine HP supply, go to <a href="http://www.hp.com/go/anticounterfeit">www.hp.com/go/anticounterfeit</a> .
<b>Economode disabled</b>		

**Table 3-7 Control-panel messages (continued)**

Control panel message	Description	Recommended action
<p><b>Too many trays installed</b></p> <p><b>Turn power off and uninstall a tray</b></p>	<p>You have installed more optional trays than the product supports.</p> <p>The product can accept up to two optional 500-sheet trays.</p>	<p>Remove one of the optional trays.</p>
<p><b>Too many USB accessories</b></p> <p><b>For help press ?</b></p>	<p>The does not support this many USB storage accessories.</p>	<p>Remove the extra USB storage accessories until this message goes away. Then, remove and reinsert the new USB storage accessory.</p>
<p><b>Too many USB hubs</b></p> <p><b>Remove latest USB hub</b></p>	<p>The product has detected that a USB hub is connected to another USB hub.</p>	<p>Remove the extra USB hub. The product does not support USB hubs connected to other USB hubs.</p>
<p><b>TRAY &lt;X&gt; [TYPE] [SIZE]</b></p> <p><b>To change size or type press OK</b></p> <p>alternates with</p> <p><b>TRAY &lt;X&gt; [TYPE] [SIZE]</b></p> <p><b>To accept settings press ↵</b></p>	<p>This message states the current type and size configuration of the paper tray, and allows you to change the configuration.</p>	<p>To change the paper size or type press the <b>OK</b> button while the message is present. To clear the message, press the back arrow ↵ while the message is present.</p> <ul style="list-style-type: none"> <li>• Select the <b>ANY SIZE</b> and <b>ANY TYPE</b> settings if the tray is used frequently for different sizes or types.</li> <li>• Set size and type to a specific setting if printing with only one type of paper.</li> </ul>
<p><b>TRAY &lt;X&gt; OPEN</b></p> <p><b>For help press ?</b></p> <p>alternates with</p> <p><b>&lt;Current status message&gt;</b></p>	<p>The tray cannot feed paper to the product because tray [X] is open and must be closed for printing to continue.</p>	<p>Check the trays and close any that are open.</p>
<p><b>Unable to add more files to print</b></p> <p><b>Wait for a job to finish printing</b></p>	<p>The print queue has the maximum number of jobs.</p>	<p>Wait for a job to finish before adding another job to the print queue.</p>
<p><b>UNABLE TO READ ENTIRE DIRECTORY</b></p> <p><b>To continue press OK</b></p>	<p>The list of files on the USB accessory is longer than the product can display.</p>	<ol style="list-style-type: none"> <li>1. To print a file from the partial list, press the <b>OK</b> button and then select a file from the list.</li> <li>2. To prevent this problem, remove files from the USB accessory.</li> </ol>
<p><b>UNABLE TO STORE JOB</b></p> <p>alternates with</p> <p><b>&lt;Current status message&gt;</b></p>	<p>The print job named cannot be stored because of a memory, disk, or configuration problem.</p>	<p>Correct the error and then try again to store the job.</p>
<p><b>UNSUPPORTED SUPPLY IN USE</b></p>	<p>The print cartridge is for a different HP product.</p>	<p>If print quality is no longer acceptable, replace the print cartridge.</p>
<p><b>UNSUPPORTED SUPPLY INSTALLED</b></p>	<p>The print cartridge is for a different HP product.</p>	<p>If print quality is no longer acceptable, replace the print cartridge.</p>

**Table 3-7 Control-panel messages (continued)**

Control panel message	Description	Recommended action
<p><b>USB ACCESSORY NEEDS TOO MUCH POWER</b></p> <p>Remove USB accessory and then turn off then on</p> <p>alternates with</p> <p><b>USB ACCESSORY NEEDS TOO MUCH POWER</b></p> <p>For help press ?</p>	<p>The USB accessory is drawing too much electrical current. Printing cannot continue.</p>	<p>Remove the USB accessory, and then restart the product.</p> <p>Use a USB accessory that uses less power or that contains its own power supply.</p>
<p><b>USB accessory not recognized</b></p> <p>For help press ?</p> <p>alternates with</p> <p><b>USB accessory not recognized</b></p> <p>To clear press OK</p>	<p>The product does not support plug and Play operation for the type of USB accessory in the host USB port, or the accessory is not supported</p>	<p>With the USB accessory connected, turn the product off and then on. If the message reappears, remove the USB accessory.</p> <p><b>NOTE:</b> Secure USB drives are not supported for walk-up print with this product. Secure USB drives usually start specialized programs that require a password, and these programs can not open on this product.</p>
<p><b>USB printing unavailable</b></p> <p>For help press ?</p>	<p>The administrator has disabled printing from USB accessories.</p>	<p>Print the job from a computer that is connected to the product.</p>
<p><b>USB storage accessory removed</b></p> <p>Clearing any unassociated data</p>	<p>You have removed the USB accessory from the product. The product cancels any jobs from the accessory that are in the print queue.</p>	<p>To print the remaining jobs, reinsert the USB accessory and select the jobs again.</p>
<p><b>USB STORAGE DEVICE FAILURE</b></p> <p>To clear press OK</p>	<p>The specified device has failed.</p>	<p>Press the <b>OK</b> button to continue.</p>
<p><b>USB STORAGE FILE OPERATION FAILED</b></p> <p>To clear press OK</p>	<p>A command attempted an illogical operation.</p>	<p>Press the <b>OK</b> button to continue.</p>
<p><b>USE TRAY &lt;X&gt; [TYPE] [SIZE]</b></p> <p>To change press ▲/▼.</p> <p>To use press OK</p>	<p>The product did not detect the type and size of paper requested. The message shows the most likely type and size available and the tray in which they are available.</p>	<p>Press the <b>OK</b> button to accept the values in the message, or press the up or down arrow ▲/▼ buttons to scroll through the available choices.</p>
<p><b>USED SUPPLY IN USE</b></p> <p>Economode disabled</p>	<p>The print cartridge has been previously used.</p>	<p>If you believe you purchased a genuine HP supply, go to <a href="http://www.hp.com/go/anticounterfeit">www.hp.com/go/anticounterfeit</a>.</p>
<p><b>USED SUPPLY INSTALLED</b></p>	<p>The print cartridge has been previously used.</p>	<p>Press the <b>OK</b> button to use this cartridge, or install a new cartridge.</p> <p>If you believe you purchased a genuine HP supply, go to <a href="http://www.hp.com/go/anticounterfeit">www.hp.com/go/anticounterfeit</a>.</p>




**Table 3-7 Control-panel messages (continued)**


Control panel message	Description	Recommended action
<b>Wait for printer to reinitialize</b>	This message can appear for a variety of reasons: <ul style="list-style-type: none"><li>• The RAM DISK settings changed before the product restarted.</li><li>• The product is restarting after changing external product modes.</li><li>• You have exited the <b>DIAGNOSTICS</b> menu.</li><li>• A new formatter has been installed with an old product, or a new product has been installed with an old formatter.</li></ul>	No action is necessary.
<b>WARMING UP</b> alternates with <Current status message>	The product is coming out of sleep mode. Printing continues when it is done.	No action is necessary.

## Event-log messages

### Print an event log

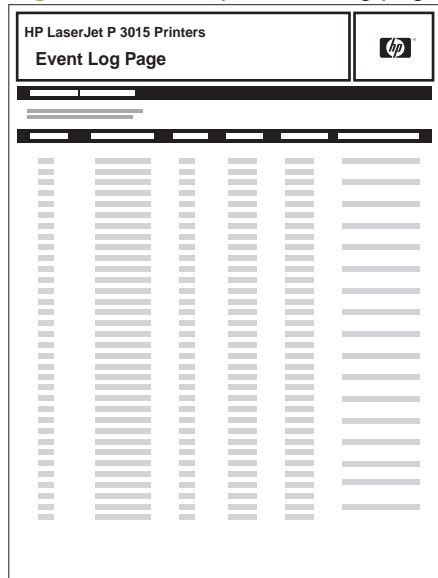
1. Press the **Menu** button .
2. Press the down arrow ▼ button or the up arrow ▲ button to navigate to the **DIAGNOSTICS** menu, and then press the **OK** button.
3. Press the down arrow ▼ button or the up arrow ▲ button to navigate to the **PRINT EVENT LOG** menu, and then press the **OK** button to print.

### Show an event log


1. Press the **Menu** button .
2. Press the down arrow ▼ button or the up arrow ▲ button to navigate to the **DIAGNOSTICS** menu, and then press the **OK** button.
3. Press the down arrow ▼ button or the up arrow ▲ button to navigate to the **SHOW EVENT LOG** sub menu, and then press the **OK** button to print.

## Sample event-log page


**Figure 3-32** Sample event-log page



## Clear an event log


1. Press the **Menu** button .
2. Press the down arrow ▼ button or the up arrow ▲ button to navigate to the **SERVICE** menu, and then press the **OK** button.
3. Type the product service PIN, and then press the **OK** button.  

---

 **NOTE:** For the HP LaserJet P3015 base model, use the arrow buttons to type the product service PIN.

---
4. Press the down arrow ▼ button or the up arrow ▲ button to navigate to the **CLEAR EVENT LOG** sub menu, and then press the **OK** button.

## Event-log messages

 **NOTE:** Unless otherwise noted, the event log messages in the following table do not have a corresponding control-panel message.

**Table 3-8** Event log only messages

Event log message	Description	Comments
10.10.0Y	Memory error on supply	The memory tag is missing or defective. See <b>10.XX.YY SUPPLY MEMORY ERROR</b> in <a href="#">Interpret control-panel messages on page 197</a> .
10.30.00	Non-HP supply in use	Transition from all HP to at least one non-HP consumable.
10.31.00	Non-HP supply in use	Transition to at least one cloned print cartridge.
10.32.00	Unauthorized supply in use	Transition to at least one unauthorized cloned print cartridge.
10.40.00	Genuine HP Supplies Installed	Transition from at least one non-HP to all genuine HP supplies.
10.41.00	Unsupported supply in use	Transition at least one unsupported HP consumable in use.
13.05.00	Jam in the fuser area	<ul style="list-style-type: none"> <li>For jam location information, see <a href="#">Jam locations on page 220</a>.</li> <li>If the error persists, a sensor might be damaged. See <a href="#">Paper-path test (and automatic sensors test) on page 136</a> or <a href="#">Sensor test (interactive) on page 137</a>.</li> </ul>
13.31.00	Jam in the fuser area	<ul style="list-style-type: none"> <li>For jam location information, see <a href="#">Jam locations on page 220</a>.</li> <li>If the error persists, a sensor might be damaged. See <a href="#">Paper-path test (and automatic sensors test) on page 136</a> or <a href="#">Sensor test (interactive) on page 137</a>.</li> </ul>
13.20.00	Jam inside the rear door	<ul style="list-style-type: none"> <li>For jam location information, see <a href="#">Jam locations on page 220</a>.</li> <li>If the error persists, a sensor might be damaged. See <a href="#">Paper-path test (and automatic sensors test) on page 136</a> or <a href="#">Sensor test (interactive) on page 137</a>.</li> </ul>
13.21.00	Jam inside the rear door	<ul style="list-style-type: none"> <li>For jam location information, see <a href="#">Jam locations on page 220</a>.</li> <li>If the error persists, a sensor might be damaged. See <a href="#">Paper-path test (and automatic sensors test) on page 136</a> or <a href="#">Sensor test (interactive) on page 137</a>.</li> </ul>

**Table 3-8 Event log only messages (continued)**

Event log message	Description	Comments
13.02.00	Jam inside the top cover	<ul style="list-style-type: none"> <li>For jam location information, see <a href="#">Jam locations on page 220</a>.</li> <li>If the error persists, a sensor might be damaged. See <a href="#">Paper-path test (and automatic sensors test) on page 136</a> or <a href="#">Sensor test (interactive) on page 137</a>.</li> </ul>
13.98.00	Paper jam open input trays	<ul style="list-style-type: none"> <li>For jam location information, see <a href="#">Jam locations on page 220</a>.</li> <li>If the error persists, a sensor might be damaged. See <a href="#">Paper-path test (and automatic sensors test) on page 136</a> or <a href="#">Sensor test (interactive) on page 137</a>.</li> </ul>
14.X	Feed roller error	
54.01	The humidity-environment sensor (TH3) is abnormal.	<ol style="list-style-type: none"> <li>Make sure that the product is in an environment that meets the specifications in <a href="#">Environmental specifications on page 309</a>.</li> <li>Make sure that connector J1803 is fully seated on the ECU.</li> <li>If the error persists, replace the environment sensor. See <a href="#">Main fan, fan duct, and environmental sensor on page 98</a>.</li> </ol>
55 901C	DCC restored	DCC NVRAM was restored from the formatter.
68 8X04	The permanent storage date does not match the engine.	
68 8X05	The permanent storage date does match the engine.	
73.00.00	Printer error	Power cycle the product.
8x7345	Disk clean successful	X denotes the slot number (0 is internal).
8x7346	Disk clean failed	A hard disk or compact flash disk cleaning failed. Usually caused by a hardware failure of the disk. X denotes the slot number.
8x7347	Some of the sanitized disk did not correctly verify.	
88.00.XX	FailCode from engine self-test execution.	

# Clear jams

## Common causes of jams

Many jams are caused by using paper that does not meet HP specifications. For complete paper specifications for all HP LaserJet products, see the *HP LaserJet Printer Family Print Media Guide*. This guide is available at [www.hp.com/support/ljpaperguide](http://www.hp.com/support/ljpaperguide).

### The product is jammed.

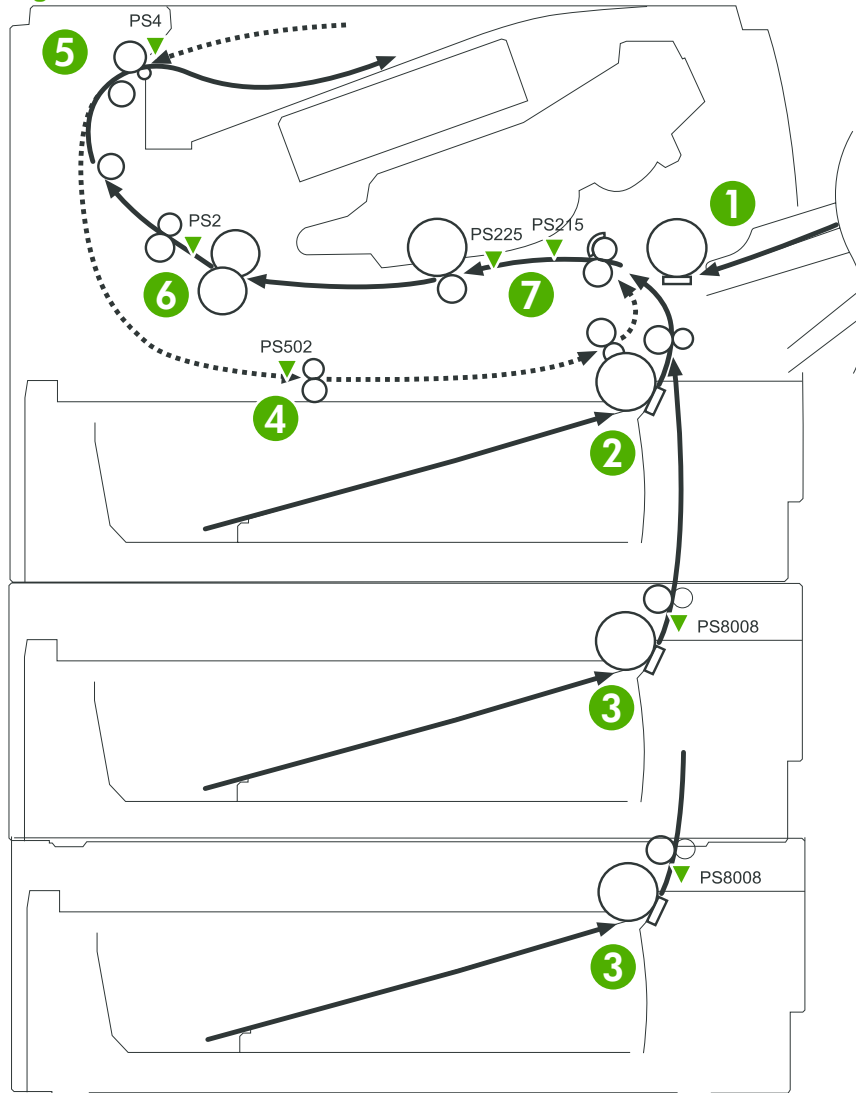
Cause	Solution
The paper does not meet specifications.	Use only paper that meets HP specifications. See the product user guide.
A component is installed incorrectly.	Verify that all components are correctly installed.
You are using paper that has already passed through a product or copier.	Do not use paper that has been previously printed on or copied.
A tray is loaded incorrectly.	Remove any excess paper from the tray. Make sure that the stack is below the maximum stack height mark in the tray. See the product user guide.
The paper is skewed.	The tray guides are not adjusted correctly. Adjust them so they hold the stack firmly in place without bending it.
The paper is binding or sticking together.	Remove the paper, flex it, rotate it 180°, or flip it over. Reload the paper into the tray.  <b>NOTE:</b> Do not fan paper. Fanning can create static electricity, which can cause paper to stick together.
The paper is removed before it settles into the output bin.	Reset the product. Wait until the page completely settles in the output bin before removing it.
During two-sided printing, you removed the paper before the second side of the document was printed.	Reset the product and print the document again. Wait until the page completely settles in the output bin before removing it.
The paper is in poor condition.	Replace the paper.
The internal rollers from the tray are not picking up the paper.	Remove the top sheet of paper. If the paper is too heavy, it might not be picked from the tray.
The paper has rough or jagged edges.	Replace the paper.
The paper is perforated or embossed.	Perforated or embossed paper does not separate easily. Feed single sheets from Tray 1.
Product supply items have reached the end of their useful life.	Check the product control panel for messages alerting you of supplies status, or print a supplies status page (see the product user guide) to verify the remaining life of the supplies.
Paper was not stored correctly.	Replace the paper in the trays. Paper should be stored in the original packaging in a controlled environment.

## Jam locations

Use this illustration to identify locations of jams. In addition, instructions appear on the control panel to direct you to the location of jammed paper and how to clear it.

**NOTE:** Internal areas of the product that might need to be opened to clear jams have green handles or green labels.

**Figure 3-33** Jam locations




1	<p>Tray 1 (multipurpose tray) area</p> <p>13.JJ.NT JAM IN TRAY 1</p> <p>13.JJ.NT JAM IN TRAY &lt;X&gt;</p> <p>13.JJ.NT PAPER JAM OPEN INPUT TRAYS</p> <p>See <a href="#">Clear jams from Tray 1 on page 222</a>.</p>
---	--

2	<p>Tray 2 area</p> <p>13.JJ.NT JAM IN TRAY 2</p> <p>13.JJ.NT JAM IN TRAY &lt;X&gt;</p> <p>13.JJ.NT PAPER JAM OPEN INPUT TRAYS</p> <p>See <a href="#">Clear jams from Tray 2 or an optional 500-sheet tray on page 223.</a></p>
3	<p>Optional 500-sheet input tray (Tray 3 or Tray 4) area</p> <p>13.JJ.NT JAM IN TRAY &lt;X&gt;</p> <p>13.JJ.NT PAPER JAM OPEN INPUT TRAYS</p> <p>See <a href="#">Clear jams from Tray 2 or an optional 500-sheet tray on page 223.</a></p>
4	<p>Duplex feed area</p> <p>13.JJ.NT JAM INSIDE DUPLEXER</p> <p>See <a href="#">Clear jams from the duplexer on page 226.</a></p>
5	<p>Output-bin area</p> <p>13.JJ.NT JAM INSIDE REAR DOOR</p> <p>See <a href="#">Clear jams from the output areas on page 231.</a></p>
6	<p>Fuser area</p> <p>13.JJ.NT JAM IN FUSER</p> <p>See <a href="#">Clear jams from the output areas on page 231.</a></p>
7	<p>Registration and transfer area</p> <p>13.JJ.NT JAM INSIDE TOP COVER</p> <p>See <a href="#">Clear jams from inside the product on page 234.</a></p>

## Clear jams from the input trays

### Clear jams from Tray 1

 **TIP:** To see an animation of this procedure go to this Web site: [www.hp.com/go/ljp3010-tray1-jams](http://www.hp.com/go/ljp3010-tray1-jams).

1. Slowly pull the jammed paper or other print media out of the product. If part of the paper has already been pulled into the product, see [Registration and transfer area on page 234](#).




2. Press the **OK** button to clear the message.

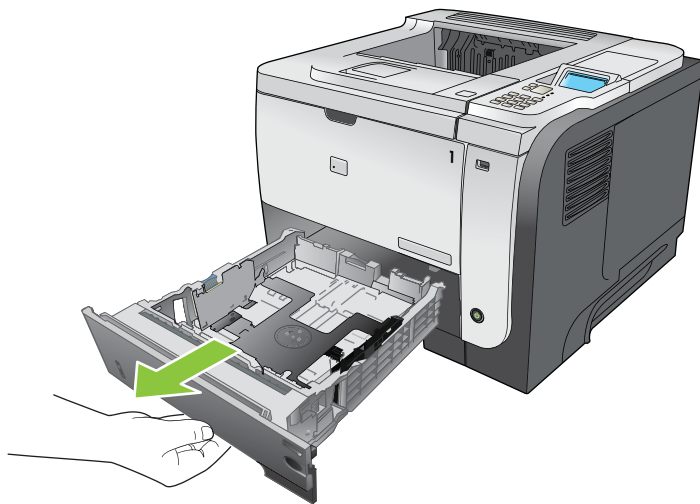




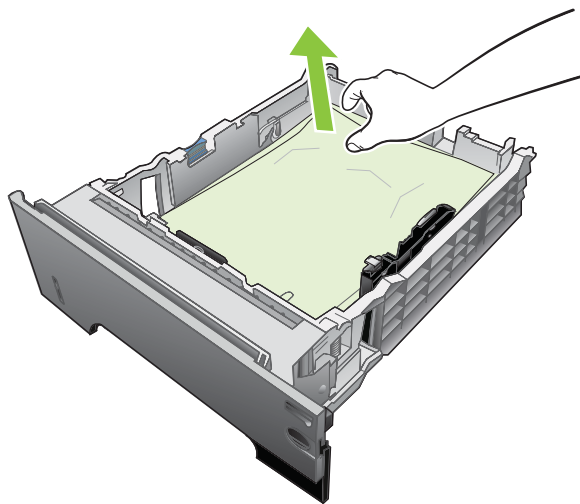
## Clear jams from Tray 2 or an optional 500-sheet tray

 **TIP:** To see an animation of this procedure go to this Web site: [www.hp.com/go/ljp3010-tray2-jams](http://www.hp.com/go/ljp3010-tray2-jams).

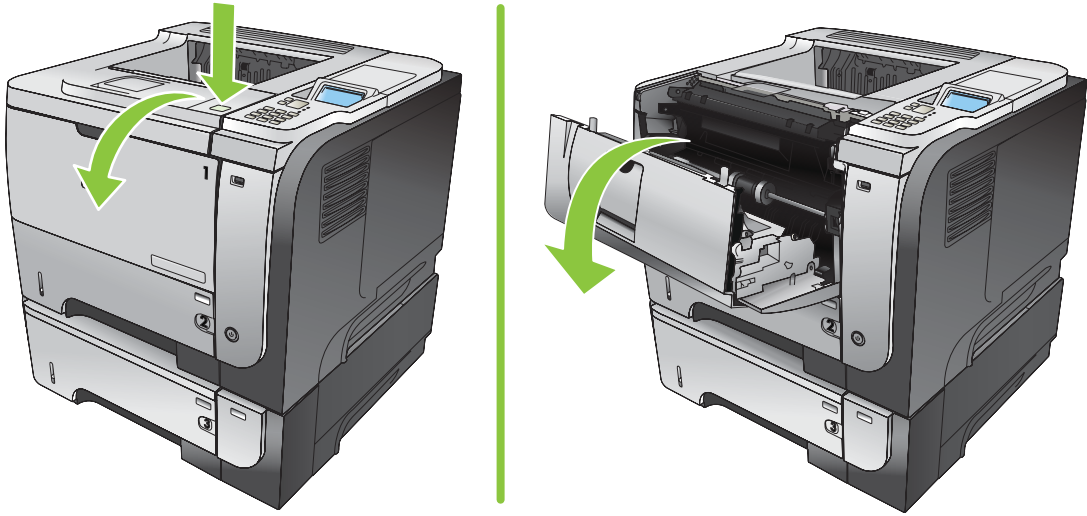
1. Remove the tray from the product.



2. Remove any damaged paper from the tray, and then reinsert the tray.



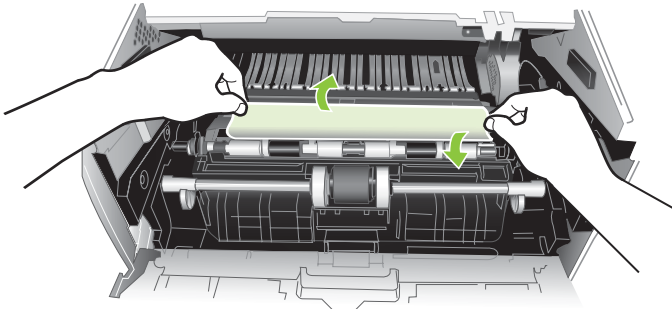
3. Press the cartridge-door-release button, and open the cartridge door.



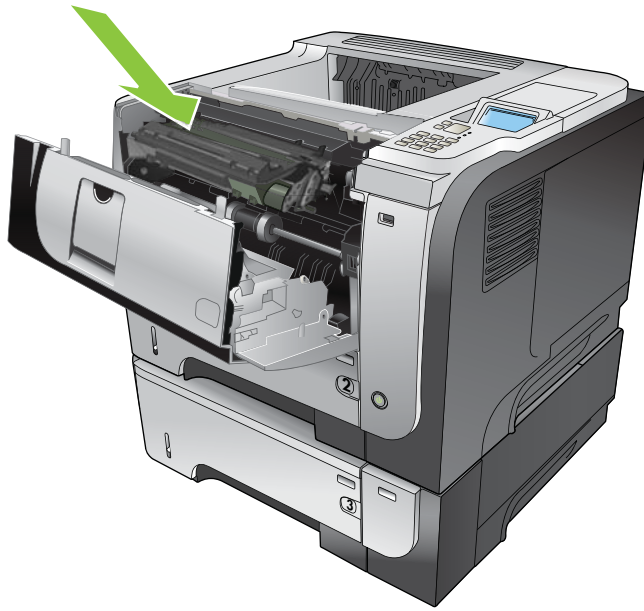
4. Remove the print cartridge.



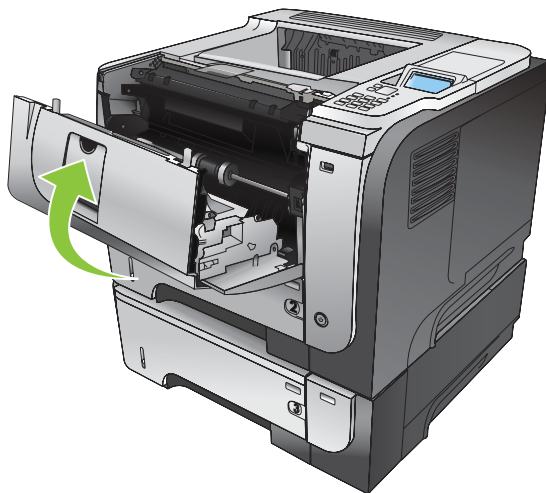
5. Remove any jammed paper.




6. Reinsert the print cartridge.



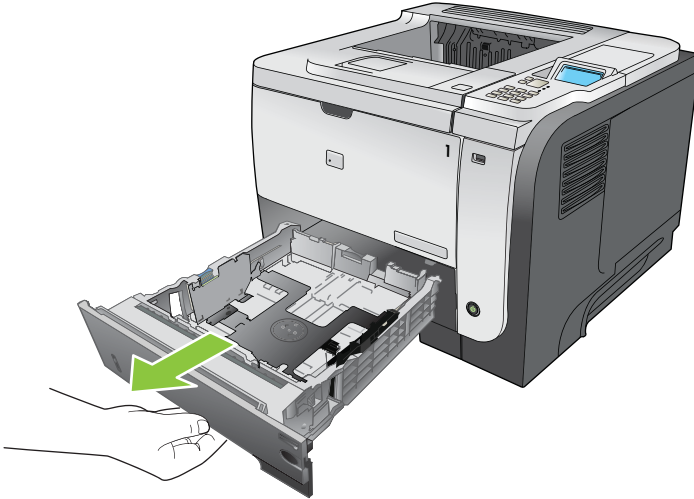
7. Close the cartridge door.



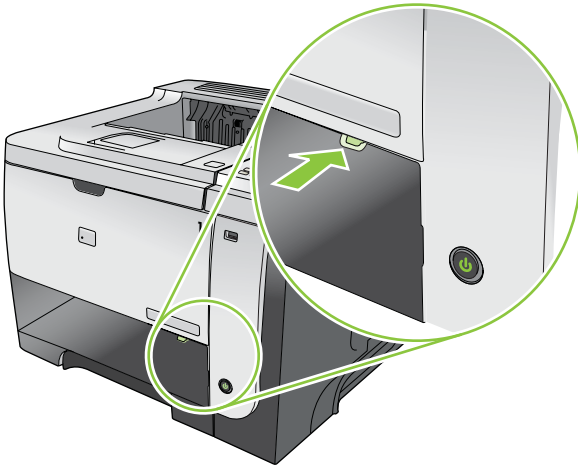
## Clear jams from the duplexer

 **TIP:** To see an animation of this procedure go to this Web site: [www.hp.com/go/ljp3010-jams-duplexer](http://www.hp.com/go/ljp3010-jams-duplexer).

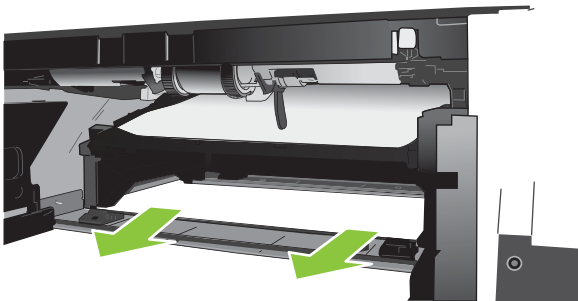
1. Remove Tray 2 completely from the product.



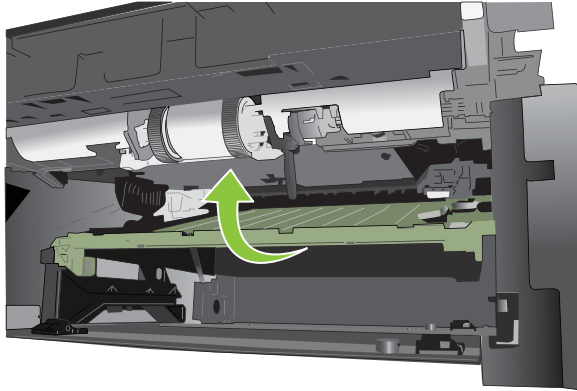
2. Push the green button to release the duplex pan.



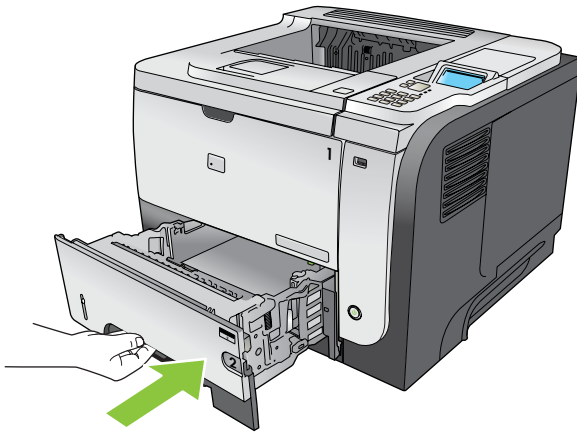
3. Remove any jammed paper.




4. Close the duplex pan.

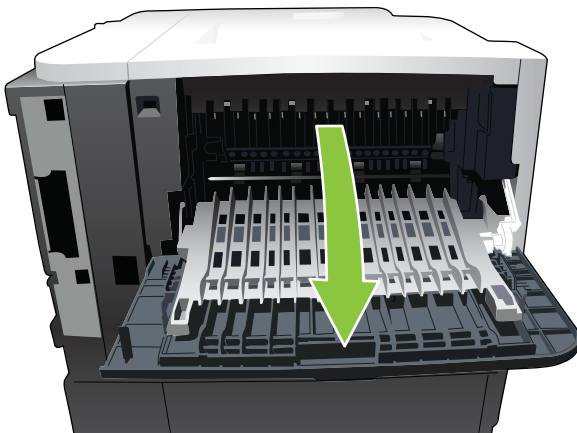


5. Reinsert Tray 2.

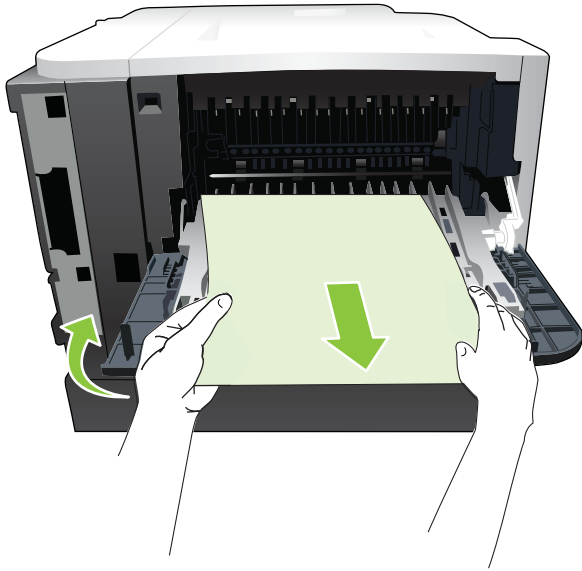


6. Open the rear door, and push down so it is fully opened to a 90° angle.

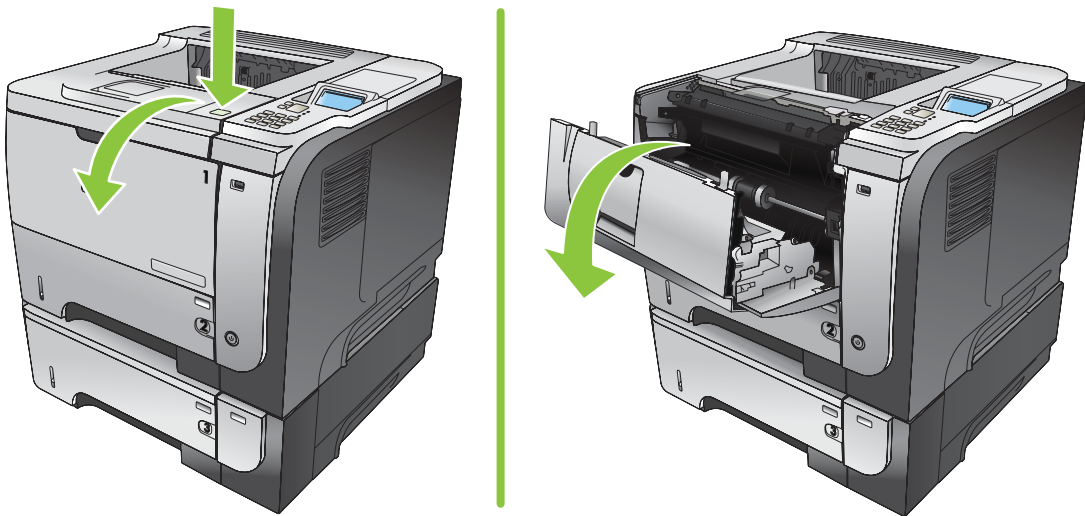
 **NOTE:** The rear door has two positions. It opens to a 45° angle for the rear output bin and to a 90° angle for clearing jams.



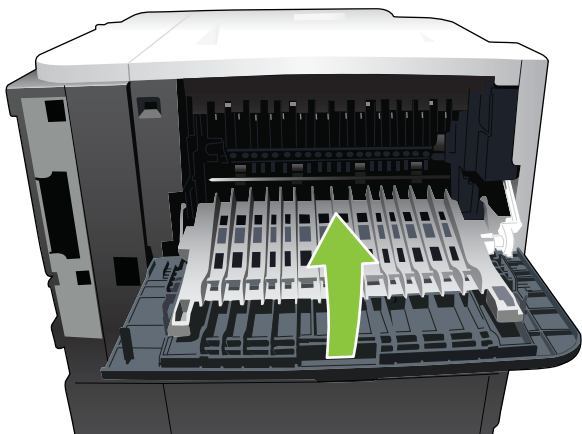
7. Remove any jammed paper.



8. Press the cartridge-door-release button, and open the cartridge door.



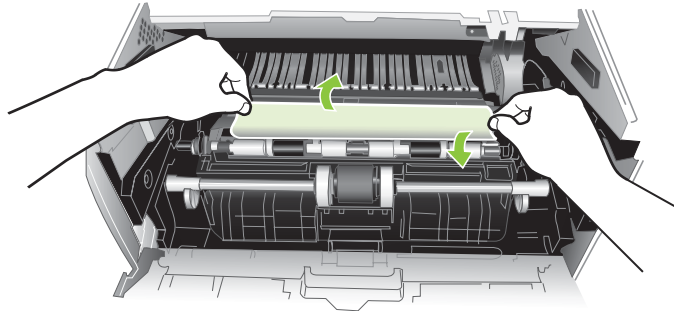
9. Close the rear door.



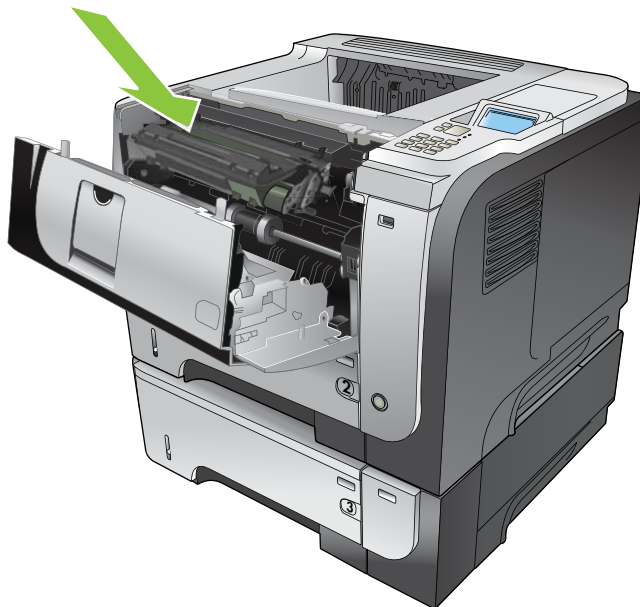
10. Remove the print cartridge.



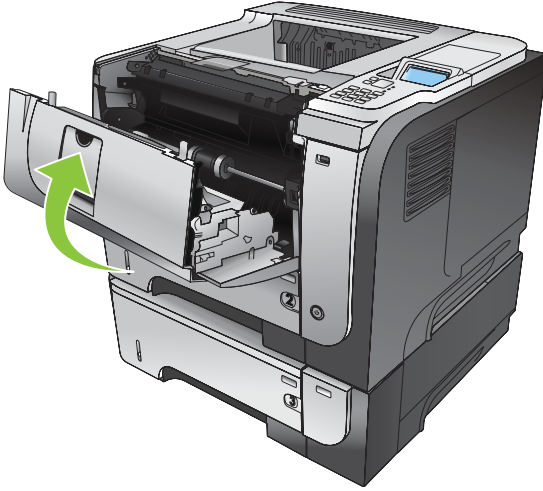
11. Remove any jammed paper.



12. Reinsert the print cartridge.




13. Close the cartridge door.






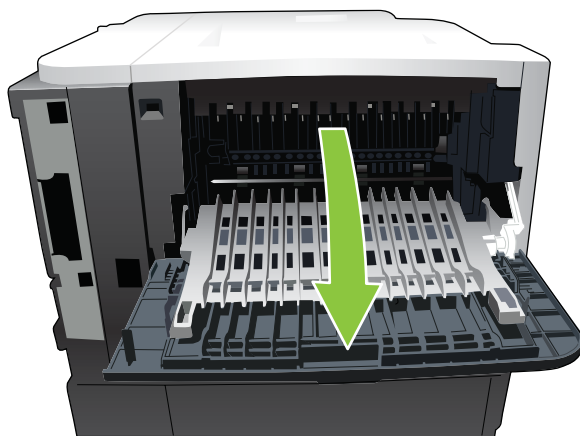
## Clear jams from the output areas

### Clear jams from the rear door and the fuser area

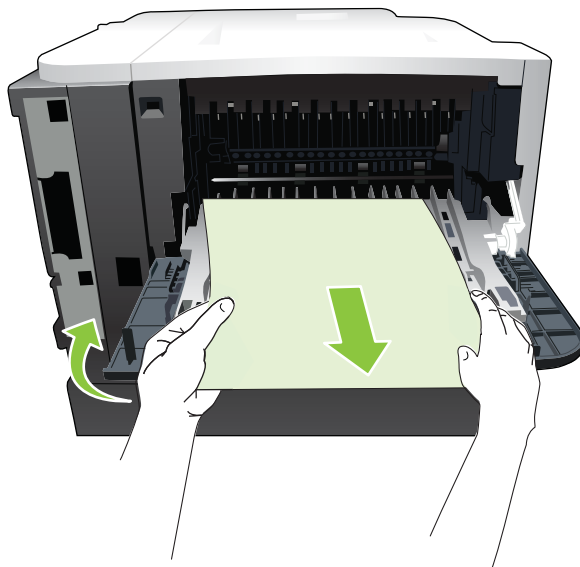
 **TIP:** To see an animation of this procedure go to this Web site: [www.hp.com/go/ljp3010-jams-rear](http://www.hp.com/go/ljp3010-jams-rear).

1. Open the rear door, and push down so it is fully opened to a 90° angle.

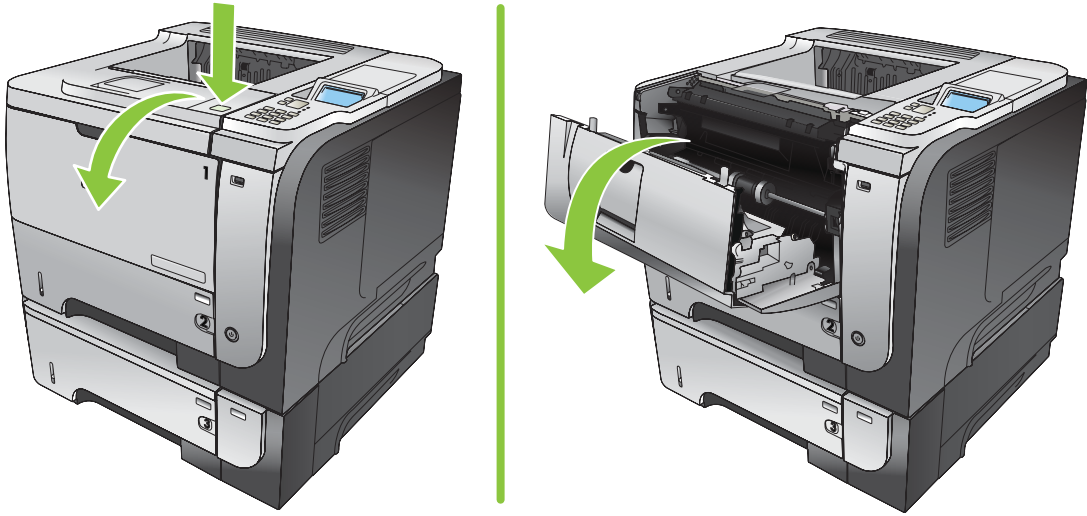
 **NOTE:** The rear door has two positions. It opens to a 45° angle for the rear output bin and to a 90° angle for clearing jams.



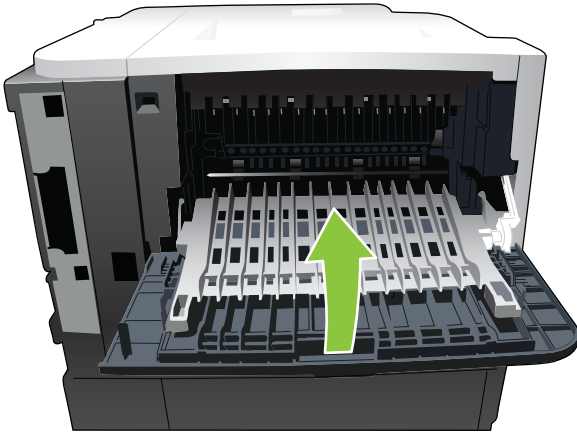
2. Remove any jammed paper.



3. Press the cartridge-door-release button, and open the cartridge door.



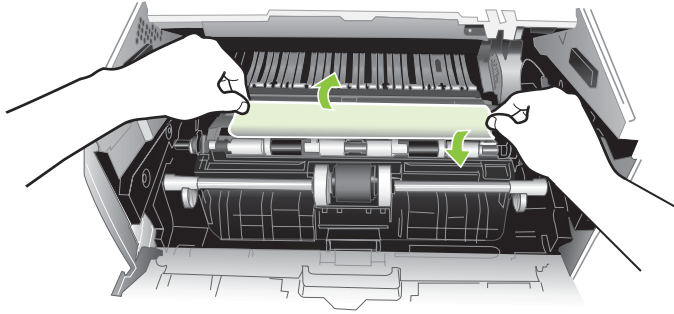
4. Close the rear door.



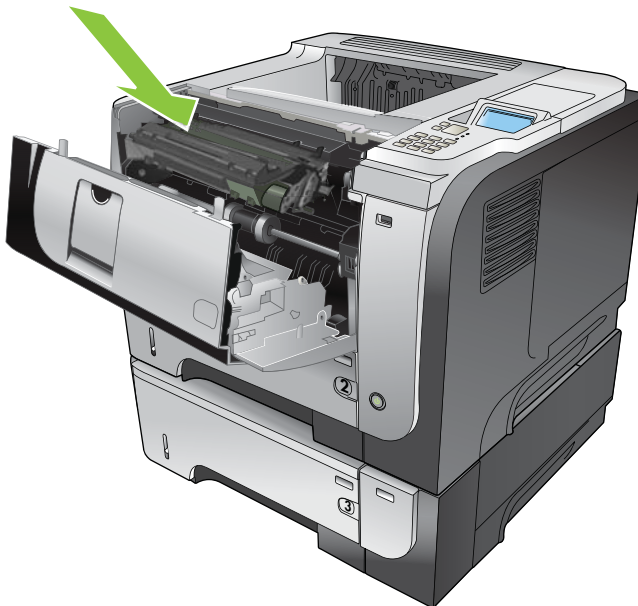
5. Remove the print cartridge.



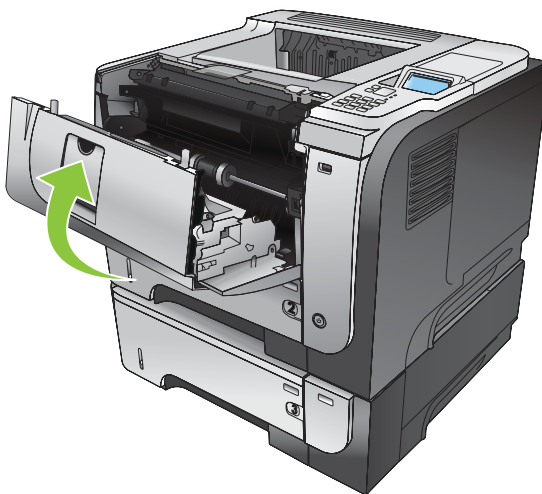
6. Remove any jammed paper.



7. Reinsert the print cartridge.




8. Close the cartridge door.

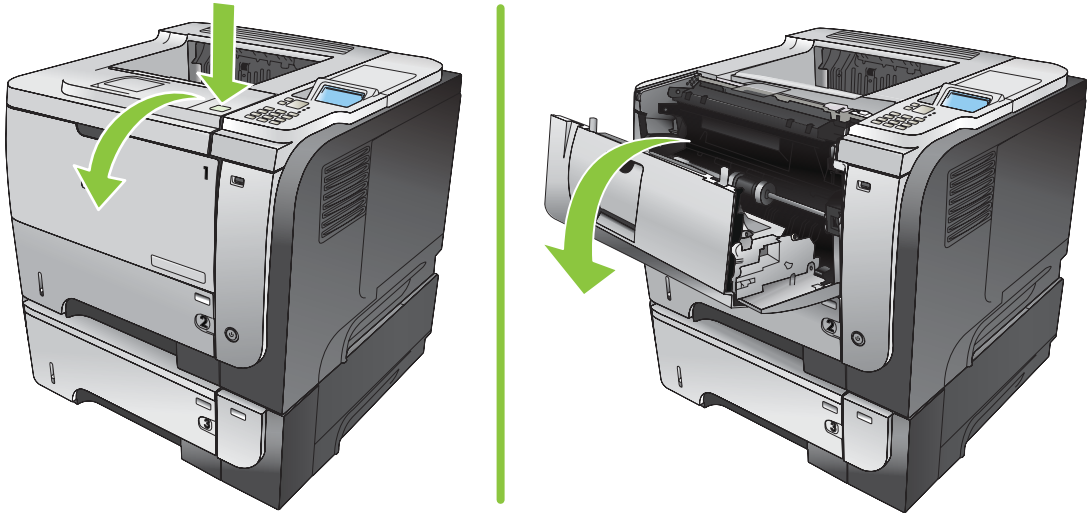


## Clear jams from inside the product

### Registration and transfer area

 **TIP:** To see an animation of this procedure go to this Web site: [www.hp.com/go/ljp3010-jams-top](http://www.hp.com/go/ljp3010-jams-top).

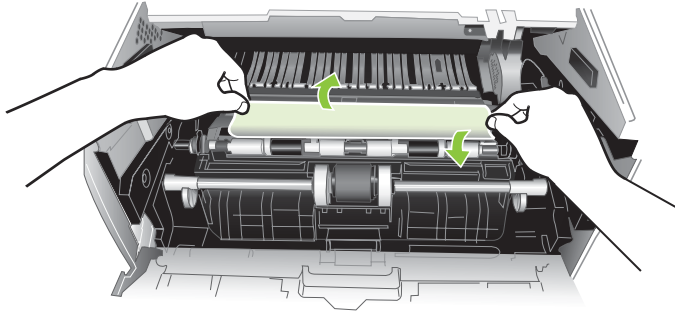
1. Press the cartridge-door-release button, and open the cartridge door.



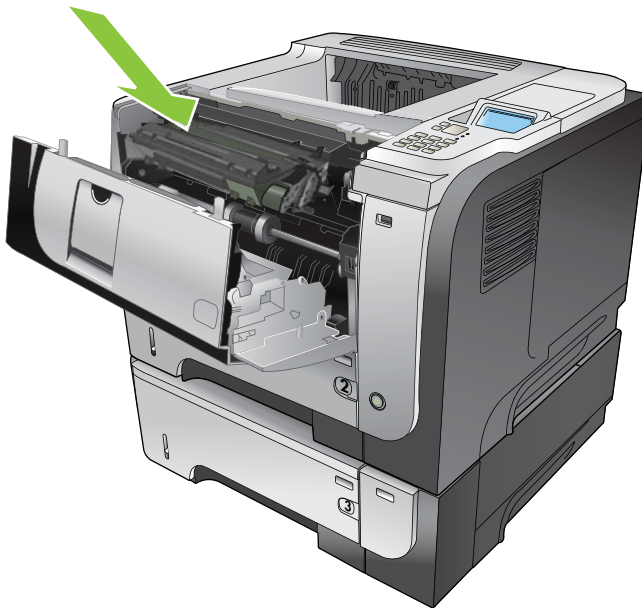
2. Remove the print cartridge.



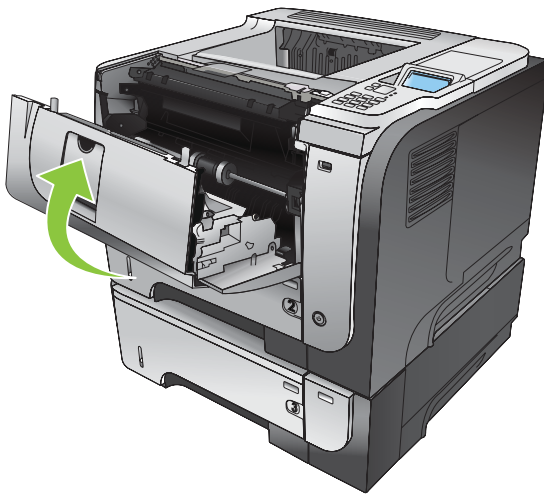
3. Remove any jammed paper.



4. Reinsert the print cartridge.



5. Close the cartridge door.



## Jam causes and solutions

### Jams in the top cover and product cassette

Cause	Solution
The cassette separation pad is worn or deformed.	Replace the cassette separation pad. See <a href="#">Tray 2, Tray 3, or Tray 4 separation pad on page 90</a> .
The cassette pickup roller is worn or deformed.	Replace the cassette pickup roller. See <a href="#">Tray 2, Tray 3, or Tray 4 pickup roller on page 88</a> .
Poor contact of the cassette pickup solenoid drive connector.	Reconnect the connector (J1601) on the ECU.
The cassette pickup solenoid is defective.	Replace the cassette pickup solenoid. See <a href="#">Cassette pickup (Tray 2) solenoid or Tray 1 (multipurpose tray) pickup solenoid on page 115</a> .
The registration roller is dirty, worn or deformed.	Clean the registration roller if it is dirty.
The registration assembly is defective.	<ul style="list-style-type: none"><li>• Check the spring of the registration shutter and place it in correct position.</li><li>• Replace the registration assembly if the registration shutter is damaged or worn. See <a href="#">Registration assembly on page 102</a>.</li></ul>
The TOP sensor (PS215) lever is defective.	<ul style="list-style-type: none"><li>• Check the sensor lever and place it in correct position to move smoothly and freely.</li><li>• Replace the sensor if the sensor lever is damaged.</li></ul>
Poor contact of the TOP sensor (PS215) connector.	Reconnect the connector (J507) on the high-voltage power supply.
The TOP sensor (PS215) is defective.	Replace the sensor.

### Jams in the input tray area (optional 500-sheet input tray)

Cause	Solution
The 500-sheet tray separation pad is worn or deformed.	Replace the 500-sheet tray separation pad. See <a href="#">Tray 2, Tray 3, or Tray 4 separation pad on page 90</a> .
The 500-sheet tray pickup roller is worn or deformed.	Replace the 500-sheet tray pickup roller. See <a href="#">Tray 2, Tray 3, or Tray 4 pickup roller on page 88</a> .
Poor contact of the 500-sheet tray pickup solenoid drive connector.	Reconnect the connector (J407) on the 500-sheet tray connector PCA.
The 500-sheet tray pickup solenoid is defective.	Replace the 500-sheet tray pickup solenoid.

### Jams in input tray area (Tray 1; multipurpose tray)

Cause	Solution
The Tray 1 separation pad is worn or deformed.	Replace Tray 1. See <a href="#">Tray 1 (multipurpose tray) cover on page 69</a> .
The Tray 1 pickup roller is worn or deformed.	Replace the Tray 1 pickup roller. See <a href="#">Tray 1 (multipurpose tray) pickup roller on page 86</a> .

### Jams in input tray area (Tray 1; multipurpose tray)

Cause	Solution
Poor contact of the Tray 1 pickup solenoid drive connector.	Reconnect the connector (J1602) on the ECU.
The Tray 1 pickup solenoid is defective.	Replace the Tray 1 pickup solenoid. See <a href="#">Cassette pickup (Tray 2) solenoid</a> or <a href="#">Tray 1 (multipurpose tray) pickup solenoid</a> on page 115.

### Jams in the input tray areas

Cause	Solution
Multiple-feed of media.	Replace the pickup roller or separation pad if worn or deformed. See <a href="#">Tray 1 (multipurpose tray) pickup roller</a> on page 86, or <a href="#">Tray 2, Tray 3, or Tray 4 pickup roller</a> on page 88, or <a href="#">Tray 1 (multipurpose tray) separation pad</a> on page 87, or <a href="#">Tray 2, Tray 3, or Tray 4 separation pad</a> on page 90.
The registration roller is worn or deformed.	Replace the registration assembly if the registration roller is damaged or worn. See <a href="#">Registration assembly</a> on page 102.
The transfer roller is not installed correctly.	Reinstall the transfer roller. See <a href="#">Transfer roller</a> on page 92.
The transfer roller is worn or deformed.	Replace the transfer roller. See <a href="#">Transfer roller</a> on page 92.
Poor contact of the main motor connector.	Reconnect the connector (J1503) on the ECU.
The main motor is defective.	Replace the main motor.

### Jam in the rear door and fuser area (delivery-delay jam)

Cause	Solution
Dirt or scratches on the fuser-inlet guide.	<ul style="list-style-type: none"><li>● Clean the fuser-inlet guide if dirty or if there is a toner build up on it.</li><li>● Replace the fuser if it is scratched. See <a href="#">Fuser</a> on page 100.</li></ul>
The fuser delivery sensor (PS2) lever is defective.	<ul style="list-style-type: none"><li>● Check the sensor lever and place it in correct position to move smoothly and freely.</li><li>● Replace the fuser if the sensor lever is damaged. See <a href="#">Fuser</a> on page 100.</li></ul>
Poor contact of the fuser delivery sensor connector.	<ul style="list-style-type: none"><li>● Reconnect the connectors (J22 and J24) on the transit (inline) connector.</li><li>● Reconnect the connector (J1608) on the ECU.</li></ul>
The fuser delivery sensor (PS2) is defective.	Replace the fuser. See <a href="#">Fuser</a> on page 100.

### Jam in the rear door and fuser area (delivery-stationary jam)

Cause	Solution
Multiple-feed of media.	Replace the pickup roller or separation pad if worn or deformed. See <a href="#">Tray 1 (multipurpose tray) pickup roller on page 86</a> , or <a href="#">Tray 2, Tray 3, or Tray 4 pickup roller on page 88</a> , or <a href="#">Tray 1 (multipurpose tray) separation pad on page 87</a> , or <a href="#">Tray 2, Tray 3, or Tray 4 separation pad on page 90</a> .
Dirt or scratches on the fuser delivery upper guide or the fuser-delivery lower guide.	<ul style="list-style-type: none"><li>● Clean the fuser-delivery upper guide or fuser-delivery lower guide if dirt or if there is a toner build up on it.</li><li>● Replace the fuser if the guides are deformed or scratched. See <a href="#">Fuser on page 100</a>.</li></ul>
The fuser delivery roller is dirty, worn or deformed.	<ul style="list-style-type: none"><li>● Clean the fuser delivery roller if it is dirty.</li><li>● Replace the fuser if the fuser delivery roller is worn or deformed. See <a href="#">Fuser on page 100</a>.</li></ul>
Fuser delivery sensor (PS2) lever is defective.	Replace the fuser. See <a href="#">Fuser on page 100</a> .
The face-down tray media-full sensor lever is defective.	<ul style="list-style-type: none"><li>● Check the sensor lever and place it in correct position to move smoothly and freely.</li><li>● Replace the top cover if the sensor lever is damaged. See <a href="#">Top cover on page 84</a>.</li></ul>
The face-down delivery roller is worn or deformed.	Replace the face-down delivery roller.
The fuser film or the fuser roller is defective.	Replace the fuser. See <a href="#">Fuser on page 100</a> .

### Jams in the top cover, rear door, fuser, and duplex area (residual media jam)

Cause	Solution
Residual media in the product.	Check the media path and remove any residual media.
The TOP sensor (P215) lever is defective.	<ul style="list-style-type: none"><li>● Check the sensor lever and place it in correct position to move smoothly and freely.</li><li>● Replace the product if the sensor lever is damaged.</li></ul>
Poor contact of the TOP sensor (PS215) connector.	Reconnect the connector (J507) on the high-voltage power supply.
The TOP sensor (PS215) is defective.	Replace the sensor.
The media width sensor (PS225) lever is defective	<ul style="list-style-type: none"><li>● Check the sensor lever and place it in correct position to move smoothly and freely.</li><li>● Replace the product if the sensor lever is damaged.</li></ul>
Poor contact of the media width sensor (PS225) connector.	Reconnect the connector (J513) on the high-voltage power supply.
The media width sensor (PS225) is defective.	Replace the sensor.
The fuser delivery sensor (PS2) lever is defective	<ul style="list-style-type: none"><li>● Check the sensor lever and place it in correct position to move smoothly and freely.</li><li>● Replace the fuser if the sensor lever is damaged. See <a href="#">Fuser on page 100</a>.</li></ul>



### Jams in the top cover, rear door, fuser, and duplex area (residual media jam)

Cause	Solution
Poor contact of the fuser delivery sensor connector.	<ul style="list-style-type: none"><li>● Reconnect the connectors (J22 and J24) on the transit (inline) connector.</li><li>● Reconnect the connector (J1608) on the ECU.</li></ul>
The fuser delivery sensor (PS2) is defective.	Replace the fuser. See <a href="#">Fuser on page 100</a> .
The duplex media-feed sensor (PS502) lever is defective (duplex models).	<ul style="list-style-type: none"><li>● Check the sensor lever and place it in correct position to move smoothly and freely.</li><li>● Replace the high-voltage power supply if the sensor lever is damaged.</li></ul>
Poor contact of the duplex media-feed sensor (PS502) connector (duplex models).	Reconnect the connector (J501) on the high-voltage power supply.
The duplex media-feed sensor is defective (duplex models).	Replace the high-voltage power supply.

### Jams in the rear door and fuser area (fuser wrapping jam)

Cause	Solution
The fuser film or the pressure roller is defective.	Replace the fuser. See <a href="#">Fuser on page 100</a> .

### Jams in the rear door, fuser, and duplex areas (duplex models; duplex re-pickup jam)

Cause	Solution
The face-down delivery roller is worn or deformed.	Replace the delivery assembly.
The duplex media-feed sensor (PS502) lever is defective.	<ul style="list-style-type: none"><li>● Check the sensor lever and place it in the correct position to move smoothly and freely.</li><li>● Replace the high-voltage power supply if the sensor lever is damaged.</li></ul>
Poor contact of the duplex media-feed sensor (PS502) connector.	Reconnect the connector (J501) on the high-voltage power supply.
The duplex media-feed sensor is defective.	Replace the high-voltage power supply.

## Avoid repeated jams


- Verify that the input trays are not overfilled. The input tray capacities vary depending on the type of print media that you are using.
- Verify that the media guides are properly adjusted.
- Do not add print media into the input trays while the product is printing.
- Use only HP-recommended media types and sizes.
- Do not fan media prior to loading it in a tray. To loosen the ream, hold it firmly in both hands and twist the media by rotating your hands in the opposite direction.
- Do not let print media stack up in the output bin. The print media type and the amount of toner used affect the output bin capacity.
- Check the power connection. Make sure that the power cord is firmly connected to both the product and the power supply box. Plug the power cord into a grounded power outlet.

## Change jam recovery

This product provides a jam recovery feature that reprints jammed pages. The following options are available:

- **AUTO** — The product attempts to reprint jammed pages when sufficient memory is available. This is the default setting.
- **OFF** — The product does not attempt to reprint jammed pages. Because no memory is used to store the most recent pages, performance is optimal.



---

 **NOTE:** When using this option, if the product runs out of paper and the job is being printed on both sides, some pages can be lost.

---

- **ON** — The product always reprints jammed pages. Additional memory is allocated to store the last few pages printed. This might cause overall performance to suffer.

### Set the jam recovery feature

1. Press the **Menu** button .
2. Press the down arrow ▼ button or the up arrow ▲ button to navigate to the **CONFIGURE DEVICE** menu, and then press the **OK** button.
3. Press the down arrow ▼ button or the up arrow ▲ button to navigate to the **SYSTEM SETUP** menu, and then press the **OK** button.
4. Press the down arrow ▼ button or the up arrow ▲ button to navigate to the **JAM RECOVERY** menu, and then press the **OK** button.
5. Press the down arrow or up arrow ▼/▲ buttons to highlight the appropriate setting, and then press the **OK** button.
6. Press the **Menu** button  to return to the **Ready** state.

# Solve paper-handling problems

Use only paper that meets the specifications outlined in the *HP LaserJet Printer Family Print Media Guide*. Always configure the paper type on the control panel to match the type of paper that is loaded in the tray.

## Product feeds multiple sheets

### Product feeds multiple sheets

Cause	Solution
The input tray is overfilled. Open the tray and verify that the paper stack is below the maximum stack height mark.	Remove excess paper from the input tray.
Print paper is sticking together.	Remove paper, flex it, rotate it 180 degrees or flip it over, and then reload it into the tray.  <b>NOTE:</b> Do not fan paper. Fanning can cause static electricity, which can cause paper to stick together.
Paper does not meet the specifications for this product.	Use only paper that meets HP paper specifications for this product.
Trays are not properly adjusted.	Make sure that the paper guides match the size of paper being used.

## Product feeds incorrect page size

### Product feeds incorrect page size

Cause	Solution
The correct size paper is not loaded in the input tray.	Load the correct size paper in the input tray.
The correct size paper is not selected in the software program or printer driver.	Confirm that the settings in the software program and printer driver are correct, because the software program settings override the printer driver and control panel settings, and the printer driver settings override the control panel settings. For more information, see the product user guide.
The correct size paper for the tray is not selected in the product control panel.	From the control panel, select the correct size paper for the tray.
The paper size is not configured correctly for the input tray.	Print a configuration page or use the control panel to determine the paper size for which the tray is configured.
The guides in the tray are not against the paper.	Verify that the paper guides are touching the paper.

## Product pulls from incorrect tray

### Product pulls from incorrect tray

Cause	Solution
You are using a driver for a different product.	Use a driver for this product.
The specified tray is empty.	Load paper in the specified tray.
The paper size is not configured correctly for the input tray.	Print a configuration page or use the control panel to determine the paper size for which the tray is configured.

## Paper does not feed automatically

### Paper does not feed automatically

Cause	Solution
Manual feed is selected in the software program.	Load Tray 1 with paper, or, if the paper is loaded, press the <b>OK</b> button.
The correct size paper is not loaded.	Load the correct size paper.
The input tray is empty.	Load paper into the input tray.
Paper from a previous jam has not been completely removed.	Open the product and remove any paper in the paper path.
The paper size is not configured correctly for the input tray.	Print a configuration page or use the control panel to determine the paper size for which the tray is configured.
The guides in the tray are not against the paper.	Verify that the rear and width paper guides are touching the paper.
The manual-feed prompt is set to <b>ALWAYS</b> . The product always prompts for manual feed, even if the tray is loaded.	Open the tray, reload the media, and then close the tray. Or, change the manual-feed prompt setting to <b>UNLESS LOADED</b> , so that the product prompts for manual feed only when the tray is empty.
The <b>USE REQUESTED TRAY</b> setting on the product is set to <b>EXCLUSIVELY</b> , and the requested tray is empty. The product will not use another tray.	Load the requested tray. Or, change the setting from <b>EXCLUSIVELY</b> to <b>FIRST</b> on the <b>CONFIGURE DEVICE</b> menu. The product can use other trays if no media is loaded in the specified tray.

## Paper does not feed from Tray 2, 3, or 4

### Paper does not feed from Tray 2 or 3

Cause	Solution
The correct size paper is not loaded.	Load the correct size paper.
The input tray is empty.	Load paper in the input tray.
The correct paper type for the input tray is not selected in the product control panel.	From the product control panel, select the correct paper type for the input tray.
Paper from a previous jam has not been completely removed.	Open the product and remove any paper in the paper path. Closely inspect the fuser area for jams.
None of the optional trays appear as input tray options.	The optional trays only display as available if they are installed. Verify that any optional trays are correctly installed. Verify that the printer driver has been configured to recognize the optional trays.
An optional tray is incorrectly installed.	Print a configuration page to confirm that the optional tray is installed. If not, verify that the tray is correctly attached to the product.
The paper size is not configured correctly for the input tray.	Print a configuration page or use the control panel to determine the paper size for which the tray is configured.
The guides in the tray are not against the paper.	Verify that the guides are touching the paper.

## Transparencies or glossy paper will not feed

### Transparencies or glossy paper will not feed

Cause	Solution
The correct paper type is not specified in the software or printer driver.	Verify that the correct paper type is selected in the software or printer driver.
The input tray is overfilled.	Remove excess paper from the input tray. Do not exceed the maximum stack height marks for the tray.
Paper in another input tray is the same size as the transparencies, and the product is defaulting to the other tray.	Make sure that the input tray containing the transparencies or glossy paper is selected in the software program or printer driver. Use the product control panel to configure the tray to the paper type loaded.
The tray containing the transparencies or glossy paper is not configured correctly for type.	Make sure that the input tray containing the transparencies or glossy paper is selected in the software program or printer driver. Use the product control panel to configure the tray to the paper type loaded.
Transparencies or glossy paper might not meet supported paper specifications.	Use only paper that meets the HP paper specifications for this product.
High-humidity environments may cause glossy paper not to feed, or to feed too many sheets.	Avoid printing glossy paper in high humidity conditions. When printing glossy paper, removing the paper from the wrapper and letting it rest for a few hours can improve feeding into the product. However, letting paper rest in humid environments may also cause blisters.

## Envelopes jam or will not feed in the product

### Envelopes jam or will not feed in the product

Cause	Solution
Envelopes are loaded in an unsupported tray. Only Tray 1 can feed envelopes.	Load envelopes into Tray 1.
Envelopes are curled or damaged.	Try using different envelopes. Store envelopes in a controlled environment.
Envelopes are sealing because the moisture content is too high.	Try using different envelopes. Store envelopes in a controlled environment.
Envelope orientation is incorrect.	Verify that the envelope is loaded correctly.
This product does not support the envelopes being used.	Refer to the <i>HP LaserJet Printer Family Print Media Guide</i> .
Tray 1 is configured for a size other than envelopes.	Configure Tray 1 size for envelopes.

## Output is curled or wrinkled

### Output is curled or wrinkled

Cause	Solution
Paper does not meet the specifications for this product.	Use only paper that meets the HP paper specifications for this product.
Paper is damaged or in poor condition.	Remove paper from the input tray and load paper that is in good condition.
Product is operating in an excessively humid environment.	Verify that the printing environment is within humidity specifications.
You are printing large, solid-filled areas.	Large, solid-filled areas can cause excessive curl. Try using a different pattern.
Paper used was not stored correctly and might have absorbed moisture.	Remove paper and replace it with paper from a fresh, unopened package.
Paper has poorly cut edges.	Remove paper, flex it, rotate it 180 degrees or turn it over, and then reload it into the input tray. Do not fan paper. If the problem persists, replace the paper.
The specific paper type was not configured for the tray or selected in the software.	Configure the software for the paper (see the software documentation). Configure the tray for the paper, see the product user guide.
The paper has previously been used for a print job.	Do not re-use paper.

## Product does not duplex or duplexes incorrectly (duplex models)

### Product will not duplex (print 2-sided jobs) or duplexes incorrectly

Cause	Solution
The product does not support automatic 2-sided printing.	The HP LaserJet P3015 base model does not support automatic 2-sided printing.
You are trying to duplex on unsupported paper.	Verify that the paper is supported for duplex printing.
The printer driver is not set up for duplex printing.	Set up the printer driver to enable duplex printing.
The first page is printing on the back of preprinted forms or letterhead.	Load preprinted forms and letterhead in Tray 1 with the letterhead or printed side down, with the top of the page leading into the product. For Trays 2, 3, and 4, load the paper printed side up with the top of the page toward the front of the product.
The product configuration is not set for duplexing.	In Windows, run the automatic configuration feature: <ol style="list-style-type: none"><li>1. Click the <b>Start</b> button, point to <b>Settings</b>, and then click <b>Printers</b> (for Windows 2000) or <b>Printers and Faxes</b> (for Windows XP).</li><li>2. Right-click the HP product icon, and then click <b>Properties</b> or <b>Printing Preferences</b>.</li><li>3. Click the <b>Device Settings</b> tab.</li><li>4. Under <b>Installable Options</b>, click <b>Update Now</b> in the <b>Automatic Configuration</b> list.</li></ol>
Duplex printing is turned off.	<ol style="list-style-type: none"><li>1. Open each of the following menus. Press the down arrow ▼ button to highlight it and then press the <b>OK</b> button to select it.<ol style="list-style-type: none"><li>a. <b>CONFIGURE DEVICE</b></li><li>b. <b>PRINTING</b></li><li>c. <b>DUPLEX</b></li></ol></li><li>2. Select the <b>ON</b> option.</li></ol>


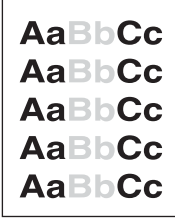



# Solve image-quality problems

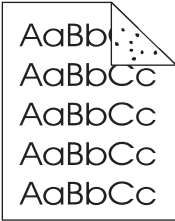
## Image defect examples

These examples identify the most common print-quality problems. If you still have problems after trying the suggested solutions, contact HP Customer Support.


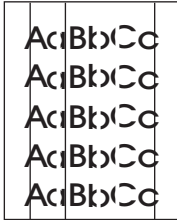
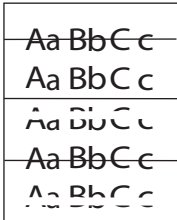
**Table 3-9 Image defect examples**

Problem	Image example	Solution
Blank page		<ol style="list-style-type: none"><li>1. The laser/scanner shutter on the print cartridge might be damaged. Replace the print cartridge.</li><li>2. The laser/scanner shutter on the laser/scanner might be damaged. Replace the laser/scanner. See <a href="#">Laser/scanner on page 107</a>.</li><li>3. The laser/scanner might be damaged. Replace the laser/scanner. See <a href="#">Laser/scanner on page 107</a>.</li><li>4. Poor developing bias with the cartridge contacts. Clean the contact on the print cartridge.</li><li>5. The high-voltage power supply might be damaged. Replace the high-voltage power supply. See <a href="#">High-voltage power supply (HVPS) on page 121</a>.</li></ol>
Light print (partial page)		<ol style="list-style-type: none"><li>1. Make sure that the print cartridge is fully installed.</li><li>2. The print cartridge might be almost empty. Check the supplies status, and replace the print cartridge if necessary.</li><li>3. The paper might not meet HP specifications (for example, the paper is too moist or too rough).</li></ol>
Light print (entire page)		<ol style="list-style-type: none"><li>1. Make sure that the print cartridge is fully installed.</li><li>2. Make sure that the <b>ECONOMODE</b> setting is turned off at the control panel and in the printer driver. For more information, see the product user guide.</li><li>3. Open the <b>CONFIGURE DEVICE</b> menu at the product control panel. Open the <b>PRINT QUALITY</b> submenu and increase the <b>TONER DENSITY</b> setting. For more information, see the product user guide.</li><li>4. Try using a different type of paper.</li><li>5. The print cartridge might be reaching its estimated end of life. Check the supplies status, and replace the print cartridge if necessary.</li></ol>



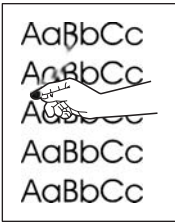
**Table 3-9 Image defect examples (continued)**

Problem	Image example	Solution
		<p><b>Perform the following test</b></p> <p>Stop a print job during the print operation before it is complete, then remove the print cartridge. Open the photosensitive drum shield, and look at the toner image on the drum.</p> <ul style="list-style-type: none"> <li>◦ If the image is not fully transferring to the page, replace the transfer roller. See <a href="#">Transfer roller on page 92</a>. Go to step 6.</li> <li>◦ If the toner on the drum is faint, replace the laser/scanner. See <a href="#">Laser/scanner on page 107</a>. Go to step 9.</li> </ul> <ol style="list-style-type: none"> <li>6. The transfer roller shaft might be dirty. Remove the transfer roller and clean the shaft to ensure good contact. See <a href="#">Transfer roller on page 92</a>.</li> <li>7. If the transfer roller is deformed or damaged, replace the roller. See <a href="#">Transfer roller on page 92</a>.</li> <li>8. The high-voltage power supply might be damaged. Replace the high-voltage power supply. See <a href="#">High-voltage power supply (HVPS) on page 121</a>.</li> <li>9. The laser/scanner might be damaged. Replace the laser/scanner. See <a href="#">Laser/scanner on page 107</a>.</li> </ol> <p>If replacing the laser/scanner does not resolve the problem and the high-voltage power supply was not replaced (step 8), replace the high-voltage power supply. See <a href="#">High-voltage power supply (HVPS) on page 121</a>.</p>
<p>Specks (front or back of the page is dirty)</p>		<p>Specks might appear on a page after a jam has been cleared.</p> <ol style="list-style-type: none"> <li>1. The paper might be dirty. Use a new package of paper. make sure that the paper is stored correctly. See your product user guide.</li> <li>2. Print a few more pages to see if the problem corrects itself.</li> <li>3. Clean the inside of the product and run a cleaning page to clean the fuser. See <a href="#">Print Quality menu on page 180</a>.</li> <li>4. Try using a different type of paper.</li> <li>5. Check the print cartridge for leaks. If the print cartridge is leaking, replace it.</li> <li>6. The cassette pickup roller might be dirty. Clean the roller. If it cannot be cleaned, replace the roller. See <a href="#">Tray 2, Tray 3, or Tray 4 pickup roller on page 88</a>.</li> <li>7. Repetitive dirt marks can be caused by the registration roller, transfer roller or pressure roller. Use the <a href="#">Repetitive image-defect ruler on page 173</a> to identify the problem, and then replace the appropriate component.</li> <li>8. The media-feed guide, or the fuser-inlet guide might be dirty. Clean the guide.</li> <li>9. The delivery rollers might be dirty. Clean the rollers.</li> </ol>

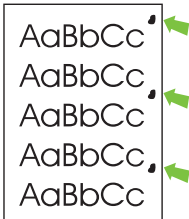
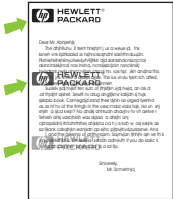
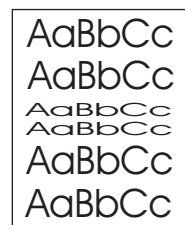
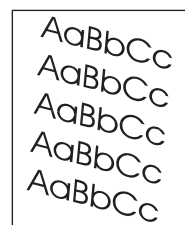
**Table 3-9 Image defect examples (continued)**

Problem	Image example	Solution
Dropouts		<ol style="list-style-type: none"> <li>1. Make sure that the environmental specifications for the product are being met. See <a href="#">Environmental specifications on page 309</a>.</li> <li>2. If the paper is rough, and the toner easily rubs off, open the <b>CONFIGURE DEVICE</b> menu at the product control panel. Open the <b>PRINT QUALITY</b> submenu, select <b>FUSER MODES</b>, and then select the paper type you are using. Change the setting to <b>HIGH1</b> or <b>HIGH2</b>, which helps the toner fuse more completely onto the paper. For more information, see the product user guide.</li> <li>3. Try using a smoother paper.</li> <li>4. If the transfer roller is deformed or damaged, replace the roller. See <a href="#">Transfer roller on page 92</a>.</li> <li>5. The high-voltage contact of the static eliminator with the print cartridge might be dirty. Clean the contact.</li> <li>6. The photosensitive drum, primary charging roller, or developing roller might be damaged. Replace the print cartridge.</li> <li>7. The fuser film might be scratched or dirty. Replace the fuser. See <a href="#">Fuser on page 100</a>.</li> <li>8. The high-voltage power supply might be damaged. Replace the high-voltage power supply. See <a href="#">High-voltage power supply (HVPS) on page 121</a>.</li> </ol>
Lines		<ol style="list-style-type: none"> <li>1. Print a few more pages to see if the problem corrects itself.</li> <li>2. Clean the inside of the product and run a cleaning page to clean the fuser. See the <a href="#">Print Quality menu on page 180</a> for cleaning page information, and <a href="#">Clean the product on page 254</a>.</li> <li>3. The photosensitive drum might be scratched. Replace the print cartridge.</li> <li>4. The fuser-inlet guide might be dirty. Clean the guide.</li> <li>5. The fuser film might be scratched. Replace the fuser. See <a href="#">Fuser on page 100</a>.</li> </ol>
Horizontal lines		<ol style="list-style-type: none"> <li>1. The photosensitive drum might be scratched. Replace the print cartridge.</li> <li>2. The fuser film might be dirty or damaged. Replace the fuser. See <a href="#">Fuser on page 100</a>.</li> </ol>

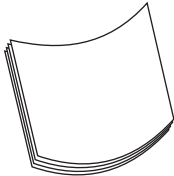
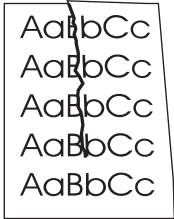

**Table 3-9 Image defect examples (continued)**

Problem	Image example	Solution
Gray background (image is obviously dark)		<ol style="list-style-type: none"> <li>1. Do not use paper that has already been run through the product.</li> <li>2. Try using a different type of paper.</li> <li>3. Print a few more pages to see if the problem corrects itself.</li> <li>4. Turn over the paper in the tray. Also, try rotating the paper 180°.</li> <li>5. Open the <b>CONFIGURE DEVICE</b> menu at the product control panel. On the <b>PRINT QUALITY</b> submenu, increase the <b>TONER DENSITY</b> setting. For more information, see the product user guide.</li> <li>6. Make sure that the environmental specifications for the product are being met. See the product user guide.</li> <li>7. The print cartridge might need to be replaced.</li> <li>8. The print-cartridge ground or bias contacts might be dirty. Clean the contacts.</li> <li>9. Stop a print job before it is complete, and then remove the print cartridge. Open the photosensitive drum shield, and look at the toner image on the drum. <ul style="list-style-type: none"> <li>◦ If the image is not fully transferring to the page, replace the transfer roller. See <a href="#">Transfer roller on page 92</a>.</li> <li>◦ If the toner on the drum is faint, replace the laser/scanner. See <a href="#">Laser/scanner on page 107</a>.</li> </ul> </li> <li>10. The high-voltage power supply might be damaged. Replace the high-voltage power supply. See <a href="#">High-voltage power supply (HVPS) on page 121</a>.</li> </ol>
Toner smear		<ol style="list-style-type: none"> <li>1. Print a few more pages to see if the problem corrects itself.</li> <li>2. Try using a different type of paper.</li> <li>3. Make sure that the environmental specifications for the product are being met. See <a href="#">Environmental specifications on page 309</a>.</li> <li>4. Clean the inside of the product and run a cleaning page to clean the fuser. See <a href="#">Print Quality menu on page 180</a>.</li> <li>5. The print cartridge might need to be replaced.</li> </ol>
Loose toner		<p>Loose toner, in this context, is defined as toner that can be rubbed off the page.</p> <ol style="list-style-type: none"> <li>1. If paper is heavy or rough, open the <b>CONFIGURE DEVICE</b> menu at the product control panel. On the <b>PRINT QUALITY</b> submenu, select <b>FUSER MODES</b>, and then select the paper type you are using. Change the setting to <b>HIGH1</b> or <b>HIGH2</b>, which helps the toner fuse more completely onto the paper. You must also set the type of paper for the tray you are using. For more information, see the product user guide.</li> <li>2. If you have observed a rougher texture on one side of your paper, try printing on the smoother side.</li> <li>3. Make sure that the environmental specifications for the product are being met. See <a href="#">Environmental specifications on page 309</a>.</li> <li>4. Make sure that the type and quality of the paper you are using meet HP specifications. For more information, see the product user guide.</li> <li>5. The pressure roller is dirty, the fuser film is scratched, or a foreign substance is on the fuser film. Use the <b>PRINT FUSER TEST PAGE</b> option in the <b>DIAGNOSTICS</b> menu to test the fuser. If the error persists, replace the fuser. See <a href="#">Fuser on page 100</a>.</li> </ol>

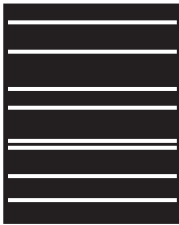

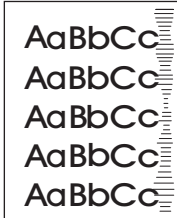
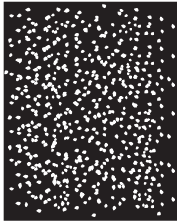
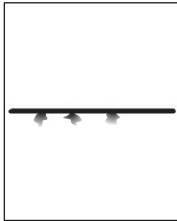
**Table 3-9 Image defect examples (continued)**

Problem	Image example	Solution
Repeat defects		<ol style="list-style-type: none"> <li>1. Print a few more pages to see if the problem corrects itself.</li> <li>2. Clean the inside of the product and run a cleaning page to clean the fuser. See <a href="#">Print Quality menu on page 180</a>.</li> <li>3. Use the repetitive defect ruler to determine if the defect is caused by the fuser or the print cartridge (see <a href="#">Repetitive image-defect ruler on page 173</a>). <ul style="list-style-type: none"> <li>◦ If the print cartridge is causing the defect, run the print/stop test at the 500 msec setting. If the test shows a defect, replace the print cartridge. See <a href="#">Print cartridge on page 52</a>.</li> <li>◦ Use the <b>PRINT FUSER TEST PAGE</b> option in the <b>DIAGNOSTICS</b> menu to test the fuser. If the error persists, replace the fuser. See <a href="#">Fuser on page 100</a>.</li> </ul> </li> </ol>
Repeat image		<p>This type of defect might occur when using preprinted forms or a large quantity of narrow paper. Verify that the preprinted ink used on forms meet HP specifications for use in laser printers.</p> <ol style="list-style-type: none"> <li>1. Print a few more pages to see if the problem corrects itself.</li> <li>2. Make sure that the type and quality of the paper you are using meet HP specifications. For more information, see the product user guide.</li> <li>3. Verify that the product is configured for the correct paper type.</li> <li>4. Set the fuser mode to <b>LOW</b>.</li> <li>5. Use the <b>PRINT FUSER TEST PAGE</b> option in the <b>DIAGNOSTICS</b> menu to test the fuser. If the error persists, replace the fuser. See <a href="#">Fuser on page 100</a>.</li> </ol>
Misformed characters		<ol style="list-style-type: none"> <li>1. Print a few more pages to see if the problem corrects itself.</li> <li>2. Make sure that the environmental specifications for the product are being met. See the product user guide.</li> <li>3. Make sure that the type and quality of the paper you are using meet HP specifications. For more information, see the product user guide.</li> <li>4. The laser/scanner wire connectors might have poor contact. Reconnect the connectors (J12 and J3100).</li> <li>5. The ECU wire connectors might have poor contact. Reconnect the connectors (J1505 and J1702).</li> <li>6. The laser/scanner might be damaged. Replace the laser/scanner. See <a href="#">Laser/scanner on page 107</a>.</li> </ol>
Page skew		<ol style="list-style-type: none"> <li>1. Print a few more pages to see if the problem corrects itself.</li> <li>2. Verify that no torn pieces of paper are inside the product.</li> <li>3. Make sure that paper is loaded correctly and that all adjustments have been made. Make sure that the guides in the tray are not too tight or too loose against the paper.</li> <li>4. Turn over the paper in the tray. Also, try rotating the paper 180°.</li> <li>5. Make sure that the type and quality of the paper you are using meet HP specifications. For more information, see the product user guide.</li> <li>6. Make sure that the environmental specifications for the product are being met. See <a href="#">Environmental specifications on page 309</a>.</li> </ol>

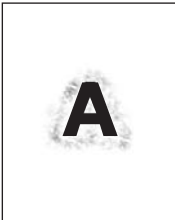

**Table 3-9 Image defect examples (continued)**

Problem	Image example	Solution
Curl or wave		<ol style="list-style-type: none"> <li>1. Turn over the paper in the tray. Also, try rotating the paper 180°.</li> <li>2. Make sure that the type and quality of the paper you are using meet HP specifications. For more information, see the product user guide.</li> <li>3. Make sure that the environmental specifications for the product are being met. See <a href="#">Environmental specifications on page 309</a>.</li> <li>4. Try printing to a different output bin.</li> <li>5. If paper is lightweight and smooth, open the <b>CONFIGURE DEVICE</b> menu at the product control panel. On the <b>PRINT QUALITY</b> submenu, select <b>FUSER MODES</b>, and then select the paper type you are using. Change the setting to <b>LOW</b>, which helps reduce the heat in the fusing process. You must also set the type of paper for the tray you are using. For more information, see the product user guide.</li> </ol>
Wrinkles or creases		<ol style="list-style-type: none"> <li>1. Print a few more pages to see if the problem corrects itself.</li> <li>2. Make sure that the environmental specifications for the product are being met. See <a href="#">Environmental specifications on page 309</a>.</li> <li>3. Turn over the paper in the tray. Also, try rotating the paper 180°.</li> <li>4. Make sure that paper is loaded correctly and all adjustments have been made. For more information, see the product user guide.</li> <li>5. Make sure that the type and quality of the paper you are using meet HP specifications. See the product user guide.</li> <li>6. If envelopes are creasing, try storing envelopes so that they lie flat.</li> <li>7. If paper is lightweight and smooth, open the <b>CONFIGURE DEVICE</b> menu at the product control panel. On the <b>PRINT QUALITY</b> submenu, select <b>FUSER MODES</b>, and then select the paper type you are using. Change the setting to <b>LOW</b>, which helps reduce the heat in the fusing process. You must also set the type of paper for the tray you are using. For more information, see the product user guide.</li> </ol>
Vertical white lines		<ol style="list-style-type: none"> <li>1. Print a few more pages to see if the problem corrects itself.</li> <li>2. Make sure that the type and quality of the paper you are using meet HP specifications. For more information, see the product user guide.</li> <li>3. The photosensitive drum might be scratched, or the developing roller might be damaged. Replace the print cartridge.</li> <li>4. The laser beam window might be dirty. Clean the laser beam window on the laser/scanner.</li> <li>5. The fuser inlet guide might be dirty. Clean the guide. See <a href="#">Clean the product on page 254</a>.</li> <li>6. The fuser film might be scratched or dirty. Replace the fuser. See <a href="#">Fuser on page 100</a>.</li> <li>7. The laser/scanner might be damaged. Replace the laser/scanner. See <a href="#">Laser/scanner on page 107</a>.</li> </ol>

**Table 3-9 Image defect examples (continued)**

Problem	Image example	Solution
Horizontal white lines		<ol style="list-style-type: none"> <li>1. The photosensitive drum might be scratched, or the developing roller might be damaged. Replace the print cartridge.</li> <li>2. The fuser film might be damaged. Replace the fuser. See <a href="#">Fuser on page 100</a>.</li> </ol>
Black page		<ol style="list-style-type: none"> <li>1. The print-cartridge ground or bias contacts might be dirty. Clean the contacts.</li> <li>2. The primary charging roller might be defective. Replace the print cartridge.</li> <li>3. The high-voltage power supply might be damaged. Replace the high-voltage power supply. See <a href="#">High-voltage power supply (HVPS) on page 121</a>.</li> </ol>
Tire tracks		<p>This defect typically occurs when the print cartridge has far exceeded its estimated life. For example, if you are printing a very large quantity of pages with very little toner coverage.</p> <ol style="list-style-type: none"> <li>1. The print cartridge might need to be replaced.</li> <li>2. Reduce the number of pages that you print with very low toner coverage.</li> </ol>
White spots on black or in the image		<ol style="list-style-type: none"> <li>1. Print a few more pages to see if the problem corrects itself.</li> <li>2. Make sure that the type and quality of the paper you are using meet HP specifications. For more information, see the product user guide.</li> <li>3. Make sure that the environmental specifications for the product are being met. See the product user guide.</li> <li>4. The print cartridge might need to be replaced.</li> <li>5. If the transfer roller is deformed or damaged, replace the roller. See <a href="#">Transfer roller on page 92</a>.</li> <li>6. The transfer roller shaft might be dirty (poor contact). Remove the transfer roller and clean the shaft. See <a href="#">Transfer roller on page 92</a>.</li> <li>7. The high-voltage power supply might be damaged. Replace the high-voltage power supply. See <a href="#">High-voltage power supply (HVPS) on page 121</a>.</li> </ol>
Scattered lines		<ol style="list-style-type: none"> <li>1. Make sure that the type and quality of the paper you are using meet HP specifications. For more information, see the product user guide.</li> <li>2. Make sure that the environmental specifications for the product are being met. See <a href="#">Environmental specifications on page 309</a>.</li> <li>3. Turn over the paper in the tray. Also, try rotating the paper 180°.</li> <li>4. Open the <b>CONFIGURE DEVICE</b> menu at the product control panel. Open the <b>PRINT QUALITY</b> submenu and change the <b>TONER DENSITY</b> setting. For more information, see the product user guide.</li> <li>5. Open the <b>CONFIGURE DEVICE</b> menu at the product control panel. On the <b>PRINT QUALITY</b> submenu, open <b>OPTIMIZE</b> and set <b>LINE DETAIL=ON</b>. For more information, see the product user guide.</li> </ol>

**Table 3-9 Image defect examples (continued)**

Problem	Image example	Solution
Blurred print		<ol style="list-style-type: none"> <li>1. Make sure that the type and quality of the paper you are using meet HP specifications. For more information, see the product user guide.</li> <li>2. Make sure that the environmental specifications for the product are being met. See <a href="#">Environmental specifications on page 309</a>.</li> <li>3. Turn over the paper in the tray. Also, try rotating the paper 180°.</li> <li>4. Do not use paper that already has been run through the product.</li> <li>5. Decrease the toner density. Open the <b>CONFIGURE DEVICE</b> menu at the product control panel. Open the <b>PRINT QUALITY</b> submenu and change the <b>TONER DENSITY</b> setting. For more information, see the product user guide.</li> <li>6. Open the <b>CONFIGURE DEVICE</b> menu at the product control panel. On the <b>PRINT QUALITY</b> submenu, open <b>OPTIMIZE</b> and set <b>HIGH TRANSFER=ON</b>. For more information, see the product user guide.</li> </ol>
Random image repetition		<p>If an image that appears at the top of the page (in solid black) repeats further down the page (in a gray field), the toner might not have been completely erased from the last job. (The repeated image might be lighter or darker than the field it appears in.)</p> <ul style="list-style-type: none"> <li>• Change the tone (darkness) of the field that the repeated image appears in.</li> <li>• Change the order in which the images are printed. For example, have the lighter image at the top of the page, and the darker image farther down the page.</li> <li>• From your software program, rotate the whole page 180° to print the lighter image first.</li> <li>• If the defect occurs later in a print job, turn the product off for 10 minutes, and then turn it on to restart the print job.</li> </ul>

## Clean the product

**⚠ WARNING!** Do not attempt to clean the print-cartridge photosensitive drum or the product transfer roller.

### Clean the product (service visit)

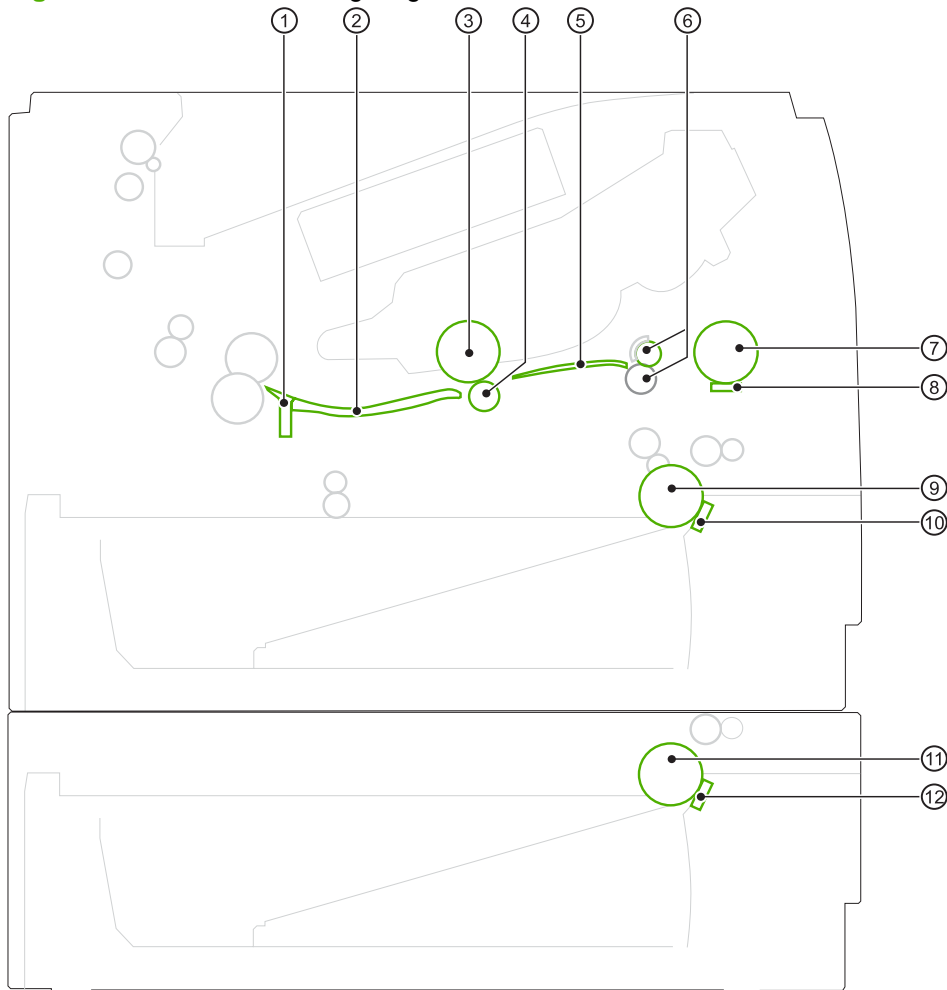
Use the guidelines below to clean the product.

- Tray 1 (multipurpose tray) pickup roller and separation pad
  - Wipe with a clean lint-free cloth
- Cassette (Tray 2) pickup roller and separation pad
  - Wipe with a clean lint-free cloth
- Paper feeder (Tray 3 and Tray 4) pickup roller and separation pad
  - Wipe with a clean lint-free cloth



- Registration roller
  - Wipe with a clean lint-free cloth
- Transfer guide
  - Wipe with a soft, dry flannel cloth
- Media-feed guide
  - Wipe with a clean lint-free cloth
- Fuser-inlet guide
  - Wipe with a water dampened flannel cloth

**Figure 3-34** Product cleaning diagram



**Table 3-10** Product cleaning diagram

Item	Description	Item	Description
1	Fuser-inlet guide	7	Tray 1 (multipurpose tray) pickup roller
2	Media-feed guide	8	Tray 1 (multipurpose tray) separation pad
3	Photosensitive drum (in the print cartridge)	9	Cassette (Tray 2) pickup roller

**Table 3-10 Product cleaning diagram (continued)**

Item	Description	Item	Description
4	Transfer roller	10	Cassette (Tray 2) separation pad
5	Transfer guide	11	Paper feeder pickup roller (Tray 3 or Tray 4)
6	Registration roller	12	Paper feeder separation pad (Tray 3 or Tray 4)

# Solve performance problems

Problem	Cause	Solution
Pages print but are totally blank.	The document might contain blank pages.	Check the document that you are printing to see if content appears on all of the pages.
	The product might be malfunctioning.	To check the product, print a Configuration page.
Pages print very slowly.	Heavier paper types can slow the print job.	Print on a different type of paper.
	Complex pages can print slowly.	Proper fusing may require a slower print speed to ensure the best print quality.
Pages did not print.	The product might not be pulling paper correctly.	Make sure paper is loaded in the tray correctly.
	The paper is jamming in the product.	Clear the jam. See <a href="#">Clear jams on page 219</a> .
	The USB cable might be defective or incorrectly connected.	<ul style="list-style-type: none"> <li>● Disconnect the USB cable at both ends and reconnect it.</li> <li>● Try printing a job that has printed in the past.</li> <li>● Try using a different USB cable.</li> </ul>
	Other devices are running on your computer.	The product might not share a USB port. If you have an external hard drive or network switchbox that is connected to the same port as the product, the other device might be interfering. To connect and use the product, you must disconnect the other device or you must use two USB ports on the computer.

# Solve connectivity problems

## Solve direct-connect problems

If you have connected the product directly to a computer, check the cable.

- Verify that the cable is connected to the computer and to the product.
- Verify that the cable is not longer than 2 meters (6 feet). Replace the cable if necessary.
- Verify that the cable is working correctly by connecting it to another product. Replace the cable if necessary.

## Solve network problems


Check the following items to verify that the product is communicating with the network. Before beginning, print a configuration page. See [Configuration page on page 172](#).

Problem	Solution
Poor physical connection	Verify that the product is attached to the correct network port using a cable of the correct length.  Verify that cable connections are secure.  Look at the network port connection on the back of the product, and verify that the amber activity light and the green link-status light are lit.  If the problem continues, try a different cable or port on the hub.
The computer is unable to communicate with the product.	Use the command prompt to ping the product from your computer. For example:  <code>ping 192.168.45.39</code>  Verify that the ping displays round-trip times, which indicates that it is working.  If the ping command failed, verify that the network hubs are on, and then verify that the network settings, the product, and the computer are all configured for the same network.
Incorrect link and duplex settings	Hewlett-Packard recommends leaving this setting in automatic mode (the default setting). See the product user guide for more information.
Incorrect IP address for the product on the computer	Use the correct IP address.  If the IP address is correct, delete the product and then it add again.
New software programs have caused compatibility problems.	Verify that any new software programs are correctly installed and that they use the correct printer driver.
Your computer or workstation is set up incorrectly.	Check the network drivers, printer drivers, and the network redirection.  Verify that the operating system is configured correctly.
The protocol is disabled, or other network settings are incorrect.	Print a configuration page to check the status of the protocol. Enable it if necessary.  Use the control panel to reconfigure the network settings if necessary.

# Service mode functions

## Service menu

The **SERVICE** menu is PIN-protected for added security. Only authorized service people have access to the **SERVICE** menu. When you select **SERVICE** from the list of menus, the product prompts you to enter an eight-digit PIN number.

- The PIN for the HP LaserJet P3015 models is 07301509.
1. Press the **Menu** button .
  2. Press the down arrow ▼ button or the up arrow ▲ button to navigate to the **SERVICE** menu, and then press the **OK** button.
  3. Type the PIN using the alphanumeric keypad (for the base model, use the arrow keys).
  4. Press the **OK** button to enter the PIN and open the **SERVICE** menu.


The following menu items appear in the **SERVICE** menu:

- **CLEAR EVENT LOG:** Use this item to clear the product event log.
- **CLEAR BOOTLOADER PASSWORD:** Use this item to clear the password that was set to prevent someone from performing an unauthorized cold reset, resetting factory defaults, or changing sleep mode settings from the **RESETS** menu.
- **TOTAL PAGE COUNT:** After replacing the formatter, use this item to reset the page count so that the figure continues to represent the page count for the product engine.
- **REFURBISH CYCLE COUNT:** Use this item to record the page count when the product was refurbished.
- **SERIAL NUMBER:** After replacing the formatter, use this item to reset the product serial number.
- **SERVICE ID:** See [Service ID on page 261](#), [Restore service ID on page 261](#), and [Convert the service ID to an actual date on page 261](#).
- **COLD RESET PAPER:** Select this item to reset the default paper size when the formatter is replaced or factory settings are restored (see [Resets menu on page 194](#)).

When a formatter is replaced or factory settings are restored in a country/region that uses A4 as the standard paper size, use this item to reset the default paper size.

## Product resets


### Restore factory settings

1. Press the **Menu** button .
2. Open each of the following menus. Press the down arrow ▼ button to highlight it and then press the **OK** button to select it.
  - a. **CONFIGURE DEVICE**
  - b. **RESETS**
  - c. **RESTORE FACTORY SETTINGS**

For more information, see [Resets menu on page 194](#).


### Hard disk initialization

A hard disk initialization will erase and reformat the product's hard disk. Perform hard disk initialization only if an error code displays on the control panel indicating a disk error. Always try initializing the hard disk before replacing it.

1. Turn the product on.
2. As the product performs its power-on sequence, press and hold the **Menu** button  until all three lights on the control panel are lit.
3. Press the back arrow ↵. The message **INITIALIZE DISC** displays on the control panel.
4. Press the **OK** button. The product initializes the hard disk and continues the power-on sequence.


### Skip disk-load

When the power is turned on the product begins the power-on sequence. By performing a power-on bypass, you can cause the product to resume the power-on sequence but not to recognize any installed EIO hard disk. This can be helpful in isolating EIO hard-disk errors.


1. Turn the product off.
2. Turn the product on. When the memory count begins, press and hold the ▼ button. Continue holding down the ▼ button until all three product control-panel lights flash once and then remain on. This might take up to 10 seconds.
3. Press the ▲ button, and then press the **Menu** button .
4. Press the ▲ button or the ▼ button until **SKIP DISK LOAD** is highlighted.
5. Press the **OK** button. The product continues the power-on sequence but ignores an installed EIO hard disk.

### NVRAM initialization

- △ **CAUTION:** Initializing NVRAM resets the serial number, the event log, the page counts, the calibration settings, and the EIO card. Use the **SERVICE** menu to restore the serial number and page counts. You also need to reconfigure any computers that print to this product to recognize the product. Initialize NVRAM only when absolutely necessary. In most situations, use a cold reset to reset product variables but still retain the needed values in the **SERVICE** menu.

 **NOTE:** Before performing a NVRAM initialization, print a menu map and a configuration page. Use the information on the configuration page to reset any customer-set product configuration values that the NVRAM initialization procedure changes. Take special not of the page count, service ID, and the serial number.

---

1. Turn the product off.
2. Remove any installed accessories.
3. Turn the product on. When the memory count begins, press and hold the down arrow ▼ button until all three product control-panel lights flash once and then remain on. This might take up to 10 seconds.
4. Press the up arrow ▲ button.
5. Press the **Menu** button . The message **SKIP DISK LOAD** displays on the control panel.
6. Press the up arrow ▲ button until **NVRAM INIT** is highlighted.
7. press **OK**. The product initializes NVRAM and then continues its power-on sequence.

### Service ID

Use this item to show the date that the product was first used on the control panel. This eliminates the need for users to keep paper receipts for proof of warranty.

Because the product does not have an internal clock, the availability of the service ID date depends on the product being connected to a source that can provide the date, in this case a time server on the same network as the product. When the product is not connected to a date source, the service ID is not available, and 00000 appears on the configuration page.

### Restore service ID

If you replace the formatter, the date is lost. Use this menu item to reset the date to the original date that the product was first used. The date format is YYDDD. Use the following formula to calculate the dates:

1. To calculate YY, subtract 1990 from the calendar year. For instance, if the product was first used in 2002, calculate YY as follows:  $2002 - 1990 = 12$ .  $YY = 12$ .
2. Subtract 1 from 10 (October is the tenth month of the year):  $10 - 1 = 9$ .

Multiply 9 by 30:  $9 \times 30 = 270$ .

**-or-**

Add 17 to 270:  $270 + 17 = 287$ . Thus,  $DDD = 287$ .

### Convert the service ID to an actual date

You can use the product service ID number to determine whether the product is still under warranty. Use the following formula to convert the service ID into the installation date as follows:

1. Add 1990 to YY to get the actual year that the product was installed.
2. Divide DDD by 30. If there is a remainder, add 1 to the result. This is the month.
3. The remainder from the calculation in step 2 is the date.

Using the service ID 12287 as an example, the date conversion is as follows:

1.  $12 + 1990 = 2002$ , so the year is 2002.
2. 287 divided by 30 = 9 with a remainder of 17. Since there is a remainder, add 1 to 9 to get 10, which represents October.
3. The remainder in step 2 is 17, so that is the date.
4. The complete date is 17-October-2002.

---

 **NOTE:** A six-day grace period is built into the date system.

---

### Reset serial number

Use the service menu to reset the product serial number. See [Service mode functions on page 259](#).

### Reset page counts


The page count that is stored in NVRAM and printed on the configuration page represents the number of pages that the formatter has formatted (not including engine-test prints). If you install a new formatter when repairing a product, use this menu item to reset the page count to the previous value. In this way, the page count reflects the number of pages that the engine has printed rather than restarting the count for the new formatter.

Use the service menu item **TOTAL PAGE COUNT** to reset the product page counts. See [Service mode functions on page 259](#).

### Product cold reset

A cold reset unlocks menus that have been previously locked and sets all control panel menu items (including EIO settings) back to the factory defaults. However, it *does not* clear the values in the [Service mode functions on page 259](#) menu (such as the serial number and page counts).

---

 **NOTE:** Before performing a cold reset, print a menu map and a configuration page. Use the information on the configuration page to reset any customer-set product configuration values that the cold reset procedure changes.

---


1. Turn the product off.
2. Turn the product on. When the memory count begins, press and hold the **OK** button. Continue holding down the **OK** button until all three product control-panel lights flash once and then remain on. This might take up to 10 seconds.
3. After the message **SELECT LANGUAGE** appears on the display, press the **▲** button or the **▼** button until **COLD RESET** is highlighted.
4. Press the **OK** button. The product performs a cold reset and then continues its power-on sequence.
5. Check all I/O settings and reset any customer-set product configuration values.



# Product updates

This product has remote firmware update (RFU) capability. Use this information to upgrade the product firmware.

## Determine the current firmware version

1. Press the **Menu** button .
2. Press the down arrow ▼ to highlight the **INFORMATION** menu, and then press the **OK** button.
3. Press the down arrow ▼ to highlight the **PRINT CONFIGURATION** option, and then press the **OK** button to print.

The firmware datecode is listed on the configuration page in the section called **Device Information**. The firmware datecode has this format: YYYYMMDD XX.XXX.X.

- The first string of numbers is the date, where YYYY represents the year, MM represents the month, and DD represents the date.
- The second string of numbers is the firmware version number, in decimal format.

## Download new firmware from the HP Web site

To download the most recent firmware upgrade for the product, go to [www.hp.com/go/ljp3010series\\_firmware](http://www.hp.com/go/ljp3010series_firmware).

## Transfer the new firmware to the product

---


 **NOTE:** The product can receive an .RFU file update when it is in a **Ready** state.

---

The following conditions can affect the time required to transfer the file.

- The speed of the host computer that is sending the update.
- Any jobs that are ahead of the .RFU job in the queue are completed before the update is processed.
- If the process is interrupted before the firmware is downloaded, you must send the firmware file again.
- If power is lost during the firmware update, the update is interrupted and the message **Resend upgrade** appears (in English only) on the control-panel display. In this case, you must send the upgrade by using the USB port.

---


 **NOTE:** The firmware update involves a change in the format of nonvolatile random-access memory (NVRAM). Any menu settings that are changed from the default settings might return to default settings and must be changed again if you want settings that are different from the defaults.

---

## Use the flash executable file to update the firmware

This product has flash-based memory, so you can use the flash firmware executable (.EXE) file to upgrade the firmware. Download this file from [www.hp.com/go/ljp3010series\\_firmware](http://www.hp.com/go/ljp3010series_firmware).

---

 **NOTE:** To use this method, connect the product directly to your computer through a USB cable, and install the printer driver for this product on your computer.

---

1. Print a configuration page and note the TCP/IP address.
2. Find the .EXE file on your computer, and double-click it to open the file.
3. From the **Select Printer to Update** drop-down list, select this product. Click the **Start** button to begin the update process.

---

△ **CAUTION:** Do not turn the product off or try to send a print job during this process.


---

4. When the process is complete, a smiling face icon displays in the dialog box. Click the **Exit** button.
5. Turn the product off and then on.
6. Print another configuration page and verify that the new firmware datecode is listed.

### Use FTP to upload the firmware through a browser

1. Make sure the Internet browser you are using is configured for viewing folders from FTP sites. These instructions are for Microsoft Internet Explorer.
  - a. Open the browser and click the **Tools** menu, and then click the **Internet Options** menu item.
  - b. Click the **Advanced** tab.
  - c. Select the box labeled **Enable folder view for FTP sites**.
  - d. Click the **OK** button.
2. Print a configuration page and note the TCP/IP address.
3. Open a browser window.
4. In the address line of the browser, type `ftp://<ADDRESS>`, where <ADDRESS> is the address of the product. For example, if the TCP/IP address is 192.168.0.90, type `ftp://192.168.0.90`.
5. Locate the downloaded .RFU file for the product.
6. Drag and drop the .RFU file onto the **PORT** icon in the browser window.

---


 **NOTE:** The product turns off and then on automatically to activate the update. When the update process is complete, a **Ready** message displays on the product control panel.

---

### Use FTP to upgrade the firmware on a network connection


1. Take note of the IP address on the HP Jetdirect page. The HP Jetdirect page is the second page that prints when you print the configuration page.

---

 **NOTE:** Before upgrading the firmware, make sure that any error messages are cleared from the control-panel display.

---


2. Click the **Start** button, click the **Run** menu item, and then type `cmd` to open the command window.
3. Type `ftp <TCP/IP ADDRESS>`. For example, if the TCP/IP address is 192.168.0.90, type `ftp 192.168.0.90`.

4. Go to the folder where the firmware file is stored.
  5. Press the **Enter** key on the keyboard.
  6. When prompted for the user name, press the **Enter** key.
  7. When prompted for the password, press the **Enter** key.
  8. Type `bin` at the command prompt.
  9. Press the **Enter** key. The message **200 Types set to I, Using binary mode to transfer files** appears in the command window.
  10. Type `put` and then the file name. For example, if the file name is `ljp3015.rfu`, type `put ljp3015.rfu`.
  11. The download process begins and the firmware is updated on the product. This can take several minutes. Let the process finish without further interaction with the product or computer.
- 
-  **NOTE:** The product automatically turns off and then on again after processing the upgrade.
- 
12. At the command prompt, type `bye` to exit the `ftp` command.
  13. At the command prompt, type `exit` to return to the Windows interface.


## Use HP Web Jetadmin to upgrade the firmware

To learn how to use HP Web Jetadmin to upgrade the product firmware, go to [www.hp.com/go/webjetadmin](http://www.hp.com/go/webjetadmin).

## Use Microsoft Windows commands to upgrade the firmware

 **NOTE:** This process requires the product to be shared on a network.

1. Click the **Start** button, click the **Run** menu item, and then type `cmd` to open the command window.
2. Type the following: `copy /B <FILENAME> \\<COMPUTERNAME>\<SHARENAME>`, where `<FILENAME>` is the name of the .RFU file (including the path), `<COMPUTERNAME>` is the name of the computer from which the product is being shared, and `<SHARENAME>` is the product share name. For example: `C:\>copy /b C:\ljp3015.rfu \\YOUR_SERVER\YOUR_COMPUTER`.

 **NOTE:** If the file name or path includes a space, you must enclose the file name or path in quotation marks. For example, type: `C:\>copy /b "C:\MY DOCUMENTS\ljp3015.rfu" \\YOUR_SERVER\YOUR_COMPUTER`.

3. Press the **Enter** key on the keyboard. The control panel shows a message that indicates the progress of the firmware upgrade. At the end of the upgrade process, the control panel shows the **Ready** message. The message **One File Copied** appears on the computer screen.

## Upgrade the HP Jetdirect firmware

The HP Jetdirect network interface in the product has firmware that can be upgraded separately from the product firmware. This procedure requires that you install HP Web Jetadmin Version 7.0 or later on

your computer. See the product user guide for more information. Complete the following steps to update the HP Jetdirect firmware by using HP Web Jetadmin.

1. Open the HP Web Jetadmin program.
2. Open the **Device Management** folder in the drop-down list in the **Navigation** panel. Navigate to the **Device Lists** folder.
3. Select the product that you want to update.
4. In the **Device Tools** drop-down list, select the **Jetdirect Firmware Update** option.
5. Under the **Jetdirect Firmware Version** heading the HP Jetdirect model number and current firmware version are listed. Make a note of these.
6. Go to [www.hp.com/go/wja\\_firmware](http://www.hp.com/go/wja_firmware).
7. Scroll down to the list of HP Jetdirect model numbers, and find the model number you wrote down.
8. Look at the current firmware version for the model, and see if it is later than the version you wrote down. If it is, right-click on the firmware link, and follow the instructions on the Web page to download the new firmware file. The file must be saved into the <drive>:\PROGRAM FILES\HP WEB JETADMIN\DOC\PLUGINS\HPWJA\FIRMWARE\JETDIRECT folder on the computer that is running the HP Web Jetadmin software.
9. In HP Web Jetadmin, return to the main product list and select the digital sender again.
10. In the **Device Tools** drop-down list, select the **Jetdirect Firmware Update** option again.
11. On the HP Jetdirect firmware page, the new firmware version is listed under the **Jetdirect Firmware Available on HP Web Jetadmin** heading. Click the **Update Firmware Now** button to update the Jetdirect firmware.

---

 **NOTE:** You also can use FTP or the HP Embedded Web Server to update the HP Jetdirect firmware. For more information, go to [www.hp.com/go/wja\\_firmware](http://www.hp.com/go/wja_firmware).

---

---

## 4 Parts and diagrams

- [Order parts by authorized service providers](#)
- [How to use the parts lists and diagrams](#)
- [Assembly locations](#)
- [Covers](#)
- [Internal assemblies \(1 of 6\)](#)
- [Internal assemblies \(2 of 6\)](#)
- [Internal assemblies \(3 of 6\)](#)
- [Internal assemblies \(4 of 6\)](#)
- [Internal assemblies \(5 of 6\)](#)
- [Internal assemblies \(6 of 6\)](#)
- [Input devices](#)
- [Alphabetical parts list](#)
- [Numerical parts list](#)

# Order parts by authorized service providers

## Order parts, accessories, and supplies

**Table 4-1 Order parts, accessories, and supplies**

Order supplies and paper	<a href="http://www.hp.com/go/suresupply">www.hp.com/go/suresupply</a>
Order genuine HP parts or accessories	<a href="http://www.hp.com/buy/parts">www.hp.com/buy/parts</a>
Order through service or support providers	Contact an HP-authorized service or support provider.
Order using HP software	For information about using the HP software to order parts, accessories, and supplies, see the product user guide.

## Related documentation and software

**Table 4-2 Related documentation and software**

Item	Description	Part number
<i>HP LaserJet P3010 Series Printers User Guide</i>	Product user guide.	CE524-90910
<i>HP LaserJet P3010 Series Printers Service Manual</i>	English service manual (this manual)	CE544-90909

## Supplies part numbers

**Table 4-3 Supplies part numbers**

Item	Description	Part number
HP LaserJet print cartridge	Standard-capacity cartridge	CE255A (new)
		CE225-67901 (service)
	High-capacity cartridge	CE255X (new)
		CE255-67902 (service)

## Accessories part numbers

**Table 4-4 Accessories part numbers**

Item	Description	Part number
144 x 32-pin DDR2 memory DIMM (dual inline memory module)	64 MB	CC413A (new) CE524-67901 (kit) <b>NOTE:</b> The kit includes the DIMM and installation instructions.
	128 MB	CC414A (new) CE524-67902 (kit) <b>NOTE:</b> The kit includes the DIMM and installation instructions.
	256 MB	CC415A (new) CE524-67903 (kit) <b>NOTE:</b> The kit includes the DIMM and installation instructions.
	512 MB	CE483A (new) CE524-67904 (kit) <b>NOTE:</b> The kit includes the DIMM and installation instructions.
Formatter PCA	Base product	CE474-67901 (new) CE474-69001 (exchange)
	Network product	CE475-67901 (new) CE475-69001 (exchange)
HP Encrypted High Performance hard disk	Encrypted hard disk to install in the EIO accessory slot	J8019A (new) CE525-69003 (kit)
	63 mm (2.5 in)	<b>NOTE:</b> The kit includes the hard disk and installation instructions.
Optional 500-sheet tray and feeder unit	Optional tray to increase paper capacity.	CE530A (new)
	The product can accommodate up to two optional 500-sheet feeders.	CE530-69001 (service)

**Table 4-4 Accessories part numbers (continued)**

Item	Description	Part number	
Enhanced I/O (EIO) cards	HP High Performance Serial ATA EIO Hard Disk	J6073G	
HP Jetdirect print server multi-protocol EIO network cards	1284B parallel adaptor	J7972G	
	Jetdirect EIO wireless 690n (IPv6/IPsec )	J8007G	
	Jetdirect en3700	J7942G	
	Jetdirect en1700	J7988G	
	Jetdirect ew2400 USB wireless print server	J7951G	
	Jetdirect 630n EIO networking card (IPv6/gigabit)	J7997G	
	Jetdirect 635n EIO networking card (IPv6/IPsec )	J7961G	
Service maintenance kit	Maintenance kit includes the following items:	110V: CE525-67901 220V: CE525-67902	
	<ul style="list-style-type: none"> <li>● Fuser for the appropriate voltage rating</li> <li>● Transfer roller</li> <li>● Tray 1 pickup roller</li> <li>● Tray 1 separation pad</li> <li>● Tray 2 pickup roller</li> <li>● Tray 2 separation pad</li> </ul>		
	USB cable	2-meter A-to-B cable	C6518A

## Whole-unit replacement part numbers

**Table 4-5 Whole-unit replacement part numbers**

Item	Description	Part number
HP LaserJet P3015	110V	CE525-69001
	220V	CE525-69002
HP LaserJet P3015d	110V	CE526-69001
	220V	CE526-69002
HP LaserJet P3015dn	110V	CE528-69001
	220V	CE528-69002
HP LaserJet P3015x	110V	CE529-69001
	220V	CE529-69002



## How to use the parts lists and diagrams

---

△ **CAUTION:** Be sure to order the correct part. When looking for part numbers for electrical components, pay careful attention to the voltage that is listed. Doing so will make sure that the part number selected is for the correct model.

📄 **NOTE:** In this manual, the abbreviation “PCA” stands for “printed circuit-board assembly.” Components described as a PCA might consist of a single circuit board or a circuit board plus other parts, such as cables and sensors.

---

The figures in this chapter show the major subassemblies in the product and their component parts. A parts list table follows each exploded view assembly diagram. Each table lists the item number, the associated part number, and the description of each part. If a part is not listed in the table, then it is not a field replacement unit (FRU).

# Assembly locations

## Base product (no optional trays or accessories)

Figure 4-1 Base product (no optional trays or accessories)

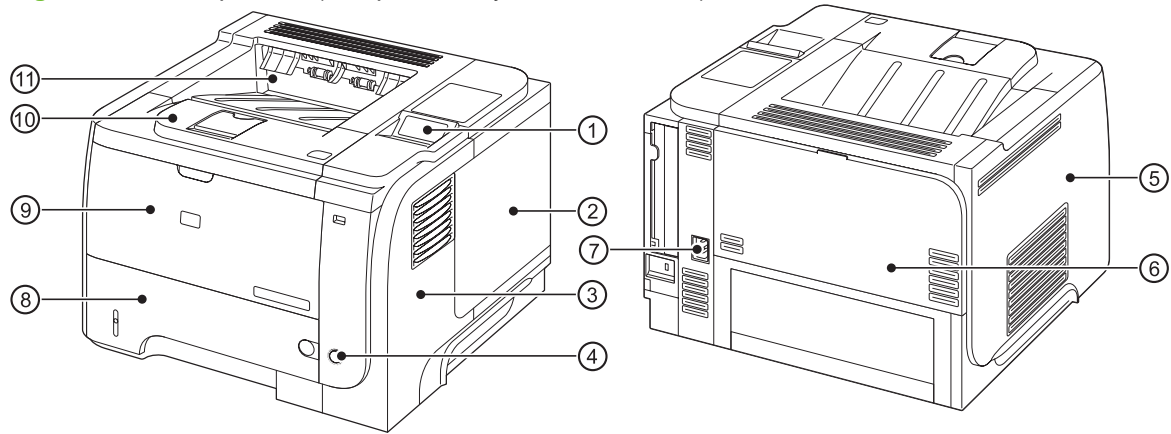


Table 4-6 Base product

Item	Description	Item	Description
1	Control panel	7	Power receptacle
2	DIMM cover	8	Tray 2 cassette
3	Front-right and right-side cover assembly	9	Tray 1 (multipurpose tray)
4	Power switch	10	Cartridge-door assembly (print-cartridge door)
5	Left cover	11	Output bin (face-down tray)
6	Rear-door assembly		

## Base product (optional trays or accessories)

Figure 4-2 Base product (optional trays or accessories)

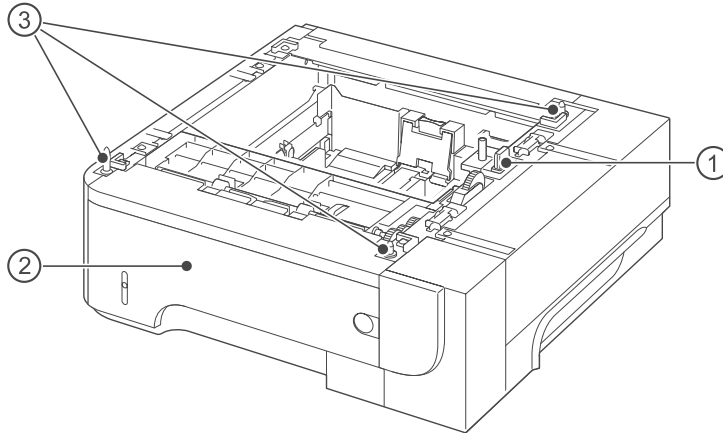
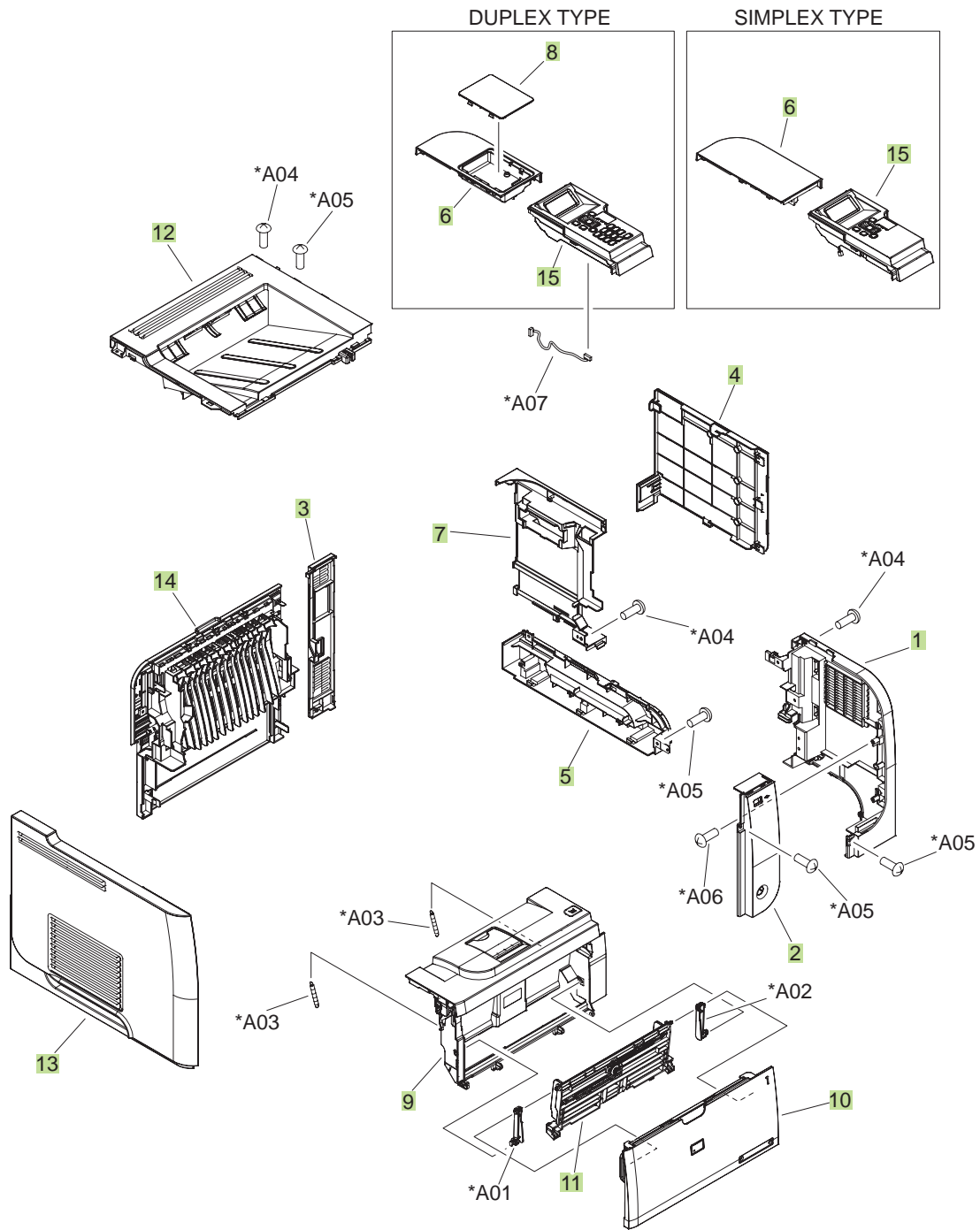


Table 4-7 Optional 500-sheet input tray

Item	Description
1	Connector
2	Tray 3 or Tray 4 cassette
3	Positioning pin

# Covers

Figure 4-3 Covers

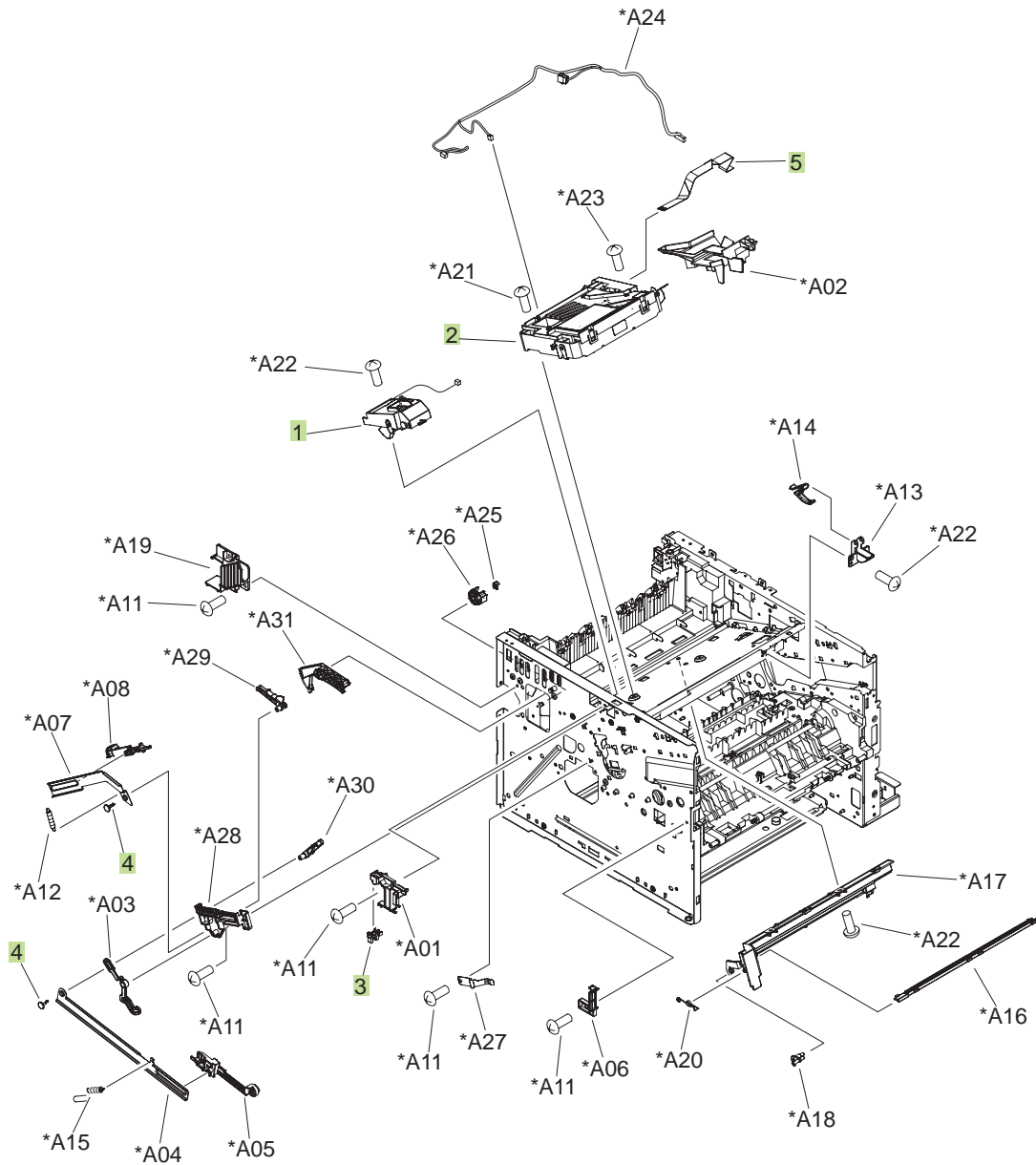


**Table 4-8 Covers**

<b>Ref</b>	<b>Description</b>	<b>Part number</b>	<b>Qty</b>
1	Cover, right	RC2-7670-000CN	1
2	Cover, right-front	RC2-7672-000CN	1
3	Cover, right-rear	RC2-7673-000CN	1
4	Cover, DIMM	RC2-7674-000CN	1
5	Cover, handle right	RC2-7675-000CN	1
6	Cover, upper-right (top-right); duplex models	RC2-7676-000CN	1
6	Cover, upper-right (top-right); simplex models	RC2-7707-000CN	1
7	Cover, formatter	RC2-7688-000CN	1
8	Cover, upper-right (top-right) sub; duplex models	RC2-7677-000CN	1
9	Cartridge-door assembly	RM1-6264-000CN	1
10	Cover, multipurpose assembly	RM1-6265-000CN	1
11	Multipurpose lifting plate assembly	RM1-6266-000CN	1
12	Cover, top assembly	RM1-6289-000CN	1
13	Cover, left	RM1-6291-000CN	1
14	Cover, rear assembly	RM1-6292-000CN	1
15	Control panel; duplex models	RM1-6518-000CN	1
15	Control panel; duplex models	RM1-6519-000CN	1

# Internal assemblies (1 of 6)

Figure 4-4 Internal assemblies (1 of 6)

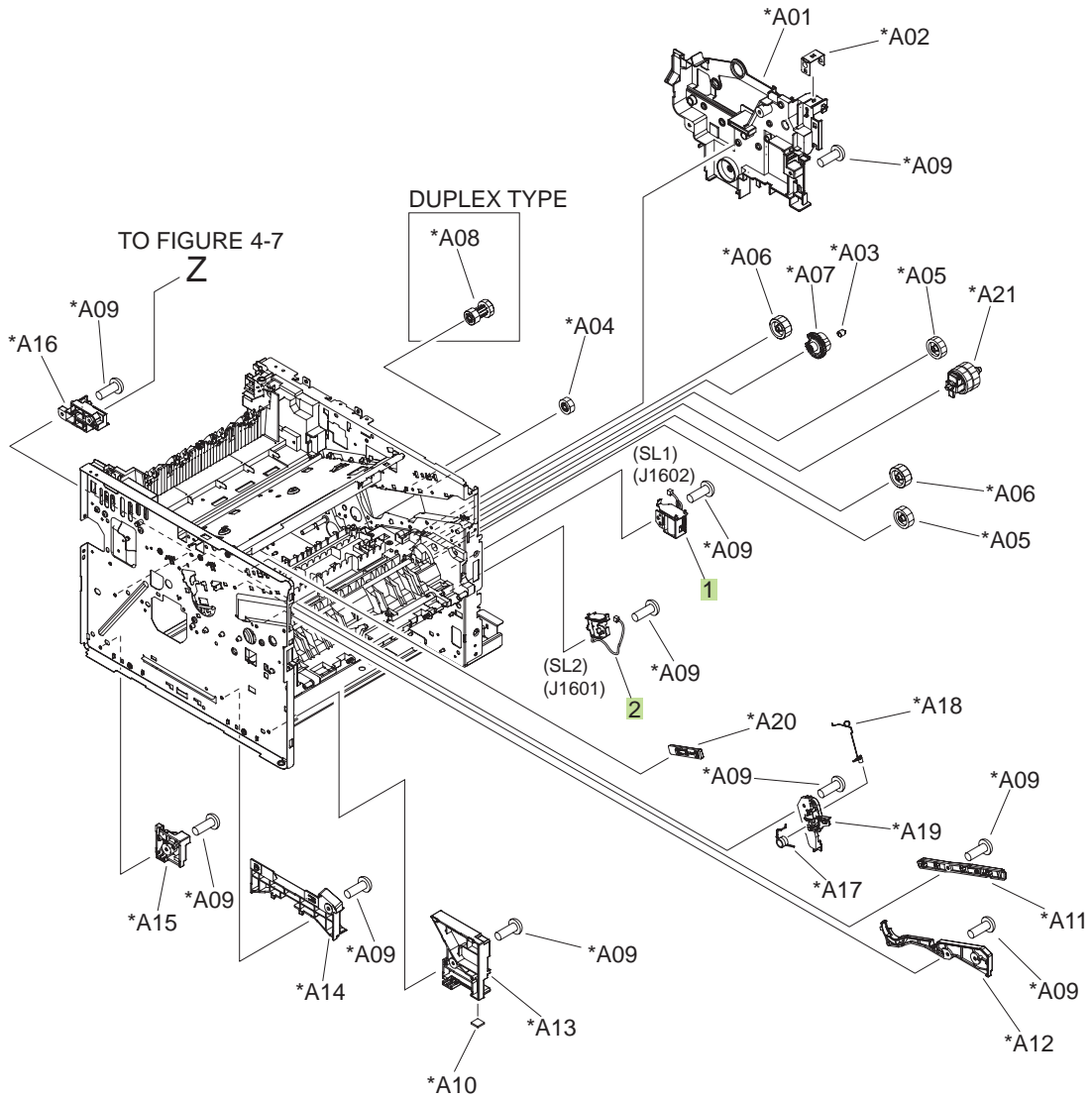


**Table 4-9 Internal assemblies (1 of 6)**

<b>Ref</b>	<b>Description</b>	<b>Part number</b>	<b>Qty</b>
1	Tag holder assembly	RM1-6284-000CN	1
2	Laser/scanner	RM1-6322-000CN	1
3	Photo interrupter, TLP1243	WG8-5696-000CN	1
4	Stopper, bushing arm	RC2-7933-000CN	2
5	Cable, flat	RK2-3103-000CN	1

# Internal assemblies (2 of 6)

Figure 4-5 Internal assemblies (2 of 6)



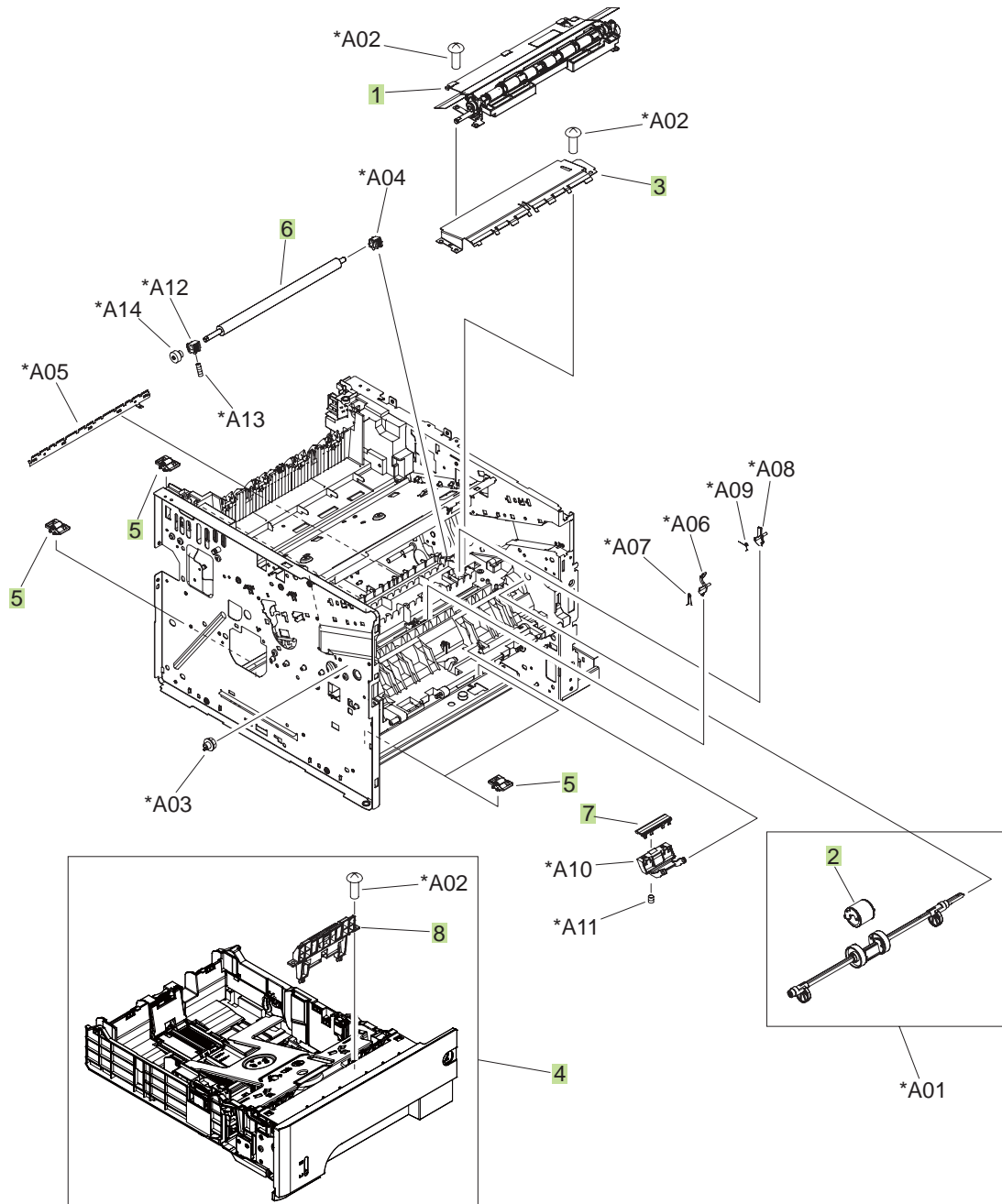


**Table 4-10 Internal assemblies (2 of 6)**

<b>Ref</b>	<b>Description</b>	<b>Part number</b>	<b>Qty</b>
1	Tray 1 solenoid	RK2-1490-000CN	1
2	Tray 2 solenoid	RK2-1492-000CN	1

# Internal assemblies (3 of 6)

Figure 4-6 Internal assemblies (3 of 6)

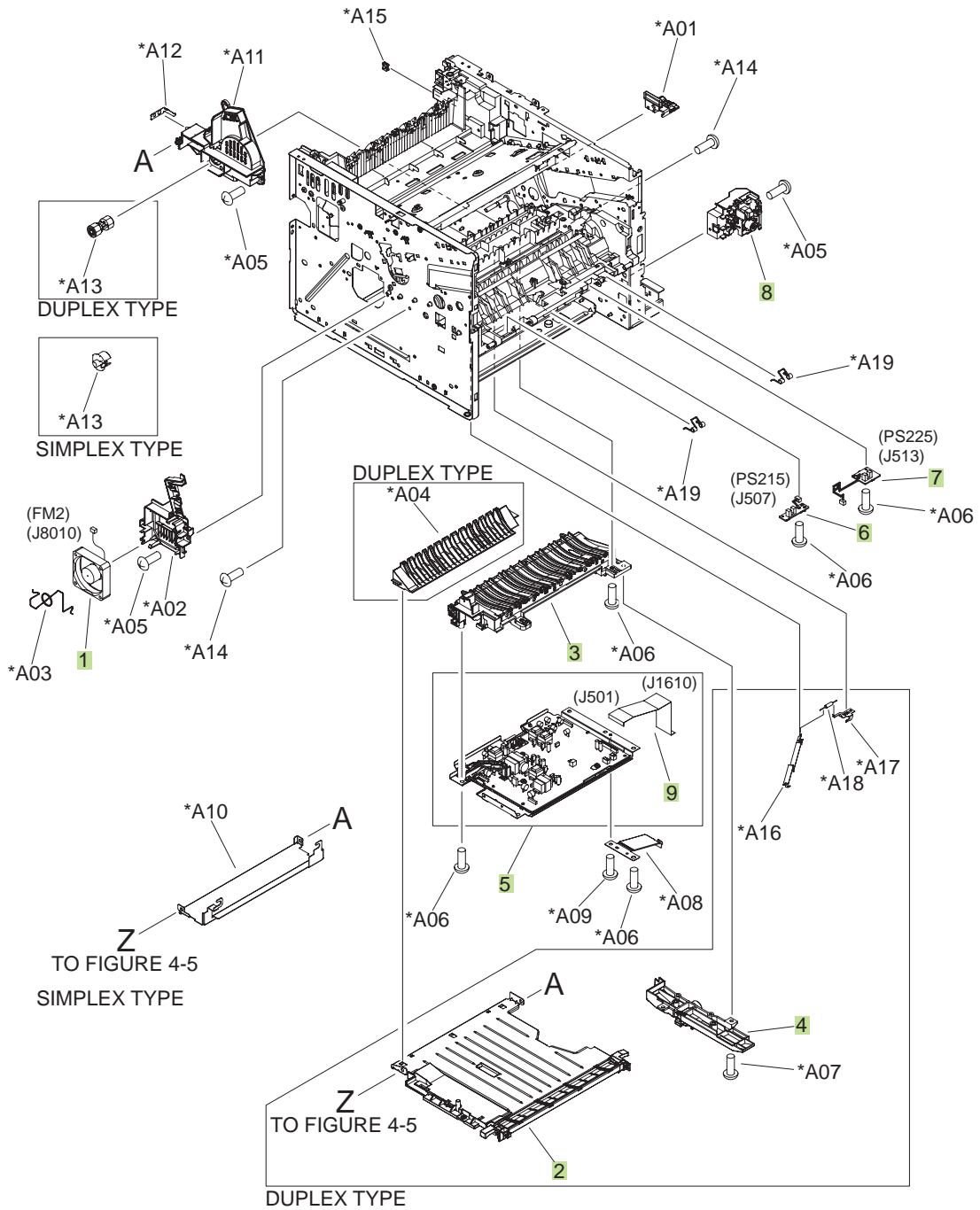


**Table 4-11 Internal assemblies (3 of 6)**

Ref	Description	Part number	Qty
1	Registration roller assembly	RM1-6272-000CN	1
2	Roller, multipurpose	RL1-2412-000CN	1
3	Transfer lower guide assembly	RM1-6315-000CN	1
4	Cassette	RM1-6279-000CN	1
5	Base plate roller assembly	RM1-6306-000CN	4
6	Roller, transfer	RM1-6321-000CN	1
7	Pad, multipurpose separation	RC2-8575-000CN	1
8	Separation holder assembly	RM1-6303-000CN	1

# Internal assemblies (4 of 6)

Figure 4-7 Internal assemblies (4 of 6)

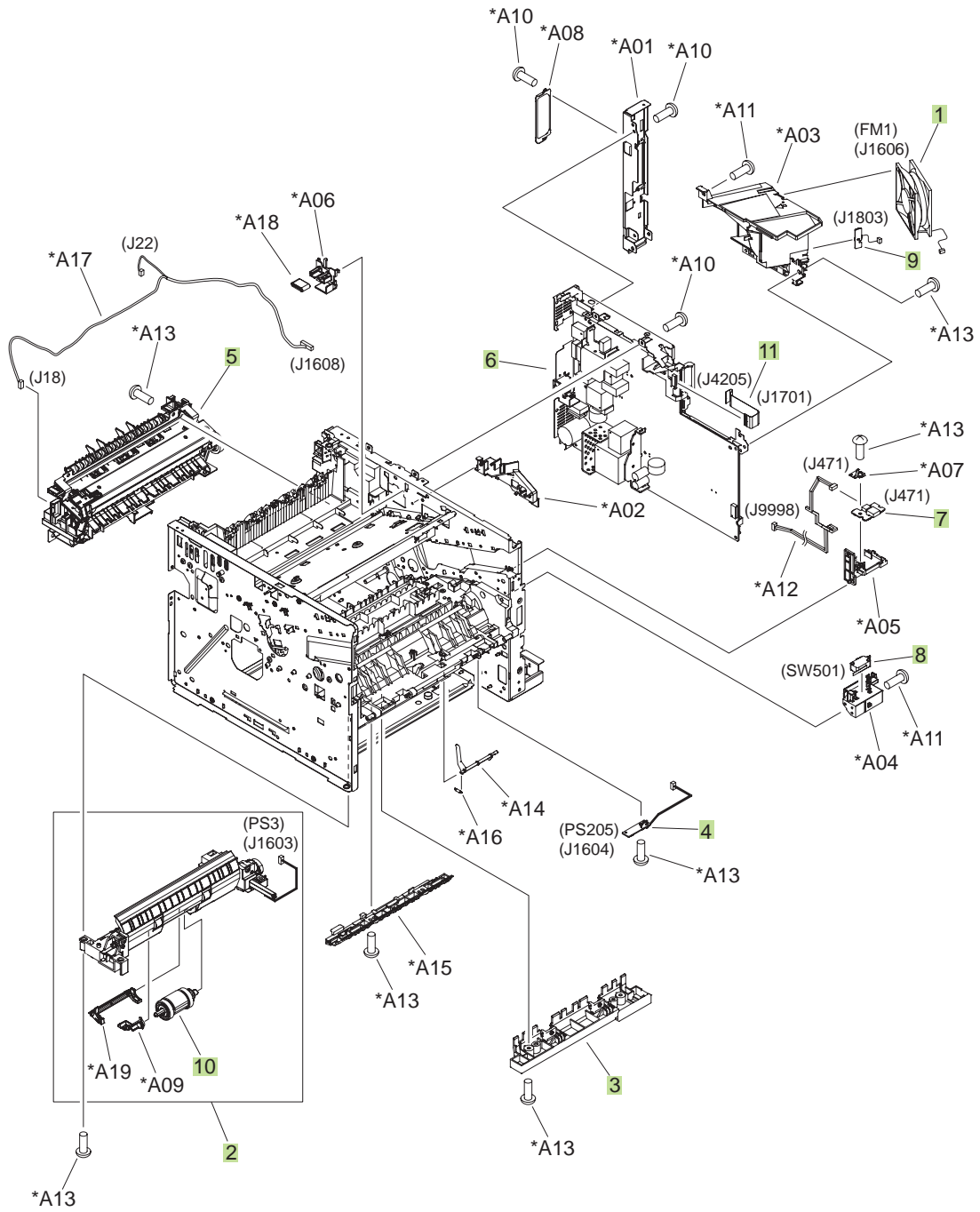


**Table 4-12 Internal assemblies (4 of 6)**

Ref	Description	Part number	Qty
1	Fan, sub	RK2-1499-000CN	1
2	Lower paper feed guide; duplex models	RM1-6263-000CN	1
3	Paper-feed guide assembly	RM1-6270-000CN	1
4	Position-guide assembly; duplex models	RM1-6273-000CN	1
5	High-voltage power supply; duplex models	RM1-6280-000CN	1
5	High-voltage power supply; simplex models	RM1-6300-000CN	1
6	TOP sensor PCA	RM1-6511-000CN	1
7	Paper width sensor PCA	RM1-6512-000CN	1
8	Switch assembly, power	RM1-6283-000CN	1
9	Cable, flat	RK2-3101-000CN	1

# Internal assemblies (5 of 6)

Figure 4-8 Internal assemblies (5 of 6)

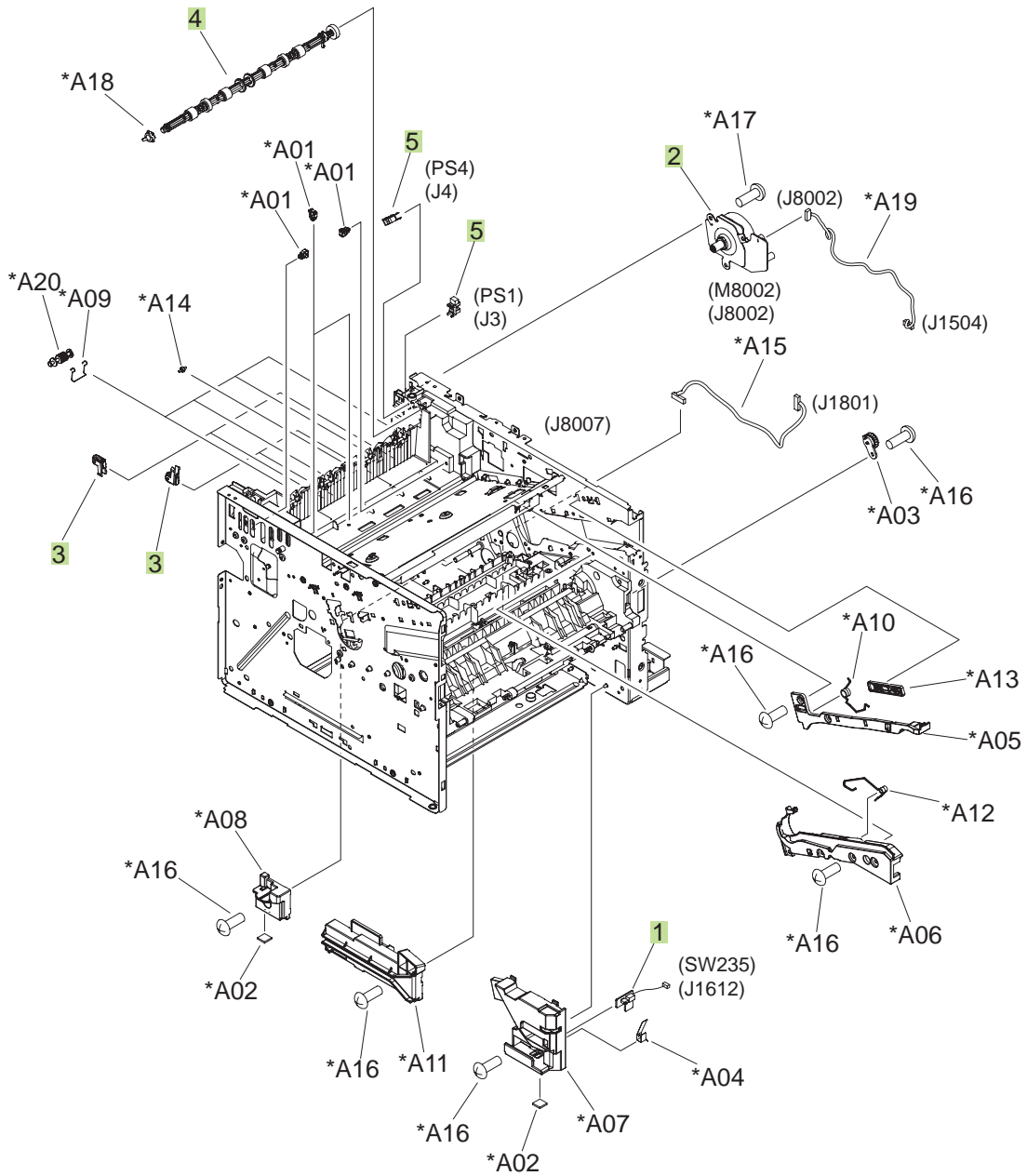


**Table 4-13 Internal assemblies (5 of 6)**

Ref	Description	Part number	Qty
1	Fan, main	RK2-1497-000CN	1
2	Cassette, paper pickup assembly; duplex models	RM1-6268-000CN	1
2	Cassette, paper pickup assembly; simplex models	RM1-6299-000CN	1
3	Idler roller assembly	RM1-6271-000CN	1
4	Multipurpose sensor PCA	RM1-6510-000CN	1
5	Fuser assembly 110V	RM1-6274-000CN	1
5	Fuser assembly 220V	RM1-6319-000CN	1
6	Engine controller PCA 110V	RM1-6281-000CN	1
6	Engine controller PCA 220V	RM1-6318-000CN	1
7	Front USB PCA	RM1-6514-000CN	1
8	Microswitch	WC4-5171-000CN	1
9	Environmental sensor assembly	RM1-6515-000CN	2
10	Cassette pickup roller	RM1-6313-000CN	1
11	Cable, flat	RK2-2788-000CN	1

# Internal assemblies (6 of 6)

Figure 4-9 Internal assemblies (6 of 6)





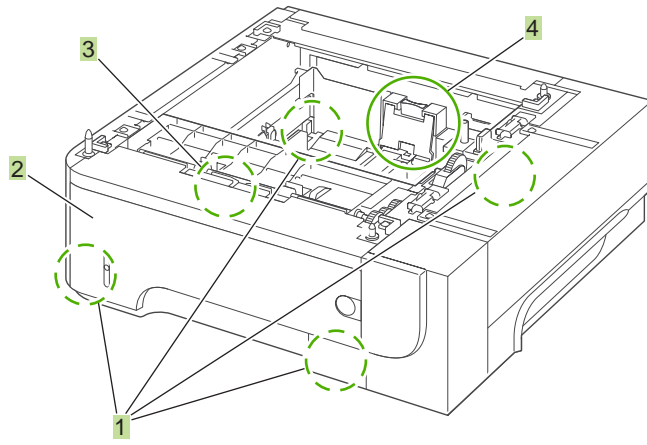
**Table 4-14 Internal assemblies (6 of 6)**

Ref	Description	Part number	Qty
1	Tray sensor PCA	RM1-6487-000CN	1
2	Fuser motor assembly	RM1-6296-000CN	1
3	Paper delivery roller assembly	RM1-6301-000CN	4
4	Face-down roller assembly	RM1-6311-000CN	1
5	Photo interrupter, TLP1243	WG8-5696-000CN	2

# Input devices

## 500-sheet input tray (Tray 3 and Tray 4)

Figure 4-10 500-sheet input tray (Tray 3 and Tray 4)



**Table 4-15 500-sheet input tray (Tray 3 and Tray 4)**

Ref	Description	Part number	Qty
	Optional 500-sheet tray and feeder unit	CE530-69001	1
1	Base plate roller assembly	RM1-6306-000CN	4
2	Cassette	RM1-6279-000CN	1
3	Pickup roller set, cassette	RM1-6313-000CN	1
4	Separation holder assembly	RM1-6303-000CN	1

# Alphabetical parts list

**Table 4-16 Alphabetical parts list**

Description	Part number	Table and page
Base plate roller assembly	RM1-6306-000CN	<a href="#">Internal assemblies (3 of 6) on page 281</a>
Base plate roller assembly	RM1-6306-000CN	<a href="#">500-sheet input tray (Tray 3 and Tray 4) on page 289</a>
Cable, flat	RK2-3103-000CN	<a href="#">Internal assemblies (1 of 6) on page 277</a>
Cable, flat	RK2-3101-000CN	<a href="#">Internal assemblies (4 of 6) on page 283</a>
Cable, flat	RK2-2788-000CN	<a href="#">Internal assemblies (5 of 6) on page 285</a>
Cartridge-door assembly	RM1-6264-000CN	<a href="#">Covers on page 275</a>
Cassette	RM1-6279-000CN	<a href="#">Internal assemblies (3 of 6) on page 281</a>
Cassette	RM1-6279-000CN	<a href="#">500-sheet input tray (Tray 3 and Tray 4) on page 289</a>
Cassette pickup roller	RM1-6313-000CN	<a href="#">Internal assemblies (5 of 6) on page 285</a>
Cassette, paper pickup assembly; duplex models	RM1-6268-000CN	<a href="#">Internal assemblies (5 of 6) on page 285</a>
Cassette, paper pickup assembly; simplex models	RM1-6299-000CN	<a href="#">Internal assemblies (5 of 6) on page 285</a>
Control panel; duplex models	RM1-6518-000CN	<a href="#">Covers on page 275</a>
Control panel; duplex models	RM1-6519-000CN	<a href="#">Covers on page 275</a>
Cover, DIMM	RC2-7674-000CN	<a href="#">Covers on page 275</a>
Cover, formatter	RC2-7688-000CN	<a href="#">Covers on page 275</a>
Cover, handle right	RC2-7675-000CN	<a href="#">Covers on page 275</a>
Cover, left	RM1-6291-000CN	<a href="#">Covers on page 275</a>
Cover, multipurpose assembly	RM1-6265-000CN	<a href="#">Covers on page 275</a>
Cover, rear assembly	RM1-6292-000CN	<a href="#">Covers on page 275</a>
Cover, right	RC2-7670-000CN	<a href="#">Covers on page 275</a>
Cover, right-front	RC2-7672-000CN	<a href="#">Covers on page 275</a>
Cover, right-rear	RC2-7673-000CN	<a href="#">Covers on page 275</a>
Cover, top assembly	RM1-6289-000CN	<a href="#">Covers on page 275</a>
Cover, upper-right (top-right) sub; duplex models	RC2-7677-000CN	<a href="#">Covers on page 275</a>
Cover, upper-right (top-right); duplex models	RC2-7676-000CN	<a href="#">Covers on page 275</a>
Cover, upper-right (top-right); simplex models	RC2-7707-000CN	<a href="#">Covers on page 275</a>

**Table 4-16 Alphabetical parts list (continued)**

Description	Part number	Table and page
Engine controller PCA 110V	RM1-6281-000CN	<a href="#">Internal assemblies (5 of 6) on page 285</a>
Engine controller PCA 220V	RM1-6318-000CN	<a href="#">Internal assemblies (5 of 6) on page 285</a>
Environmental sensor assembly	RM1-6515-000CN	<a href="#">Internal assemblies (5 of 6) on page 285</a>
Face-down roller assembly	RM1-6311-000CN	<a href="#">Internal assemblies (6 of 6) on page 287</a>
Fan, main	RK2-1497-000CN	<a href="#">Internal assemblies (5 of 6) on page 285</a>
Fan, sub	RK2-1499-000CN	<a href="#">Internal assemblies (4 of 6) on page 283</a>
Front USB PCA	RM1-6514-000CN	<a href="#">Internal assemblies (5 of 6) on page 285</a>
Fuser assembly 110V	RM1-6274-000CN	<a href="#">Internal assemblies (5 of 6) on page 285</a>
Fuser assembly 220V	RM1-6319-000CN	<a href="#">Internal assemblies (5 of 6) on page 285</a>
Fuser motor assembly	RM1-6296-000CN	<a href="#">Internal assemblies (6 of 6) on page 287</a>
High-voltage power supply; duplex models	RM1-6280-000CN	<a href="#">Internal assemblies (4 of 6) on page 283</a>
High-voltage power supply; simplex models	RM1-6300-000CN	<a href="#">Internal assemblies (4 of 6) on page 283</a>
Idler roller assembly	RM1-6271-000CN	<a href="#">Internal assemblies (5 of 6) on page 285</a>
Laser/scanner	RM1-6322-000CN	<a href="#">Internal assemblies (1 of 6) on page 277</a>
Lower paper feed guide; duplex models	RM1-6263-000CN	<a href="#">Internal assemblies (4 of 6) on page 283</a>
Microswitch	WC4-5171-000CN	<a href="#">Internal assemblies (5 of 6) on page 285</a>
Multipurpose lifting plate assembly	RM1-6266-000CN	<a href="#">Covers on page 275</a>
Multipurpose sensor PCA	RM1-6510-000CN	<a href="#">Internal assemblies (5 of 6) on page 285</a>
Optional 500-sheet tray and feeder unit	CE530-69001	<a href="#">500-sheet input tray (Tray 3 and Tray 4) on page 289</a>
Pad, multipurpose separation	RC2-8575-000CN	<a href="#">Internal assemblies (3 of 6) on page 281</a>
Paper delivery roller assembly	RM1-6301-000CN	<a href="#">Internal assemblies (6 of 6) on page 287</a>
Paper width sensor PCA	RM1-6512-000CN	<a href="#">Internal assemblies (4 of 6) on page 283</a>

**Table 4-16 Alphabetical parts list (continued)**

Description	Part number	Table and page
Paper-feed guide assembly	RM1-6270-000CN	<a href="#">Internal assemblies (4 of 6) on page 283</a>
Photo interrupter, TLP1243	WG8-5696-000CN	<a href="#">Internal assemblies (1 of 6) on page 277</a>
Photo interrupter, TLP1243	WG8-5696-000CN	<a href="#">Internal assemblies (6 of 6) on page 287</a>
Pickup roller set, cassette	RM1-6313-000CN	<a href="#">500-sheet input tray (Tray 3 and Tray 4) on page 289</a>
Position-guide assembly; duplex models	RM1-6273-000CN	<a href="#">Internal assemblies (4 of 6) on page 283</a>
Registration roller assembly	RM1-6272-000CN	<a href="#">Internal assemblies (3 of 6) on page 281</a>
Roller, multipurpose	RL1-2412-000CN	<a href="#">Internal assemblies (3 of 6) on page 281</a>
Roller, transfer	RM1-6321-000CN	<a href="#">Internal assemblies (3 of 6) on page 281</a>
Separation holder assembly	RM1-6303-000CN	<a href="#">Internal assemblies (3 of 6) on page 281</a>
Separation holder assembly	RM1-6303-000CN	<a href="#">500-sheet input tray (Tray 3 and Tray 4) on page 289</a>
Stopper, bushing arm	RC2-7933-000CN	<a href="#">Internal assemblies (1 of 6) on page 277</a>
Switch assembly, power	RM1-6283-000CN	<a href="#">Internal assemblies (4 of 6) on page 283</a>
Tag holder assembly	RM1-6284-000CN	<a href="#">Internal assemblies (1 of 6) on page 277</a>
TOP sensor PCA	RM1-6511-000CN	<a href="#">Internal assemblies (4 of 6) on page 283</a>
Transfer lower guide assembly	RM1-6315-000CN	<a href="#">Internal assemblies (3 of 6) on page 281</a>
Tray sensor PCA	RM1-6487-000CN	<a href="#">Internal assemblies (6 of 6) on page 287</a>
Tray 1 solenoid	RK2-1490-000CN	<a href="#">Internal assemblies (2 of 6) on page 279</a>
Tray 2 solenoid	RK2-1492-000CN	<a href="#">Internal assemblies (2 of 6) on page 279</a>

# Numerical parts list

**Table 4-17 Numerical parts list**

Part number	Description	Table and page
CE530-69001	Optional 500-sheet tray and feeder unit	<a href="#">500-sheet input tray (Tray 3 and Tray 4) on page 289</a>
RC2-7670-000CN	Cover, right	<a href="#">Covers on page 275</a>
RC2-7672-000CN	Cover, right-front	<a href="#">Covers on page 275</a>
RC2-7673-000CN	Cover, right-rear	<a href="#">Covers on page 275</a>
RC2-7674-000CN	Cover, DIMM	<a href="#">Covers on page 275</a>
RC2-7675-000CN	Cover, handle right	<a href="#">Covers on page 275</a>
RC2-7676-000CN	Cover, upper-right (top-right); duplex models	<a href="#">Covers on page 275</a>
RC2-7677-000CN	Cover, upper-right (top-right) sub; duplex models	<a href="#">Covers on page 275</a>
RC2-7688-000CN	Cover, formatter	<a href="#">Covers on page 275</a>
RC2-7707-000CN	Cover, upper-right (top-right); simplex models	<a href="#">Covers on page 275</a>
RC2-7933-000CN	Stopper, bushing arm	<a href="#">Internal assemblies (1 of 6) on page 277</a>
RC2-8575-000CN	Pad, multipurpose separation	<a href="#">Internal assemblies (3 of 6) on page 281</a>
RK2-1490-000CN	Tray 1 solenoid	<a href="#">Internal assemblies (2 of 6) on page 279</a>
RK2-1492-000CN	Tray 2 solenoid	<a href="#">Internal assemblies (2 of 6) on page 279</a>
RK2-1497-000CN	Fan, main	<a href="#">Internal assemblies (5 of 6) on page 285</a>
RK2-1499-000CN	Fan, sub	<a href="#">Internal assemblies (4 of 6) on page 283</a>
RK2-2788-000CN	Cable, flat	<a href="#">Internal assemblies (5 of 6) on page 285</a>
RK2-3101-000CN	Cable, flat	<a href="#">Internal assemblies (4 of 6) on page 283</a>
RK2-3103-000CN	Cable, flat	<a href="#">Internal assemblies (1 of 6) on page 277</a>
RL1-2412-000CN	Roller, multipurpose	<a href="#">Internal assemblies (3 of 6) on page 281</a>
RM1-6263-000CN	Lower paper feed guide; duplex models	<a href="#">Internal assemblies (4 of 6) on page 283</a>
RM1-6264-000CN	Cartridge-door assembly	<a href="#">Covers on page 275</a>
RM1-6265-000CN	Cover, multipurpose assembly	<a href="#">Covers on page 275</a>
RM1-6266-000CN	Multipurpose lifting plate assembly	<a href="#">Covers on page 275</a>
RM1-6268-000CN	Cassette, paper pickup assembly; duplex models	<a href="#">Internal assemblies (5 of 6) on page 285</a>

**Table 4-17 Numerical parts list (continued)**

Part number	Description	Table and page
RM1-6270-000CN	Paper-feed guide assembly	<a href="#">Internal assemblies (4 of 6) on page 283</a>
RM1-6271-000CN	Idler roller assembly	<a href="#">Internal assemblies (5 of 6) on page 285</a>
RM1-6272-000CN	Registration roller assembly	<a href="#">Internal assemblies (3 of 6) on page 281</a>
RM1-6273-000CN	Position-guide assembly; duplex models	<a href="#">Internal assemblies (4 of 6) on page 283</a>
RM1-6274-000CN	Fuser assembly 110V	<a href="#">Internal assemblies (5 of 6) on page 285</a>
RM1-6279-000CN	Cassette	<a href="#">Internal assemblies (3 of 6) on page 281</a>
RM1-6279-000CN	Cassette	<a href="#">500-sheet input tray (Tray 3 and Tray 4) on page 289</a>
RM1-6280-000CN	High-voltage power supply; duplex models	<a href="#">Internal assemblies (4 of 6) on page 283</a>
RM1-6281-000CN	Engine controller PCA 110V	<a href="#">Internal assemblies (5 of 6) on page 285</a>
RM1-6283-000CN	Switch assembly, power	<a href="#">Internal assemblies (4 of 6) on page 283</a>
RM1-6284-000CN	Tag holder assembly	<a href="#">Internal assemblies (1 of 6) on page 277</a>
RM1-6289-000CN	Cover, top assembly	<a href="#">Covers on page 275</a>
RM1-6291-000CN	Cover, left	<a href="#">Covers on page 275</a>
RM1-6292-000CN	Cover, rear assembly	<a href="#">Covers on page 275</a>
RM1-6296-000CN	Fuser motor assembly	<a href="#">Internal assemblies (6 of 6) on page 287</a>
RM1-6299-000CN	Cassette, paper pickup assembly; simplex models	<a href="#">Internal assemblies (5 of 6) on page 285</a>
RM1-6300-000CN	High-voltage power supply; simplex models	<a href="#">Internal assemblies (4 of 6) on page 283</a>
RM1-6301-000CN	Paper delivery roller assembly	<a href="#">Internal assemblies (6 of 6) on page 287</a>
RM1-6303-000CN	Separation holder assembly	<a href="#">Internal assemblies (3 of 6) on page 281</a>
RM1-6303-000CN	Separation holder assembly	<a href="#">500-sheet input tray (Tray 3 and Tray 4) on page 289</a>
RM1-6306-000CN	Base plate roller assembly	<a href="#">Internal assemblies (3 of 6) on page 281</a>
RM1-6306-000CN	Base plate roller assembly	<a href="#">500-sheet input tray (Tray 3 and Tray 4) on page 289</a>
RM1-6311-000CN	Face-down roller assembly	<a href="#">Internal assemblies (6 of 6) on page 287</a>



**Table 4-17 Numerical parts list (continued)**

<b>Part number</b>	<b>Description</b>	<b>Table and page</b>
RM1-6313-000CN	Cassette pickup roller	<a href="#">Internal assemblies (5 of 6) on page 285</a>
RM1-6313-000CN	Pickup roller set, cassette	<a href="#">500-sheet input tray (Tray 3 and Tray 4) on page 289</a>
RM1-6315-000CN	Transfer lower guide assembly	<a href="#">Internal assemblies (3 of 6) on page 281</a>
RM1-6318-000CN	Engine controller PCA 220V	<a href="#">Internal assemblies (5 of 6) on page 285</a>
RM1-6319-000CN	Fuser assembly 220V	<a href="#">Internal assemblies (5 of 6) on page 285</a>
RM1-6321-000CN	Roller, transfer	<a href="#">Internal assemblies (3 of 6) on page 281</a>
RM1-6322-000CN	Laser/scanner	<a href="#">Internal assemblies (1 of 6) on page 277</a>
RM1-6487-000CN	Tray sensor PCA	<a href="#">Internal assemblies (6 of 6) on page 287</a>
RM1-6510-000CN	Multipurpose sensor PCA	<a href="#">Internal assemblies (5 of 6) on page 285</a>
RM1-6511-000CN	TOP sensor PCA	<a href="#">Internal assemblies (4 of 6) on page 283</a>
RM1-6512-000CN	Paper width sensor PCA	<a href="#">Internal assemblies (4 of 6) on page 283</a>
RM1-6514-000CN	Front USB PCA	<a href="#">Internal assemblies (5 of 6) on page 285</a>
RM1-6515-000CN	Environmental sensor assembly	<a href="#">Internal assemblies (5 of 6) on page 285</a>
RM1-6518-000CN	Control panel; duplex models	<a href="#">Covers on page 275</a>
RM1-6519-000CN	Control panel; duplex models	<a href="#">Covers on page 275</a>
WC4-5171-000CN	Microswitch	<a href="#">Internal assemblies (5 of 6) on page 285</a>
WG8-5696-000CN	Photo interrupter, TLP1243	<a href="#">Internal assemblies (1 of 6) on page 277</a>
WG8-5696-000CN	Photo interrupter, TLP1243	<a href="#">Internal assemblies (6 of 6) on page 287</a>



---

# A Service and support

- [Hewlett-Packard limited warranty statement](#)
- [HP's Premium Protection Warranty: LaserJet print cartridge limited warranty statement](#)
- [End User License Agreement](#)
- [Customer self-repair warranty service](#)
- [Customer support](#)
- [Repack the product](#)
- [Service information form](#)

# Hewlett-Packard limited warranty statement

HP PRODUCT	DURATION OF LIMITED WARRANTY
HP LaserJet P3015, P3015d, P3015n, CP3015dn, CP3015x	One-year limited warranty

HP warrants to you, the end-user customer, that HP hardware and accessories will be free from defects in materials and workmanship after the date of purchase, for the period specified above. If HP receives notice of such defects during the warranty period, HP will, at its option, either repair or replace products which prove to be defective. Replacement products may be either new or equivalent in performance to new.

HP warrants to you that HP software will not fail to execute its programming instructions after the date of purchase, for the period specified above, due to defects in material and workmanship when properly installed and used. If HP receives notice of such defects during the warranty period, HP will replace software which does not execute its programming instructions due to such defects.

HP does not warrant that the operation of HP products will be uninterrupted or error free. If HP is unable, within a reasonable time, to repair or replace any product to a condition as warranted, you will be entitled to a refund of the purchase price upon prompt return of the product.

HP products may contain remanufactured parts equivalent to new in performance or may have been subject to incidental use.

Warranty does not apply to defects resulting from (a) improper or inadequate maintenance or calibration, (b) software, interfacing, parts or supplies not supplied by HP, (c) unauthorized modification or misuse, (d) operation outside of the published environmental specifications for the product, or (e) improper site preparation or maintenance.

TO THE EXTENT ALLOWED BY LOCAL LAW, THE ABOVE WARRANTIES ARE EXCLUSIVE AND NO OTHER WARRANTY OR CONDITION, WHETHER WRITTEN OR ORAL, IS EXPRESSED OR IMPLIED AND HP SPECIFICALLY DISCLAIMS ANY IMPLIED WARRANTIES OR CONDITIONS OF MERCHANTABILITY, SATISFACTORY QUALITY, AND FITNESS FOR A PARTICULAR PURPOSE. Some countries/regions, states or provinces do not allow limitations on the duration of an implied warranty, so the above limitation or exclusion might not apply to you. This warranty gives you specific legal rights and you might also have other rights that vary from country/region to country/region, state to state, or province to province.

HP's limited warranty is valid in any country/region or locality where HP has a support presence for this product and where HP has marketed this product. The level of warranty service you receive may vary according to local standards. HP will not alter form, fit or function of the product to make it operate in a country/region for which it was never intended to function for legal or regulatory reasons.

TO THE EXTENT ALLOWED BY LOCAL LAW, THE REMEDIES IN THIS WARRANTY STATEMENT ARE YOUR SOLE AND EXCLUSIVE REMEDIES. EXCEPT AS INDICATED ABOVE, IN NO EVENT WILL HP OR ITS SUPPLIERS BE LIABLE FOR LOSS OF DATA OR FOR DIRECT, SPECIAL, INCIDENTAL, CONSEQUENTIAL (INCLUDING LOST PROFIT OR DATA), OR OTHER DAMAGE, WHETHER BASED IN CONTRACT, TORT, OR OTHERWISE. Some countries/regions, states or provinces do not allow the exclusion or limitation of incidental or consequential damages, so the above limitation or exclusion may not apply to you.

THE WARRANTY TERMS CONTAINED IN THIS STATEMENT, EXCEPT TO THE EXTENT LAWFULLY PERMITTED, DO NOT EXCLUDE, RESTRICT OR MODIFY AND ARE IN ADDITION TO THE MANDATORY STATUTORY RIGHTS APPLICABLE TO THE SALE OF THIS PRODUCT TO YOU.

## HP's Premium Protection Warranty: LaserJet print cartridge limited warranty statement

This HP product is warranted to be free from defects in materials and workmanship.

This warranty does not apply to products that (a) have been refilled, refurbished, remanufactured or tampered with in any way, (b) experience problems resulting from misuse, improper storage, or operation outside of the published environmental specifications for the printer product or (c) exhibit wear from ordinary use.

To obtain warranty service, please return the product to place of purchase (with a written description of the problem and print samples) or contact HP customer support. At HP's option, HP will either replace products that prove to be defective or refund your purchase price.

TO THE EXTENT ALLOWED BY LOCAL LAW, THE ABOVE WARRANTY IS EXCLUSIVE AND NO OTHER WARRANTY OR CONDITION, WHETHER WRITTEN OR ORAL, IS EXPRESSED OR IMPLIED AND HP SPECIFICALLY DISCLAIMS ANY IMPLIED WARRANTIES OR CONDITIONS OF MERCHANTABILITY, SATISFACTORY QUALITY, AND FITNESS FOR A PARTICULAR PURPOSE.

TO THE EXTENT ALLOWED BY LOCAL LAW, IN NO EVENT WILL HP OR ITS SUPPLIERS BE LIABLE FOR DIRECT, SPECIAL, INCIDENTAL, CONSEQUENTIAL (INCLUDING LOST PROFIT OR DATA), OR OTHER DAMAGE, WHETHER BASED IN CONTRACT, TORT, OR OTHERWISE.

THE WARRANTY TERMS CONTAINED IN THIS STATEMENT, EXCEPT TO THE EXTENT LAWFULLY PERMITTED, DO NOT EXCLUDE, RESTRICT OR MODIFY AND ARE IN ADDITION TO THE MANDATORY STATUTORY RIGHTS APPLICABLE TO THE SALE OF THIS PRODUCT TO YOU.

# End User License Agreement

**PLEASE READ CAREFULLY BEFORE USING THIS SOFTWARE PRODUCT:** This End-User License Agreement (“EULA”) is a contract between (a) you (either an individual or the entity you represent) and (b) Hewlett-Packard Company (“HP”) that governs your use of the software product (“Software”). This EULA does not apply if there is a separate license agreement between you and HP or its suppliers for the Software, including a license agreement in online documentation. The term “Software” may include (i) associated media, (ii) a user guide and other printed materials, and (iii) “online” or electronic documentation (collectively “User Documentation”).

RIGHTS IN THE SOFTWARE ARE OFFERED ONLY ON THE CONDITION THAT YOU AGREE TO ALL TERMS AND CONDITIONS OF THIS EULA. BY INSTALLING, COPYING, DOWNLOADING, OR OTHERWISE USING THE SOFTWARE, YOU AGREE TO BE BOUND BY THIS EULA. IF YOU DO NOT ACCEPT THIS EULA, DO NOT INSTALL, DOWNLOAD, OR OTHERWISE USE THE SOFTWARE. IF YOU PURCHASED THE SOFTWARE BUT DO NOT AGREE TO THIS EULA, PLEASE RETURN THE SOFTWARE TO YOUR PLACE OF PURCHASE WITHIN FOURTEEN DAYS FOR A REFUND OF THE PURCHASE PRICE; IF THE SOFTWARE IS INSTALLED ON OR MADE AVAILABLE WITH ANOTHER HP PRODUCT, YOU MAY RETURN THE ENTIRE UNUSED PRODUCT.

1. **THIRD PARTY SOFTWARE.** The Software may include, in addition to HP proprietary software (“HP Software”), software under licenses from third parties (“Third Party Software” and “Third Party License”). Any Third Party Software is licensed to you subject to the terms and conditions of the corresponding Third Party License. Generally, the Third Party License is located in a file such as license.txt; you should contact HP support if you cannot find any Third Party License. If the Third Party Licenses include licenses that provide for the availability of source code (such as the GNU General Public License) and the corresponding source code is not included with the Software, then check the product support pages of HP’s website (hp.com) to learn how to obtain such source code.

2. **LICENSE RIGHTS.** You will have the following rights provided you comply with all terms and conditions of this EULA:

a. **Use.** HP grants you a license to Use one copy of the HP Software. “Use” means installing, copying, storing, loading, executing, displaying, or otherwise using the HP Software. You may not modify the HP Software or disable any licensing or control feature of the HP Software. If this Software is provided by HP for Use with an imaging or printing product (for example, if the Software is a printer driver, firmware, or add-on), the HP Software may only be used with such product (“HP Product”). Additional restrictions on Use may appear in the User Documentation. You may not separate component parts of the HP Software for Use. You do not have the right to distribute the HP Software.

b. **Copying.** Your right to copy means you may make archival or back-up copies of the HP Software, provided each copy contains all the original HP Software’s proprietary notices and is used only for back-up purposes.

3. **UPGRADES.** To Use HP Software provided by HP as an upgrade, update, or supplement (collectively “Upgrade”), you must first be licensed for the original HP Software identified by HP as eligible for the Upgrade. To the extent the Upgrade supersedes the original HP Software, you may no longer use such HP Software. This EULA applies to each Upgrade unless HP provides other terms with the Upgrade. In case of a conflict between this EULA and such other terms, the other terms will prevail.

4. **TRANSFER.**

a. **Third Party Transfer.** The initial end user of the HP Software may make a one-time transfer of the HP Software to another end user. Any transfer will include all component parts, media, User Documentation, this EULA, and if applicable, the Certificate of Authenticity. The transfer may not be an indirect transfer, such as a consignment. Prior to the transfer, the end user receiving the transferred

Software will agree to this EULA. Upon transfer of the HP Software, your license is automatically terminated.

b. Restrictions. You may not rent, lease or lend the HP Software or Use the HP Software for commercial timesharing or bureau use. You may not sublicense, assign or otherwise transfer the HP Software except as expressly provided in this EULA.

5. PROPRIETARY RIGHTS. All intellectual property rights in the Software and User Documentation are owned by HP or its suppliers and are protected by law, including applicable copyright, trade secret, patent, and trademark laws. You will not remove any product identification, copyright notice, or proprietary restriction from the Software.

6. LIMITATION ON REVERSE ENGINEERING. You may not reverse engineer, decompile, or disassemble the HP Software, except and only to the extent that the right to do so is allowed under applicable law.

7. CONSENT TO USE OF DATA. HP and its affiliates may collect and use technical information you provide in relation to (i) your Use of the Software or the HP Product, or (ii) the provision of support services related to the Software or the HP Product. All such information will be subject to HP's privacy policy. HP will not use such information in a form that personally identifies you except to the extent necessary to enhance your Use or provide support services.

8. LIMITATION OF LIABILITY. Notwithstanding any damages that you might incur, the entire liability of HP and its suppliers under this EULA and your exclusive remedy under this EULA will be limited to the greater of the amount actually paid by you for the Product or U.S. \$5.00. TO THE MAXIMUM EXTENT PERMITTED BY APPLICABLE LAW, IN NO EVENT WILL HP OR ITS SUPPLIERS BE LIABLE FOR ANY SPECIAL, INCIDENTAL, INDIRECT, OR CONSEQUENTIAL DAMAGES (INCLUDING DAMAGES FOR LOST PROFITS, LOST DATA, BUSINESS INTERRUPTION, PERSONAL INJURY, OR LOSS OF PRIVACY) RELATED IN ANY WAY TO THE USE OF OR INABILITY TO USE THE SOFTWARE, EVEN IF HP OR ANY SUPPLIER HAS BEEN ADVISED OF THE POSSIBILITY OF SUCH DAMAGES AND EVEN IF THE ABOVE REMEDY FAILS OF ITS ESSENTIAL PURPOSE. Some states or other jurisdictions do not allow the exclusion or limitation of incidental or consequential damages, so the above limitation or exclusion may not apply to you.

9. U.S. GOVERNMENT CUSTOMERS. If you are a U.S. Government entity, then consistent with FAR 12.211 and FAR 12.212, Commercial Computer Software, Computer Software Documentation, and Technical Data for Commercial Items are licensed under the applicable HP commercial license agreement.

10. COMPLIANCE WITH EXPORT LAWS. You will comply with all laws, rules, and regulations (i) applicable to the export or import of the Software, or (ii) restricting the Use of the Software, including any restrictions on nuclear, chemical, or biological weapons proliferation.

11. RESERVATION OF RIGHTS. HP and its suppliers reserve all rights not expressly granted to you in this EULA.

(c) 2007 Hewlett-Packard Development Company, L.P.

Rev. 11/06

## Customer self-repair warranty service

HP products are designed with many Customer Self Repair (CSR) parts to minimize repair time and allow for greater flexibility in performing defective parts replacement. If during the diagnosis period, HP identifies that the repair can be accomplished by the use of a CSR part, HP will ship that part directly to you for replacement. There are two categories of CSR parts: 1) Parts for which customer self repair is mandatory. If you request HP to replace these parts, you will be charged for the travel and labor costs of this service. 2) Parts for which customer self repair is optional. These parts are also designed for Customer Self Repair. If, however, you require that HP replace them for you, this may be done at no additional charge under the type of warranty service designated for your product.

Based on availability and where geography permits, CSR parts will be shipped for next business day delivery. Same-day or four-hour delivery may be offered at an additional charge where geography permits. If assistance is required, you can call the HP Technical Support Center and a technician will help you over the phone. HP specifies in the materials shipped with a replacement CSR part whether a defective part must be returned to HP. In cases where it is required to return the defective part to HP, you must ship the defective part back to HP within a defined period of time, normally five (5) business days. The defective part must be returned with the associated documentation in the provided shipping material. Failure to return the defective part may result in HP billing you for the replacement. With a customer self repair, HP will pay all shipping and part return costs and determine the courier/carrier to be used.



## Customer support

---

Get telephone support, free during your warranty period, for your country/region

Country/region phone numbers are on the flyer that was in the box with your product or at [www.hp.com/support/](http://www.hp.com/support/).

Have the product name, serial number, date of purchase, and problem description ready.

---

Get 24-hour Internet support

[www.hp.com/support/ljp3010series](http://www.hp.com/support/ljp3010series)

---

Get support for products used with a Macintosh computer

[www.hp.com/go/macosex](http://www.hp.com/go/macosex)

---

Download software utilities, drivers, and electronic information

[www.hp.com/go/ljp3010series\\_software](http://www.hp.com/go/ljp3010series_software)

---

Order additional HP service or maintenance agreements

[www.hp.com/go/carepack](http://www.hp.com/go/carepack)

---

## Repack the product

If HP Customer Care determines that your product needs to be returned to HP for repair, follow these steps to repack the product before shipping it.

---

△ **CAUTION:** Shipping damage as a result of inadequate packing is the customer's responsibility.

---

1. Remove and retain any DIMMs cards that you have purchased and installed in the product.

△ **CAUTION:** Static electricity can damage electronic parts. When handling DIMMs, either wear an antistatic wrist strap, or frequently touch the surface of the DIMM antistatic package and then touch bare metal on the product. To remove the DIMMs, see [DIMM cover and DIMM on page 57](#).

---

2. Remove and retain the print cartridge.

△ **CAUTION:** It is *extremely important* to remove the print cartridge before shipping the product. A print cartridge that remains in the product during shipping can leak and cover the product engine and other parts with toner.

To prevent damage to the print cartridge, avoid touching the roller on it, and store the print cartridge in its original packing material or so that it is not exposed to light.

---

3. Remove and retain the power cable, interface cable, and optional accessories, such as an EIO card.

4. If possible, include print samples and 50 to 100 sheets of paper or other print media that did not print correctly.

5. In the U.S., call HP Customer Care to request new packing material. In other areas, use the original packing material, if possible. Hewlett-Packard recommends insuring the equipment for shipment.

# Service information form

---

**WHO IS RETURNING THE EQUIPMENT?**

Date:

Person to contact:

Phone:

Alternate contact:

Phone:

Return shipping address:

Special shipping instructions:

---

**WHAT ARE YOU SENDING?**

Model name:

Model number:

Serial number:

Please attach any relevant printouts. Do NOT ship accessories (manuals, cleaning supplies, and so on) that are not required to complete the repair.

---

**HAVE YOU REMOVED THE PRINT CARTRIDGES?**

You must remove them before shipping the printer, unless a mechanical problem prevents you from doing so.

 Yes. No, I cannot remove them.

---

**WHAT NEEDS TO BE DONE?** (Attach a separate sheet if necessary.)

1. Describe the conditions of the failure. (What was the failure? What were you doing when the failure occurred? What software were you running? Is the failure repeatable?)

2. If the failure is intermittent, how much time elapses between failures?

3. If the unit connected to any of the following, give the manufacturer and model number.

Personal computer:

Modem:

Network:

4. Additional comments:

---

**HOW WILL YOU PAY FOR THE REPAIR?** Under warranty

Purchase/received date:

(Attach proof of purchase or receiving document with original received date.)

 Maintenance contract number: Purchase order number:

**Except for contract and warranty service, a purchase order number and/or authorized signature must accompany any request for service.** If standard repair prices do not apply, a minimum purchase order is required. Standard repair prices can be obtained by contacting an HP-authorized repair center.

Authorized signature:

Phone:

Billing address:

Special billing instructions:



---

# B Specifications

- [Physical specifications](#)
- [Electrical specifications](#)
- [Acoustic specifications](#)
- [Environmental specifications](#)

## Physical specifications

**Table B-1 Product dimensions and weights**

Product model	Height	Depth	Width	Weight
Base, d, n, and dn models	316 mm (12.4 in)	412 mm (16.2 in)	448 mm (17.6 in)	15.9 kg (35.1 lb)
x model	456 mm (17.9 in)	412 mm (16.2 in)	448 mm (17.6 in)	21.2 kg (46.8 lb)
Optional 500-sheet feeder	140 mm (5.5 in)	412 mm (16.2 in)	448 mm (17.6 in)	5.3 kg (11.7 lb)

**Table B-2 Product dimensions with all doors and trays fully opened**

Product model	Height	Depth	Width
Base, d, n, and dn models	347 mm (13.7 in)	1040 mm (41.0 in)	448 mm (17.6 in)
x model	487 mm (19.2 in)	1040 mm (41.0 in)	448 mm (17.6 in)

## Electrical specifications

**⚠ WARNING!** Power requirements are based on the country/region where the product is sold. Do not convert operating voltages. This can damage the product and void the product warranty.

**Table B-3 Power requirements**

Specification	110-volt models	220-volt models
Power requirements	100 to 127 Vac	220 to 240 Vac
	50/60 Hz	50/60 Hz
Rated current	8.6 Amps	4.2 Amps

**Table B-4 Power consumption (average, in watts)<sup>1</sup>**

Model	Printing <sup>2</sup>	Ready or standby <sup>4</sup>	Sleep <sup>3</sup>	Off
HP LaserJet P3015	780 W	14.5 W	8.5 W	0.6 W

<sup>1</sup> Values are based on preliminary data. See [www.hp.com/go/ljp3010series\\_regulatory](http://www.hp.com/go/ljp3010series_regulatory) for current information.

<sup>2</sup> Power numbers are the highest values measured using all standard voltages.

<sup>3</sup> Default time from Ready mode to Sleep = 30 minutes.

<sup>4</sup> Heat dissipation in Ready mode = 50 BTU/hour.

## Acoustic specifications

**Table B-5 Sound power and pressure level**

Product model	Sound power level <sup>1, 2</sup>	Declared per ISO 9296
HP LaserJet P3015 models	Printing	$L_{WA,d} = 6.8$ Bels (A) [68 dB(A)]
	Ready	Inaudible

**Table B-5 Sound power and pressure level (continued)**

Product model	Sound power level <sup>1, 2</sup>	Declared per ISO 9296
HP LaserJet P3015 models	Printing	$L_{pAm}=54$ dB (A)
	Ready	Inaudible

<sup>1</sup> Values are based on preliminary data. See [www.hp.com/support/ljp3010series](http://www.hp.com/support/ljp3010series) for current information.

<sup>2</sup> Configuration tested: HP LaserJet P3015dn printing simplex on A4 paper.

## Environmental specifications

**Table B-6 Necessary conditions**

Environmental condition	Recommended	Allowed
Temperature (Product and print cartridge)	17.5° to 25°C (63° to 77°)	-20° to 60°C (-4° to 140°F)
Relative humidity	30% to 70%	10% to 90%





---

## C Regulatory information


- [FCC regulations](#)
- [Environmental product stewardship program](#)
- [Declaration of conformity](#)
- [Safety statements](#)

## FCC regulations

This equipment has been tested and found to comply with the limits for a Class B digital device, pursuant to Part 15 of the FCC rules. These limits are designed to provide reasonable protection against harmful interference in a residential installation. This equipment generates, uses, and can radiate radio frequency energy. If this equipment is not installed and used in accordance with the instructions, it may cause harmful interference to radio communications. However, there is no guarantee that interference will not occur in a particular installation. If this equipment does cause harmful interference to radio or television reception, which can be determined by turning the equipment off and on, the user is encouraged to try to correct the interference by one or more of the following measures:

- Reorient or relocate the receiving antenna.
- Increase separation between equipment and receiver.
- Connect equipment to an outlet on a circuit different from that to which the receiver is located.
- Consult your dealer or an experienced radio/TV technician.

---

 **NOTE:** Any changes or modifications to the printer that are not expressly approved by HP could void the user's authority to operate this equipment.

Use of a shielded interface cable is required to comply with the Class B limits of Part 15 of FCC rules.

# Environmental product stewardship program

## Protecting the environment

Hewlett-Packard Company is committed to providing quality products in an environmentally sound manner. This product has been designed with several attributes to minimize impacts on our environment.

## Ozone production

This product generates no appreciable ozone gas (O<sub>3</sub>).

## Power consumption

Power usage drops significantly while in Ready and Sleep mode, which saves natural resources and saves money without affecting the high performance of this product. To determine the ENERGY STAR® qualification status for this product, see the Product Data Sheet or Specifications Sheet. Qualified products are also listed at:

[www.hp.com/go/energystar](http://www.hp.com/go/energystar)

## Toner consumption

EconoMode uses less toner, which might extend the life of the print cartridge.

## Paper use

This product's optional automatic duplex feature (two-sided printing) and N-up printing (multiple pages printed on one page) capability can reduce paper usage and the resulting demands on natural resources.


## Plastics

Plastic parts over 25 grams are marked according to international standards that enhance the ability to identify plastics for recycling purposes at the end of the product's life.

## HP LaserJet print supplies

It's easy to return and recycle your HP LaserJet print cartridges after use—free of charge—with HP Planet Partners. Multilingual program information and instructions are included in every new HP LaserJet print cartridge and supplies package. You help reduce the toll on the environment further when you return multiple cartridges together rather than separately.

HP is committed to providing inventive, high-quality products and services that are environmentally sound, from product design and manufacturing to distribution, customer use and recycling. When you participate in the HP Planet Partners program, we ensure your HP LaserJet print cartridges are recycled properly, processing them to recover plastics and metals for new products and diverting millions of tons of waste from landfills. Since this cartridge is being recycled and used in new materials, it will not be returned to you. Thank you for being environmentally responsible!

 **NOTE:** Use the return label to return original HP LaserJet print cartridges only. Please do not use this label for HP inkjet cartridges, non-HP cartridges, refilled or remanufactured cartridges or warranty returns. For information about recycling your HP inkjet cartridges please go to <http://www.hp.com/recycle>.

## Return and recycling instructions

### United States and Puerto Rico

The enclosed label in the HP LaserJet toner cartridge box is for the return and recycling of one or more HP LaserJet print cartridges after use. Please follow the applicable instructions below.

#### Multiple returns (more than one cartridge)

1. Package each HP LaserJet print cartridge in its original box and bag.
2. Tape the boxes together using strapping or packaging tape. The package can weigh up to 31 kg (70 lb).
3. Use a single pre-paid shipping label.

#### OR

1. Use your own suitable box, or request a free bulk collection box from [www.hp.com/recycle](http://www.hp.com/recycle) or 1-800-340-2445 (holds up to 31 kg (70 lb) of HP LaserJet print cartridges).
2. Use a single pre-paid shipping label.

#### Single returns

1. Package the HP LaserJet print cartridge in its original bag and box.
2. Place the shipping label on the front of the box.

#### Shipping

For all HP LaserJet print cartridge recycling returns, give the package to UPS during your next delivery or pickup, or take it to an authorized UPS drop-off center. For the location of your local UPS drop-off center, call 1-800-PICKUPS or visit [www.ups.com](http://www.ups.com). If you are returning via USPS label, give the package to a U.S. Postal Service carrier or drop off at a U.S. Postal Service Office. For more information, or to order additional labels or boxes for bulk returns, visit [www.hp.com/recycle](http://www.hp.com/recycle) or call 1-800-340-2445. Requested UPS pickup will be charged normal pickup rates. Information subject to change without notice.

#### Residents of Alaska and Hawaii

Do not use the UPS label. Call 1-800-340-2445 for information and instructions. The U.S. Postal Service provides no-cost cartridge return transportation services under an arrangement with HP for Alaska and Hawaii.

#### Non-U.S. returns

To participate in HP Planet Partners return and recycling program, just follow the simple directions in the recycling guide (found inside the packaging of your new product supply item) or visit [www.hp.com/recycle](http://www.hp.com/recycle). Select your country/region for information on how to return your HP LaserJet printing supplies.

#### Paper

This product is capable of using recycled papers when the paper meets the guidelines outlined in the *HP LaserJet Printer Family Print Media Guide*. This product is suitable for the use of recycled paper according to EN12281:2002.

## Material restrictions

This HP product does not contain added mercury.

This HP product contains a battery that might require special handling at end-of-life. The batteries contained in or supplied by Hewlett-Packard for this product include the following:

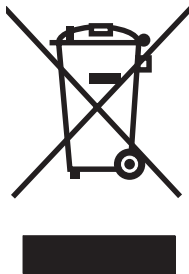
HP LaserJet P3010 Series	
Type	Carbon monofluoride lithium
Weight	1.5 g
Location	On formatter board
User-removable	No



### 廢電池請回收

For recycling information, you can go to [www.hp.com/recycle](http://www.hp.com/recycle), or contact your local authorities or the Electronics Industries Alliance: [www.eiae.org](http://www.eiae.org).

## Disposal of waste equipment by users in private households in the European Union



This symbol on the product or on its packaging indicates that this product must not be disposed of with your other household waste. Instead, it is your responsibility to dispose of your waste equipment by handing it over to a designated collection point for the recycling of waste electrical and electronic equipment. The separate collection and recycling of your waste equipment at the time of disposal will help to conserve natural resources and ensure that it is recycled in a manner that protects human health and the environment. For more information about where you can drop off your waste equipment for recycling, please contact your local city office, your household waste disposal service or the shop where you purchased the product.

## Chemical substances

HP is committed to providing our customers with information about the chemical substances in our products as needed to comply with legal requirements such as REACH (Regulation EC No 1907/2006 of the European Parliament and the Council). A chemical information report for this product can be found at: [www.hp.com/go/reach](http://www.hp.com/go/reach).

## Material Safety Data Sheet (MSDS)

Material Safety Data Sheets (MSDS) for supplies containing chemical substances (for example, toner) can be obtained by accessing the HP Web site at [www.hp.com/go/msds](http://www.hp.com/go/msds) or [www.hp.com/hpinfo/community/environment/productinfo/safety](http://www.hp.com/hpinfo/community/environment/productinfo/safety).

## For more information

To obtain information about these environmental topics:

- Product environmental profile sheet for this and many related HP products
- HP's commitment to the environment
- HP's environmental management system
- HP's end-of-life product return and recycling program
- Material Safety Data Sheets

Visit [www.hp.com/go/environment](http://www.hp.com/go/environment) or [www.hp.com/hpinfo/globalcitizenship/environment](http://www.hp.com/hpinfo/globalcitizenship/environment).

# Declaration of conformity

## Declaration of Conformity

according to ISO/IEC 17050-1 and EN 17050-1, DoC#: BOISB-0804-00-rel.1.0

**Manufacturer's Name:** Hewlett-Packard Company  
**Manufacturer's Address:** 11311 Chinden Boulevard,  
Boise, Idaho 83714-1021, USA

**declares, that the product**

**Product Name:** HP LaserJet P3010 series  
Including: CE530A - Optional 500-sheet tray

**Regulatory Model Number<sup>2)</sup>:** BOISB-0804-00  
**Product Options:** ALL


Print Cartridges: CE255A /CE255X

**conforms to the following Product Specifications:**

**Safety:** IEC 60950-1:2001 / EN60950-1: 2001 +A11  
IEC 60825-1:1993 +A1 +A2 / EN 60825-1:1994 +A1 +A2 (Class 1 Laser/LED Product)  
GB4943-2001

**EMC:** CISPR22:2005 / EN 55022:2006 - Class B<sup>1)</sup>  
EN 61000-3-2:2006  
EN 61000-3-3:1995 +A1  
EN 55024:1998 +A1 +A2  
FCC Title 47 CFR, Part 15 Class B<sup>2)</sup> / ICES-003, Issue 4  
GB9254-1998, GB17625.1-2003

### Supplementary Information:

The product herewith complies with the requirements of the EMC Directive 2004/108/EC and the Low Voltage Directive 2006/95/EC, and carries the CE-Marking  accordingly.

This Device complies with Part 15 of the FCC Rules. Operation is subject to the following two conditions: (1) this device may not cause harmful interference, and (2) this device must accept any interference received, including interference that may cause undesired operation.

1) The product was tested in a typical configuration with Hewlett-Packard Personal Computer Systems.

2) For regulatory purposes, this product is assigned a Regulatory model number. This number should not be confused with the marketing name or the product number(s).

Boise, Idaho , USA

**May 30, 2009**

### For regulatory topics only:

**European Contact:** Your Local Hewlett-Packard Sales and Service Office or Hewlett-Packard GmbH, Department HQ-TRE / Standards Europe,, Herrenberger Strasse 140, , D-71034, Böblingen, (FAX: +49-7031-14-3143), [www.hp.com/go/certificates](http://www.hp.com/go/certificates)

**USA Contact:** Product Regulations Manager, Hewlett-Packard Company,, PO Box 15, Mail Stop 160, Boise, ID 83707-0015, , (Phone: 208-396-6000)

## Safety statements

### Laser safety

The Center for Devices and Radiological Health (CDRH) of the U.S. Food and Drug Administration has implemented regulations for laser products manufactured since August 1, 1976. Compliance is mandatory for products marketed in the United States. The device is certified as a “Class 1” laser product under the U.S. Department of Health and Human Services (DHHS) Radiation Performance Standard according to the Radiation Control for Health and Safety Act of 1968. Since radiation emitted inside the device is completely confined within protective housings and external covers, the laser beam cannot escape during any phase of normal user operation.

**⚠ WARNING!** Using controls, making adjustments, or performing procedures other than those specified in this user guide may result in exposure to hazardous radiation.

### Canadian DOC regulations

Complies with Canadian EMC Class B requirements.

« Conforme à la classe B des normes canadiennes de compatibilité électromagnétiques. « CEM ». »

### VCCI statement (Japan)

この装置は、情報処理装置等電波障害自主規制協議会（VCCI）の基準に基づくクラスB情報技術装置です。この装置は、家庭環境で使用することを目的としていますが、この装置がラジオやテレビジョン受信機に近接して使用されると、受信障害を引き起こすことがあります。  
取扱説明書に従って正しい取り扱いをして下さい。

### Power cord statement (Japan)

製品には、同梱された電源コードをお使い下さい。  
同梱された電源コードは、他の製品では使用出来ません。

### EMC statement (Korea)

B급 기기 (가정용 방송통신기기)	이 기기는 가정용(B급)으로 전자파적합등록을 한 기기로서 주로 가정에서 사용하는 것을 목적으로 하며, 모든 지역에서 사용할 수 있습니다.
-----------------------	--



## Laser statement for Finland

### **Luokan 1 laserlaite**

Klass 1 Laser Apparat

HP LaserJet P3015, P3015d, P3015dn, P3015x, laserkirjoitin on käyttäjän kannalta turvallinen luokan 1 laserlaite. Normaalisissa käytössä kirjoittimen suojakotelo estää lasersäteiden pääsyn laitteen ulkopuolelle. Laitteen turvallisuusluokka on määritetty standardin EN 60825-1 (1994) mukaisesti.

### **VAROITUS !**

Laitteen käyttäminen muulla kuin käyttöohjeessa mainitulla tavalla saattaa altistaa käyttäjän turvallisuusluokan 1 ylittävälle näkymättömälle lasersäteilylle.

### **WARNING !**

Om apparaten används på annat sätt än i bruksanvisning specificerats, kan användaren utsättas för osynlig laserstrålning, som överskrider gränsen för laserklass 1.

### **HUOLTO**

HP LaserJet P3015, P3015d, P3015dn, P3015x - kirjoittimen sisällä ei ole käyttäjän huollettavissa olevia kohteita. Laitteen saa avata ja huoltaa ainoastaan sen huoltamiseen koulutettu henkilö. Tällaiseksi huoltotoimenpiteeksi ei katsota väriainekasetin vaihtamista, paperiradan puhdistusta tai muita käyttäjän käsikirjassa lueteltuja, käyttäjän tehtäväksi tarkoitettuja ylläpitotoimia, jotka voidaan suorittaa ilman erikoistyökaluja.

### **VARO !**

Mikäli kirjoittimen suojakotelo avataan, olet alttiina näkymättömälle lasersäteilylle laitteen ollessa toiminnassa. Älä katso säteeseen.

### **WARNING !**

Om laserprinterns skyddshölje öppnas då apparaten är i funktion, utsättas användaren för osynlig laserstrålning. Betrakta ej strålen. Tiedot laitteessa käytettävän laserdiodin säteilyominaisuuksista: Aallonpituus 775-795 nm Teho 5 m W Luokan 3B laser.

## Substances Table (China)

### 有毒有害物质表

根据中国电子信息产品污染控制管理办法的要求而出台

部件名称	有毒有害物质和元素					
	铅 (Pb)	汞 (Hg)	镉 (Cd)	六价铬 (Cr(VI))	多溴联苯 (PBB)	多溴二苯醚 (PBDE)
打印引擎	X	0	X	0	0	0
控制面板	0	0	0	0	0	0
塑料外壳	0	0	0	0	0	0
格式化板组件	X	0	0	0	0	0
碳粉盒	X	0	0	0	0	0

3685

0：表示在此部件所用的所有同类材料中，所含的此有毒或有害物质均低于 SJ/T11363-2006 的限制要求。

X：表示在此部件所用的所有同类材料中，至少一种所含的此有毒或有害物质高于 SJ/T11363-2006 的限制要求。

注：引用的“环保使用期限”是根据在正常温度和湿度条件下操作使用产品而确定的。

---

# Index

## A

accessories  
    ordering 268  
acoustic specifications 308  
address, TCP/IPv6 189  
after service checklist 48  
AppleTalk settings 190

## B

batteries included 315  
black page, problem-solving 253  
blank page  
    problem-solving 247  
blank pages  
    troubleshooting 257  
blurred print, problem-solving 254  
both sides, printing on  
    Show Me How menu 174

## C

cables  
    USB, troubleshooting 257  
Canadian DOC regulations 318  
cartridge  
    memory tag 32  
    ordering 268  
    part number 268  
    removing 52  
cartridge-door assembly  
    removing 71  
cartridges  
    recycling 313  
    warranty 299  
cassette  
    Tray 2, removing 54  
    Tray 3, removing 54  
    Tray 4, removing 54  
cautions iii  
characters, misformed 251

checklists  
    after service 48  
    preservice 48  
circuit diagram 170  
cold reset 262  
configuration page, printing 176  
Configure device menu 178  
control panel  
    cleaning page, printing 172  
    default settings, restoring 262  
    messages, types of 197  
    removing 74  
control-panel menus  
    accessing 174  
    Configure device 178  
    Diagnostics 194  
    EIO <X> Jetdirect menu 187  
    Embedded Jetdirect 187  
    I/O (input/output) 187  
    Information 176  
    Manage supplies 177  
    opening 174  
    Paper handling 177  
    PCL sub-menu 179  
    Print quality 180  
    Printing 178  
    Resets 194  
    Retrieve job 175  
    Service 259  
    Show Me How 174  
    System setup 183  
conventions, document iii  
covers  
    cartridge-door assembly,  
        removing 71  
    DIMM, removing 57  
    formatter, removing 60  
    front right, removing 76  
    left, removing 66  
    lower-right and bracket,  
        removing 80  
    multipurpose tray cover,  
        removing 69  
    right, removing 76  
    right-rear, removing 68  
    top cover, removing 84  
    top-right, removing 73  
    tray 1 cover, removing 69  
creased paper, problem-solving 252  
crooked pages 251  
curled paper, problem-solving 252  
customer support  
    online 303  
    repacking product 304  
    service information form 305

## D

date code, service ID 261  
declaration of conformity 317  
default settings, restoring  
    cold reset 262  
demonstration page, printing 176  
density  
    problem-solving 247  
developing stage 29  
DHCP settings 188  
diagnostics  
    engine 134  
    networks 191  
    skip disk-load 260  
Diagnostics menu 194  
dimensions, product 308  
DIMM  
    removing 57  
DIMM cover  
    removing 57

- disk
  - initialization 260
- disposal, end-of-life 315
- DLC/LLC settings 190
- DNS settings
  - IPV4 189
  - IPV6 189
- document conventions iii
- doors
  - rear assembly, removing 62
- dots, problem-solving 248, 253
- double-sided printing
  - Show Me How menu 174
- dropouts, problem-solving 249
- drum cleaning stage 31
- duplex media-feed assembly
  - removing 104
- duplexer
  - Show Me How menu 174

**E**

- ECU
  - removing 110
- EIO <X> Jetdirect menu 187
- EIO cards
  - settings 187
- electrical specifications 308
- electrostatic discharge (ESD) 46
- Embedded Jetdirect menu 187
- end-of-life disposal 315
- energy specifications 308
- engine test 134
- engine-control system 6
- envelopes
  - jams 245
  - wrinkled, problem-solving 252
- environment for product
  - specifications 309
- environmental stewardship
  - program 313
- error messages
  - event log, listed
    - numerically 217
  - types of 197
- ESD (electrostatic discharge) 46
- European Union, waste
  - disposal 315
- event log
  - messages, listed
    - numerically 217

- print 215
- sample 216
- view 215

**F**

- fan sub, removing 118
- file directory, printing 176
- Finnish laser safety
  - statement 319
- firmware, upgrading 263
- font list, printing
  - PCL 177
  - PS 177
- formatter
  - ordering 269
  - part number 269
  - service ID 261
- formatter cover
  - removing 60
- formatter lights 133
- formatter PCA
  - removing 60
- front-right cover, removing 76
- fuser
  - removing 100
- fuser motor, removing 117
- fusing stage 30

**G**

- gray background, problem-solving 250

**H**

- hard disk
  - initialization 260
- heartbeat LED 133
- help, Show Me How menu 174
- HP Customer Care 303
- HP Jetdirect print server
  - firmware updates 266
  - lights 133
- HP Web Jetadmin
  - firmware updates 265
- humidity
  - specifications 309

**I**

- I/O (input/output) menu 187
- image defects, problem-solving 247

- image repetition, problem-solving 254
- Information menu 176
- initializing
  - hard disk 260
- input trays
  - configuring 177
- IP address
  - default 188
- IPv4 settings 188
- IPv6 settings 189
- IPX/SPX settings 190

**J**

- jams
  - common causes of 219
  - envelopes 245
  - preventing 240
  - recovery 241
  - Show Me How menu 174
- Japanese VCCI statement 318
- Jetadmin
  - firmware updates 265
- Jetdirect print server
  - firmware updates 266
  - lights 133

**K**

- Korean EMC statement 318

**L**

- laser beam exposure stage 28
- laser safety statements 318, 319
- laser/scanner
  - operations 24
  - removing 107
- left cover
  - removing 66
- license, software 300
- light print
  - problem-solving 247
- lights
  - formatter 133
- lines horizontal, problem-solving 249, 253
- lines vertical, problem-solving 252
- lines, problem-solving 249, 253
- link speed settings 193
- loading
  - Show Me How menu 174

- location
  - assemblies (base product) 272
  - covers 274
  - internal assemblies 276
  - optional trays or accessories (base product) 273
- log of events
  - messages, listed numerically 217
- loose toner, problem-solving 250
- lower-right cover and bracket, removing 80
- M**
- Macintosh
  - support 303
- Manage supplies menu 177
- material restrictions 315
- Material Safety Data Sheet (MSDS) 316
- media
  - Show Me How menu 174
- memory
  - DIMM, removing 57
  - NVRAM initialization 260
  - ordering 269
  - part numbers 269
  - print cartridge 32
- menu map, printing 176
- menus, control panel
  - default settings, restoring 262
- menus, control-panel
  - accessing 174
  - Configure device 178
  - Diagnostics 194
  - EIO <X> Jetdirect menu 187
  - Embedded Jetdirect 187
  - I/O (input/output) 187
  - Information 176
  - Manage supplies 177
  - Paper handling 177
  - PCL sub-menu 179
  - Print quality 180
  - Printing 178
  - Resets 194
  - Retrieve job 175
  - Service 259
  - Show Me How 174
  - System setup 183
- mercury-free product 315
- messages
  - event log, listed numerically 217
  - types of 197
- misformed characters, problem-solving 251
- multipurpose tray cover
  - removing 69
- N**
- networks
  - diagnostics 191
  - link speed settings 193
  - protocols 187
  - security 187
  - settings 187
- noise specifications 308
- notes iii
- NVRAM initialization 260
- O**
- online support 303
- operating environment
  - specifications 309
- operations
  - engine-control system 6
  - laser/scanner 24
  - print cartridge memory 32
- ordering
  - 500-sheet tray 269
  - formatter 269
  - memory 269
  - print cartridge 268
  - product documents 268
  - supplies and accessories 268
  - whole-unit replacement 270
- P**
- packaging product 304
- pages
  - blank 257
  - not printing 257
  - printing slowly 257
- paper
  - curled 252
  - Show Me How menu 174
  - skewed 251
  - wrinkled 252
- Paper handling menu 177
- part number
  - 500-sheet tray 269
  - formatter 269
  - memory 269
  - print cartridge 268
  - whole-unit replacement 270
- parts
  - 500-sheet input tray 288
  - assemblies (base product) 272
  - covers 274
  - internal assemblies 276
  - optional trays or accessories (base product) 273
- PCL font list, printing 177
- PCL sub-menu 179
- physical specifications 308
- post-service tests 48
- power specifications 308
- preservice checklist 48
- primary charging stage 28
- print cartridge
  - memory tag 32
  - ordering 268
  - part number 268
  - removing 52
- print cartridges
  - recycling 313
  - warranty 299
- print quality
  - black page 253
  - blurred 254
  - dropouts 249
  - gray background 250
  - horizontal lines 249
  - image defects 247
  - light print 247
  - lines 249
  - loose toner 250
  - misformed characters 251
  - repeating defects 251
  - repetitive images 254
  - scattered lines 253
  - smear toner 250
  - specks 248
  - tire tracks 253
  - white horizontal lines 253
  - white lines vertical 252
  - white spots 253
- Print quality menu 180

- print-quality test 48
- printing
  - troubleshooting 257
- Printing menu 178
- problem-solving
  - black page 253
  - blank page 247
  - blurred print 254
  - checklist 128
  - curled paper 252
  - dropouts 249
  - event-log messages, numerical list 217
  - gray background 250
  - image defects 247
  - light print 247
  - lines 249
  - lines horizontal 249, 253
  - lines vertical 252
  - messages, types of 197
  - networks 191
  - repeating defects 251
  - repetitive images 254
  - scattered lines 253
  - Show Me How menu 174
  - skewed pages 251
  - smear toner 250
  - specks 248
  - text quality 251, 254
  - tire tracks 253
  - white spots 253
  - wrinkled paper 252
- product settings
  - configuring 178
- protocols, network 187
- proxy server settings 190
- PS font list, printing 177
- R**
- rear-door assembly
  - removing 62
- recycling
  - HP printing supplies returns and environmental program 314
- registration assembly
  - removing 102
- remote firmware update (RFU) 263
- removing parts
  - cautions for 46
- checklists 48
- print cartridge 52
- service approach 48
- sub cover 52
- tray cassette 54
- repacking product 304
- repair approach 48
- repeating defects, problem-solving 251, 254
- replacing parts
  - cautions for 46
  - service approach 48
- reset, cold 262
- Resets menu 194
- Retrieve job menu 175
- right cover, removing 76
- right-rear cover, removing 68
- S**
- safety statements 318, 319
- screwdrivers, required 46
- screws
  - replacing 46
  - types of 47
- security
  - settings 187
- sensor tests, manual
  - duplex sensor (C) 142
  - face up detect sensor (H) 147
  - FD tray full sensor (G) 146
  - fuser output sensor (B) 141
  - paper width sensor 1 (D) 143
  - rear cover open sensor (I) 149
  - top cover open sensor (I) 148
  - TOP sensor (A) 140
  - Tray 1 paper sensor (K) 150
  - Tray 2 detect sensor (M) 152
  - Tray 2 paper sensor (L) 151
  - Tray 3 detect sensor (O) 154
  - Tray 3 feed sensor (E) 144
  - Tray 3 paper sensor (N) 153
  - Tray 4 detect sensor (Q) 156
  - Tray 4 feed sensor (F) 145
  - Tray 4 paper sensor (P) 155
- separation stage 30
- service
  - approach 48
  - information form 305
- repacking product 304
- service ID 261
- Service menu 259
- settings
  - cold reset 262
  - configuring 178
  - NVRAM initialization 260
- shipping product 304
- Show Me How menu 174
- skewed pages 251
- skip disk-load 260
- Sleep mode
  - power specifications 308
- smear toner, problem-solving 250
- software
  - software license agreement 300
- solving
  - direct-connect problems 258
  - network problems 258
- specifications
  - acoustic 308
  - electrical 308
  - operating environment 309
  - physical 308
- specks, problem-solving 248, 253
- spots, problem-solving 248, 253
- static precautions 46
- status
  - messages, types of 197
- sub cover
  - removing 52
- supplies
  - managing 177
  - ordering 268
  - recycling 313
- supplies status page, printing 176
- supply messages
  - configuring 177
- support
  - online 303
  - repacking product 304
  - service information form 305
- System setup menu 183

## T

- TCP/IP settings
  - 187
- technical support
  - online 303
  - repacking product 304
  - service information form 305
- temperature specifications 309
- tests
  - engine 134
  - networks 191
  - post-service 48
  - print-quality 48
  - sensor 137
  - skip disk-load 260
- text, problem-solving
  - blurred 254
  - misformed characters 251
- tips iii
- tire tracks, problem-solving 253
- toner
  - output quality, problem-solving 250
- toner cartridges. *See* print cartridges
- tools, required 46
- top cover, removing 84
- top-right cover, removing 73
- transfer stage 30
- tray 1 cover
  - removing 69
- Tray 3
  - physical specifications 308
- Tray 4
  - physical specifications 308
- trays
  - removing 54
  - Show Me How menu 174
- trays, input
  - configuring 177
- troubleshooting
  - blank pages 257
  - direct-connect problems 258
  - duplexing 246
  - engine test 134
  - network problems 258
  - pages not printing 257
  - pages printing slowly 257
  - paper handling problems 242
  - service approach 48

- transparencies 244

- USB cables 257

- two-sided printing

- Show Me How menu 174

## U

- upgrading firmware 263

- usage page, printing 176

- USB port

- troubleshooting 257

## V

- voltage specifications 308

## W

- warnings iii

- warranty

- customer self repair 302

- license 300

- print cartridges 299

- product 298

- service ID 261

- wavy paper, problem-solving 252

- Web Jetadmin

- firmware updates 265

- Web sites

- customer support 303

- Macintosh customer

- support 303

- Material Safety Data Sheet

- (MSDS) 316

- weight, product 308

- white horizontal lines or spots,

- problem-solving 253

- white vertical lines or spots,

- problem-solving 252

- wiring diagram 170

- wrinkled paper, problem-

- solving 252









CE524-90909

